

Complete Range **Single-axle trailers**



Small but
strong trailers
by **Humba**

- 🚚
- 🚛
- 🚚
- 🚚
- 🚚
- 🚚
- 🚚
- 🚚
- 🚚
- 🚚
- 🚚

Experience it for yourself

Our rationale makes it easy for you to become a staunch follower of Humbauro's high-quality products.



Follow HUMBAUR!

"The quality trailer specialist."

35 years of experience

We have been one of the leading manufacturers of car trailers for over 35 years. Over 1,000,000 trailers have left our premises since our company was founded. Nowadays, we produce around 60,000 units per year. And our wealth of experience is reflected in each of our trailers.

High quality

Robust and long-lasting — that's what a trailer needs to be. We use outstanding components and first-rate workmanship to achieve this goal. Before we deliver each trailer, we put it through its paces.

A wide range of transportation solutions

Our offering covers a very wide range of uses. Whether you are looking for a trailer for private or commercial needs, we can provide you with the appropriate model. You can choose a maximum gross weight between 750 kg and 55 t.

Wide range of accessories

Do you have very specific demands when it comes to your trailer? Thanks to a number of matching accessories, you can add to the comprehensive standard features to meet your requirements.

Committed customer service

If your trailer has a gross weight of up to 3.5 t, your dealer near you will be happy to help. Owners of trailers with a gross weight of 5 t or above can use our direct service. Whether you need a spare part or have a question about how to use your trailer — we and your local dealer, will be happy to help.

High-quality components

Quality is reflected in the detail — that's why Humbauro only uses high-quality vehicle components produced by reputable manufacturers. We continuously share our experiences with our suppliers. This enables us to continuously improve our products.

Table of contents

Experience it for yourself	2
Exactly what building contractors and passionate gardeners need	4
Trailers	
Steely flatbed trailer	6
Startrailer flatbed trailer	10
HA flatbed trailer	14
HA Allrounder flatbed trailer	18
HA Multi flatbed trailer	20
HU wheels-in trailer	22
HN wheels-in trailer	26
Optional accessories.....	30
Strengthened by experience	34



The 1000 series

Exactly what building contractors and passionate gardeners need



Steely flatbed trailer

With its non-slip, water-resistant wooden floor and robust construction, the Steely flatbed trailer makes for a helpful companion both for gardeners and on construction sites. Elegant toggle-type fasteners keep the tailgate securely closed. Do you need a raised or flat tarpaulin? The fastening studs are ready-fitted so that the trailer can be retrofitted with a cover at any time.



Startrailer flatbed trailer

Do you want to transport garden waste, small bulk waste or larger goods? Then the Startrailer flatbed trailer is just what you're looking for. It's very light and versatile, with an attractive appearance. The retractable tie-down hoops in the side panels are another practical feature.



HA flatbed trailer

Ideal for almost any task. The large selection of accessories allows you to equip the HA flatbed trailer for a wide range of applications. It can transport your motorcycles, bicycles, garden equipment and much more. The load can be lashed down using the tie-down hoops recessed in the aluminium side panels to prevent it from sliding around.



HA tipping flatbed trailer

It is easier to transport loads such as garden equipment and motorcycles if the trailer can be tipped. For applications of this kind and similar, we offer this version of the HA flatbed trailer with a tipping body. A shock absorber makes it easier to tip. Reinforcements, such as additional hinges on the tailgate, make the trailer particularly sturdy.



HU wheels-in trailer

The HU wheels-in trailer is designed with durability and quality in mind. All the main metal components are hot-dip galvanised. You can lower the side panels, or remove them completely, to make loading and unloading particularly easy. Loads can be easily fixed down using the lashing rings. The low loading height comes in useful for everyday use.



HN wheels-in trailer

Practical and well-designed: With the side panels lowered, you can easily load your goods onto the HN wheels-in trailer with a forklift truck. Its low loading height makes handling easier for you. The lashing rings on our trailers can withstand tensile forces of 400 kg, allowing you to transport heavy loads safely as well (tested by DEKRA).

STEELY FLATBED TRAILER





STEELY

A helpful companion both for gardeners and on construction sites

- 1 Hot-dip galvanised V drawbar
- 2 13-pin plug
- 3 Base plate 9 mm thick
- 4 Side panels made of hot-dip galvanised, angled sheet steel
- 5 Tailgate with toggle-type fasteners
- 6 Four tie rings on the insides of the trailer's side panels
- 7 Ready-fitted fastening studs on the side panels for attaching tarpaulins
- 8 Humbaur multifunctional lights fitted on the underrun protection
- 9 Stanchions for slotting in
- 10 All unbraked trailers with a ball head coupling with Soft-Dock as standard



STEELY DK



STEELY FLATBED TRAILER

Steely

TECHNICAL DATA

STEELY

Overall dimensions	2960 x 1545 x 805 mm
Internal dimensions	2050 x 1095 x 300 mm
Maximum gross weight	750 kg
Payload	630 kg
Load height	495 mm
Tyres	13"

STEELY DK

Overall dimensions	2960 x 1545 x 805 mm
Internal dimensions	2050 x 1095 x 300 mm
Maximum gross weight	750 kg
Payload	604 kg
Load height	495 mm
Tyres	13"

Accessories (optional)

- 300-mm side panel extension
- H-frame
- Flat tarpaulin, grey
- Tarpaulin & frame, load height 1000 mm, grey
- 2 prop stands
- loose Net
- Spare wheel
- Jockey wheel with mounting parts



STEELY



STEELY DK





Steely with side panel extension and flat tarpaulin



Steely with raised tarpaulin



Steely with H-frame



Hot-dip galvanized V drawbar with transverse strut

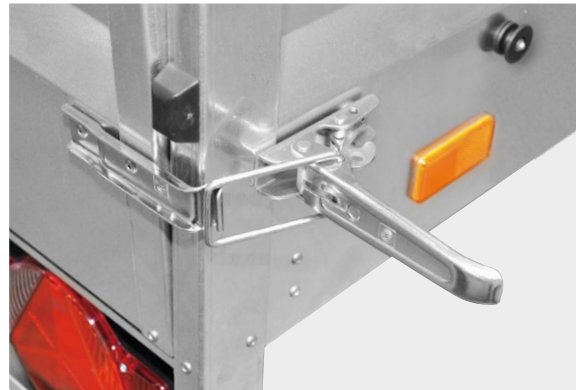

Toggle-type fasteners on the tailgate



Four tie rings attached to the side panels



STEELY DK
POSITIONED VERTICALLY

STARTRAILER FLATBED TRAILER



H 132513



8

5



6



8

H 752010



3

9

4

7

2

1

10

This trailer is ideal for almost any conceivable use

- 1 Hot-dip galvanised **V drawbar**
- 2 13-pin plug
- 3 Base plate **12 mm thick**
- 4 **Side panels** made of an anodised, double-walled **aluminium section**
- 5 **Tailgate** with recessed fasteners (H 752010)
- 6 **Lashing rings integrated in the side panels; each hoop can withstand a tensile force of 400 kg, as tested by DEKRA**
- 7 **Ready-fitted fastening studs** on the side panels for **attaching tarpaulins**
- 8 Humbaur **multifunctional lights** fitted on the underrun protection
- 9 **Stanchions** for slotting in
- 10 All unbraked trailers with a ball head coupling with **Soft-Dock** as standard

STARTRAILER FLATBED TRAILER

Startrailer

TECHNICAL DATA

H 752010

Overall dimensions	2970 x 1537 x 800 mm
Internal dimensions	2050 x 1095 x 300 mm
Maximum gross weight	750 kg
Payload	614 kg
Load height	500 mm
Tyres	13"

H 132513

Overall dimensions	3765 x 1800 x 830 mm
Internal dimensions	2510 x 1310 x 300 mm
Maximum gross weight	1300 kg
Payload	1078 kg
Load height	530 mm
Tyres	14"

TECHNICAL DATA

STARTRAILER DK

Overall dimensions	2965 x 1545 x 805 mm
Internal dimensions	2050 x 1095 x 300 mm
Maximum gross weight	750 kg
Payload	604 kg
Load height	495 mm
Tyres	13"

H 752513

Overall dimensions	3585 x 1760 x 800 mm
Internal dimensions	2510 x 1310 x 300 mm
Maximum gross weight	750 kg
Payload	602 kg
Load height	500 mm
Tyres	13"



H 751510

Accessories (optional)

- 300-mm side panel extension
- 500-mm H-frame, welded
- Railing attachment on the sides
- Wood/aluminium cover, interior height 185 mm
- Railing on wood/aluminium cover
- Two crossbars for bicycle stand rails
- One bicycle stand rail with bracket (can be locked)
- Net
- Flat tarpaulin, grey
- Tarpaulin and frame, grey, 1000 mm & 1500 mm
- Spare wheel
- Spare wheel bracket
- Jockey wheel with mounting parts
- 2 prop stands



H 752010 with flat tarpaulin



H 752010 with side railing

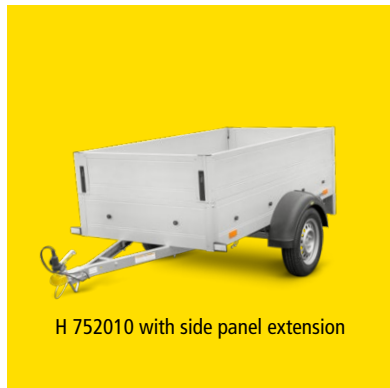

H 752010 with side panel extension



H 752010 with tarpaulin (1000 mm) and frame



H 752513 with tarpaulin (1500 mm) and frame

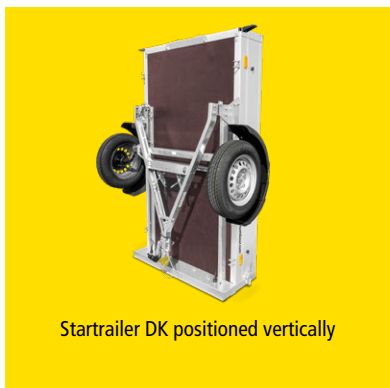

Startrailer DK positioned vertically



Recessed lashing eyelets



side panels made of an anodised, double-walled aluminium section



STARTRAILER DK



Hot-dip galvanised V drawbar



Jockey wheel

HA FLATBED TRAILER



The universal workhorse: versatile and robust

- 1 Hot-dip galvanised V drawbar
- 2 13-pin plug and reversing light
- 3 Base plate 15 mm thick
- 4 Side panels made of an anodised, double-walled aluminium section
- 5 Tailgate with recessed fasteners
- 6 Front panel with recessed fasteners (optional)
- 7 Lashing rings (4x for body lengths up to 2050 mm/6x for body lengths over 2510 mm) integrated in the side panels; each lashing ring can withstand a tensile force of 400 kg, as tested by DEKRA
- 8 Can only be tipped on the HA: Bridge with shock absorber for tipping; 18° tipping angle at the rear; reinforced tailgate and reinforced underrun protection on the HA 132513
- 9 Humbaur multifunctional lights integrated in the underrun protection
- 10 Stanchions for slotting in
- 11 Ramp wall that can be lowered at the rear, only on the HA 132513 aluminium with lattice ramp wall
- 12 All unbraked trailers with a ball head coupling with Soft-Dock as standard

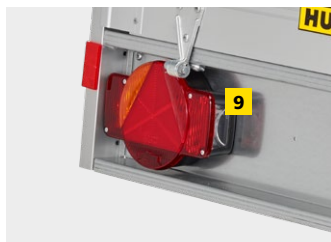

HA 132513

HA FLATBED TRAILER

Maximum gross weight in kg	Model	Overall dimensions in mm	Internal dimensions in mm	Payload in kg	Load height in mm	Tyres in inches	braked
750	HA 752111	3025 x 1548 x 870	2050 x 1100 x 350	610	510	13	
750	HA 752111-5	3025 x 1548 x 1020	2050 x 1100 x 500	598	510	13	
750	HA 752113	3035 x 1760 x 870	2050 x 1310 x 350	602	510	13	
750	HA 752113-5	3035 x 1760 x 1020	2050 x 1310 x 500	589	510	13	
750	HA 752513	3580 x 1760 x 865	2510 x 1310 x 350	581	510	13	
750	HA 752513 FS	3580 x 1760 x 865	2510 x 1310 x 350	585	510	13	
750	HA 752513-5	3580 x 1760 x 1015	2510 x 1310 x 500	565	510	13	
750	HA 752513 tipping	3580 x 1760 x 865	2510 x 1310 x 350	577	510	13	
1000	HA 102111	3215 x 1550 x 905	2050 x 1100 x 350	822	525	13	✓
1000	HA 102111-5	3215 x 1550 x 1055	2050 x 1100 x 500	810	525	13	✓
1000	HA 102113	3215 x 1770 x 890	2050 x 1310 x 350	801	530	13	✓
1000	HA 102113-5	3215 x 1770 x 1040	2050 x 1310 x 500	788	530	13	✓
1300	HA 132513	3760 x 1810 x 905	2510 x 1310 x 350	1058	530	14	✓
1300	HA 132513 FS	3780 x 1810 x 905	2510 x 1310 x 350	1063	530	14	✓
1300	HA 132513-5	3760 x 1810 x 1055	2510 x 1310 x 500	1043	530	14	✓
1300	HA 132513 tipping	3795 x 1800 x 915	2510 x 1310 x 350	1046	565	14	✓
1300	HA 1325 13 aluminium with lattice ramp wall	3850 x 1810 x 1525	2510 x 1310 x 350	1008	530	14	✓
1500	HA 152513	3760 x 1810 x 875	2510 x 1310 x 350	1248	525	14	✓
1500	HA 152513 FS	3760 x 1810 x 875	2510 x 1310 x 350	1253	525	14	✓
1500	HA 153015	4320 x 2004 x 940	3030 x 1500 x 350	1209	590	14	✓



HA 132513 TIPPING



Tipping body (on the tipping HA) with shock absorber support



left Hot-dip galvanised drawbar
right Lashing rings integrated into the side panels



left Front side lights
right Tailgate with recessed fasteners



Facility to drive onto the tipping HA



HA 132513 with tarpaulin and frame

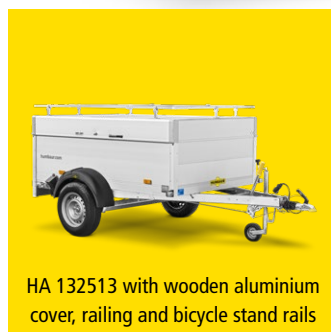

HA 132513 with wooden aluminium cover, railing and bicycle stand rails



HA 132513 with steel lattice extension

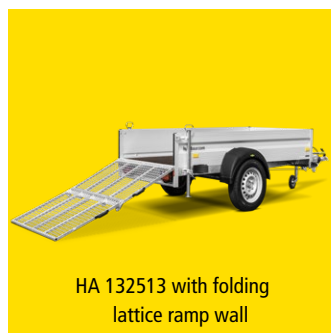

HA 132513 with folding lattice ramp wall

Accessories (optional)

- Spare wheel & spare wheel bracket
- Jockey wheel with mounting parts
- 2 prop stands
- Loose wheel shock absorbers without 100 km/h approval
- Mounted wheel shock absorbers with 100 km/h approval
- Front panel/side railing
- Steel lattice extension 620 mm
- 500-mm H-frame, welded
- Aluminium side panel extension
- Wood/aluminium cover with base side panel, ready-fitted, interior height 185 mm
- Railing on wood/aluminium cover
- Two crossbars for bicycle stand rails, width 1100 mm
- One bicycle stand rail with bracket (can be locked)
- Tarpaulin and frame, load height 1300 mm/1600 mm/1800 mm
- Long drawbar (version depends on model, unavailable for some models)
- Folding lattice ramp wall
- Flat cover

HA ALLROUNDER FLATBED TRAILER

HA Allrounder

TECHNICAL DATA

HA 132513 ALLROUNDER

Overall dimensions	3760 x 1810 x 955 mm
Internal dimensions	2510 x 1310 x 400 mm
Maximum gross weight	1300 kg
Payload	1011 kg
Load height	530 mm
Tyres	14"



Accessories (optional)

Spare wheel & spare wheel bracket



Ideal for any task – with that little bit more

- 1 Hot-dip galvanised **V drawbar**
- 2 **13-pin plug and reversing light**
- 3 **Base plate** 15 mm thick
- 4 **Side panels** made of an **anodised, double-walled aluminium section**
- 5 **Gates** with recessed fasteners
- 6 Six **tie-down hoops** integrated in the side panels, each hoop can withstand a tensile force of 400 kg, as tested by DEKRA
- 7 Humbaour **multifunctional lights**
- 8 **Stanchions** for slotting in
- 9 Includes **shock absorbers, loading ramps, stand rail, railing, flat tarpaulin, prop stand and loose toolbox**



HA 132513 ALLROUNDER

HA MULTI FLATBED TRAILER

HA Multi

TECHNICAL DATA

HA 752513 MULTI

Overall dimensions	3858 x 1760 x 800 mm
Internal dimensions	2510 x 1310 x 300 mm
Maximum gross weight	750 kg
Payload	592 kg
Load height	500 mm
Tyres	13"

HA 132513 MULTI

Overall dimensions	3765 x 1800 x 905 mm
Internal dimensions	2510 x 1310 x 300 mm
Maximum gross weight	1300 kg
Payload	1060 kg
Load height	530 mm
Tyres	14"

HA 132513 MULTI RSD

Overall dimensions	3765 x 1800 x 905 mm
Internal dimensions	2510 x 1310 x 300 mm
Maximum gross weight	1300 kg
Payload	1055 kg
Load height	530 mm
Tyres	14"



Aluminium lid

Aluminium loading ramps



Optional aluminium loading ramps can be pushed into the underrun protection



Accessories (optional)

- Spare wheel & spare wheel bracket
(standard equipment for braked models)
- 300 mm alu extension sides
- Aluminium lid & flat tarpaulin
- Aluminium loading ramps



The all-rounder – always ready

- 1 Galvanised v-shaped drawbar
- 2 13 pin plug and reversing light from 751 kg (gross weight)
- 3 Side walls made of anodised double-walled aluminum profiles
- 4 6 lashing rings integrated in the side walls, traction force 400 kg per ring, Dekra tested
- 5 Humba lighting integrated in the underrun protection
- 6 Insertion of the loading planks possible
- 7 Possibility to insert corner stanchions
- 8 All unbraked trailers with a ball head coupling with Soft-Dock as standard

HU WHEELS-IN TRAILER





Impressive in every respect thanks to its durability and quality

- | | |
|--------------------------------------------------------|------------------------------------------------------------------------|
| 1 Welded and hot-dip galvanised chassis | 5 Conical end stanchions , removable |
| 2 Base plate 15 mm thick | 6 Jockey wheel |
| 3 300-mm side panels fully hinged and removable | 7 Lights integrated in the underrun protection |
| 4 Drawbar closures | 8 V-groove outer frame with two pairs of recessed lashing rings |

HU WHEELS-IN TRAILER

HU wheels-in trailer

TECHNICAL DATA

HU 752314

Overall dimensions	3535 x 1535 x 988 mm
Internal dimensions	2300 x 1400 x 300 mm
Maximum gross weight	750 kg
Payload	520 kg
Load height	690 mm
Tyres	13"

HU 132314

Overall dimensions	3580 x 1535 x 955 mm
Internal dimensions	2300 x 1400 x 300 mm
Maximum gross weight	1300 kg
Payload	1010 kg
Load height	655 mm
Tyres	13"

HU 152314

Overall dimensions	3580 x 1535 x 955 mm
Internal dimensions	2300 x 1400 x 300 mm
Maximum gross weight	1500 kg
Payload	1210 kg
Load height	655 mm
Tyres	13"

Accessories (optional)

- Flat cover
- 350 mm side panel extension
- Closed aluminium extension 620 mm
- Steel lattice extension 620 mm
- Tarpaulin & frame, various load heights
- Support feet
- Toolbox

Stanchions and
side panels
**COMPLETELY
REMOVABLE**





V-groove outer frame with two pairs of recessed lashing rings



Drawbar closures



Extension sides (optional)

HN WHEELS-IN TRAILER



Tailored to special tasks thanks to its low loading height and high flexibility

- 1 Hot-dip galvanised V drawbar
- 2 Low frame construction
- 3 13-pin plug and reversing light
- 4 Base plate 18 mm thick
- 5 Completely removable side panels made of an anodised, double-walled aluminium section with recessed fasteners
- 6 Four lashing rings integrated in a V-shaped outer frame section; each hoop can withstand a tensile force of 400 kg, as tested by DEKRA
- 7 Jockey wheel
- 8 Humbaur multifunctional lights integrated in the underrun protection section
- 9 Stanchions for slotting in

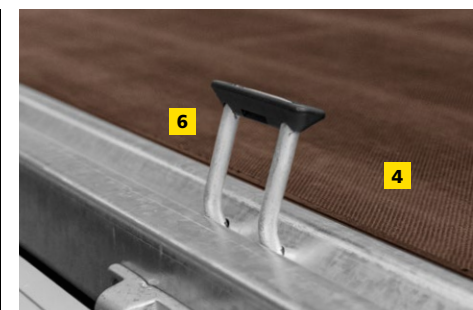

HN WHEELS-IN TRAILER

HN wheels-in trailer

TECHNICAL DATA

HN 132616

Overall dimensions	3920 x 1713 x 930 mm
Internal dimensions	2650 x 1650 x 300 mm
Maximum gross weight	1300 kg
Payload	962 kg
Load height	610 mm
Tyres	13"

HN 152616

Overall dimensions	3920 x 1713 x 930 mm
Internal dimensions	2650 x 1650 x 300 mm
Maximum gross weight	1500 kg
Payload	1152 kg
Load height	610 mm
Tyres	13"



Accessories (optional)

- Spare wheel, long drawbar & H-frame
- Spare wheel bracket mounted on the drawbar (only possible on long drawbars)
- Two telescopic crank supports
- Loose wheel shock absorbers without 100 km/h approval
- Mounted wheel shock absorbers with 100 km/h approval
- 350-mm side panel & 350-mm side panel extension
- Flat tarpaulin & flat tarpaulin with side panel extension
- Tarpaulin and frame, load height 1300 mm/1600 mm/1800 mm

ENOUGH SPACE FOR YOUR PROJECTS

WITH THE HN WHEELS-IN TRAILER



For 4 EURO pallets or grid boxes



Stanchions and side panels
COMPLETELY REMOVABLE

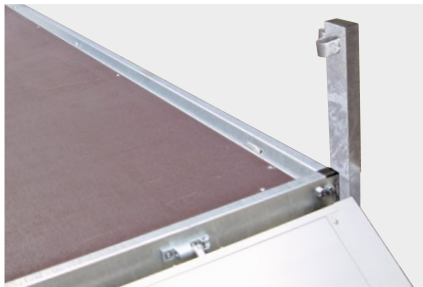
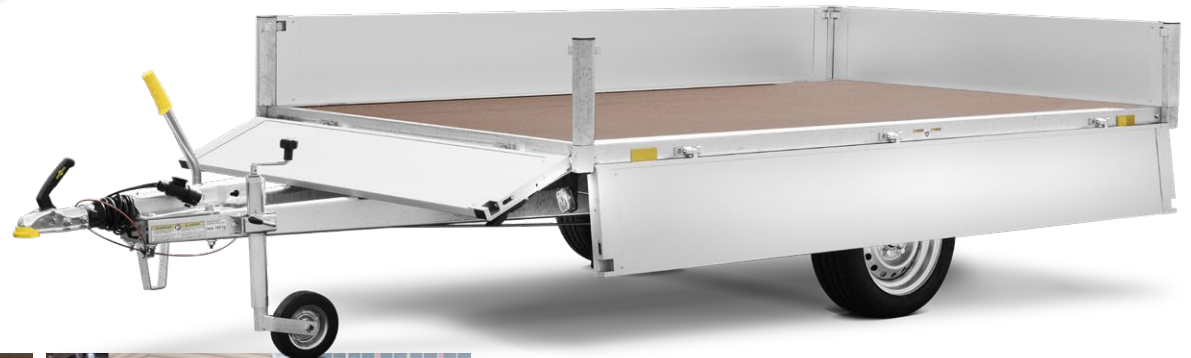

Stanchion pockets and removable stanchions, both hot-dip galvanised



Lashing rings integrated directly in the outer frame (4x)



Ideal for loading from all sides

Our range of accessories

Body



350-mm side panel extension (300 mm on the Startrailer)



H-frame



Wood/aluminium cover for base side panel



Front panel



Crossbars for bicycle rails (2x, loose)

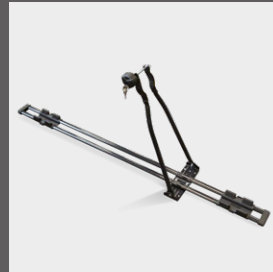

Bicycle stand rail with lockable bracket (1x) for wood/aluminium cover



Railing on wood/aluminium cover



Side or front and rear railings



Steel lattice extension for HA models

Anti-theft device

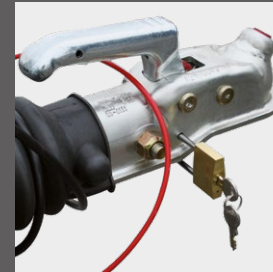

Padlock for braked trailers up to 3500 kg

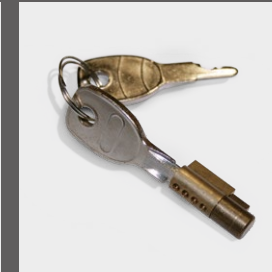

Mortise lock for unbraked trailers

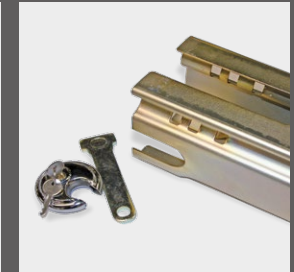

Metal locking shoe with lock



Tailored to your requirements

Wheels



Spare tyres



Spare wheel bracket mounted on the drawbar



Spare wheel bracket (loose)



Lights/electrics



7 – 13-pin adapter



Load security



Net

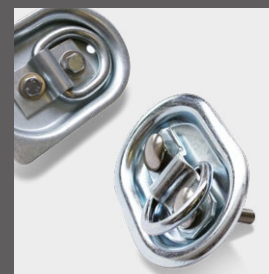

Lashing rings recessed into wooden floor

Our range of accessories

Chassis

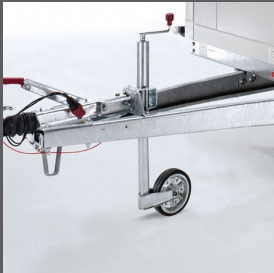

Long drawbar (version depends on model)



Crossbar (loose) for jockey wheel



(Mounted)* wheel shock absorbers



Prop stands (loose, 2x)



Telescopic crank supports (2x)



Jockey wheel (version depends on model)

*with 100 km/h approval; wheel shock absorbers (loose) without 100 km/h approval



Tarpaulin and frame bodies



Flat tarpaulin (available in different colours depending on the model), even with the side panel extension fitted



Version with flat tarpaulin and side railings (incl. front and rear railings)



Tarpaulin and frame, load height 1000/1300/1600/1800 mm (version depends on model)

Tailored to your requirements

Standard tarpaulin colours

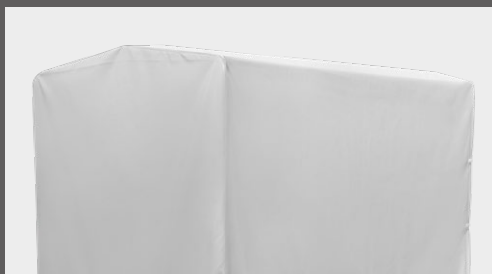

White/similar to RAL 9010



Yellow/similar to RAL 1003



Orange/similar to RAL 2011



Red/similar to RAL 3002

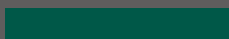

Green/similar to RAL 6026



Blue/similar to RAL 5002



Grey/similar to RAL 7038

Please note that the colours shown may vary from the original colours.

We are happy to create **customised** signage on tarpaulins on request



In addition to the **extensive standard equipment** for our trailer and vehicle bodies, we offer a wide selection of accessories **to suit each model.**

This means that you can **configure** just the right solution for your transport needs based on **your individual requirements** and they can grow alongside your transport requirements.



Order spare parts – conveniently online

shop.humbaur.com



Strengthened by experience

Humbaur stands for innovation and customer-oriented solutions. This approach has enabled this owner-managed, medium-sized family business to become the **European market leader**. With around **420 different standard trailer models** from 750 kg to 55 tonnes for commercial and private clients and 230 models of the FlexBox vehicle bodies, it has the perfect solution to every transport problem. For over 35 years we have built a wealth of experience, together with our trading partners and customers that is reflected in each of our products – **in sophisticated functions and details, greater user-friendliness and a high level of driving comfort.**

Our trademarks include robust and low-maintenance vehicles with an extensive range of standard equipment, as well a wide range of accessories plus the ability to offer customised solutions. Our own manufacturing expertise – ranging from small metal parts to polyester roofs or sandwich panels – combined with quality components from renowned manufacturers, ensures **durable products which retain their value well.**

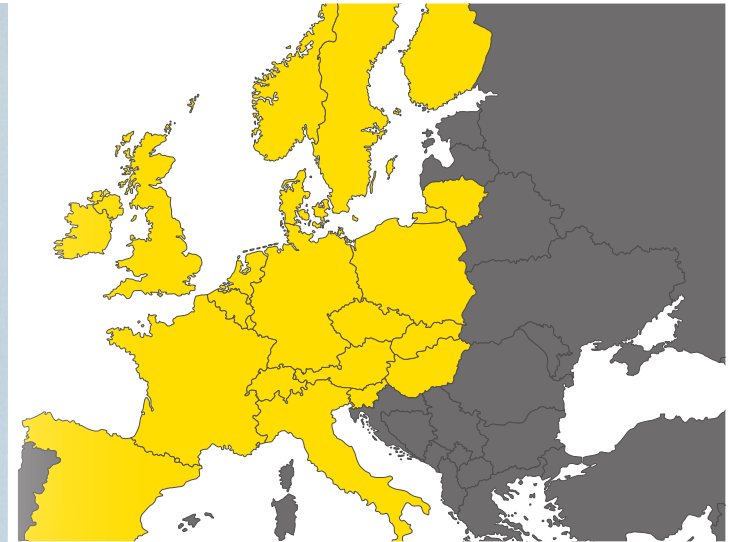

Together with our **partner network**, we provide comprehensive local support for all your transport problems. Together, we will find the right solution for your transport requirements and will take care of **servicing and repairs**. Our service includes reasonably priced repair options, as well as the **long-term availability of spare parts** so that you can enjoy and use your trailer or vehicle body for years to come.

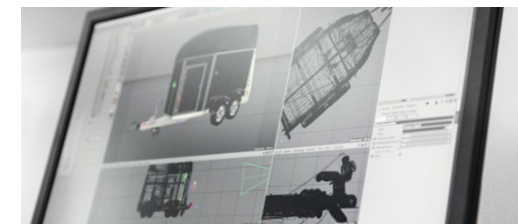

Outstanding quality

We place great importance on the fact that our products operate even under **tough conditions** with no nasty surprises. We construct our trailers in robust designs using suitable materials of the required strength. We simulate the hardest conceivable use for our trailers on various test tracks. We check the stability and durability of the chassis, frame and components at full load. This is how we ensure the **outstanding quality** of our trailers.



Our **quality management system** is certified to **DIN EN ISO 9001:2015** and **KBA-ZM-A** and is regularly reviewed. We are also certified by numerous commercial vehicle manufacturers as a construction and reconstruction partner for the vehicle body segment. We regularly demonstrate **our quality** through recurring checks and through our products themselves.



As a customer, you benefit from this twice:
during use and when it comes to reselling.





More information is available online at
[humbaur.com/en/dealersservice/downloads/](https://www.humbaur.com/en/dealersservice/downloads/)

Do you have any questions about this or another trailer from our range or would you like some personal advice? We look forward to hearing from you.

Contact us by phone on **+49 (0) 821 / 24 929 - 0**
or by email at info@humbaur.com

YOUR HUMBAUR CONTACT IN YOUR AREA

