

Soft-Line Couplings



Soft-Line Coupling Covers Provide Application Protection

CEJN Soft-Line “softens” the edges of quick connect couplings, making them non-abrasive and less likely to cause damage to surrounding components and surfaces. They also protect couplings from impact, prolonging the service life of the couplings.

Soft-Line covers are available in two styles:

- **Integrated** – Permanently attached to couplings during the manufacturing process
- **Accessory** – Designed to be added onto couplings

The accessory-style cover can be attached easily to a coupling at any time by simply placing the assembly tool over the front end of the coupling, slipping the cover on the assembly tool, and moving the cover over the assembly tool and onto the coupling.

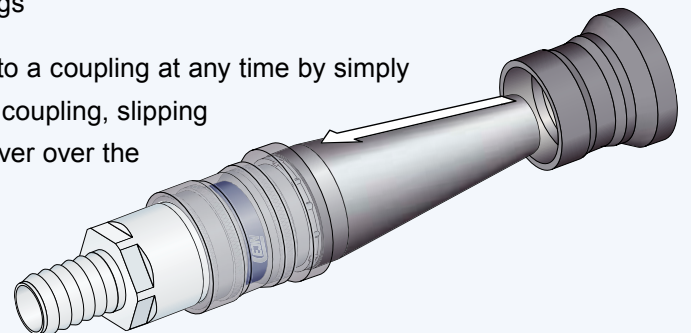

Accessory style



Integrated vented safety style with additional kink protector



Integrated standard style







Soft-Line Couplings





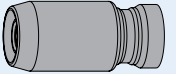
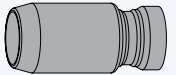
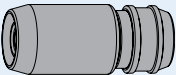

INTEGRATED



This series includes safety products.
For other safety products, see Page 71-78.

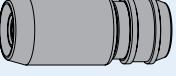

SERIES 300 (Page 10)	Part No.	Connection
Stream-Line, Vented Safety 	10 300 3080	6.5 x 10 mm
	10 300 3082	8 x 12 mm

SERIES 310 (Page 13)	Part No.	Connection
Stream-Line 	10 310 1083	6.5 x 10 mm
	10 310 1084	8 x 12 mm
Female thread 	10 310 1240	G 1/4"
	10 310 1241	G 3/8"
	10 310 1446	NPT 1/4"
	10 310 1447	NPT 3/8"
Stream-Line, Vented Safety 	10 310 3080	6.5 x 10 mm
	10 310 3082	8 x 12 mm
Female thread, Vented Safety 	10 310 3234	G 3/8"

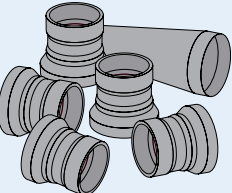
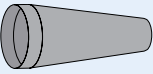
SERIES 320 (Page 16)	Part No.	Connection
Hose connection 	10 320 1086	10 mm (3/8")
	10 320 1087	13 mm (1/2")
Stream-Line 	10 320 1089	6.5 x 10 mm
	10 320 1090	8 x 12 mm
Female thread 	10 320 1246	G 1/4"
	10 320 1247	G 3/8"
Stream-Line, Vented Safety 	10 320 3080	6.5 x 10 mm
	10 320 3082	8 x 12 mm
	10 320 3085	11 x 16 mm
Hose connection, Vented Safety 	10 320 3086	10 mm (3/8")
	10 320 3087	13 mm (1/2")
Female thread, Vented Safety 	10 320 3234	G 3/8"

ACCESSORIES	Hose Connection	Part No.
Accessory Covers 		19 900 7000
Accessory-style covers are available in packages of 10, including an assembly tool and assembly instructions. They are compatible with all standard Series 300, 303, 310, 315, 320, and 342 couplings.		
Assembly tool 		19 900 7050
Kink protectors 	6.5 x 10.0	10 300 4010
	8.0 x 12.0	10 300 4012
Kink protectors can be used on all Stream-Line connections with the corresponding hose size. Kink protectors are sold separately and can be replaced during use with the cap nut on the Stream-Line connection.		



Thread connections are listed according to ISO Standards (see Page 82 for more information). Check with an authorized CEJN distributor for availability and prices.



Para más información:

info@aesscorp.com
WA: +507 6378 0341
www.aesscorp.com