VP Dew Point Sensor

User manual

© 2019 VPIstruments



VP Dew Point Sensor

© 2019 VPInstruments

All rights reserved. No parts of this document may be reproduced in any form or by any means - graphic, electronic, or mechanical, including photocopying, recording, taping, or information storage and retrieval systems - without the written permission of the publisher.

Products that are referred to in this document may be either trademarks and/or registered trademarks of the respective owners. The publisher and the author make no claim to these trademarks.

While every precaution has been taken in the preparation of this document, the publisher and the author assume no responsibility for errors or omissions, or for damages resulting from the use of information contained in this document or from the use of programs and source code that may accompany it. In no event shall the publisher and the author be liable for any loss of profit or any other commercial damage caused or alleged to have been caused directly or indirectly by this document.

Creation date: 15-02-2019 in Delft





Publisher

Van Putten Instruments BV
Buitenwatersloot 335
2614 GS Delft
The Netherlands

Table of Contents

1 Warning - Read this first	4
2 Introduction	5
3 Product overview	5
4 Functional description	7
1 DRYCAP Technology	7
Auto-calibration	7
Sensor Purge	7
Sensor Warming in high humidities and freezing conditions	8
2 Startup Sequence	8
3 Alarm LED	9
5 Mechanical installation	10
1 Configuration Before Installation	10
2 Selecting the Location	10
3 Installing the sensor	11
4 Sampling from a process	13
Sampling Accessories	13
6 Electrical installation	14
7 Connectivity & communication	16
1 Modbus	16
2 Remote display	19
8 Service	20
9 Specifications	21
10 Order information and Accessories	22
11 Appendix A - Troubleshooting	23
12 Appendix B - Mechanical dimensions	23

1 Warning - Read this first

	<p>Compressed gases can be dangerous! Please familiarize yourself with the forces under pressurized conditions. Respect the local guidelines and regulations for working with pressurized equipment.</p>
	<p>Precision instruments need regular re-calibration. To keep your VP Dew Point Sensor in best shape, it needs recalibration. The advised recalibration interval is 2 years.</p>
	<p>Do not open the device. Our instruments are assembled with high precision. Opening this device is dangerous and may destroy the instruments. Warranty is voided when you open the instrument.</p>
	<p>Feedback leads to product improvement. Please share your experience with us, as we are continuously improving our products in our commitment to quality, reliability and ease of use. Let us know via sales@vpinstruments.com!</p>

2 Introduction

The VP Dew Point Sensor is a small and lightweight sensor suitable for a wide range of applications. The sensor is easy to install and the mechanics have been designed for harsh environments requiring protection against dust, dirt and splashed water.

The accuracies of the internal sensors have been optimized for different parts of the sensors' measurement range.

For more information on the measurement accuracy specification of the different sensors, see [Product overview](#) and [Specifications](#).

VPInstruments Dew Point Sensors use the DRYCAP® polymer sensor for dewpoint measurement. DRYCAP® technology has low maintenance needs due to its excellent long term stability and durability against condensation. The calibration interval of sensor is two years.

Output Parameters

Parameter	Abbreviation	Metric Unit	Non-Metric Unit
Dewpoint/frost point temperature	Tdf	°C	°F
Dewpoint/frost point temperature, converted to atmospheric pressure	Tdfatm	°C	°F
ppm moisture, by volume	H2O	ppm	ppm



NOTE

When dewpoint is below 0 °C, the VP Dew Point Sensor outputs frostpoint for Td.

Dewpoint temperature in atmospheric pressure (Td/f atm) is a calculated parameter that presents the dewpoint the gas would have at atmospheric pressure. For this calculation to provide accurate results, it is important to have the correct pressure setting stored in the sensor. This setting can be changed using Modbus.

3 Product overview



When the VP Dew Point Sensor is delivered, the filter is protected by a yellow transport protection cap that keeps the sensor dry. The transport protection cap should be left on the VP Dew Point Sensor during storage. Remove the transport protection cap before installing the VP Dew Point Sensor.

VP Dew Point Sensor with G1/2" ISO228/1 Thread

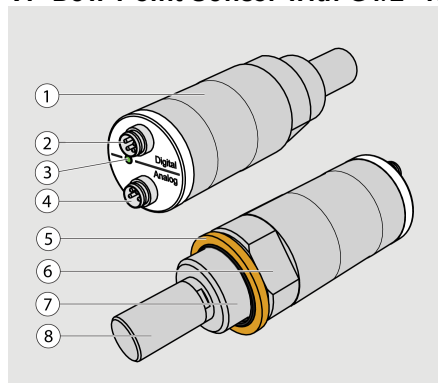

- 1 = Body. Type label is applied here
- 2 = Digital output: non-isolated RS-485 (Modbus RTU)
- 3 = Alarm LED
- 4 = Analog output
- 5 = Sealing ring. Must be used with the G1/2" ISO228/1 connection thread
- 6 = 24 mm nut
- 7 = Connection thread: G1/2" ISO228/1
- 8 = DRYCAP®180D sensor protected with sintered filter

Connection Cables

VPIInstruments supplies shielded cables with M8 female straight threaded connector. The standardized cable length is 10 m | 32.8 ft.

A USB service cable is available for easy configuration. It converts the RS485 interface into USB so it can be used on your computer. It also features an input for power.

For the order codes of the cables, see section [Order information and Accessories](#)

Sampling Accessories

A sampling cell is available for the sensor. For more information on performing sampling, and a description of the accessories, see [Sampling Accessories](#)

For the order codes of the sampling accessories, see [Order information and accessories](#)

4 Functional description

This chapter describes the advanced functionality of VP Dew Point Sensor, including the auto-calibration, sensor purge, and sensor warming functions.

4.1 DRYCAP Technology

The DRYCAP® dewpoint measurement technology ensures accurate measurement with excellent long term stability. This results in very low maintenance requirements for the VP Dew Point Sensor. The lasting performance is achieved with microprocessor technology and software that automatically performs self-diagnostic functions in addition to the normal dewpoint measurement. The self-diagnostic procedures that are conducted are called auto-calibration, sensor purge, and sensor warming.

The Dew Point Sensor uses the DRYCAP® 180D sensor designed for applications such as plastic dryers and small industrial compressed air dryer (sensor filter length 22.5 mm | 0.886 inch, probe length 91.6 mm | 3.61 inch).

DRYCAP® polymer sensor:

- Auto-calibration ensures accuracy in changing measurement conditions
- Sensor warming keeps the sensor dry in high humidity
- Sensor purge ensures long term stability
- NIST traceable (certificate included)
- Optional accessories
- Sampling cells with various installation options

4.1.1 Auto-calibration

The auto-calibration feature of the VP Dew Point Sensor is an automatic procedure which greatly reduces the possible drift in the dry end of the dewpoint measurement. It is performed at one hour intervals, and when the power is switched on. When measuring very dry conditions, the VP Dew Point Sensor performs the auto-calibration at shorter intervals. A significant change in dewpoint or temperature may also trigger the auto-calibration.

During auto-calibration the sensor is warmed for a short period (< 1 min) and the sensor capacitance values are evaluated at the elevated temperature. The possible dry end drift is then corrected to correspond to the calibrated values. During the auto-calibration the VP Dew Point Sensor outputs the Td value prior to the procedure.

Auto-calibration is carried out only if several criteria for the measurement environment are fulfilled. This ensures the reliability of the adjustments, and maintains the excellent long term stability that the patented technology offers. These criteria include for example a stable enough moisture level in the measured atmosphere. If the conditions are not fulfilled, the auto-calibration function is postponed until satisfactory conditions are reached.

4.1.2 Sensor Purge

Sensor purge is also an automatic procedure that minimizes the drift at the wet end readings of the dewpoint measurement. Sensor purge is performed once a day or when the power is switched on. The sensor is heated for several minutes which will then evaporate all excess molecules out of the sensor polymer. This, together with auto-calibration, results in a very small drift of the sensor due to the very linear behaviour of the polymer technology. During the sensor purge the VP Dew Point Sensor outputs the Td value prior to the procedure.

4.1.3 Sensor Warming in high humidities and freezing conditions

VP Dew Point Sensor has a sensor warming feature that improves the sensor's performance in high humidities and freezing conditions. Sensor warming does not interrupt the VP Dew Point Sensor's Td value output.

In high humidity, sensor warming prevents the sensor and filter from becoming wet. High humidity may be present when the dewpoint temperature rises close to the gas temperature.

Sensor warming is switched on automatically when the humidity in the measured gas increases to a level where dew can start to form. The advantage of sensor warming is the rapid response of dewpoint measurement. A wet sensor and filter would otherwise result in a dewpoint equal to ambient temperature (that is, RH = 100 %).

If in spite of sensor warming the sensor gets soaked, it will recover fully back to normal operation after it dries out.

In freezing conditions, the VP Dew Point Sensor uses sensor warming to maintain the sensor temperature above 0 °C.



When measuring in temperatures below 0 °C, the supply voltage must be 24 .. 28 VDC. For more information on VP Dew Point Sensor supply voltage requirements, see [Electrical installation](#)

4.2 Startup Sequence

When the VP Dew Point Sensor is powered up, it will perform the sequence shown in Figure 5 below. After a two-second startup, the sensor will measure normally for 40 seconds, after which it will perform the sensor purge and auto-calibration functions. This can take up to 5 minutes, during which time the output is frozen: it will display the last measured values before the sensor purge began. The auto-calibration function may be postponed if the measurement environment is not suitable. For example, the environment may be changing rapidly or have too high humidity.

Normal operation and output is typically achieved no later than 6 minutes after startup. The sensor purge repeats every 24 hours and auto-calibration every hour. The output will again be frozen for their duration.

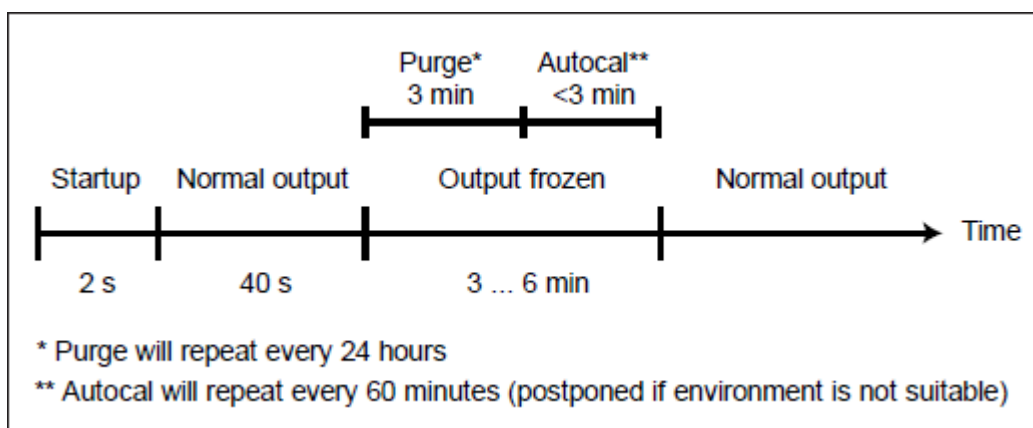

The VP Dew Point Sensor always performs this sequence when starting up. Keep the device continuously powered to optimize its measurement performance and availability.

4.3 Alarm LED

The alarm LED at the back of the VP Dew Point Sensor provides a visual indication of the sensor's status. You can use the Modbus commands to change the alarm limit, enable/disable the dewpoint alarm, or turn on/off the LED completely. See section [Modbus](#) for the commands.

LED	Color Meaning
Not lit	Power off or LED functionality disabled.
Green	Power on, normal measurement.
Green and blinking	Purge or auto-calibration in progress, measurement frozen.
Red	Dewpoint above limit.
Red and blinking	Transmitter error. See section Appendix A - Troubleshooting

5 Mechanical installation

5.1 Configuration Before Installation

You may wish to configure your VP Dew Point Sensor before physically installing it. For easy access to the serial line, use the USB service cable and a Modbus program on a PC. Instructions for using the serial line and the Modbus commands are provided in section [Modbus](#)

Examples of configurable settings for Modbus output:

1. The Modbus address
2. Parity, stop bits and baud rate

5.2 Selecting the Location

It is important that the point of installation represents well the gas to be measured. Temperature changes do not affect the dewpoint measurement, but pressure changes will have an effect on the measurement. All leaks in the system must be eliminated to avoid ambient humidity affecting the measurement.

Direct installation to the measured gas is the recommended installation method if the temperature of the gas is suitable for VP Dew Point Sensor and no additional filtering is needed due to very dusty or oily gas. Oil as such is not harmful for the DRYCAP® sensor, but response time may be slower if there are oil particles in the system, or if oil is collected to the filter over a longer period of time. The maximum measurement pressure is 50 bara | 725 psia for direct measurement.

If the gas temperature is higher than the specified maximum operating temperature of the VP Dew Point Sensor, gas sampling and cooling it to ambient temperature (for example, 20 °C | 68 °F) is recommended. Note that the dewpoint temperature must be clearly lower than the ambient temperature to avoid condensation in the sampling line. Sampling from the process is easy by using sampling cell options; see section [Sampling Accessories](#)

The VP Dew Point Sensor is light in weight, which means that it can be installed in a sample pipeline in the sampling cell without the need of any additional mechanical support. You can use a standard G1/2" T-shaped pipe fitting (not available from VPInstruments) when installing VP Dew Point Sensor into a pipeline.

5.3 Installing the sensor

Installation of the VP Dew Point Sensor can be done with or without sampling cell. See section [sampling from a process](#) for more information.

Installation without sampling cell

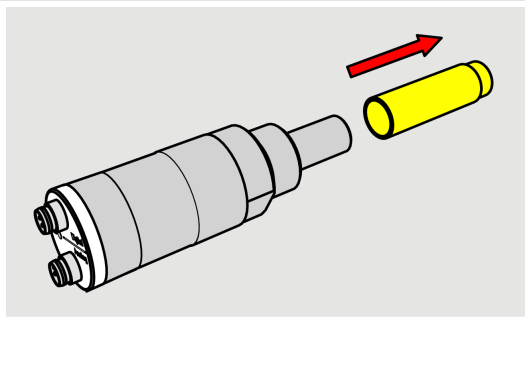
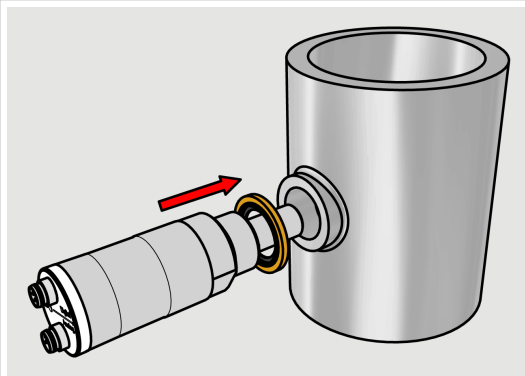
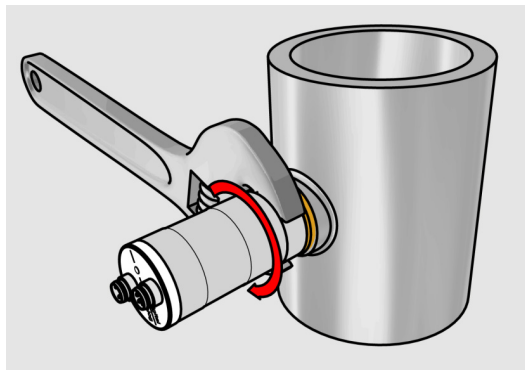
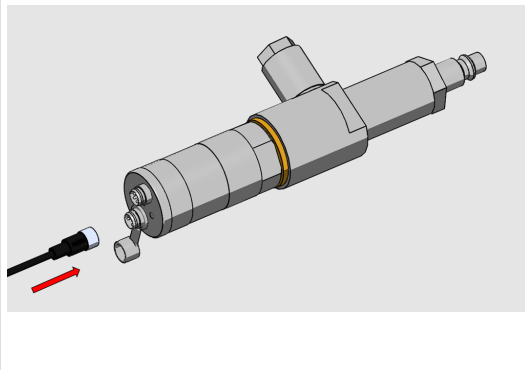
	
<p>Step 1 Remove the yellow transport protection cap from the VP Dew point Sensor.</p>	<p>Step 2 The VP Dew Point Sensor requires a sealing ring for a tight connection. Use the sealing ring that is provided with the sensor. Make sure the threads on the mounting point match your VP Dew Point Sensor.</p>
	
<p>Step 3 Tighten the connection by turning with a wrench (max. 50Nm). Wrench size is 24mm.</p>	<p>Step 4 Connect the signal and power cable to the VP Dew Point Sensor. Refer to the following sections for wiring instructions and power supply requirements.</p>

Installation with sampling cell

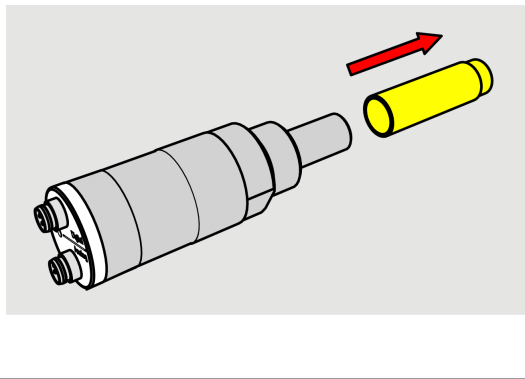
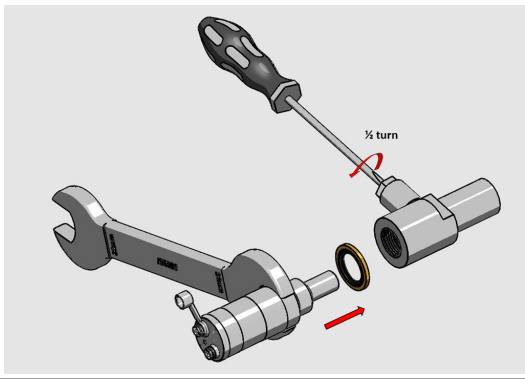
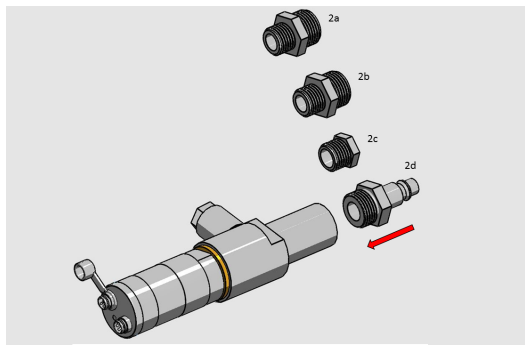
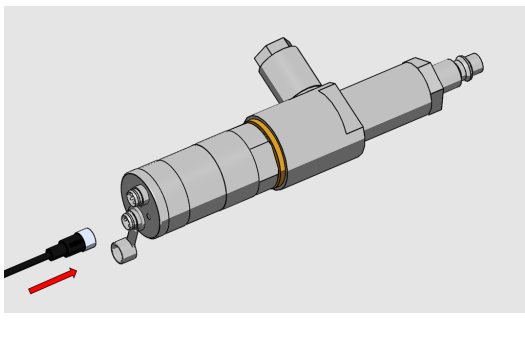
	
<p>Step 1 Remove the yellow transport protection cap from the VP Dew Point Sensor.</p>	<p>Step 2</p> <ol style="list-style-type: none"> 1. The VP Dew Point Sensor requires a sealing ring for a tight connection. Use the sealing ring that is provided with the sensor. Make sure the threads on the mounting point match your VP Dew Point Sensor. 2. Tighten the connection by turning with a wrench (max. 50Nm). Wrench size is 24mm. 3. Use a screw driver to rotate the leak screw 1/2 turn.
	
<p>Step 3 Choose the desired process interface and mount in on the sampling cell. Seal the threads of the quick connector or thread adapter carefully with PTFE thread seal tape. Tighten with an open-end wrench.</p>	<p>Step 4 Connect the signal and power cable to the VP Dew Point Sensor. Refer to the following sections for wiring instructions and power supply requirements.</p>

5.4 Sampling from a process

Sampling is needed when direct measurement of the air or gas is not possible or desirable. This may be related to, for example, a high process temperature, protecting the sensor from water spikes, the need to easily detach the instrument from a pressurized process without running the whole process down, or wanting to make the measurement at a more convenient location.

It is important to keep in mind that changing the pressure of a gas changes the dewpoint temperature of the gas. If the sensor is at a different pressure than the process itself, there may be an error of several tens of degrees in the dewpoint measurement.

Make sure there is sufficient flow of gas to the sensor (for example, 1 l/min) to give a representative sample.

5.4.1 Sampling Accessories

Sampling Cell

The sampling cell has been designed especially for compressed air lines. The sampling cell contains an adjustable leak screw that allows keeping up the pipeline pressure at the sensor. The leak screw is opened and closed with a screwdriver. The leak screw should be 1/2 turn open. This can be verified by first closing the leak screw, then turning 1/2 turn to open it.

Then the air coming out will make a barely audible little hiss and it can be lightly felt when putting a hand in front of the air stream.



NOTE Do not open the leak screw more than 1/2 turn to avoid reducing the pressure in the sampling cell.

The sampling cell comes with a quick connector that fits to industry standard compressed air line connectors (suitable for type D, Quick08, NIP08).

This allows for easy installation and detachment of the VP Dew Point Sensor without having to shut down the process. Alternative ways to connect are through the three different thread adapters (G3/8" to G1/2"

and G3/8" to G1/4" ISO and G3/8" to 1/2" NPT) that are supplied with each sampling cell.

When using the sampling cell, seal the threads of the quick connector or thread adapter carefully with PTFE thread seal tape. Tighten with an open-end wrench.

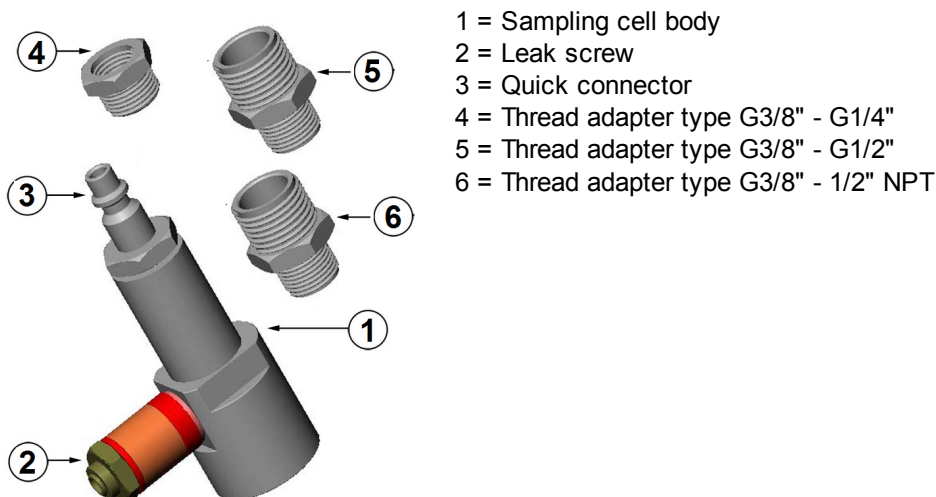

6 Electrical installation

The VP Dew Point Sensor features two M8 connectors. One connector is used for use with the analog input, the other one features the Modbus output. Both connectors can be used to apply power. The power supply lines are internally connected. You can use either one of them, but do not connect more than one supply voltage in permanent installations.

Connector Pinouts

Pin	Analog connector	Digital connector	Wire color
1	VDC supply+	VDC supply+	Brown
2	Ch-	RS-485 D0-	White
3	GND	GND	Blue
4	Ch+	RS-485 D1+	Black

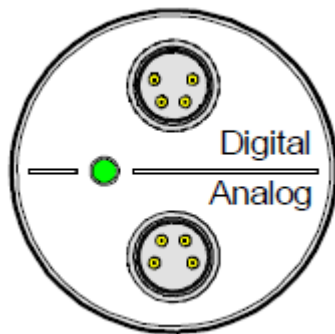

Wiring the digital connector

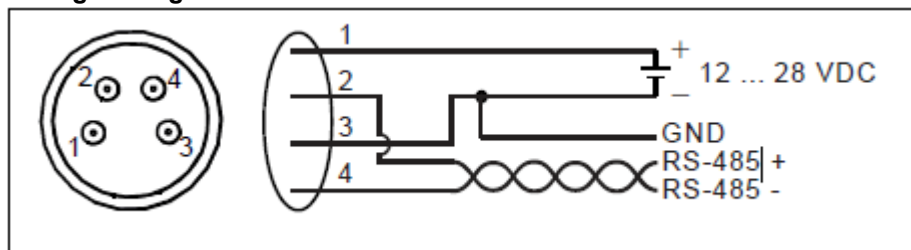

Wiring the analog connector

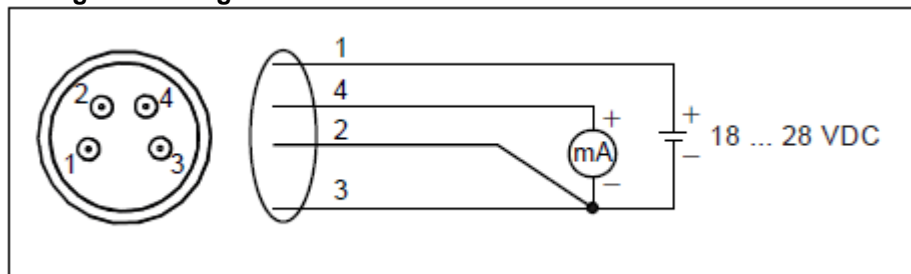

Power Supply Requirements

The voltage input is 18 .. 28 VDC. The maximum load is 500 Ω.

The power supply should maintain the voltage for all load conditions.

If measuring in pressures above 20 bara | 290 psia or temperatures below 0 °C, the supply voltage must be 24 .. 28 VDC.

Current consumption during normal operation is <math><10\text{ mA}</math>. The consumption increases during the sensor self-diagnostics (auto-calibration and sensor purge). The maximum current consumption is 220 mA pulsed current. See images below.

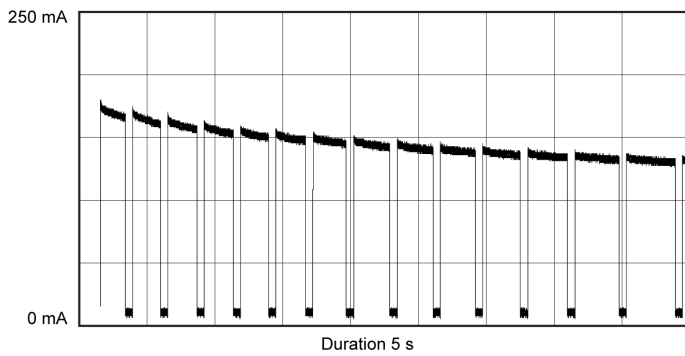
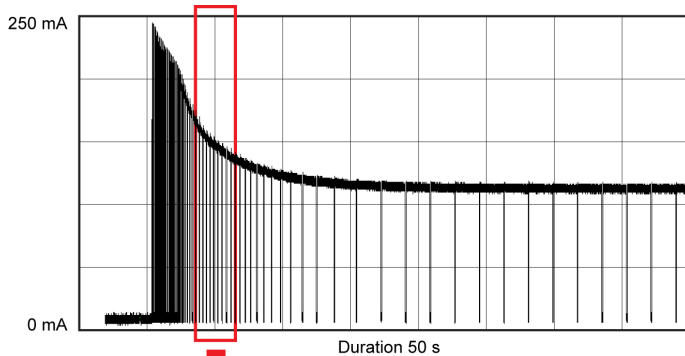

Above figure shows a typical duty cycle during sensor purge at room temperature with 24 VDC supply voltage. Sensor purge current varies with supply voltage and operating temperature. The peak value is the highest in the lowest temperature.

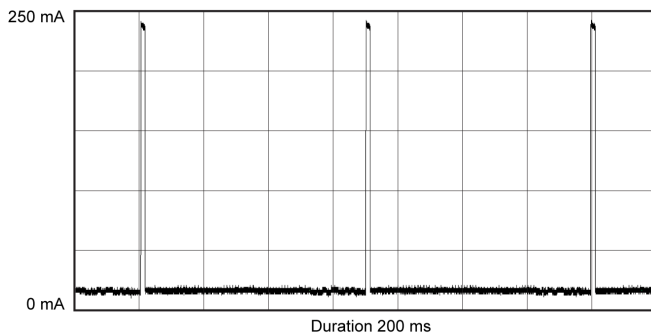
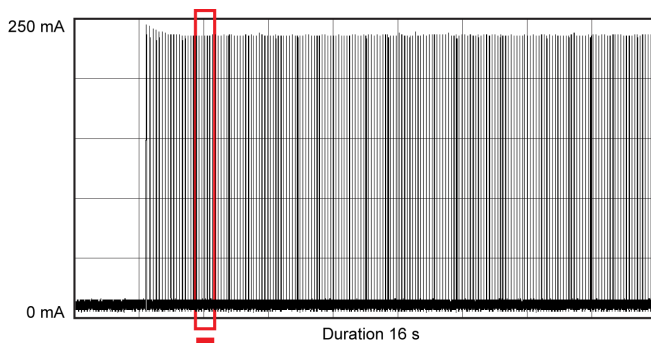

Above figure shows a typical duty cycle during auto-calibration at room temperature with 24 VDC supply voltage. Also the auto-calibration current varies with supply voltage and operating temperature.

7 Connectivity & communication

Connecting the Modbus interface

The VP Dew Point Sensor can be connected to a PC using the RS-485 line on the Digital port. It is recommended that you use the USB service cable (VPA.8000.1511) for the connection, since the cable also provides the operating power from the USB port. If you have not used the USB service cable before, install the driver that came with the cable. Refer to section Installing the Driver for the USB Service Cable below for detailed instructions.

Installing the Driver for the USB Service Cable

Before taking the USB service cable into use, you must install the provided USB driver on your PC.

1. Check that the USB service cable is not connected. Disconnect the cable if you have already connected it.
2. Insert the media that came with the cable, or download the latest driver from www.vpinstruments.com/downloads.
3. Execute the USB driver installation program (setup.exe), and accept the installation defaults. The installation of the driver may take several minutes.
4. After the driver has been installed, connect the USB service cable to a USB port on your PC. Windows will detect the new device, and use the driver automatically.
5. The installation has reserved a COM port for the cable. Verify the port number using Windows device manager.

7.1 Modbus

Introduction to Modbus

For a complete introduction on the Modbus standard can be found on www.modbus.org. See the document [Modbus_over_serial_line_V1_02.pdf](#), which can be downloaded from their website. We strongly recommend to download and read this information carefully before installing Modbus communication. The following paragraphs in this chapter assume you are familiar with the Modbus communication standard.

All measurement parameters are available through Modbus in floating point and integer format.

Default communication settings

Description	Default value
Baud rate	19200
Parity	None
Number of data bits	8
Number of stop bits	2
Modbus address	240
Serial delay	0

Data format

- Function code 0x03 for reading(Holding register)
- Function code 0x10 for writing (Holding register)
- 32-bit Floating point Little endian [CDAB]
- 16-bit signed Integer Little endian [CDAB]

Register map - Measurement data registers

Decimal	HEX	Register name	Register description	Unit	Type	Read / Write
0	0x0000 0x0001	Relative humidity	RH	%RH	32-bit Floating point	Read
6	0x0006 0x0007	Dew/frost point temperature	Td / f	°C	32-bit Floating point	Read
10	0x000A 0x000B	Dew/frost point temperature at 1 atm	TD / fa	°C	32-bit Floating point	Read
20	0x0014 0x0015	Water concentration	ppm	ppm	32-bit Floating point	Read
256	0x0100	Relative humidity	RH * 100	%RH	16-bit integer	Read
259	0x0103	Dew/frost point temperature	Td / f * 100	°C	16-bit integer	Read
261	0x0105	Dew/frost point temperature at 1 atm	TD / fa *100	°C	16-bit integer	Read
266	0x010A	Water concentration	ppm	ppm	16-bit integer	Read

Register map - Configuration registers

Decimal	HEX	Register name	Unit / valid range	Type	Read / Write
768	0x02FF	Pressure, power-up default value	bar (absolute) 0.001 .. 50	32-bit Floating point	Read/Write
770	0x0301	Pressure	bar (absolute) 0.001 .. 50	32-bit Floating point	Read/Write
794	0x0319	Filtering factor	0.00001 .. 1	32-bit Floating point	Read/Write
1536	0x05FF	Address	0 .. 255	16-bit integer	Read/Write
1537	0x0600	Baud rate	5 = 9600 6 = 19200	16-bit integer	Read/Write
1538	0x0601	Parity, data, stopbits	0 = N81 1 = N82 2 = E81 3 = E82 4 = O81 5 = O82	16-bit integer	Read/Write
1539	0x0602	Response delay	0 .. 1020	16-bit integer	Read/Write
1541	0x0604	Restart device	When writing to register: 1 = Restart the device	16-bit integer	Read/Write
3072	0x0BFF	Indicator mode	0 = Off 1 = Status only 2 = Alarm	16-bit integer	Read/Write
3074	0x0C01	Alarm setpoint	-70 °C .. +60 °C	32-bit Floating point	Read/Write
7680	0x1DFF	Restore settings	1 = Restore factory settings	16-bit integer	Read/Write

Register map - Status registers

Decimal	HEX	Register name	Notes	Type	Read / Write
512	0x01FF	Error status	Error status (1 = No errors)	16-bit integer	Read
513	0x0200	Online status	Online status 1 = data available 0 = output frozen due to autocal or purge	16-bit integer	Read
514	0x0202	Error code	Error code (0 = no errors)	32-bit integer	Read

Register map - Test value registers

Decimal	HEX	Register name	Value	Type	Read / Write
7936	0x1EFF	Signed integer	-12345	16-bit integer	Read
7937	0x1F00	Floating point	-123.45	32-bit Floating point	Read

7.2 Remote display

The VP Dew Point Sensor can be connected to a loop-powered external LED display. The display provides a reading of the output parameter. The display is powered by the 4 .. 20 mA current signal, so there is no need for an external power supply.

Two models are available:

- VPA.8000.1512
- VPA.8000.1513 (with 2 alarm relays)

Configure the display functions and scaling according to the documentation delivered with the display. For a wiring example, see example below or see the documentation delivered with the display

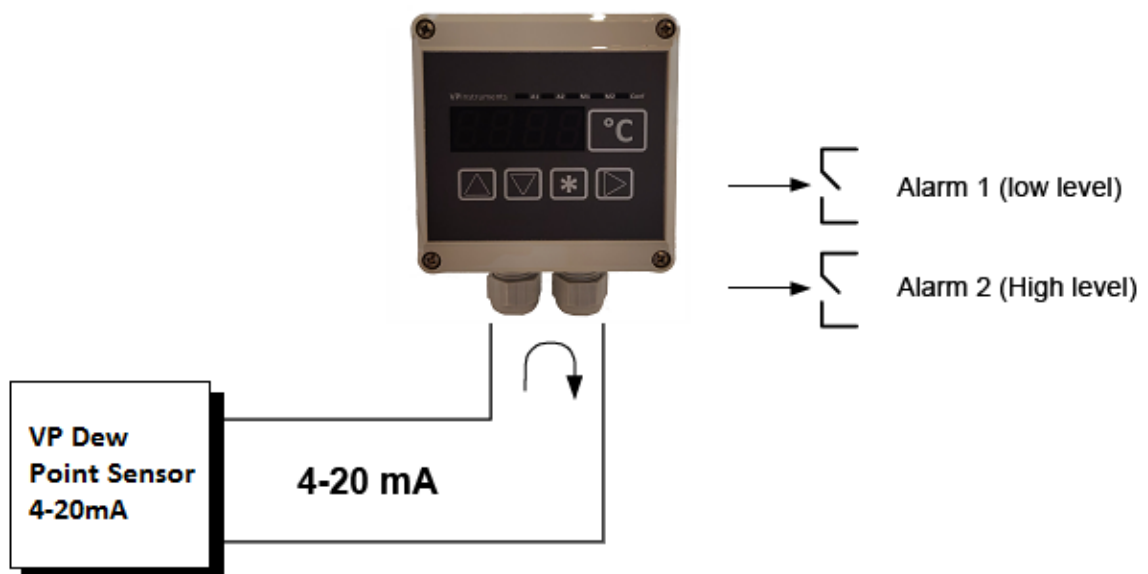

Display connector pin	Description	Wire color of standard cable
Pin 1	4 .. 20 mA +	Black
Pin 2	4 .. 20 mA -	White



NOTE The loop resistance of the display must be included in the loop resistance calculation for the complete current loop. For the loop resistance of the display, refer to the manufacturer's documentation.

8 Service

Periodic Maintenance

Cleaning

The body of the sensor can be cleaned by wiping with a moistened lint-free cloth. Do not immerse the VP Dew Point Sensor in liquid, and do not use cleaning agents or solvents.

Calibration

The VP Dew Point Sensor is fully calibrated as shipped from factory. The recommended calibration interval is two years.

Changing the Filter

Replace the filter if it is contaminated. New filters are available from VPInstruments; see section [order information and accessories](#)



CAUTION Be careful when changing the filter, since it is easy to break the sensor when the filter is removed.



CAUTION If the VP Dew Point Sensor is installed in a pressurized chamber, always make sure that the pressure of the chamber is equalized with the ambient pressure prior to removing the VP Dew Point Sensor. When the VP Dew Point Sensor is removed for maintenance, cap the hole with a capped nut. This way, the chamber can be pressurized although the VP Dew Point Sensor is not in place.

When replacing the filter, wear clean gloves to avoid depositing dirt or oil on the filter. Inspect the sealing ring for damage (used with ISO thread only), and replace it if necessary.

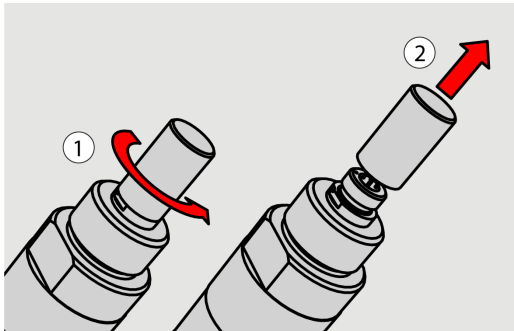

Replace the filter as follows:

1. Turn the filter counterclockwise until it is loose.
2. Pull the filter straight out carefully. Do not damage the sensor.
3. Take the new filter, and insert it to the filter thread.
4. Tighten the new filter to 5 Nm by turning it clockwise.

Repair Maintenance



CAUTION The VP Dew Point Sensor body does not have user serviceable parts inside, and is not designed to be opened. Opening the VP Dew Point Sensor will void the warranty.

If there is a problem with your VP Dew Point Sensor that you are unable to solve yourself, contact your local VPInstruments distributor.

For troubleshooting instructions, see [Appendix A - Troubleshooting](#)

9 Specifications



Please always check the label of your product for the specifications.
Specifications are subject to change as we are continuously improving our products.
Please contact us to obtain the latest specification sheet.

Dewpoint temperature

Dew point range	-70 .. 60 °C	-94 .. 140 °F
Accuracy in air or N2.	±2 °C ±3.6 °F of reading	

Response time 63% [90%], <i>at +20 °C (+68 °F), 1 bar pressure</i>	-60 to -20 °C -76 to -4 °F	5 s [15 s]
	-20 to -60 °C -4 to -76 °F	45 s [10 min]

PPM volume concentration

Measurement range	10 .. 40000 ppm (typical)
Accuracy <i>at +20 °C (+68 °F), 1 bar pressure</i>	1 ppm + 20 % of reading

Operation environment

Temperature	-40 .. 60 °C	-40 .. 140 °F
Relative humidity	0 .. 100 %	
Operating pressure	0 .. 50 bara	0 .. 725 psia
Measurand gasses	Non-corrosive gasses	
Sample flow rate	No effect on measurement accuracy	

Mechanical

Housing material	Stainless steel (AISI316L)	
Sensor protection	Stainless steel sintered filter	
Mechanical connection	ISO G1/2"	
IP grade	IP66 (NEMA4)	
Weight	90 g	3.2 oz
Storage temperature range	-40 .. 60 °C	-40 .. 140 °F
Ambient humidity	10 .. 95 %. Avoid condensation at all times	

Inputs and outputs

Analog output	4 .. 20 mA (3-wire)	
Resolution for current output	±0.002 mA	
Accuracy for current output <i>at +20 °C</i>	+/- 0.05 mA	
Typical temperature dependence	0.005 % of span / °C	
Digital output	RS-485 2 wire, non-isolated, Modbus RTU	
LED	For dewpoint level alarm and sensor diagnostics.	
Connector	M8 4-pin	

Electrical

Supply voltage with current output	18 .. 28 VDC
Supply voltage with RS-485	12 .. 28 VDC
Supply voltage, <i>in pressures over 20 bara (290 psia) or temperatures below 0°C</i>	24 .. 28 VDC
Supply current during normal measurement	Max 10 mA + load current
Supply current during self-diagnostics	Max. 220 mA pulsed
Load for current output	Max. 500 Ω
Load for voltage output	Min. 10k Ω

Certification

CE	EN 61326-1, EN 550022
----	-----------------------

10 Order information and Accessories

- VPA.8000.1018 Dew point sensor
- VPA.8000.1019 Dew point sensor kit (includes sampling cell and 10m | 31.82 ft cable)

Accessories

- VPA.8000.1514 Sampling block
- VPA.8000.1517 Adapter 3/8 inch BSP to 1/2 inch NPT process connection
- VPA.8000.1515 O-ring set (3 pieces)
- VPA.8000.1511 USB service cable
- VPA.8000.1510 4-pin M8 cable 10 m | 32.81 ft
- VPA.8000.1516 Replacement filter cap
- VPA.8000.1512 External display
- VPA.8000.1513 External display with alarm relays

11 Appendix A - Troubleshooting

Solving Typical Problems

Some problems can be solved by simply resetting the VP Dew Point Sensor. You can reset the VP Dew Point Sensor by disconnecting the power or issuing the restart command using Modbus. If resetting does not help, and if the problem is related to VP Dew Point Sensor software or settings, you can restore the factory configuration of the VP Dew Point Sensor by issuing the Reset command using Modbus. If you are unable to solve your problem with the VP Dew Point Sensor, contact VPIInstruments support via sales@vpinstruments.com.

Problem	Possible Causes and Solutions
Unable to access VP Dew Point Sensor on the RS-485 line.	Possible causes: Incorrect wiring, unknown serial settings. Check wiring. Try connecting as instructed in section electrical installation
Analog output seems to be stuck, the measurement is not changing.	Possible causes: Sensor diagnostics in progress (autocal or purge), malfunction error active. Check the active errors by reading the error status register.
Dewpoint alarm LED is red even though the measured dewpoint is not high.	Possible causes: the alarm limit may be set incorrectly for your application. Check and correct using the Modbus configuration options.

12 Appendix B - Mechanical dimensions

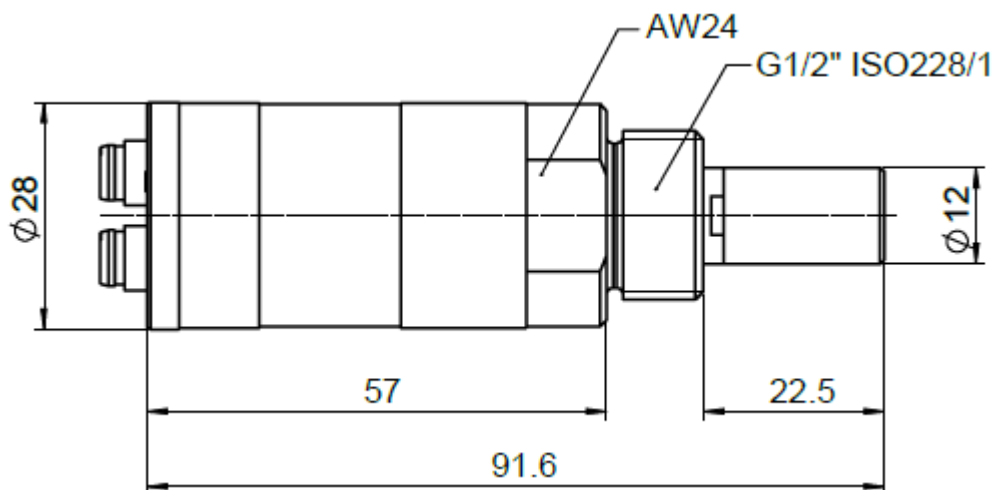

easy insight into energy flows

VPInstruments

Buitenwatersloot 335
2614 GS Delft
The Netherlands
info@vpinstruments.com
www.vpinstruments.com

MAN-VP-DEW-EN-1901

Date: 15-02-2019



INSTRUMENTS