



Regd. office:
Goldmedal Electricals Pvt. Ltd.
A/303, Kemp Plaza, Off Link Road,
MindSpace, Chincholi Bunder, Malad (W),
Mumbai-400064, Maharashtra, India

Web: www.goldmedalindia.com
Email: info@goldmedalindia.com

Goldmedal, Curve, Nixon, Air, Ringo,
Gifa & Cloudg are registered trademarks
of Goldmedal Electricals Pvt. Ltd.
Copyright protected by Goldmedal. No part of this
pricelist & catalogue may be printed or duplicated
without consent of Goldmedal Electricals Pvt.
Ltd. Patent, Trademark & Designs protected.
Infringement is liable for prosecution. Imitation
of graphics is a punishable offence.
Brand identity, concept & design of
Goldmedal Electricals Pvt. Ltd.



SCAN this QR-code from your
smart phone to visit our website



1ST EDITION MAR 2K22



Technology to upgrade
your
lifestyle.



**PRODUCTS & PRICING
MANUAL**

Leave the ordinary behind

Why choose the ordinary when you are worth so much more? Leave ordinary switches behind and switch to Goldmedal. We offer a vast range of innovative switches that add more elegance to your space and more meaning to your life. With cutting-edge features and sharp stylish looks, you will agree that every Goldmedal switch is far from ordinary.

Never ending innovation

At Goldmedal, the cycle of innovation never stops. We are always at the forefront of innovation, constantly identifying new ways of making products that are more efficient, more inspiring, more amazing. By creating products that are extraordinary in every way, we hope to make your life simpler, easier, and better. The new range of Artio and Arcos switches in the AIR modular range is another successful example of our endeavour.

Like the AIR modular range, the Artio and Arcos switches are delightfully simple and minimalistic in appearance. Embodying reductionism and refinement, which are the hallmarks of a sleek, modern, and urbane lifestyle, these switches make contemporary statements in every sense. An ingenious design, both the Artio and Arcos consists of either completely circular or a combination of semi-circular and straight modular switches embedded within a square frame.

Once installed, either individually or as a combination, the switches appear as perfectly symmetrical circles. The elegance, harmony, and unity of the Artio and Arcos switches give them a truly timeless appeal. These new switch ranges follow Goldmedal's impeccable record of crafting products that delight users with their thoughtful functionality and breathtaking aesthetics. With their refreshingly elegant designs, the Artio and Arcos are sure to set the benchmark for standard switches.

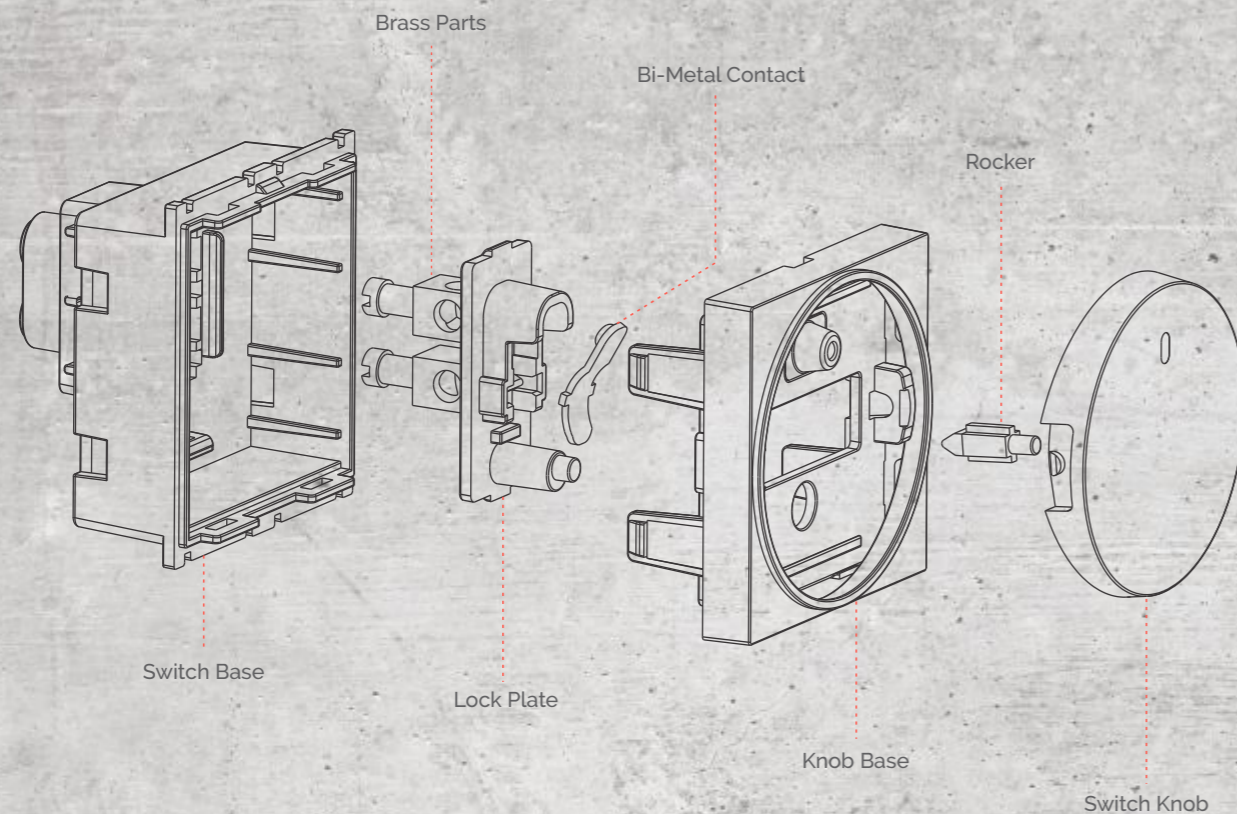

ARTIO
Flat. Sleek. Elegant.

Contents



Air
i-Smart Regulator
Bluetooth & Wi-Fi

Air
i-Smart Switches
Bluetooth & Wi-Fi

Air
i-Smart Dimmer
Bluetooth & Wi-Fi

Sec 01	Curve Modular Inserts	06-17
Sec 02	Nixon Modular Inserts	18-33
Sec 03	Modular Cover Plates	34-55
Sec 04	Air Modular Inserts	56-69
Sec 05	Air Modular Cover Plates	70-79
Sec 06	Gifa Cloud 9 Inserts	80-95
Sec 07	Gifa Modular Cover Plates	96-103
Sec 08	Curve Plus Products	104-123
Sec 09	Healthcare Products	124-125
Sec 10	Gifa Mini Modular Series 8	126-131
Sec 11	Gzifa Mini Modular	132-136
Sec 12	Essenza	137-141
Sec 13	Gazelle Wood Plates	142-143
Sec 14	Urea Range	144-155
Sec 15	DBs & MCBs	156-177

Endless possibilities for modern living

Nixon represents a new era in stylish living. Crafted in contemporary styles with minimalistic profiles in classical as well as revolutionary shades, Nixon introduces a variety of high quality lifestyle products that will change the way you look at modular switches and functions. All Nixon products are compatible with a variety of Goldmedal plates, including the Wega, making the possibilities for form, finish and colours, simply endless.



Wega Plate -
G-Dip Switch with Indicator



Wega Plate -
G-Click Switch with Indicator



Wega Plate -
i-Touch Wi-Fi Switches



Wega Plate -
i-Feel Fan Regulator



Wega Plate -
i-Sense Senso Switch



Wega Plate -
Universal Socket with Flap & Indicator



Wega Plate -
Galaxy 5 Step Full Rotary Regulator



Wega Plate -
32A DP Operated by Key Tag

i-Touch WiFi Panels

Feather Touch IoT/RF Enabled Home Automation
6 Module



TOUCH



TAP



SWIPE



Smart living made
smarter.



Presenting the next step in smart living. The i-Touch WiFi panels are the latest devices in Goldmedal's family of automation switches. Sleek and stylish in appearance, these backlit LED WiFi panels have a host of functions including switches, fan regulators, dimmers, USB sockets, and international sockets. Apart from manual operations, you can also control these panels using the RF Remote control and voice commands. You can even operate these panels from anywhere in the world using the i-World mobile app. There's no gateway required - the technology is built into the device. A complete system by itself, the module can be installed directly into a regular junction without the need for any new wiring.



Code	Item	MRP ₹		Pkg.
		White Jazz	Digital Chrome Voltage Grey	
10AX SWITCHES 240V~ (1 Module)				
101001	1 Way Switch	72.00	80.00	20/600
101002	1 Way Switch with Indicator (LED)	125.00	138.00	20/600
101003	2 Way Switch	144.00	159.00	20/600
101004	Bell Push Switch	147.00	163.00	20/600
101005	Bell Push Switch with Indicator (LED)	147.00	163.00	20/600
10AX SWITCHES 240V~ (2 Module)				
102010	1 Way Switch	121.00	132.00	10/300
102011	1 Way Switch with Indicator (LED)	131.00	145.00	10/300
102012	2 Way Switch	188.00	207.00	10/300
102013	Bell Push Switch	188.00	207.00	10/300
102014	Bell Push Switch with Indicator (LED)	210.00	230.00	10/300
6AMP BELL PUSH 240V~ (2 Module)				
102015	Bell Push with Luminous Name Plate 240V~ 50-60Hz LED circuit with diffuser	261.00	287.00	10/300
20AMP / 25 AMP SWITCHES 240V~ (1 Module)				
101020	20A 1 Way Switch	192.00	210.00	20/600
101021	20A 1 Way Switch with Indicator (LED)	207.00	228.00	20/600
101022	20A 2 Way Switch	213.00	234.00	20/600
101023	25A 1 Way Switch	231.00	254.00	20/600
20AMP / 25AMP SWITCHES 240V~ (2 Module)				
102025	20A 1 Way Switch	211.00	231.00	10/300
102026	20A 1 Way Switch with Indicator (LED)	231.00	254.00	10/300
102027	20A 2 Way Switch	244.00	268.00	10/300
102028	25A 1 Way Switch	265.00	291.00	10/300
32AMP DP SWITCHES 240V~				
102031	DP Switch with Indicator (LED) - 2M	362.00	398.00	10/300

Code	Item	MRP ₹		Pkg.
		White Jazz	Digital Chrome Voltage Grey	
6AMP / 10AMP SOCKETS 240V~				
101035	6A 2 Pin Socket (1M) with safety shutter	126.00	140.00	20/600
102036	6A 3 Pin Multi Socket (2M) with safety shutter	108.00	119.00	10/450
102037	6A 2x1 Socket (2M) with safety shutter	141.00	155.00	10/450
102038	6A 3 Pin Socket (2M) with safety shutter	134.00	148.00	10/450
102039	10A International Socket (2M) with safety shutter	245.00	269.00	10/450
102040	6A Universal Socket (2M) with mobile socket & safety shutter	164.00	180.00	10/450
6&16AMP / 25AMP SOCKETS 240V~ (2 Module)				
102041	6&16A Universal Socket with safety shutter	264.00	291.00	10/450
102042	25A 3 Pin Socket with safety shutter	290.00	320.00	10/450
DIMMERS 240 V~50-60Hz 300-450W				
101045	Dimmer (1M) 450W	311.00	342.00	20/600
102046	Dimmer (2M) 450W	406.00	448.00	10/300
FAN REGULATOR 240V~				
101051	4 Step Regulator (1M)	459.00	504.00	20/600
102052	5 Step Regulator (2M)	495.00	545.00	10/300
102052A	5 Step Regulator - Full Rotary (2M) - Regulator Supplied in ISI & Non ISI	495.00	545.00	10/300
MOTOR STARTER (SP) 240V~ 50-60Hz (2 Module)				
102056	10A Starter Switch	605.00	665.00	10/300
102057	16A Starter Switch	605.00	665.00	10/300
102058	20A Starter Switch	605.00	665.00	10/300
102059	25A Starter Switch	605.00	665.00	10/300
102060	32A Starter Switch	605.00	665.00	10/300
TV SOCKET / RJ-11 TELEPHONE JACKS (1 Module)				
101062	TV Socket Coaxial 40-862 Mhz Socket	147.00	161.00	20/900
101069	RJ-11 Single Telephone Jack	138.00	151.00	20/600
101070	RJ-11 Double Telephone Jack	162.00	177.00	20/600



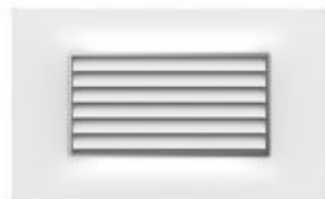

Code	Item	MRP ₹		Pkg.
		White Jazz	Digital Chrome Voltage Grey	
EDP SOCKET OUTLET RJ-45 WITH NAME PLATE (1 Module)				
101072	EDP Socket Outlet - RJ 45 (Cat 5e) Category 5e, Universal wiring T568A, insulating-piercing terminal with shutter	236.00	259.00	20/600
101074	EDP Socket Outlet - RJ 45 (Cat 6e) Category 6e, Universal wiring T568A, insulating-piercing terminal with shutter	617.00	678.00	20/600
SINGLE POLE MCBS 240/450V~ (1 Module)				
101077	C6 SP MCB	329.00	358.00	20/600
101078	C10 SP MCB	329.00	358.00	20/600
101079	C16 SP MCB	329.00	358.00	20/600
101080	C20 SP MCB	329.00	358.00	20/600
101081	C25 SP MCB	329.00	358.00	20/600
101082	C32 SP MCB 240/450V~ 50-60Hz 3kA Breaking Capacity	329.00	358.00	20/600
DOUBLE POLE MCBS 240/450V~ (2 Module)				
102083	C6 DP MCB	685.00	742.00	10/300
102084	C10 DP MCB	685.00	742.00	10/300
102085	C16 DP MCB	685.00	742.00	10/300
102086	C20 DP MCB	685.00	742.00	10/300
102087	C25 DP MCB	685.00	742.00	10/300
102088	C32 DP MCB 240/450V~ 50-60Hz 3kA Breaking Capacity	685.00	742.00	10/300
INDICATOR, FUSE UNITS (1 Module)				
101093	Indicator with LED & Red Diffuser	122.00	136.00	20/600
101098	Fuse Carrier 10 / 16AMP with miniature fuse dia 6.3x28	174.00	191.00	20/600
STEP MARKER LAMP (2 Module)				
102105	Step Marker Supply voltage 240V~ 50-60Hz with high-efficiency 1W LED & adjustable beam on three levels	575.00	632.00	5/120
FLOOR & STEP LIGHT 240~ (4 Module)				
120405	G-Focus Light (Blue LED)	775.00	852.00	5/120
120405W	G-Focus Light (White LED)	775.00	852.00	5/120
120405WW	G-Focus Light (Warm White LED)	775.00	852.00	5/120
120406	G-Focus Light Trio (LED) Fully recessed floor & step light with support frame & glassio cover plate with 3 color inbuilt LED Supply voltage 240V~50-60Hz	847.00	932.00	5/120

Code	Item	MRP ₹		Pkg.
		White Jazz	Digital Chrome Voltage Grey	
LIGHTING FITTING WITH EMERGENCY FUNCTION 240V~				
102119	Lighting Fitting with Emergency Function (2M) with High Efficiency 2x0.5W LED	872.00	941.00	5/100
103121	Lighting Fitting with Emergency Function (3M) with High Efficiency 3x0.5W LED Supply voltage 240V~ 50Hz 3 Steps Dimming Switch 240V~ 50Hz When battery is inserted, the device will function as an emergency light - Batteries supplied separately (101124)	1375.00	1515.00	5/100
EMERGENCY LIGHT BATTERY				
101123	AAA Ni-MH 1.2V 1100 mAh without "memory" effect interchangeable - 3 Batteries set (Spare parts)	398.00	-	N.A.
101124	Battery Li-ion, 3.6V 600mAh 2/3A	261.00	-	20/600
BLANK MODULE (1 Module)				
101125	Blank Module	31.00	34.00	50/2000
ELECTRONIC BUZZERS (2 Module)				
102138	Electronic Cuckoo Buzzer 240V~ 50-60Hz (LED)	197.00	217.00	10/300
102139	Electronic Bell 240V~ 50-60Hz (LED)	338.00	373.00	10/300
25A ELECTRONIC BADGE SWITCH (3 Module)				
103165	Electronic Switch with Smart Card 25A, 160-240V~ 50-60Hz with indicator (LED) & Integral relay having exit delay.	1654.00	1816.00	5/100
103166	Smart Card Customizable Smart Card	125.00	-	N.A.
DND / MAKE MY ROOM (2 Module)				
102168A	Do Not Disturb/Make My Room 240V~ 50-60Hz - Outside Room	449.00	492.00	10/300
102169A	Do Not Disturb/Make My Room 240V~ 50-60Hz - Inside Room	482.00	528.00	10/300





Code	Item	MRP ₹		Pkg.
		White Jazz	Digital Chrome Voltage Grey	
SHAVER SOCKET (4 Module)				
104171	Shaver Socket 240V~ 50-60Hz with isolating transformer output 110/240V~	1099.00	1209.00	5/50
USB CHARGER 240V~				
101172	USB Fast Charger - Single Port (1M) Supply voltage 160-240V~ 50-60Hz Output - 5V ≍ 1.50A / 9V ≍ 1.45A (Max 14W) NEW	950.00	1045.00	10/300
102173	USB Charger - Single Port (2M) Supply voltage 160-240V~ 50-60Hz Output - 5V DC, 1000mA or 1A with inbuilt switch & dual colour LED indicator	1030.00	1135.00	5/100
102174	USB Charger - Double Port (2M) Supply voltage 160-240V~ 50-60Hz Output - 5V DC, 2000mA or 2A	920.00	1012.00	5/100
CRISTALLO SWITCH MEMORIO KNOB				
101540	1 Module Switch Knob	12.00	-	50/2000
102541	2 Module Switch Knob	19.00	-	30/900
103542	3 Module Switch Knob (with support knob)	29.00	-	20/800
SMART PASSIVE INFRARED DETECTOR (2 Module)				
101210	Passive Infrared Detector with infrared sensor, adjustable dusk/dawn sensor threshold and time delay cycle, supply voltage 240V~ 50-60Hz, 6A relay output	1099.00	1209.00	5/120
102212	Smart Passive Infrared Detector with infrared sensor, auto on/off, adjustable dusk/dawn sensor threshold and time delay cycle, supply voltage 240V~ 50-60Hz, 6A relay output	1681.00	1849.00	5/120
LPG / METANO GAS DETECTOR 240V~ (3 Module)				
103225	LPG / Metano Gas Detector Detector with acoustic and optical signaling and control on a solenoid valve, supply voltage 240V~50-60Hz	2599.00	2799.00	5/100
RF REMOTE (RADIO FREQUENCY)				
103268	RF Remote with Stand 2 Nos AAA 1.5V Battery Radio Frequency : 433.92 Mhz All scene setting can be done through the Remote. - Battery not included	-	1999.00	5/100

#please refer to page no. 19 for wiring diagram & technical details of Touch Switches.



Wega Titanium Grey Plate
with Digital Silver Wi-Fi Router+Extender

Working from home calls for a reliable Wi-Fi network. Goldmedal's Wi-Fi Router + Extender is a smart solution for dead zone problems that many face. This unique device not only ensures uninterrupted and consistent Wi-Fi connectivity but can also extend the network signal to the remotest corners of your home. The device also has an inbuilt USB port for charging devices and Ethernet port for Internet connectivity. On the subject of charging, you should also consider the USB Charger & International Socket for getting your smart devices and electrical appliances charged. Along with charging your mobile devices, it also accepts different types of international plugs.



Wega Titanium Grey Plate
with Digital Silver USB Charger & Inter. Socket



Code	Item	MRP ₹		Pkg.
		White Jazz	Digital Chrome Voltage Grey	
BLUETOOTH PLAYER (2 Module)				
102273	Bluetooth Player Supply voltage 240V- Bluetooth player with transmitter & receiver. Multi colour LED to display different status Audio input - 3.5mm jack, Bluetooth (Rx mode) Audio output - Can be connected to bluetooth speaker or headphones in Tx mode (Input - Aux in) - Can be connected to any music system, home audio system, speakers i.e ceiling or inwall through amplifier via Line out Amplifier supplied separately - 101320	1200.00	1300.00	5/100
BLUETOOTH & FM PLAYER (8 Module)				
108274	Bluetooth & FM Player with Speaker Supply voltage 240V- Mode selection -Aux (Line 1), Aux (Line 2), FM & Bluetooth. Audio input - 3.5 jack (Front), Line In (Back), Bluetooth Audio output - Inbuilt Stereophonic Speaker 3W x 2 - Can be connected to any music system, home audio system, speakers i.e ceiling or inwall through amplifier via Line out Amplifier supplied separately - 101320	4999.00	5499.00	5/50
i - DOCK PLAYER (4 Module)				
104281	i-Dock Player Supply voltage 240V- Inbuilt stereo amplifier : 2 x 4W, charging function for iPod and iPhone. Audio input - 3.5mm jack, i-pod, i-phone & via Bluetooth Receiver (101283) Audio output - Stereo Line out, 2 Speaker out 4W each - Can be connected to any music system, home audio system, speakers i.e ceiling or inwall through amplifier via Line out (Aux out) - Amplifier supplied separately - 101320 - Bluetooth Receiver supplied separately - 101283 Unit supplied with infrared Remote	3100.00	3300.00	5/50
BLUETOOTH RECEIVER (PORTABLE)				
101283	Bluetooth Receiver (Portable) Made for iPod and iPhone docking Can be operated by any bluetooth device i.e. iPod, iPhone, iPad, Laptop, Mobile etc.	-	1100.00	5/50

* introducing shortly

Code	Item	MRP ₹		Pkg.
		White Jazz	Digital Chrome Voltage Grey	
STEREOPHONIC SPEAKER (2 Module)				
102306	Stereophonic Speaker - 2piece set Stereophonic loud Speaker Load rating : 4W Impedance : 4 ohms	699.00	769.00	10/100
CURVE MODULAR COVER PLATE SUITCASE				
101645#	Curve Cover Plate Suitcase	-	2100.00	1/5
AIR MODULAR COVER PLATE SUITCASE				
101647#	Air Cover Plate Suitcase	-	1000.00	1/5
GIFA MODULAR COVER PLATE SUITCASE				
101648#	Gifa Cover Plate Suitcase	-	1000.00	1/5
AUTOMATION SUITCASE				
101649#	Automation Suitcase Quorra Crystallight plate with Nixon WiFi inserts RF remote 6M WiFi panel	-	15000.00	1/5

Note: Prices of above Suitcases are Net Price & will be billed in Project Only.

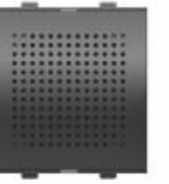



Code	Item	MRP ₹		Pkg.
		Absolute White	Digital Silver Titanium Grey	
10AX SWITCHES 240V~ (1 Module)				
101401	1 Way Switch	74.00	81.00	20/600
101402	1 Way Switch with Indicator (LED)	131.00	144.00	20/600
101403	2 Way Switch	149.00	164.00	20/600
101404	Bell Push Switch	151.00	165.00	20/600
101405	Bell Push Switch with Indicator (LED)	151.00	165.00	20/600

Code	Item	MRP ₹		Pkg.
		Absolute White	Digital Silver Titanium Grey	
10AX SWITCHES 240V~ (2 Module)				
102410	1 Way Switch	129.00	141.00	10/300
102411	1 Way Switch with Indicator (LED)	139.00	152.00	10/300
102412	2 Way Switch	200.00	219.00	10/300
102413	Bell Push Switch	200.00	219.00	10/300
102414	Bell Push Switch with Indicator (LED)	222.00	244.00	10/300
102415	Bell Push Switch with Luminous Name Plate	277.00	305.00	10/300

Code	Item	MRP ₹		Pkg.
		Absolute White	Digital Silver Titanium Grey	
20AMP / 25AMP SWITCHES 240V~ (1 Module)				
101420	20A 1 Way Switch	199.00	219.00	20/600
101421	20A 1 Way Switch with Indicator	216.00	239.00	20/600
101422	20A 2 Way Switch	222.00	245.00	20/600
101423	25A 1 Way Switch	238.00	262.00	20/600

Code	Item	MRP ₹		Pkg.
		Absolute White	Digital Silver Titanium Grey	
20AMP / 25AMP SWITCHES 240V~ (2 Module)				
102425	20A 1 Way Switch	218.00	239.00	10/300
102426	20A 1 Way Switch with Ind. (LED)	243.00	267.00	10/300
102427	20A 2 Way Switch	261.00	289.00	10/300
102428	25A 1 Way Switch	277.00	305.00	10/300

Code	Item	MRP ₹		Pkg.
		Absolute White	Digital Silver Titanium Grey	
32AMP DP SWITCHES 240V~ (2 Module)				
102431	32A DP Switch with Indicator (LED)	388.00	428.00	10/300

240V~ 50-60Hz LED circuit with diffuser

Code	Item	MRP ₹		Pkg.
		Absolute White	Digital Silver Titanium Grey	
G-Click 10AX SWITCHES 240V~ (1 Module)				
101751	1 Way Switch	81.00	88.00	20/600
101752	1 Way Switch with Indicator (LED)	137.00	152.00	20/600
101753	2 Way Switch	151.00	167.00	20/600
101754	Bell Push Switch	158.00	172.00	20/600
101755	Bell Push Switch with Indicator (LED)	168.00	184.00	20/600

Code	Item	MRP ₹		Pkg.
		Absolute White	Digital Silver Titanium Grey	
G-Click 10AX SWITCHES 240V~ (2 Module)				
102760	1 Way Switch	136.00	150.00	10/300
102761	1 Way Switch with Indicator (LED)	146.00	160.00	10/300
102762	2 Way Switch	209.00	229.00	10/300
102764	Bell Push Switch with Indicator (LED)	231.00	254.00	10/300

Code	Item	MRP ₹		Pkg.
		Absolute White	Digital Silver Titanium Grey	
G-Click 20AMP / 25AMP SWITCHES 240V~ (1 Module)				
101770	20A 1 Way Switch	207.00	228.00	20/600
101771	20A 1 Way Switch with Indicator	217.00	239.00	20/600
101772	20A 2 Way Switch	223.00	245.00	20/600
101773	25A 1 Way Switch	249.00	273.00	20/600

Code	Item	MRP ₹		Pkg.
		Absolute White	Digital Silver Titanium Grey	
G-Click 20AMP / 25AMP SWITCHES 240V~ (2 Module)				
102775	20A 1 Way Switch	228.00	251.00	10/300
102776	20A 1 Way Switch with Ind. (LED)	253.00	278.00	10/300
102777	20A 2 Way Switch	274.00	301.00	10/300
102778	25A 1 Way Switch	291.00	320.00	10/300

Code	Item	MRP ₹		Pkg.
		Absolute White	Digital Silver Titanium Grey	
G-Click 32AMP DP SWITCHES 240V~ (2 Module)				
102781	32A DP Switch with Indicator (LED)	406.00	448.00	10/300





Code	Item	MRP ₹		Pkg.
		Absolute White	Digital Silver Titanium Grey	
G-Dip 10AX SWITCHES 240V~ (1 Module) NEW				
101801*	1 Way Switch	74.00	81.00	20/600
101802*	1 Way Switch with Indicator (LED)	131.00	144.00	20/600
101803*	2 Way Switch	149.00	164.00	20/600
101804*	Bell Push Switch	151.00	165.00	20/600
101805*	Bell Push Switch with Indicator (LED)	161.00	177.00	20/600

Code	Item	MRP ₹		Pkg.
		Absolute White	Digital Silver Titanium Grey	
G-Dip 10AX SWITCHES 240V~ (2 Module) NEW				
102810*	1 Way Switch	129.00	142.00	10/300
102811*	1 Way Switch with Indicator (LED)	139.00	152.00	10/300
102812*	2 Way Switch	200.00	219.00	10/300
102813*	Bell Push Switch	200.00	219.00	10/300
102814*	Bell Push Switch with Indicator (LED)	222.00	244.00	10/300

Code	Item	MRP ₹		Pkg.
		Absolute White	Digital Silver Titanium Grey	
G-Dip 20AMP / 25AMP SWITCHES 240V~ (1 Module) NEW				
101820*	20A 1 Way Switch	199.00	219.00	20/600
101821*	20A 1 Way Switch with Indicator	216.00	239.00	20/600
101822*	20A 2 Way Switch	222.00	245.00	20/600
101823*	25A 1 Way Switch	238.00	262.00	20/600

Code	Item	MRP ₹		Pkg.
		Absolute White	Digital Silver Titanium Grey	
G-Dip 20AMP / 25AMP SWITCHES 240V~ (2 Module) NEW				
102825*	20A 1 Way Switch	218.00	239.00	10/300
102826*	20A 1 Way Switch with Ind. (LED)	243.00	267.00	10/300
102827*	20A 2 Way Switch	261.00	289.00	10/300
102828*	25A 1 Way Switch	277.00	305.00	10/300

Code	Item	MRP ₹		Pkg.
		Absolute White	Digital Silver Titanium Grey	
G-Dip 32AMP DP SWITCHES 240V~ (2 Module) NEW				
102831*	32A DP Switch with Indicator (LED)	388.00	428.00	10/300

Code	Item	MRP ₹		Pkg.
		Absolute White	Digital Silver Titanium Grey	
6AMP / 10AMP SOCKETS 240V~				
101435	6A 2 Pin Socket (1M) with safety shutter	129.00	142.00	20/600
102437	6A 2x1 Socket (2M) with safety shutter	151.00	166.00	10/450
102438	6A 3 Pin Socket (2M) with safety shutter	144.00	158.00	10/450
102439	10A International Socket (2M) with safety shutter	260.00	286.00	10/450
102440	6A Universal Socket (2M) with mobile socket & safety shutter	175.00	193.00	10/450

Code	Item	MRP ₹		Pkg.
		Absolute White	Digital Silver Titanium Grey	
6&16AMP / 6&25AMP SOCKETS 240V~ (2 Module)				
102441	6&16A Universal Socket with safety shutter	283.00	311.00	10/450
102442	6&25A Universal Socket with safety shutter	305.00	335.00	10/450

Code	Item	MRP ₹		Pkg.
		Absolute White	Digital Silver Titanium Grey	
6 & 16AMP SOCKET WITH FLAP - (2 Module)				
102444	6&16A Universal Socket with flap & Indicator - 240V~	283.00	311.00	10/450

Code	Item	MRP ₹		Pkg.
		Absolute White	Digital Silver Titanium Grey	
DIMMER / FAN REGULATOR 240 V~				
101445	Dimmer - 450W (1M)	351.00	385.00	20/600
101451	4 Step Regulator (1M)	516.00	568.00	20/600
102452	5 Step Regulator (2M)	550.00	604.00	10/300
- Regulator Supplied with ISI & Non ISI				

Code	Item	MRP ₹		Pkg.
		Absolute White	Digital Silver Titanium Grey	
FAN REGULATOR 240V~ (2 Module)				
102453	5 Step Galaxy Step Regulator Half Rotary (Pure White)	522.00	-	10/300
102454	5 Step Galaxy Step Regulator Full Rotary (Pure White)	550.00	-	10/300
- Regulator Supplied with ISI & Non ISI				

Code	Item	MRP ₹		Pkg.
		Absolute White	Digital Silver Titanium Grey	
FAN REGULATOR 240V~ (2 Module)				
102453A	5 Step Galaxy Step Regulator Half Rotary (Chrome Knob)	546.00	600.00	10/300
102454A	5 Step Galaxy Step Regulator Full Rotary (Chrome Knob)	575.00	632.00	10/300
- Regulator Supplied with ISI & Non ISI				

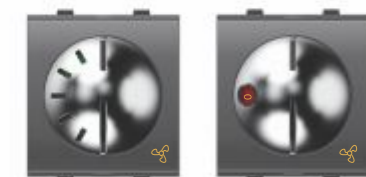



Code	Item	MRP ₹		Pkg.
		Absolute White	Digital Silver Titanium Grey	
MOTOR STARTER (SP) 240V~ 50-60Hz (2 Module)				
102456	10A Motor Starter Switch	648.00	712.00	10/300
102457	16A Motor Starter Switch	648.00	712.00	10/300
102458	20A Motor Starter Switch	648.00	712.00	10/300
102459	25A Motor Starter Switch	648.00	712.00	10/300
102460	32A Motor Starter Switch	648.00	712.00	10/300
TV SOCKET / RJ-11 TELEPHONE JACKS / EDP SOCKET (1 Module)				
101462	TV Socket Coaxial 40-862 Mhz Socket	151.00	164.00	20/900
101468	Telephone Jack - RJ 11	159.00	174.00	20/600
101472	EDP Socket Outlet - RJ 45 (Cat 5e) Category 5e, Universal wiring T568A, insulating-piercing terminal	259.00	285.00	20/600
101474	EDP Socket Outlet - RJ 45 (Cat 6e) Category 6e, Universal wiring T568A, insulating-piercing terminal	653.00	718.00	20/600
SINGLE POLE MCBS 240/450V~ (1 Module)				
101477	C6 SP MCB	356.00	391.00	20/600
101478	C10 SP MCB	356.00	391.00	20/600
101479	C16 SP MCB	356.00	391.00	20/600
101480	C20 SP MCB	356.00	391.00	20/600
101481	C25 SP MCB	356.00	391.00	20/600
101482	C32 SP MCB	356.00	391.00	20/600
	240/450V~ 50-60Hz 3kA Breaking Capacity			
DOUBLE POLE MCBS 240/450V~ (2 Module)				
102483	C6 DP MCB	699.00	768.00	10/300
102484	C10 DP MCB	699.00	768.00	10/300
102485	C16 DP MCB	699.00	768.00	10/300
102486	C20 DP MCB	699.00	768.00	10/300
102487	C25 DP MCB	699.00	768.00	10/300
102488	C32 DP MCB	699.00	768.00	10/300
	240/450V~ 50-60Hz 3kA Breaking Capacity			
G-POWER 25A UNIT (4 Module)				
104491	G-Power 25A Unit (Metal Box) with Concealed Metal Junction Box (4M Plate with 25A MCB, 25A Socket & 16A G-grip Top)	839.00	929.00	5/60
104492	G-Power 25A Unit (Plastic Box) with G-surface Plastic Gang Box (4M Plate with 25A MCB, 25A Socket & 16A G-grip Top)	809.00	889.00	5/60
	240/450V~ 50-60Hz 3kA Breaking Capacity			
INDICATOR / FUSE UNIT / BLANK MODULE (1 Module)				
101493	Indicator with LED & Red Diffuser	129.00	142.00	20/600
101498	Fuse Carrier (10Amp/16Amp) with miniature fuse dia 6.3x28	174.00	191.00	20/600
101525	Blank Module	33.00	35.00	50/2000

Code	Item	MRP ₹		Pkg.
		Absolute White	Digital Silver Titanium Grey	
STEP MARKER				
102505	Step Marker (2M) with High Efficiency 2x0.5W LED	586.00	645.00	5/120
103506	Step Marker with Step Dimming Function (3M) with High Efficiency 3x0.5W LED	1078.00	1186.00	5/100
102507	Step Marker with Smart Dimming Function (2M) with High Efficiency 2x0.5W LED	815.00	895.00	5/100
103508	Step Marker with Trio LED & Step Dimming Function (3M) with High Efficiency 3x0.5W LED Supply voltage 240V~ 50-60Hz,	1078.00	1186.00	5/100
LIGHTING FITTING WITH EMERGENCY FUNCTION				
102510	Lighting Fitting with Emergency Function (2M) with High Efficiency 2x0.5W LED	872.00	941.00	5/100
103511	Lighting Fitting with Emergency Function (3M) with High Efficiency 3x0.5W LED Supply voltage 160-240V~ 50Hz Dimmable function (3 Level) The device will function as an emergency light if battery is inserted - Battery supplied separately (101123 for 3M / 101124 for 2M)	1375.00	1515.00	5/100
ELECTRO MECHANICAL BUZZER / ELECTRONIC BUZZER 240V ~				
101530	Electro Mechanical Buzzer (1M) 240V-50-60Hz	176.00	193.00	20/600
102539	Electronic Bell (2M) 240V-50-60Hz	399.00	438.00	10/300
ELECTRONIC DOOR BELLS (4 Module)				
104541	Electronic Multi Tune Bell with 4 selectable melodies Supply voltage 240V~ 50-60Hz,	1034.00	1150.00	5/150
i-TOUCH RF SWITCHES / UNIVERSAL SWITCH (2 Module)				
102544	i-Touch 2 Switch Supply voltage 160-240V~, 6A relay output Operating load (CFL & LED): 100W Max (per switch) Radio Frequency : 433.92 Mhz Can also be operated by RF Remote control-103268 or web/mobile application via Gateway-101646	3500.00	3900.00	5/100
102545	i-Touch Universal Switch Supply voltage 240V~, - Can be paired wirelessly with any Goldmedal RF switch, fan regulator, dimmer etc. (Touch, i-Touch and i-Feel) as a two way switch - Can be configured as a switch for any particular scene or All ON or All OFF command	3900.00	4300.00	5/100
i-TOUCH BELL PUSH / RF 20A SWITCH (2 Module)				
102548	i-Touch Bell Push Switch Supply voltage 160-240V~ 2A relay output	2300.00	2500.00	5/100
102550	i-Touch 20A Switch Supply voltage 160-240V~, 20A relay output Operating load (CFL & LED): 200W Max Air conditioner: 2 ton Radio Frequency : 433.92 Mhz Can also be operated by RF Remote control-103268 or web/mobile application via Gateway-101646	3600.00	4000.00	5/100



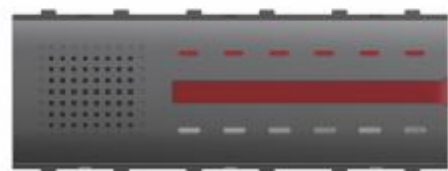
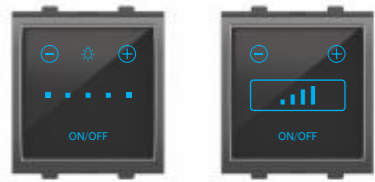

Code	Item	MRP ₹		Pkg.
		Absolute White	Digital Silver Titanium Grey	
i-TOUCH RF DIMMER/FAN REGULATOR/DRAPE CONTROLLER (2M)				
102553	i-Touch Light Dimmer Supply voltage 160-240V~, Triac Technology with soft end & soft start function Operating load (LED) : 80W (Max) Incandescent Light: 40-450W Not suitable for Fan	3500.00	3800.00	5/100
102554	i-Touch Fan Regulator Supply voltage 160-240V~ Variable Capacitance based 4 step regulator Operating load (Fan) : 100W	3500.00	3800.00	5/100
102556	i-Touch Drape Controller Supply voltage 160-240V~ 2.5A relay output Electronic RF Drape Controller suitable for AC Motor Radio Frequency : 433.92 Mhz Can also be operated by RF Remote control-103268 or web/mobile application via Gateway-101646	3800.00	4200.00	5/100

i-TOUCH DO NOT DISTURB/MAKE MY ROOM (2 Module)				
102560	i-Touch DND / Make My Room / Please Wait (Inside Room)	2100.00	2500.00	5/100
102561	i-Touch DND / Make My Room / Please Wait with Bell Push Switch (Outside Room) Supply voltage 160-240V~ (Inside & outside unit are connected to each other)	2300.00	2700.00	5/100

32A MAIN SWITCH (3 Module)				
103562	32A DP Operated by Key Tag 240V~, LED Supplied with Key Tag For key tag please refer Curve product 102164	571.00	627.00	5/150

32A MAIN SWITCH (2 Module)				
102563	32A DP Operated by Key Tag 240V~, LED Supplied with Key Tag	624.00	686.00	10/300
102564	Only Key Tag with Name Plate	115.00	126.00	N.A.

25A ELECTRONIC BADGE SWITCH (3 Module)				
103565	Electronic Switch with Smart Card 25A, 160-240V~ 50-60Hz with indicator (LED) & Integral relay having exit delay. For smart card please refer Curve product 103166	1654.00	1816.00	5/100

BELL INDICATOR (6 Module) 240~				
106567	Bell Indicator with 6 Display Units with buzzer, reset switches & name plate	1699.00	1899.00	5/100

Code	Item	MRP ₹		Pkg.
		Absolute White	Digital Silver Titanium Grey	
DND/MAKE MY ROOM 240~ (2 Module)				
102568	Do Not Disturb/Make My Room 240V~ 50-60Hz - Inside Room	475.00	518.00	10/300
102569	Do Not Disturb/Make My Room 240V~ 50-60Hz - Outside Room	508.00	550.00	10/300
USB CHARGER / INTERNATIONAL SOCKET				
101571	USB Fast Charger - Single Port (1M) Supply voltage 160-240V~ 50-60Hz Output - 5V = 1.50A / 9V = 1.45A (Max 14W) NEW	950.00	1045.00	10/300
101572	USB Charger - (1M) Supply voltage 160-240V~ 50-60Hz	865.00	952.00	10/300
102573	USB Charger - Double Port (2M) Supply voltage 160-240V~ 50-60Hz Output - 5V DC, 2A (Total)	920.00	1012.00	5/100
103574	USB Charger & 10A Int. Socket (3M) Supply voltage 160-240V~ 50-60Hz Output - 5V DC, 2A (Total)	1248.00	1370.00	5/100

AUDIO - VIDEO SOCKET (1 Module)				
101577	HDMI Socket	1000.00	1102.00	5/150
101579	Triple RCA Socket (Audio & Video)	660.00	720.00	5/150

ROUTER + EXTENDER (3 Module)				
103580	Wi-Fi Router + Extender 300 MBPS wi-fi wireless router with Ethernet port, In-built USB port for internet connectivity and charging devices. Also support 4G dongle.	4500.00	5000.00	5/100

CAMERA / IP CAMERA				
102598*	Camera (2M) Automatic day/night switching, Camera can be manually swivelled 20° horizontally & vertically Automatic background lighting compensation. Automatic gain control (AGC) Protection type IP 44	-	8999.00	5/100
103599*	IP Camera (3M) Automatic day/night switching, Camera can be manually swivelled 20° horizontally & vertically Automatic background lighting compensation. Automatic gain control (AGC) Supply voltage 160-240V~	-	14400.00	5/100

i-SENSE SENSO SWITCH (2 Module)				
102601	i-Sense Senso Switch Supply voltage 160-240V~ 6A relay output Allows to control lights by simply passing the hand in front of it (Max distance 50mm). 2 units can be combined to control the same light (2 way function).	2999.00	3300.00	5/100

* introducing shortly



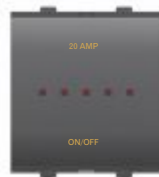

Code	Item	MRP ₹		Pkg.
		Absolute White	Digital Silver Titanium Grey	
i-SENSE FM RADIO / BLUETOOTH PLAYER				
102603*	i-Sense FM Radio (2M) Feather touch FM radio with digital display 87-50 MHz, 30 Station Memory with scanner	-	6100.00	5/100
103604	i-Sense FM Radio / Bluetooth (3M) FM & Bluetooth player Mode selection : FM & Bluetooth. Audio output - Stereo Line out - Can be connected to any music system, home audio system, speakers i.e ceiling or inwall through amplifier via Line out, Supply voltage 240V~ - Amplifier supplied separately - 101320	2500.00	-	5/100
i-FEEL RF SWITCHES / BELL PUSH SWITCH (2 Module)				
102626	i-Feel 2 Switch Supply voltage 160-240V~, 6A relay output Operating load (CFL & LED): 100W Max (per switch) Radio Frequency : 433.92 Mhz - Can also be operated by RF Remote control-103268 or web/mobile application via Gateway-101646	3500.00	3850.00	5/100
102630	i-Feel Bell Push Switch Supply voltage 160-240V~ 2A relay output	2000.00	2200.00	5/100
i-FEEL RF 20A SWITCH (2 Module)				
102632	i-Feel 20A Switch Supply voltage 160-240V~, 20A relay output Operating load (CFL & LED): 200W Max Air Conditioner: 2 ton Radio Frequency : 433.92 Mhz Can also be operated by RF Remote control-103268 or web/mobile application via Gateway-101646	3700.00	4070.00	5/100
i-FEEL RF DIMMER / FAN REGULATOR (2 Module)				
102634*	i-Feel Light Dimmer Supply voltage 160-240V~, Triac Technology with soft end & soft start function Operating load LED: 80W Incandescent Light: 40-450W Not suitable for Fan	3500.00	3850.00	5/100
102636	i-Feel Fan Regulator Supply voltage 160-240V~ Variable Capacitance based 4 step regulator Operating load (Fan) : 100W Radio Frequency: 433.92 Mhz Can also be operated by RF Remote control-103268 or web/mobile application via Gateway-101646	3500.00	3850.00	5/100
i-FEEL RF DRAPE CONTROLLER (2 Module)				
102638	i-Feel Drape Controller Supply voltage 160-240V~ 2.5A relay output Electronic RF Drape Controller suitable for AC Motor Radio Frequency : 433.92 Mhz Can also be operated by RF Remote control-103268 or web/mobile application via Gateway-101646	3600.00	3960.00	5/100
i-REMOTE CONTROL				
101926	i-Remote with Micro USB Cable Wifi-IR Remote Control Universal Infrared Remote Control Can operate TV, Set Top Box, AC and other IR Remotes Works with WiFi through iWorld App or Voice Command (Google Home / Amazon Alexa)	-	2999.00	1/1

*introducing shortly

Code	Item	MRP ₹		Pkg.
		Absolute White	Digital Silver Titanium Grey	
i-TOUCH WI-FI SWITCH (2 Module)				
102901	i-Touch - Wi-Fi 2 Switch Supply voltage 160-240V~, 6A relay output Operating load (CFL & LED): 100W Max (per switch) Radio Frequency : 433.92 Mhz Can also be operated by RF Remote control-103268 or via WI-FI Internet (without Gateway)	4500.00	4950.00	5/100
i-TOUCH WI-FI 20A SWITCH (2 Module)				
102903	i-Touch - Wi-Fi 20A Switch Supply voltage 160-240V~, 20A relay output Operating load (CFL & LED): 200W Max Air conditioner: 2 ton Radio Frequency : 433.92 Mhz Can also be operated by RF Remote control-103268 or via WI-FI Internet (without Gateway)	4500.00	4950.00	5/100
i-TOUCH WI-FI DIMMER/FAN REGULATOR (2 Module)				
102906	i-Touch Wi-Fi Dimmer Supply voltage 160-240V~, Triac Technology with soft end & soft start function Operating load (LED) : 80W (Max) Incandescent Light: 40-450W Not suitable for Fan	4500.00	4950.00	5/100
102907	i-Touch Wi-Fi Fan Regulator Supply voltage 160-240V~ Variable Capacitance based 4 step regulator Operating load (Fan) : 100W Radio Frequency : 433.92 Mhz Can also be operated by RF Remote control-103268 or via WI-FI Internet (without Gateway)	4500.00	4950.00	5/100
i-TOUCH WI-FI DRAPE CONTROLLER (2 Module)				
102909	i-Touch Wi-Fi Drape Controller Supply voltage 160-240V~ 2.5A relay output Electronic RF Drape Controller suitable for AC Motor Radio Frequency : 433.92 Mhz Can also be operated by RF Remote control-103268 or via WI-FI Internet (without Gateway)	4500.00	4950.00	5/100
i-TOUCH WI-FI SWITCH (3 Module)				
103913	i-Touch - Wi-Fi 4 Switch with Master Supply voltage 160-240V~, 6A relay output Operating load (CFL & LED): 100W Max (per switch) Radio Frequency : 433.92 Mhz	6600.00	7300.00	5/100
103916	i-Touch - Wi-Fi 2 Switch + 1 Fan Regulator with Master Supply voltage 160-240V~, 6A relay output Operating load (CFL & LED): 100W Max (per switch) Radio Frequency : 433.92 Mhz Can also be operated by RF Remote control-103268 or via WI-FI Internet (without Gateway)	7600.00	8400.00	5/100
i-TOUCH WI-FI PANEL 240V~ (6 Module) NEW				
106925	i-Touch - WiFi 6 Switch + Fan Reg. + 2 USB Port + Int. Socket (With Glass Plate) Supply voltage 160-240V~, 6A relay output Operating load (CFL & LED): 100W Max (per switch) Radio Frequency : 433.92 Mhz Variable Capacitance based 5 Step Fan Regulator USB Output: 5V 2A DC (Max) Socket: 10A International Socket Can also be operated by RF Remote control-103268 or via WI-FI Internet (without Gateway)	-	13500.00	5/-

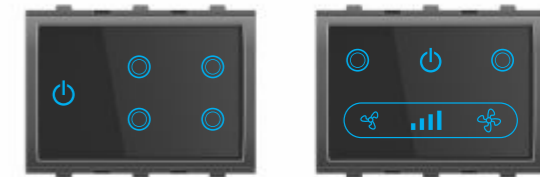



Code	Item	MRP ₹		Pkg.
		Absolute White	Digital Silver Titanium Grey	
i-HOME AUTOMATION				
101646	i-Home Gateway - Compatible with RF Touch, i-Touch & i-Feel products. - Connects electrical functions through a router. - Control from anywhere using your smartphone / tablet / laptop / desktop. - Individual device control as well as scene settings. - Schedule individual devices as well as scenes.	9999.00	-	1/1
SIGNAGE 240V~ 50-60Hz - [3 Module]				
103647	Foot Light (LED) Supply voltage 240V~ 50-60Hz	603.00	677.00	5/100
103648	Step Marker (LED) Supply voltage 240V~ 50-60Hz	563.00	631.00	5/100
103649	LED Indicator Supply voltage 240V~ 50-60Hz	546.00	604.00	5/100
103650	LED Signage Supply voltage 240V~ 50-60Hz	546.00	604.00	5/100
EDGE GLOW LED SIGNAGE 240V~ 50-60 Hz - [3 Module]				
103652	Edge Glow LED Signage* Supply voltage 240V~ 50-60Hz	445.00	490.00	5/100
103653	Edge Glow Square Slide customizable symbol	205.00	-	5/100
103654	Edge Glow Rectangle Slide customizable symbol	225.00	-	5/100
103655	Edge Glow L Type Slide customizable symbol	255.00	-	5/100

* Edge Glow Slide Supplied Separately

SYMBOLS FOR CUSTOMIZABLE SLIDE OF EDGE GLOW LED SIGNAGE (LASER ENGRAVING)



i-HOME Automation
INTELLIGENT GATEWAY



YOUR WORLD.
YOUR WAY.

WELCOME TO YOUR NEW, INTELLIGENT HOME!

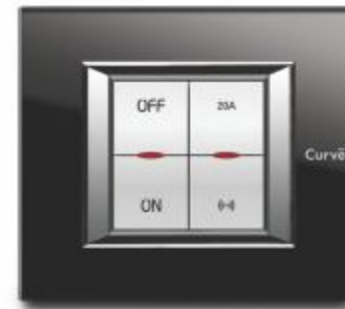

RF Touch Products



i-Touch Products



i-Feel Products

You have installed the latest Touch technology switches from Goldmedal in your home. Now, take it to the next level with the i-Home Gateway! From lights to fans to drapes and other functions, you can control individual devices, set scenes or even schedule the operations of scenes and devices using your smartphone, tablet, desktop or any smart mobile device ... from anywhere in the world.



i-HOME GATEWAY

The i-Home Gateway Router connects to your network in a few simple steps. Once connected, it captures commands from your Smartphone, tablet, laptop or PC from anywhere in the world. The commands are then relayed to the relevant RF devices in the premises.

SMARTPHONE

Access the i-Home Gateway Application on the move on your Smartphone, Tablet or PC. The intuitive interface enables you to set scenes, create timers and schedule devices as per your need!

Goldmedal i-Home

Download the Goldmedal i-Home App on your smart device to control your RF Switches from anywhere in the world. Download now!



Scan with your smartphone to download the user manual

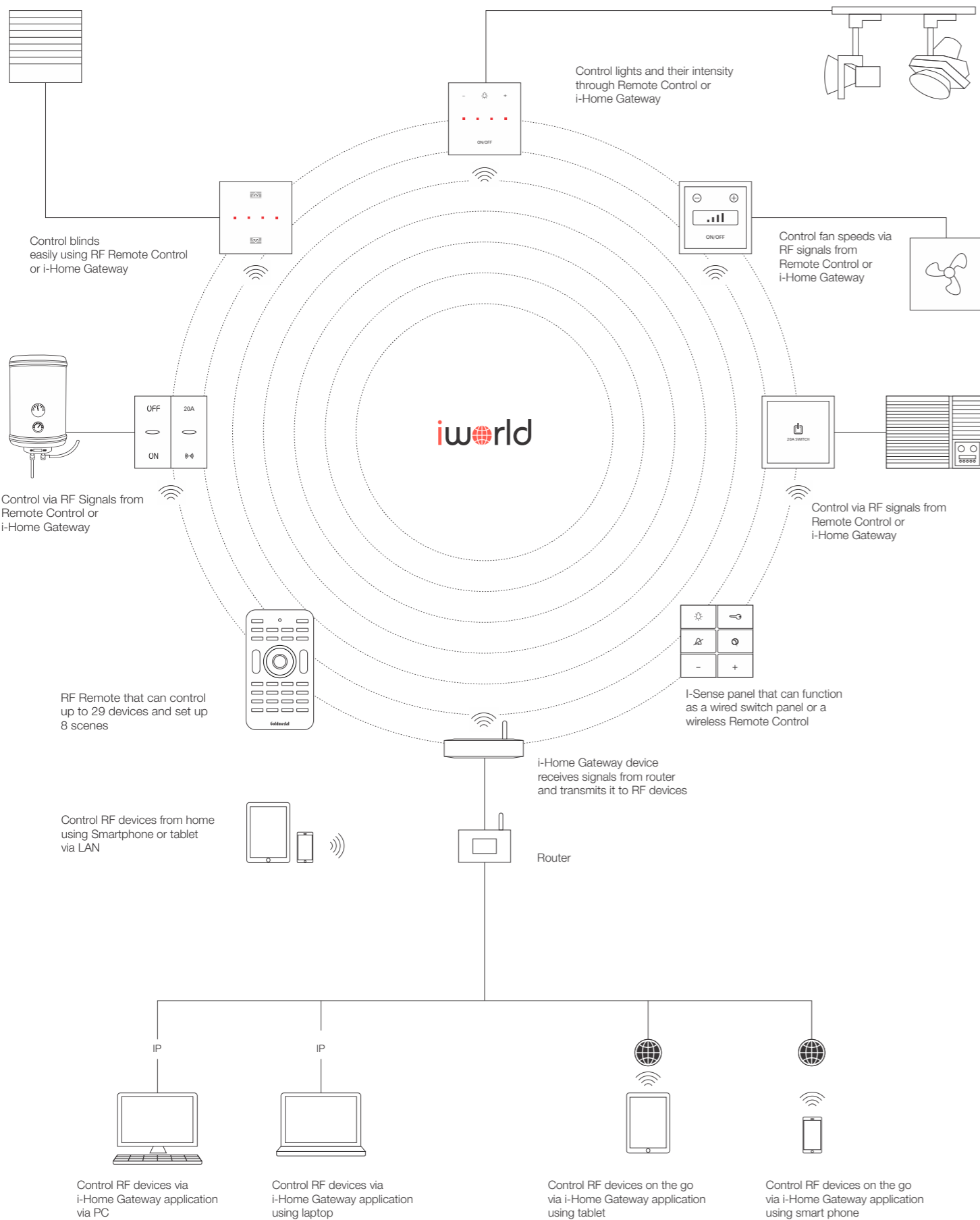

RF i-TOUCH / RF i-FEEL / RF TOUCH SYSTEMS

Installing i-Touch, i-Feel or Touch Switches does not require any drilling or any additional wiring. Simply plug them into your existing wiring. All i-Touch, i-Feel & Touch devices are designed with Switched Mode Power Supply (SMPS) for improved reliability, over current and over voltage protection. (For specific installation and technical details, please refer to the technical sheet provided within the product packaging). In case you need to upgrade, these electronic Touch devices can easily replace your existing Curve / Nixon modular switches.

RF I-Touch 4 Switch + Master Switch (Wiring Diagram)

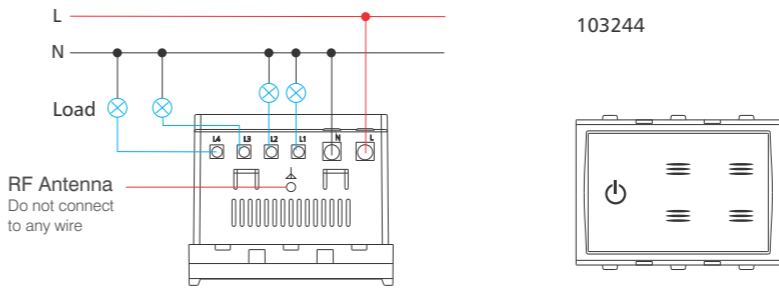

- Technical Specifications**
- Rated Voltage: 160-240V~ 50-60Hz
 - Rated Load per Switch :
 - a) Capacitive Load - CFL & LED (PF>0.8) : 100W
 - b) Resistive Load - Incandescent & Halogen Lights: 1000 W
 - c) Inductive Load - Fan and Motor : 800W
 - Service Life: 50,000 Operations

RF I-Touch 2 Switch + Fan Regulator (Wiring Diagram)

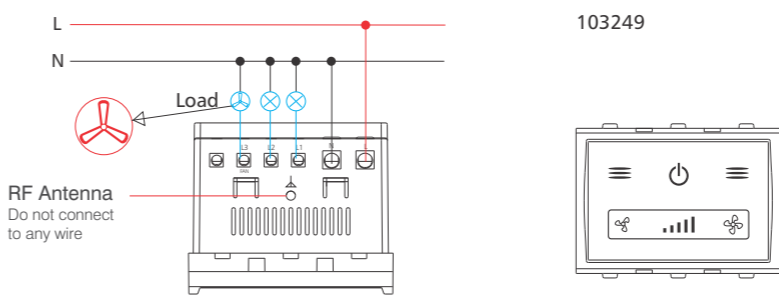

- Technical Specifications**
- Rated Voltage: 160-240V~ 50Hz
 - Rated Load per switch:
 - a) Capacitive Load - CFL & LED (PF>0.8) : 100W
 - b) Resistive Load - Incandescent & Halogen Lights: 1000 W
 - c) Inductive Load - Fan and Motor - 800 W
 - Rated Load: Fan Regulator - Max 100 W
 - 5-Level Speed Selection with Indicator
 - Service Life: 50,000 Operations

RF Touch Switch (Wiring Diagram)

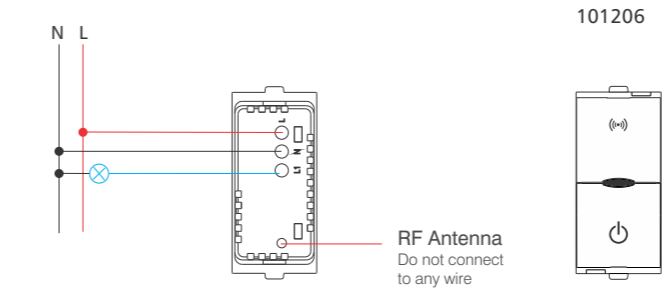

- Technical Specifications**
- Rated Voltage: 160-240V~ 50-60Hz
 - Rated Load:
 - a) Capacitive Load - CFL & LED (PF>0.8) : 100W
 - b) Resistive Load - Incandescent & Halogen Lights: 1000 W
 - c) Inductive Load - Fan and Motor : 800W
 - Service Life: 50,000 Operations

RF Touch Fan Regulator (Wiring Diagram)

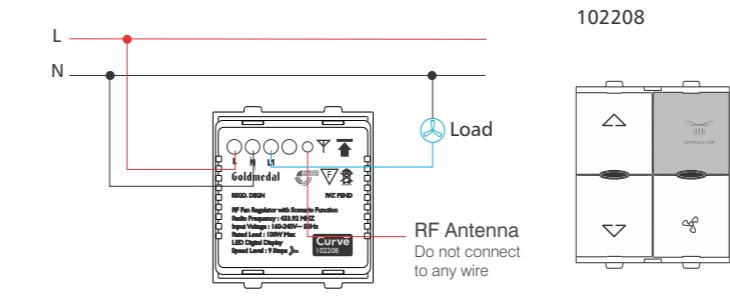

- Technical Specifications**
- Rated Voltage: 160-240V~ 50Hz
 - Rated Load: Max 100 W.
 - 9 Level Speed Selection
 - 7 Segment Digital Display for Indicating Speed Level of the Fan.
 - Service Life: 50,000 Operations

Wire colour codes: ■ Red (live),
■ Black (neutral),
■ Blue (load).



Code	Item	MRP ₹	Pkg.
Outer/Master			
GALAXY RGB LED SPEAKER			
101311	Galaxy RGB LED Speaker Load rating: 25W Impedance: 8 ohms - Toughened glass for maximum safety - Amplifier supplied separately - Supplied with wireless RGB LED Controller - Supplied with touch RF remote.	10399.00	1/1
2 CHANNEL AMPLIFIER			
101320	2 Channel Amplifier Power supply 110-240V~ Amplifier type BTL (class D) Output power max RL=4 ohms 35W per channel Treble (@20KHz) +- 12 db Bass (@40Hz) +- 12 db Frequency (-3 db) 25Hz-20KHz	4999.00	5/50
GIFA AUDIO HUB			
GTX 501	Audio Hub (Wireless docking station + LED Lamp Speaker) - Charging and Playback iPod models and iPhone - Plays MP3/WMA music through USB/SD/MMC card - Composite video out for iPod and iPhone - Aux in jack for Mp3 playback - DC-in Jack with AC/DC adaptor included - Docking station for iPod and iPhone - 2.4GHz wireless transmission - 85 white LED light - Back house with standard lamp E27 screw - 2.25" x 1 full range speaker - Control up to 8 group wireless devices (Supplied with wireless LED lamp speaker GRX 501)	11599.00	5/50
GIFA AUDIO LIGHT			
GRX 501	Audio Light (Wireless LED Lamp Speaker) Music power: 20W Lighting power: 5W 2.25" x 1 full range speaker Digital Amplifier - 2.4GHz wireless transmission - 85 white LED light burns upto 30,000 hrs. - Back house with standard lamp E27 connector - Semi transparent cover with metal grill - Can be paired upto 8 group wireless devices (Combine with GIFA Wireless docking GTX 501)	5999.00	5/50

Code	Item	MRP ₹	Pkg.
Outer/Master			
KBSOUND® DOCK			
KB 50902	KBSOUND DOCK Wireless accessories for use with KBSOUND SPACE and KBSOUND iSELECT kit. Contents: Dock (52591), Wireless Module (52592), RF Antenna and 5V power supply with interchangeable plugs for different countries (When integrated with KBSOUND iSELECT you can enjoy the radio or listen to the music from your iPod, iPhone or additional sound source using a 3.5mm jack)	9999.00	5/50
KBSOUND® SPACE			
KB 50398	KBSOUND SPACE An open-ended model that allows you to freely choose your loudspeaker and amplifier to fulfil your specific design requirement. Contents: REMOTE CONTROL - IR Remote control with display screen that shows RDS information and iPod/iPhone playing list. - Keypad to access different sound sources such as FM, iPod, Audio IN and DAB. - Allows you to control the volume, bass and treble levels, together with scanning and storing stations in the memory. ELECTRONIC MODULE (52398) - Designed to incorporate the radio frequency device that permits integration with the KBSOUND DOCK. - Includes an improved antenna (RF) connector for better FM reception. IR RECEIVER / TRANSMITTER - A separate IR bi-directional receiver/transmitter to communicate with the remote.	11800.00	5/50
KBSOUND® iSELECT KIT			
KB 50302	KBSOUND iSELECT (KIT) A perfect sound system that allows you to hear FM radio and music from iPod/iPhone or 3.5mm Line IN when integrated with KBSOUND DOCK. Contents: REMOTE CONTROL - IR Remote control with display screen that shows RDS information. - Keypad to access different sound sources such as FM, iPod, Audio IN and DAB. (when integrated with KBSOUND DOCK) - Allows you to control the volume, bass and treble levels, together with scanning and storing stations in the memory. ELECTRONIC MODULE (52391) - Designed to incorporate any radio frequency device that permits integration with the KBSOUND DOCK. - Includes an improved antenna (RF) connector for better FM reception. TWO 2.5" LOUDSPEAKER - 1.5W+1.5W stereo output - IR reciver/transmitter built-in to loudspeaker grille ANTENNA WIRE (76cm) PARALLEL LOUDSPEAKER CABLING (10M)	10999.00	5/50
* Introducing shortly			





Bella White Jazz Plate with Curve White Jazz Switches

bella

You are mesmerized by the smile of a newborn; you wonder at the precision of a perfectly drawn line. Part dreamer, part realist, you synchronize your lifestyle with the demands of your heart and mind. You'll find an expression of this rare combination in the bella range of cover panels. Choose from the natural opulence of Bellewood panels, the elegant simplicity of White Jazz, the passion and energy of Metalik, the exuberance of Antik, or the soft-to-touch feel of Bellesoft. The options on offer are simply a myriad.

Bella Spirit Gold Plate with Nixon Titanium Grey Switches



BELLA COVER PLATES WITH MOUNTING FRAMES

PLATES →	1M	2M	3M	3M*	4M	6M	7M*	8M(H)	8M*	8M (V)	8M(V)**	12M	16M	18M
COLOURS ↓	MRP ₹	MRP ₹	MRP ₹	MRP ₹	MRP ₹	MRP ₹	MRP ₹	MRP ₹	MRP ₹	MRP ₹	MRP ₹	MRP ₹	MRP ₹	MRP ₹
White Jazz	96.00	96.00	119.00	119.00	138.00	186.00	227.00	235.00	273.00	235.00	235.00	293.00	322.00	381.00
Metalik	123.00	123.00	159.00	159.00	179.00	235.00	301.00	307.00	342.00	307.00	307.00	386.00	390.00	425.00
Belle Soft	133.00	133.00	174.00	174.00	204.00	263.00	332.00	336.00	373.00	336.00	336.00	425.00	435.00	466.00
Antik	161.00	161.00	201.00	201.00	234.00	311.00	412.00	419.00	457.00	419.00	419.00	469.00	538.00	594.00
Belle Wood	161.00	161.00	201.00	201.00	234.00	311.00	412.00	419.00	457.00	419.00	419.00	469.00	538.00	594.00
CODE →	30101	30201	30301	33301	30401	30601	30701	30801	32801	38801	39801	31201	31601	31801
Outer/Master →	10/400	10/400	10/300	10/300	10/300	5/150	5/150	5/150	5/150	5/150	5/150	5/120	5/90	5/80
SIZE(mm) →	93x86	93x86	119x86	125x86	151x86	219x86	219x86	268x86	246x86	154x155	152x168	220x155	268x155	225x224

COVER PLATES

* Without Partition **8 Module Vertical Big Size

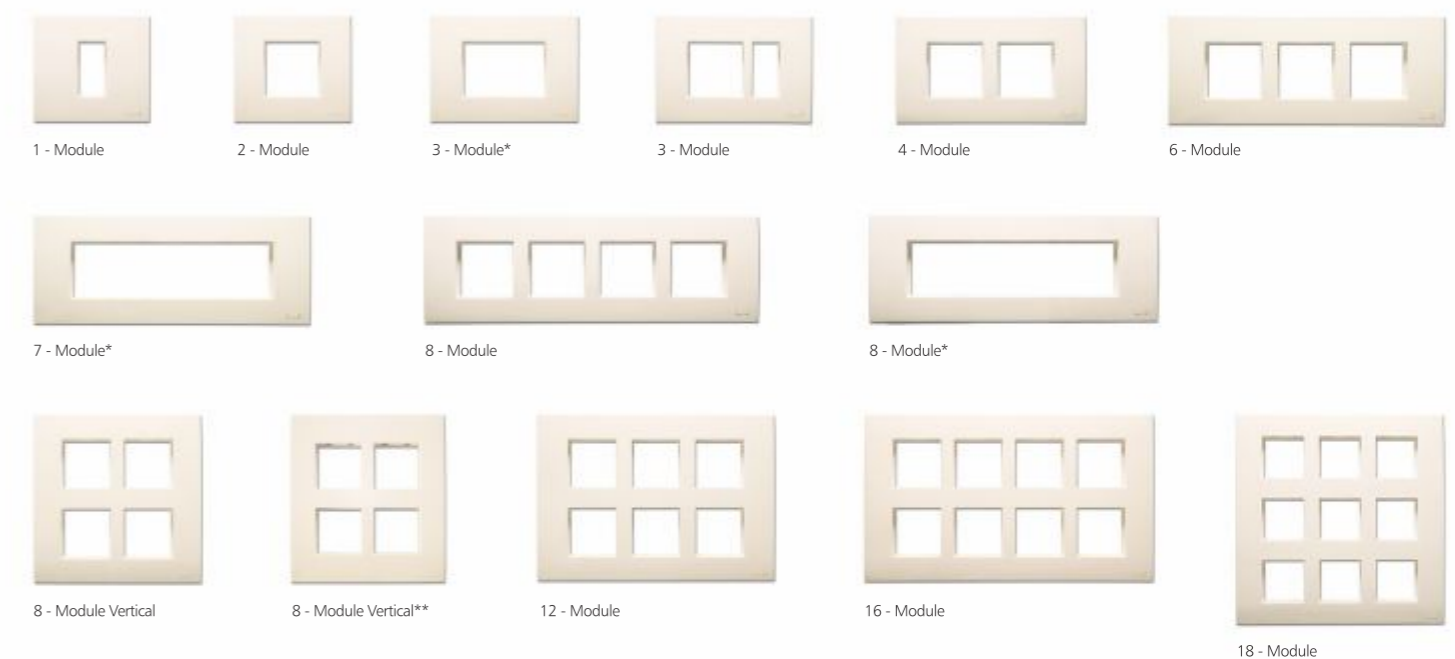

MOUNTING FRAMES - Horizontal & Vertical Distance for Screwing (Dimensions in mm)

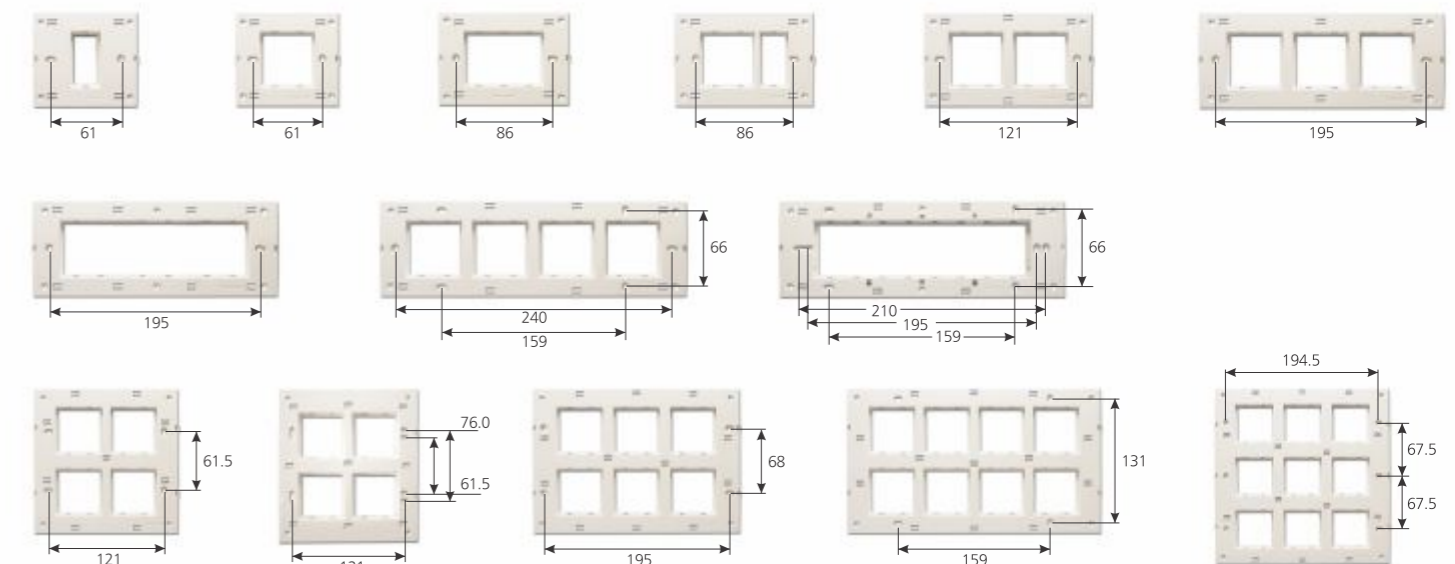

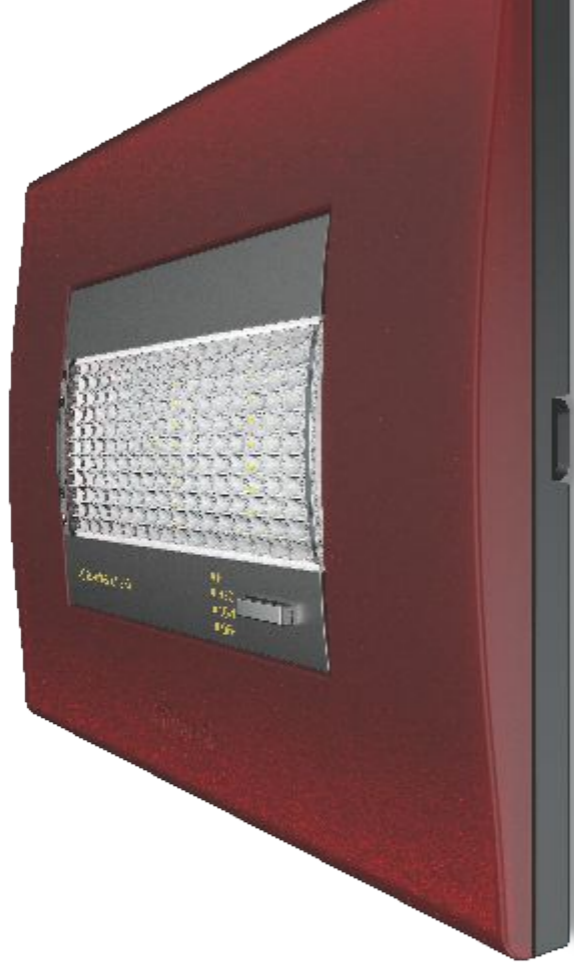

Cristallo Valentine Wine Plate with Curve Voltage Grey Emergency Light

Cristallo

With Curve Cristallo, you can create style statements that echo your true self. Choose the clear, transparent Memorio panels to showcase your memories from the past. Select the specially crafted Twixos panels with two-tone colours to lend a distinct verve to your interiors. Or opt for the Illumino panels that emit a soft, gentle glow that inspires as well as guides you in total darkness.... Whichever your choice, the Cristallo range doesn't just allow you to express yourself more clearly, it sets trends for the rest to follow.

Cristallo Herbal Spa Plate with Curve Digital Chrome Switches



CRISTALLO COVER PLATES WITH MOUNTING FRAMES

PLATES →	1M	2M	3M	3M*	4M	6M	8M (H)	8M*	8M (V)	12M	16M	18M
COLOURS ↓	MRP ₹	MRP ₹	MRP ₹	MRP ₹	MRP ₹	MRP ₹	MRP ₹	MRP ₹	MRP ₹	MRP ₹	MRP ₹	MRP ₹
White Jazz	86.00	86.00	108.00	108.00	122.00	165.00	211.00	240.00	211.00	267.00	295.00	339.00
Memorio	198.00	198.00	239.00	239.00	288.00	368.00	501.00	501.00	501.00	551.00	662.00	755.00
Twixos/Metalik	170.00	170.00	220.00	220.00	253.00	311.00	376.00	376.00	376.00	459.00	512.00	587.00
Wood	200.00	200.00	260.00	260.00	304.00	357.00	441.00	441.00	441.00	538.00	597.00	669.00
CODE →	40101	40201	40301	43301	40401	40601	40801	42801	48801	41201	41601	41801
Outer/Master →	10/300	10/300	10/200	10/200	10/200	5/120	5/120	5/120	5/100	5/80	5/40	5/40
SIZE(mm) →	92x86	92x86	115x86	122x86	150x86	222x86	264x86	248x86	150x151	222x151	264x151	223x217

COVER PLATES

* Without Partition

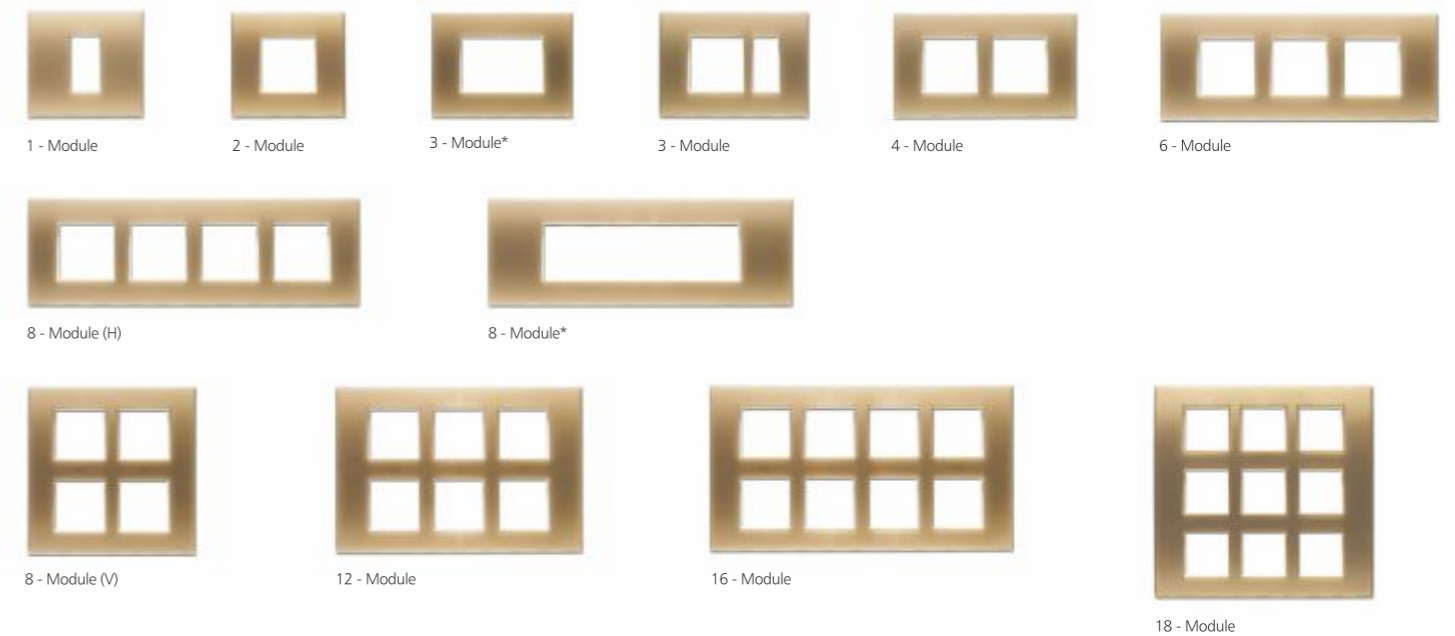

CRISTALLO MOUNTING FRAMES - Horizontal & Vertical Distance for Screwing (Dimensions in mm)

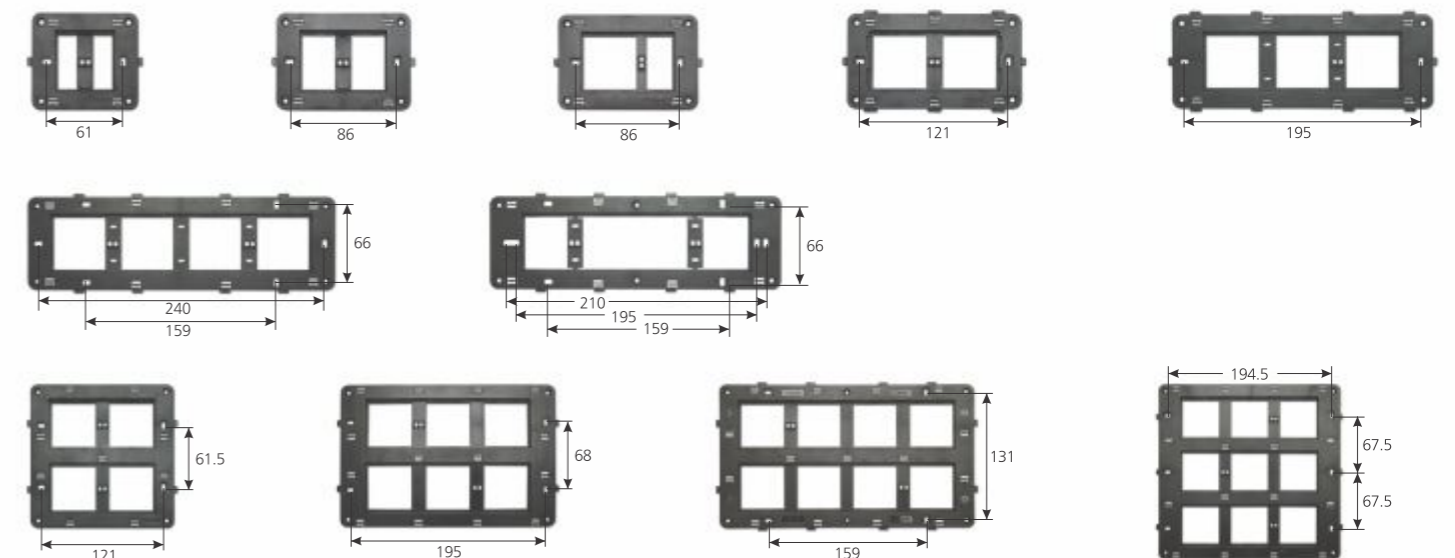



Crystallight Honey Mint Plate with Nixon Titanium Grey Gas Detector

QUORRA

The Crystallight cover frames are precisely crafted for that perfect finish – right from their delicately frosted facade to the exquisite chamfer around the edges. Like naturally occurring crystals, the Crystallight cover plate exhibits a rare brilliance that creates an aura of sophisticated elegance around it. Unmatched in their beauty and finish, these cover plates are without doubt, the definitive symbol of luxury on your walls.

Crystallight Grey Ghost Plate with Nixon Titanium Grey Switches



Crystallight

QUORRA BASIC COVER PLATES

PLATES	1M	2M	3M	4M	4M*	6M	6M*	8M (H)*	8M	8M*	8M (V)	12M	18M
					(H&V)**		(H&V)**			(H&V)**			
COLOURS	MRP ₹	MRP ₹	MRP ₹	MRP ₹	MRP ₹	MRP ₹	MRP ₹	MRP ₹	MRP ₹	MRP ₹	MRP ₹	MRP ₹	MRP ₹
Satin White	-	124.00	157.00	194.00	-	251.00	-	301.00	301.00	-	301.00	381.00	532.00
Metallic	-	205.00	227.00	266.00	-	320.00	-	387.00	387.00	-	387.00	534.00	654.00
Wood	-	240.00	266.00	333.00	-	387.00	-	480.00	480.00	-	480.00	654.00	867.00
Outer/Master		10/400	10/300	10/300	-	5/150	-	5/150	5/150	-	5/150	5/120	5/80

QUORRA EXCLUSIVE COVER PLATES

Glass	-	411.00	594.00	788.00	-	1110.00	-	1208.00	1208.00	-	1208.00	1458.00	1785.00
SIZE(mm)		101x87	124x87	148x87	-	222x87	-	271x87	248x87	-	148x154	222x154	222x220

QUORRA PREMIUM COVER PLATES

Glass	528.00	528.00	747.00	985.00	1082.00	1338.00	1459.00	-	1509.00	1642.00	1509.00	1785.00	2166.00
CODE	50101	50201	53301	50401	50403	50601	50603	50801	52801	50803	58801	51201	51801
Outer/Master	10/200	10/200	10/200	10/150	10/150	5/100	5/100		5/100	5/100	5/100	5/75	5/40
SIZE(mm)	106x91	106x91	128x91	152x91	152x91	226x91	226x91	-	251x91	269x91	152x157	226x157	226x224

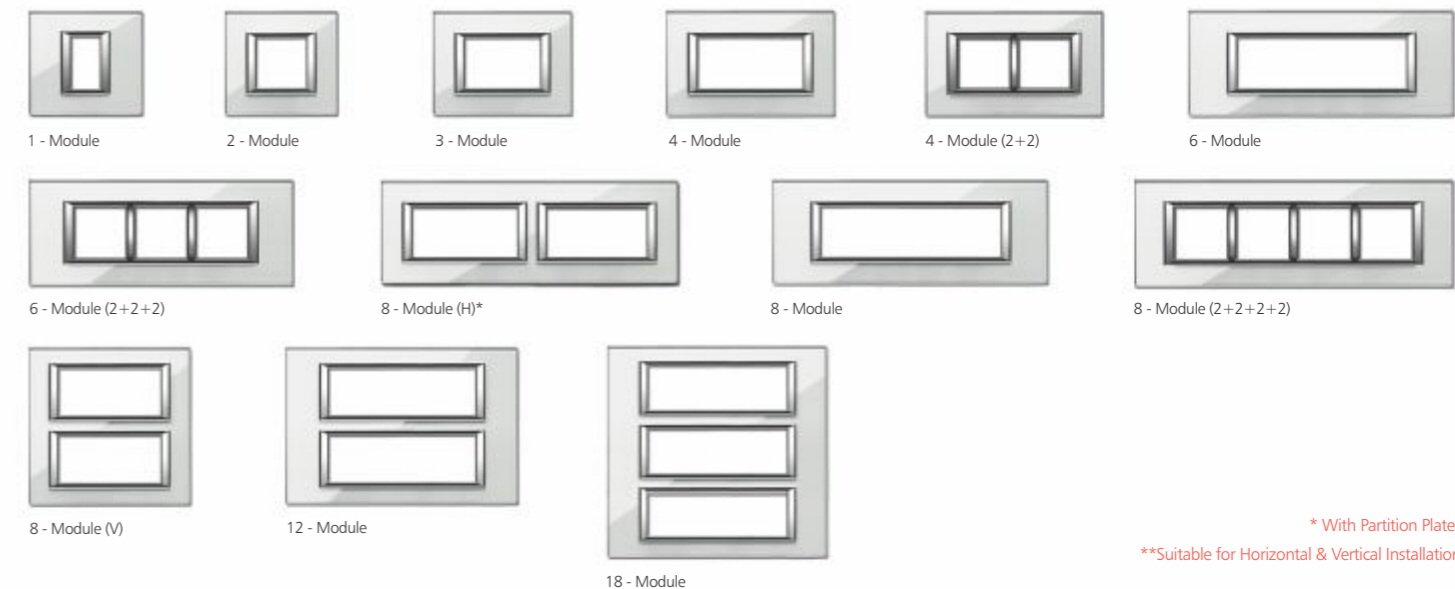

* With Partition Plates
**Suitable for Horizontal & Vertical Installation

QUORRA MOUNTING FRAME - Horizontal & Vertical Distance for Screwing (Dimensions in mm)

Quorra Frame	2M	3M	4M	4M	6M	6M	8M (H)*	8M	8M	8M (V)	12M	18M
				(H&V)**		(H&V)**			(H&V)**			
MRP ₹	61.00	74.00	86.00	91.00	125.00	136.00	156.00	156.00	170.00	156.00	200.00	271.00
CODE	50202	53302	50402	50404	50602	50604	50802	52802	50804	58802	51202	51802
Outer/Master	25/750	25/750	25/500	25/500	20/240	20/240	20/240	20/240	20/240	20/240	20/160	10/80

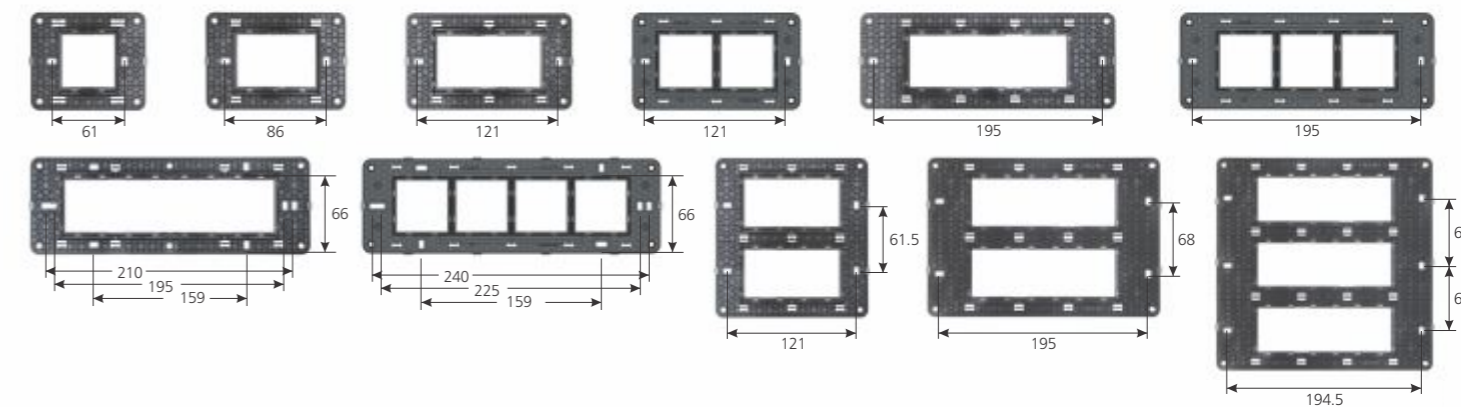



Xtreme Brushed Silver Plate with Nixon Titanium Grey Step Marker

QUORRA

Fashioned from wood, glass, metal, chrome, stone and wool, the Quorra Xtreme cover frames are distinguished by their sleek chrome encasing. Visible from the sides as well as the front, the chrome border creates an aura of luxury and sophistication around the frames. While the Quorra Xtreme is superlative in every respect, the Quorra Xtreme is the epitome of flawless grandeur; diamond cut and polished to perfection. Painstakingly crafted, Quorra cover frames symbolizes the absolute pinnacle of luxurious living.

Xtreme Brushed Silver Plate with 3M Bluetooth FM Player



XTREME

QUORRA CRYSTALLIGHT / DIAMOND COVER PLATES												
PLATES →	1M	2M	3M	4M	4M*	6M	6M*	8M	8M*	8M (V)	12M	18M
					(H&V)**		(H&V)**		(H&V)**			
COLOURS ↓	MRP ₹	MRP ₹	MRP ₹	MRP ₹	MRP ₹	MRP ₹	MRP ₹	MRP ₹	MRP ₹	MRP ₹	MRP ₹	MRP ₹
Glass (diamond cut)	596.00	596.00	840.00	1106.00	1216.00	1594.00	1677.00	1791.00	1848.00	1791.00	2011.00	2465.00
Diamond (studded)	-	-	4896.00	-	-	-	-	-	-	-	-	-

QUORRA XTREME COVER PLATES												
	Wood	Steel	Aluminum	CODE →	Outer/Master →	SIZE(mm) →						
	498.00	600.00	600.00	50101	10/200	106x91	498.00	600.00	600.00	50201	10/200	106x91
	714.00	855.00	855.00	53301	10/200	128x91	714.00	855.00	855.00	50401	10/150	152x91
	943.00	1136.00	1136.00	50401	10/150	152x91	1040.00	1250.00	1250.00	50403	10/150	152x91
	1341.00	1608.00	1608.00	50601	5/100	226x91	1341.00	1448.00	1448.00	50603	5/100	226x91
	1535.00	1854.00	1854.00	52801	5/100	251x91	1535.00	1602.00	1602.00	50803	5/100	269x91
	1602.00	1854.00	1854.00	58801	5/100	152x157	1535.00	1602.00	1602.00	58801	5/100	152x157
	1761.00	2105.00	2105.00	51201	5/75	226x157	1761.00	2105.00	2105.00	51201	5/75	226x157
	2156.00	2591.00	2591.00	51801	5/40	226x224	2156.00	2591.00	2591.00	51801	5/40	226x224

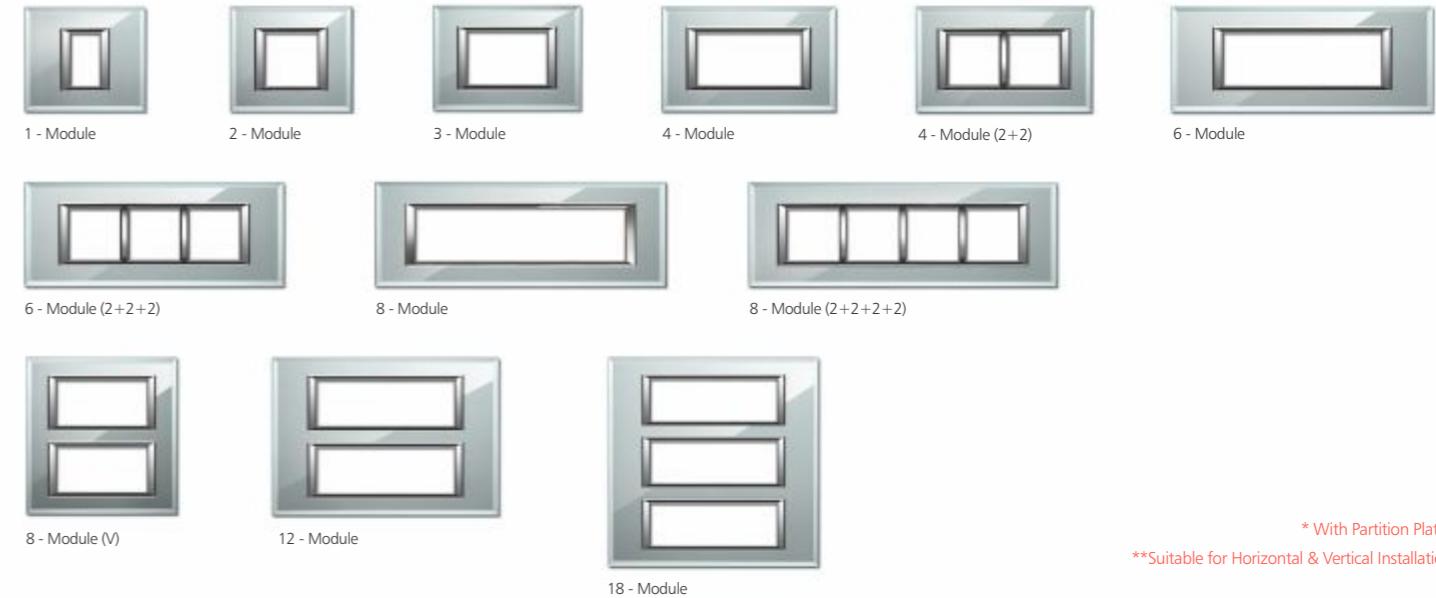

* With Partition Plates
**Suitable for Horizontal & Vertical Installation

QUORRA XTREME COVER PLATES												
1 - Module	2 - Module	3 - Module	4 - Module	4 - Module (2+2)	6 - Module	6 - Module (2+2+2)	8 - Module	8 - Module (2+2+2+2)	8 - Module (V)	12 - Module	18 - Module	



Grazia Basic Moughal Teak Plate with Nixon Digital Silver Switches

grazia

Grazia, the thinnest, most stylish cover frames you can imagine, are available in Basic and Premium options. Both Basic and Premium cover frames accentuate the style quotient of your rooms with their distinctively slender appearance. The Grazia Premium has an additional chrome side casing which highlights the delightful slimness of these cover frames. Choose from either of these options to make a style statement that will always be in.

Grazia Premium Italian Espresso Plate with Digital Silver Key Tag



GRAZIA BASIC COVER PLATES WITH MOUNTING FRAMES

PLATES →	1M	2M	3M	3M*	4M	4M*	6M	6M*	8M	8M*	8M	9M*	12M	12M*	12M*	16M	18M
						(H&V)**		(H&V)**		(H&V)**	(V)				(H&V)**		
COLOURS ↓	MRP ₹	MRP ₹	MRP ₹	MRP ₹	MRP ₹	MRP ₹	MRP ₹	MRP ₹	MRP ₹	MRP ₹	MRP ₹	MRP ₹	MRP ₹	MRP ₹	MRP ₹	MRP ₹	MRP ₹
Pure Glossy	103.00	103.00	127.00	127.00	158.00	158.00	224.00	224.00	281.00	281.00	281.00	301.00	322.00	322.00	322.00	356.00	407.00
Metallic	149.00	149.00	193.00	193.00	235.00	235.00	323.00	323.00	404.00	404.00	404.00	433.00	473.00	473.00	473.00	518.00	523.00
Wood	199.00	199.00	270.00	270.00	330.00	330.00	450.00	450.00	615.00	615.00	615.00	619.00	631.00	631.00	631.00	692.00	735.00

GRAZIA PREMIUM COVER PLATES WITH MOUNTING FRAMES

Pure Glossy	121.00	121.00	149.00	149.00	181.00	181.00	260.00	260.00	330.00	330.00	330.00	353.00	377.00	377.00	377.00	424.00	481.00
CODE →	60101	60201	60301	60303	60401	60404	60601	60604	60801	60804	68801	60901	61201	61204	61207	61601	61801
Outer/Master	10/400	10/400	10/300	10/300	10/300	10/300	5/150	5/150	5/150	5/150	5/150	5/150	5/120	5/120	5/120	5/90	5/80
SIZE(mm) →	101x93	101x93	124x93	124x93	148x93	154x93	221x93	226x93	247x93	280x93	148x159	280x93	222x160	226x160	226x160	246x159	222x226

* With Partition Plates **Suitable for Horizontal & Vertical Installation

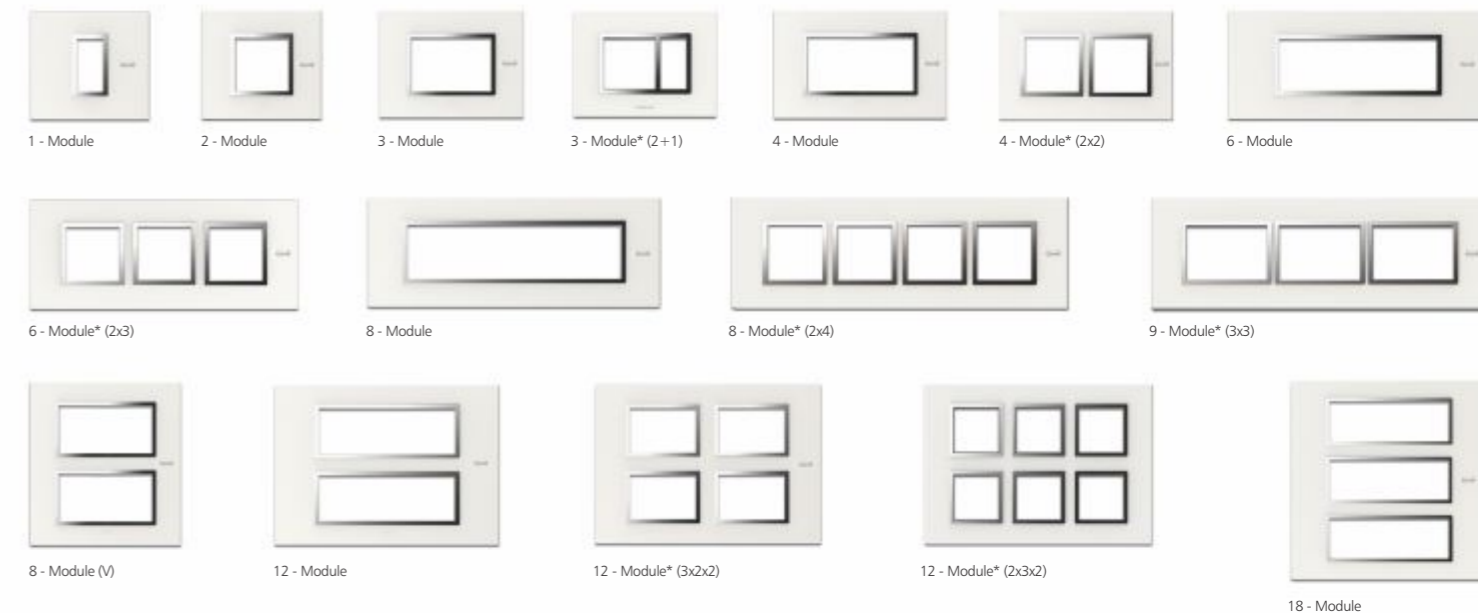

GRAZIA MOUNTING FRAMES - Horizontal & Vertical Distance for Screwing [Dimensions in mm]

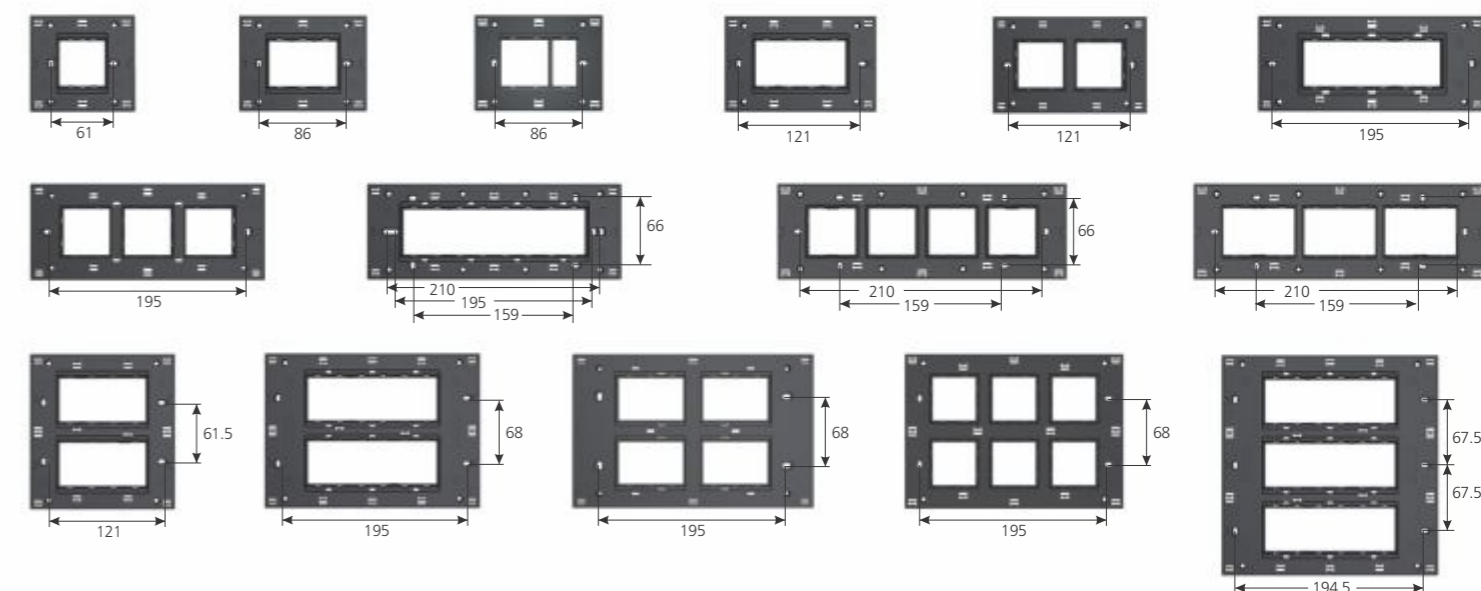



Classio Black Glossy Plate with Digital Silver I-touch Bellpush

GLASSIO

The Glassio is without doubt a classical beauty – exhibiting a smooth, glossy frontage, with soft, rounded edges and a demeanour that's sophisticated yet warm and welcoming. The elegantly flared corners reflect and absorb light in a manner that adds depth and character to the cover plate. This interplay of light and shadow also creates a sinuous effect that makes Glassio the definitive artefact on your wall.

Classio Black Glossy Plate with Digital Silver RF I-touch Switches



GLASSIO COVER PLATES WITH MOUNTING FRAMES

PLATES →	1M	2M	3M	4M	4M*	6M	6M*	8M	8M*	8M	9M*	12M	12M*	16M*	18M
					(H&V)**		(H&V)**		(H&V)**	(V)			(H&V)**		
COLOURS ↓	MRP ₹	MRP ₹	MRP ₹	MRP ₹	MRP ₹	MRP ₹	MRP ₹	MRP ₹	MRP ₹	MRP ₹	MRP ₹	MRP ₹	MRP ₹	MRP ₹	MRP ₹
Pure Glossy	121.00	121.00	149.00	181.00	181.00	260.00	260.00	330.00	330.00	330.00	353.00	377.00	377.00	424.00	481.00
Metallic	163.00	163.00	213.00	260.00	260.00	355.00	355.00	445.00	445.00	445.00	480.00	522.00	522.00	586.00	626.00
Metal Krome	244.00	244.00	340.00	413.00	413.00	554.00	554.00	744.00	744.00	744.00	758.00	765.00	765.00	839.00	886.00
VelvetTouch	238.00	238.00	324.00	400.00	400.00	534.00	534.00	730.00	730.00	730.00	740.00	747.00	747.00	820.00	870.00
Wood	218.00	218.00	296.00	362.00	362.00	494.00	494.00	678.00	678.00	678.00	688.00	693.00	693.00	768.00	810.00
CODE →	120101	120201	120301	120401	120404	120601	120604	120801	120804	128801	120901	121201	121204	121601	121801
Outer/Master →	10/500	10/500	10/400	10/400	10/400	5/200	5/200	5/200	5/200	5/200	5/200	5/120	5/120	5/90	5/80
SIZE(mm) →	92x90	92x90	120x90	146x90	152x90	219x90	219x90	244x90	264x90	152x168	280x90	219x156	219x156	244x156	219x223

* With Partition Plates **Suitable for Horizontal & Vertical Installation

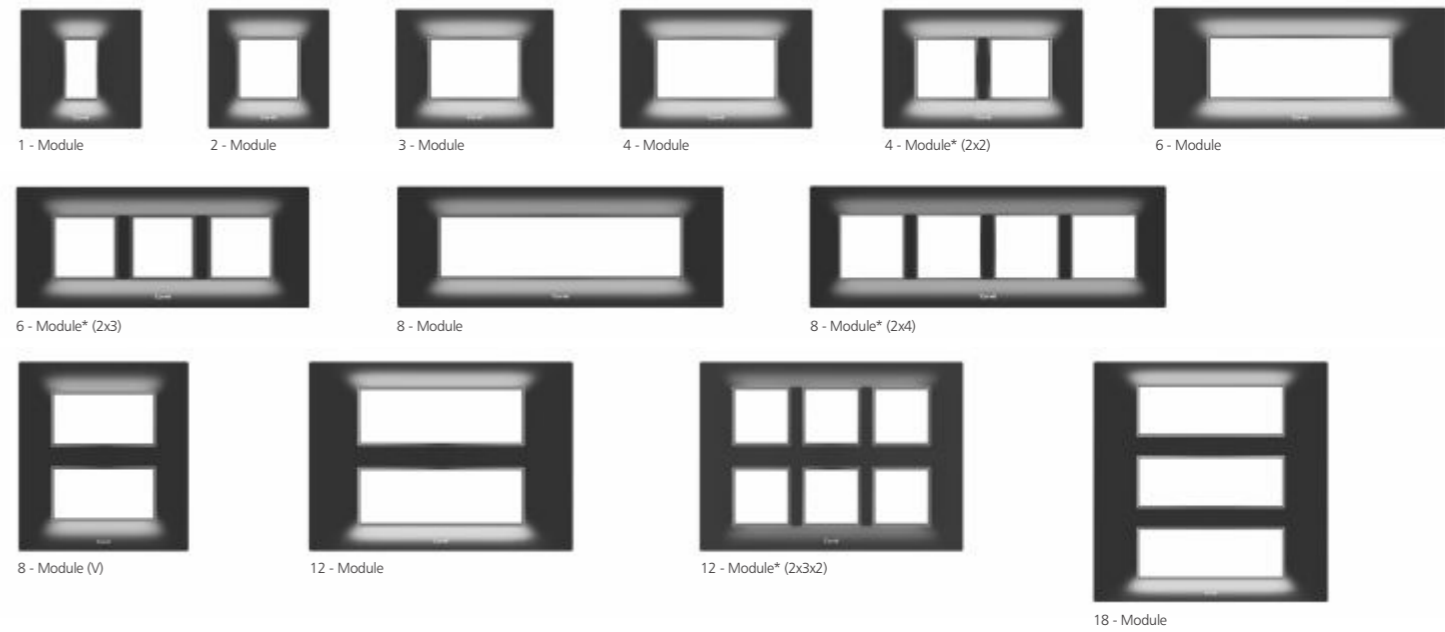

GLASSIO MOUNTING FRAMES - Horizontal & Vertical Distance for Screwing (Dimensions in mm)

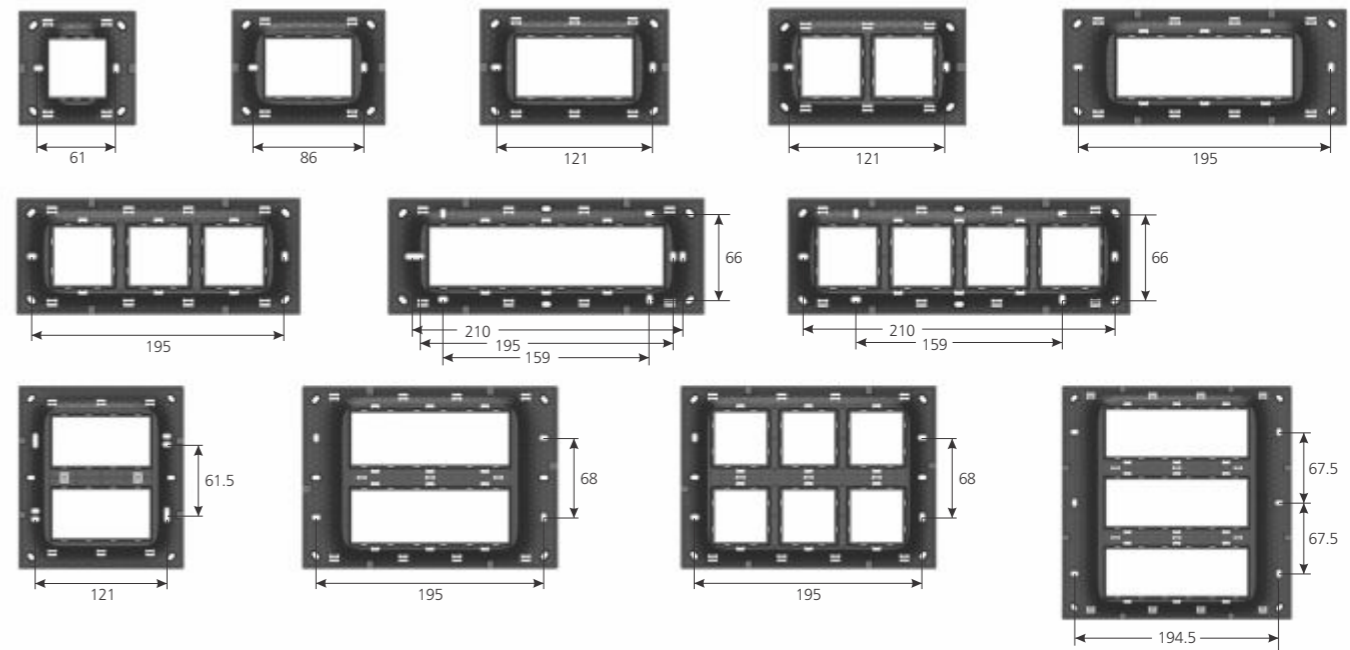



Wega Junglee Wenge Plate with Titanium Grey G-dip Switches

WEGA

Unconventional yet perfectly symmetrical, bold yet elegant - the Wega cover plates are stunning in every way. An example of imagination and engineering precision of the highest order, the Wega, with its distinctive appearance stands out from the clutter with ease. Its undulating shape creates a magical interplay of light that adds to its visual appeal. The colours appear dazzling, mesmerizing and even playful, depending on the prevailing light conditions.

Wega Dark Espresso Plate with Titanium Grey Step Marker



WEGA COVER PLATES WITH MOUNTING FRAMES NEW												
PLATES →	1M	2M	3M	4M	4M	6M	6M*	8M	8M*	8M	12M	18M
					(H&V)**		(H&V)**		(H&V)**	(V)		
COLOURS ↓	MRP ₹	MRP ₹	MRP ₹	MRP ₹	MRP ₹	MRP ₹	MRP ₹	MRP ₹	MRP ₹	MRP ₹	MRP ₹	MRP ₹
Pure Glossy	-	199.00	263.00	318.00	318.00	399.00	379.00	493.00	474.00	493.00	573.00	861.00
Metallic	-	299.00	349.00	424.00	424.00	487.00	467.00	598.00	580.00	598.00	811.00	1036.00
VelvetTouch	-	412.00	474.00	573.00	573.00	673.00	654.00	853.00	835.00	853.00	1121.00	1484.00
Wood	-	343.00	399.00	474.00	474.00	562.00	543.00	711.00	692.00	711.00	936.00	1235.00
CODE →	200101	200201	200301	200401	200403	200601	200603	200801	200803	208801	201201	201801
Outer/Master →	10/400	10/400	10/300	10/300	10/300	5/150	5/150	5/150	5/150	5/150	5/120	5/80
SIZE(mm) →	94x92	94x92	122x92	148x92	154x92	221x92	221x92	246x92	266x92	154x170	221x159	221x225

*With Partition Plates **Suitable for Horizontal & Vertical Installation

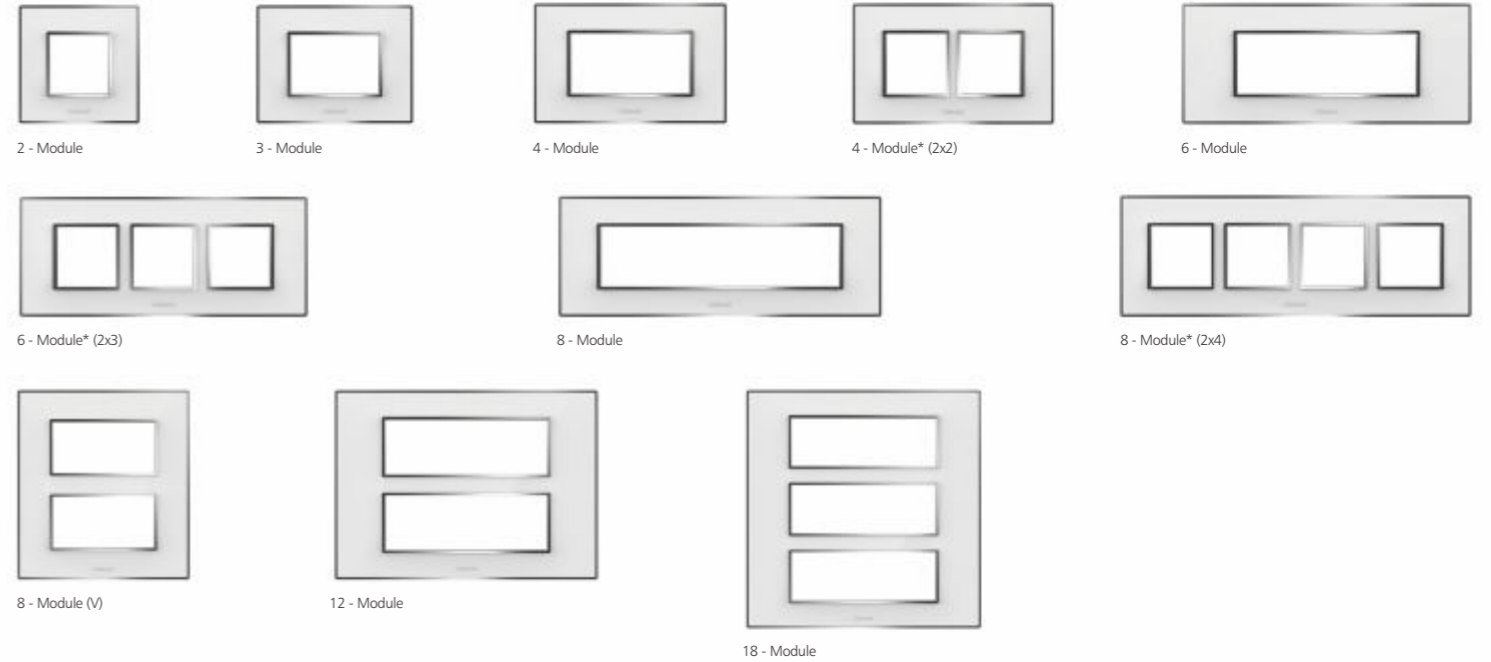

WEGA MOUNTING FRAMES - Horizontal & Vertical Distance for Screwing (Dimensions in mm)

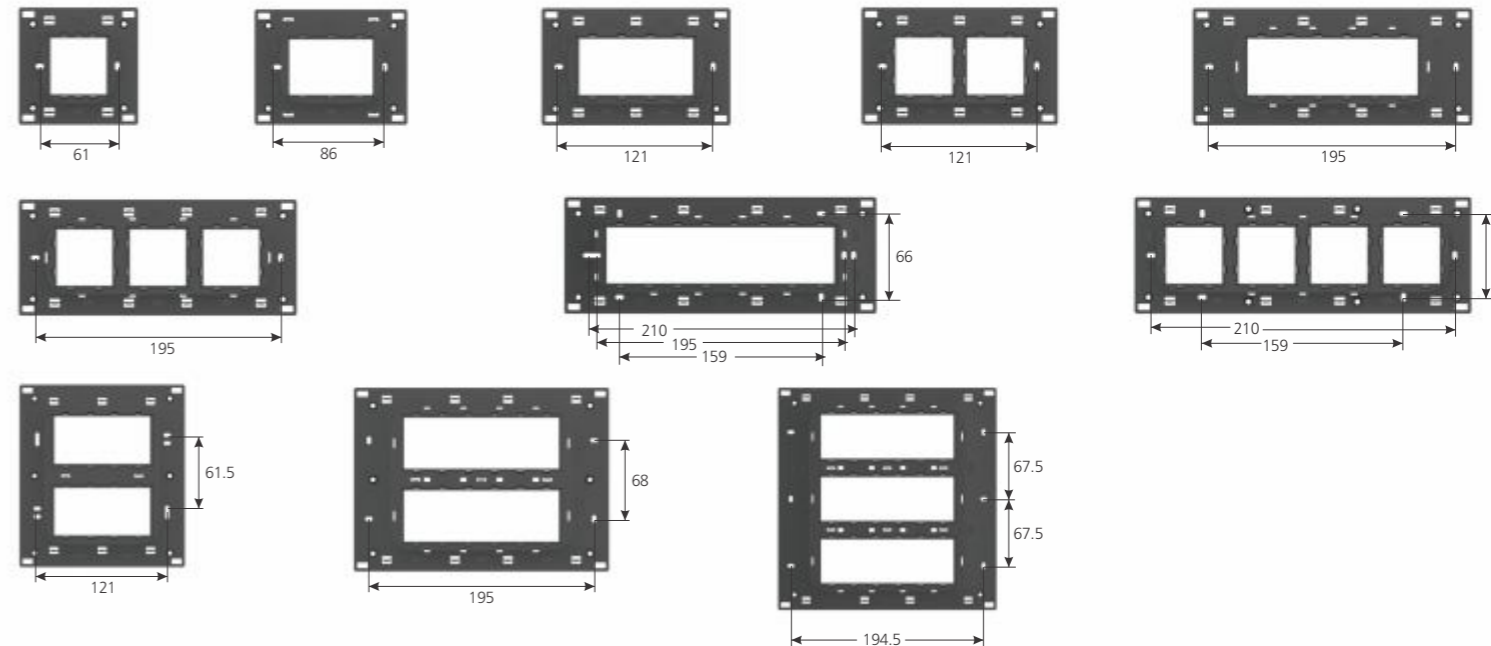

COLOURS OF COVER PLATES

PURE GLOSSY



01 - Absolute White

METALLIC



05 - Champagne Gold



06 - Titanium Silver



07 - Titanium Grey

WOOD



11 - Junglee Wenge



12 - Dark Espresso

Colours shown may not match actual product colours due to printing limitations.

COLOURS OF COVER PLATES

bella

WHITE JAZZ



01 - White Jazz

METALIK



06 - Spirit Gold



07 - Silver Streak



08 - Copper

BELLESOFT



09 - Digital Chrome



16 - Pepper Leaf



17 - Deep Currant



18 - Blu Caspian

ANTI-K



21 - Voltage Grey



31 - Antik Copper

BELLEWOOD



41 - African Wenge



44 - Burma Teak

MEMORIO



01 - Memorio



Barbie

WHITE JAZZ



02 - White Jazz

Cristallo

TWIXOS



12 - Valentine Wine



13 - Herbal Spa



14 - Plum Island



15 - Ice Grey

Metalik



21 - Ocean Pearl



22 - Gold



23 - Silver

Wood



26 - Fumed Oak

Colours shown may not match actual product colours due to printing limitations.

COLOURS OF COVER PLATES

PURE GLOSSY



01 - Absolute White



02 - Black Glossy



03 - Ivory Gold

METALLIC



06 - Gold Mist*



07 - Digital Silver*



08 - Digital Chrome*

METAL KROME



11 - Hyper Chrome



12 - Satin Chrome*



13 - Miami Gold*



14 - Copper Cola*



15 - French Wine*



16 - Toronto Red*



17 - Charcoal Brown*

VELVET TOUCH



21 - Apple Green*



22 - Mexican Peach*



23 - Cherry Red*



24 - Black Grape*

WOOD



31 - Black Walnut



32 - Italian Espresso*



33 - Zebra Wood



34 - Moughal Teak

COLOURS OF COVER PLATES

PURE GLOSSY



01 - Absolute White



02 - Black Glossy*

basic

METALLIC



06 - Gold Mist*



07 - Digital Silver

WOOD



11 - Wild Wenge*



12 - Italian Espresso



13 - Zebra Wood



14 - Moughal Teak*

PURE GLOSSY



20 - Absolute White



21 - Black Glossy*

premium

COLOURS OF COVER PLATES

GLASS



01 - Snow White



02 - Red Wine



03 - Green Ice



04 - Rich Black

EXCLUSIVE

CORIAN®



05 - Hot Red



11 - Glacier White



12 - Lava Grey



13 - Berry Red

BASIC



16 - Satin White

METALLIC



17 - Digital Silver

BASIC WOOD



18 - Fumed Oak

basic

GLASS



21 - Snow White



22 - Red Wine



23 - Green Ice



24 - Rich Black

premium



25 - Hot Red

COLOURS OF COVER PLATES

GLASS



41 - Mint Ice



42 - Honey Sapphire



43 - Black Diamond*



44 - Ruby Red*

Crystallight



45 - Magic Mirror



46 - Honey Mint



47 - Grey Ghost

PLUS



101 - Honey Dew

DIAMOND Crystal Studded



49 - Star Shine*



50 - Night Sky*

Available only in 3 Module

WOOD



56 - Wenge*



57 - Sycamore*



58 - Zebrano*

XTREME

STEEL



81 - Brushed Steel*



82 - Signature Steel*

ALUMINIUM



86 - Brushed Black



87 - Brushed Silver

Divinity



36 - Snow White*



37 - Hot Red*

Available only in 3 Module & 6 Module

FLUSH MOUNTING METAL GANG BOXES (GALVANIZED)									
GANG BOX →	1 & 2M	3M	4M	6M	8M(H)	8M(V)	12M	16M	18M
MRP ₹ ↓	78.00	102.00	127.00	158.00	205.00	205.00	258.00	316.00	362.00
CODE	70201	70302	70403	70604	70805	78806	71207	71608	71809
Outer/Master	10/120	10/120	10/120	5/80	5/80	5/60	5/45	5/40	5/40
SIZE (WxHxL) mm	75x73x51	100x73x51	135x73x51	208x73x51	230x73x51	135x130x60	209x130x60	230x144x60	209x200x60

METAL GANG BOXES



FLUSH MOUNTING PLASTIC GANG BOXES (FIRE RESISTANT)									
GANG BOX →	1 & 2M	3M	4M	6M	8M(H)	8M(V)	12M	16M	18M
MRP ₹ ↓	72.00	83.00	99.00	130.00	156.00	156.00	207.00	243.00	295.00
CODE	80201	80302	80403	80604	80805	88806	81207	81608	81809
Outer/Master	10/120	10/120	10/120	5/80	5/80	5/60	5/45	5/40	5/40
SIZE (WxHxL) mm	79x82x50	104x82x50	139x82x50	213x82x50	263x86x55	141x142x55	213x143x55	249x150x55	214x211x58

PLASTIC GANG BOXES



SURFACE MOUNTING PLASTIC GANG BOXES (FIRE RESISTANT)										
GANG BOX →	1 & 2M	3M	3M	4M	6M	8M(H)	8M(V)	12M	16M	18M
MRP ₹ ↓	71.00	104.00	104.00	111.00	140.00	178.00	178.00	226.00	252.00	300.00
CODE	90201	90302	93303	90404	90605	90806	98807	91208	91609	91810
Outer/Master	10/120	10/120	10/120	10/120	5/80	5/80	5/60	5/45	5/40	5/40
SIZE (WxHxL) mm	92x85x48	124x85x48	118x85x48	150x85x48	218x85x48	267x85x48	153x154x48	219x154x48	267x154x48	224x227x48

PLASTIC SURFACE GANG BOXES

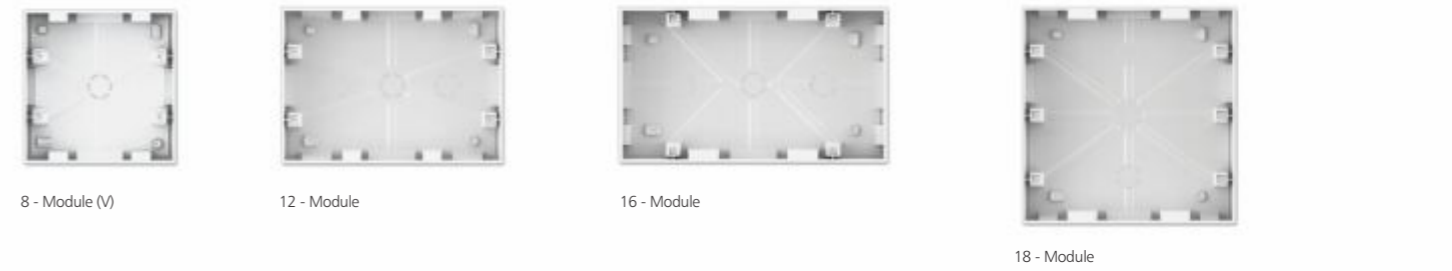

G- SURFACE MOUNTING PLASTIC GANG BOXES (FIRE RESISTANT) Suitable for Grazia & Glassio												
GANG BOX →	1 & 2M	3M	4M	4M (HV)	6M	8M(H)	8M(HV)	8M (V)	9M	12M	16M	18M
MRP ₹ ↓	78.00	118.00	130.00	130.00	164.00	214.00	214.00	214.00	242.00	264.00	306.00	356.00
CODE	100201	100302	100403	100404	100605	100806	100807	108808	100909	101212	101611	101812
Outer/Master	10/120	10/120	10/120	10/120	5/80	5/80	5/80	5/60	5/80	5/45	5/40	5/40
SIZE (WxHxL) mm	91x89x48	119x89x48	145x89x48	150x89x48	218x89x48	243x89x48	263x89x48	154x155x48	279x89x48	218x155x48	243x155x48	218x222x48

PLASTIC SURFACE GANG BOXES

Note: Not suitable for Grazia 8M (V) Plate



Flat. Flawless. Flamboyant.

Aero

Completely flat -
at OFF position

The Aero redefines flat switches. Styled to remain absolutely flush with the cover plate, the Aero emphasizes the minimalistic design of the Air range. Manufactured using the very best in raw materials and processes, the Aero is both functionally and aesthetically a class apart!



Arcos

Add a new dimension to your
interiors



The Arcos switch is the perfect blend of sophistication and minimalism. The subtly contoured body and the arched edges of the Arcos is what sets it apart from its contemporaries. It makes a distinctive style statement while adhering to Goldmedal's vision of crafting extraordinary, timeless, and truly amazing switches.

Artio

Simple, minimalistic and
completely flat -
at OFF position



Inspired by the immaculate perfection of a circle, the new Artio range of switches are beautiful yet minimalistic in appearance. The Artio switch range consists of either completely circular or a combination of straight and semi-circular switches embedded within a square frame. Once installed, these switches form perfectly flat, flawless, circles.

Aura

Perfect crisp lines that define
the Air range



The Aura has a forceful presence that commands attention. With its perfect, crisp lines and distinct shape, the Aura highlights the precision and style that defines the Air range. The Aura is the perfect choice for interiors that are practical yet modern.

Arc

Add a new dimension to your
interiors



The Arc switches by Air symbolizes minimalistic elegance. Easy on the eye as well as a pleasure to use, the Arc can be the perfect accessory in stylish homes with graceful settings. Crafted to perfection using the very best in technology and materials, the Arc adds a new dimension to your interiors.

Distinctly flat, slim and minimal

The AIR range of modular switches and systems breaks the mold with its classy, minimalistic, uniquely flat, and slim appearance. An example of meticulous craftsmanship, careful detailing, and unmatched excellence, the AIR range makes other ordinary switch ranges appear unwieldy and extravagant. Absolutely light and modern, the AIR range marks a new beginning in the world of standard fittings. Slim, stylish, minimal – the AIR devices shout quality, elegance, and finesse through every inch of their presence.

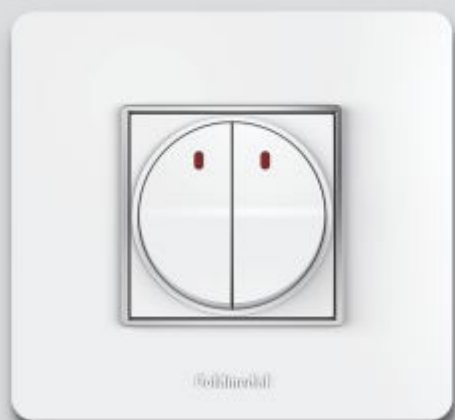

A7 Plate -
Arcos Switches with Indicator



A7 Plate -
Artio Switch with Indicator

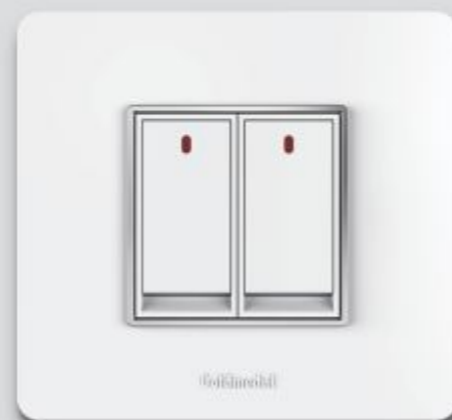

A7 Plate -
Aero Switches with Indicator



A7 Plate -
USB Charger



A7 Plate -
Step Marker

A7 Plate -
i-Push Step Marker



A7 Plate -
Tri-Star 5 Step Regulator

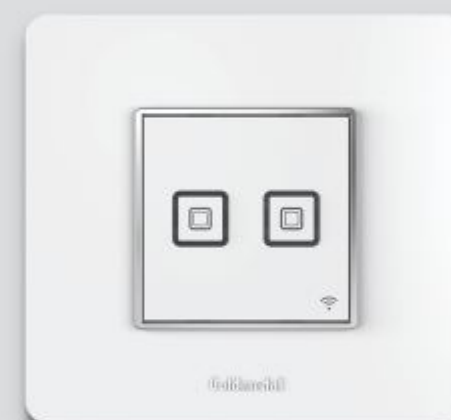

A7 Plate -
Wi-Fi Switches

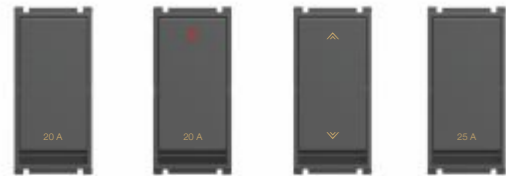
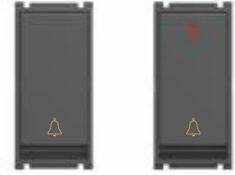

Code	Item	MRP ₹		Pkg.
		Absolute White	Digital Silver Titanium Grey	
AERO 10AX SWITCHES 240V~ (1 Module)				
181001	1 Way Switch	63.00	-	20/600
181002	1 Way Switch with Ind. (LED)	102.00	-	20/600
181003	2 Way Switch	110.00	-	20/600
181004	Bell Push Switch	122.00	-	20/600
181005	Bell Push Switch with Ind. (LED)	138.00	-	20/600

Code	Item	MRP ₹		Pkg.
		Absolute White	Digital Silver Titanium Grey	
AERO 10AX SWITCHES 240V~ (2 Module)				
182010	1 Way Switch	100.00	-	10/300
182011	1 Way Switch with Ind. (LED)	115.00	-	10/300
182012	2 Way Switch	165.00	-	10/300
182014	Bell Push Switch with Ind. (LED)	179.00	-	10/300

Code	Item	MRP ₹		Pkg.
		Absolute White	Digital Silver Titanium Grey	
AERO 20 / 25AMP SWITCHES 240V~ (1 Module)				
181020	20A 1 Way Switch	141.00	-	20/600
181021	20A 1 Way Switch with Ind. (LED)	172.00	-	20/600
181022	20A 2 Way Switch	172.00	-	20/600
181023	25A 1 Way Switch	186.00	-	20/600

Code	Item	MRP ₹		Pkg.
		Absolute White	Digital Silver Titanium Grey	
AERO 20AMP SWITCHES 240V~ (2 Module)				
182025	20A 1 Way Switch	178.00	-	10/300
182026	20A 1 Way Switch with Ind. (LED)	201.00	-	10/300
182027	20A 2 Way Switch	212.00	-	10/300

Code	Item	MRP ₹		Pkg.
		Absolute White	Digital Silver Titanium Grey	
AERO 32AMP DP SWITCH 240V~ (2 Module)				
182031	32A DP Switch with Indicator (LED)	319.00	-	10/300

Code	Item	MRP ₹		Pkg.
		Absolute White	Digital Silver Titanium Grey	
ARC 10AX SWITCHES 240V~ (1 Module)				
181401	1 Way Switch	58.00	63.00	20/600
181402	1 Way Switch with Ind. (LED)	95.00	104.00	20/600
181403	2 Way Switch	103.00	113.00	20/600
181404	Bell Push Switch	112.00	123.00	20/600
181405	Bell Push Switch with Ind. (LED)	127.00	139.00	20/600

Code	Item	MRP ₹		Pkg.
		Absolute White	Digital Silver Titanium Grey	
ARC 10AX SWITCHES 240V~ (2 Module)				
182410	1 Way Switch	87.00	95.00	10/300
182411	1 Way Switch with Ind. (LED)	103.00	113.00	10/300
182412	2 Way Switch	148.00	162.00	10/300
182414	Bell Push Switch with Ind. (LED)	163.00	179.00	10/300

Code	Item	MRP ₹		Pkg.
		Absolute White	Digital Silver Titanium Grey	
ARC 20 / 25AMP SWITCHES 240V~ (1 Module)				
181420	20A 1 Way Switch	128.00	140.00	20/600
181421	20A 1 Way Switch with Ind. (LED)	162.00	178.00	20/600
181422	20A 2 Way Switch	162.00	178.00	20/600
181423	25A 1 Way Switch	177.00	194.00	20/600

Code	Item	MRP ₹		Pkg.
		Absolute White	Digital Silver Titanium Grey	
ARC 20AMP SWITCHES 240V~ (2 Module)				
182425	20A 1 Way Switch	156.00	171.00	10/300
182426	20A 1 Way Switch with Ind. (LED)	178.00	195.00	10/300
182427	20A 2 Way Switch	188.00	206.00	10/300

Code	Item	MRP ₹		Pkg.
		Absolute White	Digital Silver Titanium Grey	
ARC 32AMP DP SWITCH 240V~ (2 Module)				
182431	32A DP Switch with Indicator (LED)	290.00	319.00	10/300

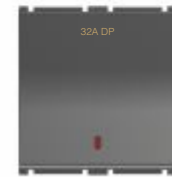
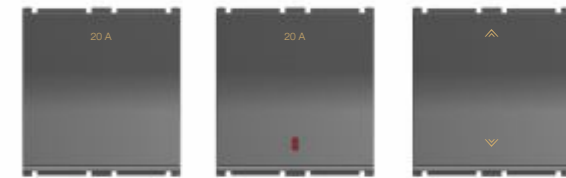
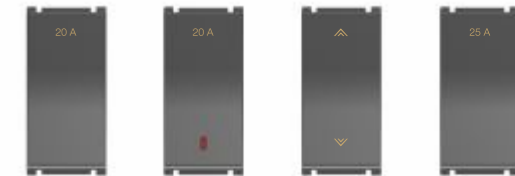
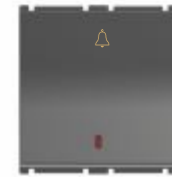
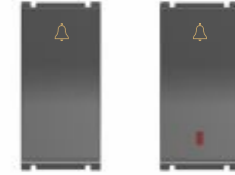
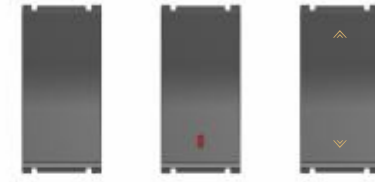

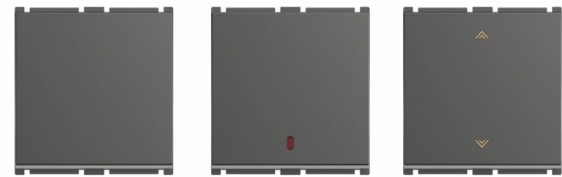

Code	Item	MRP ₹		Pkg.
		Absolute White	Digital Silver Titanium Grey	
AURA 10AX SWITCHES 240V~ (1 Module)				
181501	1 Way Switch	58.00	63.00	20/600
181502	1 Way Switch with Ind. (LED)	95.00	104.00	20/600
181503	2 Way Switch	103.00	113.00	20/600
181504	Bell Push Switch	112.00	123.00	20/600
181505	Bell Push Switch with Ind. (LED)	127.00	139.00	20/600

Code	Item	MRP ₹		Pkg.
		Absolute White	Digital Silver Titanium Grey	
AURA 10AX SWITCHES 240V~ (2 Module)				
182510	1 Way Switch	87.00	95.00	10/300
182511	1 Way Switch with Ind. (LED)	103.00	113.00	10/300
182512	Way Switch	148.00	162.00	10/300
182514	Bell Push Switch with Ind. (LED)	163.00	179.00	10/300

Code	Item	MRP ₹		Pkg.
		Absolute White	Digital Silver Titanium Grey	
AURA 20 / 25AMP SWITCHES 240V~ (1 Module)				
181520	20A 1 Way Switch	128.00	140.00	20/600
181521	20A 1 Way Switch with Ind. (LED)	162.00	178.00	20/600
181522	20A 2 Way Switch	162.00	178.00	20/600
181523	25A 1 Way Switch	177.00	194.00	20/600

Code	Item	MRP ₹		Pkg.
		Absolute White	Digital Silver Titanium Grey	
AURA 20AMP SWITCHES 240V~ (2 Module)				
182525	20A 1 Way Switch	156.00	171.00	10/300
182526	20A 1 Way Switch with Ind. (LED)	178.00	195.00	10/300
182527	20A 2 Way Switch	190.00	206.00	10/300

Code	Item	MRP ₹		Pkg.
		Absolute White	Digital Silver Titanium Grey	
AURA 32AMP DP SWITCH 240V~ (2 Module)				
182531	32A DP Switch with Indicator (LED)	290.00	319.00	10/300

Code	Item	MRP ₹		Pkg.
		Absolute White	Digital Silver Titanium Grey	
6AMP / 10AMP SOCKETS 240V~				
181035	6A 2 Pin Socket (1M) with safety shutter	90.00	99.00	20/600
182037	6A 2x1 Socket (2M) with safety shutter	109.00	120.00	10/450
182038	6A 3 Pin Socket (2M) with safety shutter	101.00	111.00	10/450
182039	10A International Socket (2M) with safety shutter	181.00	199.00	10/450
182040	6A Universal Socket (2M) with mobile socket & safety shutter	125.00	137.00	10/450

Code	Item	MRP ₹		Pkg.
		Absolute White	Digital Silver Titanium Grey	
6&16AMP / 6&25AMP SOCKETS 240V~ (2 Module)				
182041	6&16A Universal Socket with safety shutter	199.00	219.00	10/450
182042	6&25A Universal Socket with safety shutter	218.00	239.00	10/450
182043	6&16A Universal Raised Socket with safety shutter	199.00	219.00	10/450
182044	6&16A Universal Socket with flap, indicator & safety shutter	199.00	219.00	10/450

Code	Item	MRP ₹		Pkg.
		Absolute White	Digital Silver Titanium Grey	
DIMMER / FAN REGULATOR 240V~ (1 Module)				
181045	Dimmer - 450W	258.00	283.00	20/600
181050	4 Step Regulator - Full Rotary NEW	375.00	410.00	20/600
181051	4 Step Regulator (Regulator Supplied in ISI & Non ISI)	357.00	392.00	20/600

Code	Item	MRP ₹		Pkg.
		Absolute White	Digital Silver Titanium Grey	
FULL ROTARY FAN REGULATOR 240V~ (2 Module)				
182052	Tri-Star 5 Step Regulator - Full Rotary NEW	427.00	469.00	10/300
182053	Orion 5 Step Regulator - Full Rotary NEW	427.00	469.00	10/300
182054	5 Step Regulator - Full Rotary (Regulator Supplied in ISI & Non ISI)	427.00	469.00	10/300

Code	Item	MRP ₹		Pkg.
		Absolute White	Digital Silver Titanium Grey	
MOTOR STARTER (SP) 240V~ 50-60Hz (2 Module)				
182057	16A Motor Starter Switch	521.00	573.00	10/300
182058	20A Motor Starter Switch	521.00	573.00	10/300
182059	25A Motor Starter Switch	521.00	573.00	10/300

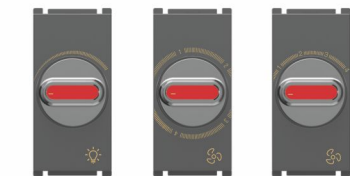
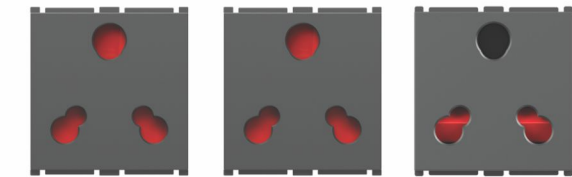
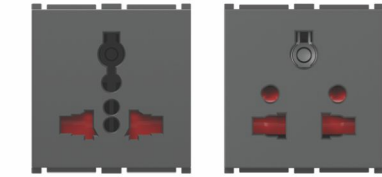
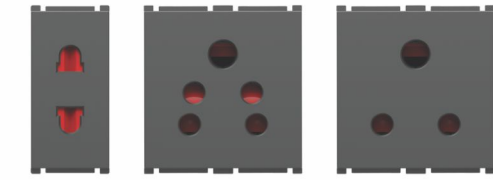

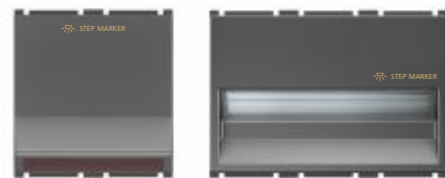
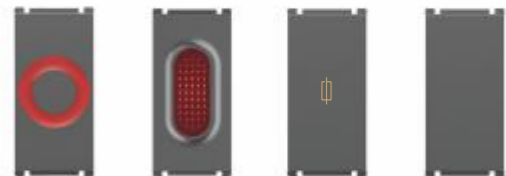
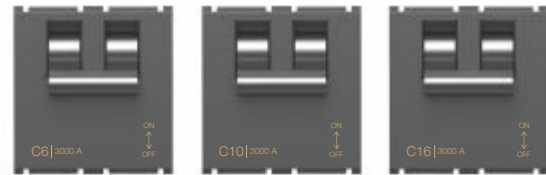

Code	Item	MRP ₹		Pkg.
		Absolute White	Digital Silver Titanium Grey	
TV SOCKET / RJ-11 TELEPHONE JACKS / EDP SOCKET (1 Module)				
181062	TV Socket Coaxial 40-862 Mhz Socket	111.00	122.00	20/900
181068	Telephone Jack - RJ 11	112.00	123.00	20/600
181074	EDP Socket Outlet - RJ 45 (Cat 6e) Category 6e, Universal wiring T568A, insulating-piercing terminal	545.00	599.00	20/600

SINGLE POLE MCB 240/450V~ (1 Module)				
181077	C6 SP MCB	309.00	340.00	20/600
181078	C10 SP MCB	309.00	340.00	20/600
181079	C16 SP MCB	309.00	340.00	20/600
181080	C20 SP MCB	309.00	340.00	20/600
181081	C25 SP MCB	309.00	340.00	20/600
181082	C32 SP MCB	309.00	340.00	20/600

240/450V~ 50-60Hz 3kA Breaking Capacity

DOUBLE POLE MCB 240/450V~ (2 Module)				
182083	C6 DP MCB	638.00	702.00	10/300
182084	C10 DP MCB	638.00	702.00	10/300
182085	C16 DP MCB	638.00	702.00	10/300
182086	C20 DP MCB	638.00	702.00	10/300
182087	C25 DP MCB	638.00	702.00	10/300
182088	C32 DP MCB	638.00	702.00	10/300

240/450V~ 50-60Hz 3kA Breaking Capacity

INDICATOR / FUSE UNIT / BLANK MODULE (1 Module)				
181093	Indicator with LED & Red Diffuser	97.00	106.00	20/600
181094	Indicator with LED & Red Diffuser	97.00	106.00	20/600
181098	Fuse Carrier (10Amp/16Amp) with miniature fuse dia 6.3x28	135.00	148.00	20/600
181125	Blank Module	30.00	33.00	50/2000

STEP MARKER 240V~				
182105	Step Marker (2M) Supply voltage 240V~ 50-60Hz with high-efficiency 5x0.2W LED	499.00	548.00	10/300
183106	Step Marker (Warm White LED) (3M) Supply voltage 240V~ 50-60Hz with high-efficiency 6x0.2W LED	599.00	658.00	5/100

* introducing shortly

Code	Item	MRP ₹		Pkg.
		Absolute White	Digital Silver Titanium Grey	
ELECTRONIC BELL / 32A MAIN SWITCH 240V~ (2 Module)				
182139	Electronic Bell 240V~50-60Hz	328.00	362.00	10/300
182163	32A DP Operated by Key Tag 240V~, LED Supplied with Key Tag	437.00	480.00	10/300
182164	Only Key Tag with Name Plate	97.00	107.00	100/2000

DND/MAKE MY ROOM (2 Module)				
182168	Do Not Disturb/Make My Room 240V~ 50-60Hz - Inside Room	402.00	442.00	10/300
182169	Do Not Disturb/Make My Room 240V~ 50-60Hz - Outside Room	430.00	473.00	10/300

USB CHARGER 240V~				
181171	USB Fast Charger - Single Port (1M) Supply voltage 160-240V~ 50-60Hz Output - 5V =1.50A / 9V =1.45A (Max 14W) NEW	950.00	1045.00	10/300
181172	USB Charger (1M) Supply voltage 160-240V~ 50-60Hz Output - 5V DC, 1A (Total)	865.00	951.00	10/300
182173	USB Charger with 2 USB ports (2M) Supply voltage 160-240V~ 50-60Hz Output - 5V DC, 2A (Total)	920.00	1012.00	10/300

STEP MARKER 240V~				
184107	Footlight Step Marker (4M) Supply voltage 240V~ 50-60Hz with high-efficiency 5x0.2W LED	724.00	794.00	5/120
182108W	Push Step Marker (White LED) - 2M Supply voltage 240V~ 50-60Hz with high-efficiency 2x0.5W LED	558.00	613.00	10/300

i-SMART BLUETOOTH & Wi-Fi 6A SWITCHES NEW				
181185*	i-Smart 6A Switch - 1M	1750.00	1925.00	5/100
182189*	i-Smart 6A 2 Switch - 2M	2300.00	2500.00	5/100

Supply voltage 160-240V~, 6A relay output
Operating load (CFL & LED): 100W Max (per switch)
Bluetooth : BLE V5.1, Wi-Fi : 2.4G

i-SMART BLUETOOTH & Wi-Fi 20A SWITCH (2 Module) NEW				
182190*	i-Smart 20A Switch	2300.00	2500.00	5/100

Supply voltage 160-240V~, 20A relay output
Operating load (CFL & LED): 200W Max
Air conditioner: 2 ton
Bluetooth : BLE V5.1, Wi-Fi : 2.4G

i-SMART BLUETOOTH & Wi-Fi DIMMER/FAN REGULATOR (2 Module) NEW				
182192*	i-Smart Dimmer	3200.00	3500.00	5/100
182196*	i-Smart Fan Regulator	3500.00	3850.00	5/100

Supply voltage 160-240V~, Triac Technology with soft end & soft start function
Operating load (LED) : 80W (Max)
Incandescent Light: 40-450W
Bluetooth : BLE V5.1, Wi-Fi : 2.4G
Not suitable for Fan

Supply voltage 160-240V~ Variable Capacitance based 4 step regulator
Operating load (Fan) : 100W
Bluetooth : BLE V5.1, Wi-Fi : 2.4G

Can also be operated via i-World App, Google Home & Alexa

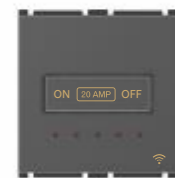
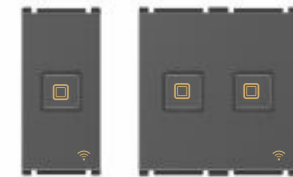



Air A7 Absolute White Plate with Titanium Grey Artio Switches

ARTIO

The Artio is a delightfully simple and minimalistic expression of the Air range. Embodying reductionism and refinement, which are hallmarks of a sleek, modern, and urbane lifestyle, the Artio makes a contemporary statement in every sense. Embedded within a square frame, the Artio switches can be installed as a single switch or as a combination of multiple switches to form a complete circle. The elegance, harmony and compositional unity that Artio represents gives it a truly timeless appeal.

Air A7 Absolute White Plate with Titanium Grey Artio Switch



Code	Item	MRP ₹		Pkg.
		Absolute White	Digital Silver Titanium Grey	
ARTIO 10AX SWITCHES 240V~ [2 Module] NEW				
182301	1 Way Switch (2 Switch)	108.00	127.00	10/300
182303	2 Way Switch (2 Switch)	175.00	206.00	10/300
182306	1 Way Switch (3 Switch)	145.00	171.00	10/300
182307	1 Way + 2 Way Switch (2 Switch)	141.00	166.00	10/300
ARTIO 10AX SWITCHES 240V~ [2 Module] NEW				
182310	1 Way Switch (1 Switch)	98.00	115.00	10/300
182312	2 Way Switch (1 Switch)	154.00	181.00	10/300
182313	Bell Push Switch (1 Switch)	126.00	149.00	10/300
ARTIO 10AX / 20AMP SWITCHES 240V~ [2 Module] NEW				
182320	20A 1 Way Switch (2 Switch)	190.00	224.00	10/300
182321	20A 1 Way Switch with Indicator - LED (2 Switch)	240.00	283.00	10/300
182324	10AX + 20A 1 Way Switch with Indicator - LED (2 Switch)	199.00	235.00	10/300
ARTIO 20AMP SWITCHES 240V~ [2 Module] NEW				
182325	20A 1 Way Switch (1 Switch)	165.00	195.00	10/300
182326	20A 1 Way Switch with Indicator - LED (1 Switch)	195.00	230.00	10/300
ARTIO 32AMP DP SWITCH 240V~ [2 Module] NEW				
182331	32A DP Switch with Indicator (LED)	310.00	366.00	10/300

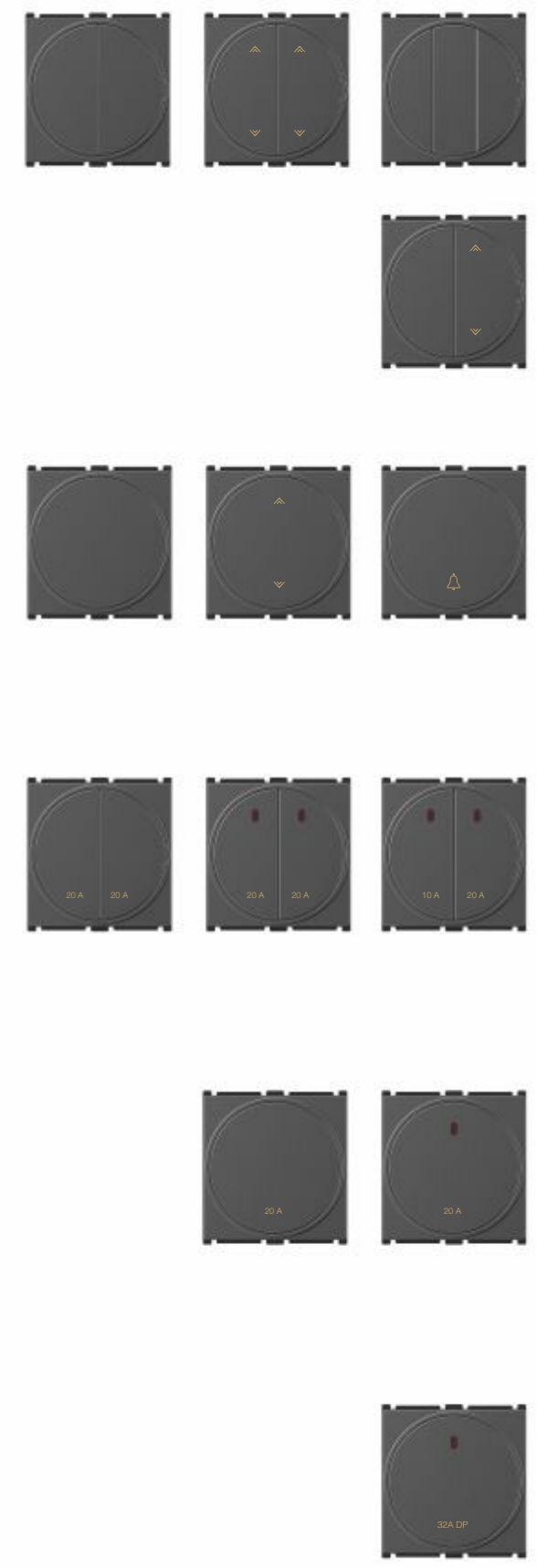



Air A5 Absolute White Plate with Titanium Grey Arcos Switches

ARCOS

The Arcos switch is the perfect blend of sophistication and minimalism, thus encapsulating the signature design of the Air modular range. Like its contemporary Artio, the Arcos too fits seamlessly within the slot of the Air cover plates. The subtly contoured body and the arched edges of the Arcos separates it from the more austere shape of the Artio. Perfectly proportioned, the Arcos makes a distinctive style statement while adhering to Goldmedal's vision of crafting extraordinary, timeless, and truly amazing switches.

Air A5 Absolute White Plate with Titanium Grey Arcos Switch



Code	Item	MRP ₹		Pkg. Outer/ Master
		Absolute White	Digital Silver Titanium Grey	
ARCOS 10AX SWITCHES 240V~ (2 Module) NEW				
182601*	1 Way Switch (2 Switch)	103.00	-	10/300
182603*	2 Way Switch (2 Switch)	170.00	-	10/300
182606*	1 Way Switch (3 Switch)	140.00	-	10/300
182607*	1 Way + 2 Way Switch (2 Switch)	137.00	-	10/300
ARCOS 10AX SWITCHES 240V~ (2 Module) NEW				
182610*	1 Way Switch (1 Switch)	93.00	-	10/300
182612*	2 Way Switch (1 Switch)	149.00	-	10/300
182613*	Bell Push Switch (1 Switch)	121.00	-	10/300
ARCOS 10AX/ 20AMP SWITCHES 240V~ (2 Module) NEW				
182620*	20A 1 Way Switch (2 Switch)	185.00	-	10/300
182621*	20A 1 Way Switch with Indicator - LED (2 Switch)	235.00	-	10/300
182624*	10AX + 20A 1 Way Switch with Indicator - LED (2 Switch)	194.00	-	10/300
ARCOS 20AMP SWITCHES 240V~ (2 Module) NEW				
182625*	20A 1 Way Switch (1 Switch)	160.00	-	10/300
182626*	20A 1 Way Switch with Indicator - LED (1 Switch)	190.00	-	10/300
ARCOS 32AMP DP SWITCH 240V~ (2 Module) NEW				
182631*	32A DP Switch with Indicator (LED)	299.00	-	10/300



* introducing shortly



Air A3 Absolute White Plate with Titanium Grey Aero Switch, Orion Regulator

A3

If you thought practical was dull and boring then you've been looking at the wrong designs. The A3 cover plates will surprise you with their unique combination of practical utility and premium look. Super slim, flat, yet extremely durable, the A3 modular cover plates can easily be the first choice for modern interiors. The distinctive chrome border raises the style quotient of these plates to a higher level! So say yes to practical style that's never boring!

Air A3 Absolute White Plate with Titanium Grey Aero Switch, Tri-Star Regulator



A3 COVER PLATES WITH MOUNTING FRAMES

PLATES →	1M	2M	3M	3M*	4M	4M*	6M	6M*	8M	8M*	8M*	12M*	16M	18M	18M*
						(H&V)**		(H&V)**		(H&V)**	(V)**	(H&V)**			(H&V)**
COLOURS ↓	MRP ₹	MRP ₹	MRP ₹	MRP ₹	MRP ₹	MRP ₹	MRP ₹	MRP ₹	MRP ₹	MRP ₹	MRP ₹	MRP ₹	MRP ₹	MRP ₹	MRP ₹
Pure Glossy	87.00	87.00	117.00	117.00	145.00	145.00	220.00	198.00	305.00	271.00	271.00	320.00	345.00	454.00	396.00
CODE →	180101	180201	180301	180303	180401	180403	180601	180603	180801	180803	188803	181203	181601	181801	181803
Outer/Master →	10/500	10/500	10/400	10/400	10/400	10/400	5/200	5/200	5/200	5/200	5/200	5/120	5/90	5/80	5/80
SIZE(mm) →	98x91	98x91	121x91	121x91	152x91	152x91	220x91	220x91	245x91	245x91	152x168	220x157	245x157	220x222	220x222

* With Partition Plates

**Suitable for Horizontal & Vertical Installation

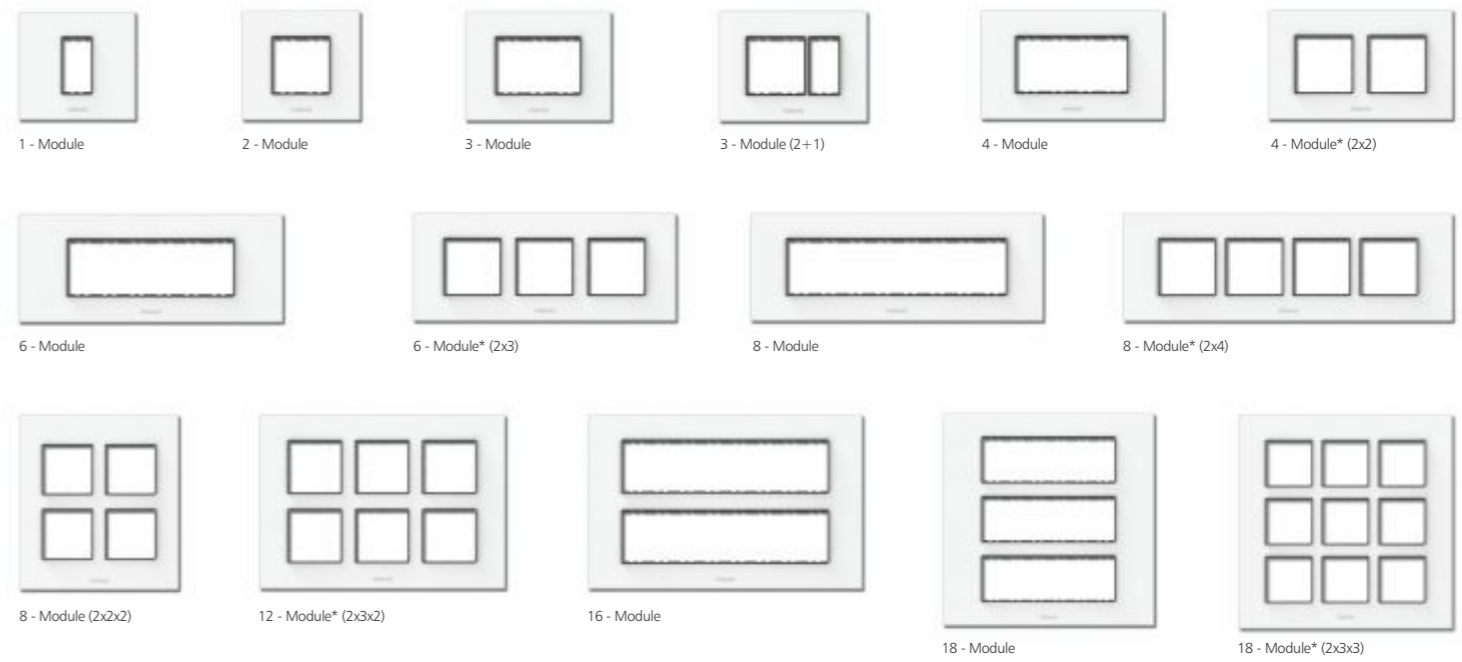

A3 MOUNTING FRAMES - Horizontal & Vertical Distance for Screwing (Dimensions in mm)

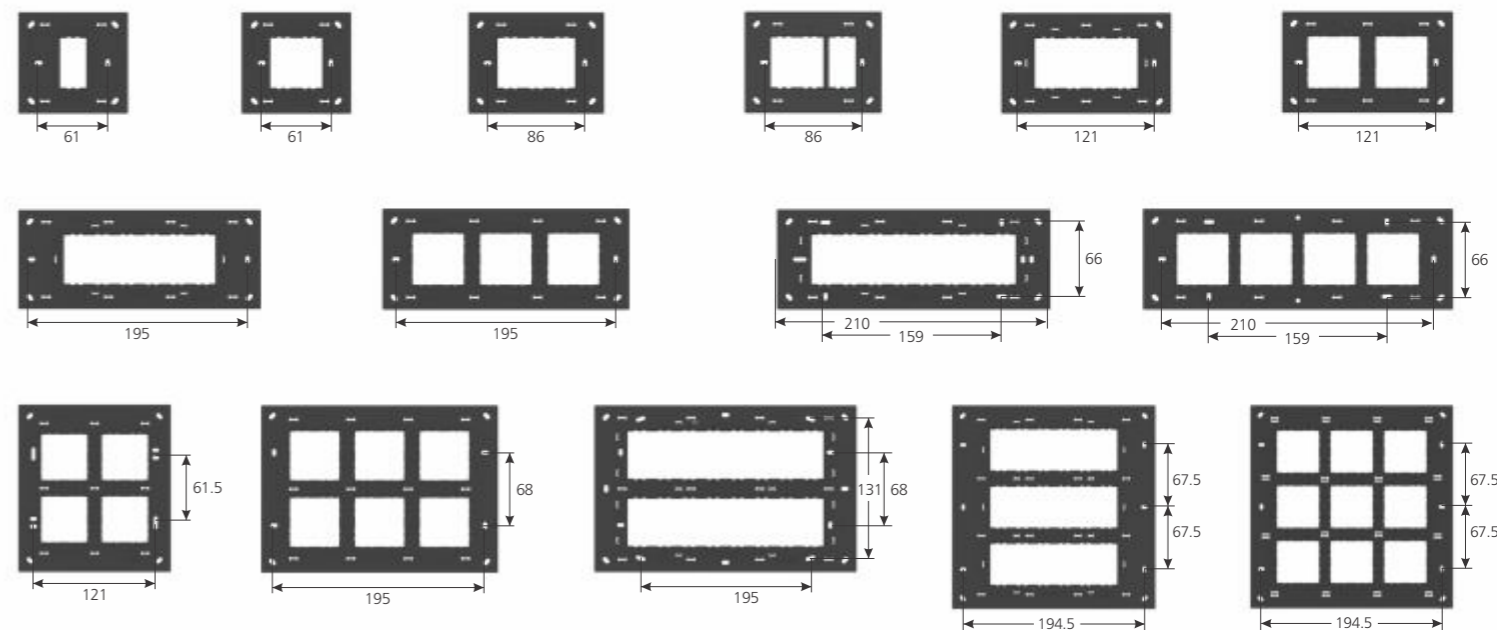



Air A5 White Jazz Plate With Aero Titanium Grey Switches

A5

The new A5 cover plate is a mix of playful elegance and contemporary styling. Gently curved with rounded corners and a sleek chrome border around the inner frame, the A5 is a refreshingly clean and modern design with a dash of added fun. Like other AIR cover plates, the A5 is restrained in a quiet, refined manner without being dull and boring. Introduce A5 to your interiors to exhibit that rare combination of elegance and charming playfulness!

Air A5 Absolute White Plate With Titanium Grey Arc Switch, Regulator



A5 BASIC COVER PLATES WITH MOUNTING FRAMES NEW

PLATES →	1M	2M	3M	4M	4M*	6M	6M*	8M	8M*	8M*	12M*	16M	18M	18M*
					(H&V)**		(H&V)**		(H&V)**	(V)**	(H&V)**			(H&V)**
COLOURS ↓	MRP ₹	MRP ₹	MRP ₹	MRP ₹	MRP ₹	MRP ₹	MRP ₹	MRP ₹	MRP ₹	MRP ₹	MRP ₹	MRP ₹	MRP ₹	MRP ₹
Pure Glossy	77.00	77.00	102.00	127.00	127.00	195.00	172.00	265.00	234.00	234.00	295.00	325.00	395.00	343.00

A5 PREMIUM COVER PLATES WITH MOUNTING FRAMES

Pure Glossy	81.00	81.00	108.00	134.00	134.00	205.00	184.00	284.00	252.00	252.00	305.00	342.00	421.00	369.00
CODE →	220101	220201	220301	220401	220403	220601	220603	220801	220803	228803	221203	221601	221801	221803
Outer/Master →	10/500	10/500	10/400	10/400	10/400	5/200	5/200	5/200	5/200	5/200	5/120	5/90	5/80	5/80
SIZE(mm) →	98x91	98x91	121x91	152x91	152x91	220x91	220x91	245x91	245x91	152x168	220x157	245x157	220x222	220x222

* With Partition Plates ** Suitable for Horizontal & Vertical Installation

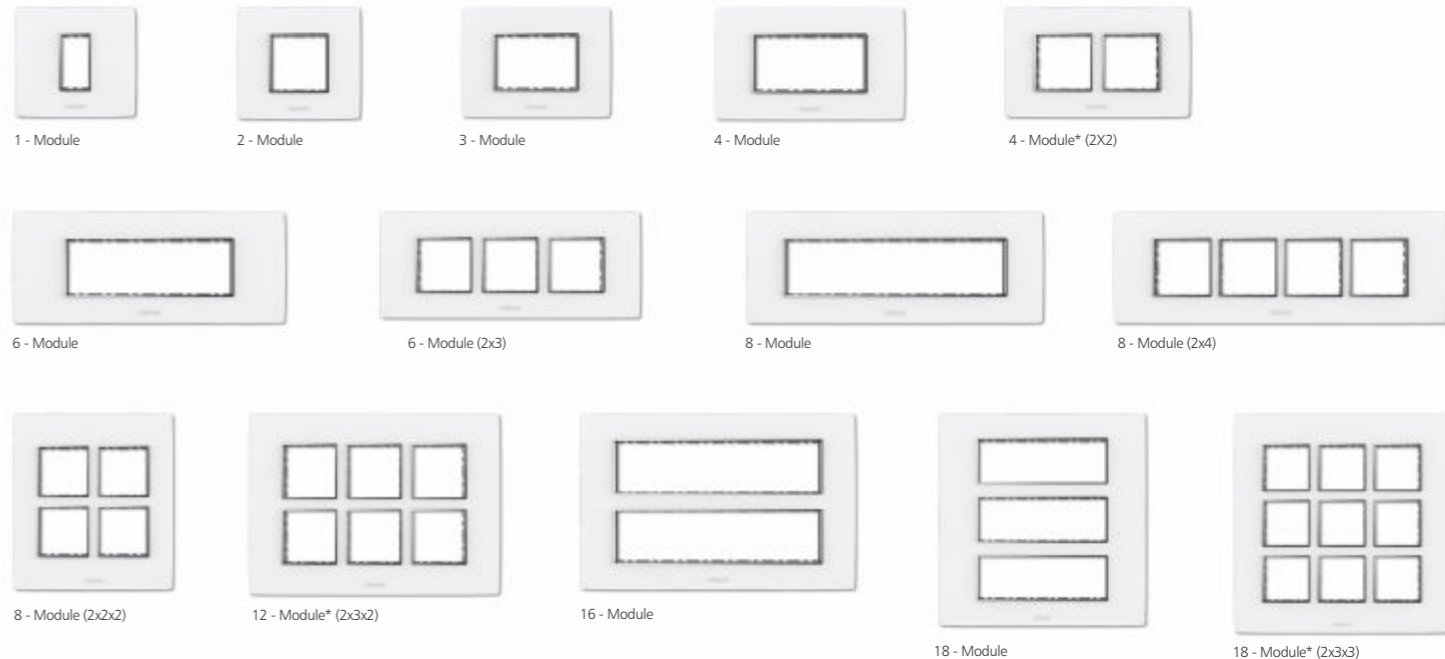

A5 MOUNTING FRAMES - Horizontal & Vertical Distance for Screwing (Dimensions in mm)

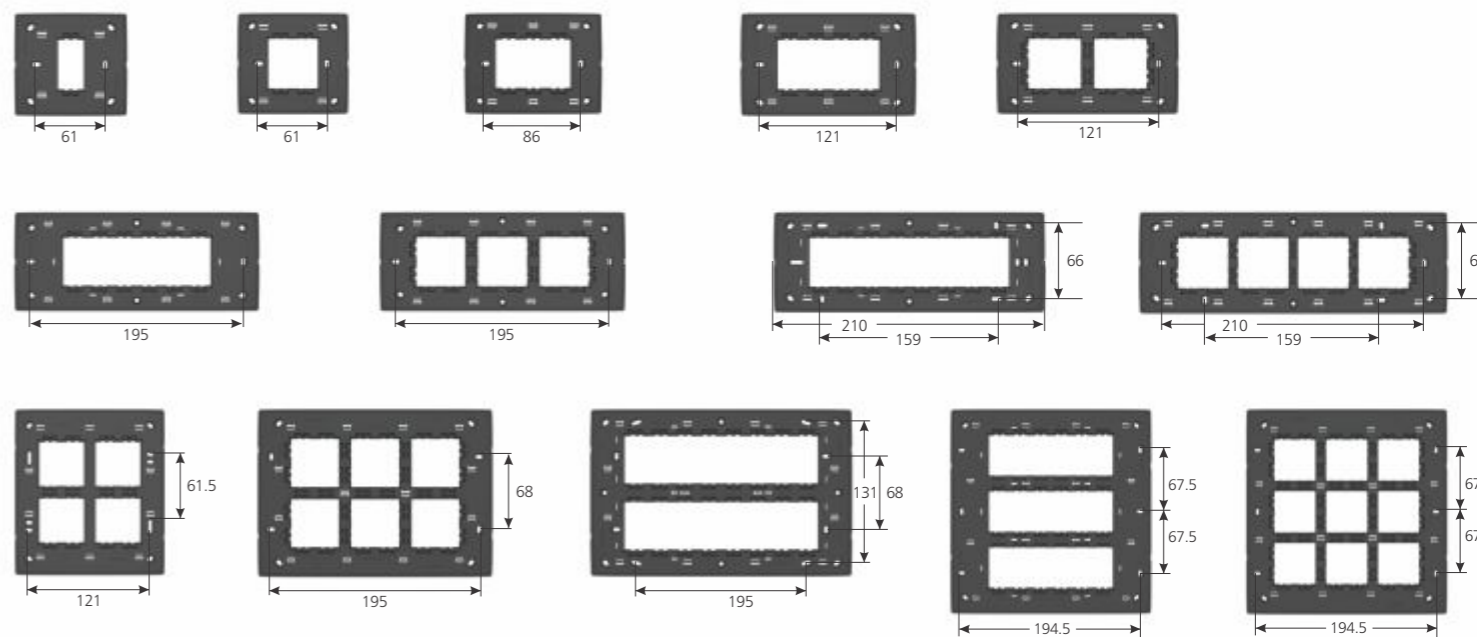



Air A7 Absolute White Plate with Titanium Grey Wi-Fi Switch, Regulator

A7

The AIR A7 cover plate is a wonderful combination of contemporary minimalistic design and stylish elegance. This is an ultra-flat plate with softly rounded corners and sleek chrome border around the inner frame. Characterised by AIR's familiar austere yet charming looks, the A7 offers a quiet and reserved presence without appearing mundane or boring. A quintessential modern-day switch plate, the A7 adds a touch of luxury with convincing functionality to every setting.

Air A7 Absolute White Plate With Titanium Grey Aero Switch, Step Marker



A7 PREMIUM COVER PLATES WITH MOUNTING FRAMES NEW

PLATES →	1M	2M	3M	3M*	4M	4M*	6M	6M*	8M	8M*	8M*	12M*	16M	18M*
						(H&V)**		(H&V)**		(H&V)**	(V)**	(H&V)**	(H&V)**	(H&V)**
COLOURS ↓	MRP ₹	MRP ₹	MRP ₹	MRP ₹	MRP ₹	MRP ₹	MRP ₹	MRP ₹	MRP ₹	MRP ₹	MRP ₹	MRP ₹	MRP ₹	MRP ₹
Pure Glossy	81.00	81.00	108.00	108.00	134.00	134.00	205.00	184.00	284.00	252.00	252.00	305.00	342.00	369.00
CODE →	230101	230201	230301	230303	230401	230403	230601	230603	230801	230803	238803	231203	231603	231803
Outer/Master →	10/500	10/500	10/400	10/400	10/400	10/400	5/200	5/200	5/200	5/200	5/200	5/120	5/90	5/80
SIZE(mm) →	98x91	98x91	123x91	123x91	152x91	152x91	225x91	225x91	250x91	275x91	152x168	225x158	275x158	225x225

* With Partition Plates ** Suitable for Horizontal & Vertical Installation

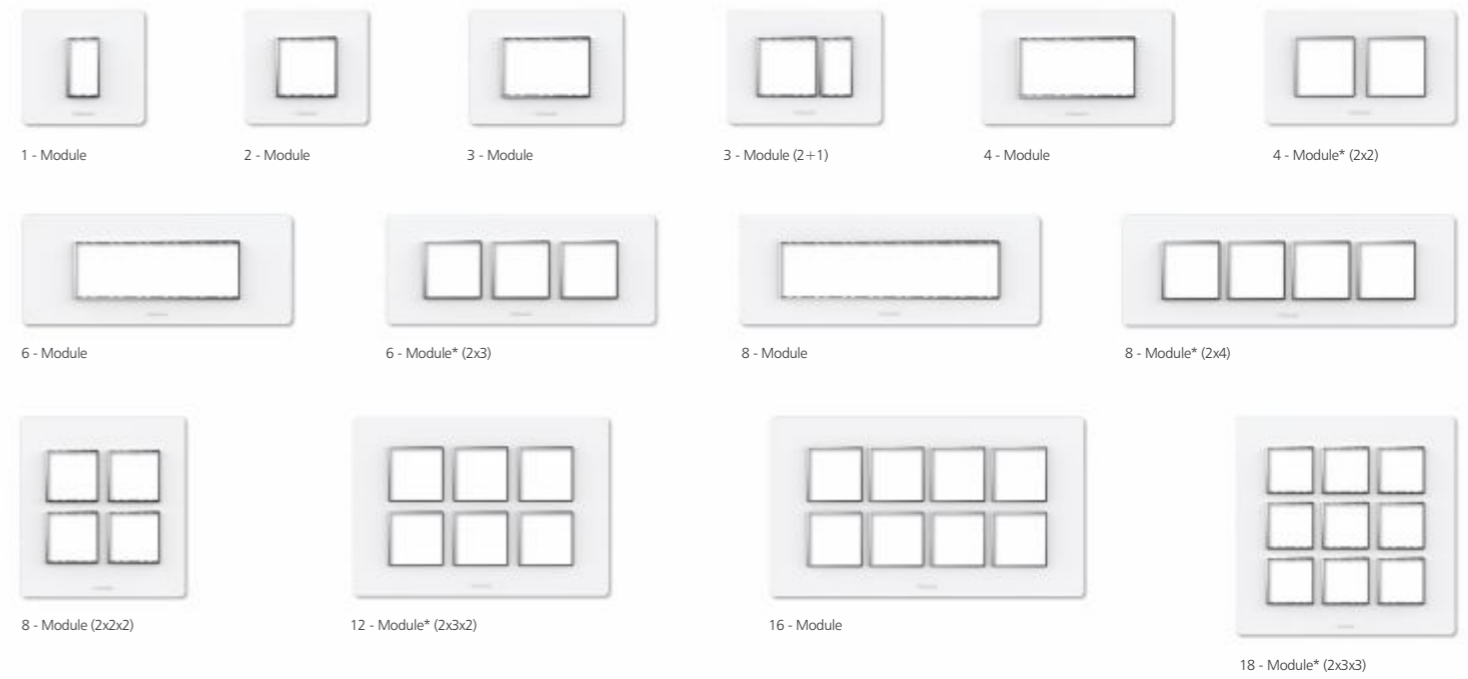

A7 MOUNTING FRAMES - Horizontal & Vertical Distance for Screwing (Dimensions in mm)

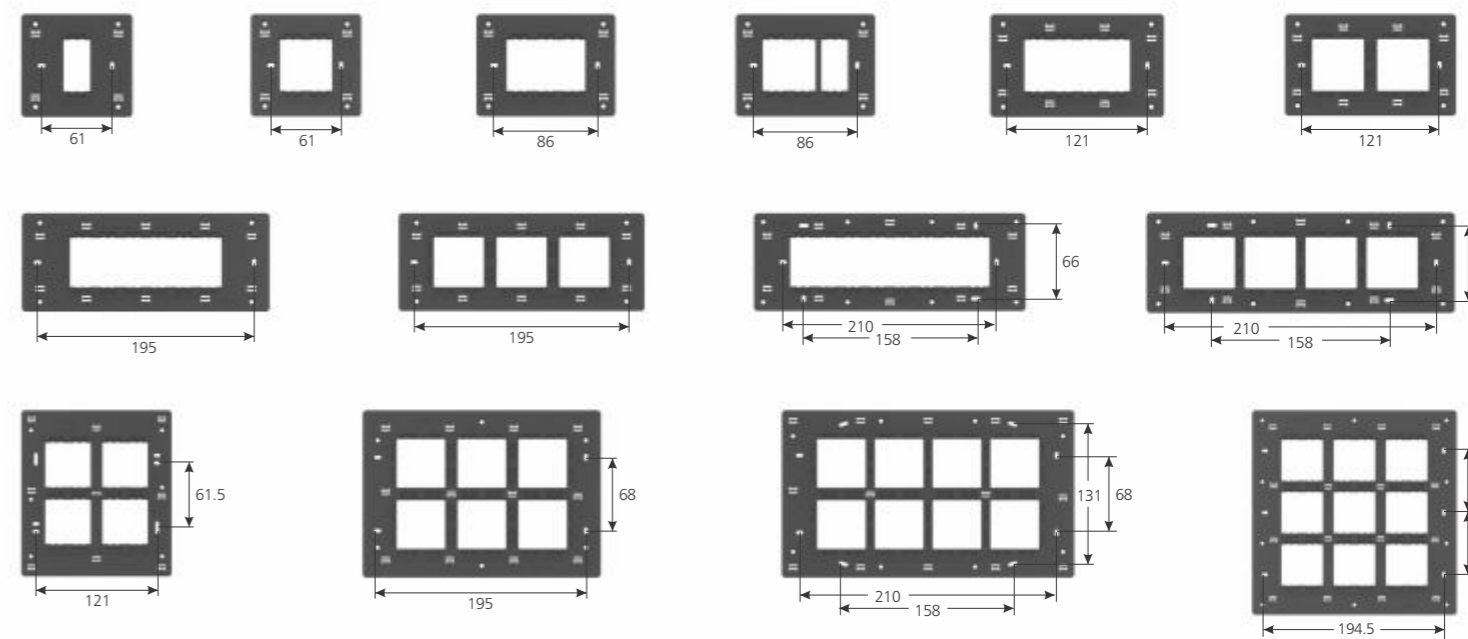

A6 WOODEN MODULAR PLATES - SUITABLE FOR WOODEN & METAL BOXES									
PLATES	1M	2M	3M	4M	4M*	6M	6M*	6M	8M*
					(H&V)**		(H&V)**		(V)
COLOURS	MRP ₹	MRP ₹	MRP ₹	MRP ₹	MRP ₹	MRP ₹	MRP ₹	MRP ₹	MRP ₹
Pure Glossy	98.00	98.00	123.00	168.00	148.00	234.00	213.00	234.00	280.00
Metallic	152.00	152.00	192.00	260.00	229.00	362.00	332.00	362.00	432.00
Wood	191.00	191.00	240.00	325.00	286.00	451.00	414.00	451.00	541.00
CODE	190101	190201	190301	190401	190403	190601	190603	190605	198803
Outer/Master	10/300	10/300	10/300	10/240	10/240	10/200	10/200	10/200	5/200
SIZE(inch)	4.5x4.5	4.5x4.5	4.5x4.5	4.5x6.5	4.5x7.5	4.5x8.5	4.5x8.5	4.5x8.5	6.5x6.5
Module Format	-	-	-	-	2x2	-	2x3	3x2	2x2x2

*With Partition Plates **Suitable for Horizontal & Vertical Installation

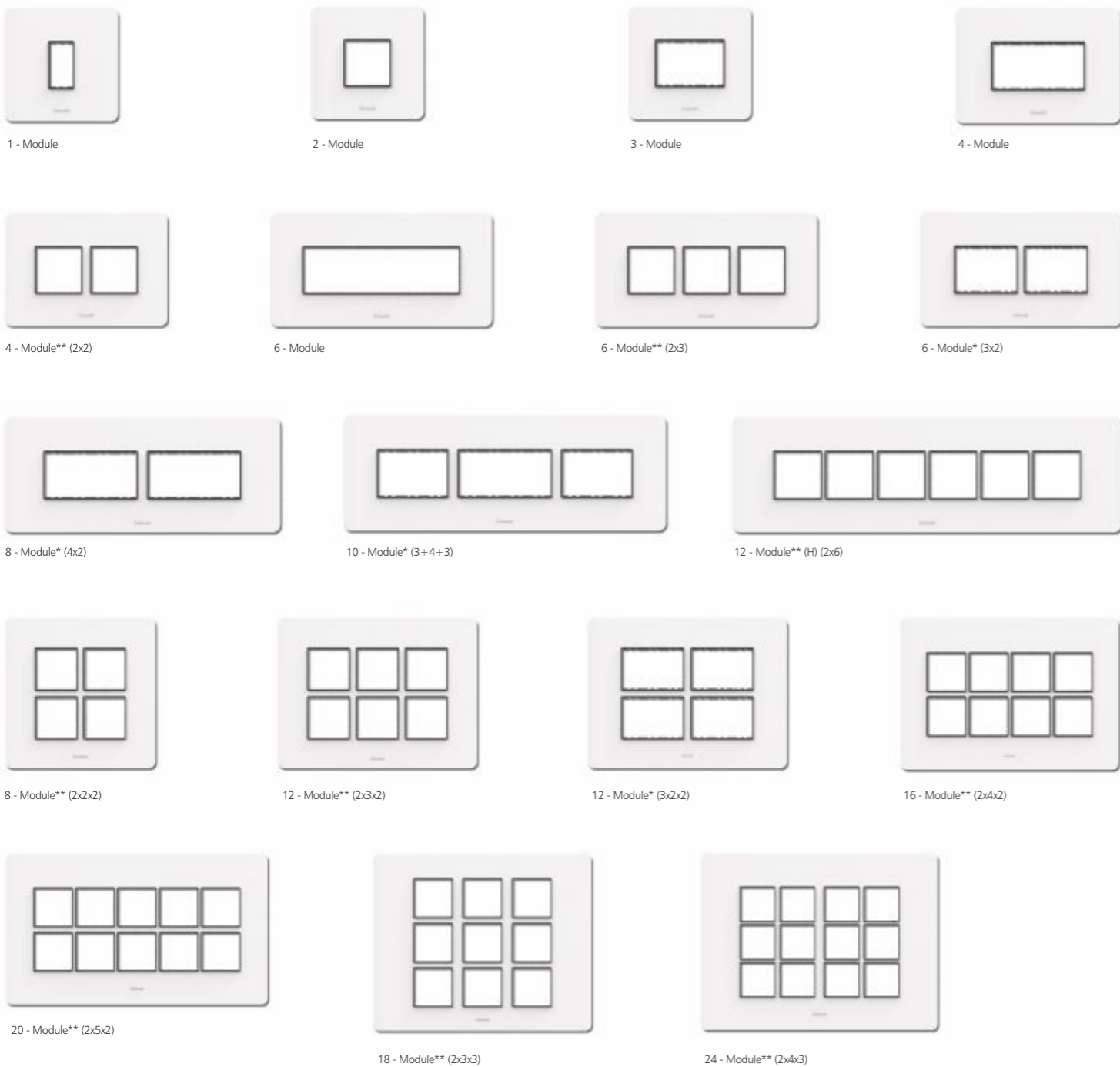

A6 WOODEN MODULAR PLATES - SUITABLE FOR WOODEN & METAL BOXES								
8M*	10M	12M [#]	12M	12M	16M*	18M*	20M [#]	24M [#]
	(H)*	(H&V)**	(V)**	(V)*	(H&V)**	(H&V)**	(H&V)**	(H&V)**
MRP ₹	MRP ₹	MRP ₹	MRP ₹	MRP ₹	MRP ₹	MRP ₹	MRP ₹	MRP ₹
280.00	324.00	366.00	411.00	366.00	392.00	471.00	591.00	733.00
432.00	502.00	568.00	637.00	568.00	608.00	728.00	915.00	1136.00
541.00	629.00	712.00	796.00	712.00	760.00	909.00	1143.00	1420.00
CODE	190805	191001	191201	191203	191205	191601	191801	192001
Outer/Master	10/200	10/120	10/120	5/120	5/120	5/90	5/80	5/60
SIZE(inch)	4.5x10.5	4.5x12.5	4.5x15.5	6.5x8.5	6.5x8.5	7.5x10.5	8.5x10.5	7.5x12.5
Module Format	4x2	3+4+3	2x6	2x3x2	3x2x2	2x4x2	2x3x3	2x5x2

*With Partition Plates **Suitable for Horizontal & Vertical Installation

A6 MOUNTING FRAMES - Horizontal & Vertical Distance for Screwing [Dimensions in mm]

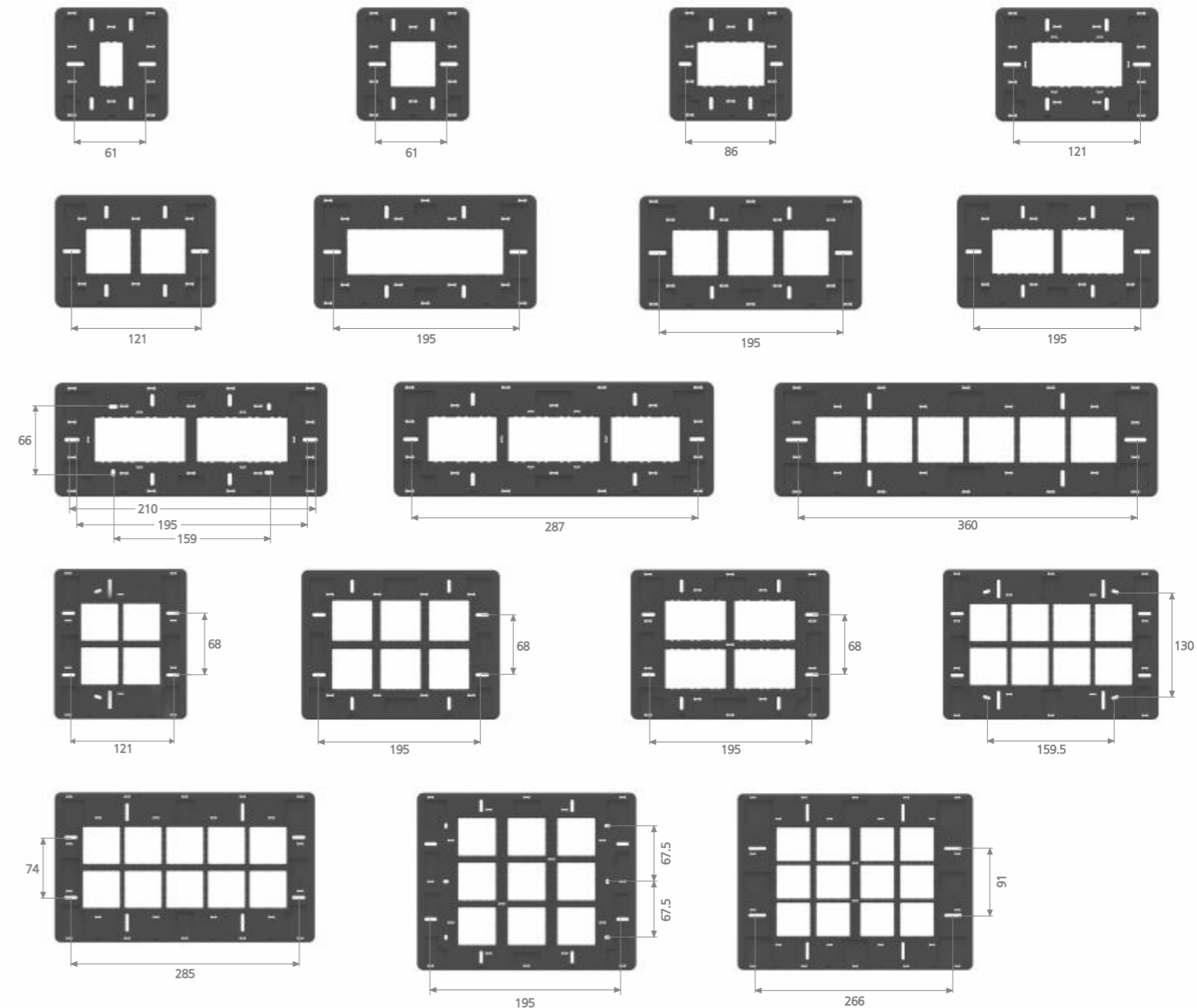

Not Suitable for Metal Box



DEFINE YOUR WORLD WITH COLOURS

A3
PLATES

PURE GLOSSY



01- Absolute White

A5
PLATES

BASIC - PURE GLOSSY



01- Absolute White

PREMIUM - PURE GLOSSY



01- Absolute White

A7
PLATES

PREMIUM - PURE GLOSSY



01- Absolute White

A6
PLATES

PREMIUM - PURE GLOSSY



01- Absolute White

METALLIC



07- Titanium Grey

WOOD



21- Volcanic Ash



22- Coffee Magic



23- Wild Wenge

* Colours shown may not match actual product colours due to printing limitations



G-STYLE

GIFA F9 Absolute White Plate
With G-Style Switches
In Titanium Grey



The G-Style switch lives up to its name with a design that is breathtakingly modern and stylish. An angular switch with defined body lines, delicately curved edges, and a metallic glaze finish, the G-Style has a striking presence in any setting. The F9, with its crisp finish and clear straight lines complements the G-Style to create a modern and sophisticated combination that will match the aesthetics of every modern home.



GIFA F9 Absolute White Plate with G-Style Switches in Titanium Grey

Bold. Contemporary.
Truly modern.

G-Slide

It's the most commonly used electrical device. But with G-Slide, the humble switch is where the magic happens. With its smooth, flowing lines, the G-Slide adds silken elegance and an almost ethereal beauty to an otherwise utilitarian device. The end result is a switch that is as delightful as it is practical.



G-Slide
Add a new dimension to your interiors

G-Style

The G-style switch lives up to its name with its breathtakingly modern and stylish appearance. An angular switch with defined body lines, delicately curved edges, and a metallic glaze finish, the G-Style has a striking presence in any setting. With its effortless symphony of form and function, the G-Style easily complements the aesthetics of every modern home.



G-Style
Ideal for modern interiors

G-Line

It doesn't get more minimalistic than this! The straight, clean lines of the G-Line, with its barest-minimum-possible protrusion over the cover plate surface, conveys the futuristic, minimalistic look that defines GIFA. Classically perfect, yet contemporary in styling, the G-Line is a pleasure to use at home and at work.



G-Line
Perfect crisp lines that define the Air range

Ultimate sophistication.

The GIFA range of modular inserts is minimalistic not just for aesthetic purposes but as a design philosophy. Represented by clear straight lines, crisp finishes, and minimum flourishes, these inserts are perfectly streamlined for optimum functionality. Deep thought has been given into the configuration and purpose of each product. The end result is an effortless symphony of form with function and class with comfort that will surprise and delight you on an everyday basis.



F9 Plate -
G-Style Switch with Indicator



F9 Plate -
I-Wave Switch

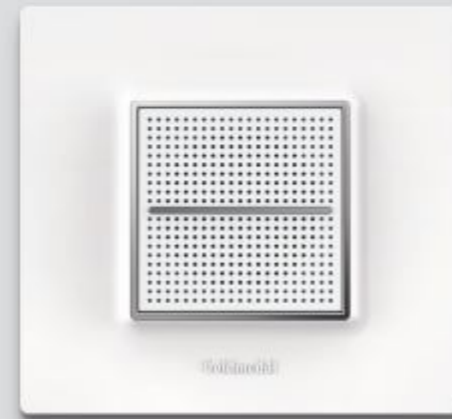

F9 Plate -
Stereophonic Speaker



F9 Plate -
Smart Passive Infrared Detector



F9 Plate -
Lighting Fitting with Emergency Function

F9 Plate -
i-Push Step Marker



F9 Plate -
Fan Regulator Full Rotary



F9 Plate -
USB Charger

Sound never looked better!

GIFA presents the Smart Dock that can be a smart companion to your smartphone! At rest, the Smart Dock remains flush with the cover plate. Apply gentle pressure on the unit and it springs out into position. Simply place your phone on the console to get it charging. Along with listening to FM, you can also listen to the music on your phone, plus make, receive, reject and end calls, as well as control the volume of the phone and change music tracks. And you can do all of these with the help of buttons, voice control, and some even through hand gestures!



GIFA A9 French Wine Cover Plate with i-Dock in Titanium Grey

-  Made for iPod
-  Made for iPhone
-  Android
-  Bluetooth
-  FM Radio
-  Bass
-  Smart Phone
-  Audio World
-  Sir/S-Voice
-  Gesture Control

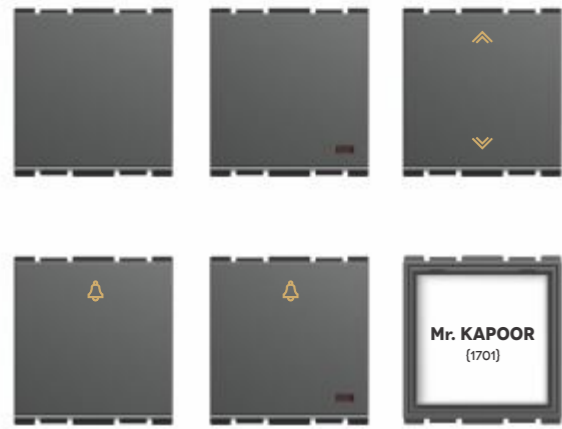

Code	Item	MRP ₹		Pkg.
		Absolute White	Digital Silver Titanium Grey	
10AX SWITCHES 240V~ (1 Module) GLINE				
GF011001	1 Way Switch	70.00	76.00	20/600
GF011002	1 Way Switch with Indicator (LED)	124.00	139.00	20/600
GF011003	2 Way Switch	141.00	155.00	20/600
GF011004	Bell Push Switch	143.00	157.00	20/600
GF011005	Bell Push Switch with Indicator (LED)	143.00	157.00	20/600

Code	Item	MRP ₹		Pkg.
		Absolute White	Digital Silver Titanium Grey	
10AX SWITCHES 240V~ (2 Module) GLINE				
GF012010	1 Way Switch	122.00	134.00	10/300
GF012011	1 Way Switch with Indicator (LED)	132.00	144.00	10/300
GF012012	2 Way Switch	190.00	209.00	10/300
GF012013	Bell Push Switch	190.00	209.00	10/300
GF012014	Bell Push Switch with Indicator (LED)	210.00	231.00	10/300
GF012015	Bell Push Switch with Luminous Name Plate	263.00	288.00	10/300

Code	Item	MRP ₹		Pkg.
		Absolute White	Digital Silver Titanium Grey	
20AMP / 25AMP SWITCHES 240V~ (1 Module) GLINE				
GF011020	20A 1 Way Switch	189.00	208.00	20/600
GF011021	20A 1 Way Switch with Ind. (LED)	205.00	225.00	20/600
GF011022	20A 2 Way Switch	210.00	230.00	20/600
GF011023	25A 1 Way Switch	226.00	248.00	20/600

Code	Item	MRP ₹		Pkg.
		Absolute White	Digital Silver Titanium Grey	
20AMP / 25AMP SWITCHES 240V~ (2 Module) GLINE				
GF012025	20A 1 Way Switch	207.00	227.00	10/300
GF012026	20A 1 Way Switch with Ind. (LED)	231.00	254.00	10/300
GF012027	20A 2 Way Switch	247.00	276.00	10/300
GF012028	25A 1 Way Switch	263.00	287.00	10/300

Code	Item	MRP ₹		Pkg.
		Absolute White	Digital Silver Titanium Grey	
32AMP DP SWITCHES 240V~ (2 Module) GLINE				
GF012031	32A DP Switch with Indicator (LED)	369.00	405.00	10/300

Code	Item	MRP ₹		Pkg.
		Absolute White	Digital Silver Titanium Grey	
10AX SWITCHES 240V~ (1 Module) GSLIDE				
GF011401*	1 Way Switch	70.00	76.00	20/600
GF011402*	1 Way Switch with Indicator (LED)	121.00	133.00	20/600
GF011403*	2 Way Switch	138.00	151.00	20/600
GF011404*	Bell Push Switch	139.00	153.00	20/600
GF011405*	Bell Push Switch with Indicator (LED)	148.00	163.00	20/600

Code	Item	MRP ₹		Pkg.
		Absolute White	Digital Silver Titanium Grey	
10AX SWITCHES 240V~ (2 Module) GSLIDE				
GF012410*	1 Way Switch	116.00	128.00	10/300
GF012411*	1 Way Switch with Indicator (LED)	128.00	141.00	10/300
GF012412*	2 Way Switch	183.00	201.00	10/300
GF012413*	Bell Push Switch	183.00	201.00	10/300
GF012414*	Bell Push Switch with Indicator (LED)	203.00	223.00	10/300

Code	Item	MRP ₹		Pkg.
		Absolute White	Digital Silver Titanium Grey	
20AMP / 25AMP SWITCHES 240V~ (1 Module) GSLIDE				
GF011420*	20A 1 Way Switch	186.00	205.00	20/600
GF011421*	20A 1 Way Switch with Indicator	208.00	229.00	20/600
GF011422*	20A 2 Way Switch	205.00	225.00	20/600
GF011423*	25A 1 Way Switch	221.00	243.00	20/600

Code	Item	MRP ₹		Pkg.
		Absolute White	Digital Silver Titanium Grey	
20AMP / 25AMP SWITCHES 240V~ (2 Module) GSLIDE				
GF012425*	20A 1 Way Switch	198.00	218.00	10/300
GF012426*	20A 1 Way Switch with Ind. (LED)	219.00	240.00	10/300
GF012427*	20A 2 Way Switch	235.00	258.00	10/300
GF012428*	25A 1 Way Switch	251.00	276.00	10/300

Code	Item	MRP ₹		Pkg.
		Absolute White	Digital Silver Titanium Grey	
32AMP DP SWITCHES 240V~ (2 Module) GSLIDE				
GF012431*	32A DP Switch with Indicator (LED)	359.00	395.00	10/300

* introducing shortly

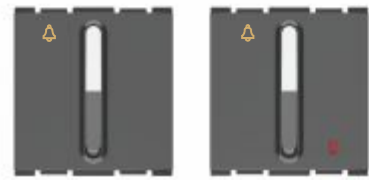
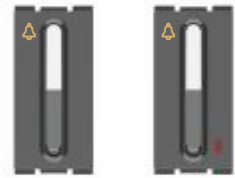

Code	Item	MRP ₹		Pkg.
		Absolute White	Digital Silver Titanium Grey	
10AX SWITCHES 240V~ (1 Module) GStyle NEW				
GF011601*	1 Way Switch	89.00	98.00	20/600
GF011602*	1 Way Switch with Indicator (LED)	162.00	178.00	20/600
GF011603*	2 Way Switch	162.00	178.00	20/600
GF011604*	Bell Push Switch	172.00	189.00	20/600
GF011605*	Bell Push Switch with Indicator (LED)	192.00	211.00	20/600

Code	Item	MRP ₹		Pkg.
		Absolute White	Digital Silver Titanium Grey	
10AX SWITCHES 240V~ (2 Module) GStyle NEW				
GF012610*	1 Way Switch	182.00	200.00	10/300
GF012611*	1 Way Switch with Indicator (LED)	202.00	222.00	10/300
GF012612*	2 Way Switch	212.00	233.00	10/300
GF012613*	Bell Push Switch	222.00	244.00	10/300
GF012614*	Bell Push Switch with Indicator (LED)	242.00	266.00	10/300

Code	Item	MRP ₹		Pkg.
		Absolute White	Digital Silver Titanium Grey	
20AMP / 25AMP SWITCHES 240V~ (1 Module) GStyle NEW				
GF011620*	20A 1 Way Switch	216.00	238.00	20/600
GF011621*	20A 1 Way Switch with Ind. (LED)	236.00	260.00	20/600
GF011622*	20A 2 Way Switch	236.00	260.00	20/600
GF011623*	25A 1 Way Switch	266.00	293.00	20/600

Code	Item	MRP ₹		Pkg.
		Absolute White	Digital Silver Titanium Grey	
20AMP / 25AMP SWITCHES 240V~ (2 Module) GStyle NEW				
GF012625*	20A 1 Way Switch	241.00	265.00	10/300
GF012626*	20A 1 Way Switch with Ind. (LED)	261.00	287.00	10/300
GF012627*	20A 2 Way Switch	261.00	287.00	10/300
GF012628*	25A 1 Way Switch	291.00	320.00	10/300

Code	Item	MRP ₹		Pkg.
		Absolute White	Digital Silver Titanium Grey	
32AMP DP SWITCHES 240V~ (2 Module) GStyle NEW				
GF012631*	32A DP Switch with Indicator (LED)	399.00	439.00	10/300

* introducing shortly

Code	Item	MRP ₹		Pkg.
		Absolute White	Digital Silver Titanium Grey	
6AMP / 10AMP SOCKETS 240V~				
GF011035	6A 2 Pin Socket (1M) with safety shutter	122.00	134.00	20/600
GF012037	6A 2x1 Socket (2M) with safety shutter	143.00	158.00	10/450
GF012038	6A 3 Pin Socket (2M) with safety shutter	136.00	150.00	10/450
GF012039	10A International Socket (2M) with safety shutter	247.00	271.00	10/450
GF012040	6A Universal Socket (2M) with mobile socket & safety shutter	166.00	183.00	10/450

Code	Item	MRP ₹		Pkg.
		Absolute White	Digital Silver Titanium Grey	
6&16AMP / 6&25AMP SOCKETS 240V~ (2 Module)				
GF012041	6&16A Universal Socket with safety shutter	269.00	295.00	10/450
GF012042	6&25A Universal Socket with safety shutter	289.00	317.00	10/450
GF012044	6&25A Universal Socket with flap & Indicator	268.00	295.00	10/450

Code	Item	MRP ₹		Pkg.
		Absolute White	Digital Silver Titanium Grey	
DIMMER / FAN REGULATOR 240 V~ (1 Module)				
GF011045	Dimmer 240V 50-60Hz 300-450W	333.00	365.00	20/600
GF011049	Step Regulator 4 Step, 240V 50-60 Hz	490.00	540.00	20/600

Code	Item	MRP ₹		Pkg.
		Absolute White	Digital Silver Titanium Grey	
GALAXY FAN REGULATOR 240V~ (2 Module)				
GF012050	Fan Regulator - Half Rotary	495.00	-	10/300
GF012051	Fan Regulator - Full Rotary	495.00	-	10/300
GF012052	Fan Regulator - Half Rotary (Chr. Knob)	-	599.00	10/300
GF012053	Fan Regulator - Full Rotary (Chr. Knob)	-	599.00	10/300
	5 Step, 240V 50-60 Hz			

Code	Item	MRP ₹		Pkg.
		Absolute White	Digital Silver Titanium Grey	
MOTOR STARTER (SP) 240V~ 50-60Hz (2 Module)				
GF012058	10A Motor Starter Switch	615.00	676.00	10/300
GF012059	16A Motor Starter Switch	615.00	676.00	10/300
GF012060	20A Motor Starter Switch	615.00	676.00	10/300
GF012061	25A Motor Starter Switch	615.00	676.00	10/300

Code	Item	MRP ₹		Pkg.
		Absolute White	Digital Silver Titanium Grey	
TV SOCKET / RJ-11 TELEPHONE JACKS / EDP SOCKET (1 Module)				
GF011066	TV Socket Coaxial 40-862 Mhz Socket	142.00	158.00	20/900
GF011068	Telephone Jack - RJ 11	151.00	166.00	20/600
GF011072	EDP Socket Outlet - RJ 45 (Cat 5e) Category 5e, Universal wiring T568A, insulating-piercing terminal	246.00	270.00	20/600
GF011074	EDP Socket Outlet - RJ 45 (Cat 6e) Category 6e, Universal wiring T568A, insulating-piercing terminal	620.00	682.00	20/600

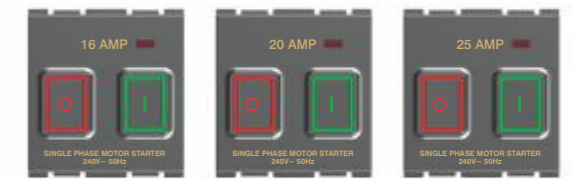
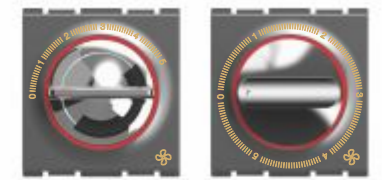
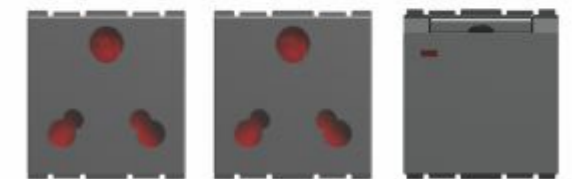
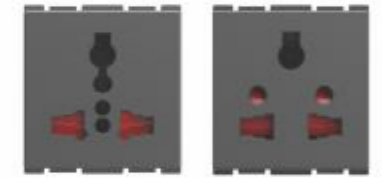
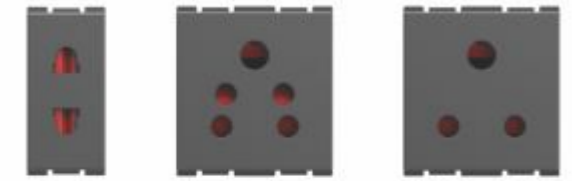

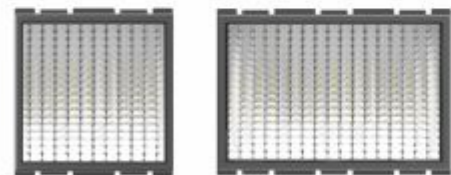
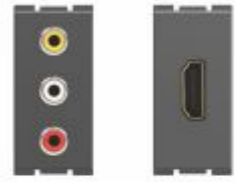

Code	Item	MRP ₹		Pkg.
		Absolute White	Digital Silver Titanium Grey	
AUDIO - VIDEO SOCKET (1 Module) NEW				
GF011075	Triple RCA Socket (Audio & Video)	660.00	720.00	5/150
GF011076	HDMI Socket	1000.00	1102.00	5/150
SINGLE POLE MCBS 240/450V~ (1 Module)				
GF011077	C6 SP MCB	338.00	384.00	20/600
GF011078	C10 SP MCB	338.00	384.00	20/600
GF011079	C16 SP MCB	338.00	384.00	20/600
GF011080	C20 SP MCB	338.00	384.00	20/600
GF011081	C25 SP MCB	338.00	384.00	20/600
GF011082	C32 SP MCB	338.00	384.00	20/600
	240/450V~ 50-60Hz 3.0kA Breaking Capacity			
DOUBLE POLE MCBS 240/450V~ (2 Module)				
GF012084	C6 DP MCB	664.00	731.00	10/300
GF012085	C10 DP MCB	664.00	731.00	10/300
GF012086	C16 DP MCB	664.00	731.00	10/300
GF012087	C20 DP MCB	664.00	731.00	10/300
GF012088	C25 DP MCB	664.00	731.00	10/300
GF012089	C32 DP MCB	664.00	731.00	10/300
	240/450V~ 50-60Hz 3.0kA Breaking Capacity			
INDICATOR / FUSE UNIT / BLANK MODULE (1 Module)				
GF011093	Indicator with LED & Red Diffuser	123.00	140.00	20/600
GF011098	Fuse Carrier (10Amp/16Amp) with miniature fuse dia 6.3x28	165.00	181.00	20/600
GF011125	Blank Module	31.00	34.00	50/2000
STEP MARKER				
GF012104	LED Step Marker (2M) Supply voltage 240V~ 50-60Hz	540.00	596.00	5/100
GF012105	i-Push Step Marker (2M) Supply voltage 240V~ 50-60Hz with high-efficiency 2x0.5W LED	1189.00	1308.00	5/100
GF013106	Step Marker (3M) Supply voltage 240V~ 50-60Hz with high-efficiency 2x0.5W LED	623.00	685.00	5/100
LIGHTING FITTING WITH EMERGENCY FUNCTION				
GF012110	Lighting Fitting with Emergency Function (2M) with High Efficiency 2x0.5W LED & 3 Steps	884.00	972.00	5/100
GF013111	Lighting Fitting with Emergency Function (3M) with High Efficiency 3x0.5W LED & 3 Steps Dimming Switch 240V~ 50Hz when battery is inserted, the device will function as an emergency light - Battery not included (101124)	1305.00	1435.00	5/100

Code	Item	MRP ₹		Pkg.
		Absolute White	Digital Silver Titanium Grey	
ELECTRONIC BELL 240V~ (2 Module)				
GF012139	Electronic Bell 240V~50-60Hz	379.00	417.00	10/300
32A MAIN SWITCH (2 Module)				
GF012163	32A DP Operated by Key Tag 240V~, LED Supplied with Key Tag	592.00	651.00	10/300
GF012164	Only Key Tag with Name Plate	109.00	120.00	N.A.
25A ELECTRONIC BADGE SWITCH (3 Module)				
GF013165	Electronic Switch with Smart Card 25A 240V~ 50-60Hz with indicator (LED) & Integral relay having exit delay.	1654.00	1816.00	5/100
GF013166	Smart Card Customizable Smart Card	140.00	-	N.A.
DND/MAKE MY ROOM (2 Module)				
GF012168	Do Not Disturb/Make My Room 240V~ 50-60Hz - Inside Room	532.00	586.00	10/300
GF012169	Do Not Disturb/Make My Room 240V~ 50-60Hz - Outside Room	569.00	626.00	10/300
UNIVERSAL USB CHARGER 240V~				
GF011171	USB Fast Charger - Single Port (1M) Supply voltage 160-240V~ 50-60Hz Output - 5V = 1.50A / 9V = 1.45A (Max 14W) NEW	950.00	1045.00	20/600
GF011172	USB Charger (1M) Supply voltage 160-240V~ 50-60Hz Output - 5V DC, 1000mA or 1A	865.00	952.00	20/600
GF012173	Dual Port USB Charger (2M) Supply voltage 160-240V~ 50-60Hz Output - 5V DC, 2000mA or 2A	920.00	1012.00	5/100
GF013174	Dual Port USB Charger with Ind. & 10A International Socket (3M) Supply voltage 160-240V~ 50-60Hz Output - 5V DC, 2000mA or 2A	1248.00	1370.00	5/100
I-WAVE SWITCH 240V~ (2 Module)				
GF012201	I-Wave Switch Electronic Sensor switch Supply voltage 160-240V~ 6A relay output Allows to control lights by simply passing the hand in front of it (Max distance 50mm). Upto 5 Switches can be combined to control the same lighting circuit.	2999.00	3300.00	5/100

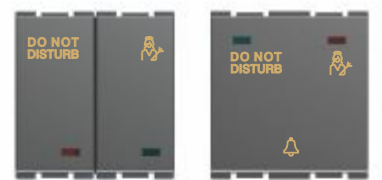

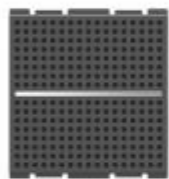
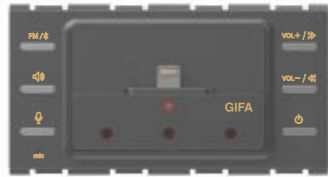

Code	Item	MRP ₹		Pkg.
		Absolute White	Digital Silver Titanium Grey	
SMART PASSIVE INFRARED DETECTOR (2 Module)				
GF012212	Smart Passive Infrared Detector with infrared sensor, auto on/off, adjustable dusk/dawn sensor threshold and time delay cycle, supply voltage 240V-50-60Hz 6A relay output	1783.00	1968.00	5/100
I - DOCK PLAYER (4 Module) NEW				
GF014280	I-Dock Player Supply voltage 240V-, Inbuilt stereo amplifier : 2 x 4W, charging function for Iphone 5, 5S, 5C, 6, 6S, 6Plus, I-pod Touch & I-Pad Air, Gesture control for music & cell phone communication, SIRI enabled. Can be connected to any music system, home audio system, speakers i.e ceiling or inwall through amplifier via Line out (Aux out) Audio input - 3.5mm jack, I-pod, I-phone & Bluetooth Enable devices. Audio output - Stereo Line out, 2 Speaker out 4W each [Amplifier supplied separately - 101320 A Curve Modular Product] - (Page No. 36)	7100.00	7800.00	5/50
GALAXY DOCK PLAYER (4 Module) NEW				
GF014281	Galaxy Dock Player Supply voltage 240V-, Inbuilt stereo amplifier : 2 x 4W, charging function for Samsung S2 and above compatible with charger. Gesture control for music & cell phone communication, S-Voice enabled. Can be connected to any music system, home audio system, speakers i.e ceiling or inwall through amplifier via Line out (Aux out) Audio input - 3.5mm jack, Android devices & Bluetooth Enable devices. Audio output - Stereo Line out, 2 Speaker out 4W each [Amplifier supplied separately - 101320 A Curve Modular Product] - (Page No. 36)	7100.00	7800.00	5/50
STEREOPHONIC SPEAKER (2 Module) NEW				
GF012306	Stereophonic Speaker - 2piece set Output : 3W Impedance : 4 ohms	1099.00	1199.00	10/100
ROUTER + EXTENDER (3 Module) NEW				
GF013322	Wi-Fi Router + Extender 300 MBPS wi-fi wireless router with Ethernet port, In-built USB port for internet connectivity and charging devices. Also support 4G dongle.	4500.00	5000.00	5/100

FLUSH MOUNTING METAL GANG BOXES (GALVANIZED)

GANG BOX →	1 & 2M	3M	4M	6M	8M(H)	8M(V)	12M	16M	18M
MRP ₹ ↓	79.00	105.00	128.00	160.00	210.00	210.00	263.00	321.00	370.00
CODE	GF70201	GF70302	GF70403	GF70604	GF70805	GF78806	GF71207	GF71608	GF71809
Outer/Master →	10/120	10/120	10/120	5/80	5/80	5/60	5/45	5/40	5/40
SIZE (WxHxL) mm	75x73x51	100x73x51	135x73x51	208x73x51	230x73x51	135x130x60	209x130x60	230x144x60	209x200x60

METAL GANG BOXES

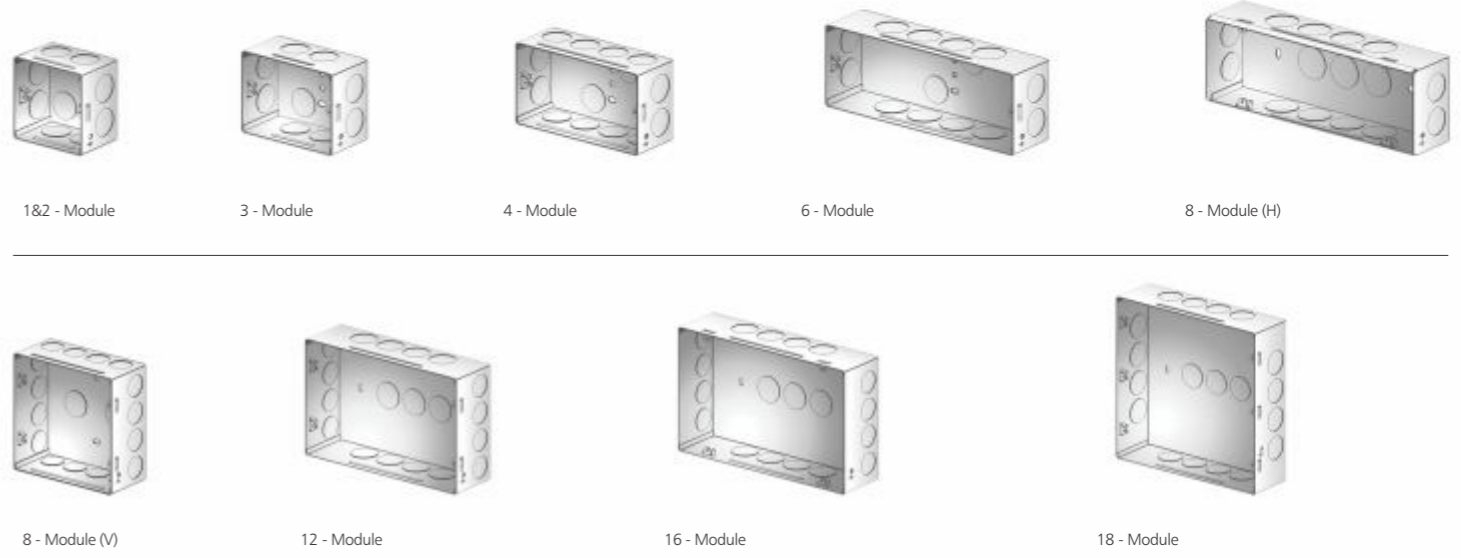



Gifa Ag Mountain Dew Plate with Titanium Grey G-Line Switch Regulator

F9

The F9 range of modular plates are distinctly contemporary in styling. Represented by clear straight lines, crisp finish and imaginative use of colours, these cover plates showcase the very essential components of style. With a minimum of flourishes and embellishments, the F9 communicates the concept of a contemporary cover plate with remarkable clarity and power. Simple and elegant at first look, the F9 will steal your heart over a period of time.

Gifa F9 Absolute White Plate with Titanium Grey G-Line Switch, i-Push Step Marker



F9 COVER PLATES WITH MOUNTING FRAMES																
PLATES →	1M	2M	3M	3M*	4M	4M*	6M	6M*	8M	8M*	8M	8M*	12M	12M*	16M*	18M
						(H&V)**		(H&V)**		(H&V)**	(V)	(H&V)		(H&V)**		
COLOURS ↓	MRP ₹	MRP ₹	MRP ₹	MRP ₹	MRP ₹	MRP ₹	MRP ₹	MRP ₹	MRP ₹	MRP ₹	MRP ₹	MRP ₹	MRP ₹	MRP ₹	MRP ₹	MRP ₹
Pure Glossy	107.00	107.00	132.00	132.00	161.00	161.00	239.00	230.00	304.00	293.00	304.00	293.00	346.00	334.00	377.00	442.00
Metallic	167.00	167.00	216.00	216.00	262.00	262.00	373.00	360.00	468.00	451.00	468.00	451.00	545.00	526.00	595.00	660.00
Wood	226.00	226.00	309.00	309.00	377.00	377.00	533.00	514.00	732.00	706.00	732.00	706.00	788.00	760.00	802.00	875.00
CODE →	GF30101	GF30201	GF30301	GF30303	GF30401	GF30403	GF30601	GF30603	GF30801	GF30803	GF38801	GF38803	GF31201	GF31203	GF31601	GF31801
Outer/Master →	10/400	10/400	10/300	10/300	10/300	10/300	5/150	5/150	5/150	5/150	5/150	5/150	5/120	5/120	5/90	5/80
SIZE(mm) →	98x91	98x91	121x91	121x91	146x91	152x91	220x91	220x91	245x90	275x90	152x168	152x168	220x157	220x157	245x157	220x222

* With Partition Plates **Suitable for Horizontal & Vertical Installation

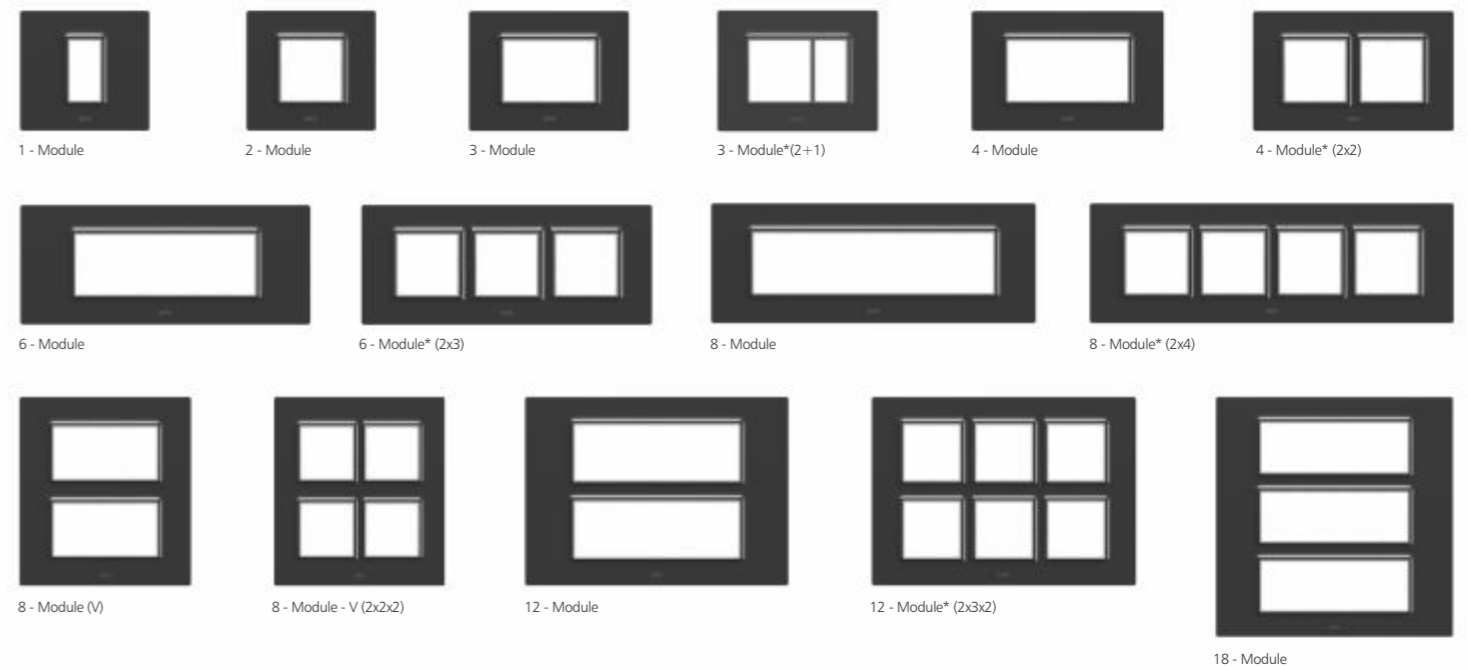

F9 MOUNTING FRAMES - Horizontal & Vertical Distance for Screwing (Dimensions in mm)

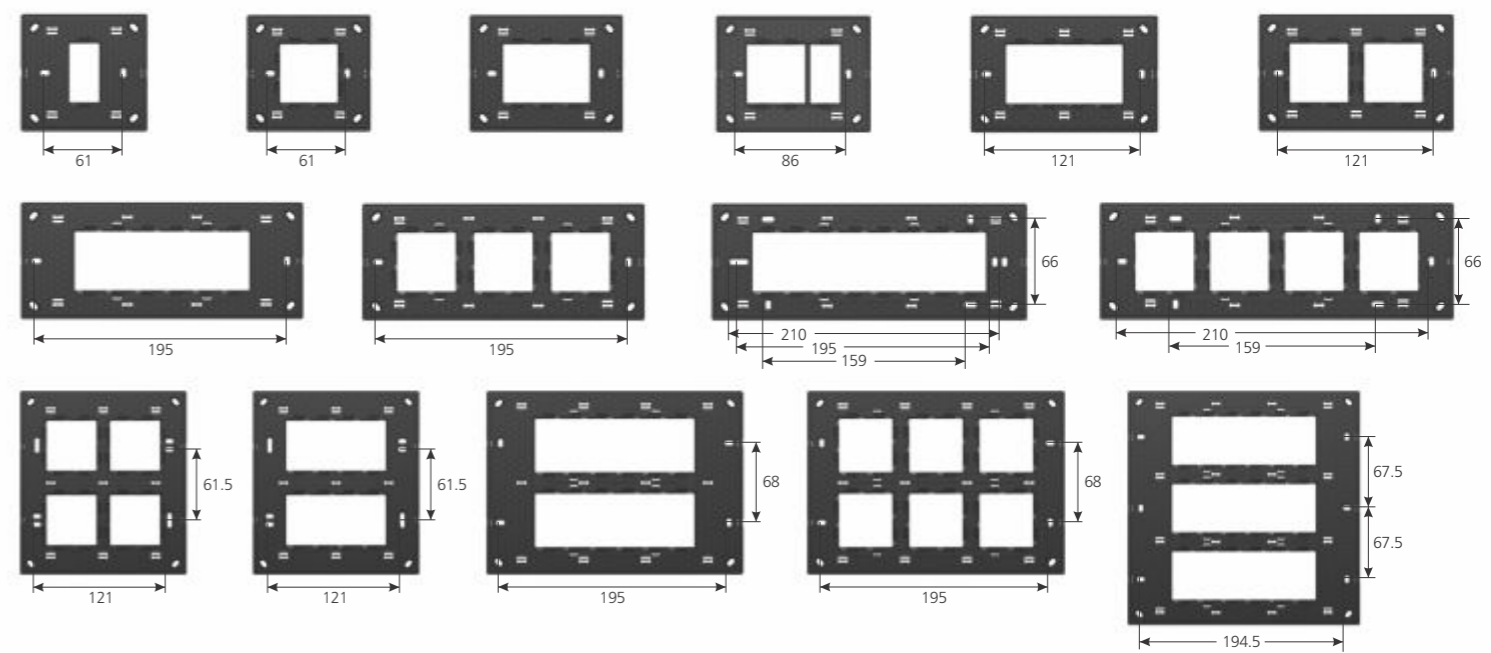



Gifa Ag Mountain Dew Plate with Titanium Grey G-Line Switch, Regulator

A9

The colours of the Ag cover plates are modern yet delicate and almost ethereal in many ways. The tone is muted, relaxed and calm to ensure that these cover plates create a warm, welcoming environment around them. The choice of colours and texture allows the Ag cover plates to coexist peacefully with almost any type of ambience. Complement it with light interiors to create an air of purity and elegance or contrast it with dark interiors to create a rich, plush setting!

Gifa Ag French Wine Plate with Titanium Grey G-Line Switch, Emergency Light



A9 GLASS COVER PLATES NEW										
A9 PLATES →	2M	3M	4M* (H&V)**	6M	6M* (H&V)**	8M* (H&V)**	8M (V) (H&V)**	12M	12M* (H&V)**	18M
COLOURS ↓	MRP ₹	MRP ₹	MRP ₹	MRP ₹	MRP ₹	MRP ₹	MRP ₹	MRP ₹	MRP ₹	MRP ₹
Glass (diamond cut)	567.00	799.00	1158.00	1504.00	1596.00	1759.00	1759.00	1897.00	2012.00	2326.00
CODE →	GF50201	GF50301	GF50403	GF50601	GF50603	GF50803	GF58803	GF51201	GF51203	GF51801
Outer/Master →	10/200	10/200	10/150	5/100	5/100	5/100	5/100	5/75	5/75	5/40
SIZE(mm) →	108x94	130x94	154x94	228x94	228x94	280x94	156x173	228x160	228x160	228x228

* With Partition Plates ** Suitable for Horizontal & Vertical Installation

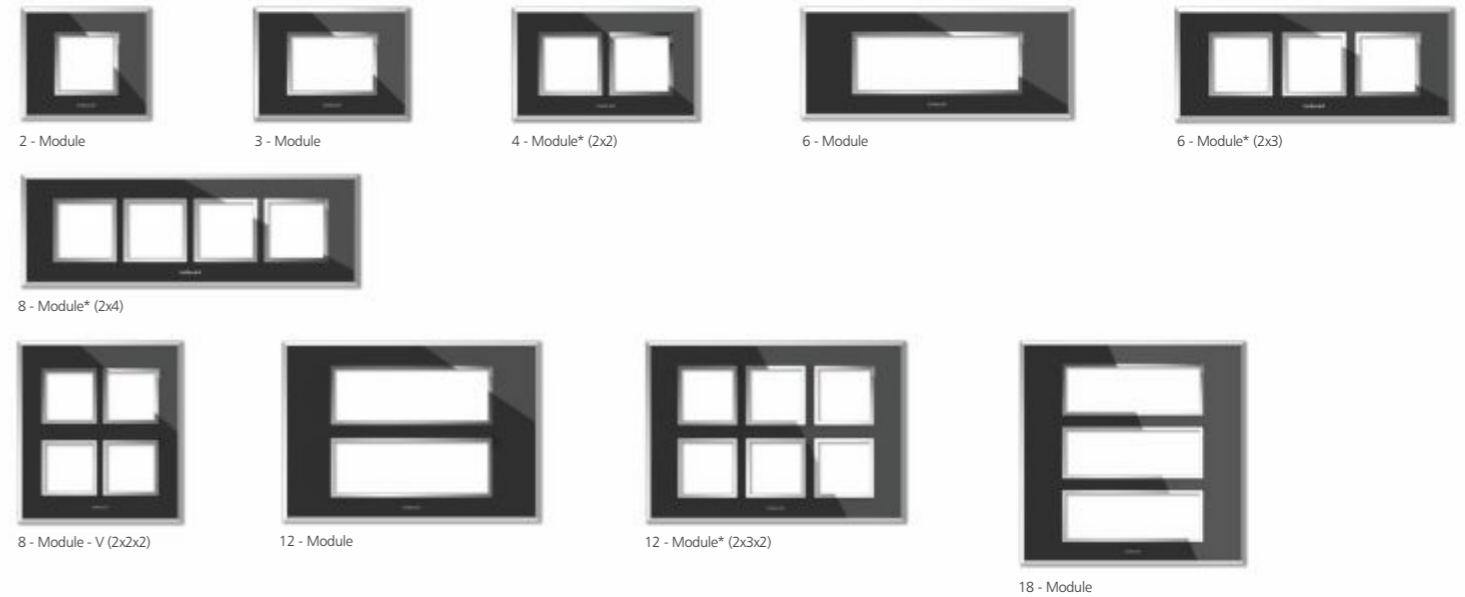

A9 MOUNTING FRAMES - Horizontal & Vertical Distance for Screwing [Dimensions in mm]										
A9 Frame →	2M	3M	4M (H&V)**	6M	6M* (H&V)**	8M* (H&V)**	8M (V) (H&V)**	12M	12M* (H&V)**	18M
MRP ₹ →	57.00	68.00	83.00	114.00	124.00	155.00	155.00	184.00	196.00	249.00
CODE →	GF50202	GF50302	GF50404	GF50602	GF50604	GF50804	GF58804	GF51202	GF51204	GF51802
Outer/Master →	25/750	25/750	25/500	20/240	20/240	20/240	20/240	20/160	20/160	10/80

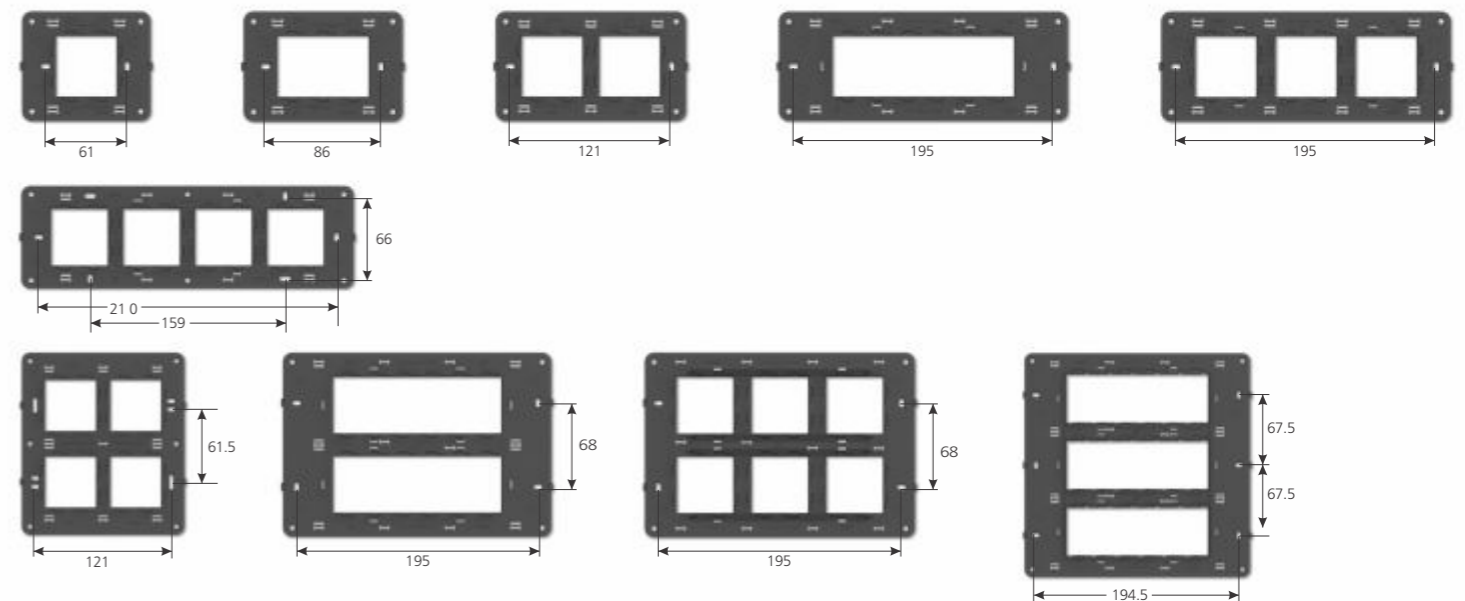



Gifa X9 Absolute White Plate with Titanium Grey G-Slide Switch, Regulator

X9

It's the cover plate with the X-factor. Shaped like an eye-catching curved TV, the X9 cover plate exhibits the aesthetics of an artistic centerpiece. Mount it on the wall and its curved shape lends this cover plate a floating look that appears ultra premium in any setting. Another unique feature is the raised chrome frame at the centre which elevates the design to a whole new level. Available in a variety of finishes, the X9 is a cover plate that's distinctly a cut above the rest.

Gifa X9 Absolute White Plate with Titanium Grey G-Slide Switch, Key Tag



X9 COVER PLATES WITH MOUNTING FRAMES NEW

PLATES →	2M	3M	4M	6M	8M	8M (V)	12M	16M	18M
COLOURS ↓	MRP ₹	MRP ₹	MRP ₹	MRP ₹	MRP ₹	MRP ₹	MRP ₹	MRP ₹	MRP ₹
Pure Glossy	141.00	188.00	223.00	324.00	382.00	353.00	488.00	571.00	676.00
Metallic	200.00	264.00	317.00	452.00	535.00	494.00	682.00	800.00	946.00
Wood	241.00	317.00	382.00	500.00	606.00	606.00	765.00	912.00	1088.00
CODE →	GF60201	GF60301	GF60401	GF60601	GF60801	GF68801	GF61201	GF61601	GF61801
Outer/Master →	10/400	10/300	10/300	5/150	5/150	5/150	5/120	5/90	5/80
SIZE(mm) →	106x92	130x92	154x92	228x92	254x92	160x168	228x158	254x158	228x222



X9 MOUNTING FRAMES - Horizontal & Vertical Distance for Screwing [Dimensions in mm]

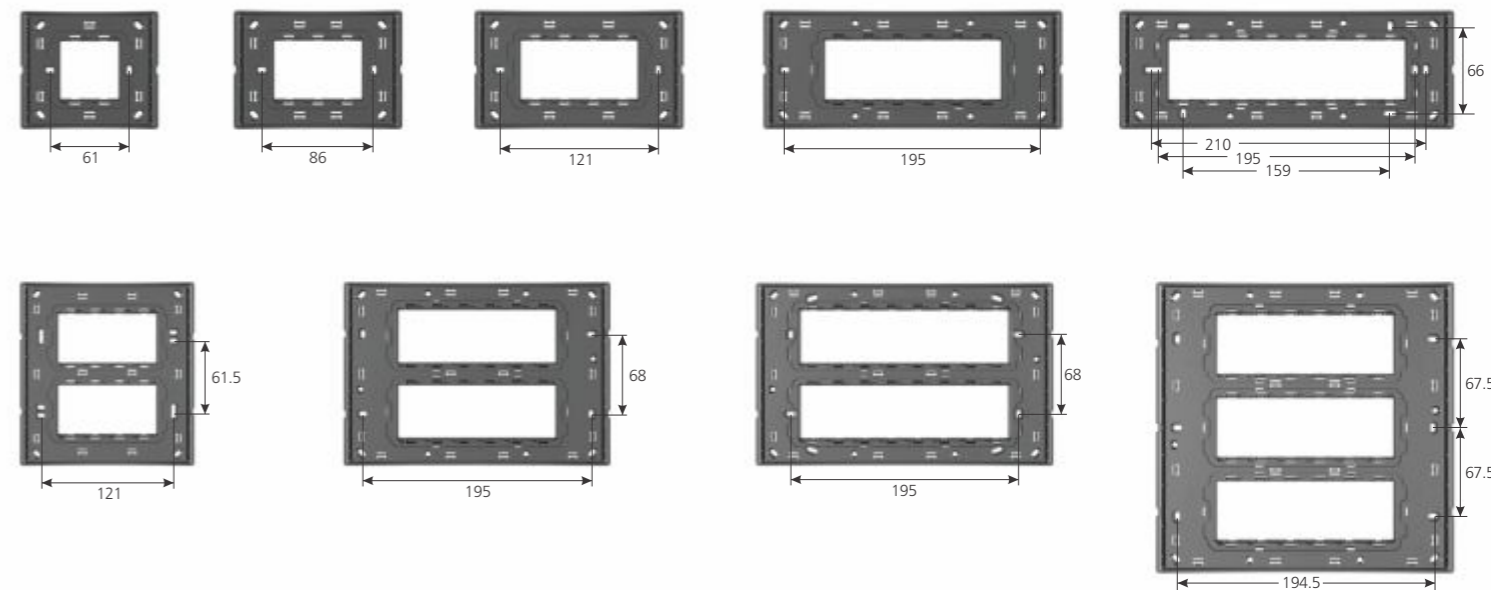

F9
PLATES

DEFINE YOUR WORLD WITH COLOURS

PURE GLOSSY



01 - Absolute White



02 - Black Glossy

METALLIC



06 - Titanium Silver



07 - Titanium Grey



08 - Champagne Gold



09 - Copper Silk



10 - Android Green*



11 - Air Force Blue



12 - Ferrari Red

WOOD



31 - Fuzzy Brown



32 - Dark Apricot



33 - Chocolate Wood

PURE GLOSSY



01 - Absolute White

X9
PLATES

A9
GLASS PLATE



01 - Black Jack



02 - Blue Witch



03 - French Wine



04 - Mountain Dew

* Introducing shortly



From the symbolic to the subliminal, colours shape the world we live in. Seek the colours that speak to you and evoke the feelings that you desire.

More reasons to
welcome with a smile!



HERE
THEY ALL COME
TOGETHER

BUZY  BEE



MAKE
WARM WELCOMES
WARMER!

ADD
ANOTHER
DIMENSION TO YOUR
FOUR WALLS.

GHEXO



THE
SEA HAS
MANY SECRETS.
REVEAL ONE ON
YOUR WALL.

GSHOIL



Say goodbye to dull,
boring doorbells.



THE ULTIMATE
STAR OF
YOUR DECOR.
STAR SPACE



STYLISH HOMES
DESERVE STYLISH
WELCOMES.
ALPHA

ANNOUNCE
YOUR
GUESTS IN STYLE!
BOSMA



DISTINCTIVE
LOOKS.
REMARKABLE
SOUND.
SOUND⁹



More reasons to
welcome with a smile!

GET, SET,
PLUG AND RING!

ULTRA



ULTRA AND
EXO PLUG-IN BELL
REMOTE



EXQUISITE
SOUND
ON EVERY RING.

EXO



WIRELESS
BELLS.
SIMPLY PLUG
AND RING!

GLORIA





203048 203049 203050



203051 203052 203053

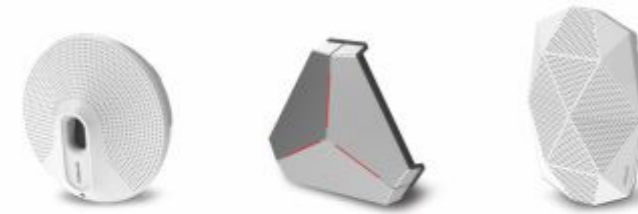

204061 204062 204063



204064 204065 204066



204067 204070 204072



204078 204082 204083

Code	Item	MRP ₹	Pkg.
------	------	-------	------

DING DONG DOOR BELL

203048	Ocean Stereophonic Ding Dong	218.00	5/100
203049	Aqua Stereophonic Ding Dong	218.00	5/100
203050	Snowwhite Stereophonic Ding Dong	218.00	5/100
203051	Belaton Stereophonic Ding Dong	218.00	5/100
203052	Woofer Stereophonic Ding Dong	266.00	5/100
203053	G-Spot Stereophonic Ding Dong	262.00	5/100

ELECTRONIC DOOR BELL NEW

204061*	G-Shell - Polyphonic with selectable tunes & flashing Light	420.00	5/60
204062	G-Space - Polyphonic 4 mode selection - Amitabh songs tunes, Amitabh songs tunes with POD, Big Ben chime, Ding Dong Melody	505.00	5/60
204063	G-Hexo - Piano+Polyphonic 4 mode selection - Hindi midi tune, English midi tune, Big Ben chime, Ding Dong melody	464.00	5/60
204064	G-Oxi - Polyphonic with Selectable Melodies & flashing light 4 mode selection - 28 melodies, 28 melodies & POD, Big Ben, Ding Dong Melody	529.00	5/60
204065	Buzy-Bee - Polyphonic 4 mode selection - Amitabh songs tunes, Amitabh songs tunes with POD, Big Ben chime, Ding Dong Melody	600.00	5/60
204066*	G-Astro - Polyphonic with Selectable Melodies & flashing light 4 mode selection - 28 melodies, 28 melodies & POD, Big Ben, Ding Dong Melody	479.00	5/60

ELECTRONIC DOOR BELL

204067*	Polygon - Single Tunes	375.00	5/60
204070	Welcome - Piano Tunes with flashing Light	491.00	5/60
204072	Pulse - Piano Tunes with flashing Light	491.00	5/60
204078	Zyro (Mp3 Door Bell) In-built 128 MB storage, Pre-Recorded tunes and Melodies, Volume Control & shuffle function Customize & store your own Music. (Supplied with USB Cable for file Transfer)	1299.00	5/60
204082	Red Dot Polyphonic with Selectable Melodies, volume control shuffle function & flashing light 4 mode selection - 28 melodies, 28 melodies & POD, Big Ben, Ding Dong Melody	600.00	5/60
204083	Salsa Polyphonic with Selectable Melodies & flashing light 4 mode selection - 28 melodies, 28 melodies & POD, Big Ben, Ding Dong Melody	567.00	5/60

* introducing shortly

Code	Item	MRP ₹	Pkg.
------	------	-------	------

MANTRA DOOR BELL

204079	Ek Mantra - Gayatri Mantra	383.00	5/60
204080 A	Ekaant - Mantra Bell with 4 selectable mantras & flashing light (4 mode selection - Jain Stuti, Gurubani, Maha Laxmi & Tirupati Balaji Mantra)	479.00	5/60
204080 B	Ekaant - Mantra Bell with 4 selectable mantras & flashing light (4 mode selection - Guru Mantra, Maha Mritunjaya, Ganeshji & Sainath Mantra)	479.00	5/60
204080 C	Ekaant - Mantra Bell with 4 selectable mantras & flashing light (4 mode selection - Sri Krishna, Ding Dong, Azaan & Gayatri Mantra)	479.00	5/60
204080 D	Ekaant - Polyphonic with 4 selectable tune & flashing light	479.00	5/60

WIRELESS DOOR BELLS

204086	Gloria 2 Pin Plug In Wireless with remote, 32 selectable melodies & volume control function with night lamp	1394.00	5/60
204092	Plug In Wireless with remote, 32 selectable melodies, volume control & shuffle function. direct AC (no battery required for bell, battery required only for remote).	1396.00	5/60
204093	G-Flow Wireless with remote, 32 selectable melodies, and flashing light	1408.00	5/60
204094	G-Guide Wireless with remote, 32 selectable melodies, and flashing light	1408.00	5/60



204079 204080A



204080B 204080C



204086 204092



204093 204094

Power, Freedom and Style.



i-Strip LED Spike Guard with Surge Protector

Curvē **plus**

Enjoy real convenience and real freedom by connecting your electrical appliances to where you are – whether it's for work, entertainment or household chores. Available in various design options with the flexibility to connect national and international plugs, these spike guards and power strips ensure you always stay connected and on. So go ahead, unwind and connect everything you need.

Logica Spike Guard with Surge Protector



G-Xpress Spike Guard with Surge Protector

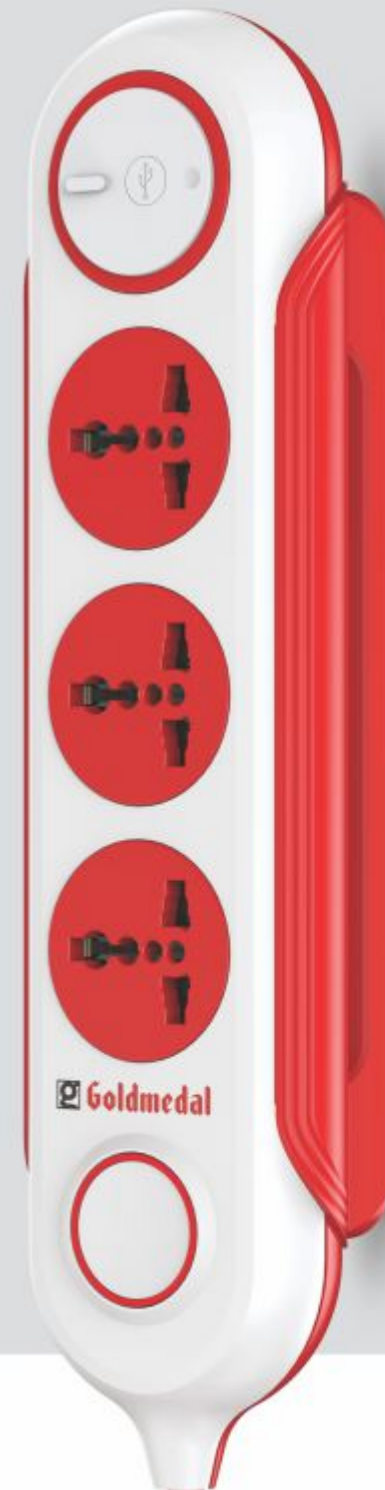



205101



205102



205103



205107



205100



205104



205106



205108

Code	Item	MRP ₹	Pkg.
------	------	-------	------

Outer/Master

HIGH GRADE ADAPTORS 240V~

205101	i-Strip LED Spike Guard 6 Outlet international Socket, Master Switch, Indicator with surge protector - 2 Mtr Cables	1162.00	5/30
--------	---	---------	------

POWER STRIP 240V~

205102	i-Design 4x1 Power Strip 4 Outlet international Socket with Master Switch & Indicator	709.00	5/30
205103	i-Design 4x4 Power Strip 4 Outlet international Socket with Individual Switch & Indicator	1018.00	5/30
205107	i-Design 4x4 Power Strip with USB with 3 Outlet international Socket, Individual Switch, Indicator & Dual USB Port - Output 2100mA. - 2 Mtr Cables	1399.00	5/30

360° HIGH GRADE ADAPTORS 240V~

205100	360° Power Strip 6 Outlet international Socket, Master Switch, Indicator	828.00	5/30
205104	360° Spike Guard 5 Outlet international Socket, Master Switch, Indicator with surge protector	828.00	5/30
205106	360° Spike Guard with USB 4 Outlet international Socket, Master Switch, Indicator with surge protector & Dual USB Port - Output 2100mA. - 2 Mtr Cables	1300.00	5/30

HIGH GRADE ADAPTORS SPIKE GUARD 240V~

NEW

205108	G-Trix 4x1 Spike Guard 4 Outlet international Socket with Master Switch, Indicator & surge protector - 2 Mtr Cables	644.00	5/30
--------	---	--------	------

Code	Item	MRP ₹	Pkg.
------	------	-------	------

Outer/Master

HIGH GRADE ADAPTORS SPIKE GUARD 240V~

NEW

205211	G-Xpress 4x1 Spike Guard 4 Outlet international Socket with Master Switch, Indicator & surge protector	790.00	5/30
205212	G-Xpress 4x1 Spike Guard with USB 3 Outlet international Socket, with Master Switch, Indicator & Dual USB Port - Output 2100mA. with surge protector	1499.00	5/30
205213*	Logica 4x1 Spike Guard 4 Outlet international Socket with Master Switch, Indicator & surge protector - 2 Mtr Cables	690.00	5/30



ESSENZA POWER STRIP 240V~

09207	Plugged-IN 4x4 Power Strip with USB outlet with 2 Mtrs Cable 3 outlet international sockets & Dual USB charger with individual switch & indicator	1299.00	5/30
09208	Plugged-IN 4x1 Power Strip 4 Outlet Socket Adapter with 2 Mtrs Cable master switch, indicator & international socket	699.00	5/30
09209	Plugged-IN 4x4 Power Strip 4 Outlet Socket Adapter with 2 Mtrs Cable individual switch, indicator & international socket	995.00	5/30
09210	Plugged-IN 4x1 Power Strip 4 Outlet Socket Adapter with 5 Mtrs Cable master switch, indicator & international socket	918.00	5/30



ESSENZA SPIKE GUARD 240V~

09211	Plugged-IN 6x1 Spike Guard 6 Outlet Socket Adapter master switch, indicator, Surge Protector & international socket - 2 Mtr Cables	1057.00	5/30
-------	--	---------	------



205211



205212



205213



09207



09208



09209



09211

Connecting devices. Safeguarding lives.

International Socket
with safety shutter

Power Indicator

High Grade Brass parts



Heavy Duty
Power Cord

Ultra Smooth
Rotation

Infino Extension Cord
with International Socket and
safety shutter



Krysta Extension Cord
with International Socket and
safety shutter





Code	Item	MRP ₹	Pkg.
2 PIN EXTENSION CORD WITH HANDLE			
205116	Sliq 2 Pin 5 Mtr Cable with handle, indicator & international socket	455.00	5/60
205118	Quord 2 Pin 5 Mtr Cable with handle, indicator & international socket	456.00	5/60
205126	G-Expert 2 Pin 5 Mtr Cable with handle, indicator & international socket	511.00	5/60

Code	Item	MRP ₹	Pkg.
3 PIN EXTENSION CORD WITH HANDLE			
205117	Sliq 3 Pin 4 Mtr Cable with handle, indicator & international socket	564.00	5/60
205119	Quord 3 Pin 4 Mtr Cable with handle, indicator & international socket	586.00	5/60
205127	G-Expert 3 Pin 4 Mtr Cable with handle, indicator & international socket	658.00	5/60

Code	Item	MRP ₹	Pkg.
2 PIN EXTENSION CORD WITHOUT HANDLE			
205120	Dazzle 2 Pin 5 Mtr Cable with indicator & international socket	424.00	5/60
205122	Twister 2 Pin 5 Mtr Cable with indicator & international socket	421.00	5/60
205124	G-Smart 2 Pin 5 Mtr Cable Indicator & international socket	440.00	5/60
205128	G-Dial 2 Pin 5 Mtr Cable with indicator & international socket	424.00	5/60
205133	Gio 2 Pin 2.5 Mtr Cable with indicator & international socket	362.00	5/60
205135	Krysta 2 Pin 5 Mtr Cable with indicator & 2 international socket NEW	524.00	5/60
205138	Plano 2 Pin 5 Mtr Cable with indicator & international socket	486.00	5/60
205140	Infino 2 Pin 5 Mtr Cable with indicator & 2 international socket NEW	571.00	5/60

Code	Item	MRP ₹	Pkg.
3 PIN EXTENSION CORD WITHOUT HANDLE			
205121	Dazzle 3 Pin 4 Mtr Cable with indicator & international socket	528.00	5/60
205123	Twister 3 Pin 4 Mtr Cable with indicator & international socket	545.00	5/60
205125	G-Smart 3 Pin 4 Mtr Cable with indicator & international socket	580.00	5/60
205129	G-Dial 3 Pin 4 Mtr Cable with indicator & international socket	529.00	5/60
205134	Gio 3 Pin 1.5 Mtr Cable with indicator & international socket	430.00	5/60
205136	Krysta 3 Pin 4 Mtr Cable with indicator & 2 international socket NEW	605.00	5/60
205139	Plano 3 Pin 4 Mtr Cable with indicator & international socket	626.00	5/60
205141	Infino 3 Pin 4 Mtr Cable with indicator & 2 international socket NEW	638.00	5/60

Code	Item	MRP ₹	Pkg.
HIGH GRADE 16A EXTENSION CORD			
205131	Twister 16A 3 Pin 3.5 Mtr Cable with 6/16A uni. socket, international socket, 2 Pin socket & Indicator	1008.00	5/30
205132	G-Expert 16A 3 Pin 3.5 Mtr Cable with 6/16A uni. socket, international socket, 2 Pin socket, Indicator & Tripper	1074.00	5/30

Code	Item	MRP ₹	Pkg.
DECORATIVE WIRE LINK			
205149	Decorative Wire Link 5 Mtr Cable with 2 pin plug & pendant holder	227.00	5/60

Code	Item	MRP ₹	Pkg.
ESSENZA EXTENSION CORDS 240V~			
09201	Flexi 2 Pin 5 Mtr Cable master switch, indicator & international socket	421.00	5/60
09202	Flexi 2 Pin 7.5 Mtr Cable master switch, indicator & international socket	533.00	5/60
09203	Flexi 3 Pin 4 Mtr Cable master switch, indicator & international socket	533.00	5/60





206151

206152

Code	Item	MRP ₹	Pkg.
LED NIGHT LAMPS			
206151	Hot Shot Night Lamp with LED	103.00	10/300
206152	Desire Night Lamp with LED	94.00	10/300
Available colour: Blue, Yellow & Orange			



206161

206162

206163

EDGE GLOW LED / NIGHT LAMPS			
206161	Divine Glow - Shri Parashwanath edge glow night lamp with LED	150.00	10/300
206162	Divine Glow - Lord Ganesha edge glow night lamp with LED	150.00	10/300
206163	Divine Glow - Maha Laxmi edge glow night lamp with LED	150.00	10/300
206164	Divine Glow - Tirupati Balaji edge glow night lamp with LED	150.00	10/300
206165	Divine Glow - Guru Nanak edge glow night lamp with LED	150.00	10/300
206166	Divine Glow - Azaan edge glow night lamp with LED	150.00	10/300
206169	G-Focus Night Lamp G-focus night lamp with LED	235.00	10/300
206170 A	G-Divine Shri Parashwanath edge glow night lamp with LED	NEW 180.00	5/100
206170 B	G-Divine Lord Ganesha edge glow night lamp with LED	NEW 180.00	5/100
206170 C	G-Divine Maha Laxmi edge glow night lamp with LED	NEW 180.00	5/100
206170 D	G-Divine Tirupati Balaji edge glow night lamp with LED	NEW 180.00	5/100
206170 E	G-Divine Guru Nanak edge glow night lamp with LED	NEW 180.00	5/100
206170 F	G-Divine Azaan edge glow night lamp with LED	NEW 180.00	5/100



203164

203165

206169



206170 A

206170 B

206170 C



206170 D

206170 E

206170 F



06325

06326

SELF ADHESIVE PVC ELECTRICAL INSULATION TAPE			
06325	PVC Electrical Insulation Tap Size: 0.13mm x 18mm x 7mtr.	20.00	30/600
06326	PVC Electrical Insulation Tap Size: 0.125mm x 17mm x 6mtr.	17.00	30/600

More ways to power your dreams!



Gzifa Angle Holder
Advanced interlock configuration

Ecco Batten Holder
Advanced interlock configuration

Ecco Angle Holder
Advanced interlock configuration



Code	Item	MRP ₹	Pkg.
PLUG TOPS 240V~			
202021	6A 2 Pin plug LDS System & safe gripper	32.00	20/1200
202022	G-mint 6A 2 Pin plug LDS System & safe gripper	36.00	20/1200
202024	G-mint 6A 2 Pin Male Female LDS System & safe gripper	63.00	20/800

Code	Item	MRP ₹	Pkg.
PLUG TOPS 240V~			
202026	Avian 6A 3 Pin Plug LDS System & safe gripper	75.00	20/600
202027	Avian 16A 3 Pin Plug LDS System & safe gripper	95.00	10/300
202028	Fusion 6A 3 Pin Plug LDS System & safe gripper	78.00	20/600
202029	Fusion 16A 3 Pin Plug LDS System & safe gripper	98.00	10/300
202030	G-grip 6A 3 Pin Plug with LED LDS System & safe gripper	87.00	20/600
202031	G-grip 16A 3 Pin Plug with LED LDS System & safe gripper	102.00	10/300

Code	Item	MRP ₹	Pkg.
UNIVERSAL TRAVEL ADAPTOR 240V~			
202037	i-Link 16A 3 Pin Universal Travel Adaptor with Mobile Socket	205.00	10/120
202038	Sliq 2 Pin Conversion plug	28.00	30/1200
202039	Sliq 3 Pin Universal Travel Adaptor with Indicator*	87.00	20/300
202042	Spice 3 Pin Universal Travel Adaptor with Indicator	145.00	10/300
202043	G-cube 2 Pin Universal Travel Adaptor with surge protector	71.00	20/300
202044	G-dot 2 Pin Universal Travel Adaptor with surge protector	71.00	20/300
202045	G-cube 2 Pin Universal Travel Adaptor	61.00	20/300
202046	G-dot 2 Pin Universal Travel Adaptor	61.00	20/300
202047	Genius USB Travel Adaptor 2 USB Port with 3 International Plug * Suitable for all kinds of plugs used around the world	973.00	10/120
202048	Auro Travel Charger Input: 100-240V~50/60Hz 0.8A 36W Total Output Auto ID 1(18W max) Output: 5V 3A 9V 2A 12V 1.5A USB+Type-C Output: 5V 3A Auto ID 2(18W max) Output: 5V 3A 9V 2A 12V 1.5A USB+Type-C Output: 5V 3A Quick Charge 3.0+PD	NEW 2499.00	01/30
202049	USB Multiplug Travel Adaptor Dual USB with International Socket	NEW 450.00	10/120

Code	Item	MRP ₹	Pkg.
LAMP HOLDER 240V~			
201001	Oro Angle Holder Advanced interlock configuration	75.00	20/400
201002	Oro Batten Holder Advanced interlock configuration	75.00	20/400
201003	Ecco Angle Holder Advanced interlock configuration	77.00	20/400
201004	Ecco Batten Holder Advanced interlock configuration	77.00	20/400
201005	Angle Holder Advanced interlock configuration	63.00	20/400
201006	Batten Holder Advanced interlock configuration	63.00	20/400
201007	Jumbo Batten Holder Advanced interlock configuration	75.00	20/400
201008	Ecco Gama Batten Holder Advanced interlock configuration	90.00	20/400
201010	Gzifa Angle Holder Advanced interlock configuration	81.00	20/400
201011	Gzifa Batten Holder Advanced interlock configuration	81.00	20/400
201012	Oval Angle Holder Advanced interlock configuration	106.00	10/300
201013	Oval Batten Holder Advanced interlock configuration	106.00	10/300
201009	Glassio Angle Holder Advanced interlock configuration	99.00	10/300
201014	Glassio Batten Holder Advanced interlock configuration	99.00	10/300
201019	Euro Angle Holder Advanced interlock configuration	114.00	10/300
201020	Euro Batten Holder Advanced interlock configuration	114.00	10/300

Code	Item	MRP ₹	Pkg.
CEILING ROSE 240V~			
201016	Pilot Ceiling Rose Auto safe lock	48.00	20/600
201017	Jumbo Ceiling Rose Auto safe lock	58.00	20/400
201018	Glassio Ceiling Rose Auto safe lock	72.00	20/400

Code	Item	MRP ₹	Pkg.
GIFA LAMP HOLDER / CEILING ROSE 240V~			
GF02103	Igloo Angle Holder (Metal) Advanced interlock configuration	76.00	20/400
GF02104	Igloo Batten Holder (Metal) Auto safe lock	76.00	20/400
GF02116	Pilot Ceiling Rose Auto safe lock	48.00	20/600
GF02117	Jumbo Ceiling Rose Auto safe lock	58.00	20/400





Code	Item	MRP ₹	Pkg.
Outer/Master			
HEALTH CARE - INFRARED THERMO SCAN NEW			
GOL8001	Infrared Thermo Scan <ul style="list-style-type: none"> • Infrared Technology • One Second Temp. Measurement • Contactless • No Lens Harm • Memory Function 	2940.00	1/50
HEALTH CARE - MAGIC MIST NEW			
GOL8002	Magic Mist <ul style="list-style-type: none"> • Energy Saving & Environmental Protection • Microporous Spray • Motion Sensor • Infrared Induction • Intelligent Chip 	1799.00	1/50
HEALTH CARE - G-SCAN NEW			
GOL8003	G - Scan <ul style="list-style-type: none"> • Energy Saving & Environmental Protection • UVC Sanitizer • USB Charge 	2280.00	1/50

The power to create a safer world!



Infrared Thermo Scan
Infrared Technology

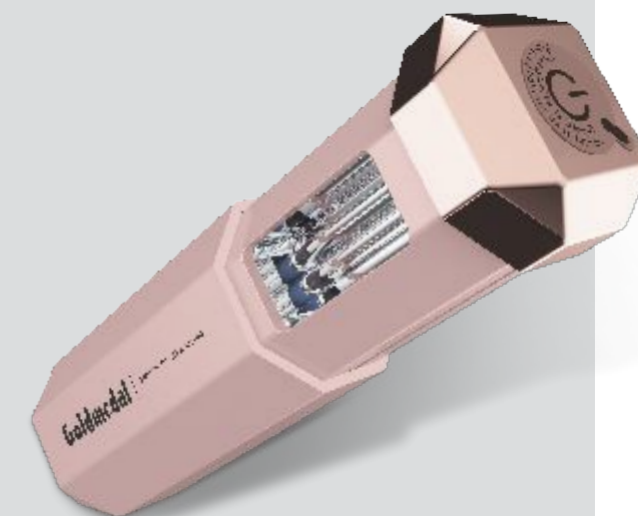

G - Scan
Touch-free sanitization.



Magic Mist
Fight off the germs with ease!



Add a bit of the natural world to your interiors with these cover plates in wood accents. Whether it's light or dark wood, adding a bit of this wondrous material makes any interior feel warmer and inviting. The African Wenge wood cover plate has a majestic, luxurious appeal to it while the Fumed Oak and Rose Wood cover plates are modern and cheerful in their appearances. Combine them with the inserts of your choice to create that distinctive look for your interiors.





Code	Item	MRP ₹		Pkg.
		White	Digital Silver Carbon Grey	
10AX SWITCHES / 6A INDICATOR				
GF 14101	1 Way Switch	18.00	20.00	20/1200
GF 14102	2 Way Switch	30.00	33.00	20/1200
GF 14103	Bell Push Switch	30.00	33.00	20/1200
GF 14104	Indicator (LED)	30.00	33.00	20/1200
6AMP BELL PUSH 240V~				
GF 14116	Bell Push with Luminous Name Plate 240V- 50-60Hz LED circuit with diffuser	132.00	146.00	10/600
6A & 10A SOCKETS / 13A INTERNATIONAL SOCKET				
GF 14118	6A 2 Pin Socket with safety shutter	33.00	36.00	20/600
GF 14119	10A 2 In One Socket	39.00	43.00	10/600
GF 14120	6A 3 Pin Socket (2M) with safety shutter	39.00	43.00	10/600
GF 14121	10A International Socket with safety shutter	58.00	63.00	10/600
TV ANTENNA SOCKETS				
GF 14125	Mini TV Antenna Socket with card-grip configuration	48.00	53.00	20/1200
GF 14126	Medium TV Antenna Socket with card-grip configuration	51.00	56.00	20/1000
ELECTRONIC DIMMER / GALAXY REGULATOR 240V~				
GF 14129	300W Mini Dimmer	170.00	187.00	10/600
GF 14130	300W Medium Dimmer	185.00	203.00	10/300
GF 14131	EME 4 Step Fan Regulator	260.00	285.00	10/600
GF 14132	Galaxy 5 Step Fan Regulator - Full Rotary	285.00	315.00	10/300
GF 14133	Galaxy 5 Step Fan Regulator - Half Rotary	285.00	315.00	10/300
GALAXY REGULATOR WITH CHROME KNOB 240V~				
GF 14134	Galaxy 5 Step Fan Regulator - Full Rotary	295.00	325.00	10/300
GF 14135	Galaxy 5 Step Fan Regulator - Half Rotary	295.00	325.00	10/300

Code	Item	MRP ₹		Pkg.
		White	Digital Silver Carbon Grey	
RJ-11 TELEPHONE JACK / RJ-45 MODEM JACK				
GF 14138	RJ-11 2 Line Telephone Jack	70.00	77.00	20/1200
GF 14139	RJ-11 4 Line Telephone Jack	94.00	103.00	10/600
GF 14140	RJ-45 Outlet for Computer (Cat 6e) Category 6e, Universal wiring T568A, insulating-piercing terminal	240.00	264.00	10/600
KIT-KAT FUSE / LED NIGHT LAMP				
GF 14144	Kit-Kat Fuse (Suitable for both 10A & 16A)	57.00	62.00	10/600
GF 14150	Night Lamp (LED)	132.00	145.00	10/600
10AMP SWITCH SOCKET COMBINED 240V~				
GF 14151*	10A Switch Socket Combined (with indicator)	72.00	78.00	5/200
GF 14152*	10A Switch Socket Combined with Junction Box (with indicator)	94.00	102.00	10/200
20AMP SWITCHES / GAMA SWITCHES 240V~				
GF 14153	20A 1 Way Switch	99.00	109.00	10/300
GF 14154	20A 2 Way Switch	112.00	122.00	10/300
GF 14155	20A Gama 1 Way Switch with indicator	112.00	122.00	10/300
GF 14156	20A Gama 2 Way Switch	133.00	146.00	10/300
10AX GAMA BELL PUSH / 6&16A SOCKET 240V~				
GF 14157	10AX Gama Bell Push with indicator	82.00	90.00	10/300
GF 14158	6&16A Universal Socket with safety shutter	105.00	115.00	10/300
32AMP DP SWITCH 240V~				
GF 14161	32AMP DP Switch with indicator	180.00	198.00	10/300

*introducing shortly





Code	Item	MRP ₹		Pkg.
		White	Digital Silver Carbon Grey	
6&16A 3 IN ONE COMBINED 240V~				
GF 14165	6&16A 3 In One Switch Socket Combined	191.00	210.00	5/150
GF 14166	6&16A 3 In One Switch Socket Combined with junction box with safety shutter	220.00	240.00	5/150

Code	Item	MRP ₹		Pkg.
		White	Digital Silver Carbon Grey	
6&16A 5 IN ONE COMBINED 240V~				
GF 14167	6&16A 5 In One Switch Socket Combined with fuse & indicator	239.00	260.00	5/100
GF 14168	6&16A 5 In One Combined with junction box with safety shutter	275.00	302.00	5/100

Code	Item	MRP ₹		Pkg.
		White	Digital Silver Carbon Grey	
10AX SWITCH COVER PLATES				
GF 14175	Platina	4.25		100/8000
GF 14176	Metaliq	6.75		100/8000
GF 14177	Wood	7.25		100/8000
SUITABLE FOR : 10AX Switches, Indicator, Mini Jack, Mini Dimmer, Mini Step Regulator & Fuse Unit etc.				

Code	Item	MRP ₹		Pkg.
		White	Digital Silver Carbon Grey	
10A SOCKET COVER PLATES				
GF 14181	Platina	5.75		100/6000
GF 14182	Metaliq	8.50		100/6000
GF 14183	Wood	9.25		100/6000
SUITABLE FOR : 10A Sockets, Bell Push, Night Lamp, Med Dimmer, 5 Step Regulator & 4 Line Telephone Jack etc.				

Code	Item	MRP ₹		Pkg.
		White	Digital Silver Carbon Grey	
10A S S COMBINED COVER PLATES				
GF 14184*	Platina	25.00		50/1200
GF 14185*	Metaliq	32.00		50/1200
GF 14186*	Wood	36.00		50/1200
SUITABLE FOR : 10 Switch Socket Combined				

Code	Item	MRP ₹		Pkg.
		White	Digital Silver Carbon Grey	
20A SWITCH COVER PLATES				
GF 14187	Platina	17.50		50/3000
GF 14188	Metaliq	24.00		50/3000
GF 14189	Wood	27.00		50/3000
SUITABLE FOR : 20A Switches				

Code	Item	MRP ₹		Pkg.
		White	Digital Silver Carbon Grey	
16A SOCKET COVER PLATES				
GF 14193	Platina	20.00		50/2400
GF 14194	Metaliq	27.00		50/2400
GF 14195	Wood	30.00		50/2400
SUITABLE FOR : 20A Gama Switch, 10AX Gama Bell Push & 32A DP Switch etc.				

Code	Item	MRP ₹		Pkg.
		White	Digital Silver Carbon Grey	
3 IN ONE COVER PLATES				
GF 14199	Platina	29.00		25/1500
GF 14200	Metaliq	37.00		25/1500
GF 14201	Wood	41.00		25/1500
SUITABLE FOR : 3 In One Combined				

Code	Item	MRP ₹		Pkg.
		White	Digital Silver Carbon Grey	
5 IN ONE COVER PLATES				
GF 14205	Platina	39.00		25/1200
GF 14206	Metaliq	52.00		25/1200
GF 14207	Wood	60.00		25/1200
SUITABLE FOR : 5 In One Combined				

AVAILABLE COLOURS IN BASE :
Digital Silver, White Jazz & Carbon Grey

*introducing shortly



AVAILABLE COLOURS IN PLATES
Platina : White Jazz & Ivory
MetaliQ : Gold, Digital Silver, Olive Green & Copper Cola
wood : Fumed Oak, African Wenge & Rose Wood



BREAK
AWAY
FROM THE
PAST.
SWITCH
TO THE
FUTURE!



There comes a time when the tide changes. When the old makes for the new. Gzifa marks the beginning of this transition in the world of mini modular switches and accessories.

With its radical new styling and a host of exciting features, Gzifa promises to be the new benchmark in mini modular products.

Gzifa. It's a sign of the changing times.



Code	Item	MRP ₹		Pkg.
		White/Grey	Digital Silver	
10AX SWITCHES / 6A INDICATOR				
14101	1 Way Switch	18.00	20.00	20/1200
14102	2 Way Switch	30.00	33.00	20/1200
14103	Bell Push Switch	30.00	33.00	20/1200
14104	Indicator (LED)	30.00	33.00	20/1200
6AMP BELL PUSH 240V~				
14116	Bell Push with Luminous Name Plate 240V~ 50-60Hz LED circuit with diffuser	132.00	146.00	10/600
6A & 10A SOCKETS / 13A INTERNATIONAL SOCKET				
14118	6A 2 Pin Socket with safety shutter	33.00	36.00	20/1200
14119	10A 2 In One Socket	39.00	43.00	10/600
14120	6A 3 Pin Socket (2M) with safety shutter	39.00	43.00	10/600
14121	10A International Socket with safety shutter	58.00	63.00	10/600
TV ANTENNA SOCKETS				
14125	Mini TV Antenna Socket with card-grip configuration	48.00	53.00	20/1200
14126	Medium TV Antenna Socket with card-grip configuration	51.00	56.00	20/1000
ELECTRONIC DIMMER / REGULATOR 240V~				
14129	300W Mini Dimmer	170.00	187.00	10/600
14130	300W Medium Dimmer	185.00	203.00	10/300
14131	EME 4 Step Fan Regulator	260.00	285.00	10/600
14132	EME 5 Step Fan Regulator - Regulator Supplied in ISI & Non ISI	285.00	315.00	10/300
RJ-11 TELEPHONE JACK / RJ-45 MODEM JACK				
14138	RJ-11 2 Line Telephone Jack	70.00	77.00	20/1200
14139	RJ-11 4 Line Telephone Jack	94.00	103.00	10/600
14140	RJ-45 Outlet for Computer (Cat 6e) Category 6e, Universal wiring T568A, insulating-piercing terminal	240.00	264.00	10/600
KIT-KAT FUSE / LED NIGHT LAMP				
14144	Kit-Kat Fuse (Suitable for both 10A & 16A)	57.00	62.00	10/600
14150	Night Lamp (LED)	132.00	145.00	10/600

Code	Item	MRP ₹		Pkg.
		White/Grey	Digital Silver	
10AMP SWITCH SOCKET COMBINED 240V~				
14151	10A Switch Socket Combined (with indicator)	72.00	78.00	10/200
14152	10A Switch Socket Combined with Junction Box (with indicator)	94.00	102.00	10/200
20AMP SWITCHES / GAMA SWITCHES 240V~				
14153	20A 1 Way Switch	99.00	109.00	10/300
14154	20A 2 Way Switch	112.00	122.00	10/300
14155	20A Gama 1 Way Switch with indicator	112.00	122.00	10/300
14156	20A Gama 2 Way Switch	133.00	146.00	10/300
10AX GAMA BELL PUSH / 6&16A SOCKET 240V~				
14157	10AX Gama Bell Push with indicator	82.00	90.00	10/300
14158	6&16A Universal Socket with safety shutter	105.00	115.00	10/300
32AMP DP SWITCH 240V~				
14161	32AMP DP Switch with indicator	180.00	198.00	5/300
6&16A 3 IN ONE COMBINED 240V~				
14165	6&16A 3 In One Switch Socket Combined	191.00	210.00	5/150
14166	6&16A 3 In One Switch Socket Combined with junction box with safety shutter	220.00	240.00	5/150
6&16A 5 IN ONE COMBINED 240V~				
14167	6&16A 5 In One Switch Socket Combined with fuse & indicator	239.00	260.00	5/100
14168	6&16A 5 In One Combined with junction box with safety shutter	275.00	302.00	5/100





AVAILABLE COLOURS IN PLATES

Platina : White Jazz & Ivory
MetalIQ : Gold, Digital Silver, Forest Green, Copper Cola, Dark Night & Pearl Grey
wood : Fumed Oak, African Wenge & Rose Wood

Note: The wood cover plates may differ in their shades as they reflect a natural look.

Code	Item	MRP ₹	Pkg.
Outer/Master			
10AX SWITCH COVER PLATES			
14175	Platina	4.25	100/8000
14176	MetalIQ	6.75	100/8000
14177	Wood	7.25	100/8000
SUITABLE FOR: 10AX Switches, Indicator, Mini Jack, Mini Dimmer, Mini Step Regulator & Fuse Unit etc.			
10A SOCKET COVER PLATES			
14181	Platina	5.75	100/6000
14182	MetalIQ	8.50	100/6000
14183	Wood	9.25	100/6000
SUITABLE FOR : 10A Sockets, Bell Push, Night Lamp, Med Dimmer, 5 Step Regulator & 4 Line Telephone Jack etc.			
10A S S COMBINED COVER PLATES			
14184	Platina	25.00	50/1200
14185	MetalIQ	32.00	50/1200
14186	Wood	36.00	50/1200
SUITABLE FOR : 10A Switch Socket Combined			
20A SWITCH COVER PLATES			
14187	Platina	17.50	50/3000
14188	MetalIQ	24.00	50/3000
14189	Wood	27.00	50/3000
SUITABLE FOR : 20A Switches			
16A SOCKET COVER PLATES			
14193	Platina	20.00	50/2400
14194	MetalIQ	27.00	50/2400
14195	Wood	30.00	50/2400
SUITABLE FOR : 20A Gama Switch, 10AX Gama Bell Push & 32A DP Switch etc.			
3 IN ONE COVER PLATES			
14199	Platina	29.00	25/1500
14200	MetalIQ	37.00	25/1500
14201	Wood	41.00	25/1500
SUITABLE FOR : 3 In One Combined			
5 IN ONE COVER PLATES			
14205	Platina	39.00	25/1200
14206	MetalIQ	52.00	25/1200
14207	Wood	60.00	25/1200
SUITABLE FOR : 5 In One Combined			
AVAILABLE COLOURS IN BASE : Digital Silver, White Jazz & Monsoon Grey			



More choices for elegant homes.

Essenza presents economy polycarbonate switches and accessories in three pleasing options: Vanilla, iCube and Valley. Designed without compromise in a rich, off-white shade, these options can be the ideal choice for elegant homes. The Vanilla switches with their distinct rounded shape presents a gentle profile while iCube and Valley, with their angular shapes, make a classical yet stylish statement.

essenza
Switches Redefined

Manufactured from polycarbonate by SABIC Innovative Plastic USA





Code	Item	MRP ₹	
		White Brown Sugar	Outer/ Master
ESSENZA 10AX VANILLA SWITCHES			
09101	1 Way Switch	28.00	20/1200
09102	2 Way Switch	39.00	20/1200
09103	Bell Push	39.00	20/1200
09104	Indicator	39.00	20/1200
ESSENZA 10AX iCUBE SWITCHES			
09105	1 Way Switch	27.00	20/1200
09106	2 Way Switch	36.00	20/1200
09107	Bell Push	36.00	20/1200
09108	Indicator	36.00	20/1200
ESSENZA 10AX VALLEY SWITCHES			
09109	1 Way Switch	27.00	20/1200
09110	2 Way Switch	36.00	20/1200
09111	Bell Push	36.00	20/1200
09112	Indicator	36.00	20/1200
ESSENZA 6A / 10A SOCKETS			
09124	2 Pin Socket with safety shutter	39.00	20/1200
09125	6A 2 In 1 Socket	48.00	10/600
09126	10A Inte. Socket with safety shutter	71.00	10/600
09127	6A 5 Pin Socket	56.00	10/600
09128	6A 3 Pin Socket (2M) with safety shutter	46.00	10/600
ESSENZA TV SOCKETS			
09130	Mini TV Socket	50.00	20/1200
09131	Medium TV Socket	51.00	20/800
ESSENZA DIMMER / REGULATOR			
09134	Mini Dimmer	249.00	10/600
09135	Medium Dimmer	266.00	10/300
09136	4 Step Regulator	336.00	10/600
09137	5 Step Regulator	375.00	10/300
- Regulator Supplied in ISI & Non ISI			

Code	Item	MRP ₹	
		White Brown Sugar	Outer/ Master
ESSENZA G-STAR DIMMER / REGULATOR			
09138	G-star Medium Dimmer	264.00	10/300
09139	G-star 4 Step Regulator	340.00	10/600
09140	G-star 5 Step Regulator	375.00	10/300
- Regulator Supplied in ISI & Non ISI			
ESSENZA TEL. JACK / KIT-KAT FUSE			
09143	Mini Tel Jack	84.00	20/1200
09144	Medium 4 Line Tel Jack	84.00	20/800
09147	Kit-Kat Fuse (Suitable for both 10A & 16A)	67.00	20/800
ESSENZA 6A / 10A S. S. COMBINED			
09151	10A 8x1 S.S.Combined with Indicator (with junction box)	270.00	5/100
09152	10A S.S.Combined with Indicator	95.00	10/200
09153	10A S.S.Combined with Indicator (with junction box)	127.00	10/200
ESSENZA NANO 20A SWITCH (PORCELAIN BASE)			
09154	Nano 20A 1 Way Switch	123.00	10/200
09155	Nano 20A 2 Way Switch with Porcelain Base	142.00	10/200
ESSENZA 20A SWITCH / 16A SOCKET (PORCELAIN BASE)			
09156	20A 1 Way Switch	133.00	10/200
09157	20A 2 Way Switch	153.00	10/200
09158	20A Gama Switch with Indicator	152.00	10/200
09159	20A Gama 2 Way Switch	174.00	10/200
09160	Gama 10A Bellpush with Indicator	112.00	10/200
09161	6 & 16A Universal Socket with safety shutter & Porcelain Base	135.00	10/200
ESSENZA SURFACE GANG BOXES / 32A DP SWITCH			
09164	16A Surface Box (Suitable for Switch/Socket/DP/Gama Switch)	39.00	10/200
09174	32A DP Switch with Indicator with Porcelain Base	236.00	10/200





Code	Item	MRP ₹	Pkg.
		White Brown Sugar	Outer/ Master
ESSENZA 3 IN 1 COMBINED (PORCELAIN BASE)			
09178	3 In 1 S.S. Combined with safety shutter	204.00	5/150
09179	3 In 1 S.S. Combined with Junction Box (with safety shutter)	255.00	5/150
ESSENZA 5 IN 1 COMBINED (PORCELAIN BASE)			
09183	5 In 1 S.S. Combined with Fuse & Indicator with safety shutter	251.00	5/80
09184	5 In 1 S.S. Combined with Fuse, Indicator & Junction Box with safety shutter	310.00	5/80
ESSENZA NANO 20A SWITCH			
09154A	Nano 20A 1 Way Switch	129.00	10/200
09155A	Nano 20A 2 Way Switch	149.00	10/200
ESSENZA 20A SWITCH / 16A SOCKET			
09156A	20A 1 Way Switch	129.00	10/200
09157A	20A 2 Way Switch	149.00	10/200
09158A	20A Gama Switch with Indicator	150.00	10/200
09159A	20A Gama 2 Way Switch	172.00	10/200
09160A	Gama 10A Bellpush with Indicator	111.00	10/200
09161A	6 & 16A Universal Socket with safety shutter	135.00	10/200
ESSENZA SURFACE GANG BOXES / 32A DP SWITCH			
09164A	16A Surface Box (Suitable for Switch/Socket/DP/Gama Switch)	41.00	10/200
09174A	32A DP Switch with Indicator	236.00	10/200
ESSENZA 3 IN 1 COMBINED			
09178A	3 In 1 S.S. Combined with safety shutter	204.00	5/150
09179A	3 In 1 S.S. Combined with Junction Box (with safety shutter)	254.00	5/150

Code	Item	MRP ₹	Pkg.
		White Brown Sugar	Outer/ Master
ESSENZA 5 IN 1 COMBINED			
09183A	5 In 1 S.S. Combined with Fuse & indicator (with safety shutter)	251.00	5/80
09184A	5 In 1 S.S. Combined with Fuse, Indicator & Junction Box (with safety shutter)	310.00	5/80
ESSENZA 6 IN 1 COMBINED			
09185	6 In 1 S.S. Combined with Fuse & indicator with safety shutter	298.00	5/90
09186	6 In 1 S.S. Combined with Fuse, Indicator & Junction Box (with safety shutter)	359.00	5/90
ESSENZA LAMP HOLDER			
09188	Angle Holder	55.00	20/400
09189	Batten Holder	55.00	20/400
	Advanced interlock configuration		
ESSENZA BED SWITCH			
09190	Bed Switch	57.00	20/1200
09191	Skirt Pendant Holder	41.00	30/600
	Advanced interlock configuration		
ESSENZA CEILING ROSE			
09192	Pilot Ceiling Rose (3 parts)	46.00	20/600
09193	Jumbo Ceiling Rose	56.00	20/400
	Auto safe lock		
ESSENZA 32A VANILLA D. P. SWITCH			
09195	Surface D. P. Switch With Indicator (Unbreakable)	248.00	5/100
09196	Flush D. P. Switch With Indicator (Unbreakable)	248.00	5/100
09197	Nano Surface D. P. Switch With Indicator	232.00	5/100



gazelle
WOOD PLATES



Gazelle Wood panels provide all the flexibility you need to install switches and other electrical modules. Its snap - fix frame is easy to use and available in three colors to match your interiors. Designed for durability, the Gazelle Wood panels deliver outstanding performance and reliability.



GAZELLE WOOD PLATE - SUITABLE FOR WOODEN BOXES

Gazelle Wood Plate	NEW		NEW		4.5 x 7.5	4.5 x 8.5	4.5 x 10.5	4.5 x 12.5
	4.5 x 4.5	5 x 5	4.5 x 6.5	5 x 7				
COLOURS ↓	MRP Rs. (₹)	MRP Rs. (₹)	MRP Rs. (₹)	MRP Rs. (₹)	MRP Rs. (₹)	MRP Rs. (₹)	MRP Rs. (₹)	MRP Rs. (₹)
PLATINA	52.00	58.00	70.00	83.00	83.00	95.00	131.00	143.00
METALIQ	73.00	80.00	100.00	116.00	116.00	132.00	158.00	185.00
CODE →	14229	14236	14230	14240	14235	14231	14232	14233
Outer / Master →	10/360	10/360	10/360	10/180	10/180	10/180	10/120	10/120

Gazelle Wood Plate	4.5 x 15.5	6.5 x 8.5	6.5 x 10.5	6.5 x 12.5	7.5 x 10.5	8.5 x 10.5	8.5 x 12.5	10.5 x 12.5
COLOURS ↓	MRP Rs. (₹)	MRP Rs. (₹)	MRP Rs. (₹)	MRP Rs. (₹)	MRP Rs. (₹)	MRP Rs. (₹)	MRP Rs. (₹)	MRP Rs. (₹)
PLATINA	166.00	166.00	190.00	212.00	232.00	246.00	253.00	263.00
METALIQ	232.00	232.00	245.00	251.00	264.00	284.00	304.00	370.00
CODE →	14234	14237	14238	14239	14242	14244	14245	14248
Outer / Master →	10/120	10/180	10/120	10/120	10/120	10/120	10/120	10/80

Gazelle Wood Plate



AVAILABLE COLOURS IN PLATES
Platina : White Jazz & Ivory
MetalIQ : Digital Silver



True beauty that delights
the heart, the mind and the soul.



You love your home. We love to help.



Code	Item	MRP ₹	Pkg.
6A CUB SWITCH / INDICATOR			
GL101	1 Way Switch	26.00	20/1200
GL102	2 Way Switch	35.00	20/1200
GL104	Bell Push	35.00	20/1200
GL105	Indicator	35.00	20/1200



Code	Item	MRP ₹	Pkg.
6A CAPSULE SWITCH / INDICATOR			
GL106	1 Way Switch	26.00	20/1200
GL107	2 Way Switch	35.00	20/1200
GL109	Bell Push	35.00	20/1200
GL110	Indicator	35.00	20/1200



Code	Item	MRP ₹	Pkg.
6A / 10A SOCKET			
GL119	2 Pin Socket	33.00	20/1200
GL120	2-in-1 Socket	47.00	10/600
GL121	6A 3 Pin Socket (2M)	51.00	10/600



Code	Item	MRP ₹	Pkg.
KIT-KAT FUSE			
GL123	Cub 10A Kit-Kat Fuse	58.00	20/600
GL125	Cub 16A Kit-Kat Fuse	65.00	10/300



Code	Item	MRP ₹	Pkg.
T.V. ANTENNA SOCKET			
GL133	Mini T. V. Antenna Socket	41.00	20/600



Code	Item	MRP ₹	Pkg.
TELEPHONE JACK			
GL139	Mini 2 Line Tel. Jack (modular)	78.00	20/600



Code	Item	MRP ₹	Pkg.
CUB ELECTRONIC DIMMER/FAN REGULATOR			
GL144	300W Mini Dimmer	229.00	10/450
GL145	300W Medium Dimmer	244.00	10/300
GL146	4 step Fan Regulator (switch type)	337.00	10/300
GL147	5 Step Fan Regulator (socket type)	366.00	10/300

- Regulator Supplied in ISI & Non ISI

Code	Item	MRP ₹	Pkg.
16A SWITCH / 6 & 16A. SOCKET			
GL150	Cub 1 Way Switch	118.00	10/200
GL151	Cub 2 Way Switch	131.00	10/200
GL152	Capsule 1 Way Switch	117.00	10/200
GL153	Capsule 2 Way Switch	131.00	10/200
GL154	6 & 16A Universal Socket	122.00	10/200



Code	Item	MRP ₹	Pkg.
3-IN-ONE / WITH J. BOX			
GL155	Cub 3-in-One Universal Switch Socket Combined	188.00	5/100
GL156	Capsule 3-in-One Universal Switch Socket Combined	188.00	5/100
GL157	Cub / Capsule 3 in one with J. Box	230.00	5/100



Code	Item	MRP ₹	Pkg.
5-IN-ONE / WITH J. BOX			
GL158	Cub 5-in-one Uni. Switch Socket Combined with Fuse & Indicator	262.00	5/60
GL159	Capsule 5-in-one Uni. Switch Socket Combined with Fuse & Indicator	262.00	5/60
GL160	Cub /Capsule 5 in one with J. Box	320.00	5/60



Code	Item	MRP ₹	Pkg.
32 AMP. DELUXE D. P. SWITCH			
GL187	Deluxe Surface D. P. Switch with Indicator (unbreakable)	248.00	5/100
GL188	Deluxe Flush D. P. Switch with Indicator (unbreakable)	248.00	5/100



Code	Item	MRP ₹	Pkg.
CEILING ROSE / ADAPTOR			
GL191	Pilot Ceiling Rose (2 plate)	33.00	40/600
GL193	Jumbo Ceiling Rose (2 plate)	39.00	20/400
GL195	Adaptor	28.00	30/720



Code	Item	MRP ₹	Pkg.
CAPSULE SKIRT LAMP HOLDER			
GL204	Capsule Angle Holder	45.00	20/400
GL205	Capsule Batten Holder	45.00	20/400
GL206	Skirt Pendant Holder	34.00	30/720



Code	Item	MRP ₹	Pkg.
3 PIN PLUG TOP			
GL213	Cub 6A 3 Pin Top	67.00	20/600
GL214	Cub 16A 3 Pin Top	97.00	10/300





Code	Item	MRP ₹	Pkg. Outer/ Master
3 PIN PLUG TOP (POLYCARBONATE)			
GL219	Glow 6A 3 Pin Top	72.00	20/600
GL220	Glow 16A 3 Pin Top	103.00	10/300
6A SUMO SWITCH / INDICATOR			
GL231	1 Way Switch	31.00	20/1200
GL232	2 Way Switch	38.00	20/1200
GL233	Bell Push	38.00	20/1200
GL234	Indicator	38.00	20/1200
6A / 10A SUMO SOCKET			
GL239	2 Pin Socket	34.00	20/1200
GL240	2-in-one Socket	48.00	10/600
GL241	6A 3 Pin Socket (2M)	48.00	10/600
SUMO KIT-KAT / TV ANTENNA SOCKET			
GL243	10A Kit-Kat Fuse	56.00	20/600
GL244	16A Kit-Kat Fuse	71.00	10/300
GL247	Mini TV Antenna Socket	44.00	20/600
SUMO TELEPHONE JACK			
GL252	Mini 2 Line Tel. Jack (Modular)	75.00	20/600
SUMO ELECTRONIC DIMMER / FAN REG.			
GL256	300W Mini Dimmer	236.00	10/450
GL257	300W Medium Dimmer	250.00	10/300
GL258	4 Step Fan Regulator (switch type)	346.00	10/300
GL259	5 Step Fan Regulator (socket type)	379.00	10/300
	- Regulator Supplied in ISI & Non ISI		
16A SUMO SWITCH / 6 & 16A UNI. SOCKET			
GL262	16A 1 Way Switch with Indicator	134.00	10/200
GL263	16A 2 Way Switch with Indicator	148.00	10/200
GL264	6 & 16A Universal Socket	135.00	10/200

Code	Item	MRP ₹	Pkg. Outer/ Master
SUMO 5-IN-ONE / WITH J. BOX			
GL267	5-in-One Universal Switch Socket Combined with Fuse & Indicator	262.00	5/60
GL268	5-in-One with J. Box	320.00	5/60
SUMO SKIRT LAMP HOLDER			
GL269	Angle Holder	47.00	20/400
GL270	Batten Holder	47.00	20/400
6A WA-WAH SWITCH / INDICATOR			
GL273	1 Way Switch	31.00	20/1200
GL274	2 Way Switch	38.00	20/1200
GL276	Bell Push	38.00	20/1200
GL277	Indicator	38.00	20/1200
6A / 10A WA-WAH SOCKET			
GL282	2 Pin Socket	34.00	20/1200
GL283	2-in-One Socket	48.00	10/600
GL284	6A 3 Pin Socket (2M)	48.00	10/600
WA-WAH KIT-KAT FUSE/TV ANTENNA SOCKET			
GL286	10A Kit-Kat Fuse	56.00	20/600
GL287	16A Kit-Kat Fuse	71.00	10/300
GL288	Mini TV Antenna Socket	44.00	20/600
WA-WAH TELEPHONE JACK			
GL291	Mini 2 Line Tel. Jack (modular)	77.00	20/600
WA-WAH ELECTRONIC DIMMER / FAN REG.			
GL296	300W Mini Dimmer	237.00	10/450
GL297	300W Medium Dimmer	253.00	10/300
GL299	5 Step Fan Regulator	383.00	10/300
	- Regulator Supplied in ISI & Non ISI		





Code	Item	MRP ₹	Pkg. Outer/ Master
------	------	-------	--------------------------

16A WA-WAH SWITCH / 6 & 16A. SOCKET

GL302	16A 1 Way Switch	127.00	10/200
GL303	16A 2 Way Switch	140.00	10/200
GL304	6 & 16A Universal Socket	133.00	10/200

WA-WAH 3-IN-ONE/ WITH J. BOX

GL305	3-in-One Universal Switch Socket Combined	207.00	5/100
GL306	3-in-One with J. Box	254.00	5/100

WA-WAH 5-IN-ONE/ WITH J. BOX

GL307	5-in-One Universal Switch Socket Combined with Fuse & Indicator	269.00	5/60
GL308	5-in-One with J. Box	332.00	5/60

16A EURO SWITCH / 6 & 16A. SOCKET

GL352	16A 1 Way Switch	137.00	10/120
GL353	16A 2 Way Switch	150.00	10/120
GL354	6 & 16A Universal Socket	145.00	10/120

EURO 3-IN-ONE / 5-IN-ONE

GL355	3-in-One Universal Switch Socket Combined	235.00	5/60
GL356	5-in-One Universal Switch Socket Combined with Fuse & Indicator	336.00	5/60

3 IN ONE / 5 IN ONE WITH J. BOX

GL357	3-in-One Junction Box	73.00	5/60
GL358	5-in-One Junction Box	78.00	5/60
GL359	Euro 3-in-one with Junction Box	295.00	5/60
GL360	Euro 5-in-one with Junction Box	403.00	5/60

TUBE - LIGHT STARTER / ROTER HOLDER

GL369	Darling Starter with Heavy Duty Cap.	16.00	100/2400
GL376	16A Iron Connector (Porcelain Base)	94.00	20/200

16A PILOT SWITCH / SOC./ ROUND TOP

GL384	16A Surface 3Pin Socket (Round Black)	118.00	10/160
GL385	16A 3 Pin Top (Round Black)	107.00	20/240

Code	Item	MRP ₹	Pkg. Outer/ Master
------	------	-------	--------------------------

2 PIN TOP / MALE FEMALE / MULTI PLUG

GL386	Flat 2 Pin Top	23.00	40/1800
GL387	Flat 2 Pin Male Female	41.00	40/960
GL392	Mak Flat 6A 2 Pin Multi Plug	27.00	20/1000
GL393	Mak 6A 3 Pin Multi Plug	84.00	20/600

FLEX BOX

GL403	Round 2 Pin Flex Box 4 Mtr.	363.00	5/80
GL404	Round 2 Pin Flex Box 8 Mtr.	476.00	5/80
GL405	Round 3 Pin Flex Box 5 Mtr.	476.00	5/80

DING DONG BELL

GL422	Angel Ding Dong Bell	189.00	5/150
-------	----------------------	--------	-------

ELECTRONIC BIRD CHIME BELL

GL461	Cuckoo Bird Chime	308.00	5/60
GL462	Parrot Bird Chime	330.00	5/100
GL464	Buzzer	70.00	10/300
GL465	Mini Parrot Bird Chime	282.00	10/120

FOOT LIGHT PLATE

GL479	Moonlite (modular) New LED based multipurpose lighting system	663.00	5/80
-------	--	--------	------

MOUNTING JUNCTION BOX

GL484	16A Switch / Soc. J. Box	41.00	20/200
GL485	3-in-One J. Box	58.00	5/200
GL486	5-in-One J. Box	62.00	10/100
GL487	Sumo 4-in-One J. Box	61.00	10/100
GL488	Sumo 5-in-One J. Box	71.00	10/100

AC, MCB JUNCTION BOX

GL489	Round Junction Plate	13.00	50/2000
GL489A	Round Junction Plate (Dummy)	13.00	50/2000
GL490	Fansheet	41.00	50/400
GL491	Med Round Junction Plate	16.50	50/1000
GL502	MCB Enclosure (1-2 Plate)	65.00	10/200
GL503	MCB Enclosure (3-4 Plate)	95.00	5/100





Code	Item	MRP ₹	Pkg. Outer/ Master
------	------	-------	--------------------------

6A OLIVE SWITCH / INDICATOR

GL601	1 Way Switch	31.00	20/1200
GL602	2 Way Switch	40.00	20/1200
GL603	Bell Push	40.00	20/1200
GL604	Indicator	40.00	20/1200

6A / 10A OLIVE SOCKETS

GL609	2 Pin Socket	37.00	20/1200
GL610	2 in 1 Socket	48.00	10/600
GL612	6A 3 Pin Socket (2M)	48.00	10/600

OLIVE TV ANTENNA SOCKETS

GL613	Mini TV Antenna with cord-grip configuration	46.00	20/600
-------	---	-------	--------

OLIVE ELECTRONIC DIMMER / FAN REGULATOR

GL615	Mini Dimmer	237.00	10/450
GL616	Medium Dimmer	255.00	10/300
GL617	4 Step Fan Regulator <small>switch type</small>	353.00	10/300
GL618	5 Step Fan Regulator <small>socket type</small> - Regulator Supplied in ISI & Non ISI	388.00	10/300

OLIVE TELEPHONE JACK

GL621	Mini 2 Line Tel. Jack <small>with enclosure</small>	80.00	20/600
-------	---	-------	--------

OLIVE KIT-KAT FUSE

GL625	10A Kit-kat Fuse	64.00	20/600
GL626	16A Kit-kat Fuse	72.00	10/300

16A OLIVE SWITCH / 6 & 16A. UNI. SOCKET

GL627	16A 1 Way Switch with indicator	138.00	10/200
GL628	16A 2 Way Switch with indicator	151.00	10/200
GL629	6 & 16 A Universal Socket With Safety Shutter	139.00	10/200

CAPS TO HIDE THE SCREW

Code	Item	MRP ₹	Pkg. Outer/ Master
------	------	-------	--------------------------

16A OLIVE 4 IN ONE

GL630	4-in-one Universal Switch Socket Combined with Indicator with safety shutter	235.00	5/100
GL631	4-in-one with Junction Box	284.00	5/100



16A OLIVE 5 IN ONE

GL632	5-in-one Universal Switch Socket Combined with Fuse & Indicator (with safety shutter)	279.00	5/60
GL633	5-in-one with Junction Box	335.00	5/60



32A OLIVE D. P. SWITCH

GL634	Surface D. P. Switch with indicator (unbreakable)	248.00	5/100
GL635	Flush D. P. Switch with indicator (unbreakable)	248.00	5/100



OLIVE SKIRT HOLDER / CEILING ROSE

GL636	Angle Holder	45.00	20/400
GL637	Batten Holder	45.00	20/400
GL640	Pilot Ceiling Rose Unbreakable (3 Plate)	35.00	20/600
GL641	Jumbo Ceiling Rose Unbreakable (3 Plate)	38.00	20/400



POWER STRIP / SPIKE GUARD

GL655	4 Outlet Power Strip (with international socket outlet)	475.00	5/60
GL656	6 Outlet Spike Adapter With Switch & Lamp (surge & spike protection with international socket outlet)	823.00	5/40





Code	Item	MRP ₹	Pkg.
6A VAASTU SWITCH / INDICATOR			
GL701	1 Way Switch	27.00	20/1200
GL702	2 Way Switch	35.00	20/1200
GL703	Bell Push	35.00	20/1200
GL704	Indicator	35.00	20/1200

Code	Item	MRP ₹	Pkg.
6A INNOVA SWITCH / INDICATOR			
GL705	1 Way Switch	26.00	20/1200
GL706	2 Way Switch	35.00	20/1200
GL707	Bell Push	35.00	20/1200
GL708	Indicator	35.00	20/1200

Code	Item	MRP ₹	Pkg.
6A GENIUS SWITCH / INDICATOR			
GL709	1 Way Switch	26.00	20/1200
GL710	2 Way Switch	32.00	20/1200
GL711	Bell Push	32.00	20/1200
GL712	Indicator	32.00	20/1200

Code	Item	MRP ₹	Pkg.
6A / 10A EIKON SOCKETS			
GL724	2 Pin Socket	36.00	20/1200
GL725	2-in-1 Socket	43.00	10/600
GL727	6A 3 Pin Socket (2M)	43.00	10/600

Code	Item	MRP ₹	Pkg.
EIKON TV ANTENNA SOCKETS			
GL731	Mini TV Antenna With Cord-grip Configuration	43.00	20/600

Code	Item	MRP ₹	Pkg.
EIKON ELECTRONIC DIMMER / FAN REGULATOR			
GL735	Mini Dimmer	233.00	10/450
GL736	Medium Dimmer	250.00	10/300
GL737	4 Step Fan Regulator <small>Switch Type</small>	337.00	10/300
GL738	5 Step Fan Regulator <small>Socket Type</small>	371.00	10/300

- Regulator Supplied in ISI & Non ISI

Code	Item	MRP ₹	Pkg.
EIKON TELEPHONE JACK			
GL742	Mini 2 Line Tel. Jack With Enclosure	75.00	20/600

Code	Item	MRP ₹	Pkg.
EIKON KIT-KAT FUSE / 6A S S COMBINED			
GL746	10A Kit-Kat Fuse	55.00	20/600
GL747	16A Kit-Kat Fuse	69.00	10/300
GL749	6A S. S. Combine with Indicator & Junction Box	114.00	10/160

Code	Item	MRP ₹	Pkg.
16A EIKON SWITCH / 6 & 16A UNI. SOCKET			
GL750	16A 1 Way Switch	131.00	10/200
GL751	16A 2 Way Switch	153.00	10/200
GL752	6 & 16A Universal Socket with Safety Shutter	135.00	10/200

Code	Item	MRP ₹	Pkg.
16A EIKON 3 IN ONE / WITH J. BOX			
GL753	3-in-one Universal Switch Socket Combined with Safety Shutter	202.00	5/100
GL754	3-in-one with Junction Box	242.00	5/100

Code	Item	MRP ₹	Pkg.
16A EIKON 5 IN ONE / WITH J. BOX			
GL755	5-in-one Universal Switch Socket Combined With Fuse & Indicator with Safety Shutter	280.00	5/60
GL756	5-in-one With Junction Box	329.00	5/60

Code	Item	MRP ₹	Pkg.
EIKON SKIRT LAMP HOLDER			
GL770	Angle Holder (Unbreakable)	45.00	20/400
GL771	Batten Holder (Unbreakable)	45.00	20/400
GL772	Vaastu Angle Holder	35.00	20/400
GL773	Vaastu Batten Holder	35.00	20/400

Code	Item	MRP ₹	Pkg.
EIKON CEILING ROSE			
GL774	Pilot Ceiling Rose Unbreakable (3 Plate)	39.00	20/600
GL775	Jumbo Ceiling Rose Unbreakable (3 Plate)	43.00	20/400



With GOLDMEDAL,
you are in safe hands!



Safeguards human life
and property against
the hazards of electrical
mishaps.

Managing power was never so simple!



Atlantic | Alessio

Automatically breaks the circuit if the current reaches a predetermined value

Compared to a traditional fuse, MCBs are designed to operate accurately under both overloading and short circuit conditions. Unlike a fuse, MCBs can also be reset quickly after they trip. RCCBs play an equally important role by automatically detecting and disconnecting the circuit whenever a fault occurs or the current exceeds the rated sensitivity. The MCBs and RCCBs from Goldmedal are housed within a plastic moulding that is made of flame-retardant, high strength plastic. The quality of the material used and its design ensures that these devices are highly durable and appear new in spite of years of use.

High performance delivered. Safely.

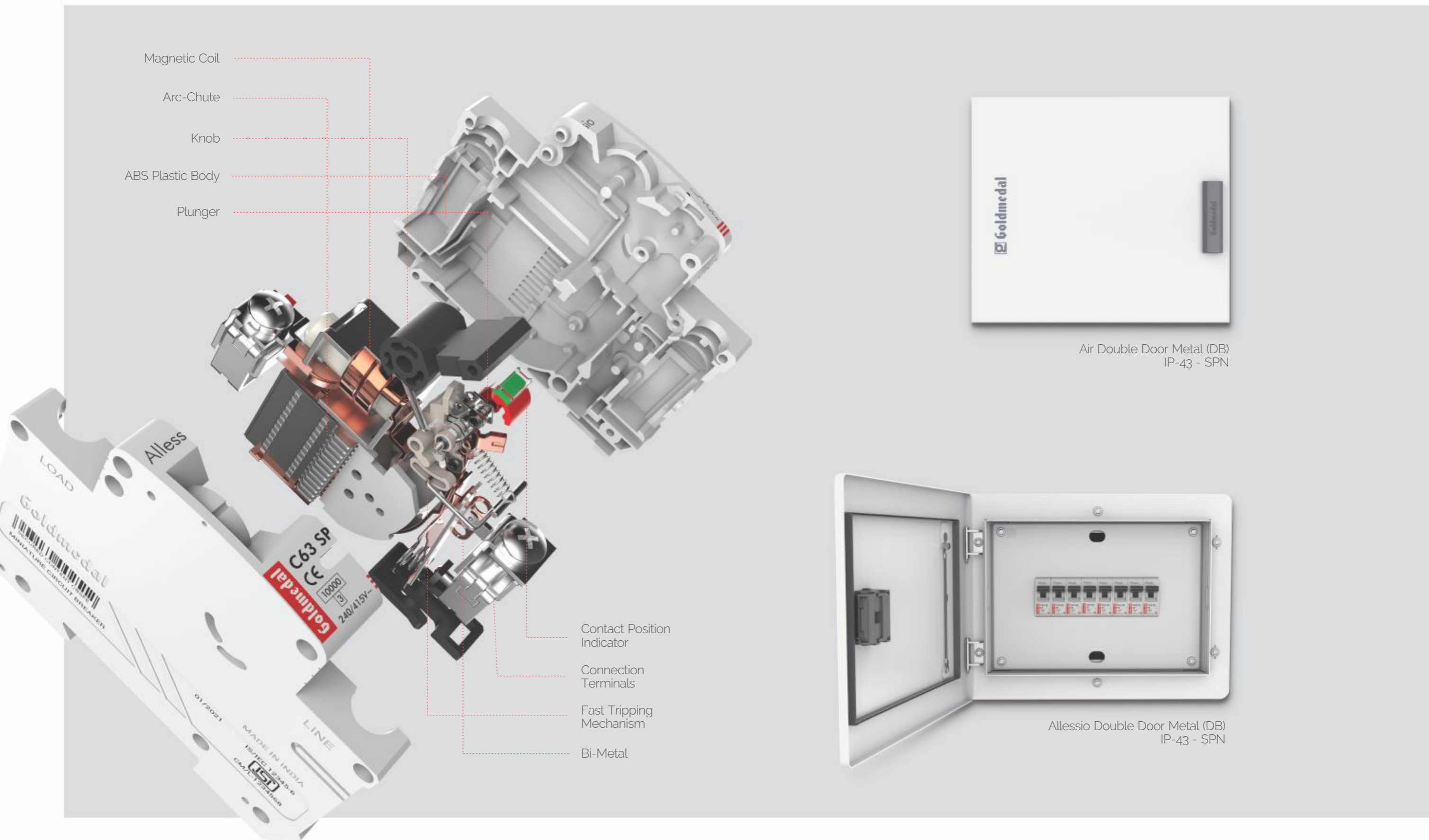

Magnetic Coil

Arc-Chute

Knob

ABS Plastic Body

Plunger

Contact Position Indicator

Connection Terminals

Fast Tripping Mechanism

Bi-Metal

Air Double Door Metal (DB)
IP-43 - SPN

Allessio Double Door Metal (DB)
IP-43 - SPN



Code	Item		MRP ₹	Pkg.
				Outer/ Master
ALLESSIO MINIATURE CIRCUIT BREAKER - 10kA C' CURVE - SP				
02301	6A MCB	1	236.00	10/200
02302	10A MCB	1	236.00	10/200
02303	16A MCB	1	236.00	10/200
02304	20A MCB	1	236.00	10/200
02305	25A MCB	1	236.00	10/200
02306	32A MCB	1	236.00	10/200
02307	40A MCB	1	289.00	10/200
02308	63A MCB	1	357.00	10/200

Code	Item		MRP ₹	Pkg.
				Outer/ Master
ALLESSIO MINIATURE CIRCUIT BREAKER - 10kA C' CURVE - SPN				
02311	6A MCB	2	519.00	6/120
02312	10A MCB	2	519.00	6/120
02313	16A MCB	2	519.00	6/120
02314	20A MCB	2	519.00	6/120
02315	25A MCB	2	519.00	6/120
02316	32A MCB	2	519.00	6/120
02317	40A MCB	2	698.00	6/120
02318	63A MCB	2	758.00	6/120

Code	Item		MRP ₹	Pkg.
				Outer/ Master
ALLESSIO MINIATURE CIRCUIT BREAKER - 10kA C' CURVE - DP				
02320	6A MCB	2	557.00	6/120
02321	10A MCB	2	557.00	6/120
02322	16A MCB	2	557.00	6/120
02323	20A MCB	2	557.00	6/120
02324	25A MCB	2	557.00	6/120
02325	32A MCB	2	557.00	6/120
02326	40A MCB	2	734.00	6/120
02327	63A MCB	2	839.00	6/120

Code	Item		MRP ₹	Pkg.
				Outer/ Master
ALLESSIO MINIATURE CIRCUIT BREAKER - 10kA C' CURVE - TP				
02330	6A MCB	3	835.00	4/80
02331	10A MCB	3	835.00	4/80
02332	16A MCB	3	835.00	4/80
02333	20A MCB	3	835.00	4/80
02334	25A MCB	3	835.00	4/80
02335	32A MCB	3	835.00	4/80
02336	40A MCB	3	1147.00	4/80
02337	63A MCB	3	1318.00	4/80

Code	Item		MRP ₹	Pkg.
				Outer/ Master
ALLESSIO MINIATURE CIRCUIT BREAKER - 10kA C' CURVE - TPN				
02340	6A MCB	4	1073.00	3/60
02341	10A MCB	4	1073.00	3/60
02342	16A MCB	4	1073.00	3/60
02343	20A MCB	4	1073.00	3/60
02344	25A MCB	4	1073.00	3/60
02345	32A MCB	4	1073.00	3/60
02346	40A MCB	4	1473.00	3/60
02347	63A MCB	4	1560.00	3/60

Code	Item		MRP ₹	Pkg.
				Outer/ Master
ALLESSIO MINIATURE CIRCUIT BREAKER - 10kA C' CURVE - FP				
02350	6A MCB	4	1164.00	3/60
02351	10A MCB	4	1164.00	3/60
02352	16A MCB	4	1164.00	3/60
02353	20A MCB	4	1164.00	3/60
02354	25A MCB	4	1164.00	3/60
02355	32A MCB	4	1164.00	3/60
02356	40A MCB	4	1523.00	3/60
02357	63A MCB	4	1838.00	3/60

Code	Item		MRP ₹	Pkg.
				Outer/ Master
ALLESSIO MINIATURE CIRCUIT BREAKER - 10kA B' CURVE - SP				
02501	6A MCB	1	234.00	10/200
02502	10A MCB	1	234.00	10/200
02503	16A MCB	1	234.00	10/200
02504	20A MCB	1	234.00	10/200
02505	25A MCB	1	234.00	10/200
02506	32A MCB	1	234.00	10/200
02507	40A MCB	1	286.00	10/200
02508	63A MCB	1	354.00	10/200

Code	Item		MRP ₹	Pkg.
				Outer/ Master
ALLESSIO ISOLATOR - DP				
02360	40A Isolator	2	394.00	6/120
02361	63A Isolator	2	511.00	6/120
02362	100A Isolator	2	671.00	6/120

Code	Item		MRP ₹	Pkg.
				Outer/ Master
ALLESSIO ISOLATOR - TP				
02368	40A Isolator	3	589.00	4/80
02369	63A Isolator	3	722.00	4/80
02370	100A Isolator	3	979.00	4/80

Code	Item		MRP ₹	Pkg.
				Outer/ Master
ALLESSIO ISOLATOR - FP				
02376	40A Isolator	4	798.00	3/60
02377	63A Isolator	4	924.00	3/60
02378	100A Isolator	4	1203.00	3/60

Code	Item		MRP ₹	Pkg.
				Outer/ Master
ALLESSIO CHANGEOVER - DP				
02381	25A Changeover	2	899.00	6/120
02382	32A Changeover	2	999.00	6/120
02383	40A Changeover	2	1250.00	6/120
02384	63A Changeover	2	1499.00	6/120

Code	Item		MRP ₹	Pkg.
				Outer/ Master
ALLESSIO CHANGEOVER - FP				
02386	25A Changeover	4	1699.00	3/60
02387	32A Changeover	4	1999.00	3/60
02388	40A Changeover	4	2400.00	3/60
02389	63A Changeover	4	2800.00	3/60





Code	Item	No of Modules			MRP ₹	Pkg. Outer/ Master
		Incomer	Sub Incomer	Outgoing		
ALLESSIO RCCB - 10kA - DP						
02400	25A RCCB 30mA			2	2048.00	6/120
02401	25A RCCB 100mA			2	2074.00	6/120
02402	25A RCCB 300mA			2	2100.00	6/120
02403	40A RCCB 30mA			2	2231.00	6/120
02404	40A RCCB 100mA			2	2284.00	6/120
02405	40A RCCB 300mA			2	2310.00	6/120
02406	63A RCCB 30mA			2	2835.00	6/120
02407	63A RCCB 100mA			2	2888.00	6/120
02408	63A RCCB 300mA			2	2940.00	6/120
ALLESSIO RCCB - 10kA - FP						
				Module		
02412	25A RCCB 30mA			4	2520.00	3/60
02413	25A RCCB 100mA			4	2678.00	3/60
02414	25A RCCB 300mA			4	2783.00	3/60
02415	40A RCCB 30mA			4	2678.00	3/60
02416	40A RCCB 100mA			4	2730.00	3/60
02417	40A RCCB 300mA			4	2835.00	3/60
02418	63A RCCB 30mA			4	3045.00	3/60
02419	63A RCCB 100mA			4	3150.00	3/60
02420	63A RCCB 300mA			4	3255.00	3/60
ALLESSIO 32A DP MCB WITH ENCLOSURE						
02426	32A DP MCB with Enclosure				431.00	5/100
AUTOMATIC CHANGEOVER WITH CURRENT LIMITER (ACCL) - SPN						
02451	Mains 32A, Genset 1.5A - 300W				2399.00	3/60
02452	Mains 32A, Genset 2.5A - 500W				2399.00	3/60
02453	Mains 32A, Genset 3A - 600W				2399.00	3/60
02454	Mains 32A, Genset 4A - 800W				2399.00	3/60
02455	Mains 32A, Genset 5A - 1000W				2399.00	3/60
02456	Mains 32A, Genset 6A - 1200W				2399.00	3/60
02457	Mains 32A, Genset 9A - 1800W				2399.00	3/60
02458	Mains 32A, Genset 12A - 2400W				2399.00	3/60
02459	Mains 32A, Genset 15A - 3000W				2399.00	3/60
02460	Mains 32A, Genset 20A - 4000W				2399.00	3/60
02461	Mains 32A, Genset 30A - 6000W				2399.00	3/60
AUTOMATIC CHANGEOVER WITH CURRENT LIMITER (ACCL) - SPN WITH DISPLAY						
02462	Mains 32A, Genset 32A - 6000W On site programmable DG Current limit 0-32A (With extra safety features)				3499.00	3/60
AUTOMATIC CHANGEOVER WITH CURRENT LIMITER (ACCL) - TPN WITH DISPLAY						
02463	Mains 40A, Genset 40A - 8000W				10999.00	1/4
02464	Mains 63A, Genset 63A - 12000W On site programmable DG Current limit 0-40/63A (With extra safety features)				18999.00	1/4

Code	Item	No of Modules			MRP ₹	Pkg. Outer/ Master
		Incomer	Sub Incomer	Outgoing		
ALLESSIO ROTARY SWITCH						
02433	3 Way - 40A				1080.00	1/40
02434	3 Way - 63A				1120.00	1/40
ALLESSIO DOUBLE DOOR DB's - PLASTIC WITH METAL BASE						
04152	4 - 6 Way	2	-	4	1432.00	1/10
04153	7 - 9 Way	2	-	7	1706.00	1/10
04154	10 - 12 Way	2	-	10	2020.00	1/10
04155	13 - 16 Way	3	-	13	2403.00	1/5
04156	16 - 20 Way	4	-	16	2806.00	1/5
	Fireproof Plastic with transparent grey cover					
ALLESSIO SINGLE DOOR (METAL) DISTRIBUTION BOARD - IP30 - SPN						
04191	4 Way	2	-	2	1161.00	1/12
04192	8 Way	2	-	6	1452.00	1/9
04193	12 Way	2	-	10	1722.00	1/9
04194	16 Way	2	-	14	2145.00	1/6
	<ul style="list-style-type: none"> •Conforms to IS 8623-1 & 3, IEC 61439-1 & 3 • IP-30. •Suitable for Surface & Flush mounting. •Enclosure is made up of CRCA Sheet steel, RAL 9003 Powder coated, •with din rail, removable bus -bar, shrouded neutral/earth link with Conditional Short Circuit Rating of 15kA in SPN DB provided with isolable neutral link to carry out isolation test, also with high integrity/Clean Earth kit as accessory for electronic/IT installation to meet international safety standard DBs design with ample space for wiring. •There is a provision for DP MCB /Isolator/ RCCB/RCBO as incomer & SP MCBs as outgoing. 					
ALLESSIO DOUBLE DOOR (METAL) DISTRIBUTION BOARD - IP43 - SPN						
04201	4 Way	2	-	2	1550.00	1/9
04203	8 Way	2	-	6	2000.00	1/6
04204	12 Way	2	-	10	2400.00	1/6
04205	16 Way	2	-	14	3000.00	1/6
	<ul style="list-style-type: none"> •Conforms to IS 8623-1 & 3, IEC 61439-1 & 3 •Reversible Door for IP-43 & IK-09 Dbs. •Suitable for Surface & Flush mounting. •Enclosure is made up of CRCA Sheet steel, RAL 9003 Powder coated, •with din rail, removable bus -bar, shrouded neutral/earth link with Conditional Short Circuit Rating of 15kA in SPN DB provided with isolable neutral link to carry out isolation test, also with high integrity/Clean Earth kit as accessory for electronic/IT installation to meet international safety standard DBs design with ample space for wiring. •There is a provision for DP MCB /Isolator/ RCCB/RCBO as incomer & SP MCBs as outgoing. 					
ALLESSIO DOUBLE DOOR (METAL) DISTRIBUTION BOARD - IP43 - TPN						
04215	4 Way	8	-	4+4+4	3650.00	1/6
04216	6 Way	8	-	6+6+6	4450.00	1/6
04217	8 Way	8	-	8+8+8	5350.00	1/3
04218	12 Way	8	-	12+12+12	8000.00	1/1
	<ul style="list-style-type: none"> •Conforms to IS 8623-1 & 3, IEC 61439-1 & 3 •Reversible door for IP-43 & IK-09 Dbs. •Suitable for Surface & Flush mounting. •Enclosure is made up of CRCA Sheet steel, RAL 9003 Powder coated, •with din rail, removable bus -bar, shrouded neutral/earth link with Conditional Short Circuit Rating of 15kA in TPN DB provided with isolable neutral link to carry out isolation test, also with high integrity/Clean Earth kit as accessory for electronic/IT installation to meet international safety standard DBs design with ample space for wiring. •There is a provision for FP MCB /Isolator/ RCCB/RCBO as incomer & SP/TP MCBs as outgoing. 					

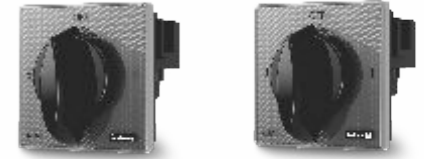



Code	Item		MRP ₹	Pkg. Outer/ Master
ATLANTIC MINIATURE CIRCUIT BREAKER - 10kA C' CURVE - SP				
04301	6A MCB	1	221.00	10/200
04302	10A MCB	1	221.00	10/200
04303	16A MCB	1	221.00	10/200
04304	20A MCB	1	221.00	10/200
04305	25A MCB	1	221.00	10/200
04306	32A MCB	1	221.00	10/200
04307	40A MCB	1	247.00	10/200
04308	63A MCB	1	289.00	10/200



Code	Item		MRP ₹	Pkg. Outer/ Master
ATLANTIC MINIATURE CIRCUIT BREAKER - 10kA C' CURVE - SPN				
04311	6A MCB	2	378.00	6/120
04312	10A MCB	2	378.00	6/120
04313	16A MCB	2	378.00	6/120
04314	20A MCB	2	378.00	6/120
04315	25A MCB	2	378.00	6/120
04316	32A MCB	2	378.00	6/120
04317	40A MCB	2	525.00	6/120
04318	63A MCB	2	625.00	6/120



Code	Item		MRP ₹	Pkg. Outer/ Master
ATLANTIC MINIATURE CIRCUIT BREAKER - 10kA C' CURVE - DP				
04320	6A MCB	2	415.00	6/120
04321	10A MCB	2	415.00	6/120
04322	16A MCB	2	415.00	6/120
04323	20A MCB	2	415.00	6/120
04324	25A MCB	2	415.00	6/120
04325	32A MCB	2	415.00	6/120
04326	40A MCB	2	562.00	6/120
04327	63A MCB	2	662.00	6/120



Code	Item		MRP ₹	Pkg. Outer/ Master
ATLANTIC MINIATURE CIRCUIT BREAKER - 10kA C' CURVE - TP				
04330	6A MCB	3	679.00	4/80
04331	10A MCB	3	679.00	4/80
04332	16A MCB	3	679.00	4/80
04333	20A MCB	3	679.00	4/80
04334	25A MCB	3	679.00	4/80
04335	32A MCB	3	679.00	4/80
04336	40A MCB	3	849.00	4/80
04337	63A MCB	3	1087.00	4/80



Code	Item		MRP ₹	Pkg. Outer/ Master
ATLANTIC MINIATURE CIRCUIT BREAKER - 10kA C' CURVE - TPN				
04340	6A MCB	4	935.00	3/60
04341	10A MCB	4	935.00	3/60
04342	16A MCB	4	935.00	3/60
04343	20A MCB	4	935.00	3/60
04344	25A MCB	4	935.00	3/60
04345	32A MCB	4	935.00	3/60
04346	40A MCB	4	1124.00	3/60
04347	63A MCB	4	1355.00	3/60

Code	Item		MRP ₹	Pkg. Outer/ Master
ATLANTIC MINIATURE CIRCUIT BREAKER - 10kA C' CURVE - FP				
04350	6A MCB	4	992.00	3/60
04351	10A MCB	4	992.00	3/60
04352	16A MCB	4	992.00	3/60
04353	20A MCB	4	992.00	3/60
04354	25A MCB	4	992.00	3/60
04355	32A MCB	4	992.00	3/60
04356	40A MCB	4	1155.00	3/60
04357	63A MCB	4	1365.00	3/60



Code	Item		MRP ₹	Pkg. Outer/ Master
ATLANTIC ISOLATOR - DP				
04360	40A Isolator	2	347.00	6/120
04361	63A Isolator	2	419.00	6/120
04362	100A Isolator	2	609.00	6/120



Code	Item		MRP ₹	Pkg. Outer/ Master
ATLANTIC ISOLATOR - TP				
04368	40A Isolator	3	515.00	4/80
04369	63A Isolator	3	620.00	4/80
04370	100A Isolator	3	830.00	4/80



Code	Item		MRP ₹	Pkg. Outer/ Master
ATLANTIC ISOLATOR - FP				
04376	40A Isolator	4	734.00	3/60
04377	63A Isolator	4	839.00	3/60
04378	100A Isolator	4	944.00	3/60



Code	Item		MRP ₹	Pkg. Outer/ Master
ATLANTIC RCCB - 10kA - DP				
04400	25A RCCB 30mA	2	2048.00	6/120
04401	25A RCCB 100mA	2	2074.00	6/120
04402	25A RCCB 300mA	2	2100.00	6/120
04403	40A RCCB 30mA	2	2231.00	6/120
04404	40A RCCB 100mA	2	2284.00	6/120
04405	40A RCCB 300mA	2	2310.00	6/120
04406	63A RCCB 30mA	2	2835.00	6/120
04407	63A RCCB 100mA	2	2888.00	6/120
04408	63A RCCB 300mA	2	2940.00	6/120





Code	Item	No of Modules			MRP ₹	Pkg. Outer/ Master
		Incomer	Sub Incomer	Outgoing		

ATLANTIC RCCB - 10kA - FP						
						Module
04412	25A RCCB 30mA			4	2520.00	3/60
04413	25A RCCB 100mA			4	2678.00	3/60
04414	25A RCCB 300mA			4	2783.00	3/60
04415	40A RCCB 30mA			4	2678.00	3/60
04416	40A RCCB 100mA			4	2730.00	3/60
04417	40A RCCB 300mA			4	2835.00	3/60
04418	63A RCCB 30mA			4	3045.00	3/60
04419	63A RCCB 100mA			4	3150.00	3/60
04420	63A RCCB 300mA			4	3255.00	3/60

ATLANTIC CHANGEOVER - DP						
						Module
04430	25A Changeover			2	799.00	6/120
04431	32A Changeover			2	900.00	6/120
04432	40A Changeover			2	1150.00	6/120

ATLANTIC CHANGEOVER - FP						
						Module
04435	25A Changeover			4	1599.00	3/60
04436	32A Changeover			4	1900.00	3/60
04437	40A Changeover			4	2300.00	3/60

ATLANTIC DOUBLE DOOR DISTRIBUTION BOARD - PLASTIC BASE						
04116	5 - 7 Way	2	-	5	1381.00	1/16
04117	7 - 9 Way	2	-	7	1619.00	1/16
04118	10 - 12 Way	2	-	10	1952.00	1/10
04119	14 - 16 Way	2	-	14	2627.00	1/10
04120	17 - 19 Way	2	-	17	2921.00	1/10

ATLANTIC DOUBLE DOOR (METAL) DB (SPN) - IP42						
04451	4 Way	2	-	2	1291.00	1/12
04455	6 Way	2	-	4	1467.00	1/12
04452	8 Way	2	-	6	1780.00	1/8
04453	12 Way	2	-	10	2328.00	1/8
04454	16 Way	2	-	14	2757.00	1/6

•Conforms to IS 8623-1 & 3, IEC 61439-1 & 3 •Reversible Door for IP-42 & IK-09 Dbs.
•Suitable for Surface & Flush mounting. •Enclosure is made up of CRCA Sheet steel, RAL 7035 Powder coated, •with din rail, removable bus-bar, shrouded neutral/earth link with Conditional Short Circuit Rating of 15kA in SPN DB provided with isolable neutral link to carry out isolation test, also with high integrity/Clean Earth kit as accessory for electronic/IT installation to meet international safety standard DBs design with ample space for wiring. •There is a provision for DP MCB /Isolator/ RCCB/RCBO as incomer & SP MCBs as outgoing.

Code	Item	No of Modules			MRP ₹	Pkg. Outer/ Master
		Incomer	Sub Incomer	Outgoing		

ATLANTIC DOUBLE DOOR (METAL) DB (TPN) - IP42						
04465	4 Way	4	-	4+4+4	3606.00	1/4
04466	6 Way	4	-	6+6+6	4301.00	1/4
04467	4 Way	8	-	4+4+4	4048.00	1/4
04468	6 Way	8	-	6+6+6	4365.00	1/4
04469	8 Way	8	-	8+8+8	5149.00	1/3
04470	12 Way	8	-	12+12+12	7148.00	1/1

•Conforms to IS 8623-1 & 3, IEC 61439-1 & 3 •Reversible door for IP-42 & IK-09 Dbs.
•Suitable for Surface & Flush mounting. •Enclosure is made up of CRCA Sheet steel, RAL 7035 Powder coated, •with din rail, removable bus-bar, shrouded neutral/earth link with Conditional Short Circuit Rating of 15kA in TPN DB provided with isolable neutral link to carry out isolation test, also with high integrity/Clean Earth kit as accessory for electronic/IT installation to meet international safety standard DBs design with ample space for wiring. •There is a provision for FP MCB /Isolator/ RCCB/RCBO as incomer & SP/TP MCBs as outgoing.

ATLANTIC DOUBLE DOOR (METAL) DB TPN PHASE SELECTOR 40A - IP-42						
04479	4 Way	8	-	4+4+4	10350.00	1/1
04480	6 Way	8	-	6+6+6	10580.00	1/1
04481	8 Way	8	-	8+8+8	11155.00	1/1
04482*	12 Way	8	-	12+12+12	14950.00	1/1

ATLANTIC DOUBLE DOOR (METAL) DB TPN PHASE SELECTOR 63A - IP-42						
04492	4 Way	8	-	4+4+4	11270.00	1/1
04493	6 Way	8	-	6+6+6	11500.00	1/1
04494	8 Way	8	-	8+8+8	11960.00	1/1
04495*	12 Way	8	-	12+12+12	15065.00	1/1

•Conforms to IS 8623-1 & 3, IEC 61439-1 & 3 •Reversible Door for IP-42 & IK-09 Dbs.
•Suitable for Surface & flush mounting. •Enclosure is made up of CRCA Sheet steel, RAL 7035 Powder coated, •DB has two separate compartments for MCB & Phase selector Switches, which includes 3 Nos. of (40A or 63A) rotary switches, 3 Nos. of Rocker Switches for Phase identification, 100A insulated Phase Bus-bar, Shrouded Neutral /Earth bar with Conditional Short Circuit Rating. This DB's kit includes high integrity accessories like Cement spill protector sheet, Colour-coded inter connecting wire set, Cable ties, Blank Module, Sticking saddles, Circuit identification labels. •There is a provision for FP MCB/Isolator /RCCB/RCBO as incomer & SP/TP MCBs as outgoing.

ATLANTIC - DOUBLE DOOR (METAL) TV/TEL DB (SPN) - IP42 NEW						
04502	6 Way	2	-	4	3449.00	1/6
04503	8 Way	2	-	6	3564.00	1/6
04504	12 Way	2	-	10	4024.00	1/6
04505	16 Way	2	-	14	5059.00	1/3

ATLANTIC - DOUBLE DOOR (METAL) TV/TEL DB (TPN) - IP42 NEW						
04511	4 Way	8	-	4+4+4	6151.00	1/3
04512	6 Way	8	-	6+6+6	6669.00	1/3
04513	8 Way	8	-	8+8+8	7359.00	1/3

•Conforms to IS 8623-1 & 3, IEC 61439-1 & 3 •Reversible Door for IP-42 & IK-09 Dbs.
•Suitable for Surface & Flush Mounting. •Enclosure is made up of CRCA Sheet steel, RAL 7035 Powder coated, •Ready to use DBs- includes 100A insulated Phase Bus-bar, Shrouded Neutral /Earth bar with Conditional Short Circuit Rating & having Telephone socket & TV co-axial socket. This DB's kit includes high integrity accessories like Cement spill protector sheet, Colour-coded inter connecting wire set, Cable ties, Blank Module, Sticking Saddles, Circuit identification labels. •There is a provision for-
1)SPN: DP MCB /Isolator/ RCCB/RCBO as incomer & SP MCBs as outgoing.
2)TPN:FP MCB /Isolator/RCCB/RCBO as incomer & SP/TP MCBs as outgoing.





Code	Item	No of Modules			MRP ₹	Pkg. Outer/ Master
		Incomer	Sub Incomer	Outgoing		

PORCELAIN KIT-KAT FUSE

05101	16A / 240V. Pilot				81.00	10/120
05102	16A / 415V. Excell				134.00	10/80
05103	32A / 415V.				234.00	5/45
05104	63A / 415V.				548.00	2/24
05105	100A / 415V.				1121.00	1/8
05106	200A / 415V.				1944.00	1/6
05107	300A / 415V with Lugs				3039.00	1/3
05108	500A / 415V with Lugs				3585.00	1/3

SWITCH FUSE UNIT (REWIRABLE)

05125	16A / 240V - DP / SPN				699.00	1/18
05126	32A / 240V - DP / SPN				1420.00	1/8
05127	16A / 415V - TP				2147.00	1/6
05128	32A / 415V - TP				2552.00	1/4
05129	63A / 415V - TP				6859.00	1/2
05130	100A / 415V - TP				11726.00	1/1
05131	200A / 415V - TP				15565.00	1/1

L. T. CONTROL REVERSE FORWARD SWITCHES

05147	16A / 240 V.				483.00	1/24
05148	25A / 415 V.				756.00	1/18

CHANGEOVER SWITCH OFF LOAD

05159	16A / 240V - 2 Pole				1211.00	1/12
05160	32A / 240V - 2 Pole				1699.00	1/8
05161	63A / 240V - 2 Pole				6240.00	1/3
05171	16A / 415V - 3 Pole				1841.00	1/6
05172	32A / 415V - 3 Pole				2249.00	1/4
05183	16A / 415V - 4 Pole				2474.00	1/6
05184	32A / 415V - 4 Pole				2759.00	1/4
05185	63A / 415V - 4 Pole				7771.00	1/2
05186	100A / 415V - 4 Pole				12388.00	1/1
05187	200A / 415V - 4 Pole				22281.00	1/1

• High grade porcelain carrier fitted with tinned copper fuse wire
 • Switchgear enclosure made of CRCA sheet steel duly pre-treated and powder coated. • Hard bright tin plated contacts for high conductivity & longer life. • Quick make and break operating mechanism.

AUTOMATIC CHANGEOVER SWITCH

05201	32A / 240V - 2 Pole				2484.00	1/8
-------	---------------------	--	--	--	---------	-----

• High grade porcelain carrier fitted with tinned copper fuse wire
 • Switchgear enclosure made of CRCA sheet steel duly pre-treated and powder coated. • Hard bright tin plated contacts for high conductivity & longer life. • Quick make and break operating mechanism.

Code	Item	No of Modules			MRP ₹	Pkg. Outer/ Master
		Incomer	Sub Incomer	Outgoing		

AC METAL PLUG & SOCKETS DB

03206	Deluxe- 20A 2Pin+SC^	P+N	1	601.00	1/24
-------	----------------------	-----	---	--------	------

SP & N enclosure with Two Pole and earth metal Plug and Socket for incorporating SP MCBs

CAM OPERATED ROTARY SWITCH

03232	3 Way - 25A			405.00	1/40
03233	3 Way - 32A			425.00	1/40
03234	3 Way - 40A			766.00	1/40
03235	3 Way - 63A			785.00	1/40

- Modular construction
- Enhanced life
- High Reliability
- Aesthetic design
- Temperature withstand capability
- Voltage Impulse test



Factory built service : Goldmedal can save your time and money by pre-assembling consumer units as per your requirements



Code	Item	No of Modules			MRP ₹	Pkg. Outer/ Master
		Incomer	Sub Incomer	Outgoing		

AIR SINGLE DOOR (METAL) DB - IP30 - SPN						
07001	4 Way	2	-	2	921.00	1/16
07002	6 Way	2	-	4	1128.00	1/16
07003	8 Way	2	-	6	1170.00	1/12
07004	12 Way	2	-	10	1530.00	1/12
07005	16 Way	2	-	14	1770.00	1/9
07006	18 Way	2	-	16	2039.00	1/9

AIR SINGLE DOOR (METAL) DB - IP30 - TPN						
07011	4 Way	4	-	4+4+4	2412.00	1/6
07012	6 Way	4	-	6+6+6	3136.00	1/6
07013	4 Way	8	-	4+4+4	2670.00	1/6
07014	6 Way	8	-	6+6+6	3024.00	1/6
07015	8 Way	8	-	8+8+8	3609.00	1/6
07016	12 Way	8	-	12+12+12	5744.00	1/3
07017	16 Way	8	-	16+16+16	6878.00	1/3

•Conforms to IS 8623-1 & 3, IEC 61439-1 & 3 •IP-30 for Single Door. •Suitable for Surface & Flush mounting. •Enclosure is made up of CRCA Sheet steel, RAL 9002 Powder coated, •Ready to use DBs - includes 100A insulated Phase Bus-bar, Shrouded Neutral /Earth bar with Conditional short circuit Rating. This DB's kit includes high integrity accessories like Cement spill protector sheet, Colour-coded inter connecting wire set, Cable ties, Blank Module, Sticking saddles, Circuit identification labels. •There is a provision for-
1)SPN: DP MCB /Isolator/ RCCB/RCBO as incomer & SP MCBs as outgoings.
2)TPN: FP MCB /Isolator/ RCCB/RCBO as incomer & SP/TP MCBs as outgoings.

AIR SINGLE DOOR (METAL) 63A TPN PHASE SELECTOR DB - IP-30						
07021	4 Way	8	-	4+4+4	8640.00	1/1
07022	6 Way	8	-	6+6+6	9416.00	1/1
07023	8 Way	8	-	8+8+8	9925.00	1/1
07024	12 Way	8	-	12+12+12	10987.00	1/1

•Conforms to IS 8623-1 & 3, IEC 61439-1 & 3 •IP-30 for single door. •Suitable for Surface & flush mounting. •Enclosure is made up of CRCA Sheet steel, RAL 9002 Powder coated, •DB has two separate compartments for MCB & Phase selector Switches, which includes 3 Nos. of 63A rotary switches, 3 Nos. of Rocker Switches for Phase identification, 100A insulated Phase Bus-bar, Shrouded Neutral /Earth bar with Conditional Short Circuit Rating. This DB's kit includes high integrity accessories like Cement spill protector sheet, Colour-coded inter connecting wire set, Cable ties, Blank Module, Sticking saddles, Circuit identification labels. •There is a provision for FP MCB /Isolator/RCCB/RCBO as incomer & SP/TP MCBs as outgoings

NEW

AIR SINGLE DOOR (METAL) 63A TPN PHASE SELECTOR ENCLOSURE DB - IP-30						
07025	Phase Selector Enclosure with 1 Rotary Switch	-	-	-	1979.00	1/10
07026	Phase Selector Enclosure with 3 Rotary Switch	-	-	-	6323.00	1/4

•Conforms to IS 8623-1 & 3, IEC 61439-1 & 3 •IP-30 for single door. • Suitable for Surface & flush mounting. • Available in CRCA Sheet steel, RAL9003 powder coated, • Ready to use DBs Phase selector Enclosure which includes 3 Nos. & 1 Nos. of 63A rotary Switches, 3 Nos. of Indicator for phase identification.

Code	Item	No. of Pins			MRP ₹	Pkg.
		Incomer	Sub Incomer	Outgoing		

07032	20A 2 Pin	-	P+N	1	637.00	1/24
07033	20A 2 Pin	-	P+N	2	732.00	1/24
07034	20A 3 Pin	-	3P	4	1486.00	1/16
07035	32A 3 Pin	-	3P	4	2116.00	1/8
07036	63A 5 Pin	-	3P+N+E	4	9769.00	1/6

•Conforms to IS 8623-1 & 3, IEC 61439-1 & 3
•Suitable for Surface & Flush mounting.
•Enclosure is made up of CRCA sheet steel, RAL 9002 powder coated.
•Loose Metal & Plastic Plugs & Sockets confirms to IS 8804 in single phase & three phase.

Code	Item	No of Modules			MRP ₹	Pkg. Outer/ Master
		Incomer	Sub Incomer	Outgoing		

AIR AC (PLASTIC) PLUG & SOC. DB						
Code	Item	No. of Pins			MRP ₹	Pkg.
		Incomer	Sub Incomer	Outgoing		

07041	16A 3 Pin	-	P+N+E	4	2228.00	1/16
07042	32A 3 Pin	-	P+N+E	4	3317.00	1/16
07043	32A 5 Pin	-	3P+N+E	8	3911.00	1/10
07044	63A 5 Pin	-	3P+N+E	8	10886.00	1/8

AIR AC (PLASTIC) PLUG & SOCKET DB (WITH PLASTIC COVER)						
07045	20A 2 Pin	-	P+N	1	679.00	1/24
07046	20A 2 Pin	-	P+N	2	679.00	1/24

•Confirms to IS 8623-1 & 3, IEC 61439-1 & 3
•Suitable for Surface & Flush mounting.
•Enclosure is made up of CRCA sheet steel, RAL 9002 powder coated.
•Loose Metal & Plastic Plugs & Sockets confirms to IS 8804 in single phase & three phase.

AIR (METAL) ENCLOSURE IP-30						
07051	2 Way	-	2	-	354.00	1/24
07052	4 Way	-	4	-	458.00	1/24
07053	6 Way	-	6	-	572.00	1/24
07054	8 Way	-	8	-	696.00	1/24

•Confirms to IS 8623-1 & 3, IEC 61439-1 & 3
•Suitable for Surface & Flush mounting.
•Enclosure is made up of CRCA sheet steel, RAL 9002 powder coated.
•There is a provision to mount MCB as Isolator, RCCB/RCBO & other modular devices.

AIR DOUBLE DOOR (METAL) DB - IP43 - SPN						
07056	4 Way	2	-	2	1469.00	1/12
07057	6 Way	2	-	4	1718.00	1/12
07058	8 Way	2	-	6	1890.00	1/8
07059	12 Way	2	-	10	2370.00	1/8
07060	16 Way	2	-	14	2929.00	1/6
07061	18 Way	2	-	16	3414.00	1/6

AIR DOUBLE DOOR (METAL) DB - IP43 - TPN						
07066	4 Way	4	-	4+4+4	3260.00	1/4
07067	6 Way	4	-	6+6+6	4039.00	1/4
07068	4 Way	8	-	4+4+4	3685.00	1/4
07069	6 Way	8	-	6+6+6	4205.00	1/4
07070	8 Way	8	-	8+8+8	5226.00	1/4
07071	12 Way	8	-	12+12+12	7418.00	1/1
07072	16 Way	8	-	16+16+16	8949.00	1/1

•Conforms to IS 8623-1 & 3, IEC 61439-1 & 3 •Reversible Door for IP-43 & IK-09 Dbs.
•Suitable for Surface & Flush mounting. •Enclosure is made up of CRCA Sheet steel, RAL 9002 Powder coated, •Ready to use DBs- includes 100A insulated Phase Bus-bar, Shrouded Neutral /Earth bar with Conditional short circuit Rating. This DB's kit includes high integrity accessories like Cement spill protector sheet, Colour-coded inter connecting wire set, Cable ties, Blank Module, Sticking saddles, Circuit identification labels. •There is a provision for-
1) SPN: DP MCB /Isolator/ RCCB/RCBO as incomer & SP MCBs as outgoings.
2) TPN: FP MCB /Isolator/ RCCB/RCBO as incomer & SP/TP MCBs as outgoings.





Code	Item	No of Modules			MRP ₹	Pkg. Outer/ Master
		Incomer	Sub Incomer	Outgoing		
		AIR DOUBLE DOOR (METAL) DB - IP43- TPN HORIZONTAL PPI				
07076	4+2 Way	8	2+2+2	4+4+4	6445.00	1/4
07077	6+2 Way	8	2+2+2	6+6+6	7910.00	1/4
07078	8+2 Way	8	2+2+2	8+8+8	9365.00	1/4
07079	12+2 Way	8	2+2+2	12+12+12	10301.00	1/1
07080	16+2 Way	8	2+2+2	16+16+16	11330.00	1/1

Code	Item	No of Modules			MRP ₹	Pkg. Outer/ Master
		Incomer	Sub Incomer	Outgoing		
		AIR DD (METAL) DB - IP43- TPN TIER PPI				
07086	4+2 Way	8	2+2+2	4+4+4	5623.00	1/1
07087	6+2 Way	8	2+2+2	6+6+6	7636.00	1/1
07088	8+2 Way	8	2+2+2	8+8+8	9450.00	1/1
07089	10+2 Way	8	2+2+2	10+10+10	10868.00	1/1
07090	12+2 Way	8	2+2+2	12+12+12	11094.00	1/1
07091	16+2 Way	8	2+2+2	16+16+16	11813.00	1/1

•Conforms to IS 8623-1 & 3, IEC 61439-1 & 3 •Reversible double door for IP-43 & IK-09 Dbs. •Suitable for Surface & Flush Mounting. •Enclosure is made up of CRCA Sheet steel, RAL 9002 Powder coated, •Ready to use DBs- includes 100A insulated Phase Bus-bar, Shrouded Neutral / Earth bars with conditional Short Circuit Rating. This DB's Kit includes high integrity accessories like Cement spill protector sheet, Colour-coded inter connecting wire set, Cable ties, Blank Module, Sticking Saddles, Circuit identification labels. •There is a provision for FP MCB /Isolator/RCCB/RCBO as incomer & DPRCCB/RCBO as sub-comer, SP MCBs as outgoing.

*suitable for 3P/4P MCCB as incomer

Code	Item	No of Modules			MRP ₹	Pkg. Outer/ Master
		Incomer	Sub Incomer	Outgoing		
		AIR DD (METAL) DB - IP43- TPN PHASE SEGREGATED- 7 SEGMENT				
07096	4 Way	8	4+4+4	4+4+4	8288.00	1/1
07097	6 Way	8	4+4+4	6+6+6	9365.00	1/1
07098	8 Way	8	4+4+4	8+8+8	10763.00	1/1
07099	12 Way	8	4+4+4	12+12+12	13457.00	1/1

•Conforms to IS 8623-1 & 3, IEC 61439-1 & 3 IP-43 & IK-09 for double door. •Suitable for Surface & Flush mounting. •Separate compartment for incomer, Sub-incomer & Outgoing device. •Enclosure is made up of CRCA Sheet steel, RAL 9002 Powder coated, •Ready to use DBs- includes 100A insulated Phase Bus-bar, Shrouded Neutral / Earth bar with Conditional short circuit Rating. This DB's kit includes high integrity accessories like Cement spill protector sheet, Colour-coded inter connecting wire set, Cable ties, Blank module, Sticking Saddles, Circuit identification labels. •There is a provision for-

- 1) Modular Incomer - FP MCB/Isolator as incomer, DP RCCB/RCBO as sub-incomer & SP MCBs as outgoing.
- 2) MCCB Incomer -TP/FP MCCB as incomer, DP RCCB/RCBO as Sub-incomer & SP MCBs as outgoing.

Code	Item	No of Modules			MRP ₹	Pkg. Outer/ Master
		Incomer	Sub Incomer	Outgoing		
		AIR DD (METAL) DB - IP43- VERTICAL TPN MCB IC				
07106	4 Way	8	-	4+4+4	8987.00	1/1
07107	6 Way	8	-	6+6+6	10764.00	1/1
07108	8 Way	8	-	8+8+8	11302.00	1/1
07109	12 Way	8	-	12+12+12	14203.00	1/1
07110	16 Way	8	-	16+16+16	17719.00	1/1

•Conforms to IS 8623-1 & 3, IEC 61439-1 & 3 •Reversible Door for IP-43 & IK-09 Dbs. •Suitable for Surface & Flush mounting. •Enclosure is made up of CRCA Sheet steel, RAL 9002 Powder coated, •Ready to use DB includes insulated Vertical Phase Bus-bar, Shrouded Neutral / Earth bar with Conditional Short Circuit Rating. This DB's kit includes high integrity accessories like Cement spill protector sheet, Colour-coded inter connecting wire set, Cable ties, Blank Module, Sticking Saddles, Circuit identification labels. •There is a provision for-

- 1) MCB IC : FP MCB/Isolator/RCCB/RCBO as incomer & SP/TP MCBs as outgoing.
- 2) MCCC IC: MCCB as incomer & SP/TP MCBs as outgoing,

*suitable for 3 pole / 4 pole MCCB as incomer.

* introducing shortly

Code	Item	No of Modules			MRP ₹	Pkg. Outer/ Master
		Incomer	Sub Incomer	Outgoing		
		AIR DD (METAL) DB - IP43- FLEXI ROW				
Modules Per Row						
07126	2 Row	-	-	14	4848.00	1/1
07127	3 Row	-	-	14	5765.00	1/1
07128	4 Row	-	-	14	6407.00	1/1
07129	4 Row	-	-	16	6993.00	1/1

•Conforms to IS 8623-1 & 3, IEC 61439-1 & 3 •Reversible Door for IP-43 & IK-09 Dbs. •Suitable for Surface & Flush mounting. •Enclosure is made up of CRCA Sheet steel, RAL 9002 Powder coated, •Ready to use DB includes Shrouded Neutral /Earth bar with Conditional Short Circuit Rating. Bus bar to be selected as per distribution requirements. This DB's kit includes high integrity accessories like Cement spill protector sheet, Cable ties, Blank Module, Sticking Saddles, Circuit identification labels. •There is a provision to mount modular devices as per requirement.

Code	Item	No of Modules			MRP ₹	Pkg. Outer/ Master
		Incomer	Sub Incomer	Outgoing		
		AIR DD (METAL) DB IP-43 TPN 63A PHASE SELECTOR				
07131	4 Way	8	-	4+4+4	11529.00	1/1
07132	6 Way	8	-	6+6+6	12030.00	1/1
07133	8 Way	8	-	8+8+8	13060.00	1/1
07134	12 Way	8	-	12+12+12	14714.00	1/1

•Conforms to IS 8623-1 & 3, IEC 61439-1 & 3 •Reversible Door for IP-43 & IK-09 Dbs. •Suitable for Surface & flush mounting. •Enclosure is made up of CRCA Sheet steel, RAL 9002 Powder coated, •DB has two separate compartments for MCB & Phase selector Switches, which includes 3 Nos. of 63A rotary switches, 3 Nos. of Rocker Switches for Phase identification, 100A insulated Phase Bus-bar, Shrouded Neutral /Earth bar with Conditional Short Circuit Rating. This DB's kit includes high integrity accessories like Cement spill protector sheet, Colour-coded inter connecting wire set, Cable ties, Blank Module, Sticking saddles, Circuit identification labels. •There is a provision for FP MCB /Isolator/RCCB/RCBO as incomer & SP/TP MCBs as outgoing.

Code	Item	No of Modules			MRP ₹	Pkg. Outer/ Master
		Incomer	Sub Incomer	Outgoing		
		AIR DD (METAL) DB IP-43 TV/TEL. SPN				
07141	4 Way	2	-	2	2645.00	1/6
07142	6 Way	2	-	4	3116.00	1/6
07143	8 Way	2	-	6	4054.00	1/4
07144	12 Way	2	-	10	4574.00	1/4
07145	16 Way	2	-	14	5338.00	1/4

•Conforms to IS 8623-1 & 3, IEC 61439-1 & 3 •Reversible Door for IP-43 & IK-09 Dbs. •Suitable for Surface & Flush Mounting. •Enclosure is made up of CRCA Sheet steel, RAL 9002 Powder coated, •Ready to use DBs- includes 100A insulated Phase Bus-bar, Shrouded Neutral /Earth bar with Conditional Short Circuit Rating & having telephone socket & TV co-axial socket. This DB's kit includes high integrity accessories like Cement spill protector sheet, Colour-coded inter connecting wire set, Cable ties, Blank Module, Sticking Saddles, Circuit identification labels. •There is a provision for-

- 1) SPN: DP MCB /Isolator/ RCCB/RCBO as incomer & SP MCBs as outgoing.
- 2) TPN: FP MCB /Isolator/ RCCB/RCBO as incomer & SP/TP MCBs as outgoing.

Code	Item	No. of Pins		Modules	MRP ₹	Pkg.
		P	N			
07037	20A 2 Pin Soc.	-	P + N	-	201.00	10/100
07038	20A 2 Pin Plug	-	P + N	-	193.00	10/100
07201	Blanking Plate	-	-	1	16.00	50/500

Code	Item	No. of Pins		Modules	MRP ₹	Pkg.
		P	N			
AIR DD (METAL) DB IP-43 BUS BAR CHAMBER NEW						
07171	32A/415V	-	-	4	2278.00	1/5
07172	63A/415V	-	-	4	3712.00	1/5
07173	100A/415V	-	-	4	4520.00	1/3
07174	200A/415V	-	-	4	7807.00	1/2
07175	320A/415V	-	-	4	11906.00	1/1
07176	400A/415V	-	-	4	16847.00	1/1
07177	630A/415V	-	-	4	29806.00	1/1



Solving your electrical challenges, precisely.



AirecoDB

The AirEcoDB distribution boards are sleek, stylish and elegant in appearance. Its appearance reflects the supremely minimalistic look of the AIR Range to which it belongs. Its crisp, clean lines accentuate the powder-coated, superior finish and durability of the product. Suitable for flush and wall mounting, the AIR DBs offer ample space for easy installation of MCBs, RCCBs and for all the wiring required. The AIR Distribution Board also complies with all the standard requirements and is water and weather resistant so that it retains its international look even after years of use.

Code	Item	No of Modules			MRP ₹	Pkg. Outer/ Master
		Incomer	Sub Incomer	Outgoing		

AIR ECO DOUBLE DOOR (METAL) DB - IP42 - SPN NEW						
07211	4 Way	2	-	2	1227.00	1/12
07212	6 Way	2	-	4	1394.00	1/12
07213	8 Way	2	-	6	1691.00	1/8
07214	10 Way	2	-	8	1914.00	1/8
07215	12 Way	2	-	10	2211.00	1/8
07216	16 Way	2	-	14	2619.00	1/6

AIR ECO DOUBLE DOOR (METAL) DB - IP42 - TPN NEW						
07221	4 Way	4	-	4+4+4	3425.00	1/4
07222	6 Way	4	-	6+6+6	4087.00	1/4
07223	4 Way	8	-	4+4+4	3846.00	1/4
07224	6 Way	8	-	6+6+6	4015.00	1/4
07225	8 Way	8	-	8+8+8	4675.00	1/4
07226	12 Way	8	-	12+12+12	6215.00	1/1

•Conforms to IS 8623-1 & 3, IEC 61439-1 & 3 •Reversible Door for IP-42 & IK-09 Dbs.
 •Suitable for Surface & Flush mounting. •Enclosure is made up of CRCA Sheet steel, RAL 9002 Powder coated, •Ready to use DBs- includes 100A insulated Phase Bus-bar, Shrouded Neutral /Earth bar with Conditional short circuit Rating. This DB's kit includes high integrity accessories like Cement spill protector sheet, Colour-coded inter connecting wire set, Cable ties, Blank Module, Sticking saddles, Circuit identification labels. •There is a provision for-
 1) SPN: DP MCB /Isolator/ RCCB/RCBO as incomer & SP MCBs as outgoing.
 2) TPN: FP MCB /Isolator/ RCCB/RCBO as incomer & SP/TP MCBs as outgoing.

AIR ECO DD (METAL) DB IP-42 TPN 63A PHASE SELECTOR (without rotary switch & wiring) NEW						
07231	4 Way	8	-	4+4+4	4950.00	1/1
07232	6 Way	8	-	6+6+6	5748.00	1/1
07233	8 Way	8	-	8+8+8	6655.00	1/1
07234	12 Way	8	-	12+12+12	8261.00	1/1

•Conforms to IS 8623-1 & 3, IEC 61439-1 & 3 •Reversible Door for IP-42 & IK -09 Dbs .
 •Suitable for Surface & flush mounting. •Enclosure is made up of CRCA Sheet steel, RAL 9002 Powder coated, •DB has two separate compartments for MCB & Phase selector Switches, 100A insulated Phase Bus-bar, Shrouded Neutral /Earth bar with Conditional Short Circuit Rating. •There is a provision for FP MCB /Isolator/RCCB/RCBO as incomer & SP/TP MCBs as outgoing.

AIR ECO DD (METAL) DB IP-42 TPN PHASE SELECTOR (with 40A Rotary switch & wiring) NEW						
07237	4 Way	8	-	4+4+4	8499.00	1/1
07238	6 Way	8	-	6+6+6	9499.00	1/1
07239	8 Way	8	-	8+8+8	10499.00	1/1

AIR ECO DD (METAL) DB IP-42 TPN PHASE SELECTOR (with 63A Rotary switch & wiring) NEW						
07241	4 Way	8	-	4+4+4	9405.00	1/1
07242	6 Way	8	-	6+6+6	10780.00	1/1
07243	8 Way	8	-	8+8+8	11880.00	1/1
07244	12 Way	8	-	12+12+12	13795.00	1/1

•Conforms to IS 8623-1 & 3, IEC 61439-1 & 3 •Reversible Door for IP-42 & IK -09 Dbs .
 •Suitable for Surface & flush mounting. •Enclosure is made up of CRCA Sheet steel, RAL 9002 Powder coated, •DB has two separate compartments for MCB & Phase selector Switches, which includes 3 Nos. of 40A/63A rotary switches, 3 Nos. of Rocker Switches for Phase identification, 100A insulated Phase Bus-bar, Shrouded Neutral /Earth bar with Conditional Short Circuit Rating. This DB's kit includes high integrity accessories like Cement spill protector sheet, Colour-coded inter connecting wire set, Cable ties, Blank Module, Sticking saddles, Circuit identification labels. •There is a provision for FP MCB /Isolator/RCCB/RCBO as incomer & SP/TP MCBs as outgoing.



Creating amazing lifestyles.
Since 1979.



Ceiling Fans | Table, Wall & Pedestal Fans
Cabin & Portable Fans | Axial & Ventilation Fans



UPVC Round Conduit FRLS | Fittings



LED LIGHTING FITTING
Panel & Downlight | COB Downlight & Spot Light | Linear Light
Surface Light | Flood & Street Light | Bulkhead & Highbay
Batten & Lamp | Strip & Rope Light



FR | FR-LSH | ZHFR | HRFR | Tele. & Switchboard
Jelly Flooded Co-axial | Submersible 3 Core Flat & Service Cables
CTS & VIR Cables | Multicore Round Flexible
Computer & Lan Networking | CCTV & Speaker Cables



KNX Lifestyle Touch Panels & Push Buttons

Goldmedal is proud to present the world's most superior automation technology: the KNX Lifestyle Automation Solution.

Now, make your home smart and control it with ease, using the most modern, flexible, and stylish automation system available in the market. From young users to the oldest, every member in your family can use the soft touch push buttons, touch pads and switches to control every electrical aspect of your home. That's not all, they can even use their smart phones and tablets to control the system remotely from anywhere in the world.

The KNX Lifestyle Automation Solution incorporates all the latest technologies like DALI, Tunable White, RGB & RGB-W Control, Human Centric Lighting Control and is ready for all future upgrades.

From a single living room to a full commercial airport, Goldmedal's KNX Lifestyle Automation Solution has answers for all your automation needs. If you are thinking of automating your home or office, get in touch with us, now.



Lifestyle 27
7" Wall Mounted Touch Screen



Lifestyle 27
4" Wall Mounted Touch Screen



For order enquiries, please log into Dhan Barse App or call Customer Care at 91 9711 09 09 09. You can also write to us at automation@goldmedalindia.com.



Lifestyle 09
Push Button with Room Temperature Control in Black Velvet



Lifestyle 09
Push Button with 6 Switches in Beige Velvet



Lifestyle 09
Push Button 8 Switches in Antique Copper



Lifestyle 09
Push Button 12 Switches in Antique Bronze



Lifestyle 07
3 Button Touch Switches in Alpine White



Lifestyle 07
4 Button Touch Switches in Silver Streak



Lifestyle 18
3 Button Touch Switches in Crystalline White



Lifestyle 18
4 Button Touch Switches in Crystalline Black



Lifestyle 90
Bluetooth Remote Control
White



Lifestyle 90
Bluetooth Remote Control
Black

Bluetooth Remote Controllers

Goldmedal's G-Mesh solution is based on Bluetooth Low Energy (BLE), the state-of-the-art wireless technology that powers all modern smartphones, tablets, and even smart watches. BLE is thus the only mainstream and future-proof, low power radio technology in the world.

A self-organizing wireless mesh network, Goldmedal's G-Mesh technology can control a large number of electrical fixtures from any point in the room. The G-Mesh does not require Internet for carrying out regular operations. The Internet is only required at the time of configuring the user interface, during installation. Even firmware updates can be done over-the-air, without the Internet.

What makes it even more exciting is that G-Mesh technology works with your existing wiring – so there's no need to drill any new holes or carry out any additional wiring. Now isn't that amazing!

Bluetooth Controller

G-Mesh products can handle DALI, Tunable White, RGB & RGB-W Control, Human Centric Lighting Control and is also ready for all future upgrades. While this may sound complex, it will surprise you to know that G-Mesh commissioning and set up is so simple that even a child can do it! Yes, even changing a lighting scenario is a simple task.

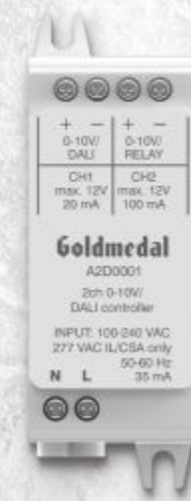

A2D0001 is a BLE-enabled 2 channel 0-10V or DALI controller. It has a universal 100-277V AC input voltage range and can control 2 separate analog channels, 1 Tunable White channel, or one Dali channel.



PWM0004 is a BLE-enabled four-channel PWM dimmer for constant voltage LED loads, such as LED strips and constant voltage LED modules. The same device can be used for both 12 and 24V DC LED strips. Separate drivers are not required for LED strip or RGB Strip dimming.



ASD0001 is a BLE-control unit for LED drivers with 0-10V, 1-10V, or DALI dimming interface. The control output can be configured either as analogue 0-10V (and 1-10V) or as a digital standalone DALI control interface.



DCS0001 is a BLE-enabled DALI controller. It does not have its own power supply. Instead, it is powered directly from a DALI bus. DCS0001 can be used with a DALI sensor for presence detection or daylight harvesting or it can be used for controlling Human Centric Lighting (HCL).



TED0001 is a BLE-enabled trailing-edge dimmer for operation of incandescent lamps, dimmable LED lamps, and dimmable LED control gear. It can be installed in the ceiling, inside a luminaire, or into a ceiling outlet box.



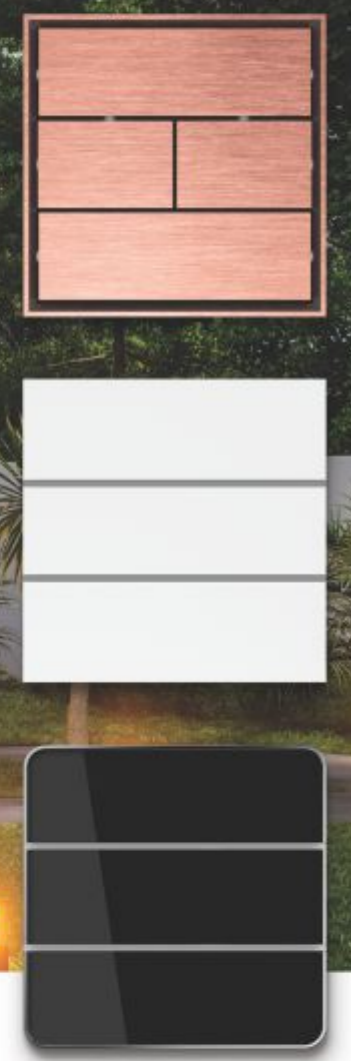

Solutions to all your automation needs under one roof!

If you are planning to build a new home or a commercial building, you are bound to face a number of technical and financial challenges. These challenges have only grown with time. At Goldmedal, we present you a one-stop, complete home automation solution, under one roof.

Whether it's a single room, the entire house, a building, or a huge office complex, Goldmedal has the products and skills to automate them for you. Your goals can range from energy efficiency to increasing productivity to enhancing your lifestyle to a mix of other needs... we can tailor our solutions as per your demands.

The way you interact with your home or office can also be customized. Besides traditional interfaces like wall switches, push buttons, and touch panels, you can also control the automation through our mobile apps, smart phones, tablets, and smart watches.

With Goldmedal, the answers to all your home automation needs is just one call away!



Bringing our world closer to you!

Experience the amazing - at your doorstep!

Presenting Goldmedal's Mobile Showroom - a never-before-seen concept in the world of wiring devices and accessories. Now, instead of visiting a showroom or a retail store, you can simply walk into this mobile store at a location nearest you. Designed by renowned automobile designer Dilip Chabria, this innovative yet thoughtfully crafted mobile showroom displays Goldmedal's latest products in a superbly premium environment.

There are multiple such mobile showrooms that ply the length and breadth of the country. You can track their movements online to check when one of them will be closest to your location. There are no reservations to be made. Just walk up to the mobile store and you will be welcomed with open doors! A Goldmedal executive in the showroom will be happy to assist you. We look forward to seeing you inside our amazing store!

MOBILE SHOWROOM FEATURES

- LED Displays
- AC Environment
- Stylish, Ambient Light
- Multi Product Display
- Interactive Touch Screen
- Live GPS Tracking
- Executive Available

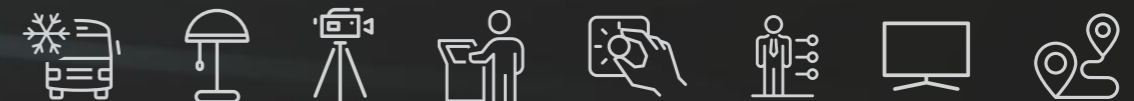

Goldmedal

Walk in – and be amazed!

Walk into Goldmedal's Mobile Showroom and be ready to get amazed! This unique showroom on wheels proudly displays the latest and the most innovative products from the company in a contemporary and aesthetically appealing environment that you now associate with the Goldmedal brand.

We welcome you to touch, feel, and interact with each of the products on display. There is no time limit for your visit. If you have a question, an experienced Goldmedal executive will be at hand to provide you all the information you need.

SHOWROOMS

WEST

MUMBAI

E-1, Laxmi Industrial Estate,
New Link Road,
Andheri West, Mumbai - 400053
Tel: +91-22-40031075
Email: info@goldmedalindia.com

EAST

KOLKATA

Merlin Homeland Mall, Shop No. 123, 1st Floor,
18B, Ashutosh Mukherjee Road, Bhawanipore,
Kolkata - 700 020. Tel: +91- 8336956017
Email: kolkata@goldmedalindia.com

SILIGURI

International Market, 2nd Floor, Shop No. 3 & 4,
Sevoke Road, Near Panitanki More,
Beside Sky Star Building, Siliguri - 734001,
West Bengal. Tel: +91-8336907033
Email: ritesh.g@goldmedalindia.com

NORTH

NOIDA

H-204, Sec-63
Noida, Uttar Pradesh - 201307
Tel: +91-120-4135901
Email: noida@goldmedalindia.com

JAIPUR

Goldmedal Electricals Private Limited
55, New Aatish Market, Mansarovar,
Jaipur - Rajasthan.
Tel: +91-291-3261955
Email: rajasthan@goldmedalindia.com

JALORE

Head Post Office Road,
Jalore - 343001, Rajasthan, India.
Tel: +91-2973222568
Email: rajasthan@goldmedalindia.com

SOUTH

HUBBALLI

Umachagi Complex, Koppikar Road, Hubballi,
Karnataka-580020
Tel: +91-0836-4258466
Email: bangalore@goldmedalindia.com

HYDERABAD

S-1, Ground Floor, Kalphakunja
Apartment 5-2-84/87, Jambagh,
Hyderabad-500095, Telangana
Tel: +91-40-24610722 / 9849172122
Email: hyderabad@goldmedalindia.com

VIJAYAWADA

2nd Floor, PVP Mall, Mahatma Gandhi Rd,
Labbipet, Vijayawada-520010, Andhra Pradesh
Tel: +91-9885676400
Email: vijayawada@goldmedalindia.com

VIJAYAWADA

D. NO. 11-33-15, Tatakulavari Street,
Vijayawada-520 001, Andhra Pradesh
Tel: +91-866-6542000 / 8977574737
Email: vijayawada@goldmedalindia.com

KADAPA

21/96, Reddy Complex, Near 7 Road Circle,
Opp. Reddy Express, Kadapa- 516001, Andhra
Pradesh.
Tel: +91-9885676400
Email: vijayawada@goldmedalindia.com

CALICUT

Shaherzad Shopping Complex, CH Flyover Junction,
Cherrooty Road, Calicut - 673001, Kerala.
Tel: +91-9048743111
Email: calicut@goldmedalindia.com

COCHIN

3rd Floor, G K Arcade, Palarivattom Bye Pass Junction,
Ernakulam - 682028, Kerala.
Tel: +91-9324936290
Email: calicut@goldmedalindia.com

BRANCHES

WEST

MUMBAI

119, Maskati Mahal, 3rd Floor, Room
No.1- B, Loharchawl, Marine Line,
Mumbai - 400002, Maharashtra, India.
Tel: +91-22-39567558
Email: info@goldmedalindia.com

PALGHAR

Bldg. No.5, Shah Industrial Estate,
Opp. Masjid, Mourya Naka, Sativali,
Vasai (E), Palghar-401208, Maharashtra
Tel: +91-22-42023026
Email: mumbai@goldmedalindia.com

PUNE

741/1, Shop No.1 & 2, Ground Floor,
Kushal Sagar Complex, Ganesh Road,
Budwar Peth, Pune - 411002,
Maharashtra, India. Tel: +91-
9822098620
Email: pune@goldmedalindia.com

AHMEDABAD

Block No. 43, Behind Savex Technologies
Warehouse, Sanathal Bakrol Ring Road,
Village Badrabad, Ahmedabad,
Gujarat- 382210
Tel: +91-9372200393
Email: ahmedabad@goldmedalindia.com

BHOPAL

Way No. 11-12, Multi Industries
Warehouse, Plot No. 13C, Industrial Area
Govindpura, Bhopal,
Madhya Pradesh - 462023
Tel: +91-9589080144
Email: bhopal@goldmedalindia.com

RAIPUR

1st Floor, Plot No.15, Kedia Business Park,
Tatibandh, Raipur, Raipur - 492099,
Chhattisgarh, India.
Tel: +91-7714910078
Email: raipur@goldmedalindia.com

EAST

KOLKATA

1/1B/4, Ram Krishna Naskar Lane
Beliaghata, Kolkata - 700010
West Bengal.
Tel: +91-8336907040
Email: kolkata@goldmedalindia.com

PATNA

Plot No.846, Mohalla East Ashu Chak,
P.o. Purvilakshmi Nagar, Krishna Niketan
School Road, Agamkuan, Patna-800030,
Bihar, India. Tel: +91-9798606400
Email: patna@goldmedalindia.com

RANCHI

R S Plot No.2072, Near Dalaldali Chowk,
Simaliya, P. S, Ratu, Ranchi - 834005,
Jharkhand, India.
Tel: +91- 9431170402
Email: ranchi@goldmedalindia.com

GUWAHATI

NH-37, Near Tirupati Parking,
Opp. Audi Showroom,
Guwahati-781029, Assam, India.
Tel: +91- 9718077070.
Email: guwahati@goldmedalindia.com

CUTTACK

Plot No.1047 & 1048, Opp. Axis Bank,
Jagatpur, Cuttack- 754021, Odisha
(Orissa), India. Tel: +91- 9437452303
Email: cuttack@goldmedalindia.com

NORTH

JODHPUR

Plot no. E-99A, M. I. A.
Basni 2nd Phase, Jodhpur,
Rajasthan - 342005.
Tel: +91-9772210543
Email: rajasthan@goldmedalindia.com

LUCKNOW

C1 - 5, Phase-2, Transport Nagar,
Lucknow - 226012, Uttar Pradesh, India.
Tel: +91-8780887400
Email: lucknow@goldmedalindia.com

NOIDA

H-204, Sec-63, Noida,
Uttar Pradesh - 201307
Tel: +91-120-4135901
Email: noida@goldmedalindia.com

DEHRADUN

A-39, Transport Nagar, Sewla Khurd,
Dehradun-248001, Uttarakhand, India.
Tel: +91-135 - 2649522
Email: dehradun@goldmedalindia.com

SOUTH

MOHALI

855/C, Janta Industrial Estate,
Sector - 82, Mohali, Mohali-160055,
Punjab, India.
Customer Care : 1800 209 0234
Email: mohali@goldmedalindia.com

BENGALURU

Level 2/3/4, Regal Arcade No. 1-2,
5th Cross, Mysore Road, Bengaluru,
Karnataka - 560026
Tel: +91-80-41687799/41759977
Email: bangalore@goldmedalindia.com

VIJAYAWADA

20-127/2, By Pass Road, Gollapudi,
Krishna District, Vijayawada - 521225,
Andhra Pradesh
Tel: +91-866-6542333/6542888
Email: vijayawada@goldmedalindia.com

HYDERABAD

Central Warehouse Corporation
A2, P B No 34, Behind Gandhi Bhavan,
Nampally, Hyderabad-500001, Telangana
Tel: +91-40-29706099
Email: hydteam@goldmedalindia.com

CHENNAI

92/6, Nattu Pillaiar Koil Street
Sowcarpet, Chennai - 600001,
Tamil Nadu, India.
Tel: +91-44-49521008
Email: chennai@goldmedalindia.com

CALICUT

Door No.1/60, Baby Marine Export
Compound, Temple Road,
West Hill Calicut, Kozhikode (Calicut),
Kozhikode-673005, Kerala, India.
Customer Care : 1800 209 0234
Email: calicut@goldmedalindia.com

NOTES

NOTES

Brand Identity, Concept &
Design copyright by
GOLDMEDAL ELECTRICALS PVT. LTD.

www.goldmedalindia.com

Commercial Term & Conditions

• All prices are in Indian Rupees (inclusive of GST) •
Prices mentioned in this price list are of standard
products • Warranty applicable on products are as
per Goldmedal's warranty policy • Prices are
subject to change without prior notice • This price
list supersedes all previous price lists • Continuous
design and product development is a routine
practice at Goldmedal, so data in this price list
provided may change without prior information or
notice, Customers are advised to check current
data before purchasing any product.