



KAY PARK RECREATION

MAKING PLACES PEOPLE FRIENDLY • **SINCE 1954**

Family Owned and Operated



American Made Quality for 69 Years!



Tables, Benches, Litter Receptacles, Grills, Bike Racks, Highway Towable Bleachers & Stages and so MUCH MORE!



1-800-553-2476 Thousands of Products Online WWW.KAYPARK.COM

Umbrellas



Square Umbrellas Wind Resistant

- 6' or 7 1/2' fiberglass ribs
- 7 1/2' and 9' diameter
- 1 1/2" 1 piece aluminum pole white or bronze finish
.065 wall thickness
- Push up or Pulley and Pin
- No Tilt

ULSQ6MP	6' Marine Grade, Pulley & Pin	24 Lbs
ULSQ6MU	6' Marine Grade, Push Up	24 Lbs
ULSQ7MP	7 1/2' Marine Grade, Pulley & Pin	24 Lbs

Marine Grade Fabric Colors:



Detail of Crank

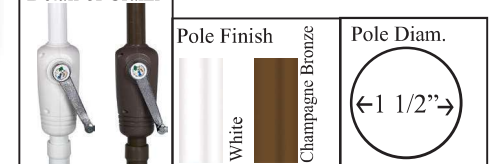

Garden Valance 6 Rib Wind Resistant

- 6 fiberglass ribs
- 3/8" Dia.
- 7 1/2' diameter
- 1 1/2" 2 piece aluminum pole white or bronze finish
.065 wall thickness
- Textilene Fabric
- Crank mechanism
- No Tilt

UVFL7-TC	7 1/2 ft Textilene crank	15 Lbs
-----------------	--------------------------	--------

Colors:

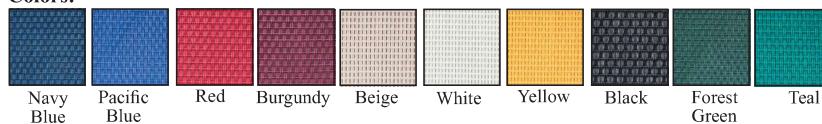

Market Octagon 8 Rib Wind Resistant

- 8 fiberglass ribs
- 1/2" Diam.
- 7 1/2', 9' or 11' diameter
- 1 1/2" 2 piece aluminum pole white or bronze finish
.080 wall thickness
- Crank, push up or pulley and pin
- No Tilt

UOM7MC	7 1/2' Marine grade fabric, crank	17 Lbs
UOM7MU	7 1/2' Marine grade fabric, push up	17 Lbs
UOM9MC	9' Marine grade fabric, crank	19 Lbs
UOM9MP	9' Marine grade fabric, pulley & pin	19 Lbs
UOM11MP	11' Marine grade fabric, pulley & pin	20 Lbs

Marine Grade Fabric Colors:

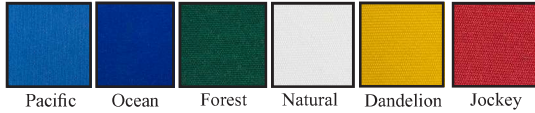

Detail of Crank

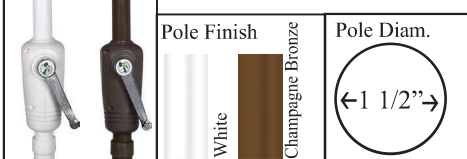

Note: Alternating colors are available. Add "A" to model and **10%** to price.

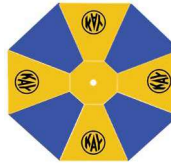

Logos available, please inquire for customized pricing.



Detail of Hub

Commercial Ultra Heavy Wind Resistant

- 8 fiberglass ribs
- 1/2" Dia.
- 7 1/2', 9' or 11' diameter
- 1 1/2" 1 piece aluminum pole white or bronze finish
.125 wall thickness
- Push up or pulley and pin
- No Tilt

ULP7MU	7 1/2' Marine grade fabric, push up	15 Lbs
ULP9MU	9' Marine grade fabric, push up	17 Lbs
ULP11MP	11' Marine grade fabric, pulley & pin	26 Lbs

Marine Grade Fabric Colors:

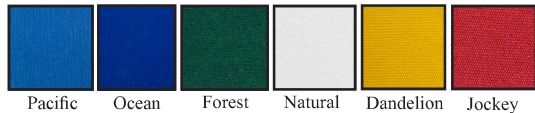

Note: Alternating colors are available. Add "A" to model and **10%** to price.

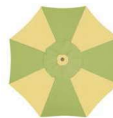

5 Year Warranty on Fabric!

5 Year no fade fabric warranty!



Champagne Bronze Pole



Detail of Hub



Wind Resistant Umbrellas

Specially designed for windy conditions. A wind vent in the top lets air out and 'fishing pole type fiberglass ribs will flex with the wind, but do not break! They come with powder coated aluminum poles. Tops are easily changed - buy- extra tops to quickly change your color scheme! Ask rep for pricing.

Pedestal Grills



Dual Cooking Grate!



Utility Shelf

SBD60035

- Dual 302 Sq. Inch Cook Surface
- 1/2" Rods on 1" Centers
- 3/16" Steel Body
- 3 1/2" Galvanized Pedestal
- Rotates 360 Degrees
- Optional Utility Shelf
- Dual 4 Position Cook Surface
- Vandal Resistant
- High Heat Black Enamel Paint

SBD60035	Standard (3 1/2") Ped.	140 Lbs
UT	Optional utility shelf	10 Lbs



Utility Shelf

SB400

- 392 Sq. Inch Cook Surface 14"x28"
- 1/2" Rods on 1" Centers
- 3/16" Steel Body
- 2 3/8" or 3 1/2" Galvanized Pedestal
- Rotates 360 Degrees
- Optional Utility Shelf
- 4 Position Cook Surface
- Vandal Resistant
- High Heat Black Enamel Paint

SB40035	Grill with 3 1/2" Ped.	110 Lbs
UT	Optional utility shelf	10 Lbs



SI1635

- 320 Sq. Inch Cook Surface
- Grate Infinitely adjustable
- 16" x 20" Firebox with 8" Sides
- 3 1/2" Galvanized Pedestal
- Rotates 360 Degrees
- 3/16" Steel Body
- Grate tips back for fire building and cleaning
- Vandal Resistant
- High Heat Black Enamel Paint

SI1635	Grill with 3 1/2" Ped.	83 Lbs
UTS1	Utility Shelf	5 Lbs



Utility Shelf

Utility Shelf - 8" x 20" x 3/16" bolts onto rear. Available for grills above. Model "UT" is painted black and model "UTG" is galvanized. Not available for ADA Pedestal **SB16ADA**. Model "UTS1" is for model **SI1635** only painted black.

Surface Mount

To add surface mount to any grill on this page add "SM" to model number and a increase in price.



WARNING: Cancer and Reproductive Harm www.P65Warnings.com



SB16 Grill

- 300 Sq. Inch Cook Surface 15"x20"
- 1/2" Rods on 1" Centers
- 3/16" Steel Body
- 2 3/8" or 3 1/2" Galvanized Pedestal
- Rotates 360 Degrees
- Optional Utility Shelf
- 4 Position Cook Surface
- Vandal Resistant
- High Heat Black Enamel Paint

Only Models:
SB16
SB16ADA

SB16	Standard (2 3/8") Ped.	79 Lbs
SB1635	3 1/2" Ped.	88 Lbs
SB1635GR	3 1/2" Ped. & gal. body	88 Lbs
UT	Optional utility shelf	10 Lbs
UTG	Optional galv. utility shelf	10 Lbs
SM	Add Surface Mount Option - See Below	



2 Day **SB16**



SB16ADA Wheel Chair Accessible Grill



ADA
Pedestal Grill

- 300 Sq Inch Cook Surface 15"x20"
- 1/2" Rods on 1" Centers
- 3/16" Steel Body
- 2 3/8", or 3 1/2" O.D. Galvanized Pedestal
- Rotates 360 Degrees
- Easy Swivel Cook Surface
- High Heat Black Enamel Paint

SB16ADA	2 3/8" Pedestal Grill	80 Lbs
SB16ADA3.5	3 1/2" Pedestal Grill	89 Lbs
UTADA	Optional utility shelf	10 Lbs
SM	Add Surface Mount Option - See Below	



2 Day **SB16ADA**



SF16 Grill

- All the features of the SB16 with the added feature of a flip back cook surface.

Only Models:
SF16

SF16	Standard (2 3/8") Ped.	79 Lbs
SF1635	3 1/2" Ped.	88 Lbs
SF1635GR	3 1/2" Ped. & gal. body	88 Lbs
UT	Optional utility shelf	10 Lbs
UTG	Optional galv. utility shelf	10 Lbs
SM	Add Surface Mount Option - See Below	



2 Day **SF16**



Hot Dip Galvanized Body

SB16 and SF16 only are available with hot dip galvanized body. Galvanized is only available with 3.5" pedestal. Cooking grate coated with black high heat paint. Please add "G" to model number.



Grill Cover

Black Vinyl Cover with drawstring closure fits standard pedestal grills.

PGCOVER 2 Lbs



Entire Page
WARNING: Cancer and Reproductive Harm www.P65Warnings.com

Group Grills



SPD450 - Large Group Grill

- 1368 Sq Inch Cook Surface 38"x36"
- 1/2" Rods on 1" Centers
- 3/16" Steel Body
- 6" Square Pedestal (Anchors Included)
- 12"x36" Bolt On Utility Shelf
- Adjustable 4 Position Fire Grate
- Flip up Grates for Easy Fire Building
- High Heat Black Enamel Paint
- Surface mount is standard

SPD450	Standard w/1 shelf SM	460 Lbs
SPD450IG	In ground mount	460 Lbs
SPDUT	Additional shelf	29 Lbs



7 Business Days



Room to Cook Enough Food For a Family Reunion!



WARNING: Cancer and Reproductive Harm www.P65Warnings.com



SB3628U - Medium Group Grill

- 1008 Sq Inch Cook Surface 28"x36"
- 1/2" Rods on 1" Centers
- 3/16" Steel Body
- 6" Square Pedestal (Anchors Included)
- 10"x28" Bolt On Utility Shelf
- 2 Separately Adjustable Cook Surfaces
- High Heat Black Enamel Paint
- Surface mount is standard

SB3628U	Standard (6" sq ped) SM	246 Lbs
SB3628UIG	In ground mount	266 Lbs



7 Business Days



XB16 - Small Group Grill

- 860 Sq Inch Cook Surface 18"x 48"
- 1/2" Rod on 1" Centers
- 3/16" Steel Body
- Two 2 3/8" O.D. Galvanized In Ground Posts
- 4 Position Adjustable Cook Surface
- High Heat Black Enamel Paint
- In ground mount is standard

XB16	Standard (2 peds) IG	197 Lbs
XB16SM	Surface Mount	177 Lbs



7 Business Days

Fire Rings



FR30 Fire Ring

- 300 Sq. Inch Cook Surface 15"x20"
- 1/2" Rods on 1" Centers
- 30" Diameter
- 3/16" Thick Steel
- "TB" = tilt back hinges
- "SAS" = spade anchors
- Cool Spring Handles
- 4 Heights Available
- High Heat Black Enamel Paint

FR730TB	7" High tilt back staples	69 Lbs
FR730SAS	7" High spade anchors	74 Lbs
FR930TB	9" High tilt back staples	88 Lbs
FR930SAS	9" High spade anchors	95 Lbs
FR1130TB	11" High tilt back staples	105 Lbs
FR1130SAS	11" High spade anchors	116 Lbs
FR1830WCSAS	18" High Sides ADA Compliant fire ring	130 Lbs

Flip - Up Grate,
Flips out of the way!

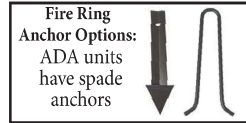

ADA
Unit

30" Diameter



AFG80 Fire Ring

- 300 Sq. Inch Cook Surface 15"x20"
- 1/2" Rods on 1" Centers
- 34" Diameter
- 6" High Sides (18" High Sides for ADA)
- 4 Adjustable Cooking Heights
- Reinforcing Angle Across Pit
- Cool Spring Handles
- Vandal Resistant
- High Heat Black Enamel Paint
- AFG80WCSAS is ADA compliant

AFG80TB	AFG80 Tilt back staples	86 Lbs
AFG80SAS	AFG80 Spade anchors	91 Lbs
AFG80WCSASR	ADA Compliant fire ring	167 Lbs

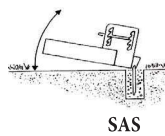

ADA
Unit

34" Diameter



Swivel Grate Fire Ring

- 32" Diameter
- 300 Square inch cooking grate
- Cooking grate rotates 180 degrees
- 9" height
- Tilt back staples
- Made from 3/16" steel
- High Heat Black Enamel Paint

FR930SWTB	Swivel Grate	84 Lbs
------------------	--------------	--------



WARNING: Cancer and Reproductive Harm www.P65Warnings.com

Fire Rings & Ash Receptacles

DOUBLE WALLED FIRE RING

- 370 Sq. Inch Cook Surface 15"x20"
- 1/2" Rods on 1" Centers
- 30" Diameter
- 18" Height
- 3/16" Thick Steel
- "SAS" = spade anchors
- Cool Spring Handles
- Double Wall
- High Heat Black Enamel Paint

FRDW1830TB DOUBLE WALL 186 Lbs



Recommended for any public picnic grounds where charcoal grills are being used!

Steel Coal Ash Receptacle

- 23" Square top funnels to 12"
- Holds 32 gallon trash
- Or let coals fall to concrete slab
- Black Powder Coat Finish

KPHCB 23" Square Recept. 90 Lbs
CG32HDNL 32 Gal Galv. Can 25 gauge 15 Lbs
KPHCBSM Surface mount 5 Lbs
KPHCBANCH Ground Anchors 3 Lbs



Promote Fire Prevention

Hot Ash Receptacle

- 22"sq. x 35" tall
- Welded steel bars on top
- Select color and texture when ordering

CHAR2235 650 Lbs

Concrete Options:
Concrete colors and aggregate textures.

	Smooth	Light Sand Blast	Perma Stone	Dura Brite
Dove Gray				
Terra Cotta				
Light Brown				
Sand Tan				

Select Texture: Smooth, Light Sand Blast, Perma Stone or Durabrite *Select Color: Dove Gray, Terra Cotta, Light Brown or Sand Tan*



Ash Shovel

ASHSHOVEL Ash Shovel 1 Lbs



Dogipot Pet Waste Disposal System - 2 Year Ltd Warranty



Dogipot Poly Station

- Forest Green Poly Dispenser
- Forest Green 10 gal Poly Trash Receptacle
- Snap on Lid (holds bag in place)
- 2" x 2" x 4'-8" poly telescopic mounting post with installation hardware
- Clearly Printed Instructions on Top
- Locked Bottom Compartment
- Aluminum DOGIPOT Pet Sign (Choice of On or Off leash)
- 2 Litter Bag Rolls @ 200 Bags Each
- 50 Ten Gal. Trash Liner Bags
- Mounting Hardware

KDP1010 Poly station, complete 23 Lbs



Dogipot Pet Station

- 15.5" x 9.4" x 3.25" Aluminum Bag Dispenser
- Locking Front Access Panel
- Clearly Printed Instructions
- "Please clean up after your dog"
- 2 Rolls (200 ea.)
- 8' Telescoping Gal. Steel Post for Direct Bury
- 10 Gallon Steel Trash Receptacle with Lid
- 50 Heavy-duty Drawstring Trash Liner Bags
- 12" x 18" Aluminum DOGIPOT Pet Sign (Choice of On or Off leash)

KDP1003 Pet station, complete 62 Lbs
KDP1003BLK Black Complete Station 62 Lbs



Dogipot Header Station

- Aluminum DOGIPOT Pet Sign (Choice of On or Off leash)
- 15.5" x 9.4" x 3.25" Aluminum Bag Dispenser
- 12 Gauge Aluminum
- Powder Coated Forest Green
- Clearly Printed Instruction on Top
- 4-100CT Cards
- 10 Gallon Steel Trash Receptacle with stainless steel lid. (Can be upgraded to include the all Aluminum Trash)
- Box of 50 Count Liner Trash Bags
- Mounting Hardware

KDP1003HP Junior Header Station 29 Lbs
KDP1003HPBLK Black Header Station 29 Lbs

Dogipot Poly-Dispenser Only

- 17" x 9.4" x 3.25" Poly Bag Dispenser
- Locking Front Access Panel
- Forest Green 2.5 mm Poly Dispenser
- Clearly Printed Instructions on Top
- 2 Diamond Bag Dispenser Slots
- 400 Litter Bags Installed
- Mounting Hardware

KDP1007 Poly, dispenser only 6 Lbs

Dogipot-Dispenser Only

- 15.5" x 9.4" x 3.25" Aluminum Bag Dispenser
- Locking Front Access Panel
- Clearly Printed Instructions
- "Please clean up after your dog"
- 400 Litter Bags Installed
- Mounting Hardware

KDP1002 Junior, dispenser only 8 Lbs

Dogipot Header-Dispenser Only

- 15.5" x 9.4" x 3.25" Aluminum Bag Dispenser
- Locking Front Access Panel
- 12 Gauge Aluminum
- Powder Coated Forest Green
- Clearly Printed Instruction on Top
- 4-100CT Cards
- Mounting Hardware

KDP1002HP Junior, dispenser only 9 Lbs

Dogipot Bags



Brown litter bags come in 10, 20 or 30 roll cases of 200 ct each roll. (10 roll case is 2,000 total bags, less than 5 cents each!)

KDP140210 12 Lbs
KDP140220 24 Lbs
KDP140230 36 Lbs

Header Packs



- Fits header dispenser
- 100 Bags per Header Pack
- 20 Header Packs Per Case
- Clearly Printed Instructions on each header pack
- Perforated Tear Away Bag

KDP1402HP20 1 Header Case 10 Lbs



Trash liner bags - 50 Heavy-duty 10 gallon drawstring bags. (50 total bags, less than 44 cents each!)

KDP1404 6 Lbs



Mutt Mitt Refill Card

Mutt Mitt Refills - 10 cards per case, 80 Mitts stapled to a card. (800 Mitts). Each of 2 plys 1.0 mil thick. Made in U.S.A.

MMREFILLS 2 Ply 18 Lbs

**More
Mutt Mitt
Online!**

Outdoor Games



Disc-Connect 4

- Outdoor concrete Connect 4
- Heavy duty reinforced concrete
- Weather proof
- Virtually maintenance free
- Bead blast finish Stainless Steel
- Secured with stainless steel tamper resistant security screws
- Includes a concrete Disc collection tray
- 43"x"wx4 3/4" 105 lbs
- 48 Discs included

Disc-Connect Only:

KPDC 54'L x 42"H x 4"W 350 Lbs

Disc Connect with Support Base:

KPDCWSB 60" x 30" x 3" 446 Lbs

KPDCDISCS 48 Discs, Red & Blue Only 5 Lbs

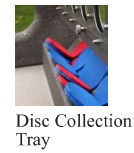

Other Outdoor Pong Table's Online

10 Year
Table Top
Warranty!



Weatherproof Steel
Nets

Outdoor Pong Table

- Thicker panel for better bounce
- Panels made from resin laminate for weather resistance
- Softmat coating to reduce sun glare
- Frame made from noncorrosive aluminum/zinc alloy
- Table top made from High Pressure Laminate
- Resistant to blows, impacts, color fading
- Soft protection pads on each order
- Frame made form zinc and aluminum alloy
- Fixed Steel Net with non corrosive treatment
- Racket holds added to the sides to store 4 rackets
- Ball dispensers under the table top
- Choose from Blue or Gray Top

CNPRO510MGR 9'L x 5'W x 30"H Gray 172 Lbs

CNPRO510MBL 9'L x 5'W x 30"H Blue 172 Lbs

NEW!



Pool Table

- Weather-proof, shock-resistant, and easy to clean
- Choice of 1 frame color: polar white or black gray
- Choice of 1 felt color: light gray or dark gray
- Choice of 1 pocket color: white, black gray, blue, orange, or yellow
- Choice of 1 outdoor dining conversion top: wood appearance or stone appearance
- Does not include any cues, balls, or other accessories
- 88" X 51" X 16"

CNOPT 88"L x 51"W x 16"H 635 Lbs

Perfect For:

- Parks
- Resorts
- Camps
- College Campuses
- Military Bases
- Playground
- Campground
- Backyards
- Apartment Complexes

Kay Park Bag Toss

All concrete construction with a smooth playing surface. Set up multiples for a great addition to park or outdoor recreation area for family outings or tournaments! **Available in gray finish only.** Add throwers blocks or bike and skate deterrents to finish the bag toss setting.

KPBT	Bag Toss (Set 2)	1330 Lbs
KPBTTB	Throwers Blocks (Set 2)	1040 Lbs
KPBTBD	Bike Deterrent	212 Lbs
KPBTSD	Skate Deterrent	8 Lbs
KPBTB	Bags (Set 8)	7 Lbs

Bag Toss Options:

Throwers Blocks



Bike Deterrent



Skate Deterrent



Custom Bag Toss Colors and Printing
Please inquire for cost.

Bag Options:

Set of 8 bags for your bag toss game. This comes with 4 of each color; choose 2 colors when ordering. Available in:



Outdoor Concrete Bag Toss

Bags Sold Separately

Bag Toss
2 Year
Warranty



Kay Park Concrete Ladder Toss

- Outdoor concrete Ladder Toss
- Heavy duty reinforced concrete
- Weather proof
- Virtually maintenance free
- Graphite Color finish
- Powder coated solid steel rungs
- Powder coating colors Black or Red, and Blue
- Base Sold Separately
- Bolas Sold Separately

KPCLTC	Color Rungs Concrete Toss	42"H x 32"W	280 Lbs
KPCLTB	Black Rungs Concrete Toss	42"H x 32"W	280 Lbs
KPSLT	Steel Ladder Toss	42"H x 32"W	160 Lbs
KPCSB	Ladder Support Base	42"H x 42"W x 3H"	425 Lbs
KPCTB	Throwers Base	42"H x 42"W x 3H"	425 Lbs
KPLTB	Bolas		2 Lbs



Throwers Base

Ladder Support Base



Kay Park Concrete Foosball

- Regulation Size Table 54 1/2" x 36" x 36"H
- Standard Finish is Natural Gray with Light Sandblast Frame
- Heavy Duty Reinforced Concrete
- Table Side Thickness 3"
- UHPC Ultra High Performance Concrete field, green and charcoal
- 316 Stainless Steel Rods
- Stenciled Playing Lines
- Center Ball Drop Holes
- Easy Access Ball Drop
- Optional Stainless Steel Scorekeepers
- Stainless Steel Table Levelers
- Optional Anchor Inserts, Stainless Steel Sold Separate
- Tamper Resistant Stainless Steel Assembly Screws
- Heavy Duty 4" High Steel I-Beam Supports
- Standard Foosball Players, Red and Blue

KPFBT	54 1/2" x 36" x 36"H	Gray	1,225 Lbs
--------------	----------------------	------	-----------



Concrete Ball Bollards

Concrete ball bollards are available in different sport balls for schools and sport facilities.

CBBB36	Baseball	36" W x 36" H	2,000 Lbs
CBBSB36	Softball	36" W x 36" H	2,000 Lbs
CBFB21	Football	21" W x 42" H	700 Lbs
CBKT18	Basketball	36" W x 36" H	2,000 Lbs
CBSCR36	Soccerball	36" W x 36" H	2,000 Lbs
CBGB36	Golfball	36" W x 36" H	1,700 Lbs



Football Bollard



Golf Bollard



Soccerball Bollard



Basketball Bollard



Baseball Bollard



Softball Bollard

Concrete Sphere Bollard

Sphere bollard comes in two sizes with a square base, very aesthetic.

CBSPH39	39"W x 39" L x 42"H	3,950 Lbs
CBSPH52	52"W x 52" L x 51"H	6,560 Lbs

Concrete Colors and finish:

	Smooth	Light Sand Blast	Perma Stone	Dura Brite
Dove Gray				
Terra Cotta				
Light Brown				
Sand Tan				

Select Color:

Dove Gray, Terra Cotta, Light Brown, or Sand Tan

Select Texture:

Smooth, Light Sand Blast, Perma Stone, or Durabrite



Great for Boosting Security!

Mounting Options:

Option A:

Bollard is precast with hollow core. Dimensions of this core are predetermined by the contractor, and need to be specified when placing the order. Existing pad, slab or sidewalk is cast with exposed vertical tubing or pipe to fit inside the core of the bollard. Before bollard is set on exposed tube. On the existing pad, epoxy, caulk, or other bonding agent is applied to core and/or vertical pipe for securing purposes. The bollard is then set in place.

Option B:

Bollard is precast with pipe or tube protruding from bottom of bollard. Dimensions of protruding pipe or tube are pre-determined by the contractor, and need to be specified when placing order. Existing pad, slab, or sidewalk is cast with sleeve correlating to protruding pipe on the bottom of the bollard. Before bollard is set, epoxy, caulk, or other bonding agent is applied to either the tube or the pipe, and/or applied to the sleeves in the existing pad. The bollard is then set in place.

Option C:

Bollard is precast with pre-determined number and pattern of inserts into the bottom of the bollard. Size and pattern of inserts are determined by the contractor and need to be specified when placing the order. The existing pad, slab or sidewalk is cast with sleeves correlating to the inserts in the bottom of the bollard. Threaded rod (included with purchase of bollard) are then screwed into the inserts in the bottom of the bollard. Epoxy, caulk, or bonding agent is applied to the rod and/or into the sleeves in the existing pad, and the bollard is set into place.

Concrete Receptacles



CTCR30MD

Has a brown plastic dome lid with self-closing door. Shown as Sand Tan Durabrite.

	Lbs
CTCR30MD 24" dia x 43"	420
CTCR30PL 30 Gal. liner	12



CTCS22PB & CTCS40PB

Holds a liner up to 22 gal.

At 40" h (to top of dome) x 20 1/2" square & has a rigid plastic bonnet top with a self-closing door. Shown in Sand Tan Durabrite. Larger, 40 gallon size model also available.

	Lbs
CTCS22PB 22 Gal. unit	400
CTC20PL 20 Gal. liner	11
CTCS40PB 40 Gal. unit	740
CTC36PL 36 Gal. liner	13



CTCR30PH

Has a dark brown rigid plastic hood top open on two sides. Shown in Sand Tan Durabrite.

	Lbs
CTCR30PH 26 1/4" dia x 44"	700
CTCR30PL 30 Gal. liner	12



CTCR30AR

Has a concave pitch in top. Shown in Light Brown Permastone.

	Lbs
CTCR30AR 24" dia x 33"	640
CTCR30PL 30 Gal. liner	11



CTCR22FP/30FP

Two pieces fit together with brown fiberglass pitch in top.

	Lbs
CTCR22FP 21" dia x 33"	300
CTCR20PL 20 Gal. liner	11
CTCR30FP 31" dia x 33"	870
CTCR30PL 30 Gal. liner	12



CTCR30AP

Has a convex spun aluminum pitch in top. Shown here in Sand Tan Permastone.

	Lbs
CTCR30AP 24" dia x 33"	420
CTCR30PL 30 Gal. liner	12



Popular Square

Features a brown pitch in top and is available in 2 sizes: 22 gal unit is 36" high x 22" square, 30 gal. unit is 30" high x 26" wide x 29" long. Shown in Sand Tan Permastone.

(22 gal top is plastic, 30 gal top is fiberglass.)

	Lbs
CTCS22FP 22 Gal. unit	620
CTC20PL 20 Gal. liner	11
CTCS30FP 30 Gal. unit	870
CTC30PL 30 Gal. liner	12

Concrete Options:

Concrete colors and aggregate textures.

	Smooth	Light Sand Blast	Perma Stone	DuraBrite
Dove Gray				
Terra Cotta				
Light Brown				
Sand Tan				

Select Texture:

Smooth,
Light Sand Blast,
Permastone
or
Durabrite

Select Color:

Dove Gray,
Terra Cotta,
Light Brown
or
Sand Tan

Round Concrete Table

A modern design with four surrounding seats offers great aesthetics and practicality for patios, food service, etc. It's heavily reinforced concrete construction is very durable. Comes with smooth top and seat surfaces, as well as smooth legs. Available in Sand Tan, Dove Gray, Light Brown, and Terra Cotta. Dedication plaques and logos also available, please inquire. Shown in Dove Gray

- CTR4S** Round 66" L x 30" H x 68" W 1040 Lbs
- CTR3H** ADA 900 Lbs
- UMBRKT** Umbrella bracket option



Square Concrete Table

Perfect for dressing up a patio or courtyard. Made of strong steel reinforced concrete. Top and seats have protective sealer to assure years of service. Two and four seat models available. Ask about umbrella attachment option. Choose a combination of color and texture to best suit your decor. Photo shows Sand Tan tops and seats with Sand Tan Permalstone legs.

- CTS4S** 4 seat sq 67 1/2" L x 29" H x 67 1/2" W 1,040 Lbs
- CTS2S** 2 seat sq 30" L x 29" H x 66" W 640 Lbs
- UMBKT** Umbrella bracket option



CTR Rectangle Table

"The good old standby." These tables have a combination of beautiful exposed aggregate legs and smooth colored tops and seats to enhance surroundings with a look of natural beauty. You choose the texture and color to best match your decor. SMOOTH CONCRETE tops and seats with color all the way through come in 60" and 84" lengths. A handicap model is also available with the top extended at one end. Shown with Light Brown top and seats and Light Brown Durabrite Legs.

- CTRJ60C** Standard 60" L x 29" H x 62" W 1,040 Lbs
- CTRJ84C** Standard 84" L x 29" H x 62" W 1,128 Lbs
- CTRJ84H** Handicap 84" L x 29" H x 62" W 1,028 Lbs



Concrete Oval Top Tables

A contemporary look along with a walk through design perfect for almost any setting. Shown with Sand Tan Light Sandblast legs and smooth top and seats. Choose any color for your tables from the selection. Two sizes available. Handicap unit has one end extended to allow for wheelchair.

- CTOV72** 72" L x 30" H x 60" W oval table 1,400 Lbs
- CTOV84** 84" L x 30" H x 60" W oval table 1,600 Lbs
- CTOV84H** 84" L x 30" H x 60" W oval table 1,600 Lbs

Game Board Option

Permanent insert for concrete table tops. Provide the fun!

GBI



Concrete Benches



CPB Bench

CPB Series concrete park benches are the most popular because they are a style suitable for almost any decor- and reasonably priced! The seats and back are: 2" thick smooth concrete. Benches come in 58", 72" and 84" lengths. Shown with Gray seats and sand tan perma-stone legs. All available textures and colors shown on page 39. Plaques sold separately see page 44.

CPB58C	33" H x 58" L concrete	420 Lbs
CPB72C	33" H x 72" L concrete	465 Lbs
CPB84C	33" H x 84" L concrete	485 Lbs



'X' Leg Bench

A unique look for a standard park bench. Heavy, reinforced concrete provides years of trouble-free service. Seat and back are 60" long, so it holds three comfortably. Available in smooth only. Shown in Light Brown.

CPB60X	34" H x 60" L x 24" W	500 Lbs
---------------	-----------------------	---------



CCB72CL

Contoured seat and contoured legs are cast in one piece, 72" long. Available with smooth finish seat and legs, or can be a combination of smooth seat and exposed aggregate legs of your choice. Shown in Light Brown.

CCB72CL	Concrete 18" H x 72" L	500 Lbs
----------------	------------------------	---------



CTB58C

Practical bench has three seat lengths, 58" as shown, 72" and 84" long units that can be used along sides of tables or as stand alone benches. Easy bolt-together assembly! A good value! Shown in Sand Tan seat with Durabrite Gray Legs.

CTB58C	18 1/2" H x 58" L	235 Lbs
CTB72C	18 1/2" H x 72" L	210 Lbs
CTB84C	18 1/2" H x 84" L	230 Lbs

Bleacher Options



Design standards: The bleachers shall be designed to support, in addition to their weight, a uniformly distributed live load of not less than 120 pounds per square foot of gross horizontal projection of the bleachers. All seat and foot plank members shall be designed to support no less than 125 pounds per liner foot, over a 6 foot span, multi-span condition. Bleachers shall be designed to resist, with or without live load, horizontal wind load of 30 pounds per square foot of gross vertical projection. They shall be designed to resist, in addition to the live load, sway forces applied to the seats, in a direction parallel to the direction of the seat plank, 24 pounds per linear foot of seat plank, and separately, in a direction perpendicular to the direction of seats, 10 pounds per linear foot of seat plank.



Kay's Vertical Bar Guard Rails (V4) 4" Spaced

Kay Park's Vertical Bar Guard Rails (Patented #404-141) were introduced to the outdoor portable bleacher industry, an innovation whose time has come. Vertical galvanized steel bars eliminate the "ladder effect" and a possible toe - hold for climbing on the guardrails. The possibility of accidents and serious injury and liability can be reduced by using vertical bar railing. This is part of Kay Park's continuing effort to make good products even better since 1954. We urge you to plan your purchases on the side of safety. Please note that Kay Park's 3 & 4 Row Low Rise Bleachers are EXEMPT from current guard rail rules because they are less than 30" high. Model numbers with 'V4' include Vertical Bar Guard Rails.



Full Width Footboards (F4)

Many of the various recent codes for outdoor bleacher seating require any opening more than 30" above the ground be small enough so that a 4" sphere cannot pass through. Kay Park has designed a system using two footboards and one riser plank. This system fills the space underneath the seats from the 4th row up to meet the 4" sphere guideline. Double footboards add a lot of comfort and peace of mind to the spectators. Model numbers with 'F4' include the double footboards and riser planks.

NEW! Extruded riser provides even more strength and easier aisle assembly!

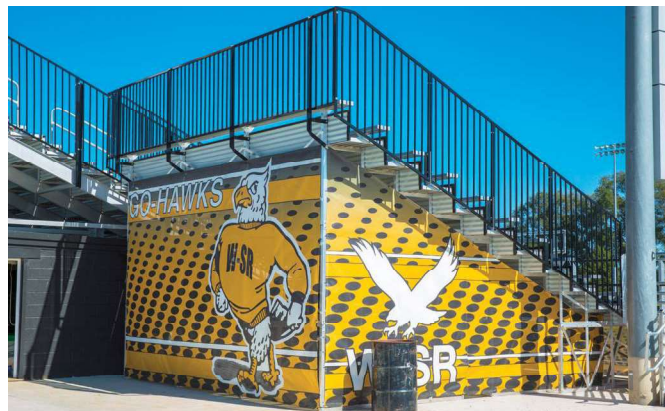

Custom Bleacher Wrap

Add custom wrap to your new bleachers for the finished look or add to older bleachers to add school spirit.

- Custom Design (Logo)
- Up to 60" Wide Panels Sections
- Direct Print to Mesh
- Full Color Bleed
- Grommets for Easy Assembly
- **Call for Pricing**

BLA Series Aluminum Angle Frame

Aluminum frames fabricated from a combination of 2" x 2" x 3/16" 6061-T6 alloy aluminum angles and channel using a punched and bolted type construction for maximum strength and safety. All main frame components are pre-assembled with large 1/2" diameter bolts, lock washers and nuts. This bolted aluminum frame provides strong joints that will not develop weld cracks. Model number with a 'BLA' are aluminum frames.

BLG Series Galvanized Steel Frame

Steel frames are fabricated from A36 alloy steel angles using full welds at all joints to give added strength. A combination of 2" x 2" x 3/16" and 1 3/4" x 1 3/4" x 3/16" angles are used, as required, for strength throughout each frame. Connecting "X" braces are 1 1/2" wide by 1/4" thick A36 alloy steel. For greatest protection and longest life, all parts are hot-dip galvanized after fabrication. Model numbers with a 'BLG' are galvanized steel frames.

Aisles & Handrails

Your local code may require one or more aisles and handrails. We do custom bleachers but some typical aisles are a 48" wide center aisle with handrail or a 36" wide aisle for an end aisle. Aisles require double footboards and risers and meet 4" opening guidelines. Heavy duty non-slip step up indicator tape is placed on each step for safety. Model numbers with '48AHR' include a 48" wide center aisle with handrail. Model numbers with '36A' include a 36" end aisle. Contact a sales rep for pricing.

Wheelchair Cut Outs

Check with your local code to see if they require wheelchair cut outs. The double wheelchair space allows for two wheelchairs and a companion to sit directly beside each wheelchair. Add 'DWCS' to the model number.

Bleacher Plank Specifications

Aluminum: Seat planks 6063-T6 extruded aluminum which is clear anodized to standard 204-R1 specification. Standard 8" rise per row uses 2" x 10" seats and low rise 6" rise uses 2" x 12" seats. Walk boards are 2" x 10" 6063-T6 extruded mill finish aluminum. End caps (anodized) and hold down clips are also extruded aluminum. Powder coated colors also available. Call for Details. Model numbers with a "Row#A" row number followed by an 'A' are aluminum planks. **Backrests available**. Fully enclosed decking also available.

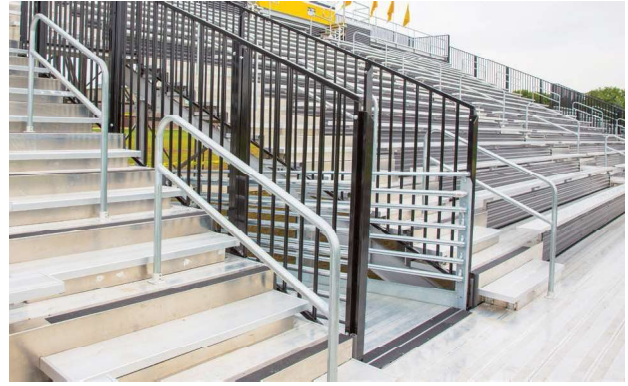

CALL 1-800-553-2476 FOR A CUSTOMIZED QUOTE TODAY!

Better Bleacher Seat

- Transforms Your Bench Seating Into a Comfortable Stadium Style Chair
- Automatic Tip-Down Back Rest (Our Safety Must-Have)
- Manufactured for Your Code-Compliance for Both Indoor or Outdoor
- Superior Manufacturing Quality and Durability
- Tired of Renting? Purchase Outright or Over Time
- Keep All of Your Revenue
- No More Wet Seats
- Installation is Quick and Easy
- Improve a Row, a Section or Your Complete Facility
- Gray, royal blue, black and navy blue

BBSSEAT Seat 17.82" W x 11.97"D- Total Depth 14.3" 8 Lbs

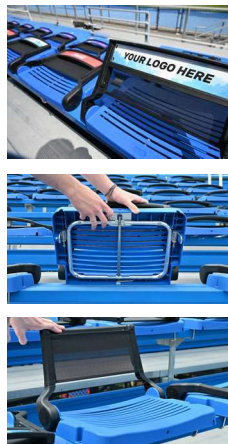

Elevated Bleachers



Kay Park's Elevated Bleachers are made to the same high standards and have the same superior features as our non-elevated bleachers. They are backed by our 60 plus years of expertise in building commercial outdoor recreation products. They are safety-equipped with vertical bar guardrails (V4)(patent #404-141) and double width footboards with risers beneath the seats (F4), our elevated bleachers meet the 4" sphere guideline in recent building codes. Standard sizes are 5, 8, 10 and 15 rows and come in many different lengths, and seating capacities. Our bleacher specialist can help you determine placement of entrance stairs, wheelchair ramps, wheelchair spaces and aisles ways to best suit your space, needs and code requirement.

Call 1-800-553-2476 to get your custom quote.



Flexible Placement of:

- Entrance Stairs
- Wheelchair Ramps
- Wheelchair Spaces
- Aisles
- Other Custom Options

Standard Elevated Sizes:

5, 8, 10 & 15 Rows
Available in many different lengths
& seating capacities.

CALL 1-800-553-2476 FOR A CUSTOMIZED QUOTE TODAY!

ADA Ramps



Add ADA seating to existing Non-compliant bleachers as Featured in: Dec. '14 Athletic Business

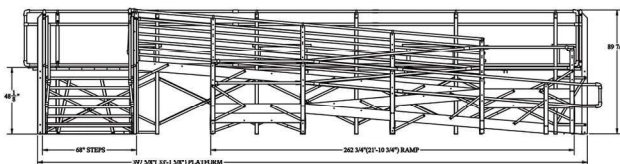

Fully Customizable

Custom ADA ramps. FREE Quotes Call Today.



Companion seats:



Elevated Bleachers

Standard 5, 8, 10 & 15 Rows - Many length, seating capacities & configuration!

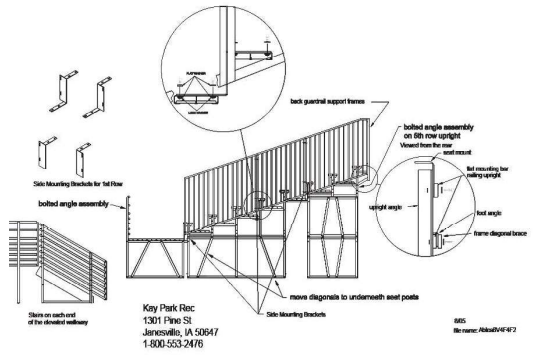
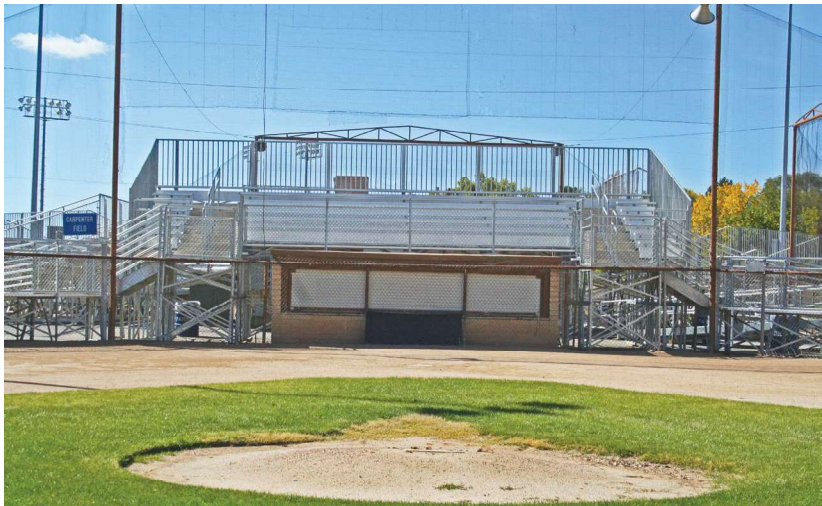
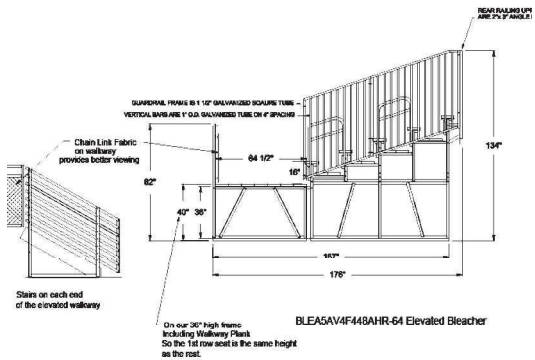

Have unique needs? We can work with you!!

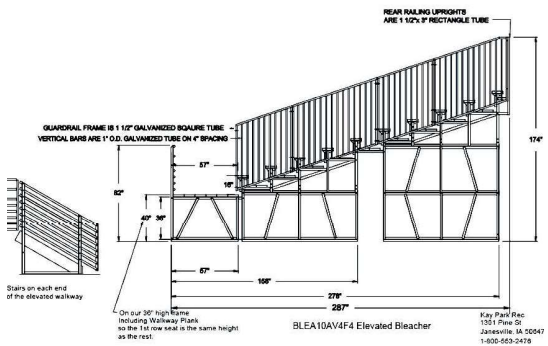

Drawings available. Call Us! 1-800-553-2476

10 Row Bleachers



10 Row Basics:

Every 10 row includes; Safe Vertical Bar Guard Rails, Double Footboards & Risers that meet the 4" Guidelines.

Local Code May Require:

- Optional ADA Spaces
- Optional Aisles

Ask about our Powder Coating Options!
Custom color coating any or all bleacher parts.

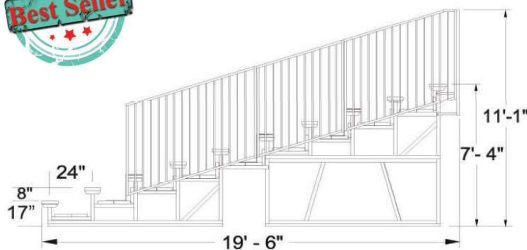

10 Row Standard 8" Rise Bleachers

Aluminum Frame

Strong 2" x 2" x 3/16" Angles & Channels

Model	Seat Plank	Rows	Length	Weight	# Seats
BLA10A15V4F4	Aluminum, 2x10 seat plank	10	15'	2155 Lbs	100
BLA10A21V4F4	Aluminum, 2x10 seat plank	10	21'	2805 Lbs	140
BLA10A27V4F4	Aluminum, 2x10 seat plank	10	27'	3484 Lbs	180
BLA10VP15V4F4	Plastisol, 2x10 seat plank	10	15'	2962 Lbs	100
BLA1015V4	Frame only, incl. hardware	10	15'	1625 Lbs	100

Galvanized Steel Frame

1 3/4" x 1 3/4" x 2" x 2" x 3/16" Angles

Model	Seat Plank	Rows	Length	Weight	# Seats
BLG10A15V4F4	Aluminum, 2x10 seat plank	10	15'	2535 Lbs	100
BLG10A21V4F4	Aluminum, 2x10 seat plank	10	21'	3355 Lbs	140
BLG10A27V4F4	Aluminum, 2x10 seat plank	10	27'	4155 Lbs	180
BLG10VP15V4F4	Plastisol, 2x10 seat plank	10	15'	3185 Lbs	100
BLG1015V4	Frame only, incl. hardware	10	15'	1614 Lbs	100

48AHR	48" Aisle & handrail	120 Lbs
36A	36" Aisle (15' units end only)	75 Lbs

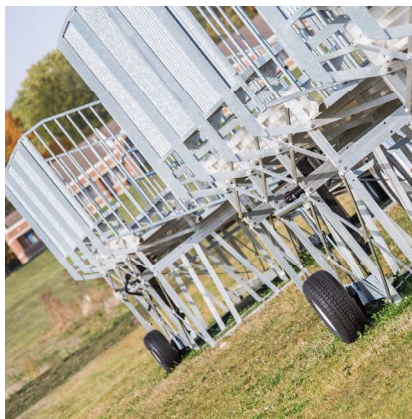

Jiffy Mover For 10 Row

Kay Park's Jiffy Mover "crank-up" unit is fast and easy to use for just one person. Special care has gone into the Jiffy design to reduce tongue weight for easier maneuvering by hand if needed. Primarily designed for transporting 10 row, 15', 21', and 27', long bleachers. Top recommended speed is 5 MPH. Aluminum frame bleachers only.

Complete Systems	(- Permanently stays w/ bleacher.)	Weight
JIF1015	10 Row, 15' long-complete system	665 Lbs
JIF1021	10 Row, 21' long-complete system	722 Lbs
JIF1027	10 Row, 27' long-complete system	777 Lbs





Optional ADA Wheelchair Spaces for any Bleacher.

DWCS Double Space

8 Row Basics:

Every 8 row includes; Safe Vertical Bar Guard Rails, Double Footboards & Risers that meet the 4" Guidelines.

Local Code May Require:

- Optional ADA Spaces
- Optional Aisles



8 Row Standard 8" Rise Bleachers

Aluminum Frame

Strong 2" x 2" x 3/16" Angles & Channels

Model	Seat Plank	Rows	Length	Weight	# Seats
BLA8A15V4F4	Aluminum, 2x10 seat plank	8	15'	1736 Lbs	80
BLA8A21V4F4	Aluminum, 2x10 seat plank	8	21'	2300 Lbs	112
BLA8A27V4F4	Aluminum, 2x10 seat plank	8	27'	2960 Lbs	144
BLA8VP15V4F4	Plastisol, 2x10 seat plank	8	15'	2325 Lbs	80
BLA815V4	Frame only, incl. hardware	8	15'	1159 Lbs	80

Galvanized Steel Frame

1 3/4" x 1 3/4" x 2" x 2" x 3/16" Angles

Model	Seat Plank	Rows	Length	Weight	# Seats
BLG8A15V4F4	Aluminum, 2x10 seat plank	8	15'	2006 Lbs	80
BLG8A21V4F4	Aluminum, 2x10 seat plank	8	21'	2640 Lbs	112
BLG8A27V4F4	Aluminum, 2x10 seat plank	8	27'	3367 Lbs	144
BLG8VP15V4F4	Plastisol, 2x10 seat plank	8	15'	2601 Lbs	80
BLG815V4	Frame only, incl. hardware	8	15'	1271 Lbs	80

48AHR	48" Aisle & handrail	120 Lbs
36A	36" Aisle (15' units end only)	75 Lbs

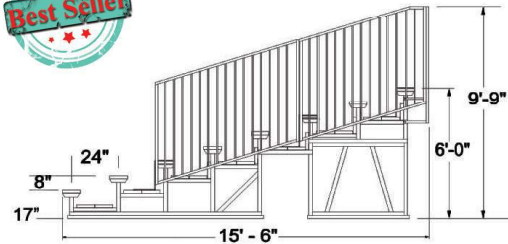

Jiffy Mover For 8 Row

Kay Park's Jiffy Mover "crank-up" unit is fast and easy to use for just one person. Special care has gone into the Jiffy design to reduce tongue weight for easier maneuvering by hand if needed. Primarily designed for transporting 8 row, 15', 21', and 27', long bleachers.

Top recommended speed is 5 MPH. Aluminum frame bleachers only.

Complete Systems - (Permanently stays w/ bleacher.)

JIF815	8 Row, 15' long-complete system	525 Lbs
JIF821	8 Row, 21' long-complete system	582 Lbs
JIF827	8 Row, 27' long-complete system	642 Lbs

When Ordering Bleachers

We advise that you check your local requirements for such things as aisle, guardrails, ADA, or other requirements. Building codes may vary by year written and by group who issues them (IBC, UBC, BOCA, SBC, NFPA, etc.)



5 Row Bleachers

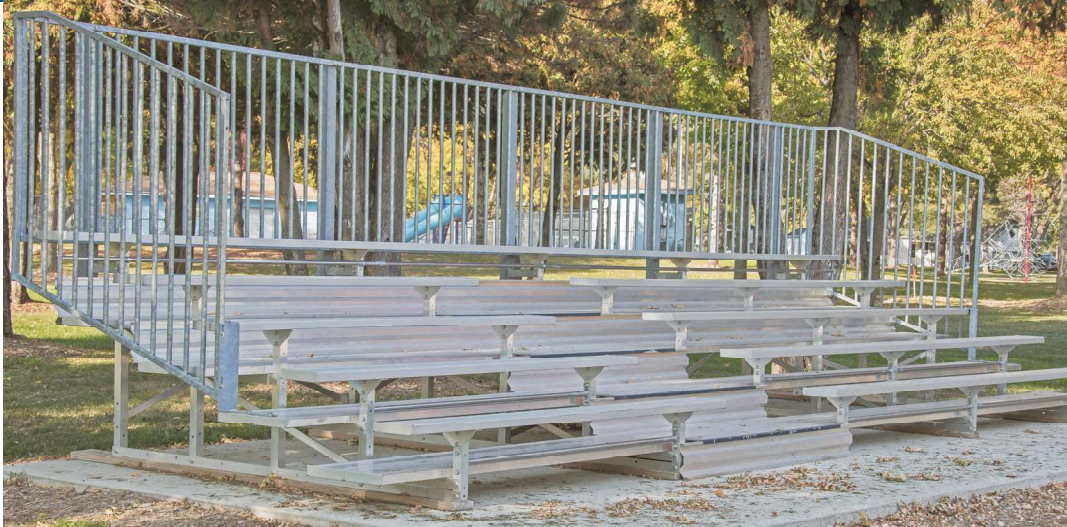

5 Row Basics:

5 row includes Safe Vertical Bar Guard Rails, Double Foot-boards & Risers that meet the 4" Guidelines.

Local Code May Require:

- Optional ADA Spaces
- Optional Aisles

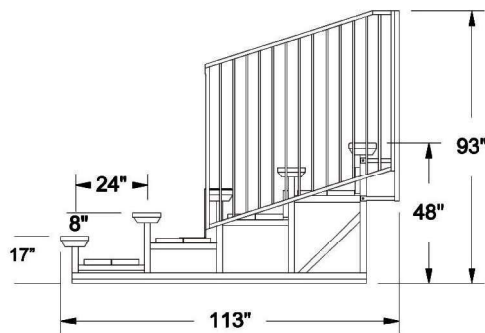

5 Row Standard 8" Rise Bleachers

Aluminum Frame

Strong 2" x 2" x 3/16" Angles & Channels

Model	Seat Plank	Rows	Length	Weight	# Seats
BLA5A15V4F4	Aluminum, 2x10 seat plank	5	15'	1063 Lbs	50
BLA5A21V4F4	Aluminum, 2x10 seat plank	5	21'	1423 Lbs	70
BLA5A27V4F4	Aluminum, 2x10 seat plank	5	27'	1735 Lbs	90
BLA5VP15V4F4	Plastisol, 2x10 seat plank	5	15'	1255 Lbs	50
BLA515V4	Frame only, incl. hardware	5	15'	667 Lbs	50

Galvanized Steel Frame

1 3/4" x 1 3/4" x 2" x 2" x 3/16" Angles

Model	Seat Plank	Rows	Length	Weight	# Seats
BLG5A15V4F4	Aluminum, 2x10 seat plank	5	15'	1124 Lbs	50
BLG5A21V4F4	Aluminum, 2x10 seat plank	5	21'	1494 Lbs	70
BLG5A27V4F4	Aluminum, 2x10 seat plank	5	27'	1863 Lbs	90
BLG5VP15V4F4	Plastisol, 2x10 seat plank	5	15'	1450 Lbs	50
BLG515V4	Frame only, incl. hardware	5	15'	718 Lbs	50

48AHR	48" Aisle & handrail	120 Lbs
36A	36" Aisle (15' units end only)	75 Lbs

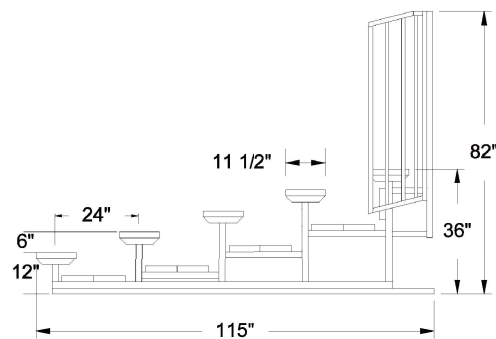

5 Row 6" Low Rise Bleachers

Aluminum Frame

Strong 2" x 2" x 3/16" Angles & Channels

Model	Seat Plank	Rows	Length	Weight	# Seats
BLRA5A15V4F4	Aluminum, 2x12 seat plank	5	15'	925 Lbs	50
BLRA5A21V4F4	Aluminum, 2x12 seat plank	5	21'	1273 Lbs	70
BLRA5A27V4F4	Aluminum, 2x12 seat plank	5	27'	1419 Lbs	90
BLRA515V4	Frame only, incl. hardware	5	15'	561 Lbs	50

Galvanized Steel Frame

1 3/4" x 1 3/4" x 2" x 2" x 3/16" Angles

Model	Seat Plank	Rows	Length	Weight	# Seats
BLRG5A15V4F4	Aluminum, 2x12 seat plank	5	15'	1063 Lbs	50
BLRG5A21V4F4	Aluminum, 2x12 seat plank	5	21'	1456 Lbs	70
BLRG5A27V4F4	Aluminum, 2x12 seat plank	5	27'	1820 Lbs	90
BLRG515V4	Frame only, incl. hardware	5	15'	668 Lbs	50

6" Low Rise Bleachers ("LR")

Aisle and handrails NOT required by many codes when: * 11 1/2" Wide seat planks

* Rise to 6" per row * First row seat is 12" high



Jiffy Mover For 5 Row

Kay Park's Jiffy Mover "crank-up" unit is fast and easy to use for just one person. Special care has gone into the Jiffy design to reduce tongue weight for easier maneuvering by hand if needed. Primarily designed for transporting 5 row 15', 21', and 27', long bleachers. Top recommended speed is 5 MPH. Aluminum frame bleachers only.

Complete Systems - (Permanently stays w/ bleacher.)

JIF51521	5 Row, 15' & 21' long-complete system	291 Lbs
JIF527	5 Row, 27' long-complete system	395 Lbs

Component Models - 5 row model only- (Transferable Parts)

JIF5JACK	5 Row, jack only (1 total)	40 Lbs
JIF5WT1521	5 Row, wheel and tongue (1 total) 15', 21'	175 Lbs
JIF5WT27	5 Row, wheel and tongue (1 total) 27'	205 Lbs
JIF5FRM1521	5 Row, frame parts (1 per bleacher) 15', 21'	70 Lbs
JIF5FRM27	5 Row, frame parts (1 per bleacher) 27'	95 Lbs

5 Row Basic Model



Optional ADA Wheelchair Spaces for any Bleacher.

DWCS Double Space

5 Row Basics:

- This page has NO Guardrails
- This page has No Double Footboard & Risers

Local Code May Require:

- Optional ADA Spaces
- Optional Aisles

5 Row 8" Rise Bleachers- No Rails & 1 Footboard

Aluminum Frame

Strong 2" x 2" x 3/16" Angles & Channels

Model	Seat Plank	Rows	Length	Weight	# Seats
BLA5A15	Aluminum, 2x10 seat plank	5	15'	395 Lbs	50
BLA5A21	Aluminum, 2x10 seat plank	5	21'	573 Lbs	70
BLA5A27	Aluminum, 2x10 seat plank	5	27'	708 Lbs	90
BLA5VP15	Plastisol, 2x10 seat plank	5	15'	587 Lbs	50
BLA515	Frame only, incl. hardware	5	15'	166 Lbs	50

Galvanized Steel Frame

1 3/4" x 1 3/4" x 2" x 2" x 3/16" Angles

Model	Seat Plank	Rows	Length	Weight	# Seats
BLG5A15	Aluminum, 2x10 seat plank	5	15'	523 Lbs	50
BLG5A21	Aluminum, 2x10 seat plank	5	21'	756 Lbs	70
BLG5A27	Aluminum, 2x10 seat plank	5	27'	947 Lbs	90
BLG5VP15	Plastisol, 2x10 seat plank	5	15'	704 Lbs	50
BLG515	Frame only, incl. hardware	5	15'	293 Lbs	50

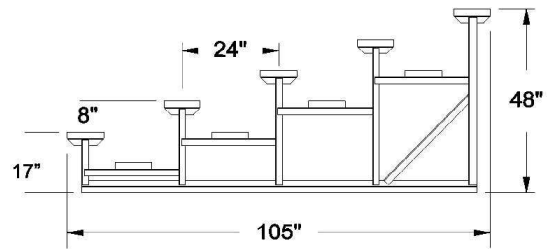

5 Row 6" Low Rise Bleachers- No Rails & 1 Footboard

Aluminum Frame

Strong 2" x 2" x 3/16" Angles & Channels

Model	Seat Plank	Rows	Length	Weight	# Seats
BLRA5A15	Aluminum, 2x12 seat plank	5	15'	395 Lbs	50
BLRA5A21	Aluminum, 2x12 seat plank	5	21'	573 Lbs	70
BLRA5A27	Aluminum, 2x12 seat plank	5	27'	708 Lbs	90
BLRA515	Frame only, incl. hardware	5	15'	166 Lbs	50

Galvanized Steel Frame

1 3/4" x 1 3/4" x 2" x 2" x 3/16" Angles

Model	Seat Plank	Rows	Length	Weight	# Seats
BLRG5A15	Aluminum, 2x12 seat plank	5	15'	533 Lbs	50
BLRG5A21	Aluminum, 2x12 seat plank	5	21'	756 Lbs	70
BLRG5A27	Aluminum, 2x12 seat plank	5	27'	947 Lbs	90
BLRG515	Frame only, incl. hardware	5	15'	273 Lbs	50

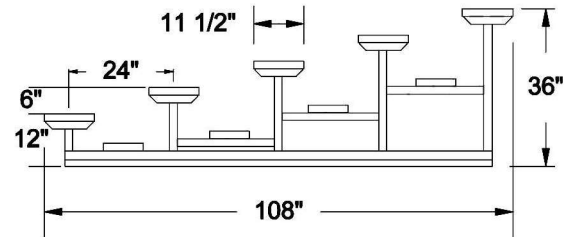

Jiffy Mover For 5 Row

Kay Park's Jiffy Mover "crank-up" unit is fast and easy to use for just one person. Special care has gone into the Jiffy design to reduce tongue weight for easier maneuvering by hand if needed. Primarily designed for transporting 5 row, 15', 21', and 27', long bleachers. Top recommended speed is 5 MPH. Aluminum frame bleachers only.

Complete Systems - (Permanently stays w/ bleacher.)

JIF51521	5 Row, 15' & 21' long-complete system	291 Lbs
JIF527	5 Row, 27' long-complete system	395 Lbs

Component Models - 5 row model only- (Transferable Parts)

JIF5JACK	5 Row, jack only (1 total)	40 Lbs
JIF5WT1521	5 Row, wheel and tongue (1 total) 15', 21'	175 Lbs
JIF5WT27	5 Row, wheel and tongue (1 total) 27'	205 Lbs
JIF5FRM1521	5 Row, frame parts (1 per bleacher) 15', 21'	70 Lbs
JIF5FRM27	5 Row, frame parts (1 per bleacher) 27'	95 Lbs



4 Row Bleachers

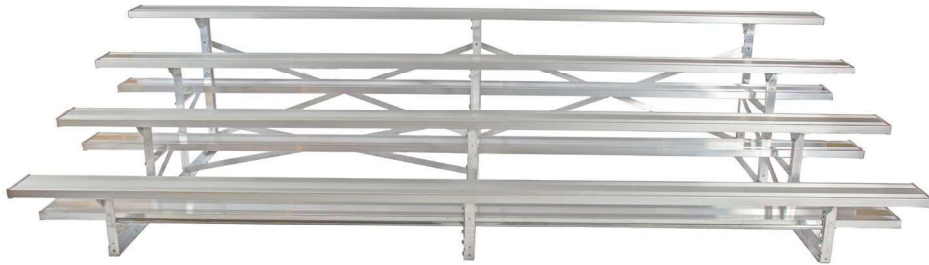

4 Row Basics:

Available with or without; Safe Vertical Bar guard Rails, Double Footboards & Risers that meet the 4" Guidelines.

Local Code May Require:

- Optional ADA Spaces
- Optional Aisles

Design Standards:

Please refer to pages 70 & 71 for design standards. Please call 1-800-553-2476 for specification

4 Row Standard 8" Rise

Aluminum Frame

Model	Seat Plank
BLA4A15V4F4	Aluminum, 2x10 seat plank
BLA4A21V4F4	Aluminum, 2x10 seat plank
BLA4A27V4F4	Aluminum, 2x10 seat plank
BLA4VP15V4F4	Plastisol, 2x10 seat plank
BLA415V4	Frame only, incl. hardware

Strong 2" x 2" x 3/16" Angles & Channels

Rows	Length	Weight	# Seats
4	15'	850 Lbs	40
4	21'	1138 Lbs	56
4	27'	1388 Lbs	72
4	15'	1004 Lbs	40
4	15'	553 Lbs	40

Galvanized Steel Frame

Model	Seat Plank
BLG4A15V4F4	Aluminum, 2x10 seat plank
BLG4A21V4F4	Aluminum, 2x10 seat plank
BLG4A27V4F4	Aluminum, 2x10 seat plank
BLG4VP15V4F4	Plastisol, 2x10 seat plank
BLG415V4	Frame only, incl. hardware

1 3/4" x 1 3/4" x 2" x 2" x 3/16" Angles

Rows	Length	Weight	# Seats
4	15'	930 Lbs	40
4	21'	1261 Lbs	56
4	27'	1579 Lbs	72
4	15'	1097 Lbs	40
4	15'	634 Lbs	40

48AHR	48" Aisle & handrail	120 Lbs
36A	36" Aisle (15' units end only)	75 Lbs

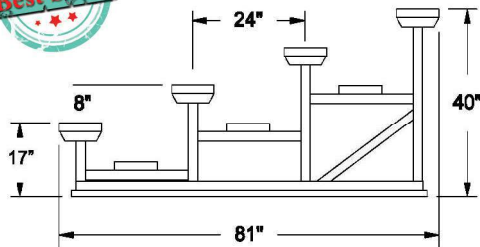
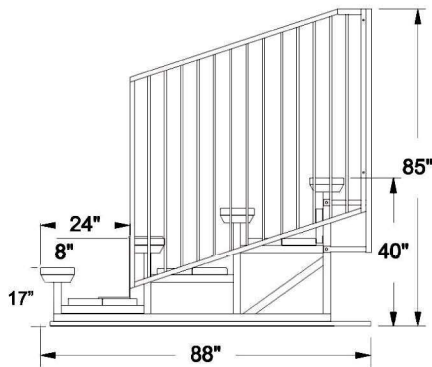

4 Row Standard 8" Rise - No Rails & 1 Footboard

Aluminum Frame

Model	Seat Plank
BLA4A7.5	Aluminum, 2x10 seat plank
BLA4A15	Aluminum, 2x10 seat plank
BLA4A21	Aluminum, 2x10 seat plank
BLA4A27	Aluminum, 2x10 seat plank
BLA4VP15	Plastisol, 2x10 seat plank
BLA415	Frame only, incl. hardware

Strong 2" x 2" x 3/16" Angles & Channels

Rows	Length	Weight	# Seats
4	7.5'	189 Lbs	20
4	15'	322 Lbs	40
4	21'	458 Lbs	56
4	27'	571 Lbs	72
4	15'	598 Lbs	40
4	15'	139 Lbs	40

Galvanized Steel Frame

Model	Seat Plank
BLG4A7.5	Aluminum, 2x10 seat plank
BLG4A15	Aluminum, 2x10 seat plank
BLG4A21	Aluminum, 2x10 seat plank
BLG4A27	Aluminum, 2x10 seat plank
BLG4VP15	Plastisol, 2x10 seat plank
BLG415	Frame only, incl. hardware

1 3/4" x 1 3/4" x 2" x 2" x 3/16" Angles

Rows	Length	Weight	# Seats
4	7.5'	240 Lbs	20
4	15'	418 Lbs	40
4	21'	605 Lbs	56
4	27'	758 Lbs	72
4	15'	563 Lbs	40
4	15'	234 Lbs	40



4 Row 6" Rise - No Rails & 1 Footboard

Aluminum Frame

Model	Seat Plank
BLRA4A7.5	Aluminum, 2x12 seat plank
BLRA4A15	Aluminum, 2x12 seat plank
BLRA4A21	Aluminum, 2x12 seat plank
BLRA4A27	Aluminum, 2x12 seat plank
BLRA415	Frame only, incl. hardware

Strong 2" x 2" x 3/16" Angles & Channels

Rows	Length	Weight	# Seats
4	7.5'	198 Lbs	20
4	15'	316 Lbs	40
4	21'	447 Lbs	56
4	27'	563 Lbs	72
4	15'	130 Lbs	40

Galvanized Steel Frame

Model	Seat Plank
BLRG4A7.5	Aluminum, 2x12 seat plank
BLRG4A15	Aluminum, 2x12 seat plank
BLRG4A21	Aluminum, 2x12 seat plank
BLRG4A27	Aluminum, 2x12 seat plank
BLRG415	Frame only, incl. hardware

1 3/4" x 1 3/4" x 2" x 2" x 3/16" Angles

Rows	Length	Weight	# Seats
4	7.5'	240 Lbs	20
4	15'	418 Lbs	40
4	21'	605 Lbs	56
4	27'	758 Lbs	72
4	15'	234 Lbs	40

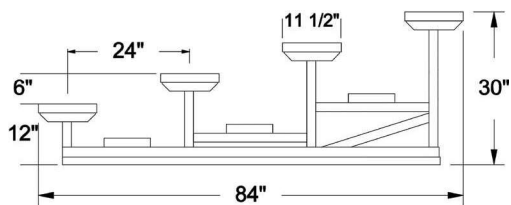

4 Row Basics:

- This page has NO Guardrails
- This page has No Double Footboard & Risers

Local Code May Require:

- Optional ADA Spaces
- Optional Aisles

6" Low Rise Bleachers ("LR")

Aisle and handrails NOT required by many codes when:

- * 11 1/2 Wide seat planks
- * Rise to 6" per row
- * First row seat is 12" high

3 Row Bleachers



3 Row Basics This page:

- NO Guardrails needed less than 30"
- NO Double footboards
- Check your local codes

Local Code May Require:

- Optional ADA Spaces
- Optional Aisles

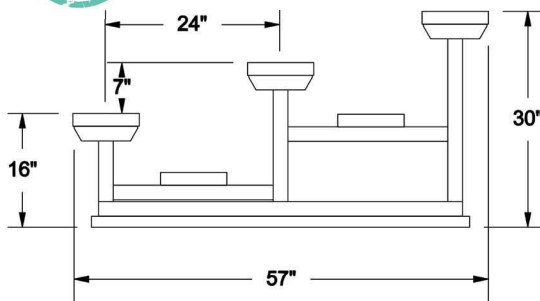

3 Row 7" Rise Aluminum Frame

Model	Seat Plank
BLA3A7.5	Aluminum, 2x10 seat plank
BLA3A15	Aluminum, 2x10 seat plank
BLA3A21	Aluminum, 2x10 seat plank
BLA3A27	Aluminum, 2x10 seat plank
BLA3VP15	Plastisol, 2x10 seat plank
BLA315	Frame only, incl. hardware

Strong 2" x 2" x 3/16" Angles & Channels

Rows	Length	Weight	# Seats
3	7.5'	136 Lbs	15
3	15'	223 Lbs	30
3	21'	326 Lbs	42
3	27'	420 Lbs	54
3	15'	342 Lbs	30
3	15'	95 Lbs	30

Galvanized Steel Frame

Model	Seat Plank
BLG3A7.5	Aluminum, 2x10 seat plank
BLG3A15	Aluminum, 2x10 seat plank
BLG3A21	Aluminum, 2x10 seat plank
BLG3A27	Aluminum, 2x10 seat plank
BLG3VP15	Plastisol, 2x10 seat plank
BLG315	Frame only, incl. hardware

1 3/4" x 1 3/4" x 2" x 2" x 3/16" Angles

Rows	Length	Weight	# Seats
3	7.5'	160 Lbs	15
3	15'	277 Lbs	30
3	21'	395 Lbs	42
3	27'	510 Lbs	54
3	15'	385 Lbs	30
3	15'	151 Lbs	30

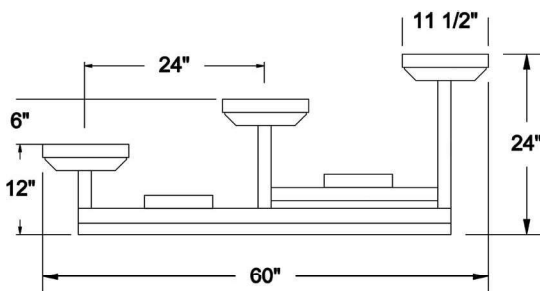

3 Row 6" Low Rise Aluminum Frame

Model	Seat Plank
BLRA3A7.5	Aluminum, 2x12 seat plank
BLRA3A15	Aluminum, 2x12 seat plank
BLRA3A21	Aluminum, 2x12 seat plank
BLRA3A27	Aluminum, 2x12 seat plank
BLRA315	Frame only, incl. hardware

Strong 2" x 2" x 3/16" Angles & Channels

Rows	Length	Weight	# Seats
3	7.5'	136 Lbs	15
3	15'	223 Lbs	30
3	21'	326 Lbs	42
3	27'	420 Lbs	54
3	15'	95 Lbs	30

Galvanized Steel Frame

Model	Seat Plank
BLRG3A7.5	Aluminum, 2x12 seat plank
BLRG3A15	Aluminum, 2x12 seat plank
BLRG3A21	Aluminum, 2x12 seat plank
BLRG3A27	Aluminum, 2x12 seat plank
BLRG315	Frame only, incl. hardware

1 3/4" x 1 3/4" x 2" x 2" x 3/16" Angles

Rows	Length	Weight	# Seats
3	7.5'	160 Lbs	15
3	15'	277 Lbs	30
3	21'	395 Lbs	42
3	27'	510 Lbs	54
3	15'	151 Lbs	30

6" Low Rise Bleachers ("LR")

Aisle and handrails NOT required by many codes when:

- * 11 1/2 Wide seat planks
- * Rise to 6" per row
- * First row seat is 12" high

When Ordering Bleachers

We advise that you check your local requirements for such things as aisle, guardrails, ADA, or other requirements. Building codes may vary by year written and by group who issues them (IBC, UBC, BOCA, SBC, NFPA, etc.)

2 Row, Back2Back & Bleacher Renovation

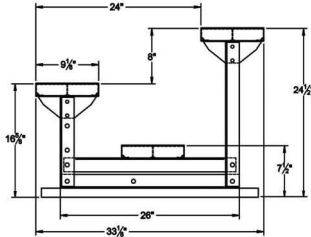

2 Row 8" Rise Bleachers

Aluminum Frame

Strong 2" x 2" x 3/16" Angles & Channels

Model	Seat Plank	Rows	Length	Weight	# Seats
BLA2A7.5	Aluminum, 2x10 seat plank	2	7.5'	83 Lbs	10
BLA2A15	Aluminum, 2x10 seat plank	2	15'	145 Lbs	20
BLA2A21	Aluminum, 2x10 seat plank	2	21'	225 Lbs	28
BLA2A27	Aluminum, 2x10 seat plank	2	27'	260 Lbs	36
BLA215	Frame only, incl. hardware	2	15'	77 Lbs	20



3 Row 7" Rise Back 2 Back Bleachers

Aluminum Frame

Strong 2" x 2" x 3/16" Angles & Channels

Model	Seat Plank	Rows	Length	Weight	# Seats
BLDA3A7.5	Aluminum, 2x10 seat plank	3	7.5'	240 Lbs	25
BLDA3A15	Aluminum, 2x10 seat plank	3	15'	299 Lbs	50
BLDA3A21	Aluminum, 2x10 seat plank	3	21'	561 Lbs	70
BLDA3A27	Aluminum, 2x10 seat plank	3	27'	690 Lbs	90
BLDA315	Frame only, incl. hardware	3	15'	164 Lbs	50

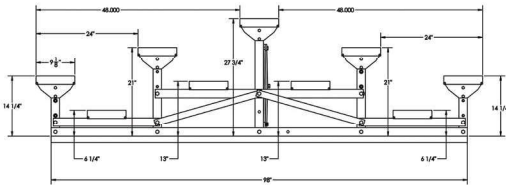

Back 2 Back bleachers are ideal between soccer fields and tennis courts

Bleacher Renovation



*Custom ADA ramps.
FREE Quotes
Call Today.*



*Before
&
After*



*Tired of replacing wood planks?
Switch to Aluminum!*

Jiffy Mover and Tip & Rolls

Jiffy Movers

Kay Park's Jiffy Mover "crank-up" unit is fast and easy to use for just one person. Special care has gone into the Jiffy design to reduce tongue weight for easier maneuvering by hand if needed. Primarily designed for transporting 5 row 15', 21', and 27', long bleachers. Top recommended speed is 5 MPH. Aluminum frame bleachers only.

Complete Systems	- (Permanently stays w/ bleacher.)	
JIF51521	5 Row, 15' & 21' long-complete system	291 Lbs
JIF527	5 Row, 27' long-complete system	395 Lbs
Complete Systems	- (Permanently stays w/ bleacher.)	
JIF815	8 Row, 15' long-complete system	525 Lbs
JIF821	8 Row, 21' long-complete system	582 Lbs
JIF827	8 Row, 27' long-complete system	642 Lbs
Complete Systems	- (Permanently stays w/ bleacher.)	
JIF1015	10 Row, 15' long-complete system	665 Lbs
JIF1021	10 Row, 21' long-complete system	722 Lbs
JIF1027	10 Row, 27' long-complete system	777 Lbs



No Parts to Lose

Designed to move with reinforced infrastructure



**One
Person
Set-Up
10 Min**



Bleacher Stays Intact

**Easy
to
Move**



Tip & Roll System

Kay Park Tip & Roll Bleachers are particularly suitable for your indoor seating that must be moved from one activity to another. Non-marring sills prevent scuffing of floors. Their special length rear extension and clearance above the floor makes tipping either aluminum or galvanized frames in 3, 4, & 5 row models, without railing. Tipping will be easiest with aluminum frames. The set of four 5" casters set contains 2 casters with brakes. **NOT available on 8 & 10 row bleachers**

Length	Rise		3 Row	4 Row	5 Row	
15'	8"	4-5" Casters	31 Lbs	BLTR315	BLTR415	BLTR515
21'	8"	4-5" Casters	31 Lbs	BLTR321	BLTR421	BLTR521
27'	8"	6-5" Casters	44 Lbs	BLTR327	BLTR427	BLTR527
15'	6"	4-5" Casters	31 Lbs	BLTRLR315	BLTRLR415	
21'	6"	4-5" Casters	31 Lbs	BLTRLR321	BLTRLR421	
27'	6"	6-5" Casters	44 Lbs	BLTRLR327	BLTRLR427	



Put Safety First! Easy to Move Tip & Roll

Speedy Stage

1. Park It!

Easy To Use!

Highway Towable Elevated Folding Stage



All-weather construction of Galvanized Steel and Aluminum

2. Unfold It!

Check out the Video Online

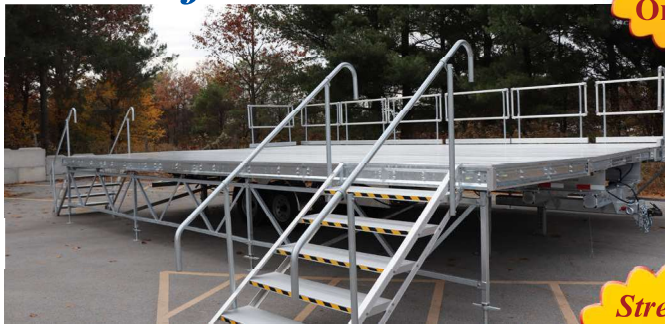

Standard Features:

- 12 Volt Hydraulic Operating System
- Push Button Folding
- Adjustable Stabilizing Jacks
- Telescopic Tongue
- LED Lights
- Electric Brakes
- Stationary Safety Rails (Multiple Configurations)
- Aluminum Deck
- Tandem Axel
- Optional Spare Tire
- Stairs (1 Set of Stairs) (Additional sets available)

3. Use It!

Stretch Budget 1 unit Multiple Locations



Saves Time and Money

Great for:
Outdoor Graduations,
Homecoming Parades, Political
Events, Music Concerts
and much more!

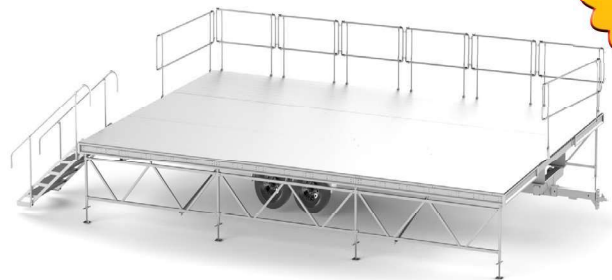

Speedy Stage

	Folded	Unfolded	Tow	Weight
SPSTG3020	30'L x 8.5'W x 11.6' H	30'L x 20'W x 48" H	34'L x 8.5'W x 11.6'H	9,850 Lbs

Call for Price Quote Today!
1-800-553-2476

Speedy Bleacher - Highway Towable Bleacher

1. Park It!



Standard Features:

- Vertical baluster bar guard rails (deters climbing) Pat. 404-141
- Hot-dip galvanized guard rail
- Heavy I-Beam main frame
- Aluminum seats & walk boards
- Stop, turn & clearance lights
- Electric brakes all four wheels
- 12-Volt hydraulic folding mechanism (self-contained battery & charger)
- Full 24" row spacing for today's taller people
- Telescoping tongue is removable (EZ slide tongue roller system)
- Semi-trailer type stabilizing jacks (high sway-load capacity-35,000 Lbs static load each)

2. Unfold It!



- Lease to Own Options Available
- Share with City, School or Fair
- Rent to Generate Revenue

Check out the Video Online

3. Use It!

Optional Features:

- Full width footboards & risers
- 48" Aisle (reduces capacity by 27 seats)
- Sturdy aisle handrail
- Push button operated hydraulic jacks
- Goose-neck towing hitch (folds flat)
- Storage Basket



Seating for 300
People In Less Than
10 Minutes!

Call for Price Quotes
Today!
1-800-553-2476

Speedy Bleacher - Highway Towable Bleacher

Call for Price Quotes Today!
1-800-553-2476

**Change to 3,000 Seats
In 1 hour!**



**Create A Stadium Anywhere
You Need The Seating!**



***Seating,
Where YOU need it,
When YOU need it,
FAST!***

Great for all of the following:

- Parades
- Baseball/Softball
- Football/Rugby
- Concerts
- Track/Cross Country
- Assemblies
- Graduation
- Tennis
- Soccer
- Tournaments
- Fairs/ Festivals
- Celebrations
- Speakers
- Training
- Arenas
- Golf
- Bands or on the sidelines.

Speedy Bleacher - Highway Towable Bleacher

**Best in
The
Market**



**Highway
Towable!**

Invest Thoughtfully

	7 Row	Seating Capacity	Row Length	Static Jack Load Cap.	Width	Length	Tow Width	Tow Length	Tow Height	Total Weight	Tongue Weight
SPBL2707		108	27'	30,000#	13'6"	29'3"	102"	32'11"	8'11"	4,100 Lbs	Approx. 550Lbs

Speedy Bleachers can be Parked, Set Up & Ready to use In just 10 Minutes

	9 Row	Seating Capacity	Row Length	Static Jack Load Cap.	Width	Length	Tow Width	Tow Length	Tow Height	Total Weight	Tongue Weight
SPBL3009		180	30'	140,000#	17'4"	31'6"	102"	35'1"	10'9"	8,830 - 9,480 Lbs	Approx. 1,270 Lbs
SPBL4009		234	39'	210,000#	17'4"	41'6"	102"	45'1"	10'9"	9,400 - 11,400 Lbs	Approx. 1,600 Lbs
SPBL4509		270	45'	210,000#	17'4"	46'6"	102"	50'1"	10'9"	11,690 - 12,270 Lbs	Approx. 1,750 Lbs

	10 Row	Seating Capacity	Row Length	Static Jack Load Cap.	Width	Length	Tow Width	Tow Length	Tow Height	Total Weight	Tongue Weight
SPBL3010		200	30'	140,000#	19'4"	31'6"	102"	35'1"	12'6"	8,730 - 9,470 Lbs	Approx. 1,175 Lbs
SPBL4010		260	39'	210,000#	19'4"	41'6"	102"	45'1"	12'6"	9,400 - 11,900 Lbs	Approx. 1,550 Lbs
SPBL4510		300	45'	210,000#	19'4"	46'6"	102"	50'1"	12'6"	12,020 - 13,170 Lbs	Approx. 1,730 Lbs

Options to fit your needs! CALL TODAY! 1-800-553-2476



Semi-Trailer type stabilizing jacks, 35,000 Lbs each. 4 jacks on 30' Speedy and 6 jacks on 40' & 45' Speedy. Operate from a standing position. Pat. No. 6,499,258



All Jacks are operated from the back side of the SPEEDY BLEACHER while you are in a full-upright standing position. (No stooping or squatting to operate numerous small jacks.) On 9 and 10 row units.



ADA wheelchair spaces! Includes required companion seats.

**Adding an aisle
10 row deducts 27 seats
9 row deducts 24**



This is a Folding Goose Neck Hitch that can be added to a Speedy Bleacher that you already own. It's a fairly easy bolt on application that will make towing your Speedy Bleacher long distances easy, even in windy conditions. It also makes getting your Speedy Bleacher into tight positions easy. Best of all once you have your bleacher setup the hitch folds flat to get it out of the way of your patrons.



A Central Aisle & Sturdy Hand Rail are Good Safety Options. Come standard on 7 and 8 row units.

Recycled Plastic Message Centers



Recycled Plastic Message Center

Our premium quality message centers are made from 100% recycled plastic. Our recycled plastic is maintenance free! It will never rot, rust, chip, splinter or peel. It is graffiti resistant and has UV inhibitors to prevent color fading. Our message centers are made with crystal clear, high-impact acrylic viewing glass that will not yellow. The glass is 100 times stronger than regular glass. We use zinc coated locks to secure the sliding doors. A high quality cork board display surface is included. Great for indoor or outdoor use! Message centers are offered in three sizes: Small = 20" x 3.5" x 26", Medium = 36" x 3.5" x 26", Large = 51" x 3.5" x 36". Medium and large sizes are offered as two different models: single sided or double sided. Each unit can be purchased as wall mount or with reinforced mounting posts. Now with thicker cork board. Available in green or cedar.

Sliding Doors

JPMCS1W	Sm msg ctr, 1 side, wall mnt.	40 Lbs
JPMCS1P	Sm msg ctr, 1 side w/post	70 Lbs
JPMCM1W	Med msg ctr, 1 side, wall mnt.	60 Lbs
JPMCM1P	Med msg ctr, 1 side w/posts	120 Lbs
JPMCM2P	Med msg ctr, 2 sides w/posts	150 Lbs
JPMCL1W	Lg msg ctr, 1 side, wall mnt.	90 Lbs
JPMCL1P	Lg msg ctr, 1 side w/posts	155 Lbs
JPMCL2P	Lg msg ctr, 2 sides w/posts	190 Lbs



Hinged Doors

Hinged Doors

JPHMCS1W	Sm msg ctr, 1 side wall mnt.	40 Lbs
JPHMCS1P	Sm msg ctr, 1 side w/posts	70 Lbs
JPHMCM1W	Med msg ctr, 1 side wall mnt.	60 Lbs
JPHMCM1P	Med msg ctr, 1 side w/posts	150 Lbs

*Top Quality Marine Grade Cork
and Specially
Coated Locking Mechanisms*



Zig-Zag Message Center

Recycled Plastic message center with six sides with three hinges and shatter resistant doors.

JPMCZZ 6 Sides, 4 Post Hinged 565 Lbs



100% Recycled Plastic

Recycled Colors:



Cedar Green

*Resin-wood Framework
With Shatter Resistance
Clear Plastic Sheet*



Car Stops

Recycled Plastic car stops won't be harmed by snow, sand, salt, or bad drivers. Let gravity hold them in place or pin them with spikes or rebar. Available in grey, blue or yellow.

PRCS6 4" X 6" X 72" 42 Lbs

Colors:

Grey
Blue
Yellow

Customer ID

Promo ID

Please circulate to:
Facility Manager
Grounds Manager
Principal/Admin

Please forward to the proper department if this catalog has reached you in error.



Easy Online Ordering
www.kaypark.com

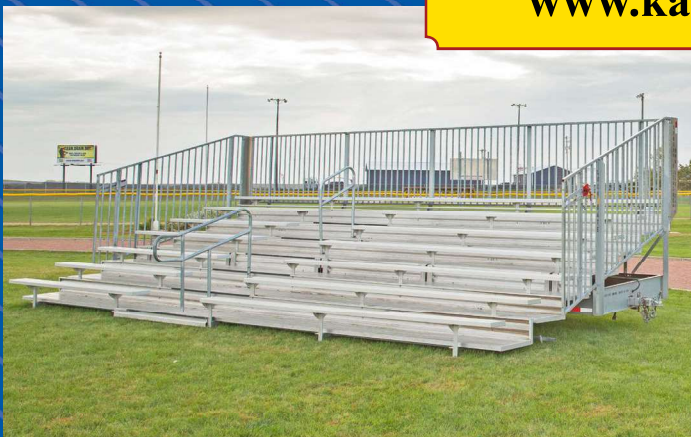

Kay Park Recreation
1301 Pine Street Janesville, IA 50647
1-800-553-2476 ♦ 1-877 (KAY - PARK) ♦ 1-319-987-2900 (Fax)
529 - 7275