

Installation Manual

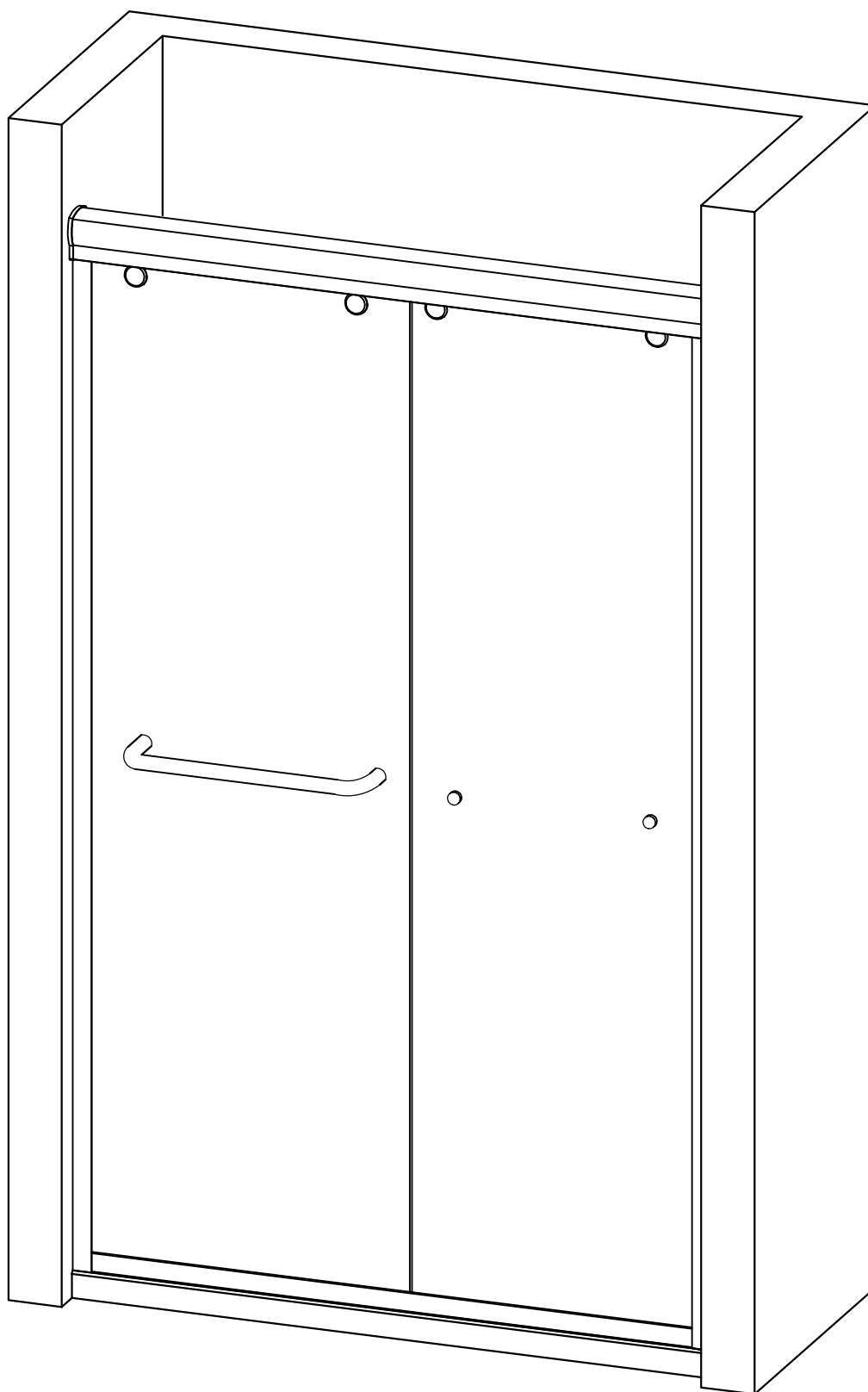

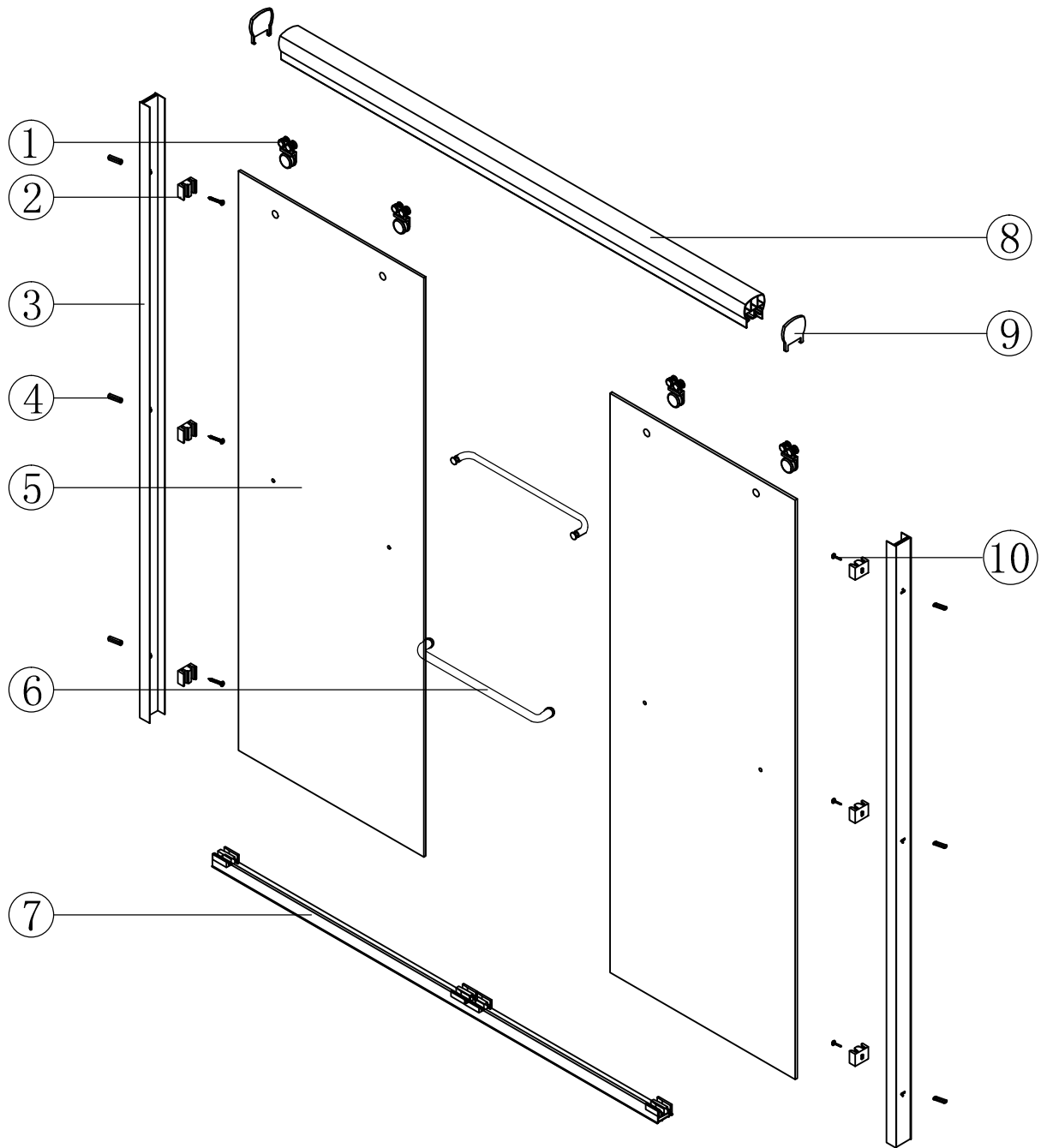





Classic (SC-82)



Exploded Diagram



Parts List

1	 x4	2	 x6	3	 x2	4	 ST4x30 x6	5	 x2	6	 x2
7	 x1	8	 x1	9	 x2						

Tools Required

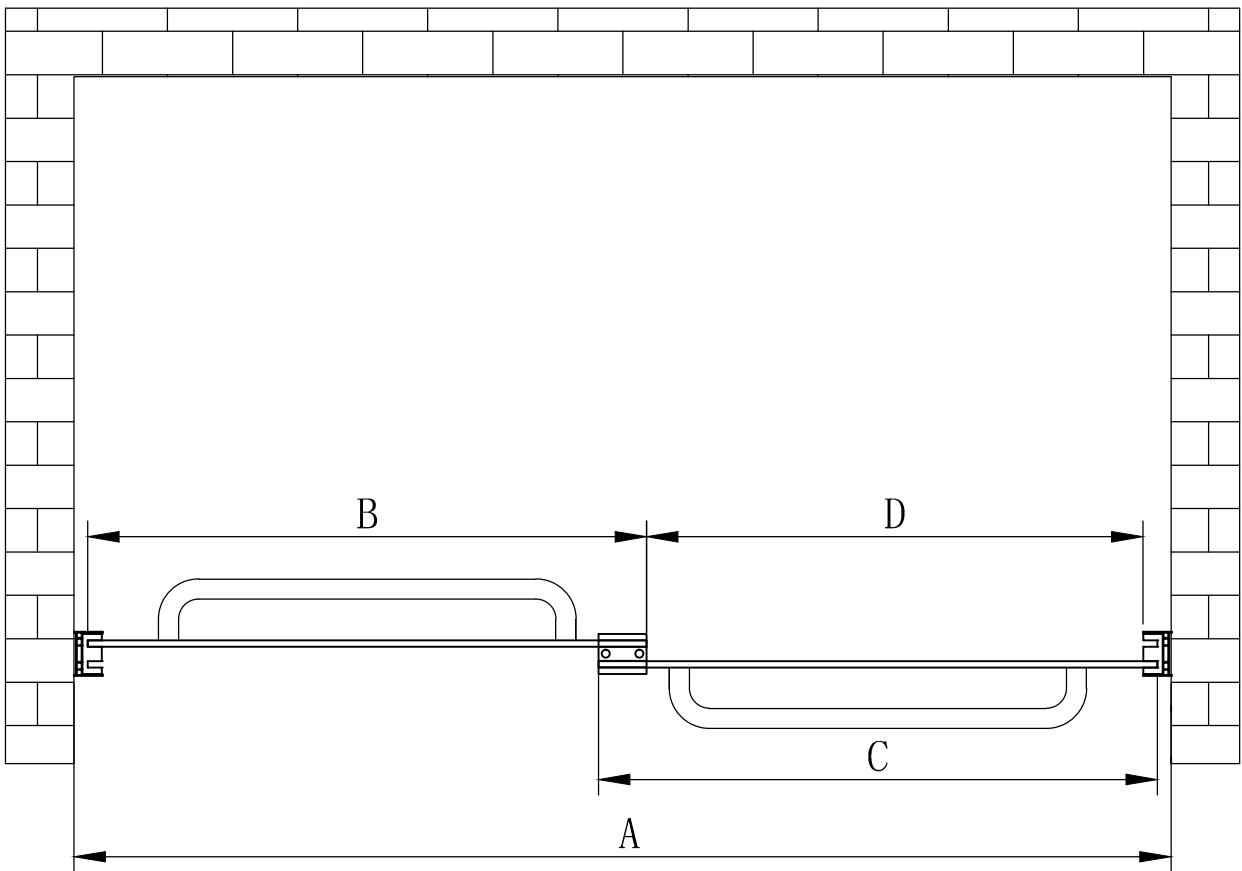
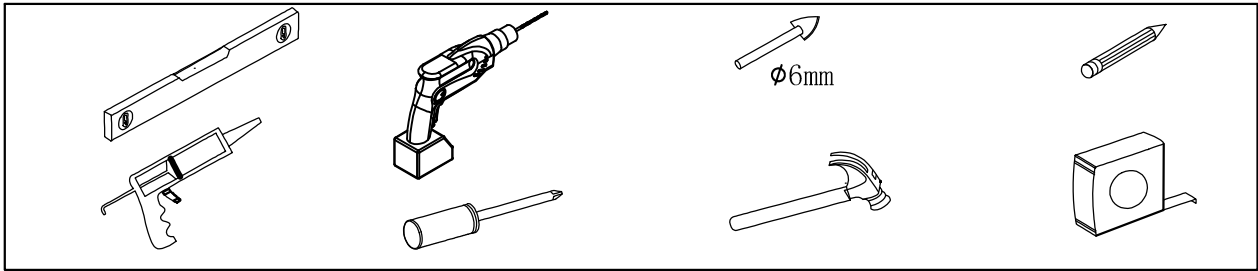

Dimension	Size A	Door B	Door C	Opening space D
48" x 76"	48"	24 1/2"	24 1/2"	21 1/2"
54" x 76"	54"	27 1/2"	27 1/2"	24 1/2"
60" x 76"	60"	30 1/2"	30 1/2"	27 1/2"
60" x 58"	60"	30 1/2"	30 1/2"	27 1/2"
66" x 76"	66"	33 1/2"	33 1/2"	30 1/2"

Step 1

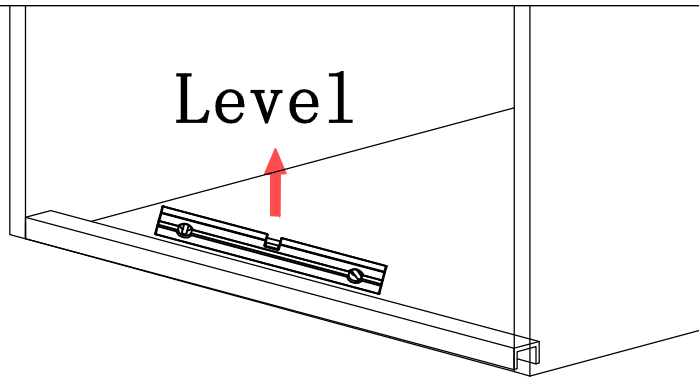

Step 2

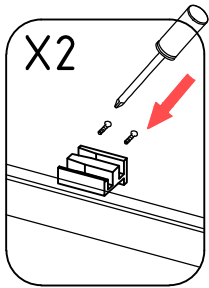

X1

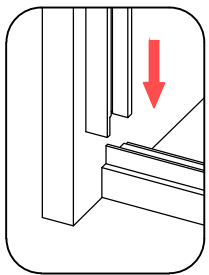

X2

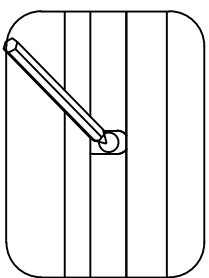

X6

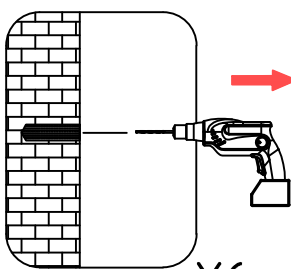

X6

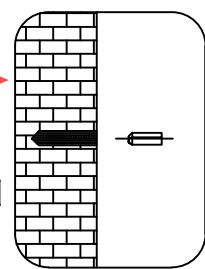

X6

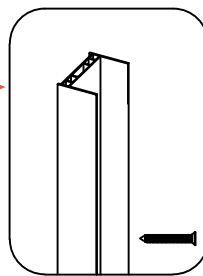

X6

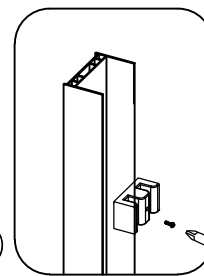

X6

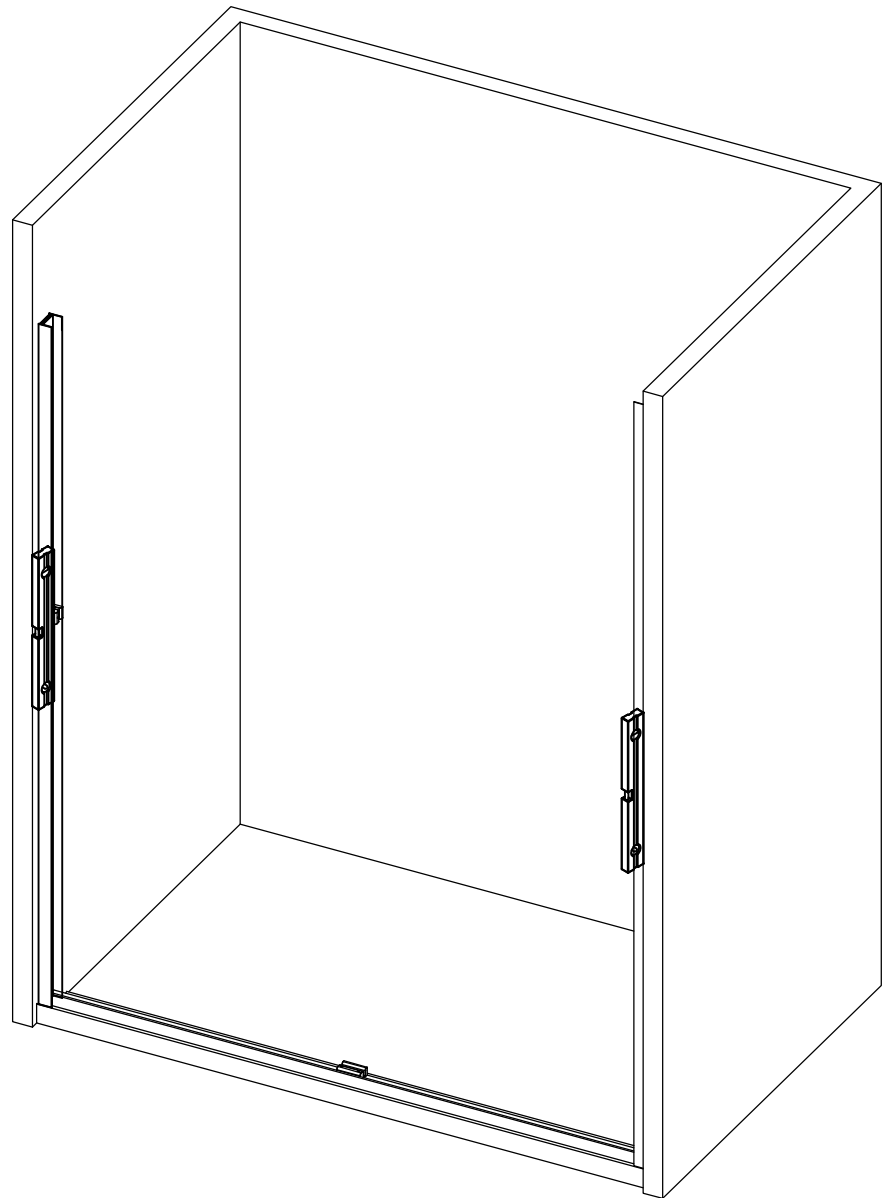

Step 3

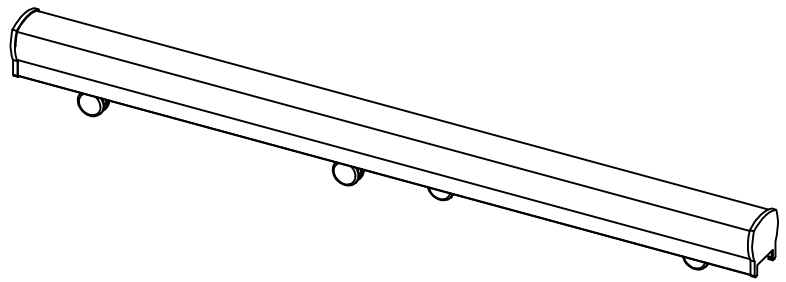
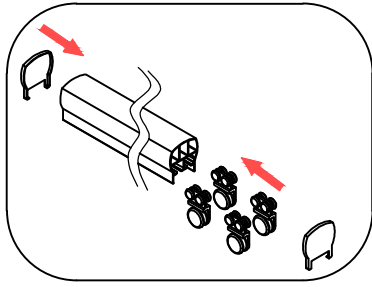

Step 4

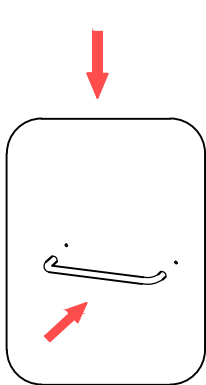
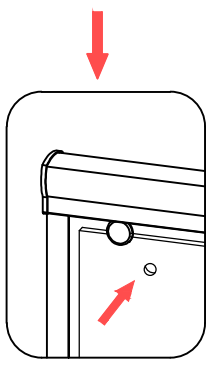
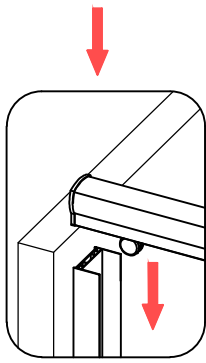

X4



X2

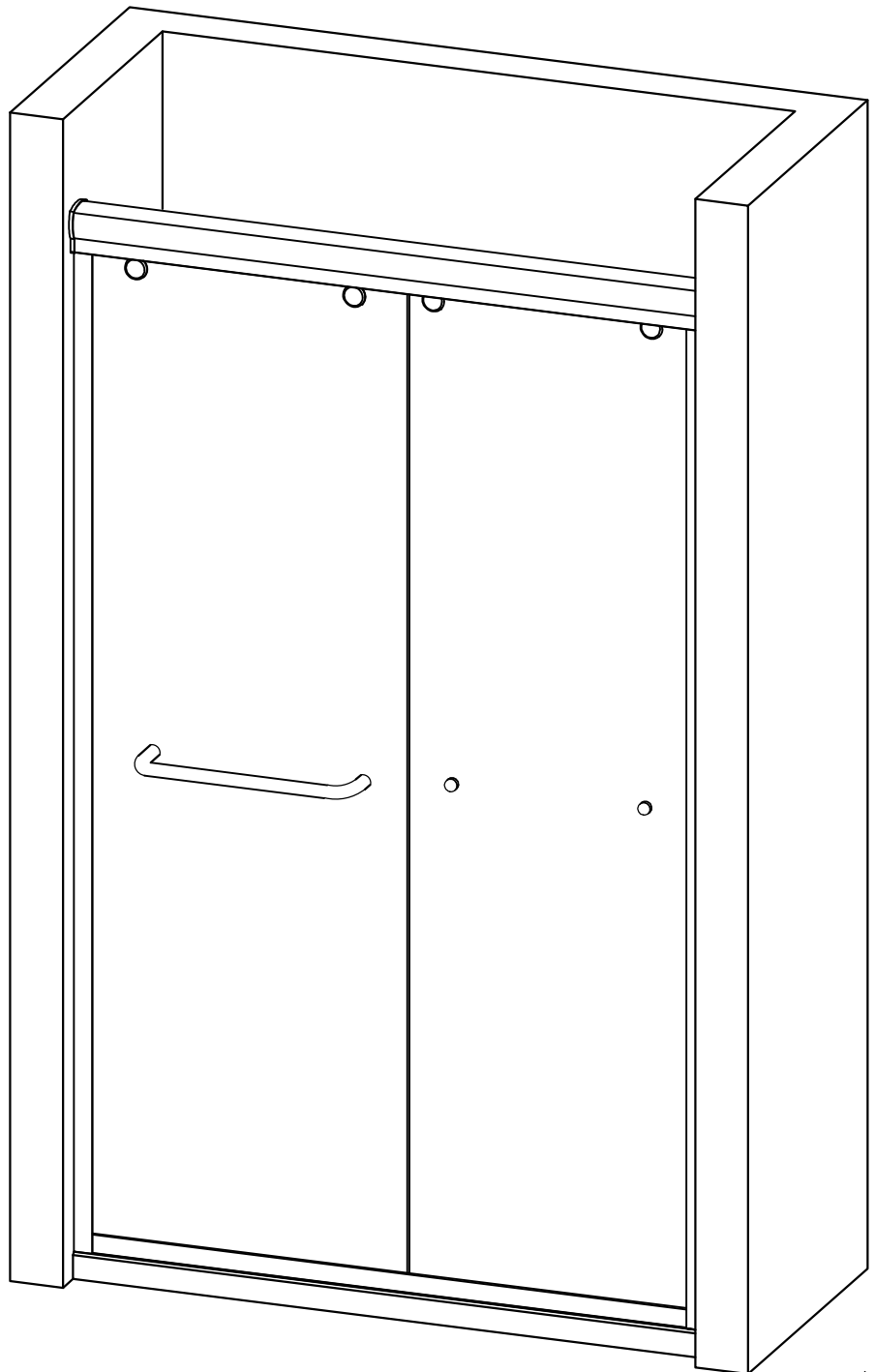

Step 5

DO NOT USE THE ENCLOSURE FOR
24 HOURS AFTER SEALING

