

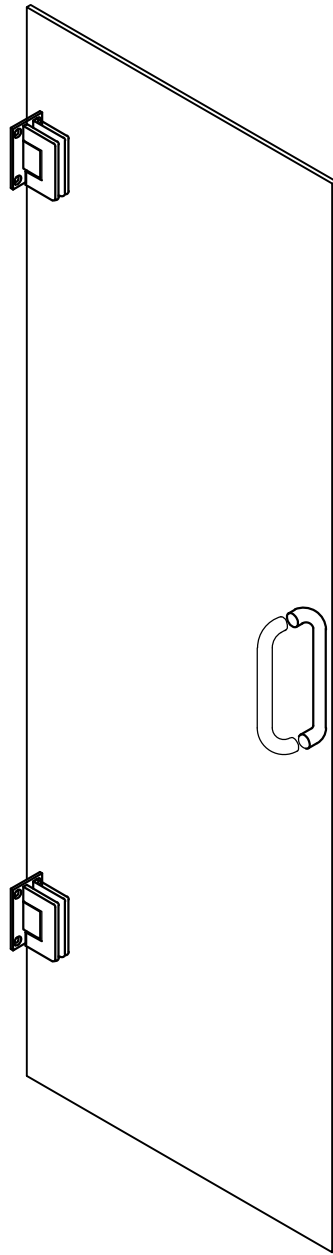

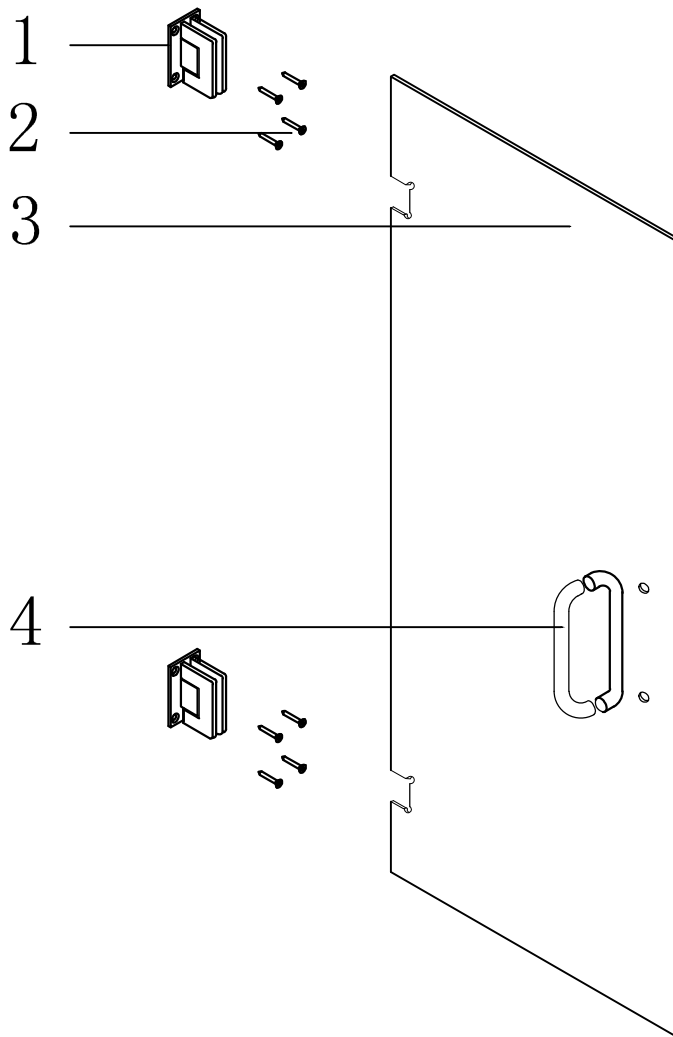

17P01 Installations Manual



Exploded diagram

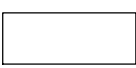

Parts List

1		X2
2		ST5x35
		X8
3		X1
4		X1

Tools Required

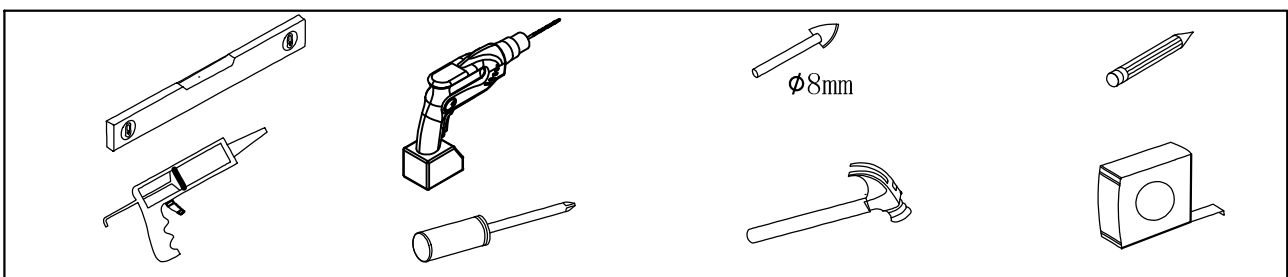

Step 1

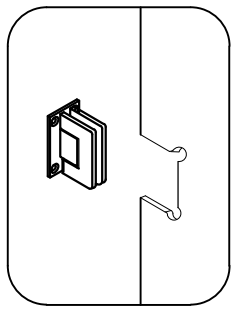

X2

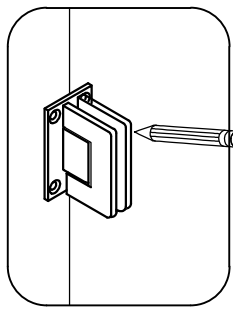

X2

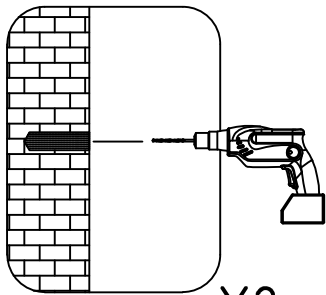

X2

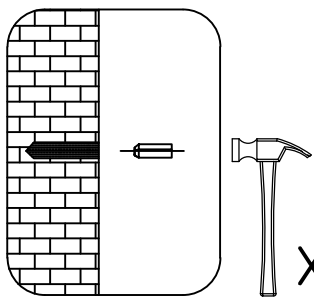

X2

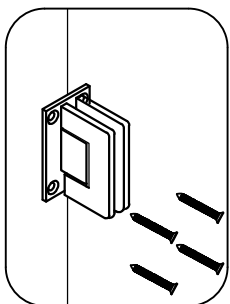

X2

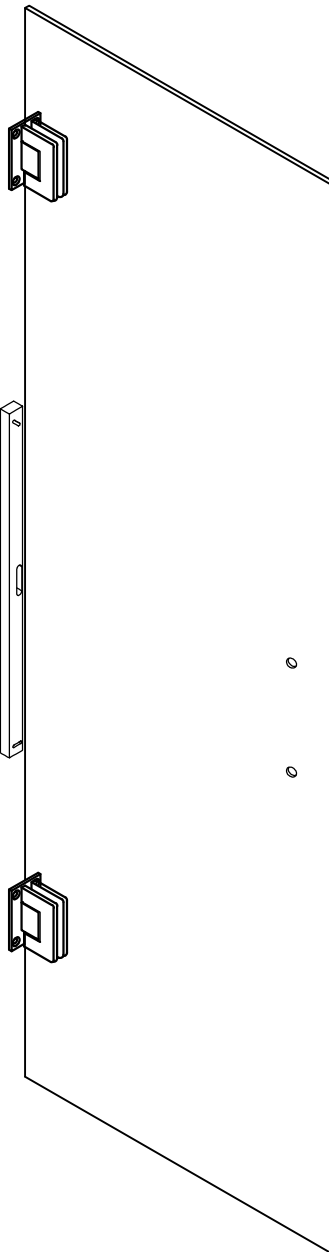
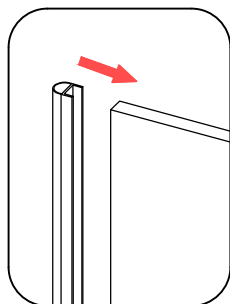

Step 2

DO NOT USE THE ENCLOSURE FOR
24 HOURS AFTER SEALING

