



SmartH



Hello, Smart Home



ENERGY SAVING



3-Way Smart Switch User Guide

Notes Before Installation

1. Wi-Fi Only support a 2.4GHz network (802.11 b/g/n)
2. Neutral wire Required.
3. basic electrical wiring knowledge or experience required , or please consult a professional electrician
4. Never connect the neutral wire to any switch wires
5. ON/OFF Button also can be used as reset button, long press to reset your smart switch to factory defaults. Only do this if you are sure you want to erase all your settings

Specifications

Type	Smart Wi-Fi 3-Way Switch
Model	S01
Power supply mode	Neutral+Live Wire
Input	AC 120V~60Hz 15A(Max)
Rated Power	1800W Resistive
Wireless Frequency	2.4GHz
Wireless Standard	IEEE802.11 b/g/n

Indicator light meaning

Indicator	Status	Discription
White	Flash Rapidly	Ready for connection (Default Mode Only)
White	Flash Slowly (1 time every 3S)	Ready for connection (AP Mode Only)
White	Off	Turn the light off
Red	On	Turn the light on
White	Flash Slowly	Networking

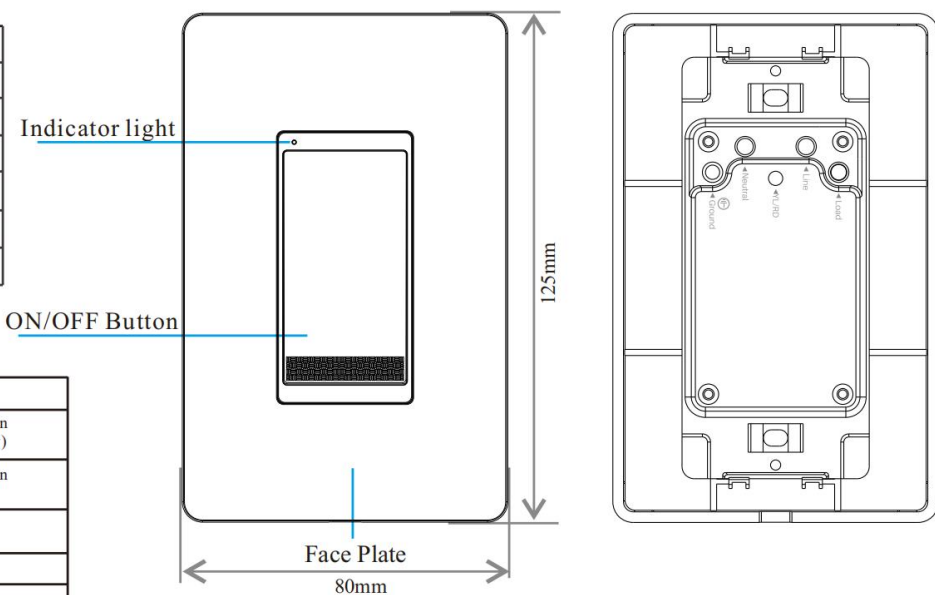

Safety Notice:

- **Cut off the power before installation**
- **Please use it only when it's installed with RCD or current leakage protector at home**
- **A neutral wire is needed to power the switch.**

Smart Lighting Switch

Installation Schematic Diagram



Installation Guide

STEP.1

Turn off circuit breaker

Find your light's control in your circuit breaker and turn it off, Then make sure the power is off by flipping your switch a few times.

STEP.2

Find the neutral wire

In the wall cassette . look for one or more white wires secured with a wire nut. Do you have a neutral wire?

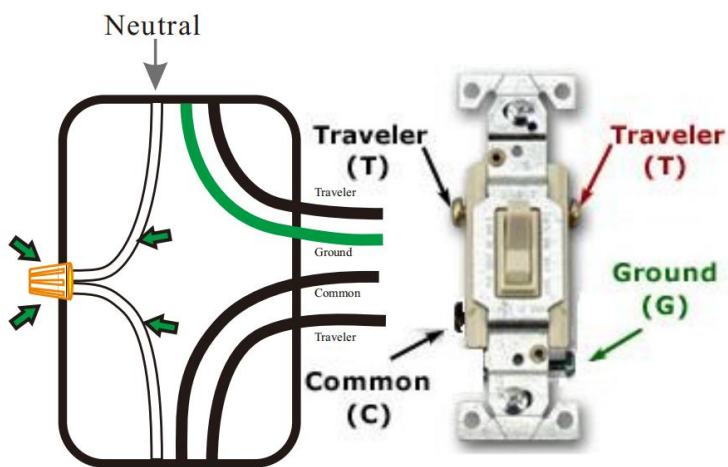
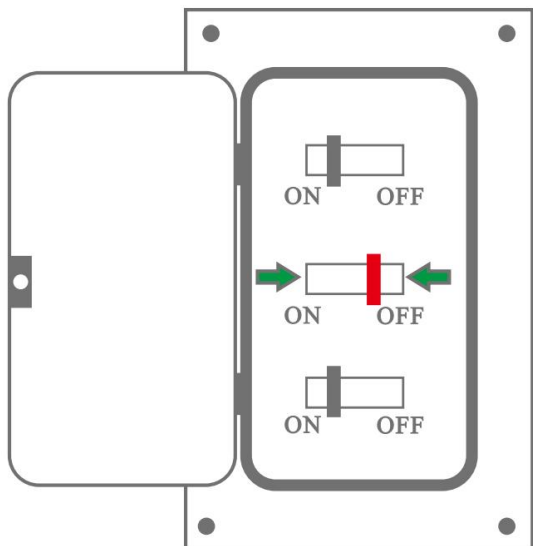

If you can't find neutral wire
Please change another wall cassette. to find a neutral wire,if you really can't find out a neutral wire in your wall cassette. please contact professional electrician to help you.

Single Pole Switch Schematic Diagram of a Traditional Switch Wiring

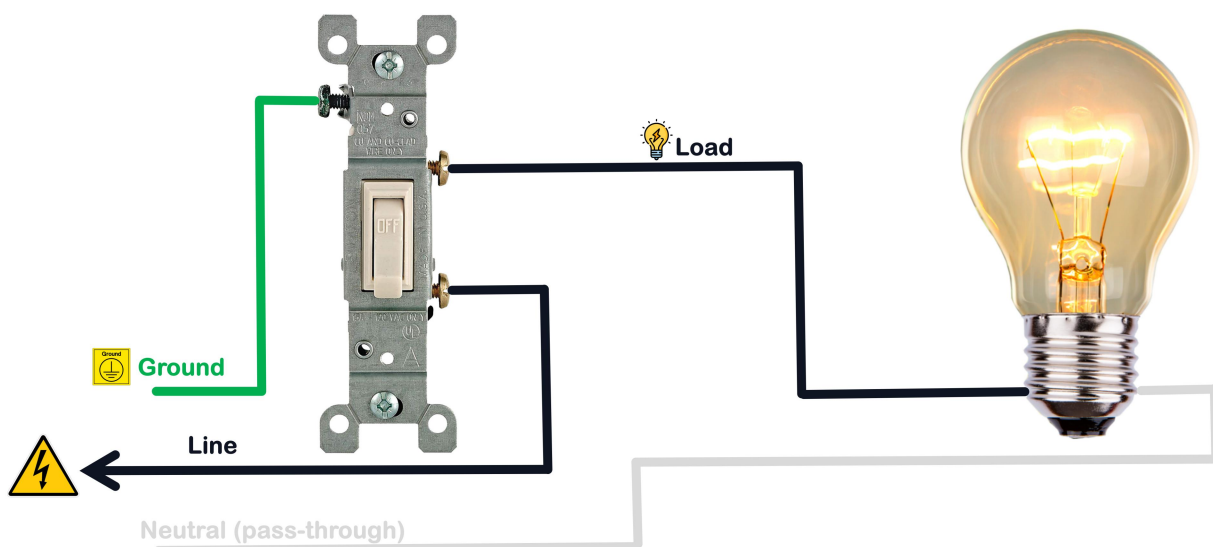

For Single Pole Switch



Replace traditional switch with Smart Switch

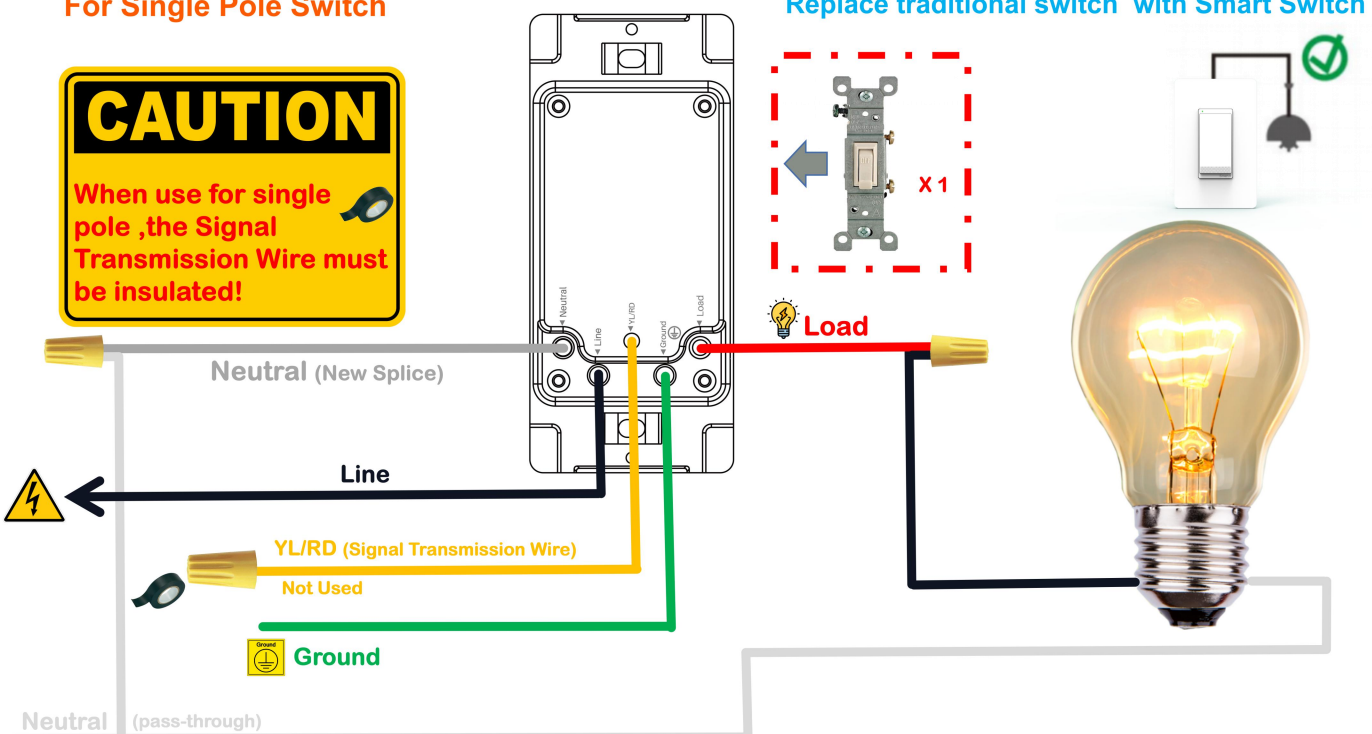

3-Way Switch

Schematic Diagram of a Traditional 3-Way Switch Wiring

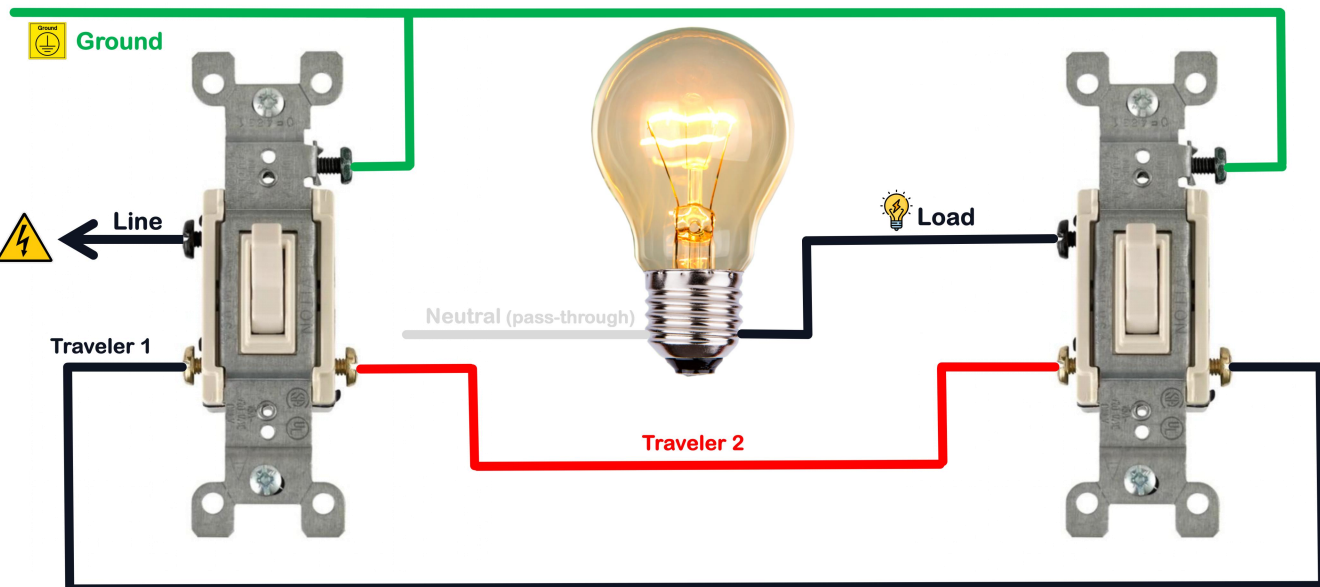

For 3-Way (Method 1)

Traditional Switch+Smart Switch

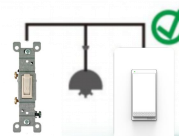

CAUTION

1. If you only want to replace one switch with a smart switch, then the smart switch must be installed at the load end.
2. The load end is supplied with power.

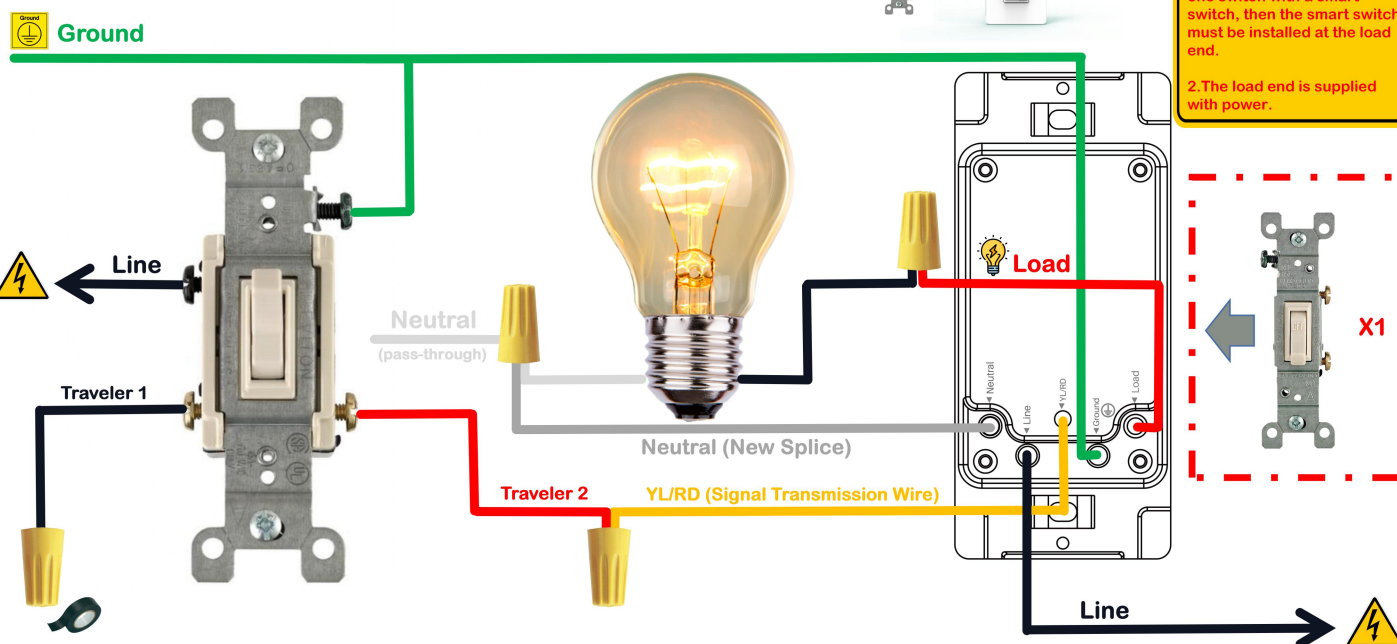

For 3-Way (Method 2)

Traditional Switch+Smart Switch

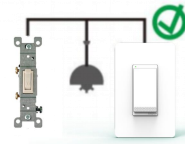

CAUTION

1. If you only want to replace one switch with a smart switch, then the smart switch must be installed at the load end.
2. The load end is not supplied with power.

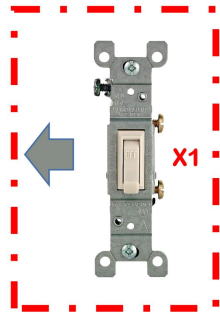
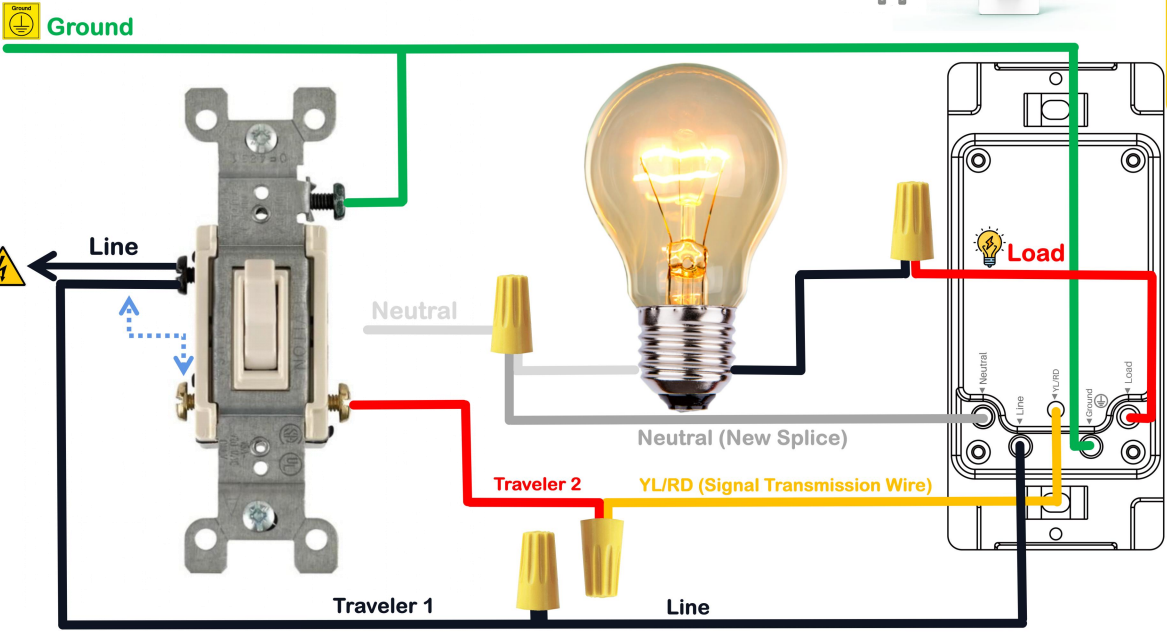

For 3-Way (Method 1)

Smart Switch + Smart Switch

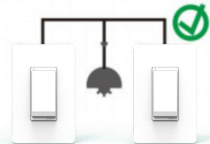

CAUTION

1. The load end is supplied with power.
2. You don't have to take Traveler 2 Wire, and must be insulated.

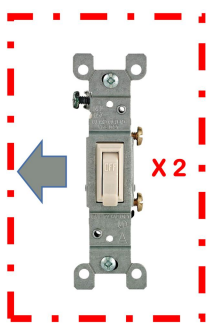
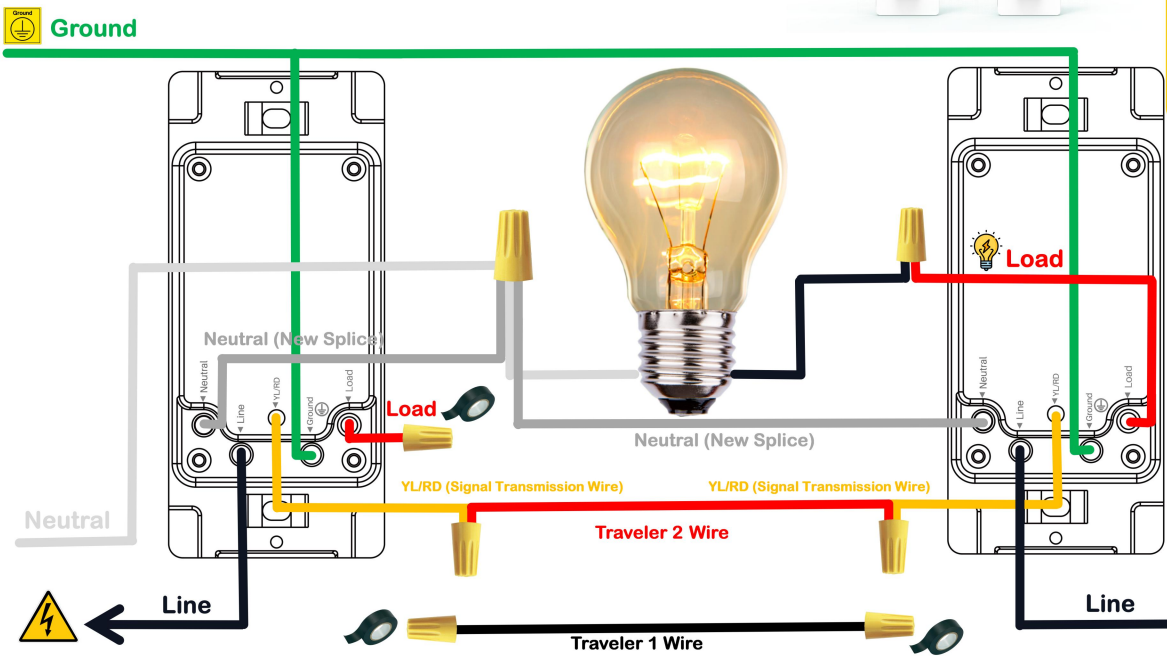

For 3-Way (Method 2) Smart Switch + Smart Switch

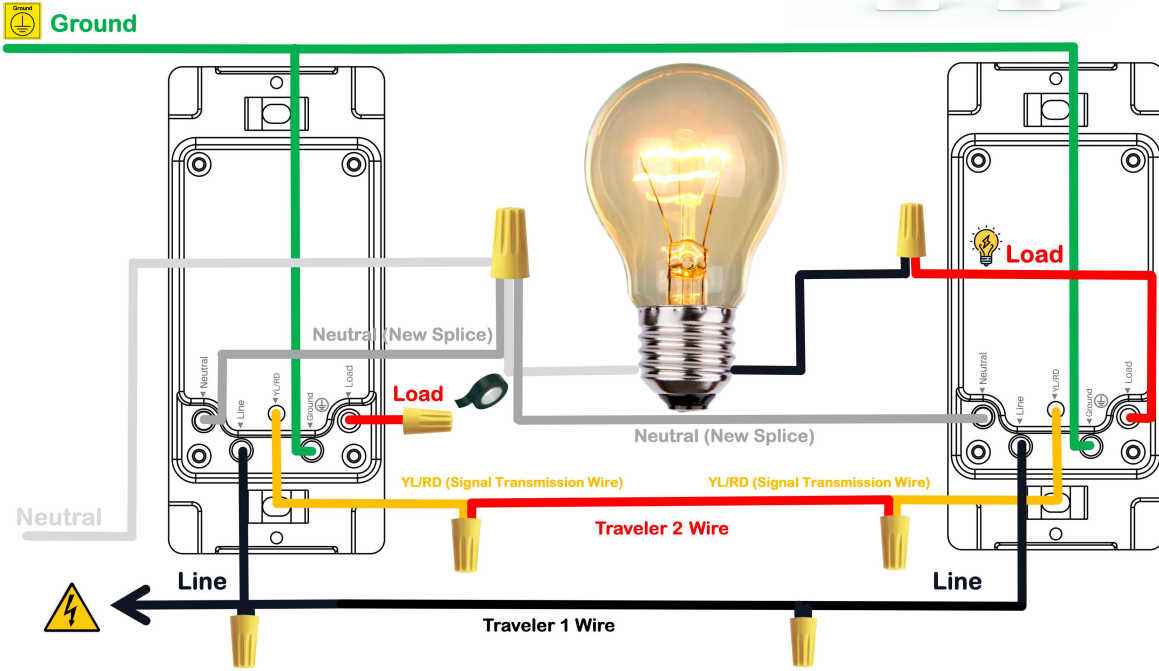

CAUTION

1. The load end is not supplied with power.
2. You must use **Traveler 1 Wire** to connect the **Line** terminals of the two switches.

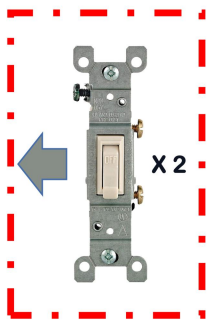

For 4-Way Smart Switch + Smart Switch + Smart Switch + Smart Switch

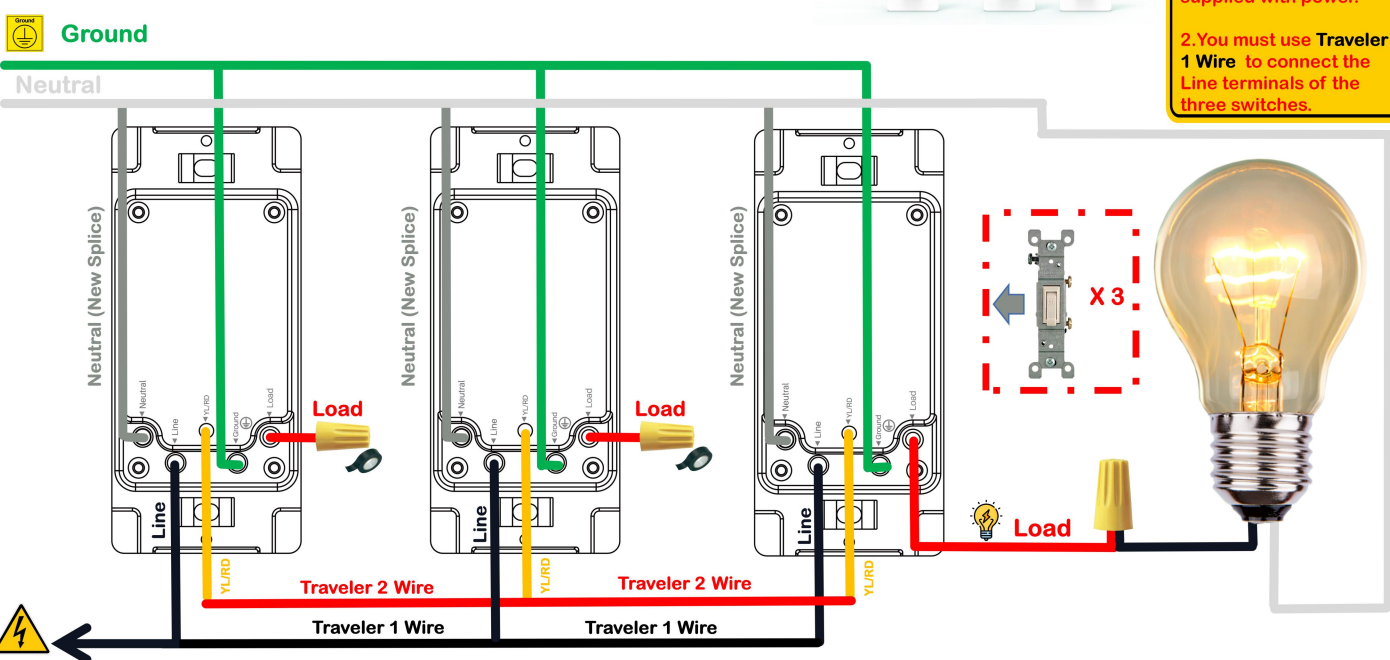

CAUTION

1. The load end is not supplied with power.
2. You must use **Traveler 1 Wire** to connect the **Line** terminals of the three switches.

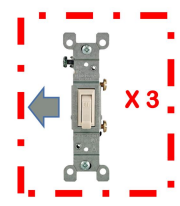

STEP.4

Turn on circuit breaker

Turn on your switch's power from the circuit breaker. Press the switch a few times to make sure it works.

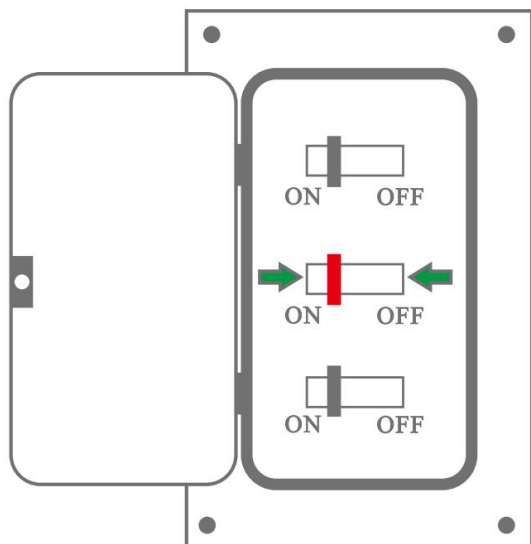

STEP.5

Check the Wi-Fi light

Tap NEXT when the Wi-Fi indicator light blinks

Indicator light rapidly blinks (2 times per second)

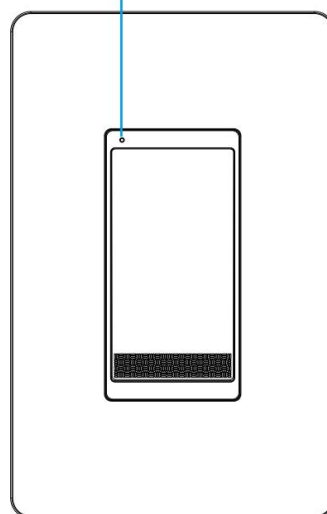

Install the “MySmarth” APP

Step A .Find out “MySmarth”app in Apple app store, Google Play, or scan the QR code below and install it.



The free app”MySmarth” is compatible with mobile devices the support IOS8.0 above, Android 4.4 above

Step B .Enter the register interface, input the email address/phone number for getting the verification code to register an account. Please just login if you already have a MySmarth account.

1. Set Up Router

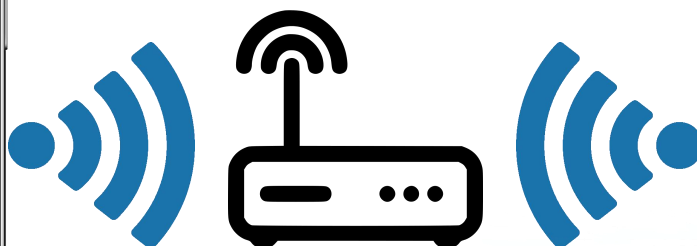
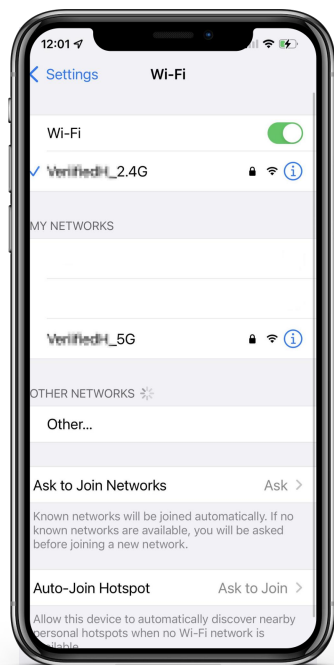

Please keep network available

2.4GHz

5GHz



The router supports the 2.4GHz WiFi (doesn't support the 5GHz), and is connected to the WiFi network. Please set the parameters of the router before connecting the WiFi network, and record the SSID and password of your WiFi.

2. Turn On Your Smartphone's Bluetooth

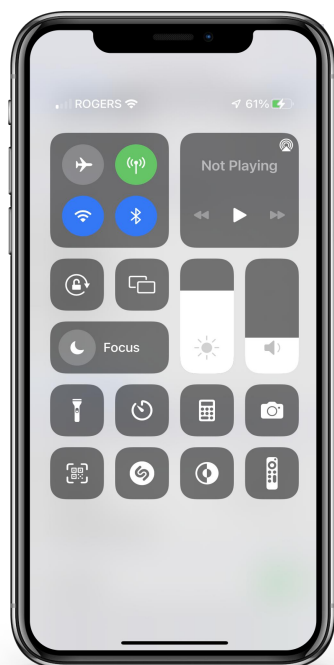

Turn on your smartphone's Bluetooth.

Step C: Add the switch to MySmarth APP

Note: This smart switch can only support 2.4G network and cannot work with 5.0G network. please check if your home network is 2.4G and make sure that your phone has been connected to your Wi-Fi home network

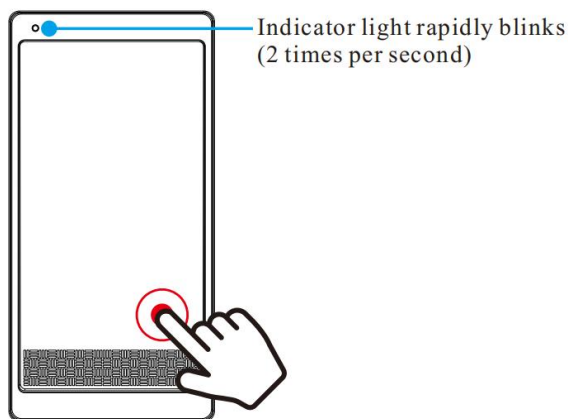

Step.1. After powering on, press and hold the ON/OFF button for 5-7 seconds, and the indicator light flashes quickly

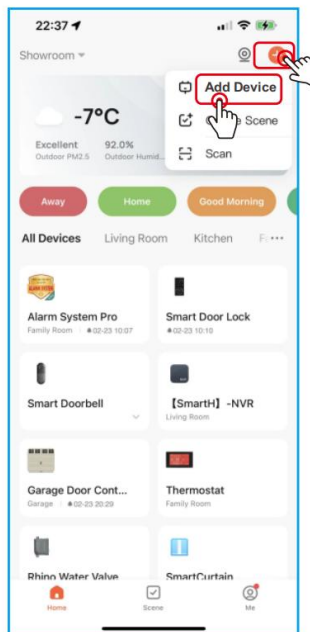

(1) Tap "+" button on top right corner to add device.

8

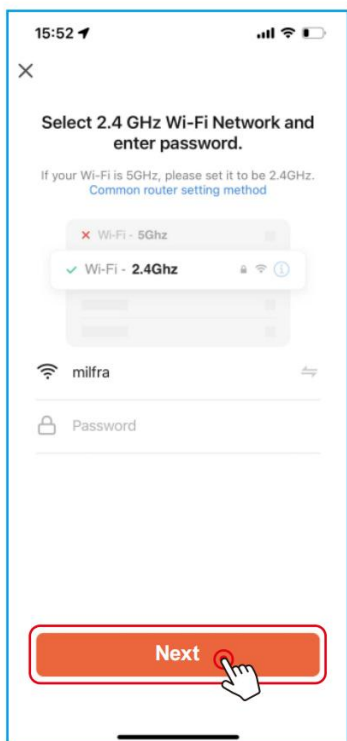

Step.2
Enter Wi-Fi password to join your network

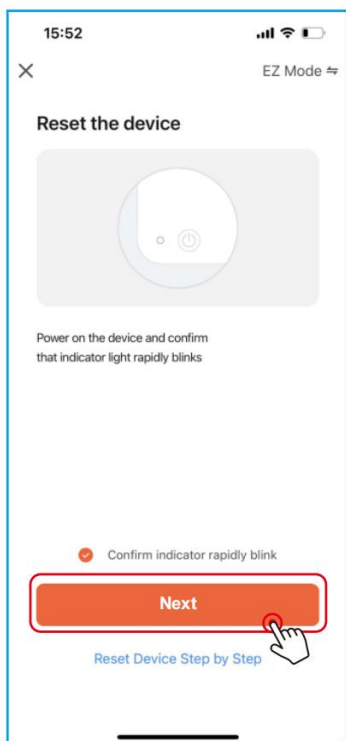

Step.3
Next

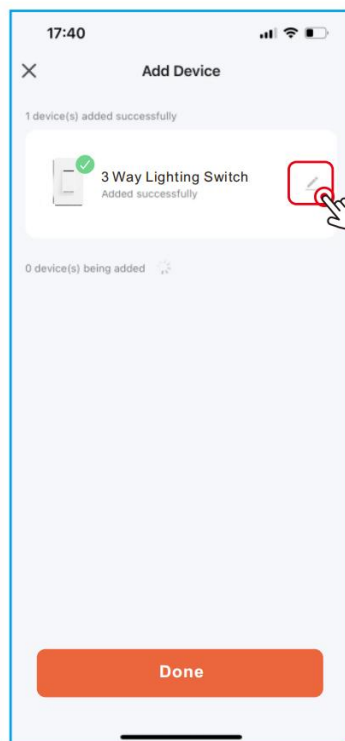

Step.4
Device added successfully you can modify device name.

9

Step D: Give a name to the switch and tap "Completed". you will find the device you've named is shown on the app home page. Tap the device to enter the setting page.

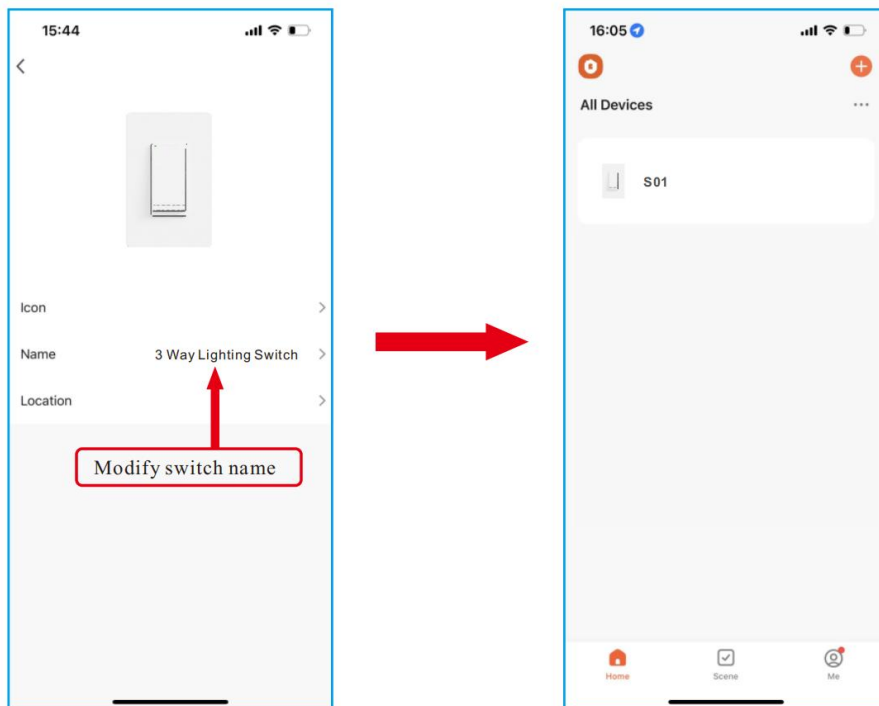

10

After completing Part Two, you can now control the switch with MySmarth APP on this setting page.

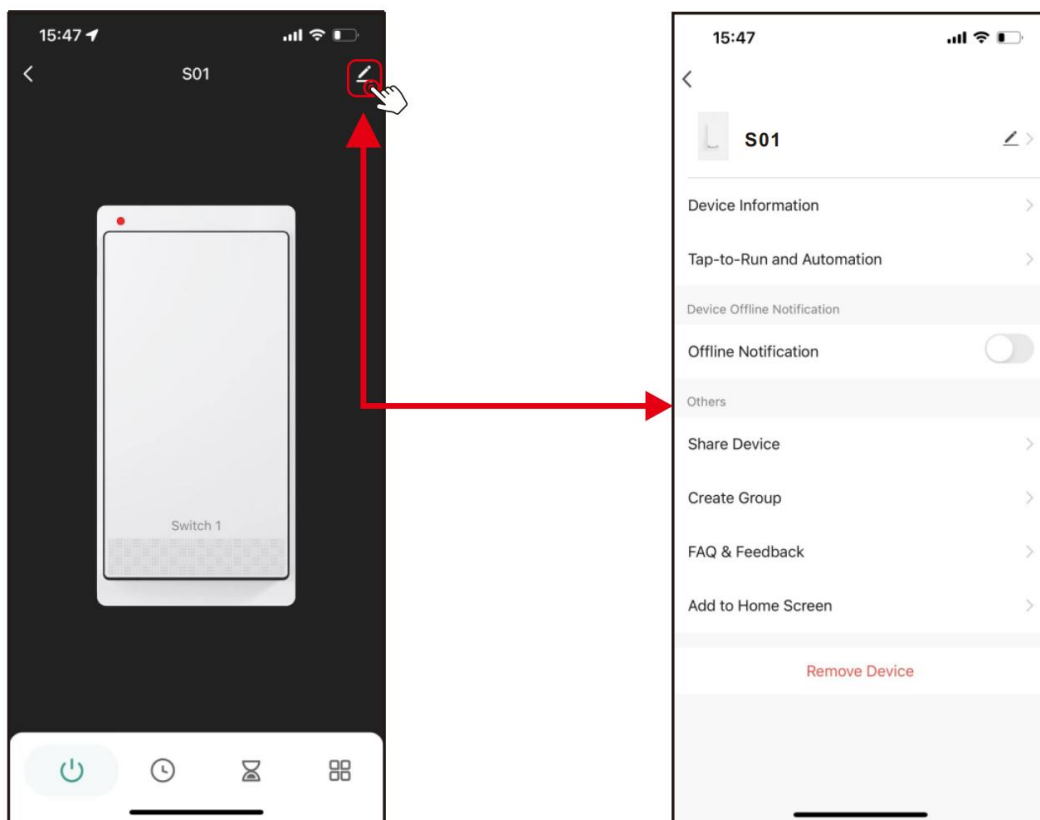

11

