



SmartH



Hello, Smart Home





Pet Fountain Instructions

Precautions

Read all the instructions

When using electrical appliances, basic safety precautions should always be followed, including the following:

1. Do not touch hot surfaces. Use handles.
2. To protect against electric shock do not immerse cord, plug into water or other liquid.
3. Close supervision is necessary when any appliance is used by or near children.
4. Unplug from outlet when not in use and before cleaning. Allow cooling before putting on or taking off parts, and before cleaning the appliance.
5. Do not operate any appliance with a damaged cord or plug, should the appliance malfunction, or if it has been damaged in any manner. Return appliance to the nearest authorized service facility for examination, repair or adjustment.
6. The use of the accessory attachments is not recommended by the appliance manufacturer as it may cause injuries.
7. Do not use outdoors.
8. Do not let the cord hang over the edge of table or counter, or touch hot surfaces.
9. Do not place on or near a hot gas or electric burner, or in a heated oven.
10. Always attach the plug to appliance first, then plug the cord in the wall outlet.
11. Do not use the appliance for other than intended use.
12. **WARNING:** Never leave the appliance unattended whilst in use.
13. **Warning:** keep the supply cord away from the heating tip and metal enclosure while using.
14. This appliance is not intended for use by persons (including children) with reduced physical, sensory or mental capabilities, or lack of experience and knowledge unless they have been given supervision or instructions concerning the use of the appliance by a person responsible for their safety.
15. Children should be supervised to ensure that they do not play with the appliance.
16. If the SUPPLY CORD is damaged, it must be replaced by the manufacturer, its service agent or similarly qualified persons in order to avoid a hazard.
17. **WARNING:** This tool must be placed on its stand when not in use.

Inside the box



Fountain

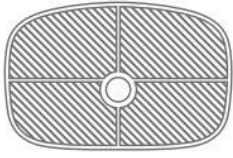

Filter



5V 2A Power Supply



Micro USB Cable 4 Feet (1.2M)



Replacement Foam

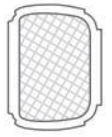

Replacement Pump Filter Sticker

Meet your Fresco Ultra

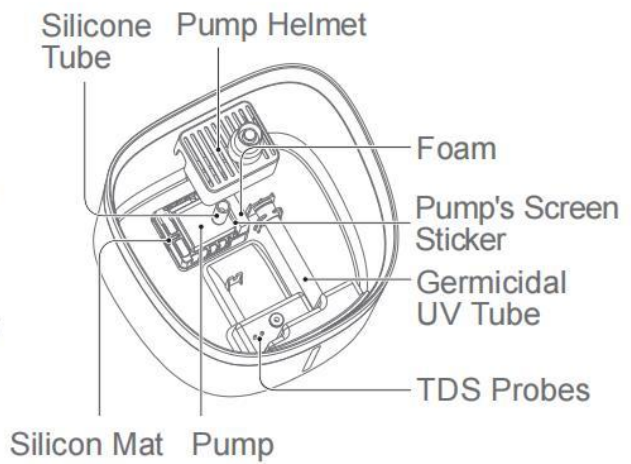
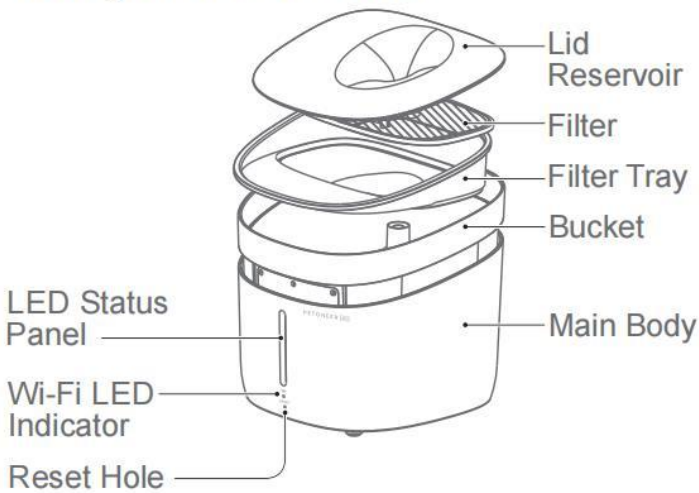

How sterilization works: The UVC ultraviolet light emitted by the tube at the bottom of the fountain can destroy the DNA structure of microorganisms such as bacteria, causing the bacteria to die. It works for 3 minutes every interval. The lighting lasts for 3 minutes every interval killing up to 99.7% bacteria.

Operations

1. Assemble

Please put all parts in the right places according to the illustration;

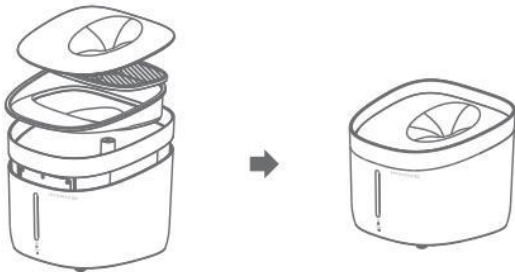

3. Fill up

Pour water into the bucket. Do not exceed the max water level.

5. Accessories replacing

It is recommended to replace the filter, foam and pump's screen sticker regularly.

2. Power on

Connect the Micro USB cable to the power input port at the bottom, then connect A/C adapter to the wall outlet.

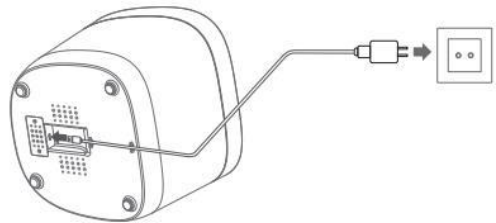

4. Clean up

Lift the bucket and clean the inside of the bucket.

6. Connect the fountain

Download the Mysmarth App and connect the fountain to your Wi-Fi to monitor and control.

Set Up Router

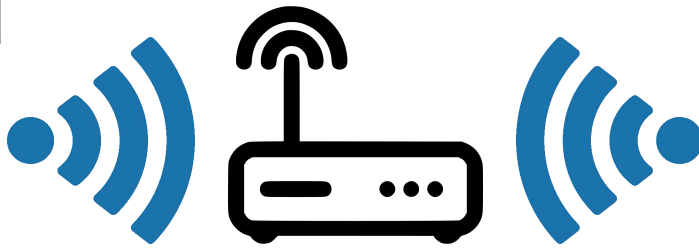
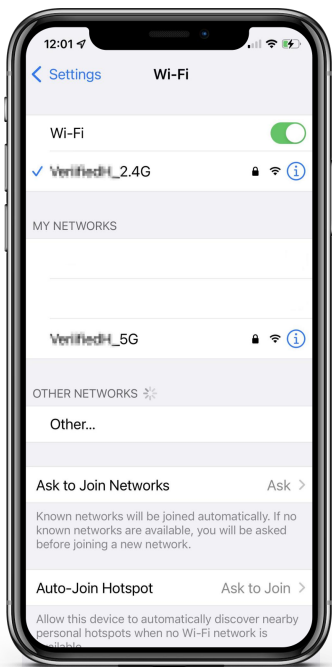

Please keep network available

2.4GHz

5GHz



The router supports the 2.4GHz WiFi (doesn't support the 5GHz), and is connected to the WiFi network. Please set the parameters of the router before connecting the WiFi network, and record the SSID and password of your WiFi.

Install Free App

Download APP: scan the QR code below to download and install. Register and login: open the "MySmarth" APP to register and login according to the prompts.



Customer Support



Ready to work



Step1: Long press the reset button with the needle and hold for 5 seconds.

Step2: Let the red Light Flash (rapid blink)

Two pairing modes are provided in the MySmartH app. The Wi-Fi Easy Connect (EZ) mode is the default mode, and the access point (AP) mode is the compatible mode. The user can tap the pairing mode drop-down list in the top-right corner of the page to switch between the pairing modes.

Manually add Wi-Fi devices in EZ mode

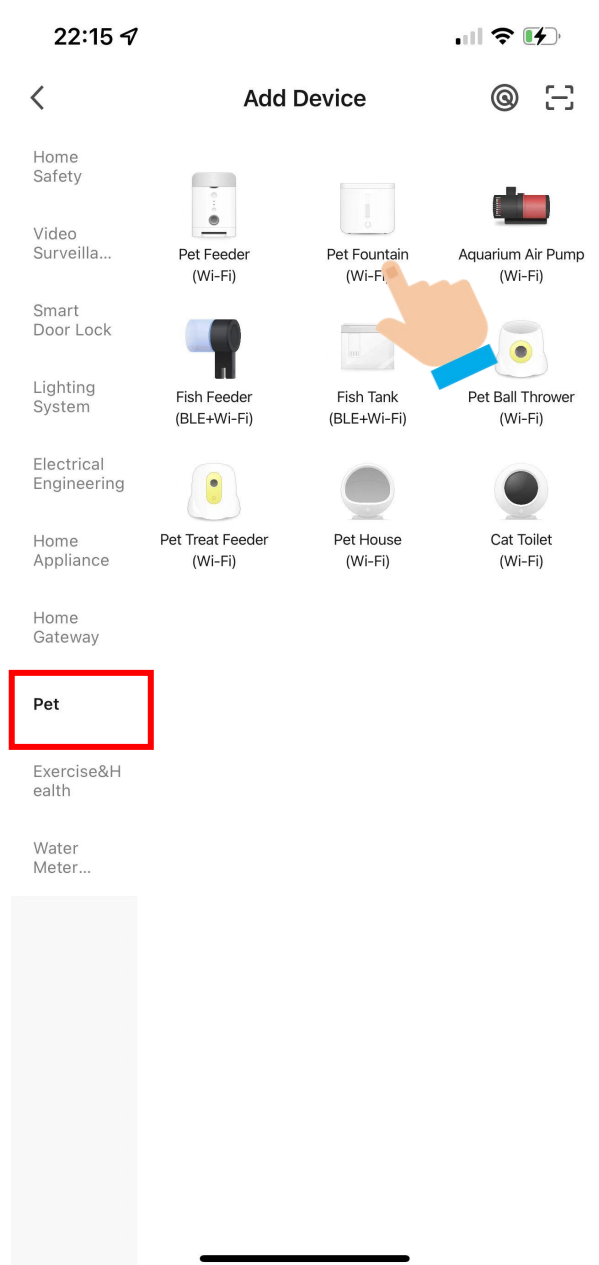
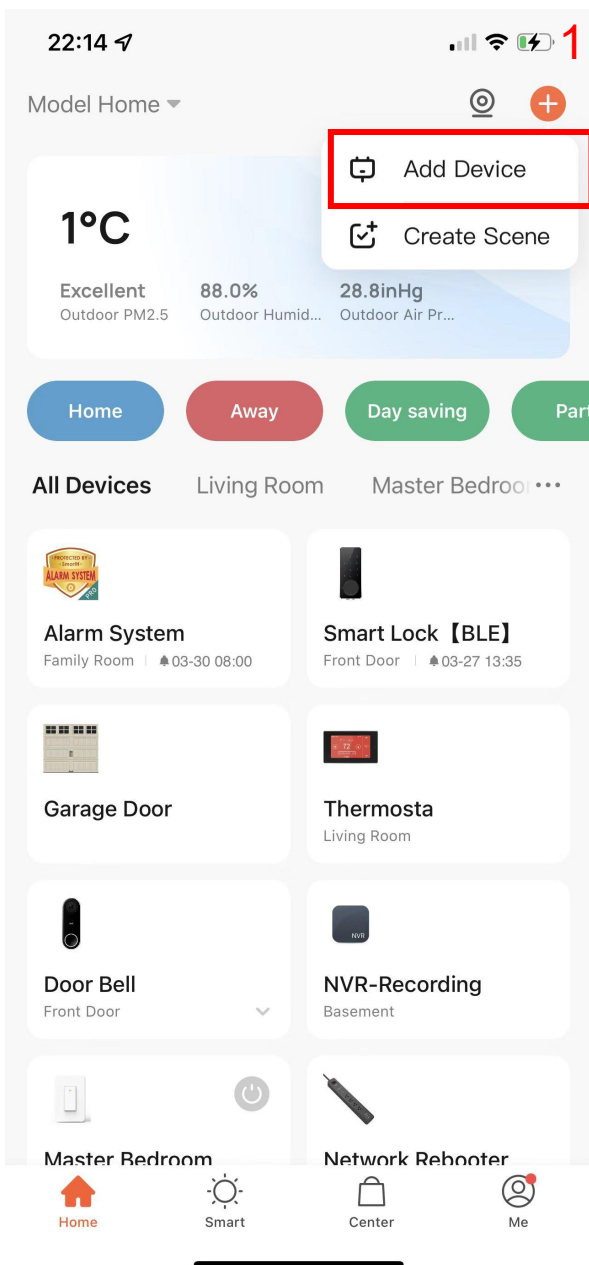

1. Open "MySmartH" APP, press the '+' in the upper right corner of the main screen;

2. Choose "Pet", click "Pet Fountain."

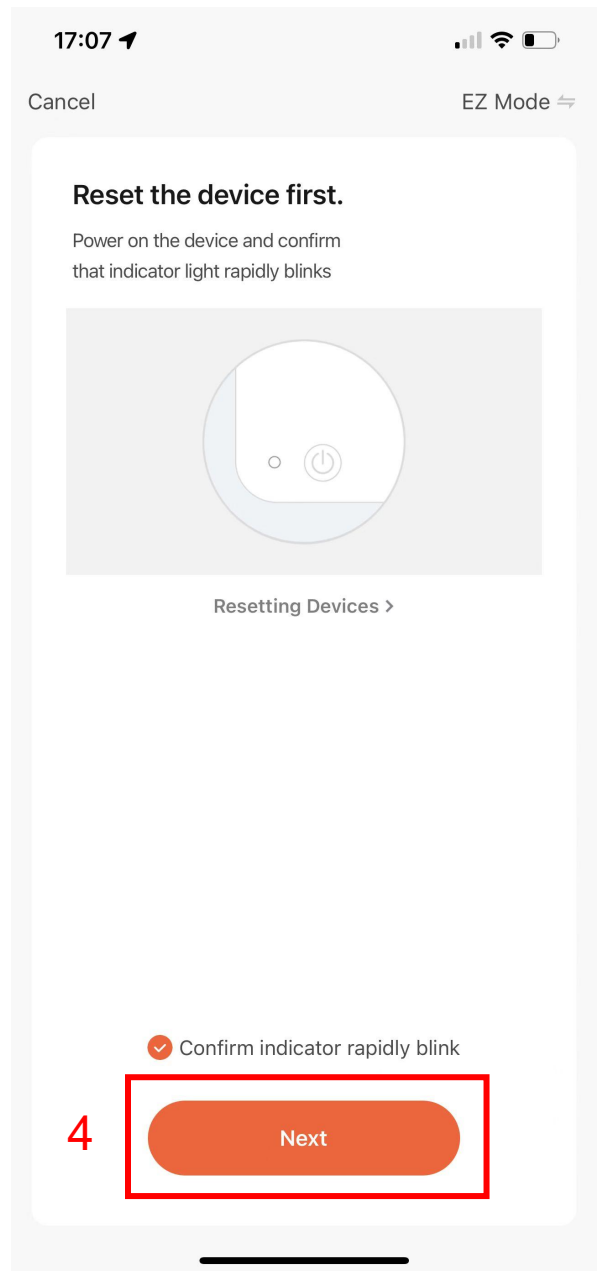
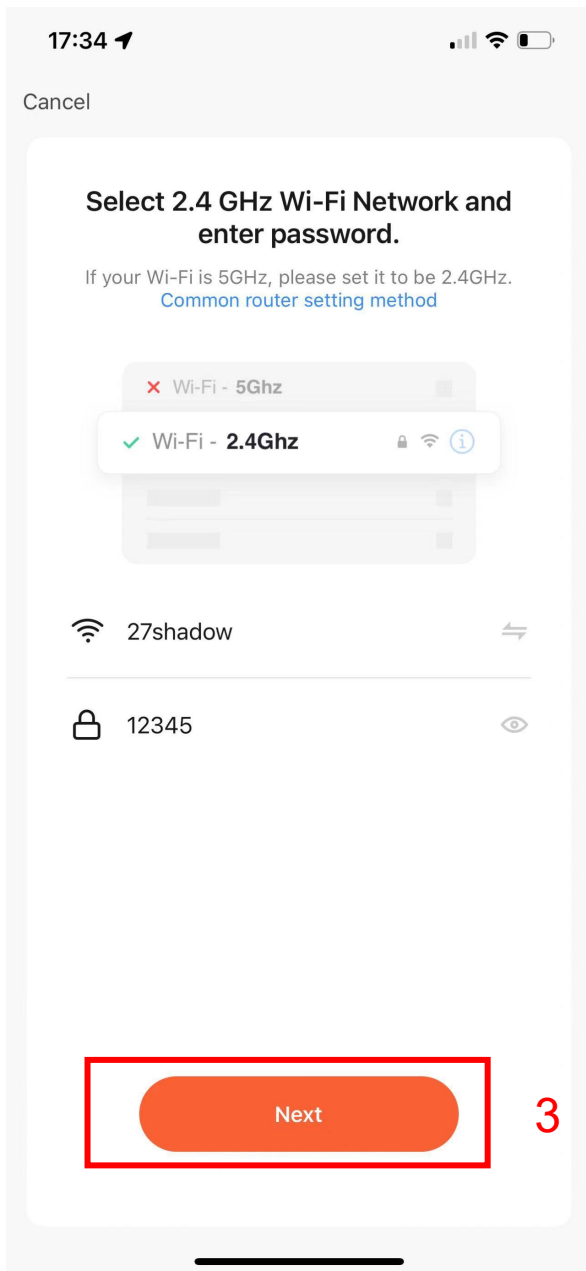

3. Choose WiFi and enter password and tap “Next”;

4. Confirm that the red indicator light of the Pet Fountain is flashing quickly and tap "Next";

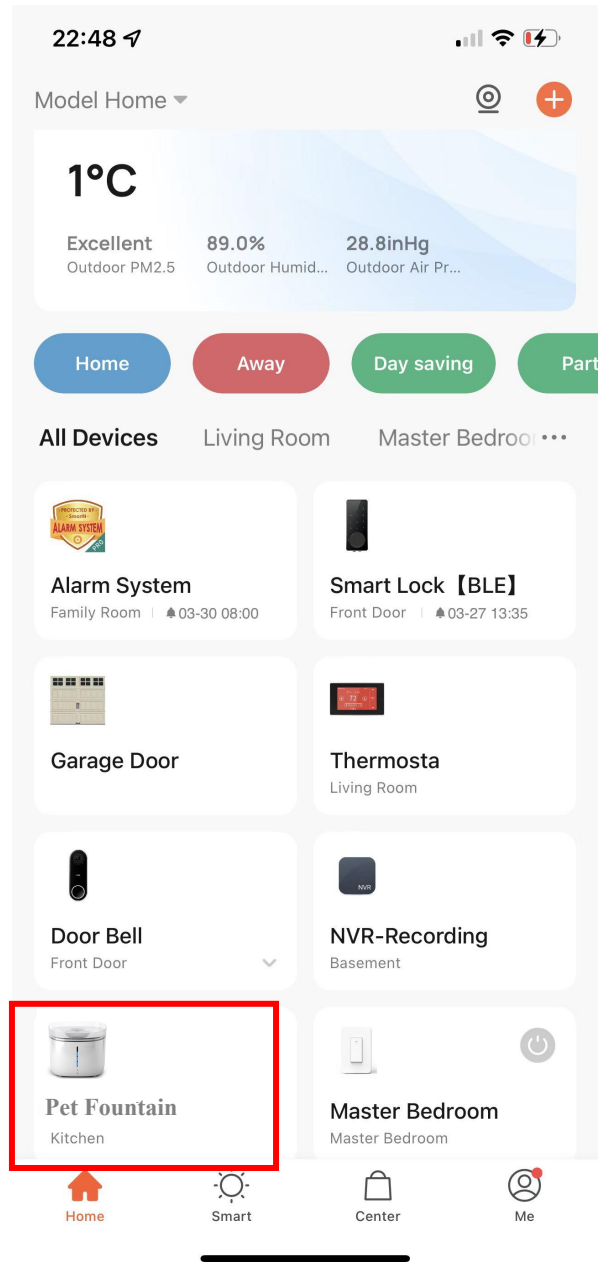
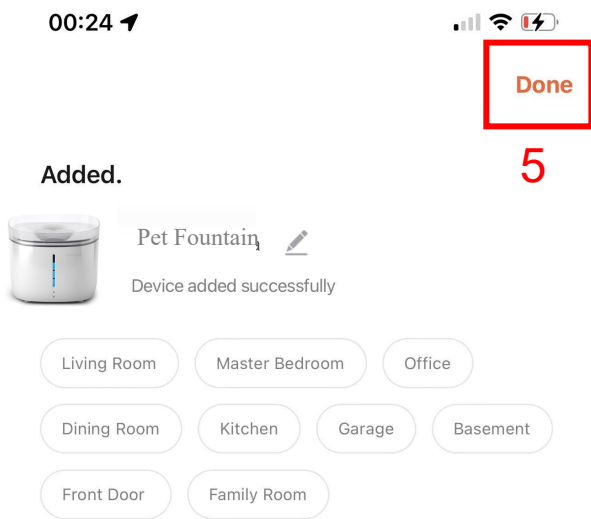

5. When connecting, you should make sure your router, mobile, and Pet Fountain are as close as possible. When Pet Fountain added successfully.

Manually add Wi-Fi devices in AP mode

If the connection fails, please try AP mode

If a dual-band network that supports both 2.4 GHz and 5 GHz bands is used, the AP mode can be used to add devices.

In AP mode, follow the instructions to enable the indicator to blink slowly, select Confirm the indicator is blinking slowly, and then tap Next.

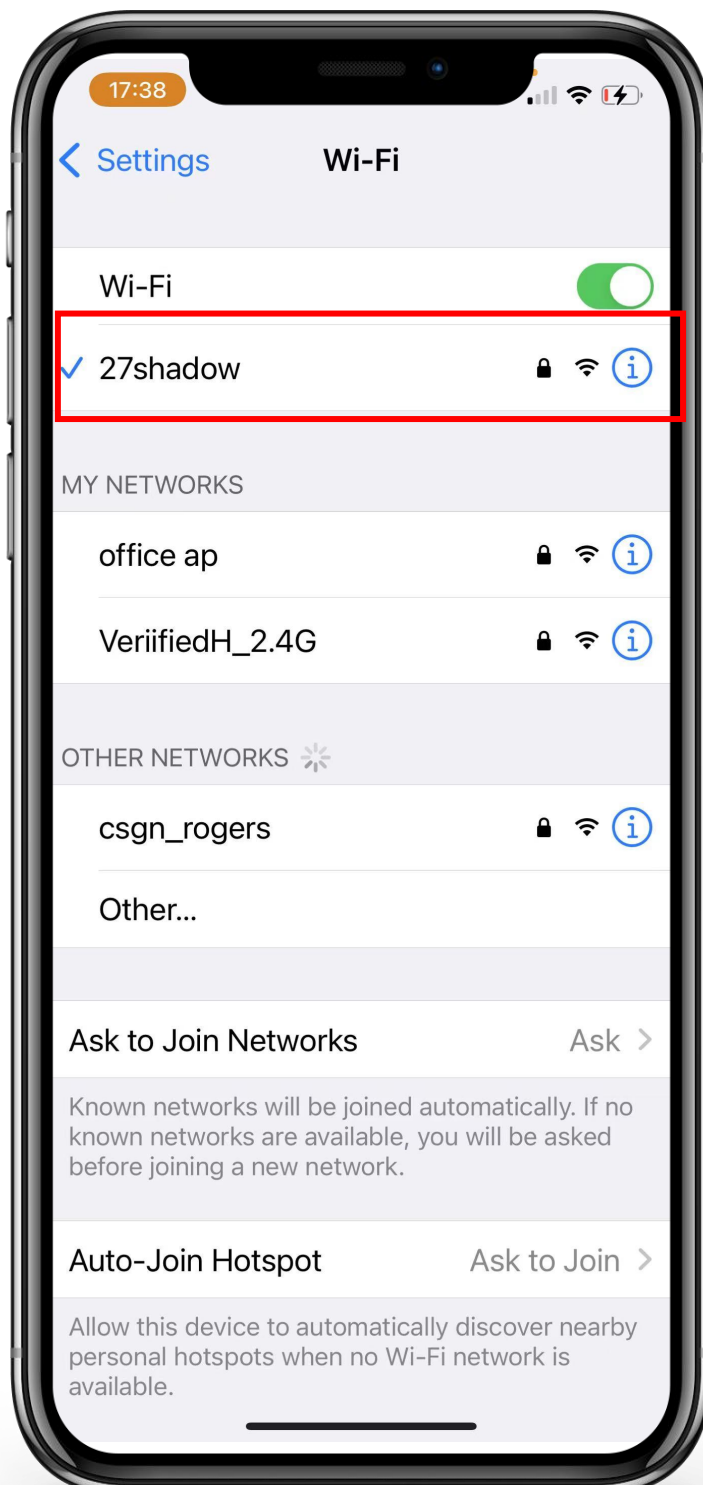

Ready to work



Step1: Long press the reset button with the needle and hold for 5 seconds.

Step2: Let the red Light Flash (blink slowly), If the indicator light of the Pet Fountain is flashing fast, please continue to press and hold the reset button until the fast flashing turns to slow flashing.

Connect the Pet Fountain to MySmarth App

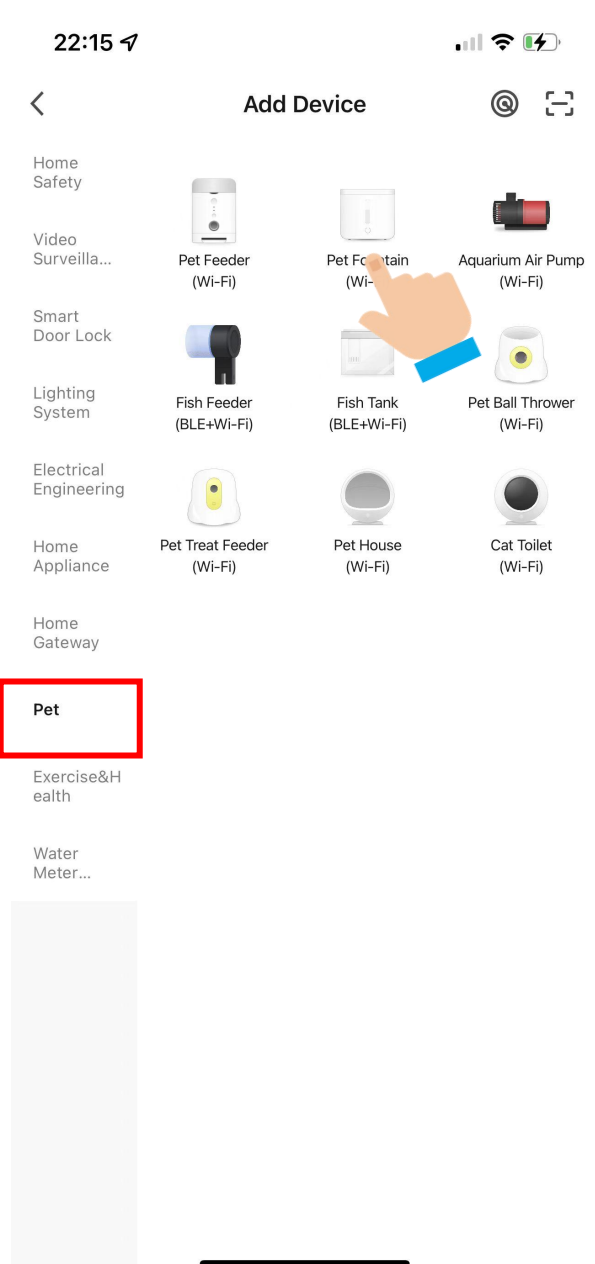
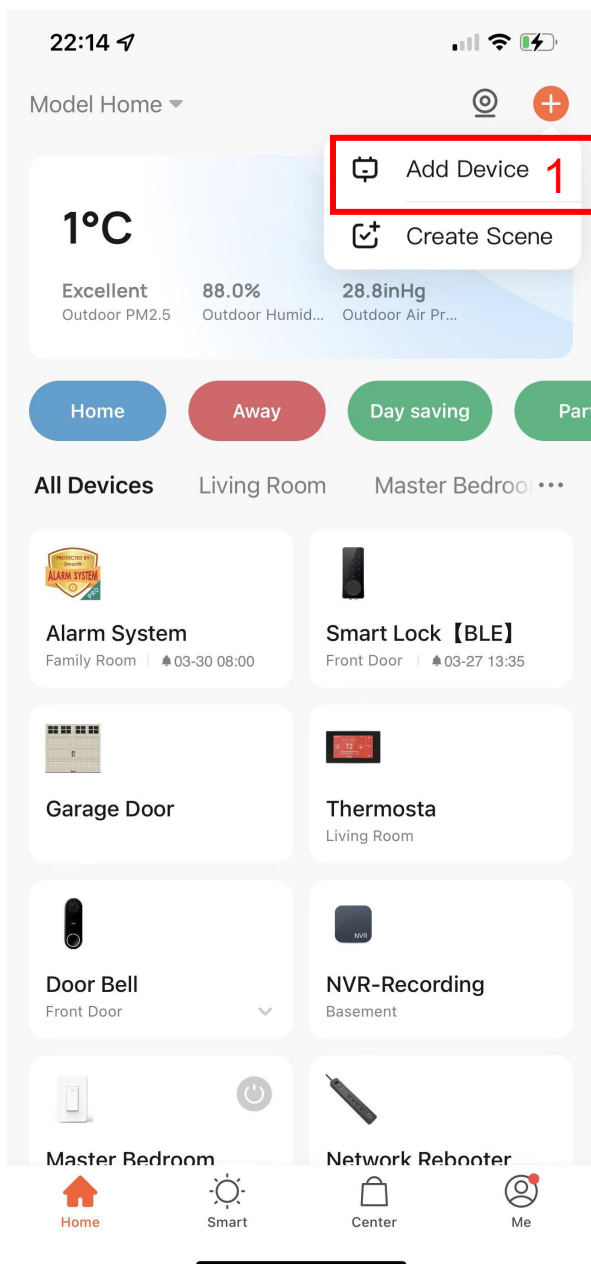

1. Open "MySmarthH" APP, press the '+' in the upper right corner of the main screen;

2. Choose "Pet", click "Pet Fountain".

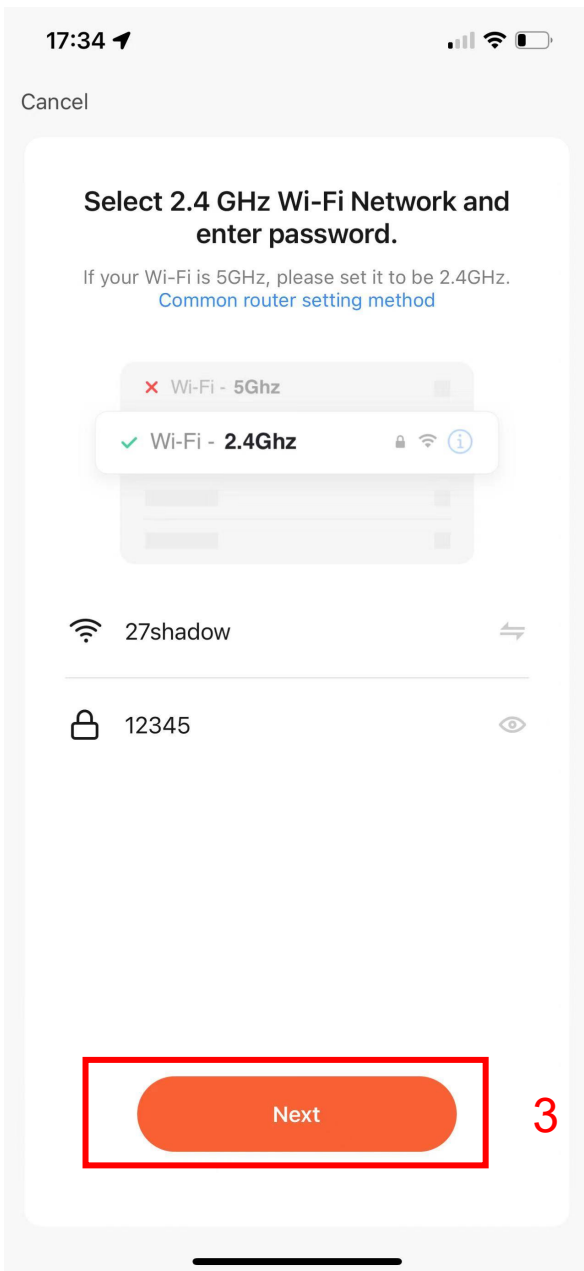

3. Choose WiFi and enter password and Tap “Next”;

4. Tap "AP Mode" in upper right screen;

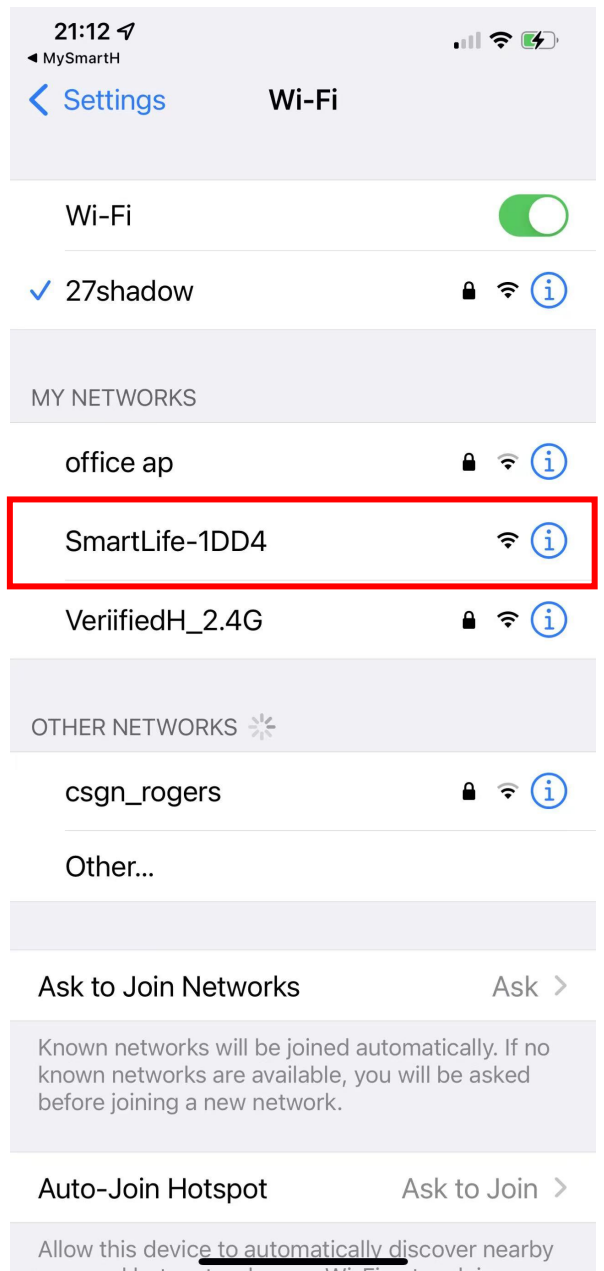
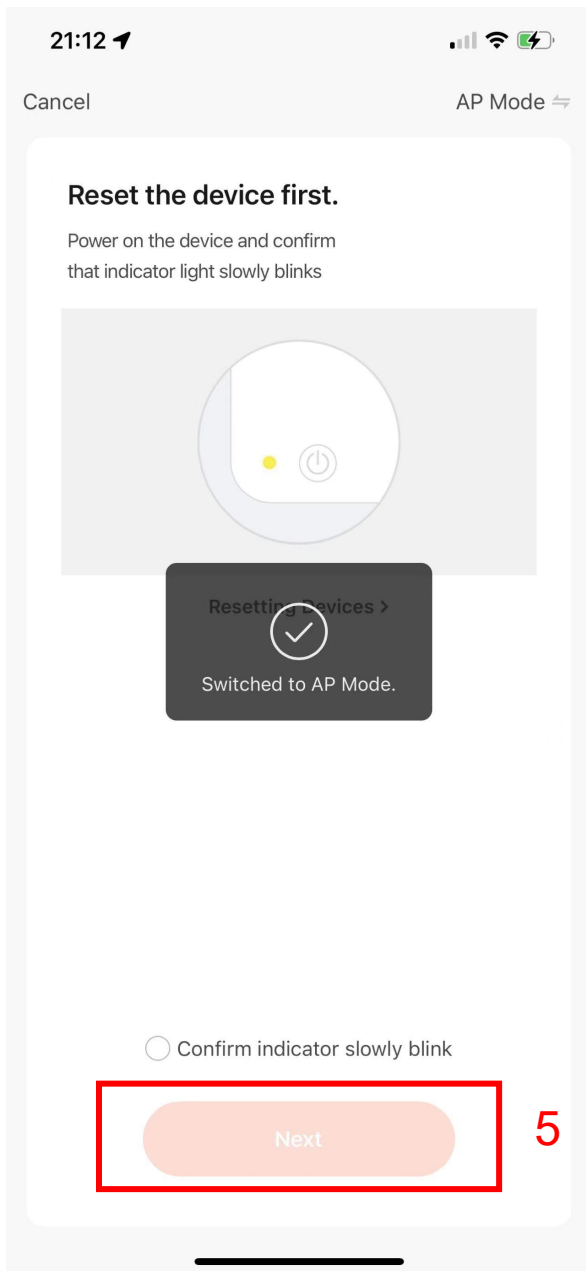

5. Tap "Next";

6. Click "SmartLife-1DD4";

In AP mode, on the Wi-Fi setting page of the mobile phone, find the Wi-Fi hotspot starting with SmartLife.

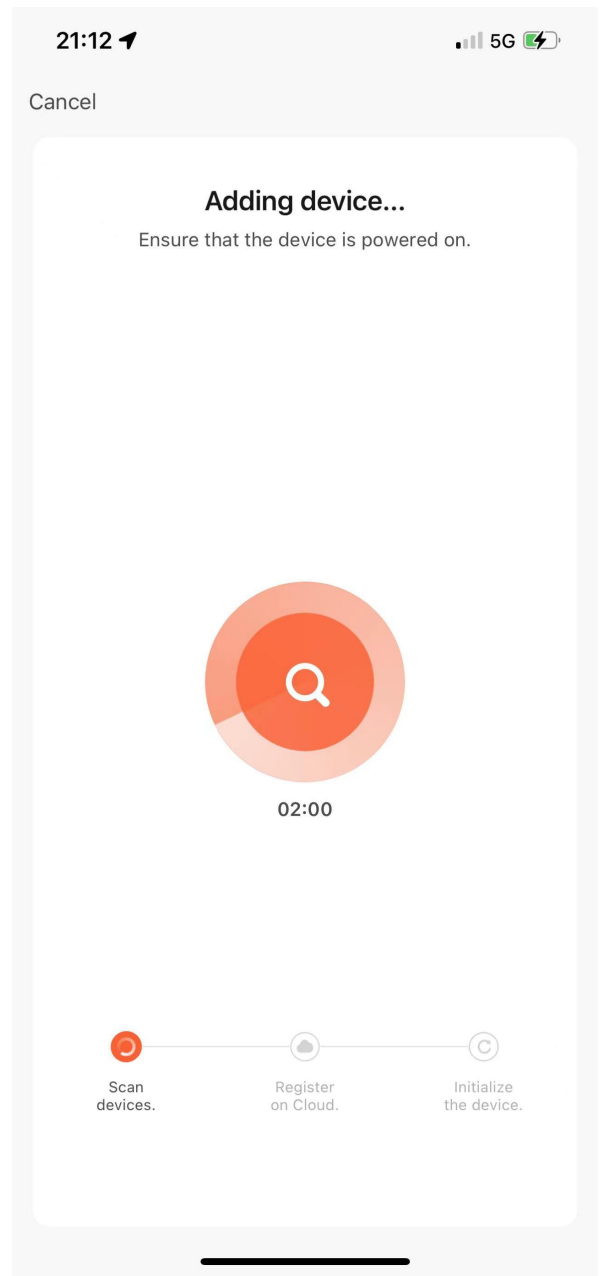

7. Tap the Wi-Fi hotspot to connect the mobile phone to it.

8. After a successful connection, go back to the app to start pairing.

The device pairing page on the app appears again and the pairing process continues.

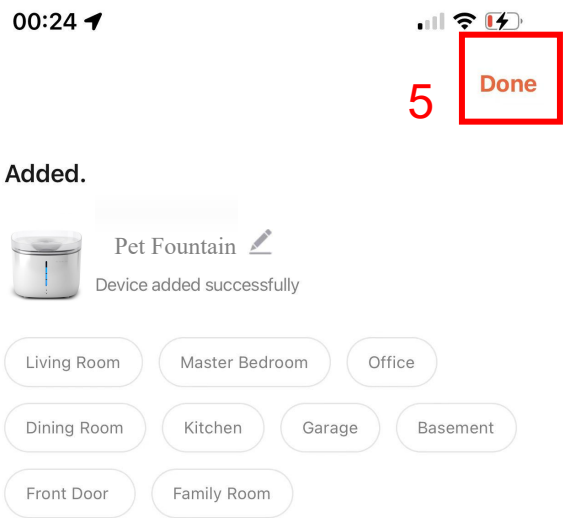
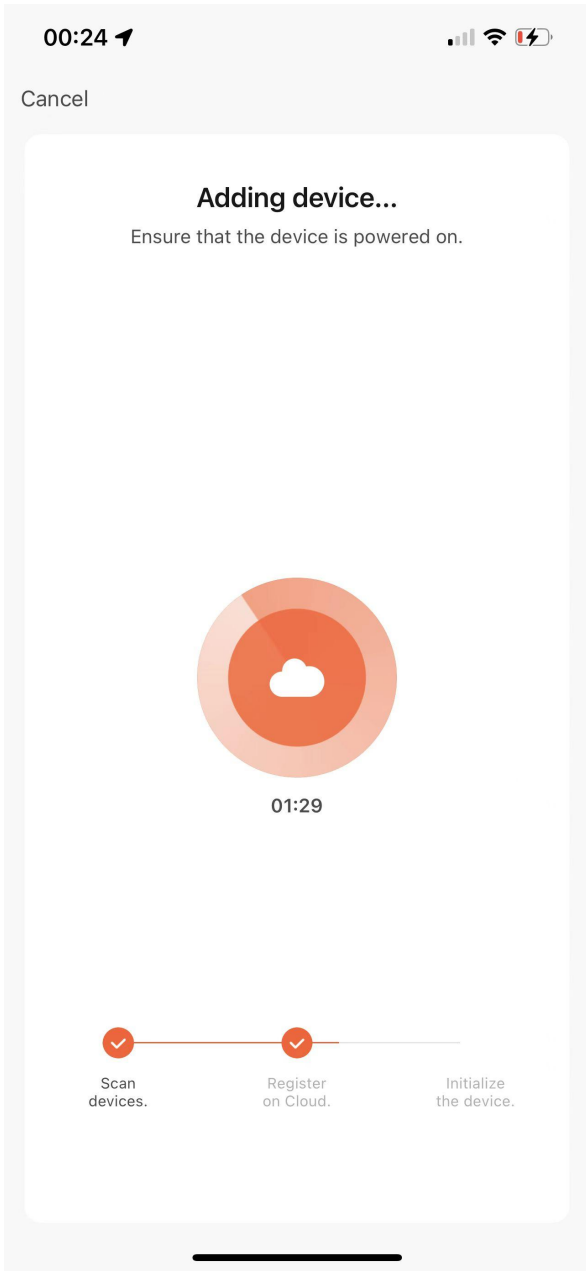

5. Tap "Done";