

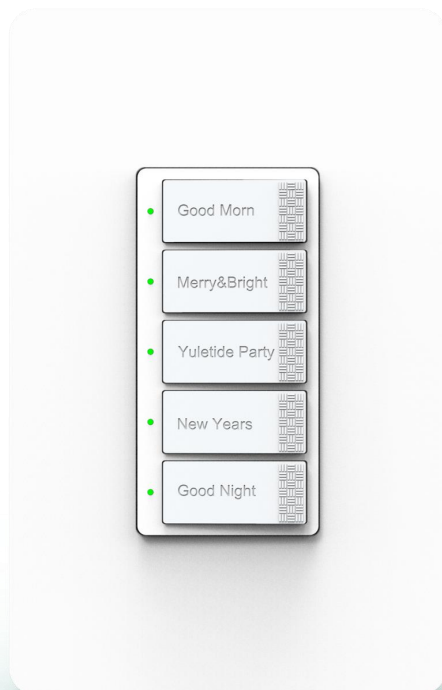

Hello, Smart Home



ENERGY SAVING



Smart Automation Switch User Guide

Notes Before Installation

1. Wi-Fi Only support a 2.4GHz network (IEEE802.11 b/g/n)
2. Neutral wire Required.
3. basic electrical wiring knowledge or experience required , or please consult a professional electrician
4. ON/OFF Button also can be used as reset button, long press to reset your smart switch to factory defaults. Only do this if you are sure you want to erase all your settings
5. Applicable only to control lamps, not recommended as other electrical breakers

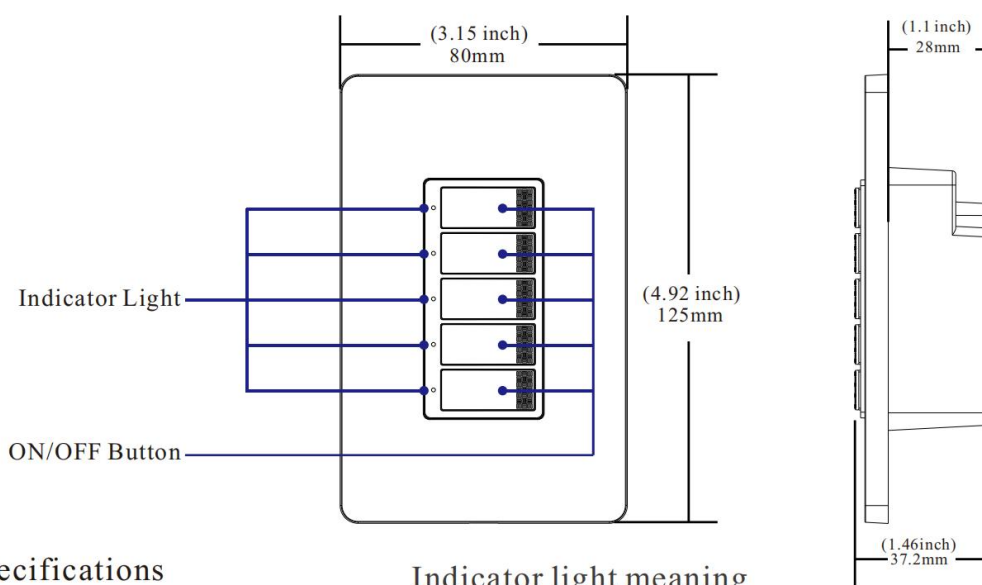

Specifications

Type	Automation Switch
Model	S04
Power supply mode	Neutral+Live Wire
Rated Voltage	AC120V 60Hz
Wireless Frequency	2.4GHz
Wireless Standard	IEEE802.11 b/g/n
Product Size	125*80*37.2MM

Indicator light meaning

Colour	Status	Description
Red	Rapidly Blinks	Ready for connection (Default Mode Only)
Red	Keep the light on	Connected the network
Red	Red light turns off after 3 seconds	Scene mode execution
Red	Flash Slowly	No Internet

Wiring Instructions

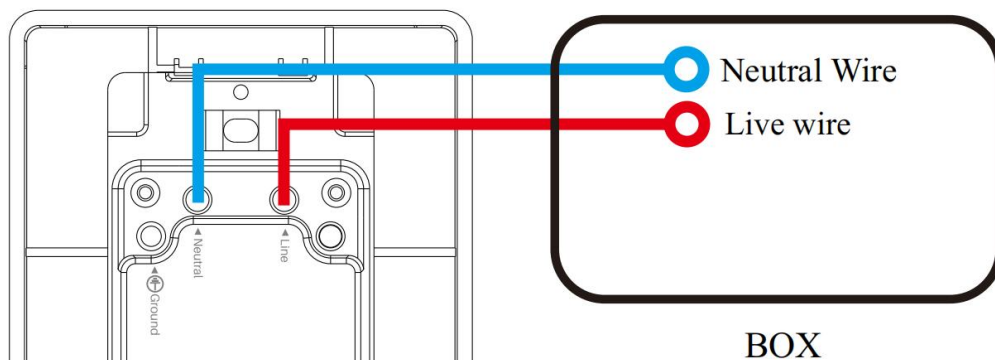

Safety Notice:

- Cut off the power before installation
- A neutral wire is needed to power the switch.

2

Installation Guide

Step 1.

Turn off circuit breaker

Find your light's control in your circuit breaker and turn it off, Then make sure the power is off by flipping your switch a few times.

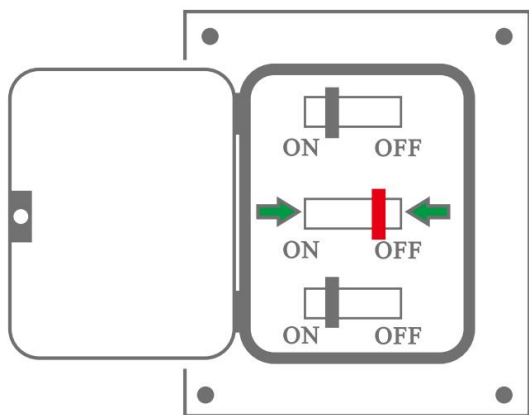

Step 2.

Find the neutral wire

In the wall cassette . look for one or more white wires secured with a wire nut. Do you have a neutral wire?

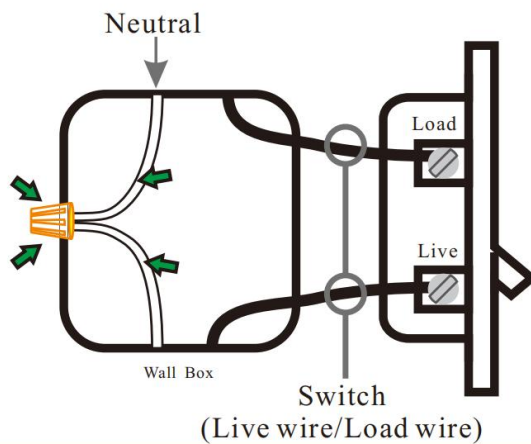

If you can't find neutral wire

Please change another wall cassette. to find a neutral wire,if you really can't find out a neutral wire in your wall cassette. please contact professional electrician to help you.

3

Step 3.

Label your wires

Mark or record the corresponding line before removing the old switch

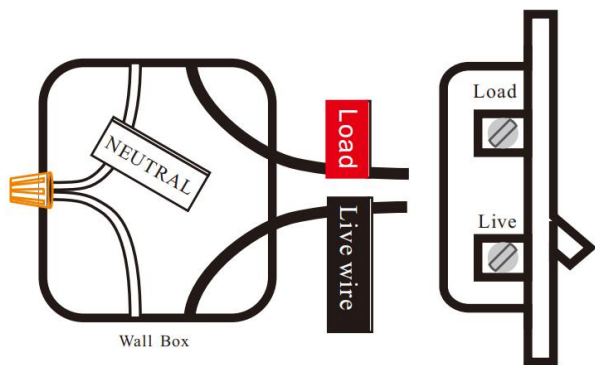

Step 4.

Install switch

Use wire-nuts to connect the switch wires to your home wires, following the diagram. Be careful to match line and load wires. Then remove the stickers, screw the switch into the wall. And attach the faceplate.

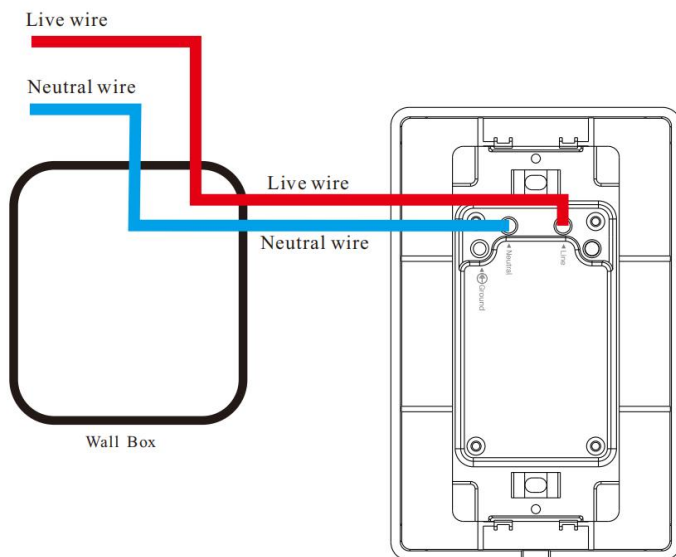

4

Step 5.

Turn on circuit breaker

Turn on your switch's power from the circuit breaker. Press the switch a few times to make sure it works.

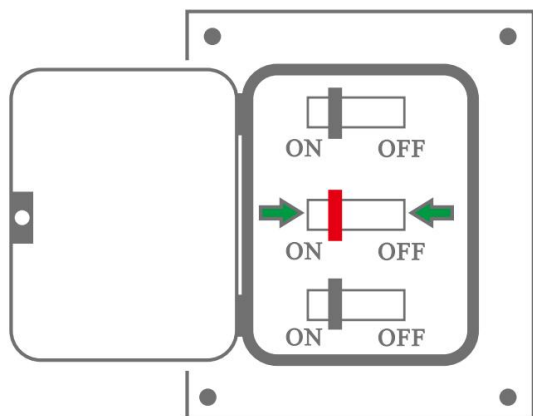

Step 6.

Check the Wi-Fi light

Tap NEXT when the Wi-Fi indicator light blinks

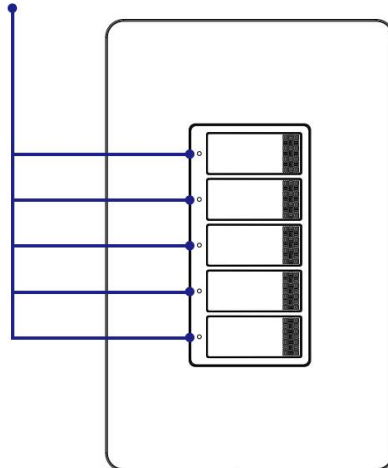

Indicator light rapidly blinks (2 times per second)

Please install the switch, close the glass cover and power on, the touch function will take effect in 10 seconds

5

1. Set Up Router

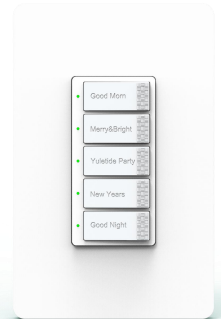
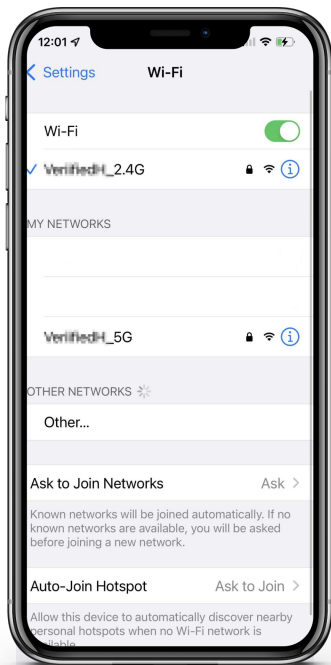

Please keep network available

2.4GHz

5GHz



The router supports the 2.4GHz WiFi (doesn't support the 5GHz), and is connected to the WiFi network. Please set the parameters of the router before connecting the WiFi network, and record the SSID and password of your WiFi.

2. Turn On Your Smartphone's Bluetooth



Turn on your smartphone's Bluetooth.

Install the “MySmarth” APP

Step A : Find out “MySmarth” app in Apple app store, Google Play, or scan the QR code bellow and install it.



The free app”MySmarthH” is compatible with mobile devices the support IOS8.0 above, Android 4.4 above

Step B : Enter the register interface, input the email address/phone number for getting the verification code to register an account. Please just login if you already have a MySmarth account.

6

Step C: Add the switch to MySmarth APP

Note: This smart switch can only support 2.4G network and cannot work with 5.0G network. please check if your home network is 2.4G and make sure that your phone has been connected to your WI-FI home network

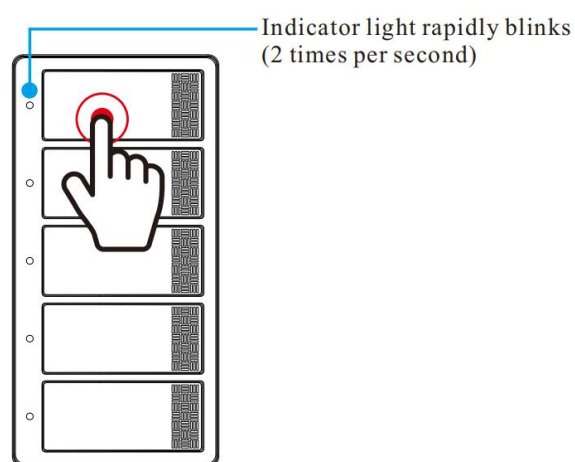

Step.1 After powering on, press and hold the ON/OFF button for 5-7 seconds, and the indicator light flashes quickly

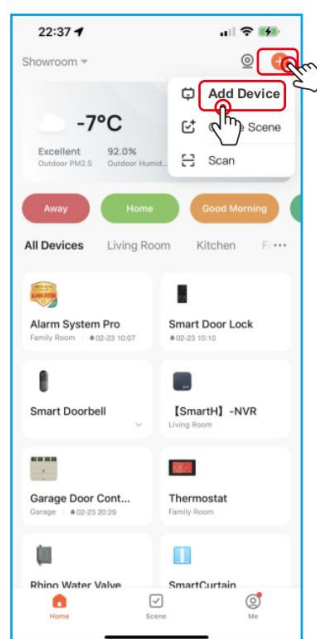

(1) Tap”+” button on top right corner to add device.

7

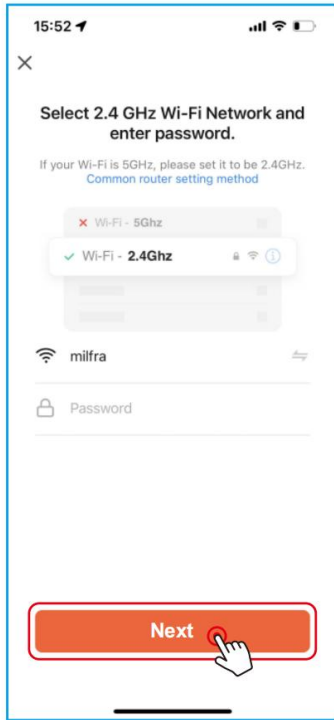

Step.2
Enter Wi-Fi password to join your network

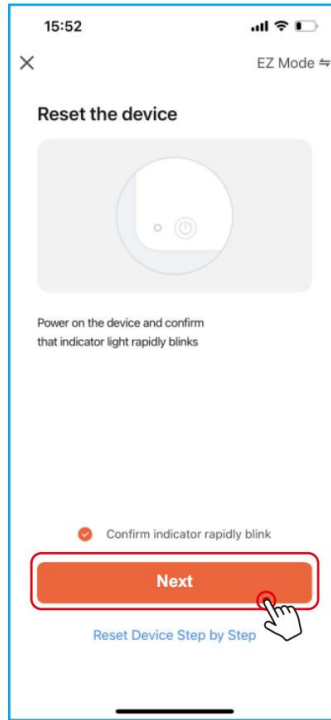

Step.3
Next

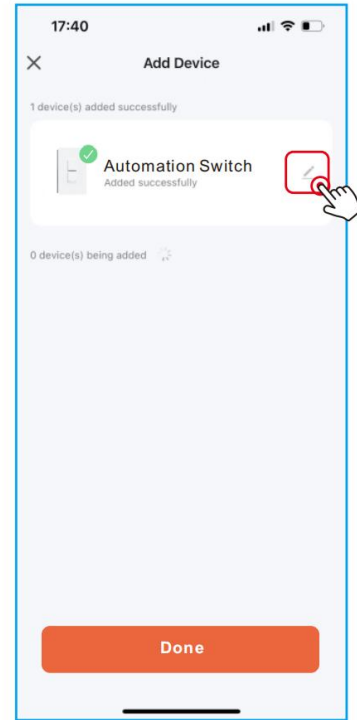

Step.4
Device added successfully you can modify device name.

Step D: Give a name to the switch and tap "Completed". you will find the device you've named is shown on the app home page. Tap the device to enter the setting page.

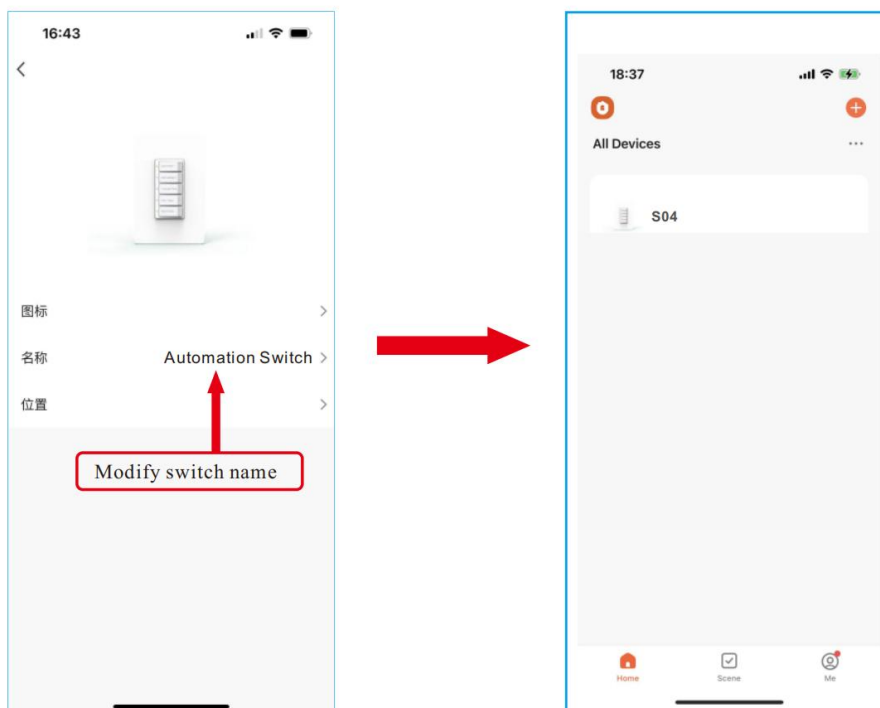

After completing Part Two, you can now control the switch with MySmarth APP on this setting page.

