



# Hello, Smart Home



# ENERGY SAVING



# Smart Receptacle User Guide

## Notes Before Installation

1. Wi-Fi Only support a 2.4GHz network (802.11 b/g/n)
2. Basic electrical wiring knowledge or experience required , or please consult a professional electrician
3. Do not access more than the maximum power of the device design
4. ON/OFF Button also can be used as reset button, long press to reset your smart socket to factory defaults. Only do this if you are sure you want to erase all your settings

## Specifications

Type	Smart Receptacle
Model	604S
Power supply mode	Neutral+Live Wire
Rated Current	15A(Max)
Rated Voltage	AC110-125V~50/60Hz
Load Power	Single 1500W Total 2500W Inductive Load<2000W
USB Output	5V/2.1A
Wireless Frequency	2.4GHz
Wireless Standard	IEEE802.11 b/g/n

## Indicator light meaning

Indicator	Status	Description
Green	Rapidly blinks	Ready for connection (Default Mode Only)
Green	Slowly blinks (1 time every 3 S)	Ready for connection (AP Mode Only)
Red light is Off	Off	Turn the light off
Red light is always on	On	Turn the light on
Green	Flash Slowly	No Internet

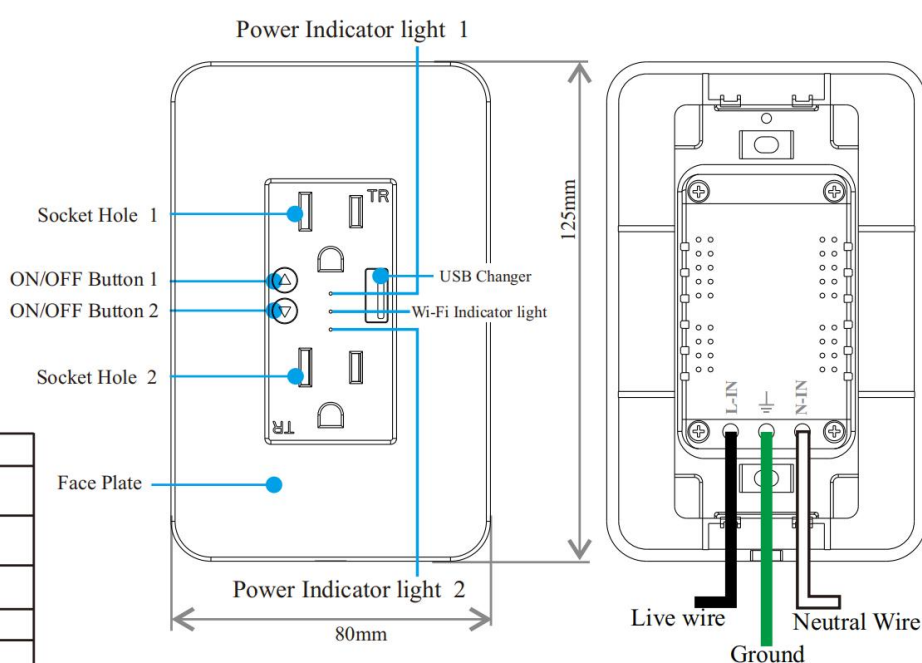

### Safety Notice:



- Cut off the power before installation
- Please use it only when it's installed with RCD or current leakage protector at home



## Installation Guide

### STEP.1

Turn off circuit breaker

Find your socket's control in your circuit breaker and turn it off, ensure the socket power off completely.

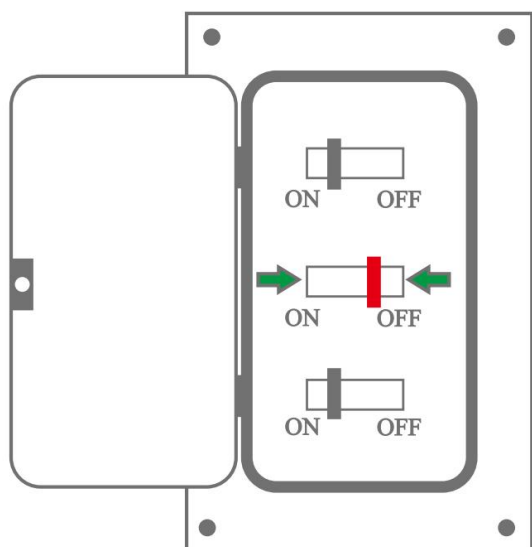

### STEP.2

Remove the original socket

In the wall cassette, find the neutral wire, line wire, and ground wire.

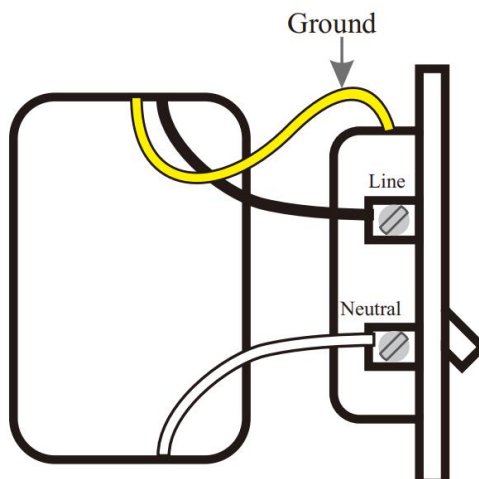

**!** If your original socket is also two jacks, you may find 4 or 5 wires. Please find the neutral wires, Line wires, and ground wires. This smart socket only needs to use the neutral wires, Line wires, and ground wires; other lines do not need to be connected.

2

### STEP.3

Label your wires

Mark or record the corresponding line before removing the old socket

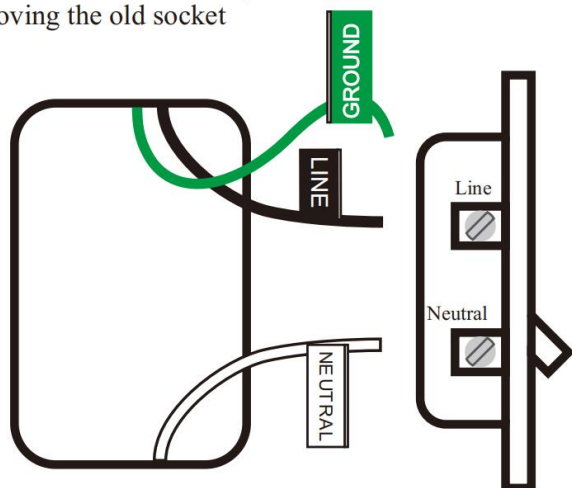

Usually:  
 White represents the neutral line  
 Black represents the fire line  
 Green or yellow or a single bare copper wire representing the ground wire

The above is for reference only and cannot be used as a standard.

### STEP.4

Install socket

Use wire-nuts to connect the socket wires to your home wires, following the diagram. Be careful to match line. Then remove the stickers, screw the socket into the wall. And attach the faceplate.

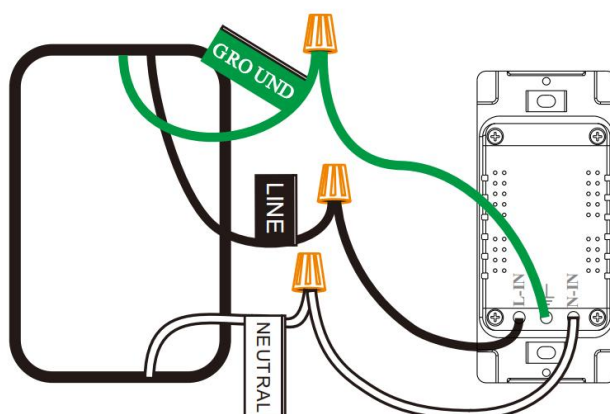

**!** For safety, please connect the ground wire

3

**STEP.5**

**Turn on circuit breaker**

Turn on your socket’s power from the circuit breaker. Press the socket a few times to make sure it works.

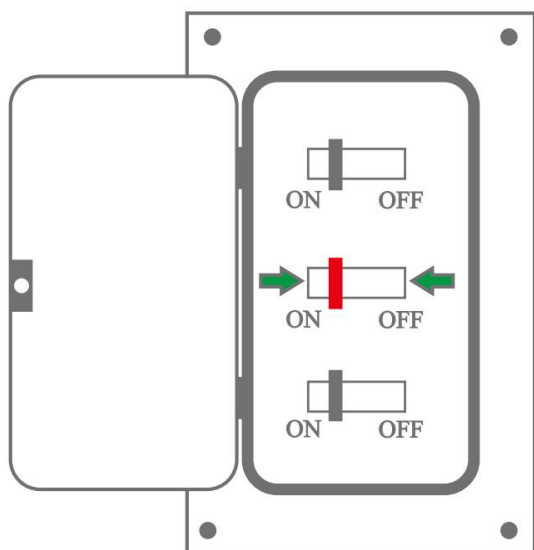

**STEP.6**

**Check the Wi-Fi light**

Tap NEXT when the Wi-Fi indicator light blinks

Indicator light rapidly blinks (2 times per second)

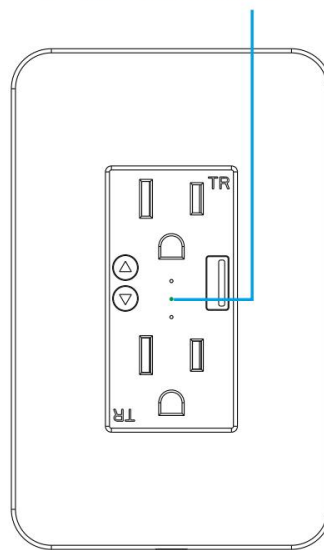

**Install the “MySmarth”APP**

**Step A** .Find out “MySmarth”app in Apple app store, Google Play, or scan the QR code below and install it.



The free app”MySmarth” is compatible with mobile devices the support IOS8.0 above, Android 4.4 above

**Step B** .Enter the register interface, input the email address/phone number for getting the verification code to register an account. Please just login if you already have a MySmarth account.

# 1. Set Up Router

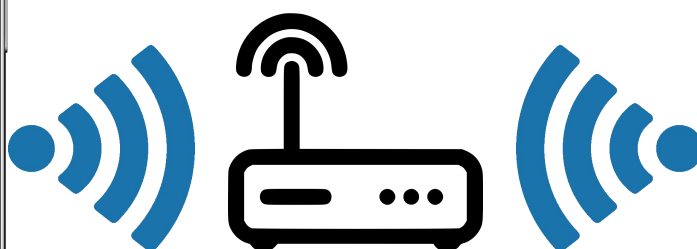
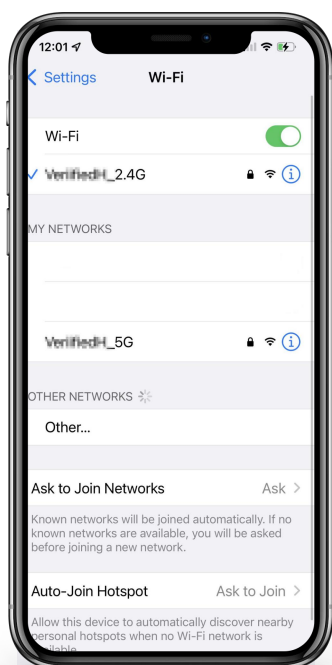

Please keep network available

2.4GHz

5GHz



The router supports the 2.4GHz WiFi (doesn't support the 5GHz), and is connected to the WiFi network. Please set the parameters of the router before connecting the WiFi network, and record the SSID and password of your WiFi.

# 2. Turn On Your Smartphone's Bluetooth

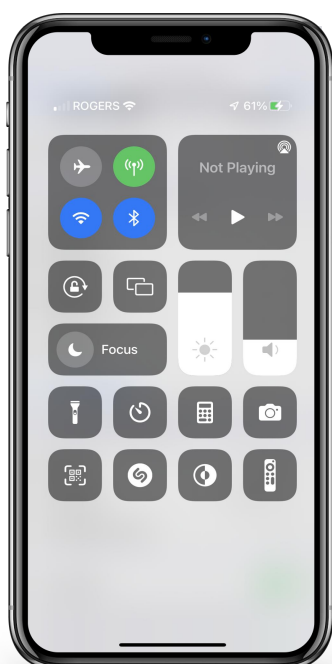

Turn on your smartphone's Bluetooth.

**Step C:**Add the switch to MySmARTH APP

Note: This smart switch can only support 2.4G network and cannot work with 5.0G network. please check if your home network is 2.4G and make sure that your phone has been connected to your WI-FI home network

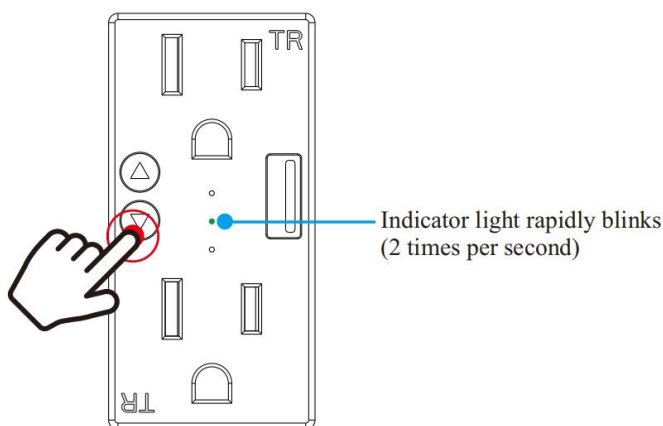

**Step.1.**After powering on, press and hold the ON/OFF button for 5-7 seconds, and the indicator light flashes quickly

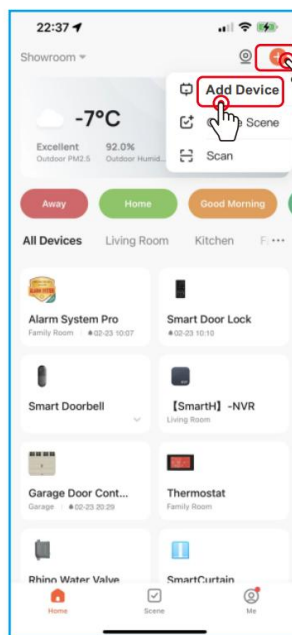

(1)Tap”+” button on top right corner to add device.

6

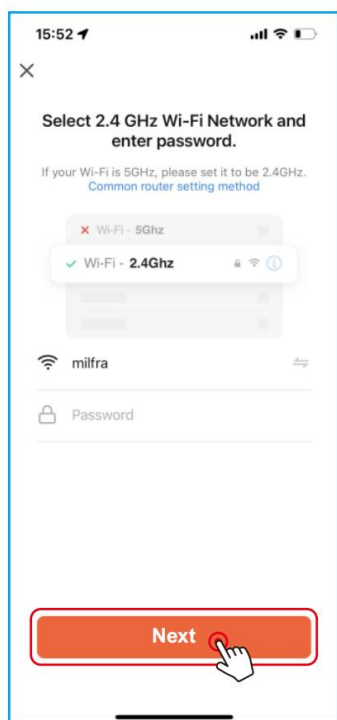

**Step.2**  
Enter Wi-Fi password to join your network

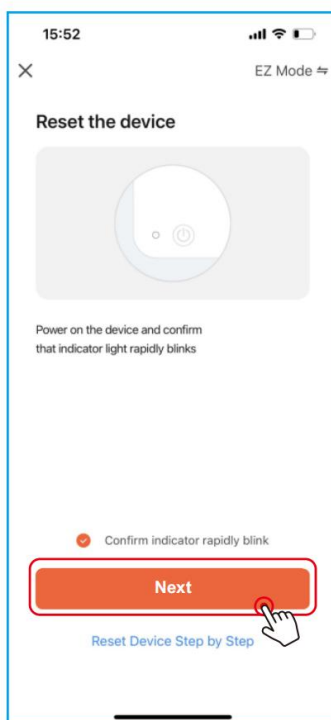

**Step.3**  
Next

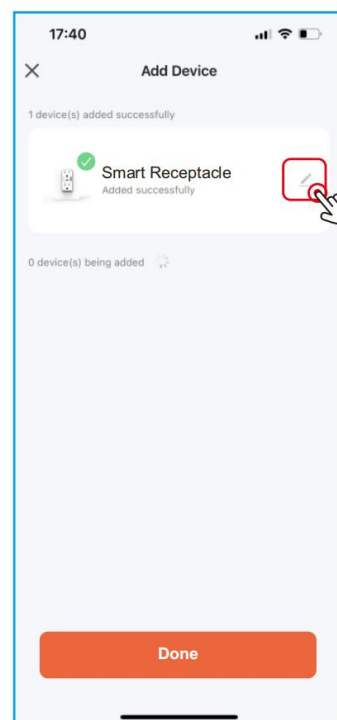

**Step.4**  
Device added successfully you can modify device name.

7

**Step D:** Give a name to the switch and tap "Completed". you will find the device you've named is shown on the app home page. Tap the device to enter the setting page.

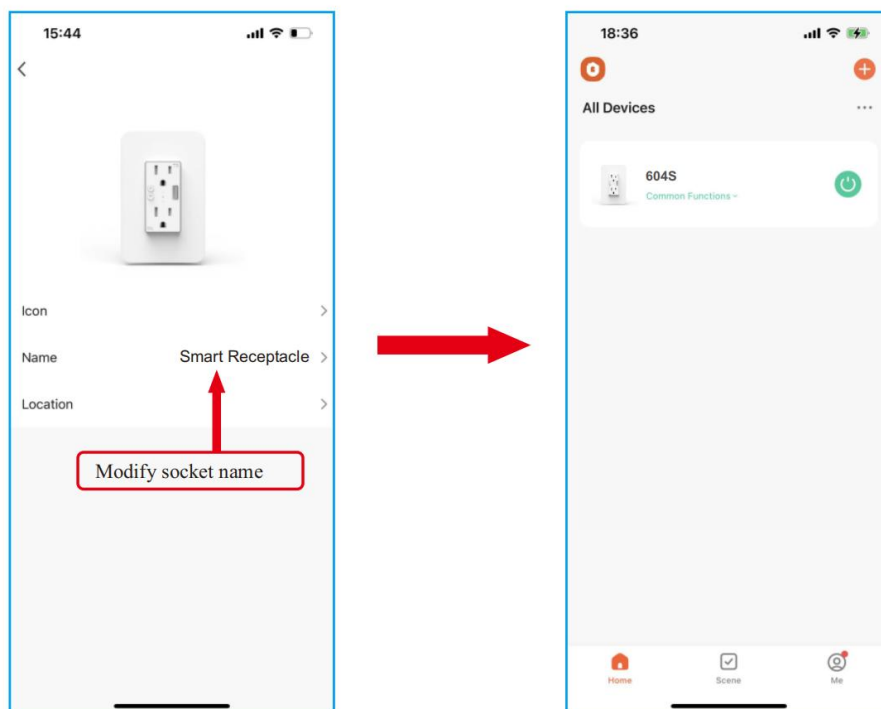

8

After completing Part Two, you can now control the switch with MySmartH APP on this setting page.

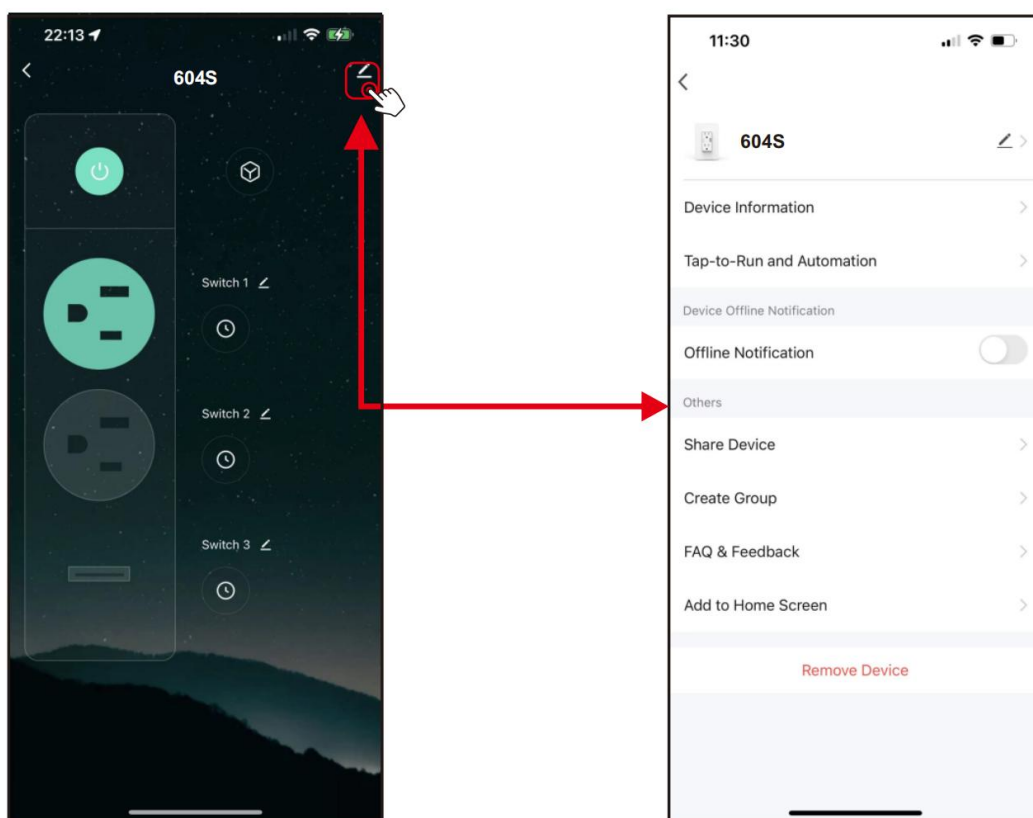

9

