







COMPONENTS

A	STEEL GROUND ANCHOR	x2	
B	NYLON REAR GROUND ANCHOR	x2	
C	M10 SOCKET DOME SCREW AND HEX DOME NUT - 80mm LONG	x6	
D	M8 DOME HEAD NUT AND HEX SCREW	x4	
E	GROUND PEG	x35	
F	NYLON STANCHION ELBOW	x2	
FXB	SLOT NET FIXINGS	x35	
AK	HEX KEY FOR COMPONENT C	x1	
NET	GOAL NET 21' x 7'	x1	

POST SECTIONS

Aluminium Sections and Tubes

I	LEFT CROSSBAR SECTION	x1	
J	CENTRE CROSSBAR SECTION	x1	
K	RIGHT CROSSBAR SECTION	x1	
L	UPRIGHT SECTIONS	x2	
M	TOP STANCHION TUBE	x2	
N	BACK STANCHION TUBE	x2	

80mm ALUMINIUM PORTABLE

21' X 7' GRASS-SURFACE FITTING INSTRUCTIONS

(21' x 7' Grass-Surface) - Three section crossbar version.

FITTING GOALPOST SLOT NET FIXINGS

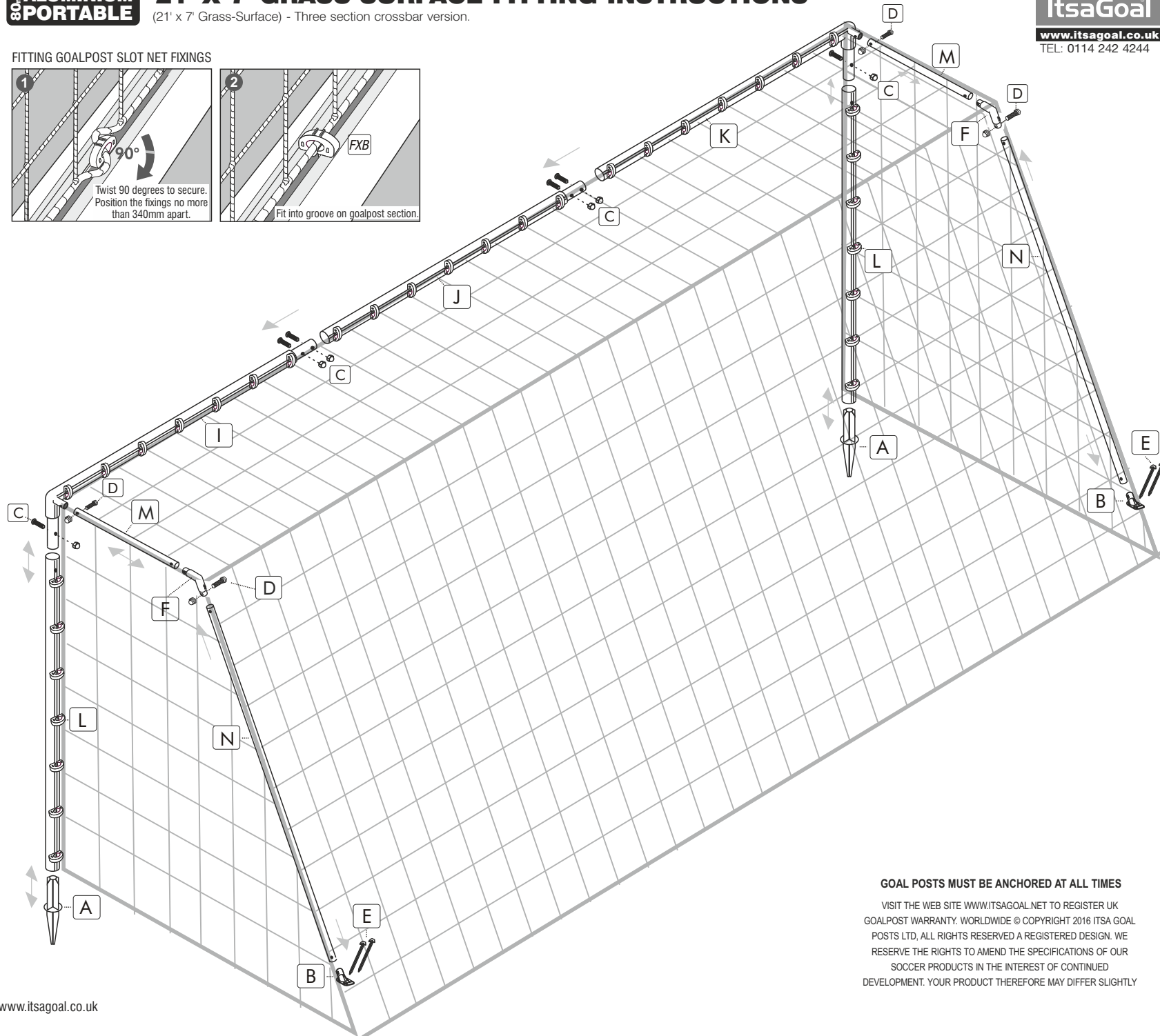
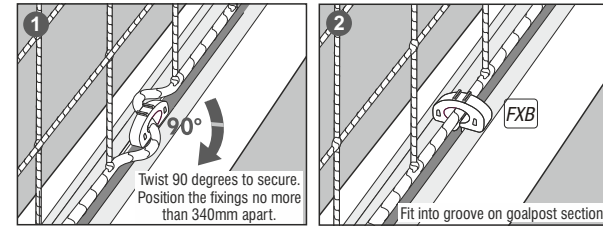

tsaGoal

www.itsagoal.co.uk
TEL: 0114 242 4244



Visit our YouTube site for assembly videos :
www.youtube.com/user/Footballgoalposts

Goalpost spare parts and replacement nets are available at - www.itsagoal.co.uk

GOAL POSTS MUST BE ANCHORED AT ALL TIMES

VISIT THE WEB SITE WWW.ITSAGOAL.NET TO REGISTER UK GOALPOST WARRANTY. WORLDWIDE © COPYRIGHT 2016 ITSA GOAL POSTS LTD. ALL RIGHTS RESERVED A REGISTERED DESIGN. WE RESERVE THE RIGHTS TO AMEND THE SPECIFICATIONS OF OUR SOCCER PRODUCTS IN THE INTEREST OF CONTINUED DEVELOPMENT. YOUR PRODUCT THEREFORE MAY DIFFER SLIGHTLY

STEP BY STEP FITTING

STEP 1:
CONNECT CROSSBAR SECTIONS (I,J&K)WITH NUT AND BOLTS (C) AND INSERT UPRIGHTS (L) AND BOLT TOGETHER.

FITTING GOALPOST SLOT NET FIXINGS

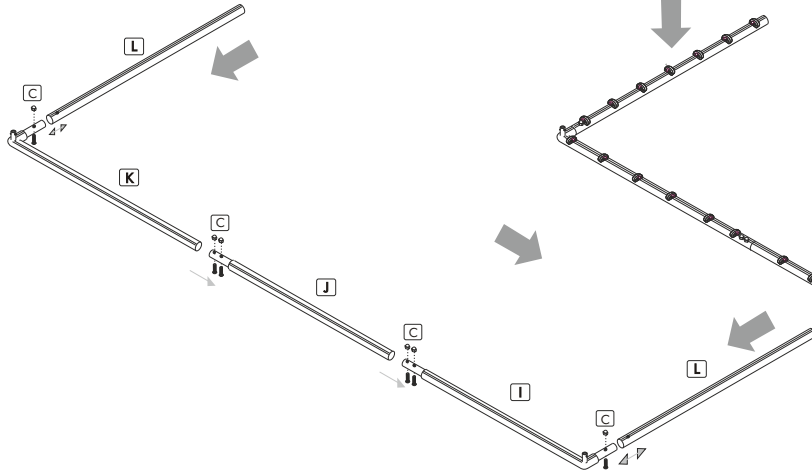
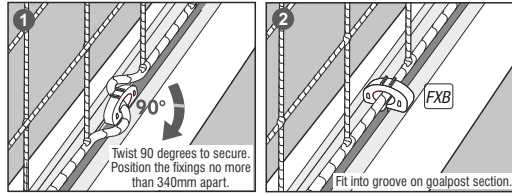

STEP 5:
LIFT THE GOAL POST WITH TWO PEOPLE AND SLIDE ONTO THE METAL GROUND ANCHORS (A). DO NOT

INSERT THE BACK STANCHION TUBES INTO THE STANCHIONS ELBOWS, ENSURE THE BACK TUBES ARE INLINE WITH THE UPRIGHT POSTS, THEN PEG THE REAR GROUND ANCHORS ONTO THE GRASS.

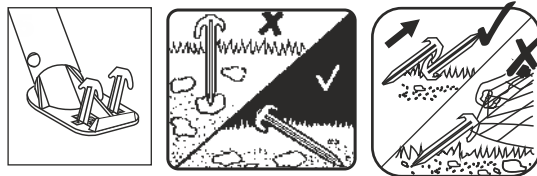
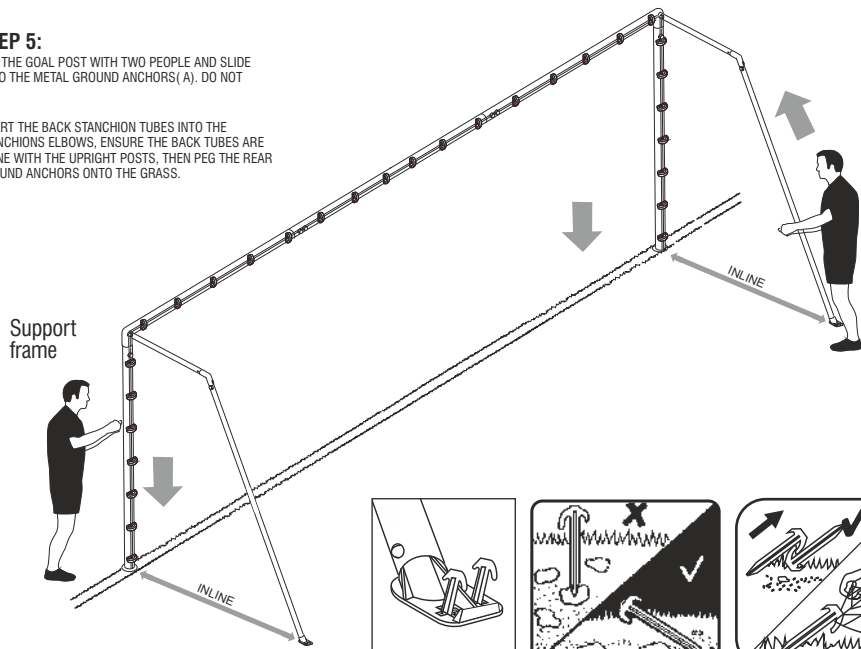

TO AVOID DAMAGE TO NETS - DO NOT REMOVE PEGS BY PULLING FROM GROUND WITH BOTTOM OF THE NET. REMOVE THE PEGS AS SHOWN USING ANOTHER PEG.

STEEL GROUND ANCHORS

HAMMER FULL DOWN INTO THE GROUND

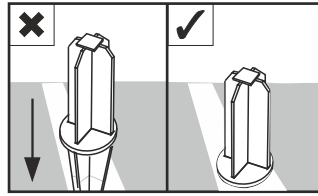

STEP 2:
INSERT TWIST AND LOCK NET FIXINGS (FXB). FITTINGS THEY CAN BE LEFT IN POSITION.

STEP 3:
LAY THE CROSSBAR ON THE GOAL LINE. FIT THE TOP TUBES (M) INTO THE CORNERS, BOLT WITH (D), FIT THE ELBOW (F)

STEP 4
INSERT THE GROUND ANCHORS AT THE CORRECT DISTANCE APART.

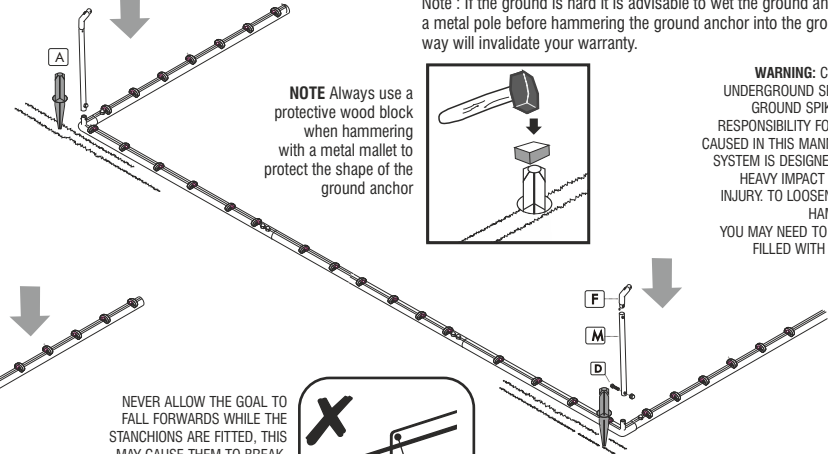

1. Make sure the Steel Ground Anchor is In line square with the posts and hammer fully into the ground.
2. To remove from ground tap lightly and wiggle left to right and lift up. This should leave the ground undisturbed.

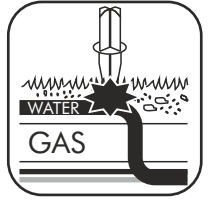
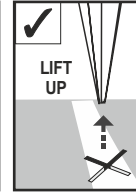
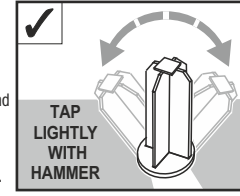

Note : If the ground is hard it is advisable to wet the ground and make a starting hole with a metal pole before hammering the ground anchor into the ground. Damage cause in this way will invalidate your warranty.

NOTE Always use a protective wood block when hammering with a metal mallet to protect the shape of the ground anchor

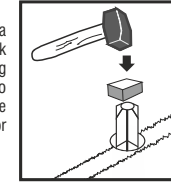

WARNING: CHECK THE POSITION OF ANY UNDERGROUND SERVICES BEFORE USING THE GROUND SPIKES AND PEGS. WE TAKE NO RESPONSIBILITY FOR ANY DAMAGE OR INJURY CAUSED IN THIS MANNER. OUR GROUND ANCHOR SYSTEM IS DESIGNED TO GIVE SLIGHTLY UNDER HEAVY IMPACT TO HELP PREVENT SERIOUS INJURY. TO LOOSEN TAP SIDES OF SPIKE WITH HAMMER BEFORE EXTRACTING. YOU MAY NEED TO INSTALL GROUND SOCKETS FILLED WITH SAND IF USED IN THE SAME POSITION REGULARLY.

NEVER ALLOW THE GOAL TO FALL FORWARDS WHILE THE STANCHIONS ARE FITTED, THIS MAY CAUSE THEM TO BREAK. WHEN LIFTING OR LOWERING GOAL ENSURE AREA IS CLEAR OF BYSTANDERS TO PREVENT INJURY.

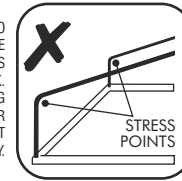

STEP 6
IDEALLY WITH TWO PEOPLE LIFT THE GOAL NET ONTO THE GOAL FRAME AND FIX WITH NET FITTINGS. FIX ALL THE CORNERS FIRST. See over for net fitting. FIT THE NET ALONG THE BACK OF THE GOAL WITH THE RED SAFETY GROUND PEGS - USE A RUBBER MALLETT TO PREVENT DAMAGE TO PEGS.

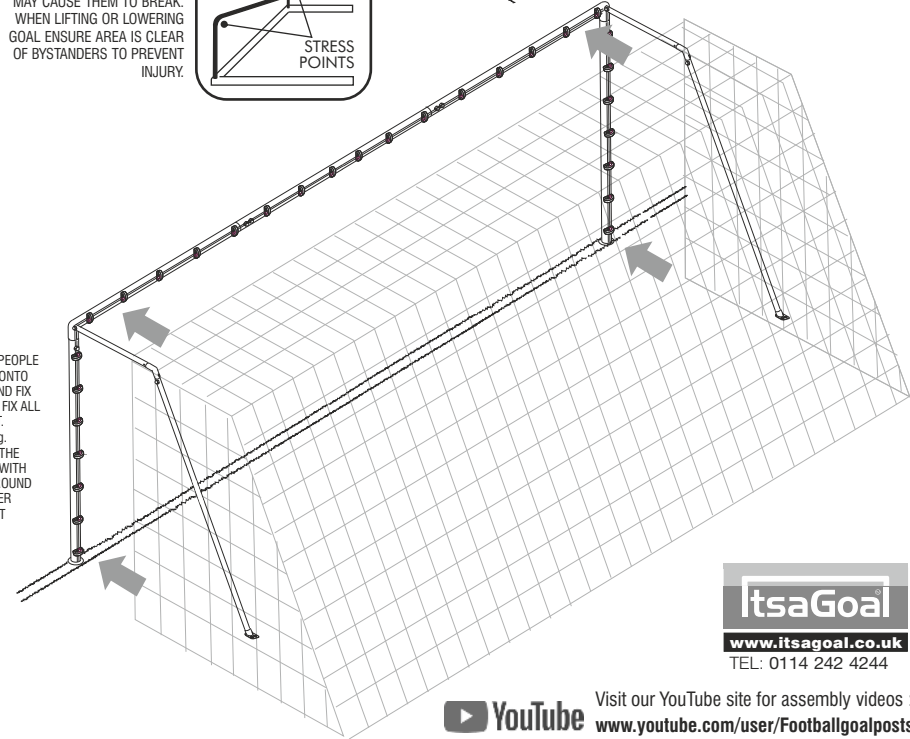

STEP BY STEP NET FITTING

STEP 1

Open net and check the lengths of a and b correspond with the diagram below.

NOTE: If your net does not fit the first time, you may be fitting it to the goal frame upside down i.e. that is to say the net from the crossbar to the floor (a) is longer than the length of the net to the bottom of the upright. (b)

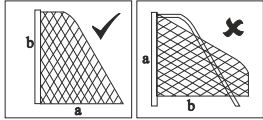

STEP 2

With the net the correct way round lift the net onto the goalpost frame. This is easier with two people.

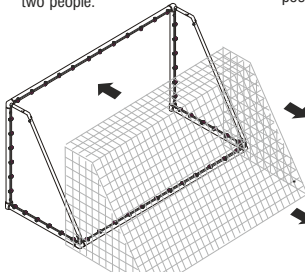

STEP 3

Attach the corners first, where the upright posts meets the crossbar as shown. Then attach the net to the post using the net fixings

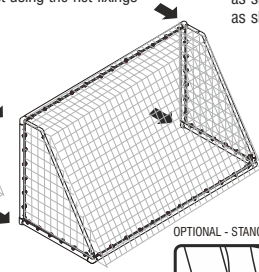

STEP 4

Using the small net ties attach the net down the back of the sloping back net supports (optional) as shown to the posts as shown.

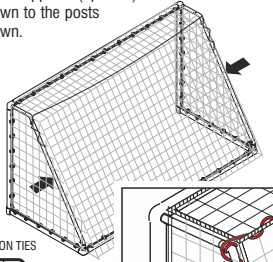

OPTIONAL - STANCHION TIES

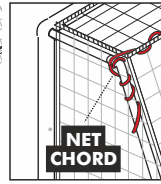
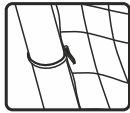

STEP 5

To help define the roof of the net Tie the cord to one side and pull the net chord tight and wrap neatly down and around the stanchion section. If you are regularly attaching or detaching the net then apply coloured tape to the roof corners of net to help identify the roof area.

ANCHORING YOUR GOAL

WARNING: Check the position of any underground services before using the ground anchors and pegs. We take no responsibility for any damage or injury caused in this manner. HARD SURFACES: to prevent damage to goal or its components, loosen soil with a steel pole and moisten with some water before inserting the ground anchors. Do not use the goal in sub zero temperatures. ANCHORING YOUR GOAL ON GRASS - POSITION YOUR GOAL ON A LEVEL PLAYING SURFACE. LARGER PEGS CAN BE PURCHASED FOR USE ON SOFT GROUND OR SAND.

CARE & MAINTENANCE

WE ADVISE ADULT SUPERVISION DURING ASSEMBLY & USE. OBSERVE AND FOLLOW WARNING LABELS ATTACHED TO GOAL. DO NOT USE GOALS WITH ANY DAMAGED OR MISSING COMPONENTS. SPARE PARTS AND REPLACEMENT NETS ARE READILY AVAILABLE TELEPHONE OUR GOAL-LINE 0114 2424244 DAMAGED COMPONENTS REQUESTED UNDER GUARANTEE MUST BE RETURNED FOR INSPECTION. FAILURE TO FOLLOW THE WARNINGS, FITTING INSTRUCTIONS CONTAINED IN THIS DOCUMENT, MAY INVALIDATE YOUR GUARANTEE. NOTE: WHEN USING A BAG PLEASE PACK THE GOAL SECTIONS CAREFULLY INTO THE BAG. THE COMPONENTS ARE DESIGNED TO FIT INTO THE BAG EFFICIENTLY AND THEREFORE. DO NOT UNDER ANY CIRCUMSTANCE THROW THE COMPONENTS INTO THE BAG AND THEN FORCE THE ZIP TO CLOSE AS THIS WILL BREAK THE ZIP FASTENER. BAG MAINTENANCE - SPONGE BAG DOWN WITH HOT SOAPY WATER. ZIP WILL RUN EASIER IF YOU RUB BOTH SIDES OF THE ZIP TRACK WITH CANDLE WAX GROUND ANCHORS - NOTE: ALWAYS ENSURE ALIGNMENT OF GROUND SPIKES IS CORRECT TO ALLOW UPRIGHTS TO EASILY SLIDE OVER TOP OF SPIKE. DO NOT USE FRONT GROUND SPIKES IF THEY BECOME MISSHAPEN OR DAMAGED AS THIS COULD CAUSE DAMAGE TO THE BASE OF UPRIGHT.

CLEANING

AT THE END OF THE SEASON NETS CAN BE TIED INTO A BUNDLE PUT INTO AN OLD PILLOW CASE, AND TIE SHUT (NOT TO DAMAGE WASHING MACHINE) AND WASHED IN A COOL WASH WITH NORMAL WASHING POWDER. THE GOAL FRAME CAN BE WASHED WITH HOT SOAPY WATER. ANY SCUFF MARKS CAN BE RUBBED OFF WITH A LIGHT ABRASIVE SCOURING PAD.

WARNING

THE GOAL IS DESIGNED FOR ASSOCIATION FOOTBALL (SOCCER) ONLY AND NO OTHER PURPOSE. CHECK ALL FITTINGS ARE FULLY SECURED BEFORE USE AND CHECKED PERIODICALLY. ENSURE THAT THE UPRIGHTS AND BACK STANCHIONS ARE STRAIGHT AND PROPERLY ALIGNED BEFORE FITTING THE NET WHEN LIFTING OR LOWERING GOAL ENSURE AREA IS CLEAR OF BYSTANDERS TO PREVENT INJURY. IT IS ADVISABLE IN EXTREME WINDY CONDITIONS TO DISMANTLE THE GOAL AND STORE AWAY. WHEN DISMANTLING THE GOAL ENSURE THAT ALL FITTINGS ARE PACKED AWAY AND THAT NOTHING IS LEFT ON THE PLAYING SURFACE. DO NOT USE DAMAGED NETS. NEVER USE GOALS WITHOUT SECURING BOLTS. GOALS MUST NEVER BE LEFT UP OR USED UNLESS THEY ARE PROPERLY FITTED WITH GROUND SPIKES AND ANCHORS WITH NET ATTACHED AND SECURELY PEGGED DOWN. DO NOT AT ANY TIME USE YOUR GOAL WITHOUT GROUND ANCHORS. DO NOT CLIMB ON THE NET OR GOAL FRAME. DO NOT DROP ANY HEAVY OBJECTS ON ENDS OF TUBES. NO LIABILITY IS ACCEPTED WHATSOEVER BY THE COMPANY ITS EMPLOYEES OR AGENTS FOR DAMAGED LOSS OR INJURY CAUSED BY NEGLIGENCE OR MISUSE. IT IS ADVISABLE IN ANY CONTACT SPORT TO TAKE OUT THE RELEVANT INSURANCE'S TO COVER AGAINST INJURY BOTH FROM TAKING PART, EQUIPMENT AND OTHER UNFORESEABLE CIRCUMSTANCES.

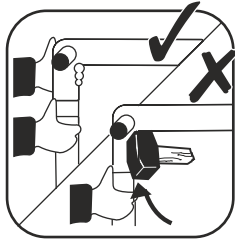

NEVER STRIKE THE POSTS WITH A HAMMER OR SOLID OBJECT. ALWAYS PRISE APART OR LIGHTLY TAP THE CORNER SECTIONS WITH A RUBBER MALLLET. MAKE SURE POSTS AND CORNERS ARE IN LINE DURING ASSEMBLY AND DISASSEMBLY.

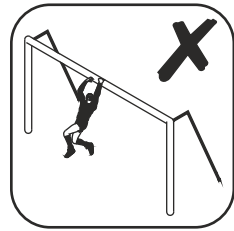

DO NOT SWING ON CROSSBARS CROSSBARS WILL NOT BE REPLACED WITHIN THE GUARANTEE PERIOD IF BROKEN BY SWINGING OR CLIMBING OR ANY OTHER MISUSE.

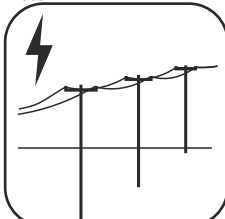

WARNING: DO NOT TOUCH OVERHEAD SERVICES WITH GOALPOST SECTIONS. CHECK THE POSITION OF ANY OVERHEAD SERVICES WHEN SETTING UP OR DISMANTLING THE GOALS, EG. POWER LINES, TELEPHONE CABELS ETC.

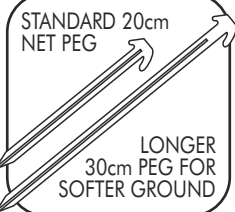
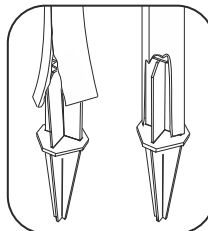

WARNING: WE RECOMMEND A RISK ASSESSMENT OF SOIL CONDITIONS. EG. FOR SOFT, VERY WET OR SANDY GROUND WE STRONGLY RECOMMEND OUR LONGER 300MM NET PEG IS USED (AVAILABLE SEPARATELY). FREESTANDING GOALS WITH COUNTER BALANCE WEIGHTS MAY BE MORE SUITABLE FOR EXTREME GROUND CONDITIONS.

DO NOT at anytime misuse or throw the metal spikes. If the metal spikes become worn or misshapen then they should be replaced as they can damage the upright sections. NEVER use the goals without the ground anchor system. In severe weather conditions it is advisable to take your goal down as Damage is not covered by the guarantee in such circumstances.

Goalpost Slot Net Fixing

A net fixing that works on most aluminum goalposts that have a slot on the rear of the posts. This net fixing can be left in place in the slot on the goal extrusion or can be twisted out and left attached in position on the net.

To attached the net turn the net fixing upside down and lay it into the slot with the opening facing up. Do this with goal post extrusion laid on the ground. The two lugs on the top of the fixing will hold the fixing clip firmly in the goalpost slot upside down to enable the net to be pushed through the opening on the back of the fixing.

This is a unique design feature that makes it easier to insert the net inside the fixing compared to other similar types of net fittings. Much easier to fit than other similar net fittings.

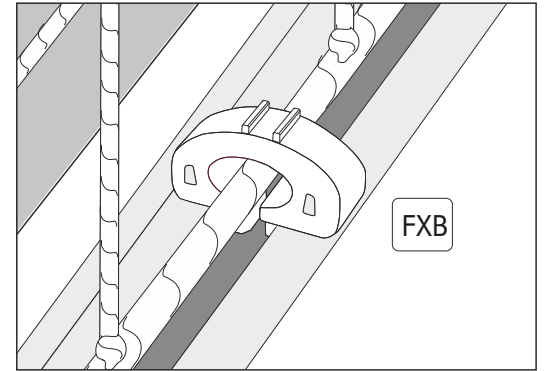

Fitting Instructions

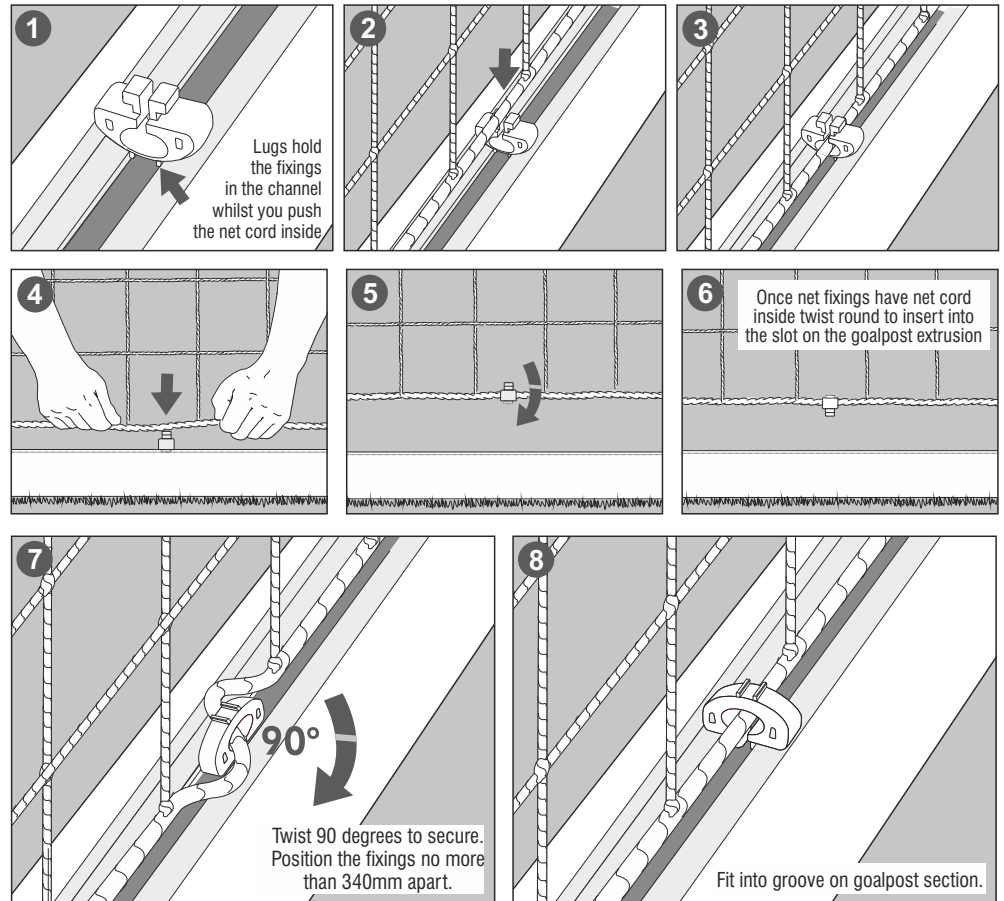

MADE IN ENGLAND www.itsagoal.co.uk

SPARE PARTS TEL: 0114 24 24 244

WORLDWIDE © COPYRIGHT 2016 ITSA GOAL POSTS LTD, ALL RIGHTS RESERVED A REGISTERED DESIGN