















## COMPONENTS

<b>A</b>	CORNER BRACKET	x2	
<b>B</b>	SPIGOT	x2	
<b>FGA</b>	FRONT GROUND ANCHOR	x2	
<b>RA</b>	REAR GROUND ANCHOR	x2	
<b>GP</b>	GROUND PEG	x18	
<b>TTE</b>	TOP TUBE ELBOW	x2	
<b>I</b>	SMALL QUICK RELEASE BUTTON	x2	
<b>NT</b>	NET TIE	x20	
<b>ST</b>	SMALL STANCHION NET TIE	x10	
<b>NET</b>	GOAL NET	x1	

## POST SECTIONS

<b>I</b>	CROSSBAR SECTION 2422mm LONG - 68mm Diameter	x1	
<b>J</b>	UPRIGHT SECTION 1205mm LONG - 68mm Diameter	x2	
<b>K</b>	TOP STANCHION TUBE 239mm LONG - 40mm Diameter	x2	
<b>L</b>	BACK STANCHION TUBE 1265mm LONG - 40mm Diameter	x2	

## 8' X 4' GRASS SURFACE

### ANCHOR YOUR GOAL POSTS & TIE NETS TO ALL FRAMES

During a game the goal posts must have the ground anchors inserted as shown below, in order to fully hold the goal post sections together. The Crossbar connects into the upright posts with the corner brackets (A). It is important to fix the goal net to the larger posts with the Large Net Ties (NT). Use the Small Stanchion ties (ST) to attached the nets tightly to the net supports as indicated. See over for other helpful hints on assembly.

Attached the net to the 68mm Dia post sections using Large Net Ties

Use the Small Stanchion ties to attach the net to the 40mm Dia net support tubes

## FOOTIEGOALS

TEL: 0114 24 24 244

## FITTING INSTRUCTION

CE NOT SUITABLE FOR CHILDREN UNDER 36 MONTHS UNTIL ASSEMBLED DUE TO SMALL PARTS.

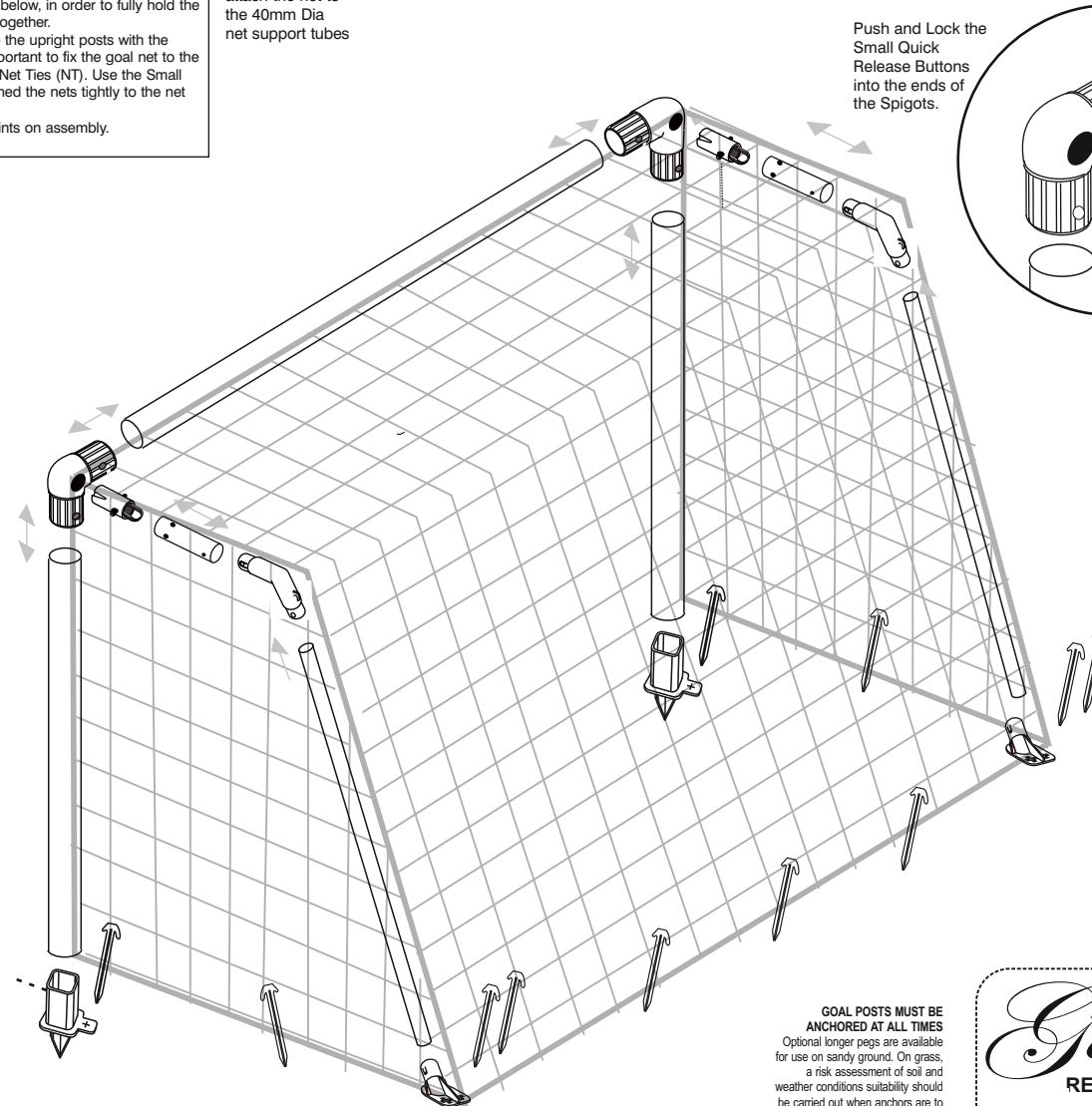

Push and Lock the Small Quick Release Buttons into the ends of the Spigots.

### GOAL TIP

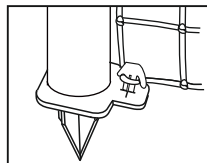

Fit the net to the ground peg at the foot of the post for a better fit.

**DO NOT USE IN EXTREME GALE FORCE WINDY CONDITIONS**

GOAL POSTS MUST BE ANCHORED AT ALL TIMES  
Optional longer pegs are available for use on sandy ground. On grass, a risk assessment of soil and weather conditions suitability should be carried out when anchors are to be used. Extra anchors are available TEL: 0114 2434200

*Guarantee*  
**REGISTER YOUR GUARANTEE**

To register for your one year guarantee please visit our web page  
[www.footiegoals.com](http://www.footiegoals.com)  
and scroll to the bottom of the page and click on the link 'Guarantee' and follow the instructions. Thank you.

SPARE PARTS AND NETS ARE AVAILABLE TEL 01142434200 [www.footiegoals.com](http://www.footiegoals.com)

WE RESERVE THE RIGHTS TO AMEND THE SPECIFICATIONS OF OUR SOCCER PRODUCTS IN THE INTEREST OF CONTINUED DEVELOPMENT. YOUR PRODUCT THEREFORE MAY DIFFER SLIGHTLY TO THOSE ILLUSTRATED. E&OE WORLDWIDE © COPYRIGHT 2001 ITSA GOAL POSTS LTD. ALL RIGHTS RESERVED A REGISTERED DESIGN

DO NOT USE IN EXTREME GALE FORCE WINDY CONDITIONS

**STEP 1**

Lay out all Posts and check component list.

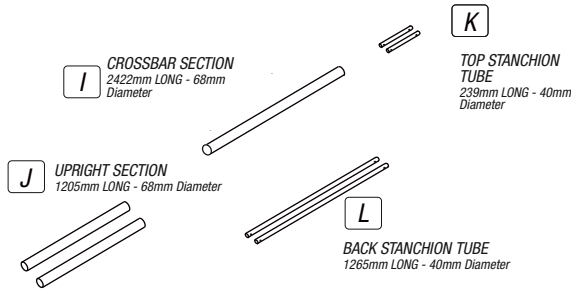

**STEP 2**

Insert Spigots **B**. into the corner brackets and insert the small quick release button **I** into the Spigots.

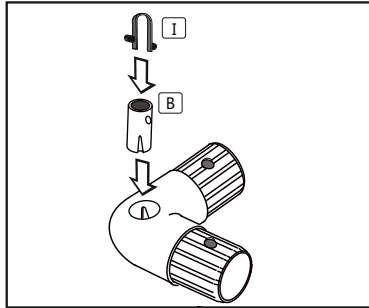

**STEP 3**

Insert Top Tube **M**. into the Corner Brackets with spigot, locking into the small quick release button. Insert the Top Tube Elbow **TTE** into the Top Tube

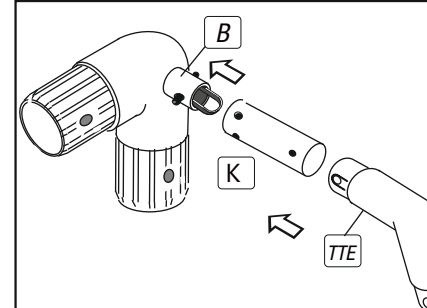

NOTE : Ensure that the two holes of the stanchion are parallel to the buttons of the Top Tube Elbow before connecting.

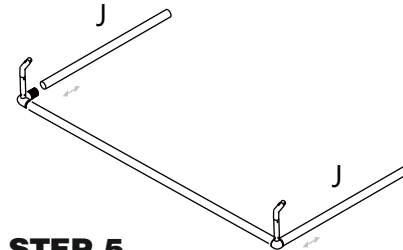
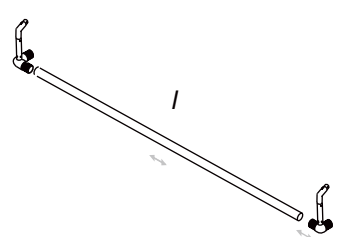
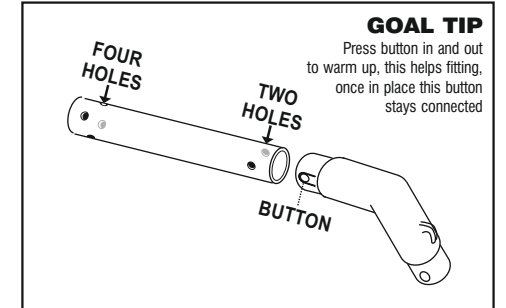

**STEP 4**

Connect **I** an insert the Corner Brackets with Top Tubes and Top Tube Elbows attached as shown in step 3.

**STEP 5**

Insert the upright posts **L** into the crossbar.

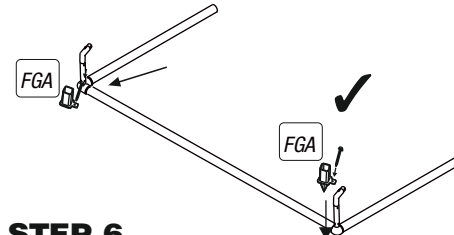

**STEP 6**

With the crossbar laid on the floor insert the Front Ground Anchors **FGA** as shown, this will provide the correct distance between the posts for the anchors to be inserted. Ssee the Goal tip, right.

**GOAL TIP**

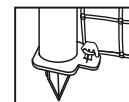

Fit the net to the ground peg at the foot of the post for a better fit.

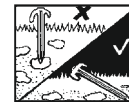

IF YOU WOULD LIKE TO CREATE A TIGHT FIT BETWEEN CORNER BRACKETS AND POSTS IT IS POSSIBLE TO ADD A SMALL AMOUNT OF MASKING TAPE (NOT INCLUDING) THIS CREATES A SEAL, IDEAL IF GOALS ARE LEFT IN SITU

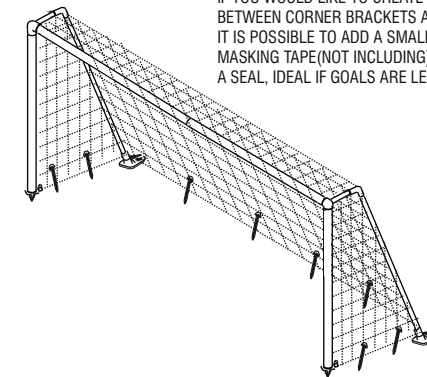

**GOAL TIP**

If the ground is really hard we recommend adding water to the ground to soften. Also use a wooden block or dowling to help insert your anchors into the turf. Use a rubber mallet.

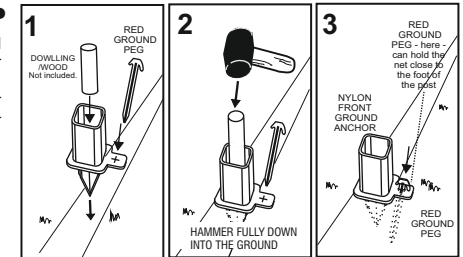

SQUARE MESH Net is cut to shape. Simply throw over the frame and fit each end onto top stanchion by securing on each corner of crossbar.

NOTE: If your net does not fit the first time, you may be fitting it to the goal frame upside down i.e. that is to say the net from the crossbar to the floor (a) is longer than the length of the net to the bottom of the upright.(b)

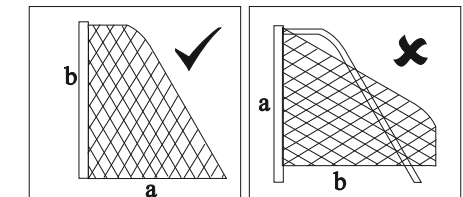

**STEP 7**

With the help of another person lift the goal uprights onto the Front Ground Anchors **FGA** and insert Ground Pegs **GP**.

**STEP 8**

Connect the back stanchion into the Top Tube Elbow. insert the Rear Ground Anchors **RA**. Line up the stanchions with the uprights and insert ground pegs **GP**.

**STEP 9**

Fit the Net . Tie the net to the frame starting with the corners first. Peg the net into the ground. Insert the pegs at an angle.

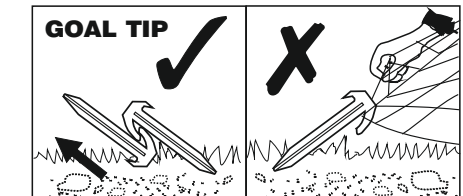

## CORNER BRACKETS

On this Budget Footie Goal the locking buttons are not included except for the net support stanchions. The corners of the goals can be made to be a tight fit by wrapping masking tape (not included) around the connectors that push into the posts. The more you apply the tighter the fit. Wrap around the twist the corner fitting onto the corner bracket. We recommend this if you are moving the goal around and do not take the goal down after each game.

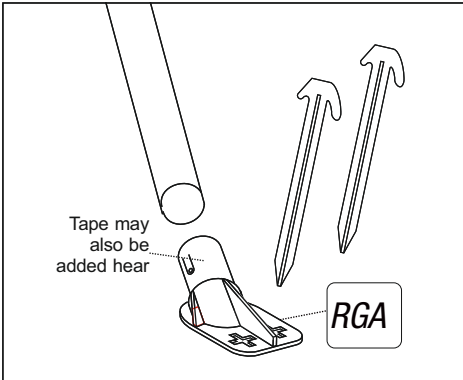
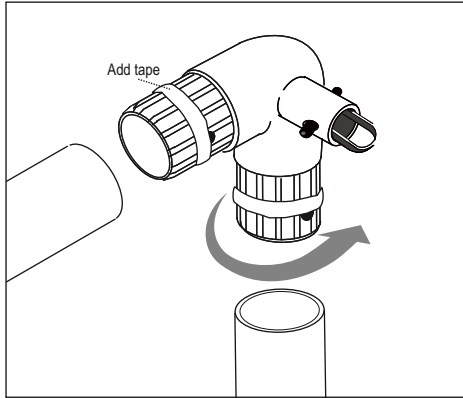

## OPTIONAL NET HOOKS

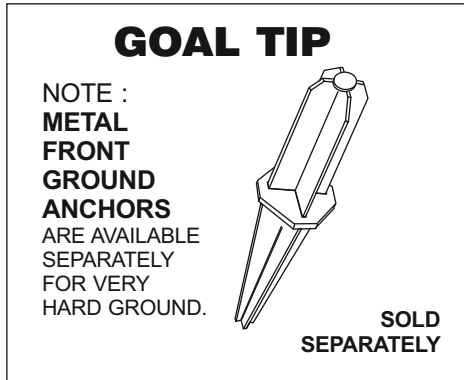
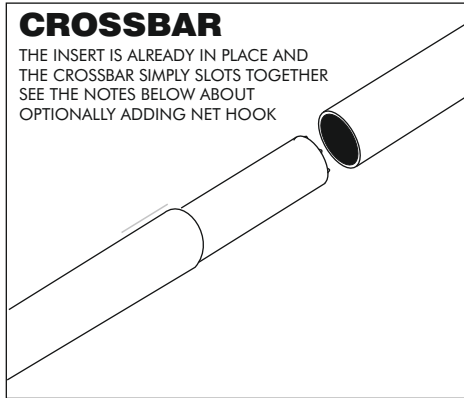
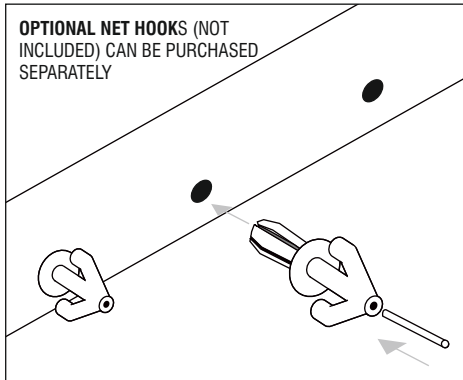

## PERMANENT FIXING

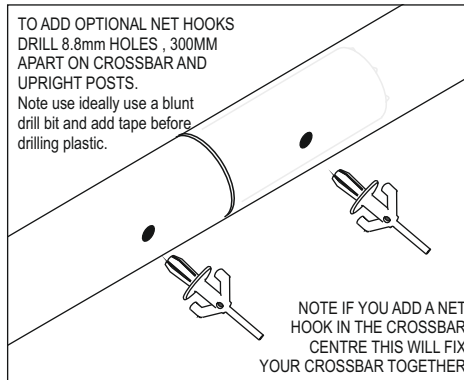

**NET TIES :** Place the small stanchion net ties on the net support stanchions. This will help extend the life of your net and keep the frame tightly fitted together. Apply the larger ties to the ground frame and the posts. We recommend placing the net ties no more than 340mm apart. The net ties supplied are designed to permanently fix the net to the goal frame. If you require to take nets on and off, other net fixings can be used.

**NOTE:** Goal must be anchored otherwise breakages may occur. In extreme conditions it is advised to store away. The best way to store your goal is to remove crossbar and rear back bar section leaving the net attached to the side frames. If you do this regularly then it is advisable to buy optional removable net ties. The goals are ideal when left with nets attached, for example in a garden. You must anchor your goals.

At the end of the season nets can be tied into a bundle and placed into a pillow case (not to damage washing machine) and washed at 40 C0 with normal washing powder. The ground frame can be washed with hot soapy water. Any scuff marks on posts can be rubbed off with a light abrasive scouring pad.

**WARNING:** Check the position of any underground services before using the ground anchors and pegs. We take no responsibility for any damage or injury caused in this manner.

**NEVER** use the goals without the ground anchor system. In severe weather or windy conditions it is advisable to take your goal down as damage is not covered by the guarantee in such circumstances.

If you find the nets are worn along the floor it may be rodents, by spreading pepper along the base frame rodents will be deterred.

It is advisable in any contact sport to take out the relevant insurance's to cover against injury both from taking part, equipment and other unforeseeable circumstances.

Crossbars will not be replaced within the guarantee period if broken by swinging or climbing or any other misuse. DO NOT try to glue any damaged fixings. Plastic materials in this product vary and this may cause the plastic to break. Always replace any damaged components.

**NOTE :** All plastic extrusions vary and therefore some tubes may be looser or tighter to connector fittings. If you want to increase the diameter of the fitting just wrap masking tape around the part that fits into the tube, twist as you insert the fitting and it will grab to the tube tight. You can make tighter fits by adding more tape.

We advise adult supervision during assembly and use. Observe and follow warning labels attached to goal. Do not use any components, nets or parts if they are damaged or broken. Spare parts and replacement nets are readily available. If others are to install your goal you should show them how to erect and dismantle the goal and hand them a copy of the fitting instruction. If you lose your instructions copies can be attained from our company website. To avoid damage when dismantling the goal follow these guidelines: it is advisable in extreme windy conditions to dismantle the goal and store away. Do not drop any heavy objects on ends of tubes. When dismantling the goal ensure that all fittings are packed away and that non are left on the playing surface. Warning goals must never be left up or used unless they are properly fitted with ground anchors with net attached and securely pegged down.

**Hard surfaces:** to prevent damage to goal or it's components, loosen soil with a steel pole and moisten with some water before inserting the ground anchors. Do not use the goal in sub zero temperatures. warning labels should be replaced when worn and we recommend replacing them every two years -spare labels available. damaged components requested under guarantee must be returned for inspection. Failure to follow the warnings, fitting instructions contained in this document, may invalidate your guarantee. The company, its agents and representatives do not accept any product liability if used outside the EU. Use of the product in other countries outside the EU including the USA is not covered and appropriate insurance should be taken out by the user to cover for any eventualty. We reserve the rights to amend the specifications of our soccer products in the interest of continued development. Your product therefore may differ slightly to those illustrated. Not suitable for children under 36 months until assembled due to small parts..

# Guarantee

## REGISTER YOUR GUARANTEE

To register for your one year guarantee please visit our web page  
[www.footiegoals.com](http://www.footiegoals.com)  
 and scroll to the bottom of the page and click on the link 'Guarantee'  
 and follow the instructions. Thank you.

