



















COMPONENTS

A	CORNER BRACKET	x6	
B	SPIGOT	x4	
C	BLANKING CAP	x2	
TTE	TOP TUBE ELBOW	x2	
LB	LOWER BACK STANCHION CONNECTOR	x2	
ST	SMALL STANCHION NET TIE	x14	
LG	LARGE NET TIE	x34	
I	SMALL QUICK RELEASE BUTTON	x4	
MSA	MULTI-SURFACE ANCHOR	x3	
GP	GROUND PEG	x6	
NET	GOAL NET	x1	
SC	STRAIGHT CONNECTOR	x1	

POST SECTIONS

K	CROSSBAR SECTION with insert 68mm Diameter	x1	
K1	CROSSBAR SECTION 68mm Diameter	x1	
L	BACKBAR SECTION 68mm Diameter	x2	
M	SIDEBAR SECTION 1360mm LONG - 68mm Diameter	x2	
N	UPRIGHT SECTION 1726mm LONG - 68mm Diameter	x2	
O	TOP STANCHION TUBE 400mm LONG - 40mm Diameter	x2	
P	BACK STANCHION TUBE 1896mm LONG - 40mm Diameter	x2	

8' X 6' FOOTIEGOAL (with Base - two section)

SPARE PARTS AND NETS ARE AVAILABLE

TEL 0114 242 4244 www.itsagoal.co.uk

Guarantee

REGISTER YOUR GUARANTEE
To register for your one year guarantee please visit our web page
www.itsagoal.co.uk
and scroll to the bottom of the page and click on the link 'Guarantee'
and follow the instructions. Thank you.

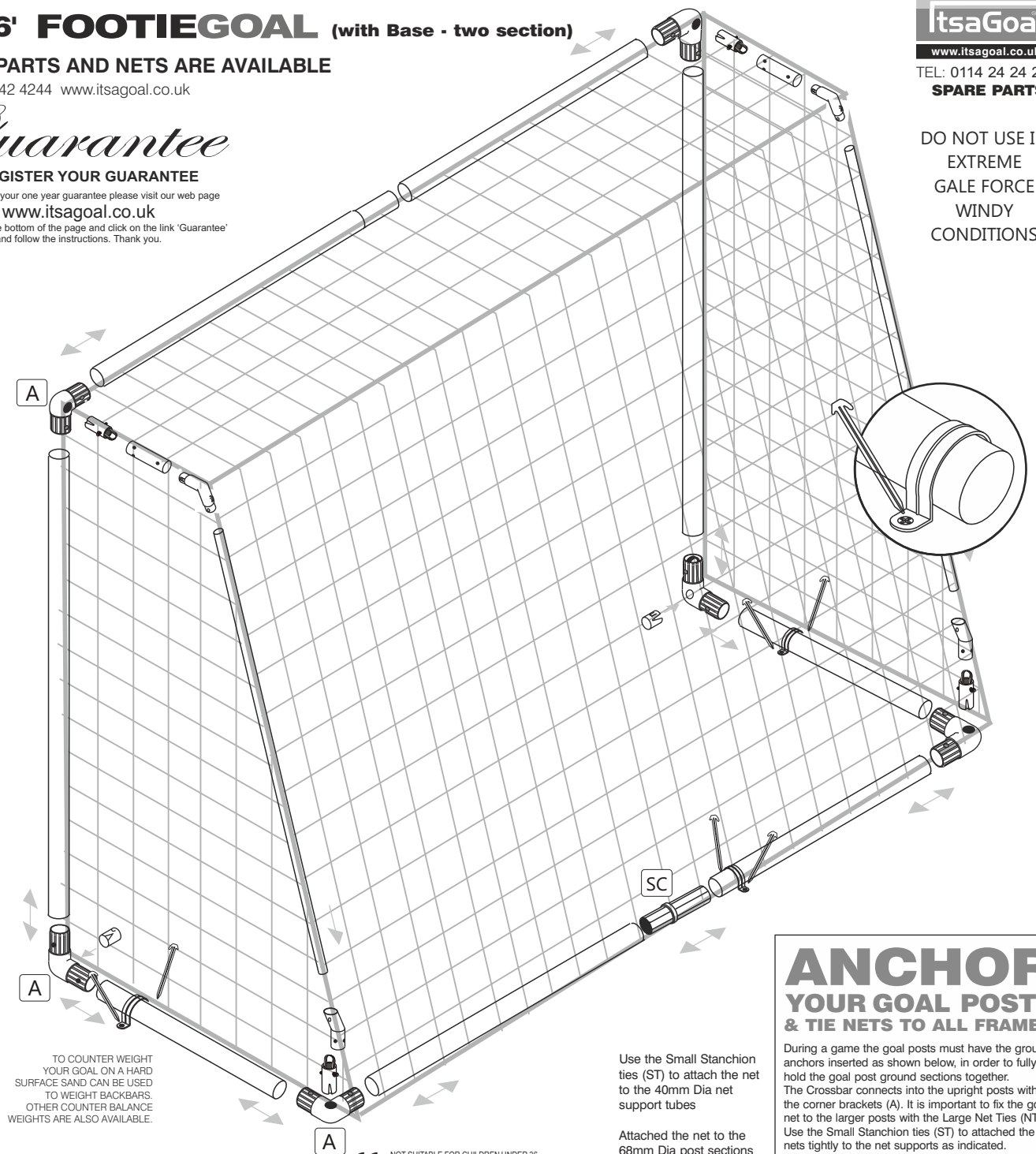

tsaGoal
www.itsagoal.co.uk
TEL: 0114 24 24 244
SPARE PARTS

DO NOT USE IN
EXTREME
GALE FORCE
WINDY
CONDITIONS

TO COUNTER WEIGHT
YOUR GOAL ON A HARD
SURFACE SAND CAN BE USED
TO WEIGHT BACKBARS.
OTHER COUNTER BALANCE
WEIGHTS ARE ALSO AVAILABLE.

ANCHOR YOUR GOAL POSTS & TIE NETS TO ALL FRAMES

During a game the goal posts must have the ground anchors inserted as shown below, in order to fully hold the goal post ground sections together. The Crossbar connects into the upright posts with the corner brackets (A). It is important to fix the goal net to the larger posts with the Large Net Ties (NT). Use the Small Stanchion ties (ST) to attached the nets tightly to the net supports as indicated. See over for other helpful hints on assembly.

Use the Small Stanchion ties (ST) to attach the net to the 40mm Dia net support tubes

Attached the net to the 68mm Dia post sections using Large Net Ties (NT)

STEP 1

Lay out all Posts & components

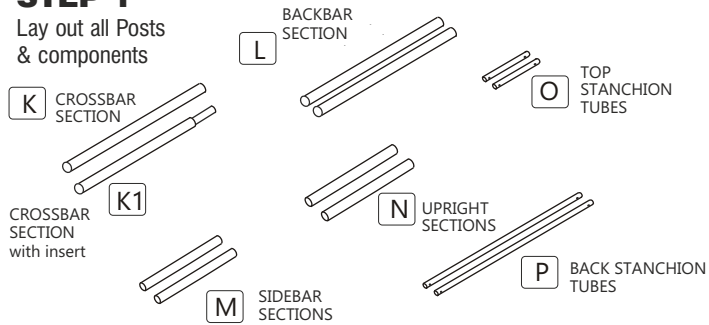

STEP 2

Insert Blanking Cap part C into two corners

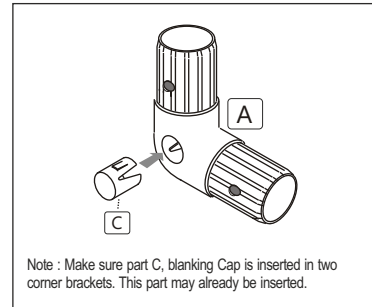

STEP 3

Insert Spigots B. into four corner brackets and insert the small quick release button I into the Spigots

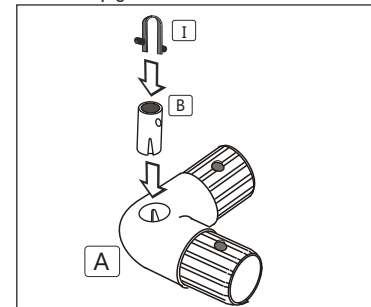

STEP 4

Insert the Lower Back Stanchion Connector LB into two of the corner bracket that already have the spigot in place.

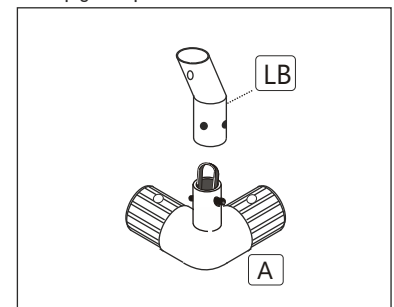

STEP 5

Firstly form the ground frame - Connect Backbar sections L using the Straight connector SC with the Corner Brackets with the Lower Back Stanchion Connectors (parts from step 3) Insert the sidebar sections M into the Corner Brackets.

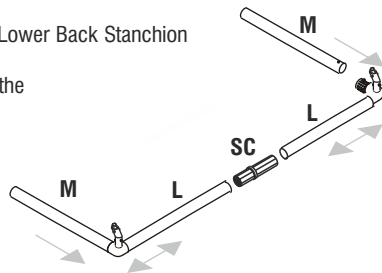

STEP 6

Insert Corner Brackets with Blanking Caps into upright posts N

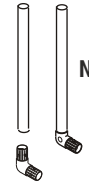

STEP 7

Insert uprights N with the Corner Brackets with Blanking Caps into the ground side bars M

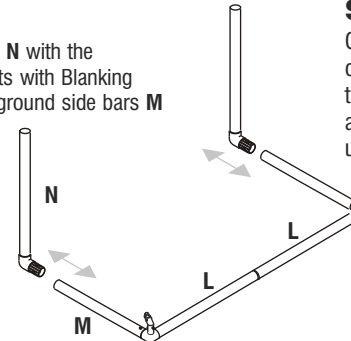

STEP 8

Connect the remaining corners brackets to the Crossbar K & K1 and slide onto the uprights

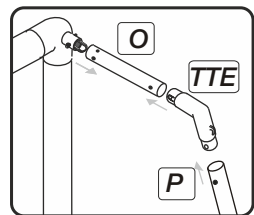
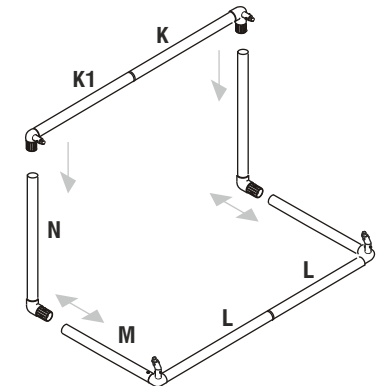

STEP 9

Join top tubes O with Top Tube Elbows TTE and back tubes P and connect to the goalpost.

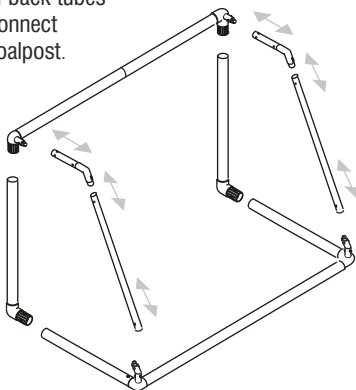

GOAL TIP

Press button in and out to warm up, this helps fitting, once in place this button stays connected

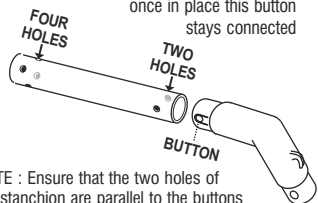

NOTE : Ensure that the two holes of the stanchion are parallel to the buttons of the Top Tube Elbow before connecting.

STEP 10

Start with each corner and attach the Net to the goal with the net ties. The net must be attached to use the goal. SEE THE NEXT PAGE for detailed information on how to properly fit your net.

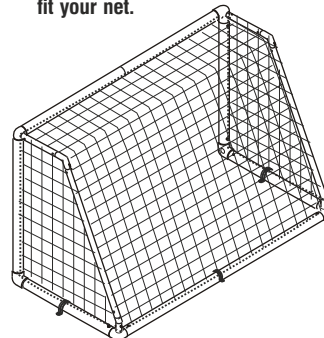

SQUARE MESH
Net is cut to shape. Simply throw over the frame and fit each end onto top stanchion by securing on each corner of crossbar.

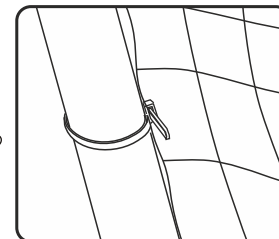

STEP 11

Attach Ground Anchors. Anchors must be inserted for the stability of the whole goal frame - see details of use overleaf.

SEE THE NEXT PAGE

for detailed information on how to anchor your goal.

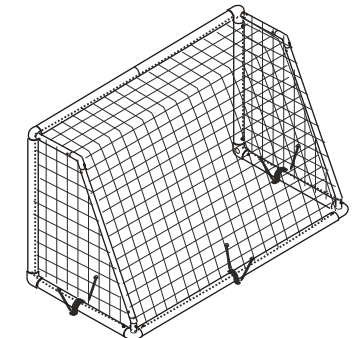
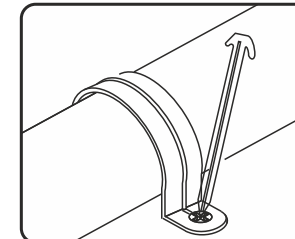

STEP BY STEP NET FITTING

STEP 1

Open net and check the lengths of a and b correspond with the diagram below.

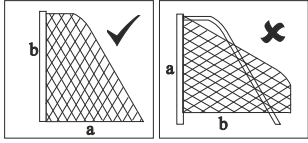

STEP 2

With the net the correct way round lift the net onto the goalpost frame. This is easier with two people.

NOTE: If your net does not fit the first time, you may be fitting it to the goal frame upside down i.e. that is to say the net from the crossbar to the floor (a) is longer than the length of the net to the bottom of the upright. (b)

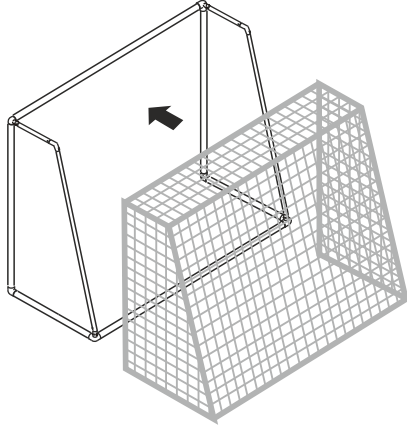

STEP 3

Attach the corners first, where the upright posts meet the crossbar as shown.

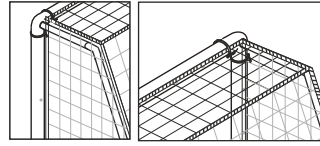

STEP 4

Using the large net ties tie the net to each remaining corner of the goal frame and use the remaining net ties to tie the net firmly to the posts as shown.

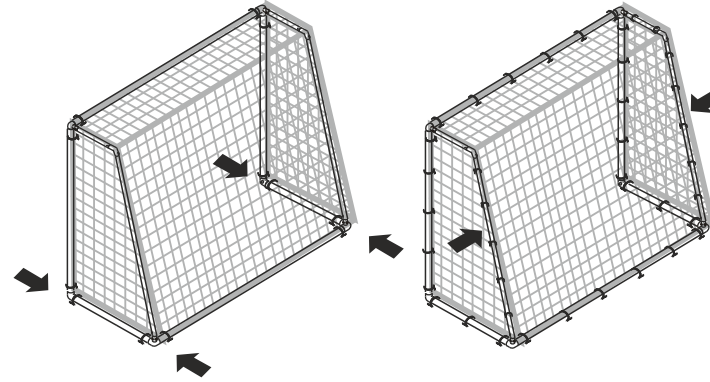

STEP 5

Using the small net ties attach the net down the back of the sloping back net supports as shown to the posts as shown.

OPTIONAL - STANCHION TIES

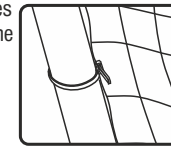

STEP 6

NET CORD - ROOF TO THE NET
To help define the roof of the net Tie the cord to one side and pull the net chord tight and wrap neatly down and around the stanchion section. If you are regularly attaching or detaching the net then apply coloured tape to the roof corners of net to help identify the roof area.

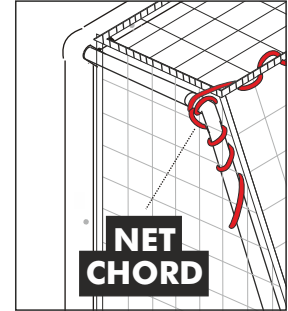

ANCHORING YOUR GOAL

WARNING: Check the position of any underground services before using the ground anchors and pegs. We take no responsibility for any damage or injury caused in this manner.

HARD SURFACES: to prevent damage to goal or it's components, loosen soil with a steel pole and moisten with some water before inserting the ground anchors. Do not use the goal in sub zero temperatures.

ANCHORING YOUR GOAL ON GRASS - POSITION YOUR GOAL ON A LEVEL PLAYING SURFACE. PLACE THE MULTI-SURFACE ANCHOR OVER EACH SIDE OF THE GROUND FRAME (POSITIONS SHOWN) HAMMER THE PEGS THROUGH THE HOLES (DO NOT USE METAL HAMMERS USE RUBBER MALLETS) ON THE ANCHOR DOWN UNDER THE FRAME INTO THE GRASS ADDITIONAL ANCHORS OR LARGER PEGS CAN BE PURCHASED FOR USE ON SOFT GROUND OR SAND. THESE ANCHORS CAN BE USED FOR HARD SURFACES SUCH AS TARMAC WITH OPTIONAL BOLTS. ON HOT/SUNNY DAYS TARMACADAM SOFTENS AND THEREFORE TO ANCHOR

YOUR GOAL PROPERLY YOU MUST:-

- 1 DIG HOLES IN YOUR TARMAC FILL HOLES WITH CONCRETE
- 2 DRILL TWO 14MM HOLES 12CM APART AND 70MM DEPTH.
- 3 POSITION GOAL AND ANCHOR, INSERT AND TIGHTEN BOLT.

FOR OTHER SURFACES SUCH AS WOODEN SPORTS HALL FLOORS WOOD SCREWS (INSTEAD OF BOLTS) OR COUNTER BALANCE WEIGHTS CAN ALSO BE USED (SUPPLIED SEPARATELY).

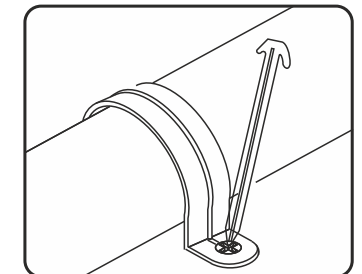
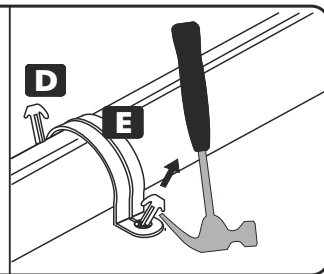
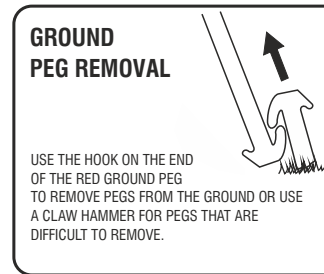
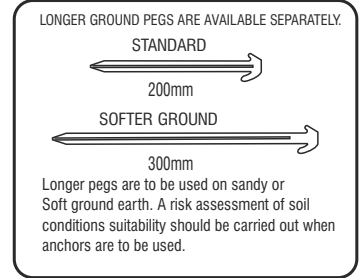
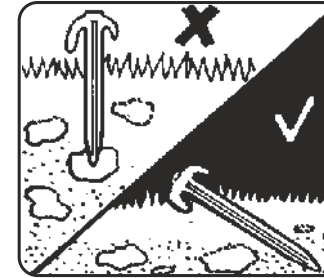
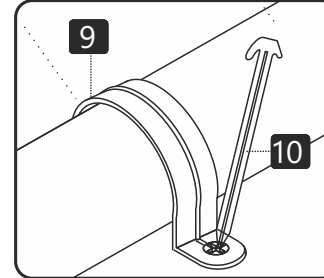
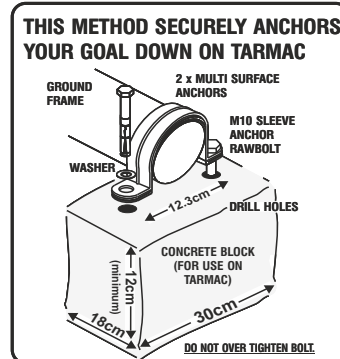
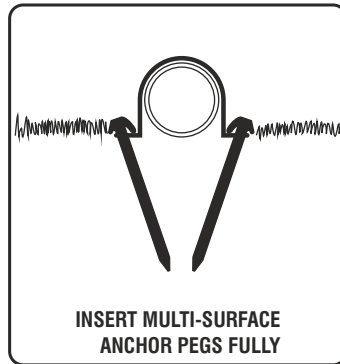

For help contact www.itsagoal.co.uk

SPARE PARTS TEL: 0114 242 4244

WORLDWIDE © COPYRIGHT 2016 ITSA GOAL POSTS LTD, ALL RIGHTS RESERVED A REGISTERED DESIGN

CORNER BRACKETS

On this Budget Footie Goal the locking buttons are not included except for the net support stanchions. The corners of the goals can be made to be a tight fit by wrapping masking tape (not included) around the connectors that push into the posts. The more you apply the tighter the fit. Wrap around the twist the corner fitting onto the corner bracket. We recommend this if you are moving the goal around and do not take the goal down after each game.

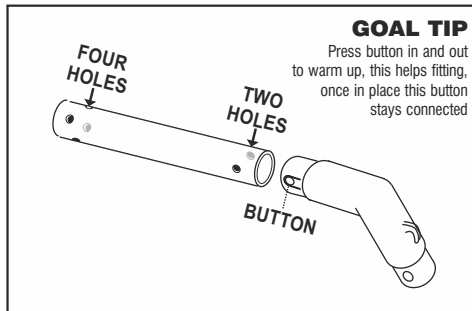
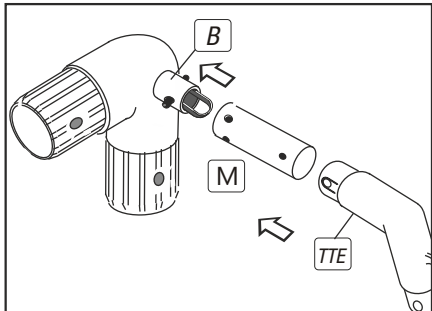
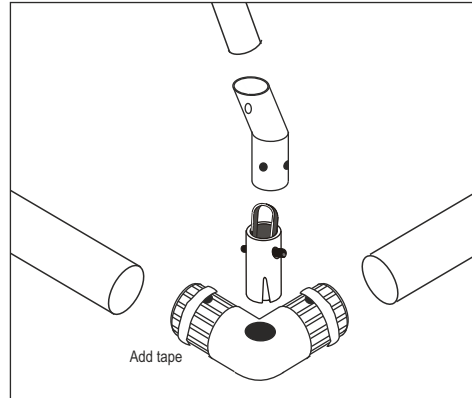
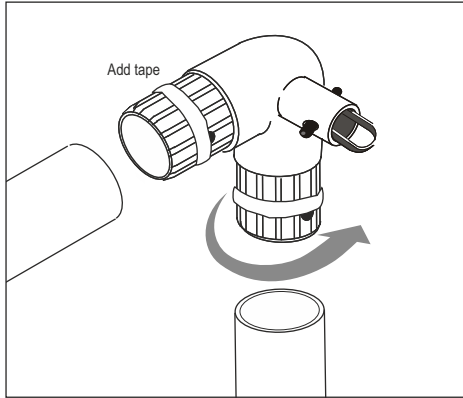

NOTE : Ensure that the two holes of the stanchion are parallel to the buttons of the Top Tube Elbow before connecting.

OPTIONAL NET HOOKS

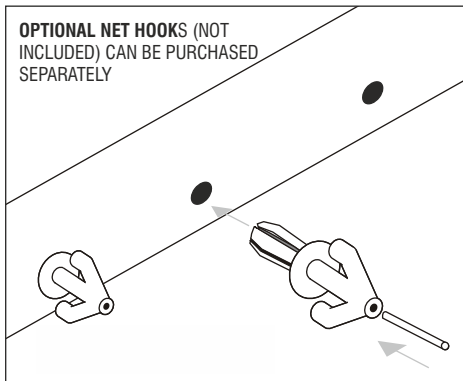

PERMANENT FIXING

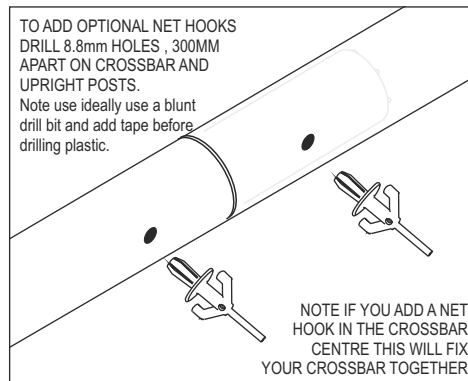

NET TIES : Place the small stanchion net ties on the net support stanchions. This will help extend the life of your net and keep the frame tightly fitted together. Apply the larger ties to the ground frame and the posts. We recommend placing the net ties no more than 340mm apart. The net ties supplied are designed to permanently fix the net to the goal frame. If you require to take nets on and off, other net fixings can be used.

NOTE: Goal must be anchored otherwise breakages may occur. In extreme conditions it is advised to store away. The best way to store your goal is to remove crossbar and rear back bar section leaving the net attached to the side frames. If you do this regularly then it is advisable to buy optional removable net ties. The goals are ideal when left with nets attached, for example in a garden. You must anchor your goals with the multi surface ground anchors provided. At the end of the season nets can be tied into a bundle and placed into a pillow case (not to damage washing machine) and washed at 40 C0 with normal washing powder. The ground frame can be washed with hot soapy water. Any scuff marks on posts can be rubbed off with a light abrasive scouring pad.

If you find the nets are worn along the floor it may be rodents, by spreading pepper along the base frame rodents will be deterred.

It is advisable in any contact sport to take out the relevant insurance's to cover against injury both from taking part, equipment and other unforeseeable circumstances.

Crossbars will not be replaced within the guarantee period if broken by swinging or climbing or any other misuse. DO NOT try to glue any damaged fixings. Plastic materials in this product vary and this may cause the plastic to break. Always replace any damaged components.

NOTE : All plastic extrusions vary and therefore some tubes may be looser or tighter to connector fittings. If you want to increase the diameter of the fitting just wrap masking tape around the part that fits into the tube, twist as you insert the fitting and it will grab to the tube tight. You can make tighter fits by adding more tape.

We advise adult supervision during assembly and use. Observe and follow warning labels attached to goal. Do not use any components, nets or parts if they are damaged or broken. Spare parts and replacement nets are readily available. If others are to install your goal you should show them how to erect and dismantle the goal and hand them a copy of the fitting instruction. If you lose your instructions copies can be attained from our company website.

To avoid damage when dismantling the goal follow these guidelines: it is advisable in extreme windy conditions to dismantle the goal and store away. Do not drop any heavy objects on ends of tubes. When dismantling the goal ensure that all fittings are packed away and that non are left on the playing surface. Warning goals must never be left up or used unless they are properly fitted with ground anchors with net attached and securely pegged down.

Hard surfaces: to prevent damage to goal or it's components, loosen soil with a steel pole and moisten with some water before inserting the ground anchors. Do not use the goal in sub zero temperatures.

Warning labels should be replaced when worn and we recommend replacing them every two years -spare labels available. damaged components requested under guarantee must be returned for inspection. Failure to follow the warnings, fitting instructions contained in this document, may invalidate your guarantee.

The company , its agents and representatives do not accept any product liability if used outside the EU. Use of the product in other countries outside the EU including the USA is not covered and appropriate insurance should be taken out by the user to cover for any eventuality. We reserve the rights to amend the specifications of our soccer products in the interest of continued development. Your product therefore may differ slightly to those illustrated.

Not suitable for children under 36 months until assembled due to small parts.

For help contact www.itsagoal.co.uk

SPARE PARTS TEL: 0114 242 4244

WORLDWIDE © COPYRIGHT 2016 ITSA GOAL POSTS LTD,
ALL RIGHTS RESERVED A REGISTERED DESIGN