

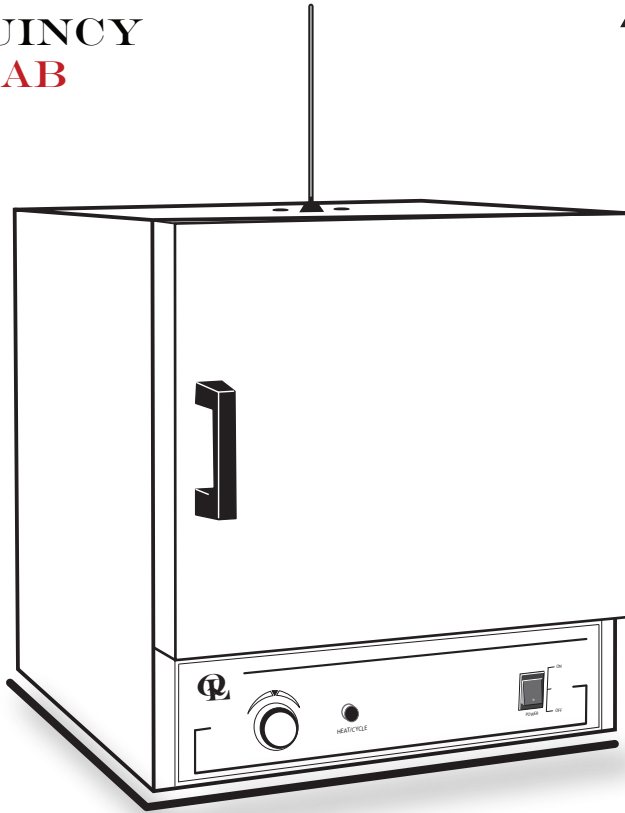

Analog Series Lab Oven Operating Manual

For models 10GC, 20GC, 30GC, & 40GC
10GC-1, 20GC-1, 30GC-1, & 40GC-1



Carton Contents

- (1) GC Series Oven
- (2) Adjustable nickel-plated wire shelves
- (4) Shelf brackets
- (1) Glass Thermometer (non-toxic)
- (1) Rubber Thermometer grommet

Approvals:

Underwriter's UL / CUL, United States
Canadian for laboratory equipment.

Compliance: UL Standard 61010-1
IEC 61010-1.

NOT FOR USE WITH FLAMMABLE LIQUIDS OR GASES



SPECIFICATIONS

(-1) indicates 230V model

	<u>MODEL</u> 10GC (-1)	<u>MODEL</u> 20GC (-1)	<u>MODEL</u> 30GC (-1)	<u>MODEL</u> 40GC (-1)
INTERIOR DIMENSIONS INCHES W x H x D (CM) W x H x D	12x10x10 30.5x25.4x25.4	13x13x13 33x33x33	18x15.63x12 45.7x39.75x30.5	18x21.75x14 45.7x55.25x35.5
EXTERIOR DIMENSIONS INCHES W x H x D (CM) W x H x D	14x17.5x12.25 35.5x44.5x31.75	15x21x15 38x53.3x38	20x25x14 51x63.5x35.5	20x30x16 51x76.2x40.7
TEMPERATURE RANGE Ambient + 25°F to: F / C	450° / 232°	450° / 232°	450° / 232°	450° / 232°
CONTROL STABILITY Typically ± °F / °C	6° / 3°	6° / 3°	6° / 3°	6° / 3°
STANDARD ELECTRICAL VOLTS / AMPS (230V) Model VOLTS / AMPS WATTS (230V) Model WATTS FREQUENCY PLUG / NEMA (230V) Model PLUG / NEMA	115 / 5.2 230 / 2.6 600 600 50/60 Hz 5-15P 6-15P	120 / 6.3 230 / 3.5 750 800 50/60 Hz 5-15P 6-15P	115 / 10.5 230 / 5.2 1200 1200 50/60 Hz 5-15P 6-15P	120 / 12.5 230 / 6.9 1500 1600 50/60 Hz 5-15P 6-15P
WEIGHT (lbs) SHIPPING STAND ALONE	44 38	61 54	78 70	94 85

Common Unit Construction

Exterior: Powder Coated Steel
Insulation: Fiberglass
Thermo-control: Bimetal(10 series) / Hydraulic

Interior: Aluminized Steel
Motor: N/A on GC Models
Heater: Resistive-Tubular Incoloy

**IMPORTANT**

Refers to an important note in the usage of the unit

**WARNING**

Warns of a possible electrical shock

**WARNING**

Warns of a possible risk of fire

**CAUTION**

Cautions of HOT exterior surface during operation

**WARNING**

Warns of possible injury or muscle strains, use assistance when moving or lifting

Safety Precautions**Read Operating Instructions thoroughly prior to operation****Operate the oven in accordance with all state, local, and federal laws that may govern its usage for your specific application. Observe the following safety precautions:**

- Use only a grounded outlet that is rated for your model's electrical requirement.
- Do not modify the oven or factory control settings to operate the oven above the stated maximum operating temperature.
- Exterior surfaces of the oven may become hot to the touch when operating at higher set temperatures.
- Do not leave the oven unattended during operation.
- Do not place volatile or combustible materials inside the oven.
- Do not use any flammable solvents or gases or materials that may contain flammable solvents or gases, or with liquids, vapors or chemicals that produce toxic gases.
- Do not use open liquids in the oven.
- Conduct periodic maintenance as required.

Set-Up & Installation

- Position the unit in its ultimate operating location. Keep a minimum of 4" of airspace around the unit and a minimum of 18" above the unit. The portholes at the top of the unit will expel a small amount of warm air through natural convection. This port can also be used as an access for an external temperature probe to verify the chamber's temperature or the chamber's contents directly.
- Install the adjustable shelf by placing the ends of the wire shelf bracket into the corresponding holes located on the inner sides of the oven at the desired height. Push the ends of the bracket into the holes until the first bends in the bracket are against the wall, then rotate the bracket down. Place the shelf on the brackets. (FIG 1)
- Plug the oven into a grounded outlet rated for your unit's labeled voltage. A separate circuit or breaker should be dedicated for the oven.
 - Do NOT modify the provided plug. Do NOT use an extension cord.**

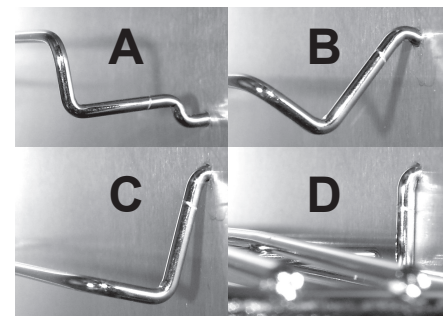
**FIG. 1****► THERMOMETER SET-UP**

Remove the glass thermometer from its container and insert it into the rubber grommet using a slow twisting motion, until the bottom of the grommet is at the reference line as shown in FIG. 2.

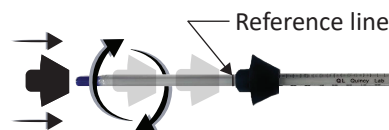
**FIG. 2****⚠ CAUTION:**

Avoid forcing the glass thermometer into the grommet, this can cause the thermometer to shatter, risking the possibility of injury.

NOTE: When inserting the rubber grommet on top of the unit, ensure that the **narrow** part of the grommet is facing down.

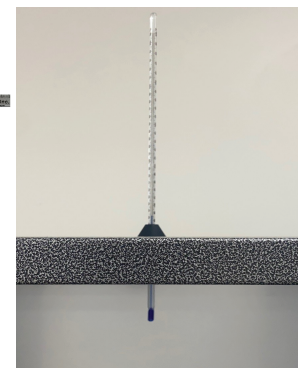
**FIG. 3**

TIP: Use a small amount of liquid soapy solution to help insert the grommet into the thermometer more easily.

General Operation

The unit is ready for your immediate use and no adjustments are necessary. For normal operation and temperature setting follow the steps below.

1. Turn the power switch to the ON (UP) position by pressing on the rocker switch.
2. Insert the grommet/thermometer assembly into the top center port hole of the oven with the narrow part of the grommet facing down. The thermometer will extend about 2 inches into the oven's chamber when it's placed at the reference line.
3. Rotate the oven's dial clockwise to a number setting (10GC series) or temperature setting to start the heating process.

General Operation (continued)

For 10GC models: Rotate the dial clockwise to around the number '8'. The "heat/cycle" light will come on indicating heater activity. **Monitor the reading on the thermometer until it reaches the desired temperature.** Next, rotate the control knob very slowly counter-clockwise until the heat-cycle light goes out. The thermostat will then cycle automatically maintaining the set temperature.

For 20GC, 30GC, and 40GC models: These models come equipped with a dual-range "quick-set" knob dial. This feature makes it easier to hit a target temperature range from a cold start, whether using the Fahrenheit or Centigrade scale. Turn the thermostat knob to the desired temperature indicated on the knob (Fahrenheit), or the dial (Centigrade).

- ▶ To set a temperature in degrees Fahrenheit, turn the knob in a clockwise direction until the desired number on the knob is directly under the white triangle with the "°F" marking.
- ▶ To set a temperature in degrees Centigrade, turn the knob in a clockwise direction until the white triangle with the "°C" marking is pointing toward the desired temperature printed on the face of the control panel.

Rotate the dial to the desired temperature. The heat-cycle light will illuminate until the set temperature is reached. Once reached, the heat-cycle light will cycle on and off with the heaters maintaining set temperature. Typically, the oven will need to cycle at a set temperature for a minimum of 20 minutes before it will achieve equilibrium and become stable.

⚠ The temperatures printed on the "quick-set" dial are designed to help quickly set a temperature to within a close proximity of the indicated dial temperature. Small rotational adjustments will likely be required to set a more precise temperature setting as measured against a reading from the glass thermometer (supplied), or another measuring device.

⚠ Any degree of offset observed for a given temperature setting may be different for other temperature settings on the dial. The control dial is calibrated at the factory in the middle of the model's temperature range and is therefore most accurate in these middle-range temperatures. Over time, continuous use at a single temperature setting may require periodic re-adjustment as the contacts wear or as ambient temperatures change seasonally, or from air conditioning or heating. See also: "Temperature Range Adjustment insert for more information".

Chamber Loading

Understanding the unit's thermal convection and "load-effect" are necessary to optimize oven's performance. Article or media processing times and/or uniformity are largely dependent on load density and positioning.

Important guidelines to chamber loading and processing:

- ▶ Load the oven so that heated air circulation within the chamber is not impaired.
- ▶ Leave a space between articles on the shelf.
- ▶ Stagger articles from those on lower shelves in a "V" formation for best performance. (FIG. 4)
- ▶ Avoid large solid trays or foil on lower shelves, this can drastically limit heat to shelves and articles placed above. (FIG. 5)
- ▶ Avoid extremely large (in quantity or size), or high-density loads (FIG. 6). This will show by non-uniform processing and long or impossible "heat-through" times. To help determine a large load's suitability, use the set-point recovery time (the time it takes for the temperature to recover to the original set temperature once load is placed), as a guide.
- ▶ To reduce recovery time after inserting a load, reduce load proportionally. Also, large loads may require an elevated set temperature for the solution to reach and maintain a lower target temperature. When possible, measure large loads or solution temperatures directly with an ancillary thermometer or probe. **Probes can be inserted at the top port.**
- ▶ Process the smallest possible load the application or workload will permit. For best processing of small multiples or a single item, adjust one shelf so that the article(s) is centered in the Lab Oven.
- ▶ Avoid placing articles or media against or within an inch of the walls especially on the lower shelf. Heated air from the lower heat-shield, is designed to travel up the sidewalls and can have a slightly elevated temperature from the setpoint and the rest of the chamber.

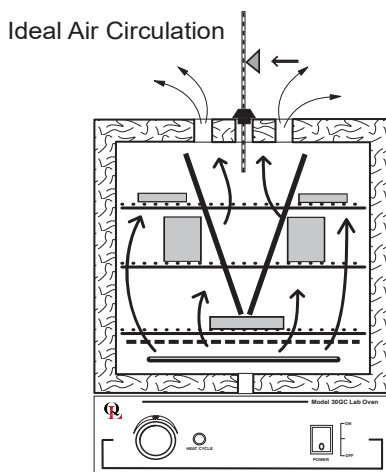

FIG. 4

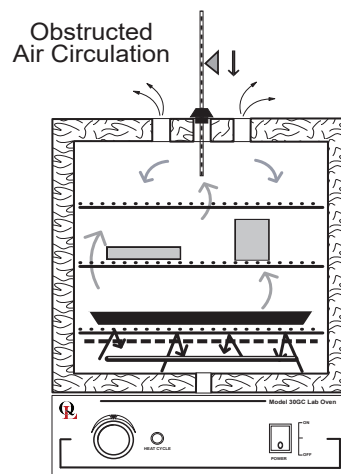

FIG. 5

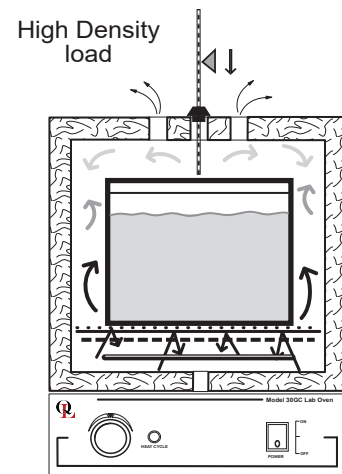



FIG. 6

Chamber Loading (Continued)

The oven's chamber temperature stability can be affected by changes in ambient (room) temperature and/or equipment running in close proximity (creating microclimates) or cycling on the same electrical circuit. Take time to see how unit location or changes in room temperature from seasonal heating or air conditioning may influence the oven's set temperature. **For best chamber temperature stability, keep the ambient temperature stable.**

Thermal Safety Reset (Snap Disc)

Oven Safety Reset- To protect the oven's electrical components and for the safety of the user, if the unit exceeds its maximum temperature, an internal safety "snap disc" will cut power OFF to the unit until it is manually reset (FIG. 7).

 **To Reset** - disconnect the oven from power. Next, lay the oven on its back and remove the bottom cover. Locate the round "snap disc" and push on the button to reset.

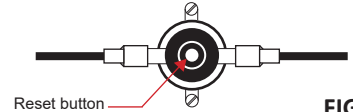

FIG. 7
Thermo Fuse (Snap Disc)

Maintenance / Cleaning Procedures / Common Replacement Parts

The Lab Series Ovens are designed to be virtually maintenance free. But operational safety requires periodic cleaning and chamber temperature accuracy verification (see calibration and temp. range adjustment insert for more information).

Cleaning Procedure - Periodically check the rear air intake vents for dirt or dust build-up. Keep the intake & exit ports clear of obstruction and clean of dust and dirt. To reduce the risk of fire, it may be necessary to remove the bottom plate cover to clean or vacuum any dirt and dust build-up. To clean the exterior and interior surfaces, use a damp cloth or an all-purpose cleaner. Avoid commercially available oven cleaners.

Troubleshooting

PROBLEM	POSSIBLE CAUSE	WHAT TO DO BEFORE CALLING TECH. SUPPORT
Unit not turning ON when power switch is in the ON position	1. <i>Tripped GFCI power outlet</i>	1. Check if the unit tripped a GFCI outlet or fuse. Try a non GFCI power outlet connection before moving to number 2 on this list.
	2. <i>Thermal safety disc tripped.</i>	2. Reset the oven's "snap disc". Refer to "Thermal Safety Reset" section above for more information.
	3. <i>Disconnected / loose wires.</i>	3. Check all wire connections in the electrical area (bottom) and make sure there are no loose or disconnected wires in the unit.
Oven has power but its not heating or is overheating.	1. <i>Thermal Fuse (10GC models only)</i>	1. Check thermal fuse in the back of the thermostat is not blown or broken. Repacle if blown/broken.
	2. <i>Bad / broken / old Thermostat</i>	2. If the oven does not heat, overheats, or does not maitain a setpoint temperature, it's an indication of a bad/broken/old thermostat. Replace thermostat on the unit.

Common Replacement Parts

Thermostat

Hydraulic Thermostat
PART # 101-2223
Bimetal Thermostat (Model 10)
PART # 201-2217

Thermometer

Spirit Thermometer
PART # 201-2219
Thermometer grommet
PART # 101-2204

Rocker Switch

GC Series
PART # 201-2213
GC Series
PART # 201-2213-1

For a full list of replacement parts scan QR code.



Technical Support

If you have any questions or need technical assistance, contact Quincy Lab technical support.

Visit us on the web at www.quincylab.com

Email: information@quincylab.com
Voice: 800-482-4328 ; Press 2 for tech support.
Fax: 773-622-2282

Quincy Lab, Inc.
109 Shore Dr.,
Burr Ridge, Illinois 60527

Limited Warranty



Quincy Lab, Inc. warrants to the original purchaser that this product will be free from defects in material and workmanship under normal use throughout the warranty period. The standard warranty period for this instrument is twenty four (24) months from date of shipment. The instrument warranty is supplemented with a three year warranty on the heating element. Please refer to your invoice or shipping documents to determine the active warranty period. This warranty covers parts & labor (labor at factory only) and shipping cost for replacement parts.

LAB OVEN SERIES

Calibration and Temperature Range Adjustment for Analog Lab Ovens

A calibration to the knob can be performed if the chamber temperature is off by 15 degrees Fahrenheit or more from the temperature number printed on the dial on models 20,30,and 40 GC/AF.

A temperature range adjustment can be performed to the oven when not able to reach lower or higher temperatures when set with the dial.

- ⚠ **Do not modify the oven to operate above the stated maximum operating temperature when adjusting the oven's temperature range.**
- ⚠ **Calibrate the dial at the most frequently used temperature using the oven's thermometer or measuring device known to be accurate.**

Understanding the Knob

For 10GC/AF model ovens, the numbers on the dial represent a power setting of 1 through 10. For all other models, the numbers represent a temperature in degrees °F (Fahrenheit) on the dial and °C (Celsius) on the back panel. (Fig A)

- ⚠ The numbers printed on the unit's dial are only to be used as a reference and do not represent an actual temperature inside the unit. Use the thermometer provided with the unit to obtain a true temperature from inside the oven.

Calibrating the dial

Follow the steps below to calibrate the oven's dial (printed) temperature to the temperature reading from inside the oven's chamber as measured by a known accurate device (models 20, 30, and 40 only).

STEP 1

Set the dial to the most frequently used temperature and allow the oven to achieve temperature stability. (FIG. B)

- ▶ **To adjust the temperature range, rotate the dial to the lowest or highest setting allowed by the dial before removing the knob.**

STEP 2

Using a 5/64" Allen Key, loosen the knob screw(s) and remove the knob from the oven. For models 20,30, and 40 remove the compression pin from the thermostat shaft as shown in (FIG. C).

STEP 3

Using a small blade screwdriver, adjust the trim screw in the shaft center to adjust the oven's temperature.

Make slight 1/8th turn adjustments at a time. Allow the oven's temperature to be stable before placing the knob.

- a) Turn the trim screw counter-clockwise to adjust the temperature UP.

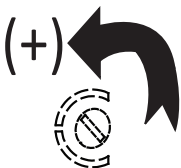

- b) Turn the trim screw clockwise to adjust the temperature DOWN.

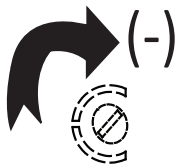

⚠ IMPORTANT

- Make sure the screw recessed in the shaft has moved after adjustment.
- Allow the temperature to settle before making any subsequent adjustments.

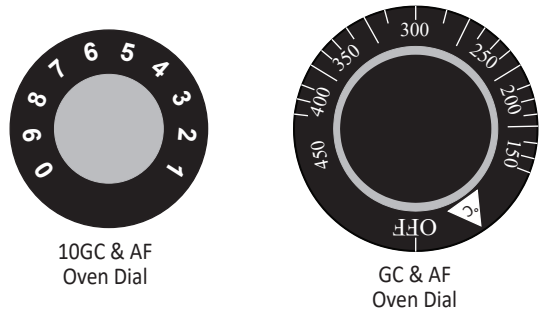

FIG. A

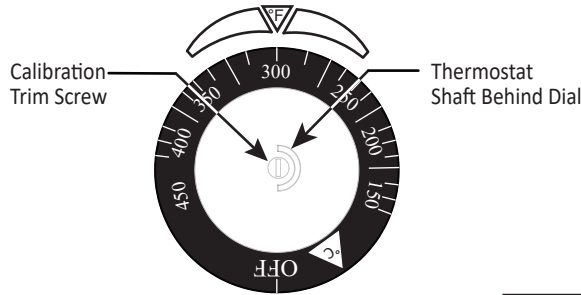

FIG. B

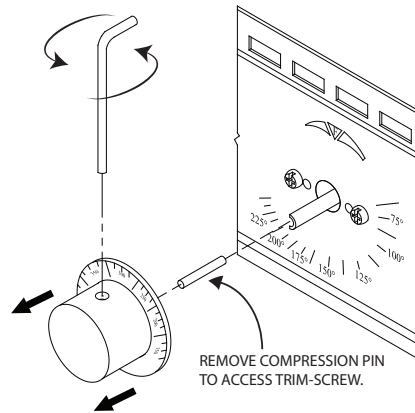

FIG. C

Technical Support

Email: information@quincylab.com
Voice: 800-482-4328 Opt 2