

Request
Quote

Weatherly #148
27.12 (Industrial)
February 2018

Supersedes 27.12 (Industrial) | November 2016



PEERLESS®

A KITO GROUP COMPANY

2018



Overhead
Lifting



Below-the-Hook &
Material Handling

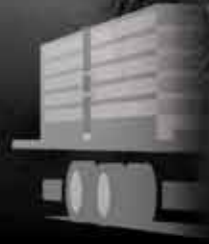

Cargo Control
Products



Hardware Chain
& Accessories



Marine Chain
& Accessories

Visit Us Online: www.peerlesschain.com | 800.873.1916



PEERLESS[®]
A **KITO** GROUP COMPANY

Peerless Industrial Group Inc., the Largest U.S. Chain Manufacturer

Peerless Industrial Group has been innovating successful products for 100 years. Today, as a worldwide provider of lifting solutions, utilizing our exceptional design, engineering, manufacturing, and quality teams, we continue to develop crucial products for the wide variety of markets we serve. Peerless is part of KITO Corporation's global network providing our customers access to overhead lifting, below-the-hook and material handling, cargo control, hardware, marine and traction products.

**PEERLESS, YOUR LINK TO QUALITY,
STRENGTH & SERVICE.**

The information and products found within this catalog are available and kept up-to-date on our website at **www.peerlesschain.com**. Please visit our website for additional information, to view our full line of products, for further technical information and safety guidelines, and to learn more about our company.

WEATHERLY #148
27.12 (INDUSTRIAL)
FEBRUARY, 2018
SUPERSEDES 27.12 (INDUSTRIAL)
NOVEMBER, 2016

Table of Contents

OVERHEAD LIFTING	04-44
BELOW-THE-HOOK	45-54
CARGO CONTROL	55-80
HARDWARE CHAIN	81-97
CHAIN ACCESSORIES	98-109
MISCELLANEOUS HARDWARE	110-122
MARINE	123-137
SAFETY GUIDELINES	138-149
INDEX	150-154



www.peerlesschain.com

Our Website Contains a Full Line of Chain
and Accessory Products Ready to View

OVERHEAD LIFTING

Grade 80 & 100 Alloy Chain	5-6
Chain Sling Information	7-13
Accoloy® Standard Magnet Chains	14
Component Reference	16-17
Oblong Master Links	18-20
Other Alloy Components	21, 24
Sub-Assemblies	22-23
Coupling Links	25
Sling Hooks	26-27
Grab Hooks	28-29
Foundry Hooks	30-31
Self-Locking Hooks	31-33
Replacement Parts	34-36
Shackles	36-37
Standard Alloy Components	38-39
Grade 50 Stainless Chain	40
316 Stainless Steel Components	41-43
Insulated Swivel Hook	44

MEETS INDUSTRY OVERHEAD LIFTING STANDARDS



OVERHEAD LIFTING APPROVED

Product (or products) with this symbol meet or exceed the overhead lifting industry required standards.



Alloy Chain

Peerless alloy chain is rugged, versatile, high-strength, low-weight chain manufactured from special analysis alloy steel. It is quenched and tempered before proof testing and the ultimate tensile strength is over twice that of ordinary steel chain.

G100 Alloy Chain

Similar to the Grade 80 chain, Grade 100 chain is commonly used for overhead lifting applications because of its excellent energy absorption properties, however, Grade 100 chain has the greatest strength to weight ratio of the alloy chains. Peerless Grade 100 chain and components meet the latest guidelines of the National Association of Chain Manufacturers (NACM), ASTM A952/A952M and ASTM A973/A973M. For fast identification, Peerless Grade 100 chain is embossed USA and stamped P10. **For quality control purposes, Peerless chain is date coded for easy traceability.**

Full Drum

Stock #	Trade Size		Wire Dia. (inches)	Inside Link Dim. (In.)		Ft. Per Drum	Net Wt. (Lbs.)	WLL	
	Inches	MM		Length (Nominal)	Width (Min)			Lbs.	Kgs.
5510223	9/32	7	0.279	0.870	0.405	800	616	4,300	1,950
5510323	5/16	8	0.332	1.010	0.480	500	560	5,700	2,585
5510423	3/8	10	0.404	1.226	0.560	500	760	8,800	3,992
5510623	1/2	13	0.529	1.570	0.750	300	836	15,000	6,804
5510823	5/8	16	0.641	1.988	0.902	200	757	22,600	10,251
5510923	3/4	20	0.812	2.417	1.139	100	629	35,300	16,012
5511023	7/8	22	0.906	2.660	1.260	100	766	42,700	19,368
5511123	1	26	1.062	3.092	1.420	50	505	59,700	27,079

Half Drum

Stock #	Trade Size		Wire Dia. (inches)	Inside Link Dim. (In.)		Ft. Per Drum	Net Wt. (Lbs.)	WLL	
	Inches	MM		Length (Nominal)	Width (Min)			Lbs.	Kgs.
5510224	9/32	7	0.279	0.870	0.405	400	308	4,300	1,950
5510324	5/16	8	0.332	1.010	0.480	250	280	5,700	2,585
5510424	3/8	10	0.404	1.226	0.560	250	380	8,800	3,992
5510624	1/2	13	0.529	1.570	0.750	150	418	15,000	6,804
5510824	5/8	16	0.641	1.988	0.902	100	379	22,600	10,251

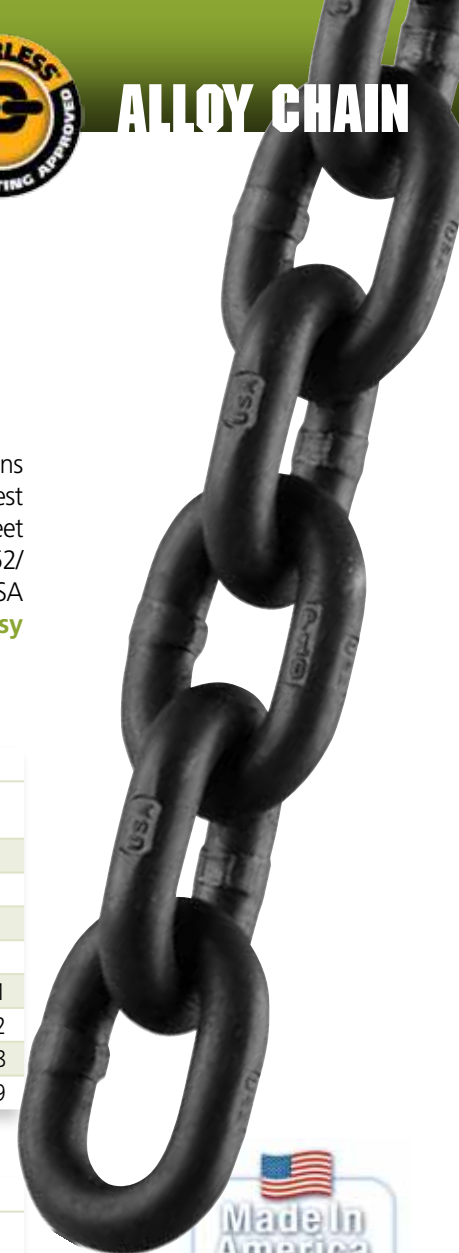

WHY CHOOSE GRADE 100 OVER GRADE 80?

- Grade 100 is on average a 25% greater Working Load Limit (WLL) over Grade 80.
- Users can experience more working power (WLL) with a smaller diameter chain based upon application.
- Grade 100 reduces the wear on the outer links from dragging on continuous contact with abrasive materials - and because Grade 100 is harder and more durable, inner link wear associated with normal use is reduced as well - which extends the life of the chain.
- Special chemistry and heat treating processes make Grade 100 our strongest chain option.



DO NOT EXCEED CAPACITY!
See the SAFETY GUIDELINES section before using these products. Pages 138-149.



Alloy Chain cont.

G80 Alloy Chain



Grade 80 chain is commonly used for overhead lifting applications because of its excellent energy absorption properties. Peerless Grade 80 chain meets the latest guidelines of the National Association of Chain Manufacturers (NACM) and ASTM A391/A391M. This is in line with the higher 4-to-1 design factor required by the International Standards Organization (ISO). For fast identification, Peerless Grade 80 chain is embossed USA and stamped P8. **For quality control purposes, Peerless chain is date coded for easy traceability.**

Full Drum

Stock #	Trade Size		Wire Dia. (inches)	Inside Link Dim. (In.)		Ft. Per Drum	Net Wt. (Lbs.)	WLL		
	Black	Inches		MM	Length (Nominal)			Width (Min)	Lbs.	Kgs.
5050223		9/32	7	0.279	0.827	0.405	800	610	3,500	1,588
5050323		5/16	8	0.310	0.945	0.480	500	457	4,500	2,041
5050423		3/8	10	0.392	1.182	0.560	500	737	7,100	3,221
5050623		1/2	13	0.516	1.535	0.750	300	743	12,000	5,443
5050823		5/8	16	0.630	1.890	0.902	200	725	18,100	8,210
5050923		3/4	20	0.781	2.420	1.140	100	575	28,300	12,837
5051023		7/8	22	0.906	2.660	1.260	100	766	34,200	15,513
5051123		1	26	1.032	2.900	1.420	50	505	47,700	21,636
5051223*		1-1/4	32	1.260	3.780	1.640	66	1023	72,300	32,795
5051323*		1-1/2	38	1.496	4.490	1.930	50	1045	99,000	44,906
5051423*		1-3/4	45	1.771	5.315	2.303	196	5978	126,000	57,153
5051523*		2	50	1.969	5.905	2.559	246	9260	160,000	72,575

*Sourced by Peerless Industrial Group

Half Drum

Stock #	Trade Size		Wire Dia. (inches)	Inside Link Dim. (In.)		Ft. Per Drum	Net Wt. (Lbs.)	WLL		
	Black	Inches		MM	Length (Nominal)			Width (Min)	Lbs.	Kgs.
5050224		9/32	7	0.279	0.827	0.405	400	305	3,500	1,588
5050324		5/16	8	0.310	0.945	0.480	250	229	4,500	2,041
5050424		3/8	10	0.392	1.182	0.560	250	369	7,100	3,221
5050624		1/2	13	0.516	1.535	0.750	150	372	12,000	5,443

LARGE DIAMETER CHAIN

With impressive lifting ranges of 100,000 to 454,600 lbs (3 and 4 leg slings), large diameter chain can be used for virtually any heavy lifting application. When Peerless developed their revolutionary 8 step manufacturing process, we didn't make any compromises. Our goal was to manufacturer the best quality large diameter chain in the market today. We have incorporated technology advances such as flash welding – the best and most consistent way to weld chain today. Great chain is a function of design as well. You will find the strength enhancing features of triple alloy with nickel, chromium, molybdenum and links with a single weld. When you consider all of these enhancements, plus the assurance of proof testing and certification, you will realize that Peerless large diameter alloy chain is tough enough to handle any lifting application.



DO NOT EXCEED CAPACITY!
See the SAFETY GUIDELINES section before using these products. Pages 138-149.

Chain Sling Working Load Limit Specifications

Use this table as a guide to determine which chain sizes and leg styles are best for your requirements. Using the maximum load (or loads) you will lift, and the angle of lift required – work to the left across this table to determine proper chain size for your sling. Working load limit of the chain and components is established as pounds applied at the indicated degrees from horizontal. The rated capacity of the sling must be based on the smallest horizontal angle. For angles not shown, use the next lower angle or have a qualified person calculate the rated load for the new angle. When using hooks in a shortening (grab) or choker application, the Working Load Limit (WLL) of the sling must be reduced by 20%.

Chain Size		Single Leg Sling	Double Leg Sling			Triple & Quad Leg Sling			
Inches	MM		90°	60°	45°	30°	60°	45°	30°
Grade 80									
7/32	6	2,100	3,600	3,000	2,100	5,500	4,400	3,200	
9/32	7	3,500	6,100	4,900	3,500	9,100	7,400	5,200	
5/16	8	4,500	7,800	6,400	4,500	11,700	9,500	6,800	
3/8	10	7,100	12,300	10,000	7,100	18,400	15,100	10,600	
1/2	13	12,000	20,800	17,000	12,000	31,200	25,500	18,000	
5/8	16	18,100	31,300	25,600	18,100	47,000	38,400	27,100	
3/4	20	28,300	49,000	40,000	28,300	73,500	60,000	42,400	
7/8	22	34,200	59,200	48,400	34,200	88,900	72,500	51,300	
1	26	47,700	82,600	67,400	47,700	123,900	101,200	71,500	
1-1/4	32	72,300	125,200	102,200	72,300	187,800	153,400	108,400	
1-1/2	38	100,000	173,200	141,400	100,000	259,800	212,100	150,000	
1-3/4	45	131,250	227,300	185,600	131,250	341,000	278,400	196,900	
2	50	175,000	303,100	247,500	175,000	454,600	371,200	262,500	
Grade 100									
7/32	6	2,700	4,700	3,800	2,700	7,000	5,700	4,000	
9/32	7	4,300	7,400	6,100	4,300	11,200	9,100	6,400	
5/16	8	5,700	9,900	8,100	5,700	14,800	12,100	8,500	
3/8	10	8,800	15,200	12,400	8,800	22,900	18,700	13,200	
1/2	13	15,000	26,000	21,200	15,000	39,000	31,800	22,500	
5/8	16	22,600	39,100	32,000	22,600	58,700	47,900	33,900	
3/4	20	35,300	61,100	49,900	35,300	91,700	74,900	53,000	
7/8	22	42,700	74,000	60,400	42,700	110,900	90,600	64,000	
1	26	59,700	103,200	84,200	59,600	154,800	126,400	89,300	
1-1/4	32	90,400	156,600	127,800	90,400	234,900	191,700	135,600	

DO NOT load an assembly in excess of the rated working load limits in the chart above.

DO NOT put an unequal load on one leg of a sling. Distribute the load evenly.

DO NOT expose assembly to impact, rapid lifts or sudden stops.

DO NOT tie knots or allow chains to become twisted.

DO NOT use chain that appears to be defective, worn or damaged.

DO NOT fasten chain over sharp corners or edges. Protect with padding.

DO NOT tip load hooks. The latch must NEVER support the load.

When using non-cradle or non-shortening grab hooks in a shortening or choker application, the Working Load Limit (WLL) of the sling must be reduced by 20%

Reference the **SAFETY GUIDELINES** section of this catalog for more information.



DO NOT EXCEED CAPACITY!
See the **SAFETY GUIDELINES** section before using these products. Pages 138-149.

Welded Chain Slings

Welded Chain Slings – the Traditional System

Welded chain slings are manufactured at our factory to your specifications to meet your lifting needs. Through the use of serial numbers, Peerless maintains full traceability of manufactured products should the welded chain sling require servicing or for inspection. The rated capacity of a sling cannot be altered since its welded construction prevents on site tampering.

Peerless welded chain slings are available with special attachments such as stirrup, plate, 'J' hooks, die pins and hooks, lifting tong, shackles and other custom devices. Contact us directly for information regarding a custom chain sling build to your specifications or complete the online form at www.peerlesschain.com/custom-order-forms/custom-chain-slings.

Peerless Chain Grades 80 and 100, Welded Chain Slings and Components meet or exceed all existing OSHA, Federal, NACM and ASTM (ASTM A906/A906M) chain specifications requirements.

Mechanical Chain Slings

Mechanical Chain Slings – the Flexible System

Mechanical Chain Slings save on costly down time since they can be repaired and altered on site. No more waiting for shipments. No more returning slings for factory repairs. Service is as close as your nearest Peerless distributor. Components are manufactured under rigid quality control standards and meet or exceed the capacity of Grade 80/100 chain.

MECHANICAL SLING ADVANTAGES

- Eliminates all protrusions and the possibility of catching or snagging.
- Exclusive Spirol retaining pins receive no load. These spring steel pins are used solely as a retention device.
- The clevis portion of the components act as a built in gauge and will accept only the proper chain link size.
- Every component has forged markings indicating the chain size to be used with it.

INFORMATION FOR CALCULATING CHAIN LENGTH

Single Leg Type: If the measurement comes within the link, the following link is cut. Reach given should be minimum.

2 Leg Type: The required chain length is measured and cut (same as single leg). The first and last links should lie in opposite planes – this allows hooks and attachments to point away from the load. Cut the second leg with the same number of links.

3 & 4 Leg Type: The cutting length is measured and number of links counted. Must be an odd number of links (due to secondary links on Master Link Assembly) so hooks hang on correct plane, pointing out. Chain lengths for additional legs are cut with the same number of links. If the reach is over five feet (1.52m), add the difference to the figures in "Cut Chain Length Needed for 5' Reach" column found in the tables on the next few pages. If reach is less than five feet (1.52m), subtract the difference. A metal tag showing the sling reach will be attached to the sling.

EXAMPLE: Required reach – 8 ft. (2.44m) | Sling type and size – CO 9/32" (7mm) chain | Add 3 feet (0.92m)(reach over 5' (1.52m)) to figure shown in chart under Type SOO – 9/32" (7mm) chain is 4' 1" (1.14m). | 7' 1" (2.16m) = cut chain length for 8' (2.44m) reach.



Alloy Chain Slings

Types of Chain Slings

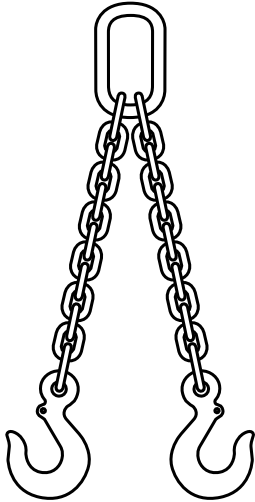

WELDED
(DOS)

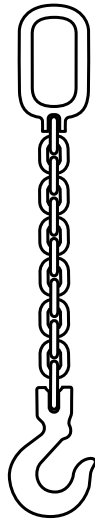

MECHANICAL
(SOS)

Attachments		
Type	One End	Opposite End
Single Chain Slings		
SOS	Oblong Link	Sling Hook
SOG	Oblong Link	Grab Hook
SGS	Grab Hook	Sling Hook
SGG	Grab Hook	Grab Hook
SSS	Sling Hook	Sling Hook
SOF	Oblong Link	Foundry Hook
SOO	Oblong Link	Oblong Link
Double Chain Slings		
DOS	Oblong Link	Sling Hooks
DOG	Oblong Link	Grab Hooks
DOF	Oblong Link	Foundry Hooks
Triple Chain Slings		
TOS	Oblong Link	Sling Hooks
TOG	Oblong Link	Grab Hooks
TOF	Oblong Link	Foundry Hooks
Quadruple Chain Slings		
QOS	Oblong Link	Sling Hooks
QOG	Oblong Link	Grab Hooks
QOF	Oblong Link	Foundry Hooks

Determining the Proper Chain Sling

To select the proper chain sling for lifting, the weight and configuration of the load to be lifted must first be determined. Then, the following information is needed.

- 1. TYPE:** According to the weight and configuration of the load, determine the type of chain sling required from the table above.
- 2. SIZE:** This is specified by the size of the material from which the chain is made, determined by working load limit required. Be sure to consider the angle of lift.
- 3. REACH:** This is the length, including attachments, from bearing point to bearing point.

When hot galvanizing is specified our recommended working load limits must be reduced. Please contact us with all such inquiries.



SOO

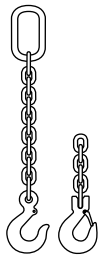

SOS or SOSH



SOG



SOF

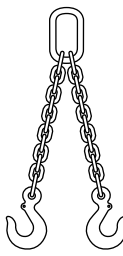

DOS

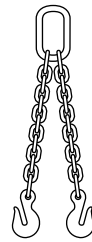

DOG

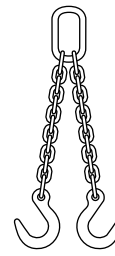

DOF

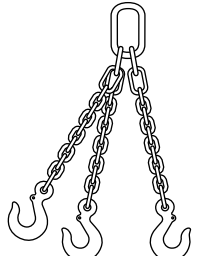

TOS

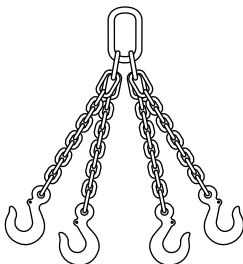

QOS



Adjustable Single

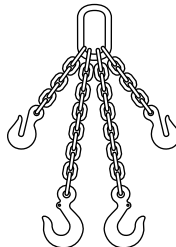

Adjustable Double



Single Endless Basket



Double Endless Basket



DO NOT EXCEED CAPACITY!
See the SAFETY GUIDELINES section before using these products. Pages 138-149.

OVERHEAD LIFTING

Mechanical Single Chain Slings

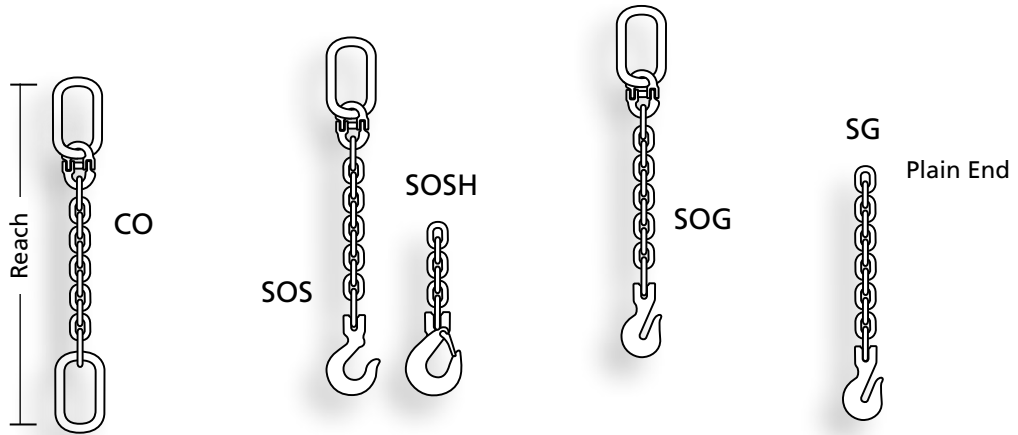

Size of Chain		WLL at 90° (Lbs.)	Oblong Master Link	Coupling Link	SOO/CO		SOS Sling Hooks SOSH Safety Hook			SOG Grab Hook		
Inch	MM				Cut Chain Needed for 5' Reach		Part #	Cut Chain Needed for 5' Reach		Part #	Cut Chain Needed for 5' Reach	
		*ft. - in.	Links	*ft. - in.	Links	*ft. - in.		Links				
9/32	7	4,300	8451000	8453100	4' - 1"	55	8418200	4' - 3"	58	8428200	4' - 5"	60
3/8	10	8,800	8451200	8453210	3' - 11"	37	8418400	4' - 2"	40	8428400	4' - 2"	40
1/2	13	15,000	8451300	8453300	3' - 8"	27	8418600	4'	30	8428610	4'	30
5/8	16	22,600	8451400	8453400	3' - 4"	19	8418700	3' - 9"	22	8428710	4' - 1"	24
3/4	20	35,300	8451500	8453510	3' - 3"	15	8418800	3' - 10"	18	8428810	3' - 10"	18
7/8	22	42,700	8451600	8453610	2' - 8"	11	8418900	3' - 5"	14	8428910	3' - 5"	14

*Cut Chain length is rounded to nearest inch.

Mechanical Double Chain Slings

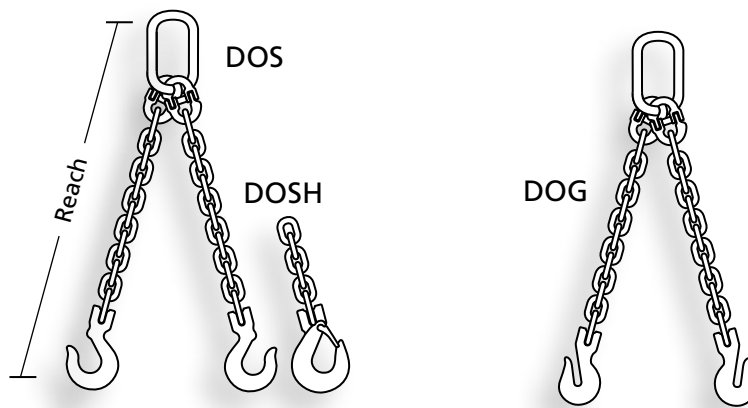

Size of Chain		WLL at 60° (Lbs.)	Oblong Master Link	Coupling Link	DOS Sling Hooks DOSH Safety Hook			DOG Grab Hook		
Inch	MM				Cut Chain Needed for 5' Reach		Part #	Cut Chain Needed for 5' Reach		Part #
		*ft. - in.	Links	*ft. - in.	Links	*ft. - in.		Links		
9/32	7	7,400	8451100	8453100	8418200	4' - 5"	58	8428200	4' - 5"	60
3/8	10	15,200	8451300	8453210	8418400	4'	38	8428400	4' - 2"	40
1/2	13	26,000	8451400	8453300	8418600	3' - 10"	28	8428610	4'	30
5/8	16	39,100	8451500	8453400	8418700	3' - 9"	22	8428710	3' - 9"	22
3/4	20	61,100	8451600	8453510	8418800	3' - 5"	16	8428810	3' - 5"	16
7/8	22	74,000	8451700	8453610	8418900	3' - 5"	14	8428910	3' - 5"	14

*Cut Chain length is rounded to nearest inch.



DO NOT EXCEED CAPACITY!
See the SAFETY GUIDELINES section before using these products. Pages 138-149.

CHAIN SLING INFORMATION

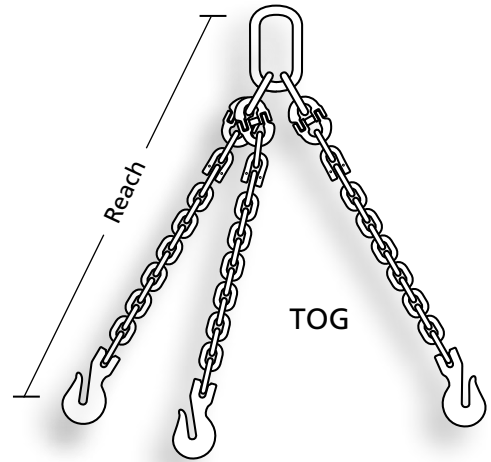
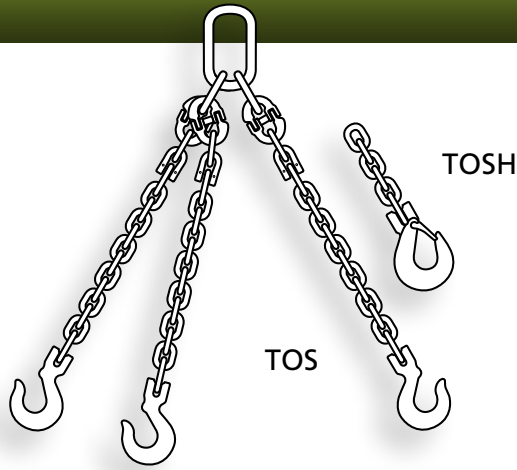

Mechanical Triple Chain Slings

Size of Chain		WLL at 60° (Lbs.)	Oblong Master Link w/ Sub-Assemblies (small sub-links)	Coupling Link	TOS Sling Hooks TOSH Safety Hook			TOG Grab Hook		
Inch	MM				Part #	Cut Chain Needed for 5' Reach		Part #	Cut Chain Needed for 5' Reach	
					Part #	*ft. - in.	Links	Part #	*ft. - in.	Links
9/32	7	11,200	8452110	8453100	8418200	4' - 1"	55	8428200	4' - 1"	55
3/8	10	22,900	8452310	8453210	8418400	3' - 8"	35	8428400	3' - 11"	37
1/2	13	39,000	8452410	8453300	8418600	3' - 5"	25	8428610	3' - 8"	27
5/8	16	58,700	8452510	8453400	8418700	3' - 3"	19	8428710	3' - 3"	19
3/4	20	91,700	8452610	8453510	8418800	2' - 10"	13	8428810	2' - 10"	13
7/8	22	110,900	8452710	8453610	8418900	2' - 8"	11	8428910	2' - 8"	11

*Cut Chain length is rounded to nearest inch.

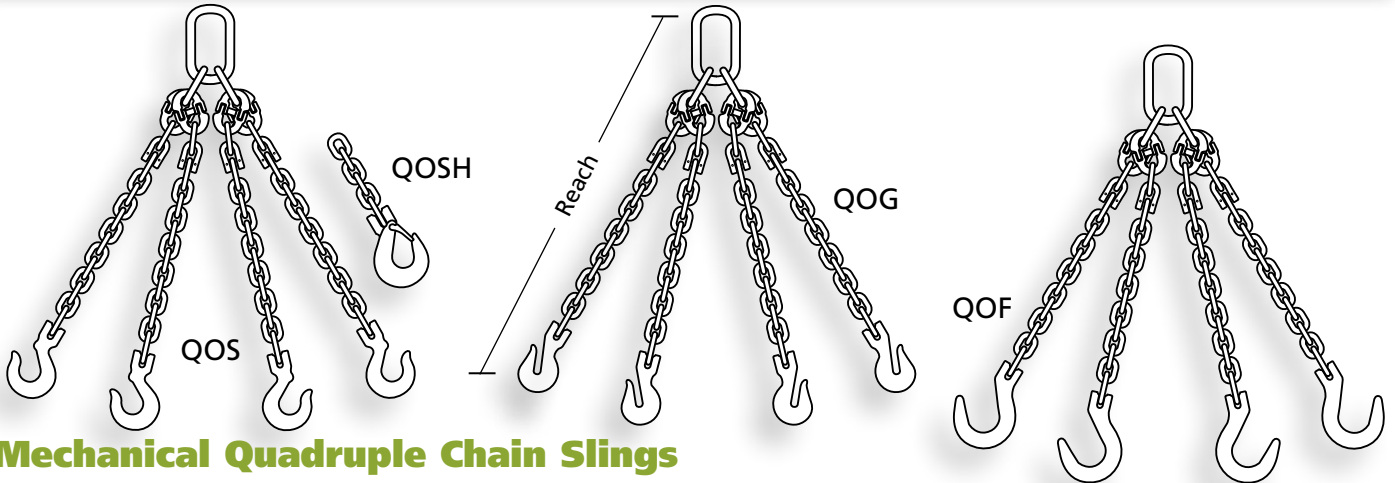

Mechanical Quadruple Chain Slings

Size of Chain		WLL at 60° (Lbs.)	Oblong Master Link w/ Sub-Assemblies (small sub-links)	Coupling Link	QOS Sling Hooks QOSH Safety Hook			QOG Grab Hook		
Inch	MM				Part #	Cut Chain Needed for 5' Reach		Part #	Cut Chain Needed for 5' Reach	
					Part #	*ft. - in.	Links	Part #	*ft. - in.	Links
9/32	7	11,200	8452110	8453100	8418200	4' - 1"	55	8428200	4' - 1"	55
3/8	10	22,900	8452310	8453210	8418400	3' - 8"	35	8428400	3' - 11"	37
1/2	13	39,000	8452410	8453300	8418600	3' - 5"	25	8428610	3' - 8"	27
5/8	16	58,700	8452510	8453400	8418700	3' - 3"	19	8428710	3' - 3"	19
3/4	20	91,700	8452610	8453510	8418800	2' - 10"	13	8428810	2' - 10"	13
7/8	22	110,900	8452710	8453610	8418900	2' - 8"	11	8428910	2' - 8"	11

*Cut Chain length is rounded to nearest inch.



DO NOT EXCEED CAPACITY!
See the SAFETY GUIDELINES section before using these products. Pages 138-149.

OVERHEAD LIFTING

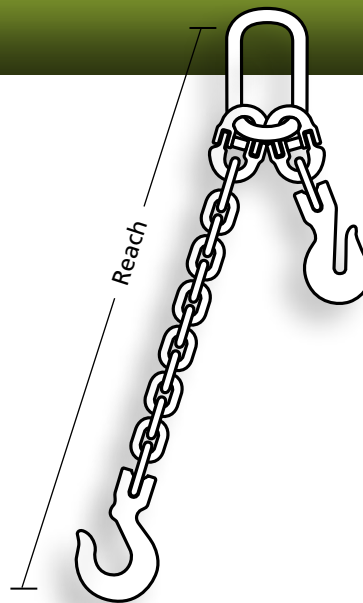

ASOS
Style 1: No chain on short leg
 (Grab hook only)

Mechanical Adjustable Single Slings

Size of Chain		WLL at 90° (Lbs.)	Oblong Master Link	Coupling Link	Grab Hook	Sling Hook	Cut Chain Needed for 5' Reach	
Inch	MM						*ft. - in.	Links
9/32	7	4,300	8451000	8453100	8428200	8418200	4' - 3"	58
3/8	10	8,800	8451200	8453210	8428400	8418400	4' - 2"	40
1/2	13	15,000	8451300	8453300	8428610	8418600	4'	30
5/8	16	22,600	8451400	8453400	8428710	8418700	3' - 9"	22
3/4	20	35,300	8451500	8453510	8428810	8418800	3' - 10"	18
7/8	22	42,700	8451600	8453610	8428910	8418900	3' - 5"	14

*Cut Chain length is rounded to nearest inch.

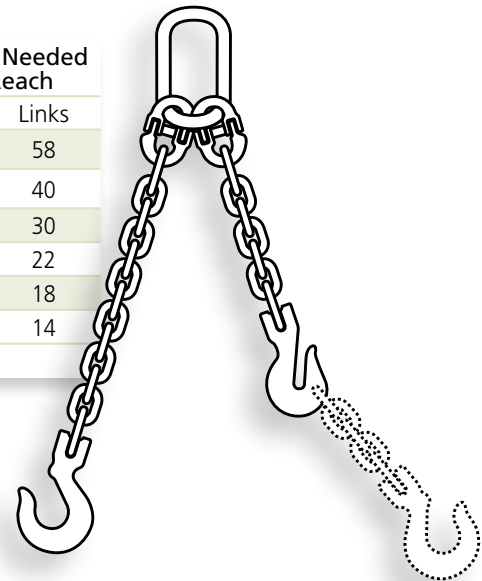

ASOS
Style 2: One foot chain on
 short leg (plus grab hook)

Mechanical Adjustable Double Slings

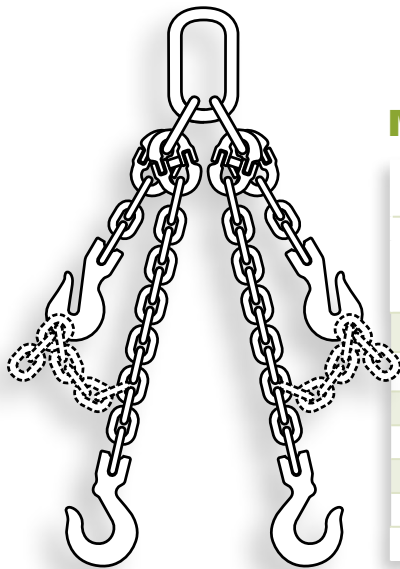

ADOS

Size of Chain		WLL at 60° (Lbs.)	Oblong Master Link w/ Sub- Assemblies (small sub- links)	Coupling Link	Grab Hook	Safety Hook or Sling Hook	Cut Chain Needed for 5' Reach (Per Leg)	
Inch	MM						*ft. - in.	Links
9/32	7	7,400	8452100	8453100	8428200	8418200	4' - 5"	58
3/8	10	15,200	8452300	8453210	8428400	8418400	4'	38
1/2	13	26,000	8452400	8453300	8428610	8418600	3' - 10"	28
5/8	16	39,100	8452500	8453400	8428710	8418700	3' - 9"	22
3/4	20	61,100	8452600	8453510	8428810	8418800	3' - 5"	16
7/8	22	74,000	8452700	8453610	8428910	8418900	3' - 5"	14

*Cut Chain length is rounded to nearest inch.



DO NOT EXCEED CAPACITY!
 See the SAFETY GUIDELINES section before using these products. Pages 138-149.

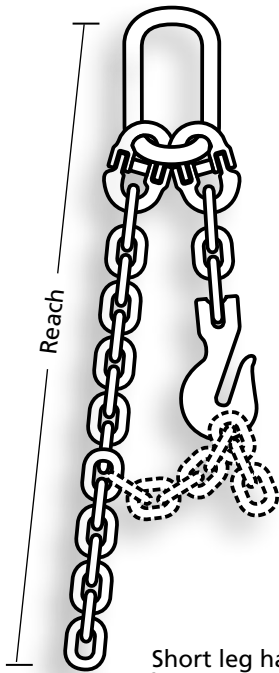

Short leg has one foot of chain & a Grab Hook.

Mechanical Adjustable Single Loop Slings

Size of Chain		WLL at 60° (Lbs.)	Oblong Master Link	Coupling Link	Grab Hook	Sling Hook	Cut Chain Needed for 5' Reach	
Inch	MM						*ft. - in.	Links
9/32	7	7,400	8451100	8453100	8428200	8418200	4' - 5"	58
3/8	10	15,200	8451300	8453210	8428400	8418400	4'	38
1/2	13	26,000	8451400	8453300	8428610	8418600	3' - 10"	28
5/8	16	39,100	8451500	8453400	8428710	8418700	3' - 9"	22
3/4	20	61,100	8451600	8453510	8428810	8418800	3' - 5"	16
7/8	22	74,000	8451700	8453610	8428910	8418900	3' - 5"	14

*Cut Chain length is rounded to nearest inch.

Mechanical Adjustable Double Loop Slings

Size of Chain		WLL at 60° (Lbs.)	Oblong Master Link w/ Sub-Assemblies (small sub-links)	Coupling Link	Grab Hook	Safety Hook or Sling Hook	Cut Chain Needed for 5' Reach	
Inch	MM						*ft. - in.	Links
9/32	7	11,200	8452110	8453100	8428200	8418200	4'	54
3/8	10	22,900	8452310	8453210	8428400	8418400	3' - 9"	36
1/2	13	39,000	8452410	8453300	8428610	8418600	3' - 6"	26
5/8	16	58,700	8452510	8453400	8428710	8418700	3' - 1"	18
3/4	20	91,700	8452610	8453510	8428810	8418800	2' - 7"	12
7/8	22	110,900	8452710	8453610	8428910	8418900	2' - 6"	10

*Cut Chain length is rounded to nearest inch.

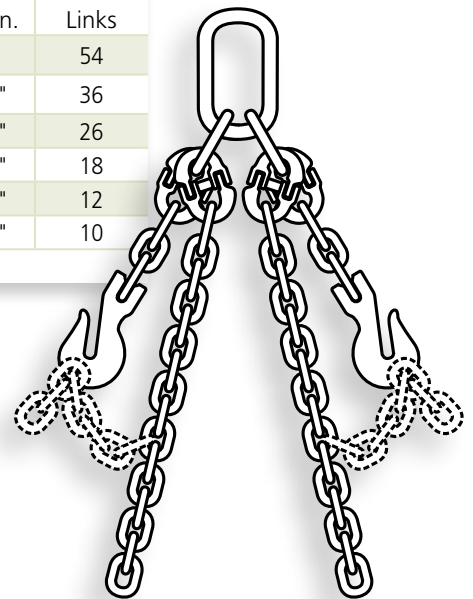

Short leg has one foot of chain & a Grab Hook.



DO NOT EXCEED CAPACITY!
See the SAFETY GUIDELINES section before using these products. Pages 138-149.



Accoloy® Standard Magnet Chains

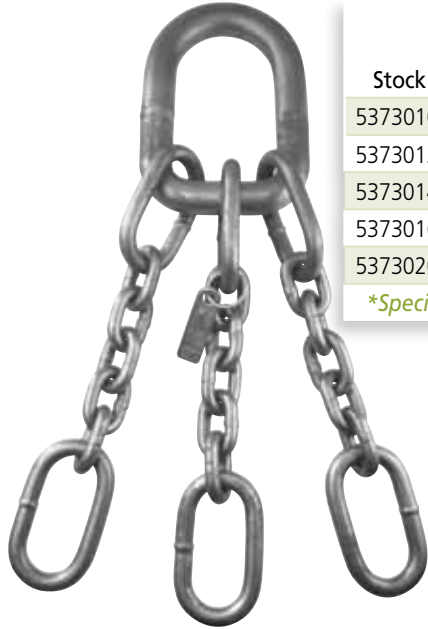

Stock #	Chain Size		Master Link Dimensions (Inches)			Sublink Dimensions (Inches)			*Reach (5 Links)	Magnet Dia.	Lbs. Per Ea.	WLL (Lbs.) @ 60°
	Inch	MM	A	B	C	A	B	C				
537301000	5/8	16	1.750	6.000	10.000	0.875	2.250	5.500	30.625	up to 40	46	47,000
537301200	3/4	20	2.000	6.000	10.000	1.000	2.500	6.000	34.000	up to 45	66	73,500
537301400	7/8	22	2.250	6.500	11.500	1.000	2.500	6.000	36.875	up to 48	90	88,900
537301600	1	26	2.250	6.500	11.500	1.250	3.000	7.000	40.000	up to 60	122	123,900
537302000	1-1/4	32	2.500	6.500	12.750	1.500	3.000	7.000	45.500	60 & over	194	187,800

*Special order reaches available

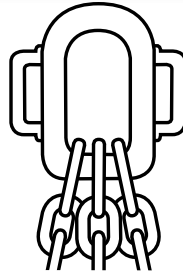

Handles Optional

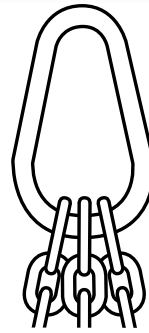

Pear Shaped Master Link Optional

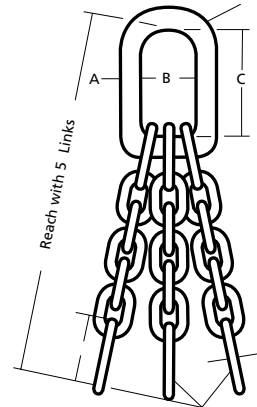

Accoloy® Steady-Lift Magnetic Chains (3 Point Suspension)

Stock #	Chain Size		Dimensions (Inches)						# of Links	Magnet Dia. (Inches)	Lbs. Per Each	WLL (Lbs.)
	Inch	MM	A	B	C	D (Reach)	E	F				
537101600	1	26	2.250	7.000	12.000	43.000	3.000	7.000	5	up to 60	235	100,000
537102000	1-1/4	32	2.500	7.000	12.000	55.000	3.000	7.000	7	60 and over	375	150,000

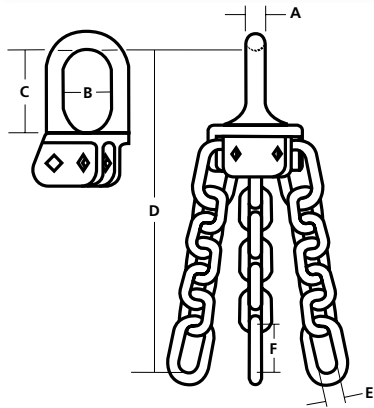

Eliminates Costly Down Time With Lift After Lift, Built-In Dependability.

- **Ease of Use** - Designed so bail stands up while chain rests on floor, there is no wrestling with the bail for hook-up.
- **Balanced Loading** - Three point suspension offers superior stability.
- **Wearability** - Engineered and built for increased service life, with heat treated bail, pins, alloy chain and end links.
- **Less Down Time** - Easy inspection, replaceable pins, legs and bail mean more time on the job and fewer off-site repairs.

Replacement Parts

Magnet Chain Size (inches)	Pin	Leg	Yoke
1	537101630	537101620	537101610
1-1/4	537102030	537102020	537102010



DO NOT EXCEED CAPACITY!
See the SAFETY GUIDELINES section before using these products. Pages 138-149.



PEERLESS
A KITO GROUP COMPANY

THE INDUSTRY LEADER IN

WELDED CHAIN SLINGS

Welded Chain Slings are fabricated to meet your specific lifting needs.

Options include:

- Sling Type – Single, Double, Triple, Quad or Adjustable.
- Chain Grade & Size – 100 (9/32" – 1"), 80 (9/32" – 2"), 63 (9/32" – 1"), Normalized Proof Coil (for acid dip pickling applications), Inconel, Nitronic 50, Monel 400, Carpenter 20/Alloy 20 and Stainless steels: 316, 304, 308.
- Attachments*

Every welded chain sling is registered and documented for inspection. Mechanical chain slings available on request with similar options. All chain slings are proof tested, tagged and test cert provided. Inspection and repair service also available.

Common Attachments* may include:

Standard sling, grab and foundry hooks, foundry sorting hooks or other custom bent attachments.



OVERHEAD LIFTING

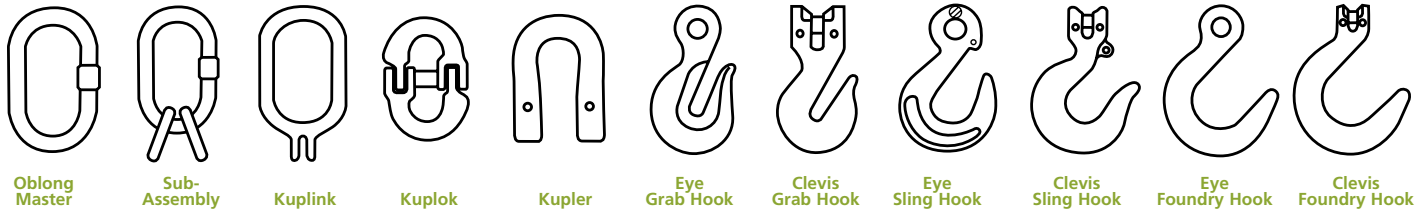

Accoloy® Kuplex® Component Reference

Single Leg Chain Slings

Chain Size	Oblong Master	Kuplink®	Kupler®	Eye Grab Hook	Clevis Grab Hook	Eye Sling Hook	Clevis Sling Hook	Eye Foundry Hook	Clevis Foundry Hook
9/32	598350001††	598350011††	---	592252072††	598750072††	592353080††	598850080††	592454498††	598250498††
3/8	598350002††	598350012††	---	592252073††	598750073††	592353081††	598850081††	592454499††	598250499††
1/2	598350003††	598350013††	---	592252075††	598750075††	592353082††	598850082††	592454500††	598250500††
5/8	598350003††	598350014††	---	592252076††	598750076††	592353083††	598850083††	592454501††	598250501††
3/4	598350004††	598300015†	---	592202077†	598700077†	592303084†	598800084†	592404502†	598200502†
7/8	598350005	---	598100025†	592202078†	598700078†	592303085†	598800085†	592404503†	598200503†
1	598310006	---	599100026	592202079†	---	592303086†	598800086	592404504†	---
1-1/4	598300030	---	599100028	592202051†	---	592303088†	---	592404505†	---

Double Leg Chain Slings

Chain Size	Oblong Master	Kuplink®	Kupler®	Eye Grab Hook	Clevis Grab Hook	Eye Sling Hook	Clevis Sling Hook	Eye Foundry Hook	Clevis Foundry Hook
9/32	598350001††	594200400†	598150020†	592252072††	598750072††	592353080††	598850080††	592454498††	598250498††
3/8	598350002††	594200601††	598150021†	592252073††	598750073††	592353081††	598850081††	592454499††	598250499††
1/2	598350003††	594200801†	598150022†	592252075††	598750075††	592353082††	598850082††	592454500††	598250500††
5/8	598350004††	594201001†	598150023†	592252076††	598750076††	592353083††	598850083††	592454501††	598250501††
3/4	598350005	594201201†	598100024†	592202077†	598700077†	592303084†	598800084†	592404502†	598200502†
7/8	598310006	---	598100025†	592202078†	598700078†	592303085†	598800085†	592404503†	598200503†
1	598300030	---	599100026	592202079†	---	592303086†	598800086	592404504†	---
1-1/4	598300034	---	599100028	592202051†	---	592303088†	---	592404505†	---

Triple & Quad Leg Chain Slings

Chain Size	Sub Assemblies	Kuplok®	Kupler®	Eye Grab Hook	Clevis Grab Hook	Eye Sling Hook	Clevis Sling Hook	Eye Foundry Hook	Clevis Foundry Hook
9/32	599450401	594200400†	598150020†	592252072††	598750072††	592353080††	598850080††	592454498††	598250498††
3/8	599450601	594200601†	598150021†	592252073††	598750073††	592353081††	598850081††	592454499††	598250499††
1/2	599450801	594200801†	598150022†	592252075††	598750075††	592353082††	598850082††	592454500††	598250500††
5/8	599451001	594201001†	598150023†	592252076††	598750076††	592353083††	598850083††	592454501††	598250501††
3/4	599401201	594201201†	598100024†	592202077†	598700077†	592303084†	598800084†	592404502†	598200502†
7/8	599401401	---	598100025†	592202078†	598700078†	592303085†	598800085†	592404503†	598200503†
1	599401601	---	599100026	592202079†	---	592303086†	598800086	592404504†	---
1-1/4	599402001	---	599100028	592202051†	---	592303088†	---	592404505†	---

Values not specially marked are Grade 63.

† Values shown for these sizes are Grade 80.

†† Values shown for these sizes are Grade 100.



Single Sling



Double Sling

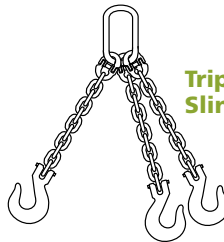

Triple Sling



Quadruple Sling



WARNING

DO NOT EXCEED CAPACITY!
See the SAFETY GUIDELINES section before using these products. Pages 138-149.

COMPONENT REFERENCE

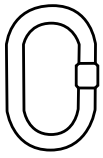

Oblong Master

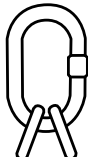

Sub-Assembly



Coupling Link



Eye Grab Hook



Clevis Grab Hook



Eye Sling Hook



Clevis Sling Hook



Eye Foundry Hook

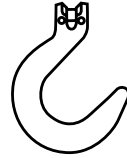

Clevis Foundry Hook

V10™ Component Reference (Grade 100)

Single Leg Chain Slings

Chain Size		Oblong Master	Coupling Link	Eye Grab Hook	Clevis Grab Hook	Clevis Grab w/ Safety Pin	Eye Grab w/ Clevis Attachment	Eye Sling Hook	Clevis Sling Hook	Eye Foundry Hook	Eye Self-Locking Hook	Clevis Self-Locking Hook	Swivel Self-Locking Hook	Swivel Self-Locking Hook w/ Bearing
In.	MM													
7/32	6	8451000	8452900	8427100	8428100	8429100	8420100	8417100	8418100	-	8497100	8498100	8499100	8491100
9/32	7	8451000	8453100	8427200	8428200	8429200	8420200	8417200	8418200	8477200	8497200	8498200	8499200	8491200
5/16	8	8451100	8453000	8427200	8428200	8429200	8420200	8417200	8418200	8477200	8497200	8498200	8499200	8491200
3/8	10	8451200	8453210	8427400	8428400	8429400	8420400	8417400	8418400	8477400	8497400	8498400	8499400	8491400
1/2	13	8451300	8453300	8427600	8428610	8429620	8420600	8417600	8418600	8477600	8497600	8498600	8499600	8491600
5/8	16	8451400	8453400	8427700	8428710	8429720	8420700	8417700	8418700	8477700	8497700	8498800	8499700	8491700
3/4	20	8451500	8453510	8427800	8428810	-	-	8417800	8418800	8477800	-	-	-	-
7/8	22	8451600	8453610	8427900	8428910	-	-	8417900	8418900	-	-	-	-	-

Double Leg Chain Slings

Chain Size		Oblong Master	Coupling Link	Eye Grab Hook	Clevis Grab Hook	Clevis Grab w/ Safety Pin	Eye Grab w/ Clevis Attachment	Eye Sling Hook	Clevis Sling Hook	Eye Foundry Hook	Eye Self-Locking Hook	Clevis Self-Locking Hook	Swivel Self-Locking Hook	Swivel Self-Locking Hook w/ Bearing
In.	MM													
7/32	6	8451000	8452900	8427100	8428100	8429100	8420100	8417100	8418100	-	8497100	8498100	8499100	8491100
9/32	7	8451100	8453100	8427200	8428200	8429200	8420200	8417200	8418200	8477200	8497200	8498200	8499200	8491200
5/16	8	8451200	8453000	8427200	8428200	8429200	8420200	8417200	8418200	8477200	8497200	8498200	8499200	8491200
3/8	10	8451300	8453210	8427400	8428400	8429400	8420400	8417400	8418400	8477400	8497400	8498400	8499400	8491400
1/2	13	8451400	8453300	8427600	8428610	8429620	8420600	8417600	8418600	8477600	8497600	8498600	8499600	8491600
5/8	16	8451500	8453400	8427700	8428710	8429720	8420700	8417700	8418700	8477700	8497700	8498800	8499700	8491700
3/4	20	8451600	8453510	8427800	8428810	-	-	8417800	8418800	8477800	-	-	-	-
7/8	22	8451700	8453610	8427900	8428910	-	-	8417900	8418900	-	-	-	-	-

Triple & Quad Leg Chain Slings

Chain Size		Sub Assemblies			Eye Grab Hook	Clevis Grab Hook	Clevis Grab w/ Safety Pin	Eye Grab w/ Clevis Attachment	Eye Sling Hook	Clevis Sling Hook	Eye Foundry Hook	Eye Self-Locking Hook	Clevis Self-Locking Hook	Swivel Self-Locking Hook	Swivel Self-Locking Hook w/ Bearing
In.	MM	Sm. Sub-Links	Lg. Sub-Links	Coupling Link											
		7/32	6	8452110	8452100	8452900	8427100	8428100	8429100	8420100	8417100	8418100	-	8497100	8498100
9/32	7	8452110	8452100	8453100	8427200	8428200	8429200	8420200	8417200	8418200	8477200	8497200	8498200	8499200	8491200
5/16	8	8452210	8452200	8453000	8427200	8428200	8429200	8420200	8417200	8418200	8477200	8497200	8498200	8499200	8491200
3/8	10	8452310	8452300	8453210	8427400	8428400	8429400	8420400	8417400	8418400	8477400	8497400	8498400	8499400	8491400
1/2	13	8452410	8452400	8453300	8427600	8428610	8429620	8420600	8417600	8418600	8477600	8497600	8498600	8499600	8491600
5/8	16	8452510	8452500	8453400	8427700	8428710	8429720	8420700	8417700	8418700	8477700	8497700	8498800	8499700	8491700
3/4	20	8452610	8452600	8453510	8427800	8428810	-	-	8417800	8418800	8477800	-	-	-	-
7/8	22	8452710	8452700	8453610	8427900	8428910	-	-	8417900	8418900	-	-	-	-	-

All components are Grade 100.



Single Sling



Double Sling



Triple Sling

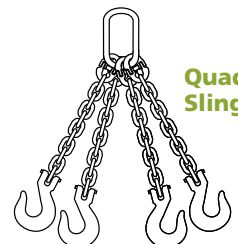

Quadruple Sling



DO NOT EXCEED CAPACITY!
See the SAFETY GUIDELINES section before using these products. Pages 138-149.



Oblong Master Links

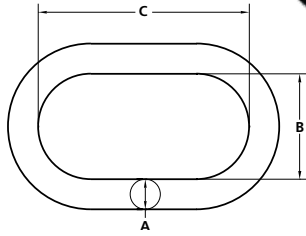

Peerless® Oblong Master Links

- Made in USA
- Welded & Forged Oblong Master Links
- Quenched and tempered
- Alloy steel with either a self-colored or powder coated finish
- Proof tested per ASTM A952 with fixtures sized to prevent localized point loading
- Each FORGED* link marked with the following:
 - USA
 - Peerless "P" logo
 - Traceability & heat code
 - A10 Designating Grade 100
 - Manufacturer's mark
 - Angle indicators at 45° from vertical

Stock #		Trade Size		Forged or Welded	Dimensions (Inches)			Lbs. Per Each	Working Load Limit (Lbs.)	Proof Load (Lbs.)
Self Colored	Painted	Inches	MM		A	B	C			
OMA041	---	13/32	10	Welded	0.41	1.50	3.00	0.3	3,600	7,200
8810005	8810003	1/2	13	Forged*	0.58	2.54	5.01	1.1	7,400**	17,200
8810015	8810014	3/4	19	Forged*	0.76	3.04	6.01	2.9	15,200**	35,200
8810025	8810024	1	26	Forged*	1.01	4.04	8.01	5.6	26,000**	60,000
8810030	8810029	1-1/4	32	Forged*	1.34	5.50	9.50	11.6	39,100**	90,400
8810035	8810034	1-1/2	38	Forged*	1.60	5.90	10.50	18.2	61,100**	141,200
8810040	8810039	1-3/4	44	Forged*	1.75	6.00	12.00	24.9	84,900**	196,000
OMA200	OMA200P	2	50	Welded	2.00	7.00	14.00	37.0	88,900	177,800
OMA225	OMA225P	2-1/4	57	Welded	2.25	8.00	16.00	63.0	125,200	250,400
OMA250	OMA250P	2-1/2	63	Welded	2.50	8.00	16.00	67.7	147,300	294,600
OMA275	OMA275P	2-3/4	70	Welded	2.75	9.00	16.00	83.7	187,800	375,600

**Ultimate load meets ASTM A952 specifications, based on a single leg sling at 90° or a double leg sling at 60° from horizontal.

For use with G80 & G100 Alloy Chain Slings

Stock #		Trade Size		Forged or Welded	Dimensions (Inches)			Chain Dia		Single Leg Working Load Limit (lbs)		Double Leg Working Load Limit @ 60° (lbs)		Lbs. Per Each
Self Colored	Painted	Inches	MM		A	B	C	Inch	MM	G80	G100	G80	G100	
8810005	8810003	1/2	13	Forged*	0.58	2.54	5.01	7/32	5.5	2,100	3,100	3,600	4,700	1.1
								9/32	7	3,500	4,300	6,100	7,400	
								5/16	8	4,500	5,700	---	---	
8810015	8810014	3/4	19	Forged*	0.76	3.04	6.01	5/16	8	4,500	5,700	7,800	9,900	2.9
								3/8	10	7,100	8,800	12,300	15,200	
								1/2	13	12,000	15,000	---	---	
8810025	8810024	1	26	Forged*	1.01	4.04	8.01	1/2	13	12,000	15,000	20,800	26,000	5.6
								5/8	16	18,100	22,600	---	---	
								5/8	16	18,100	22,600	31,300	39,100	
8810030	8810029	1-1/4	32	Forged*	1.34	5.50	9.50	3/4	20	28,300	35,300	-	-	11.6
								3/4	20	28,300	35,300	49,000	61,100	
								7/8	23	34,200	42,700	---	---	
8810035	8810034	1-1/2	38	Forged*	1.60	5.90	10.50	7/8	23	34,200	42,700	59,200	74,000	18.2
								1	26	47,700	59,700	---	---	
								1	26	47,700	59,700	---	---	
8810040	8810039	1-3/4	44	Forged*	1.75	6.00	12.00	1-1/4	32	72,300	---	---	---	24.9
								1-1/4	32	72,300	---	---	---	
OMA200	---	2	51	Welded	2.00	7.00	14.00	1	26	47,700	---	82,600	---	46.5
								1-1/4	32	72,300	---	---	---	
OMA225	---	2-1/4	57	Welded	2.25	8.00	16.00	1-1/4	32	72,300	---	125,200	---	63.0



DO NOT EXCEED CAPACITY!
See the SAFETY GUIDELINES section before using these products. Pages 138-149.



OBLONG MASTER LINKS

V10™ Alloy (Grade 100)

Stock #	Blue	Mfr. #	Trade Size		Dimensions (Inches)			Lbs. Per Each	Grade 100 Chain Size (Inches)	Working Load Limit 2 Leg Chain Sling @ 60°
			Inches	MM	A	B	C			
8451000		D13	1/2	13	0.512	2.362	4.331	0.8	7/32	4,700
8451100		D16	5/8	16	0.630	2.362	4.331	1.2	9/32	7,400
8451200		D18	3/4	18	0.748	2.953	5.315	2.0	5/16	9,900
8451300		D22	7/8	22	0.906	3.543	6.299	3.5	3/8	15,200
8451400		D26	1	26	1.063	3.937	7.087	5.5	1/2	26,000
8451500		D32	1-1/4	32	1.299	4.331	7.874	9.3	5/8	39,100
8451600		D38	1-1/2	38	1.496	5.906	10.827	16.5	3/4	61,100
8451700		D45	1-3/4	45	1.772	7.087	13.386	28.3	7/8	74,000
8451800		D50	2	50	1.969	7.480	13.780	36.4	1	103,400
8451900		D60	2-1/4	60	2.362	7.874	15.748	59.5	1-1/4	156,600

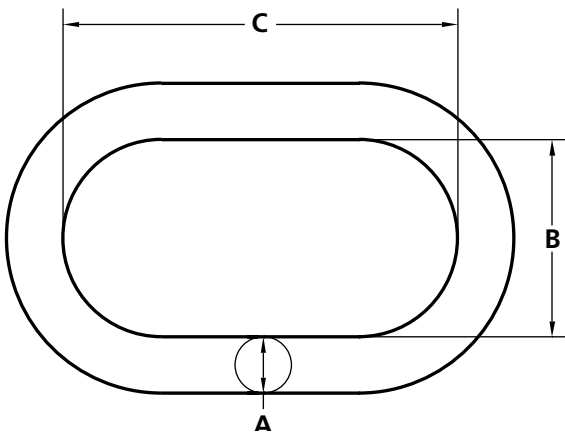

DO NOT EXCEED CAPACITY!
See the SAFETY GUIDELINES section before using these products. Pages 138-149.

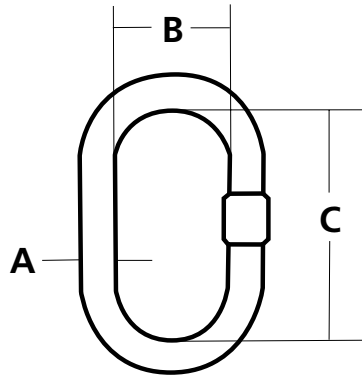

Oblong Master Links cont.

Accoloy® Kuplex®

Stock #		Trade Size		Forged or Welded	Dimensions (Inches)			Lbs. Per Each	Working Load Limit (Lbs.)	Proof Load (Lbs.)
Self Colored	Painted	Inches	MM		A	B	C			
598300047	598350001	5/8	16	Forged	0.63	3.00	6.00	1.4	7,400	17,200
598300048	598350002	3/4	19	Forged	0.75	3.00	6.00	2.5	15,200	35,200
598300049	598350003	1	26	Forged	1.00	3.50	7.00	5.3	26,000	60,000
598300052	598350004	1-1/4	32	Forged	1.25	4.00	8.00	8.6	39,100	90,400
598300022	598350005	1-1/2	38	Welded	1.50	6.00	12.00	18.0	58,700	135,600
598300025	598310006	1-3/4	44	Welded	1.75	6.00	12.00	25.0	73,500	169,800
598300030	---	2	51	Welded	2.00	7.00	14.00	38.0	88,900	205,800
598300034	---	2-1/4	57	Welded	2.25	8.00	16.00	58.0	125,200	289,200
598300038	---	2-1/2	63	Welded	2.50	8.00	16.00	74.0	135,000	270,000
598300036	---	2-3/4	70	Welded	2.75	9.00	16.00	92.0	164,400	375,600

For use with G80 & G100 Alloy Chain Slings

Stock #		Trade Size		Forged or Welded	Dimensions (Inches)			Chain Dia		Single Leg Working Load Limit (lbs)		Double Leg Working Load Limit @ 60° (lbs)		Lbs. Per Each
Self Colored	Painted	Inches	MM		A	B	C	Inch	MM	G80	G100	G80	G100	
598300047	598350001	5/8	16	Forged	0.63	3.00	6.00	7/32	5.5	2,100	3,100	3,600	4,700	1.4
								9/32	7	3,500	4,300	6,100	7,400	
								5/16	8	4,500	5,700	-	-	
598300048	598350002	3/4	19	Forged	0.75	3.00	6.00	5/16	8	4,500	5,700	7,800	9,900	2.5
								3/8	10	7,100	8,800	12,300	15,200	
598300049	598350003	1	26	Forged	1.00	3.50	7.00	1/2	13	12,000	15,000	20,800	26,000	5.3
								5/8	16	18,100	22,600	-	-	
598300052	598350004	1-1/4	32	Forged	1.25	4.00	8.00	5/8	16	18,100	22,600	31,300	39,100	8.6
								3/4	20	28,300	35,300	-	-	
598300022	598350005	1-1/2	38	Welded	1.50	6.00	12.00	3/4	20	28,300	35,300	49,000	-	18.0
								7/8	23	34,200	42,700	-	-	
598300025	598310006	1-3/4	44	Welded	1.75	6.00	12.00	7/8	23	34,200	-	59,200	-	25.0
								1	26	47,700	-	-	-	
598300030	-	2	51	Welded	2.00	7.00	14.00	1	26	47,700	-	82,600	-	38.0
								1-1/4	32	72,300	-	-	-	
598300034	-	2-1/4	57	Welded	2.25	8.00	16.00	1-1/4	32	72,300	-	125,200	-	58.0



DO NOT EXCEED CAPACITY!
See the SAFETY GUIDELINES section before using these products. Pages 138-149.



OTHER ALLOY COMPONENTS



Peerless® Alloy Pear Shape Master Links

Alloy components are 8620 or 4130 alloy steel. Master links are welded, heat-treated, proof tested and tumble finished.

Stock #	Trade Size		Dimensions (Inches)				Lbs. Per Each	Working Load Limit (Lbs.)
	Inches	MM	D	E	F	G		
Self-Colored								
PMA050	1/2	13	0.500	1.500	3.000	6.000	1.00	4,100
PMA063	5/8	16	0.630	1.500	3.000	6.000	1.46	6,600
PMA075	3/4	20	0.750	1.750	3.000	6.000	2.20	13,200
PMA100	1	26	1.000	2.500	4.000	8.000	5.10	22,500
PMA125	1-1/4	32	1.250	3.000	6.000	9.000	9.50	32,500
PMA150	1-1/2	38	1.500	5.500	7.000	10.500	16.36	49,000
PMA175	1-3/4	45	1.750	4.000	7.000	12.000	24.40	73,500
PMA200	2	50	2.000	4.000	7.000	14.000	42.25	88,900

*NAS specification Pear Shape Master Links available upon request.

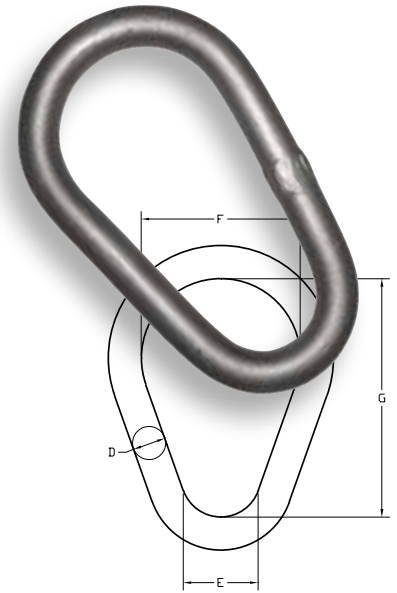

Peerless® Alloy Round Rings

Alloy components are 8620 or 4130 alloy steel. Master links are welded, heat-treated, proof tested and tumble finished.

Stock #	Trade Size		Dimensions (Inches)		Lbs. Per Each	Working Load Limit (Lbs.)
	Inches	MM	A	B		
Self-Colored						
RMA050	1/2	13	0.500	2.500	0.58	4,300
RMA063	5/8	16	0.630	3.000	1.00	5,650
RMA075	3/4	20	0.750	4.000	2.00	8,600
RMA088	7/8	22	0.880	4.000	2.83	13,200
RMA100	1	26	1.000	4.000	3.40	19,000
RMA125	1-1/4	32	1.250	5.000	7.50	24,000
RMA150	1-1/2	38	1.500	6.000	12.00	37,000
RMA175	1-3/4	45	1.750	7.000	20.00	49,000
RMA200	2	50	2.000	8.000	27.20	60,000

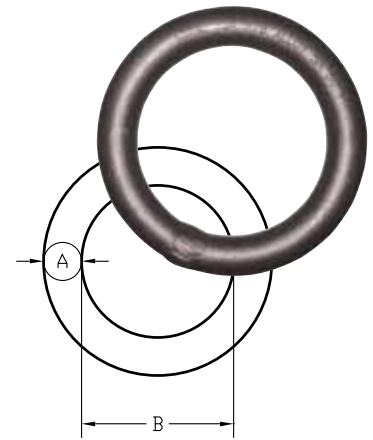

V-Notched Alloy Coupling Links

Alloy components are 8620 or 4130 alloy steel. Un-heat treated coupling links are pre-notched, bright finished and ready for welding.

NOT FOR OVERHEAD LIFTING

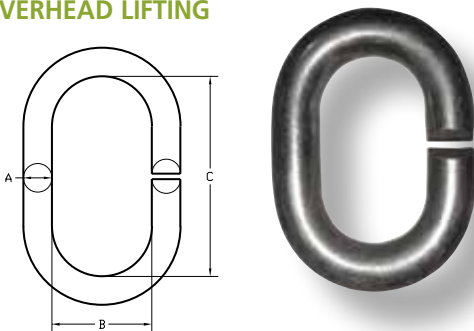

Stock #	Chain Size		Dimensions (Inches)			Lbs. Per Each
	Inches	MM	A	B	C	
Self-Colored						
CAN038	9/32	7	0.380	0.880	1.500	0.20
CAN050	3/8	10	0.500	1.250	2.000	0.40
CAN069	1/2	13	0.690	1.500	2.500	0.90
CAN081	5/8	16	0.810	1.750	3.000	1.50
CAN094	3/4	20	0.940	2.000	3.500	2.30
CAN106	7/8	22	1.060	2.250	4.000	3.30
CAN125	1	26	1.250	3.000	5.250	6.00
CAN150	1-1/4	32	1.500	3.500	6.250	10.30
CAN175	1-1/2	38	1.750	4.000	7.000	15.90
CAN200	1-3/4	45	2.000	4.500	8.000	23.60
CAN225	2	50	2.250	5.000	9.000	33.50



DO NOT EXCEED CAPACITY!
See the SAFETY GUIDELINES section before using these products. Pages 138-149.



Sub-Assemblies

Peerless® Alloy

Grade 80 Alloy components are 8620 or 4130 alloy steel. Master links are welded, heat-treated, proof tested and tumble finished.

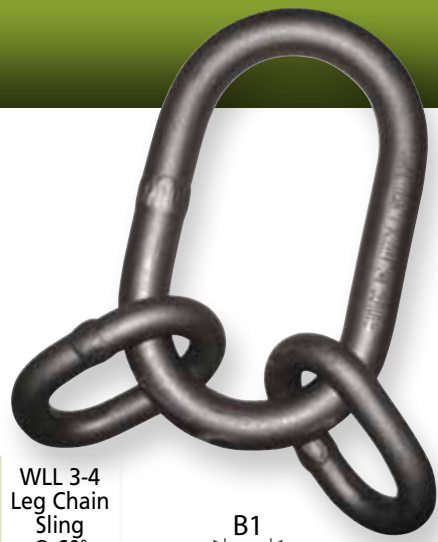

Stock #	Trade Size	Dimensions (Inches)						Lbs. Per Ea.	Grade 80 Chain Size		WLL 3-4 Leg Chain Sling @ 60° (Lbs.)
		Self-Colored In.	A	B	C	A1	B1		C1	In.	
SMA028	3/4	0.750	2.750	5.500	0.500	1.250	2.000	2.90	9/32	7	9,100
SMA038	1	1.000	3.500	7.000	0.750	1.500	3.000	7.30	3/8	10	18,400
SMA050	1-1/4	1.250	4.380	8.750	1.000	2.000	4.000	16.33	1/2	13	31,200
SMA063	1-1/2	1.500	5.250	10.500	1.250	3.000	5.250	27.80	5/8	16	47,000
SMA075	1 3/4	1.750	6.000	12.000	1.500	3.250	5.750	51.00	3/4	20	73,500
SMA088	2	2.000	7.000	14.000	1.750	4.000	6.000	65.90	7/8	22	88,900
SMA100	2-1/4	2.250	8.000	16.000	1.880	4.000	7.000	90.55	1	26	123,900
SMA125	2-3/4	2.750	9.000	16.000	2.250	4.500	8.000	144.90	1-1/4	32	187,800

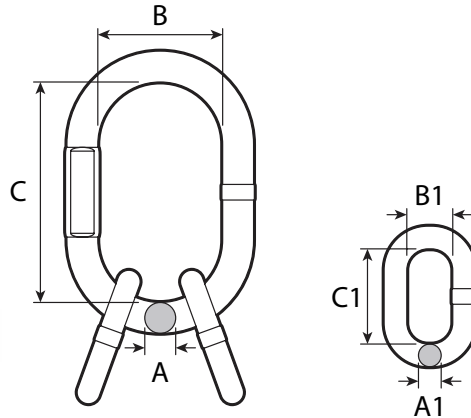
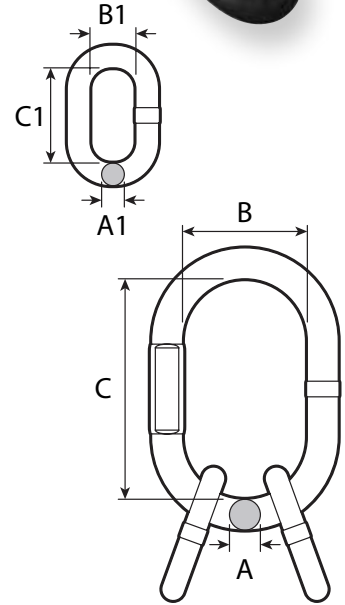

V10™ Alloy w/Small Sub-Links (Grade 100)

Stock #	Trade Size	Dimensions (Inches)						Lbs. Per Each	Grade 100 Chain Size (Inches)	WLL 3-4 Leg Chain Sling @ 60° (Lbs.)		
		Blue Mfr. #	In.	MM	A	B	C				A1	B1
8452110	3/4	D18L13	19	0.748	2.953	5.315	0.512	1.496	2.362	3.0	9/32	11,200
8452210	7/8	D22L16	22	0.906	3.543	6.299	0.630	1.339	2.756	5.3	5/16	14,800
8452310	1	D26L20	26	1.063	3.937	7.087	0.748	1.575	3.346	8.4	3/8	22,900
8452410	1-1/4	D32L22	32	1.299	4.331	7.874	0.906	1.969	4.528	14.5	1/2	39,000
8452510	1-1/2	D38L26	38	1.496	5.906	10.827	1.063	2.559	5.512	25.3	5/8	58,700
8452610	2	D50L32	50	1.969	7.480	13.780	1.299	2.756	5.906	50.7	3/4	91,700
8452710	2-1/4	D56L36	56	2.205	9.843	13.780	1.417	2.953	6.693	68.4	7/8	110,900



DO NOT EXCEED CAPACITY!
See the SAFETY GUIDELINES section before using these products. Pages 138-149.



SUB-ASSEMBLIES

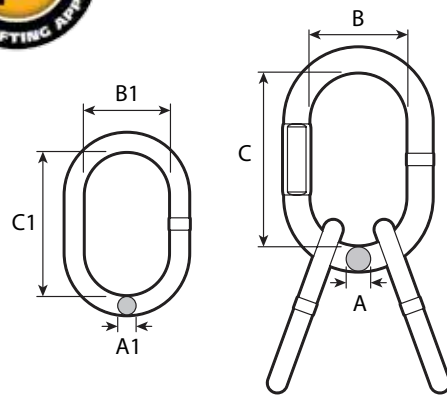

V10™ Alloy w/Large Sub-Links (Grade 100)

Stock #	Mfr. #	Trade Size		Dimensions (Inches)						Lbs. Per Each	Grade 100 Chain Size (Inches)	WLL 3-4 Leg Chain Sling @ 60°
		Inches	MM	A	B	C	A1	B1	C1			
8452100	D18E14	3/4	19	0.760	2.950	5.210	0.600	2.740	4.600	4.2	9/32	11,200
8452200	D22E16	7/8	22	0.906	3.543	6.299	0.669	3.150	5.512	6.9	5/16	14,800
8452300	D26E20	1	26	1.063	3.937	7.087	0.787	3.740	6.299	10.9	3/8	22,900
8452400	D32E26	1-1/4	32	1.299	4.331	7.874	1.063	4.331	7.480	21.0	1/2	39,000
8452500	D38E32	1-1/2	38	1.496	5.906	10.827	1.299	5.118	9.055	37.5	5/8	58,700
8452600	E50D38	2	50	1.969	9.843	13.780	1.496	5.906	10.827	71.9	3/4	91,700
8452700	D56D45	2-1/4	56	2.205	9.843	13.780	1.772	7.087	13.386	106.1	7/8	110,900

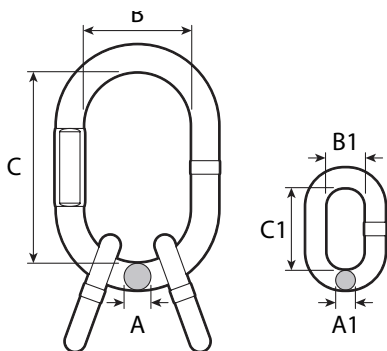

Accoloy® Kuplex®

These Oblong Sub-Assemblies are fabricated from premium fine grain alloy steel subjected to high quality heat treatment and quality control associated with other Peerless products.

Stock #	Trade Size (Inches)	Dimensions (Inches)						Lbs. Per Each	Chain Size			WLL 3-4 Leg Chain Sling @ 60°
		A	B	C	A1	B1	C1		Inches	MM	Grade	
599450401	3/4	0.750	3.000	6.000	0.625	1.156	2.188	3.8	9/32	7	100	11,200
599450601	1	1.000	3.500	7.000	0.750	1.500	3.000	7.2	3/8	10	100	22,900
599450801	1-1/4	1.250	4.000	8.000	1.031	2.000	4.000	15.0	1/2	13	100	39,000
599451001	1-1/2	1.500	6.000	12.000	1.125	2.250	4.563	26.2	5/8	16	100	58,700
599401201	1-3/4	1.750	6.000	12.000	1.500	2.500	5.250	42.3	3/4	20	80	73,500
599401401	2	2.000	7.000	14.000	1.750	3.000	6.000	65.5	7/8	22	80	88,900
599401601	2-1/4	2.250	8.000	16.000	1.875	5.000	10.000	115.0	1	26	80	123,900
599402001	2-3/4	2.750	9.000	16.000	2.250	5.000	10.000	160.0	1-1/4	32	80	187,800



DO NOT EXCEED CAPACITY!
See the SAFETY GUIDELINES section before using these products. Pages 138-149.



Kuplex® Master Kuplinks

Master Kuplinks® are the optimum of chain to master link connections. In addition to the streamline characteristics of the Kuplink®, there is a definite advantage to field assembly since other coupling devices are unnecessary.

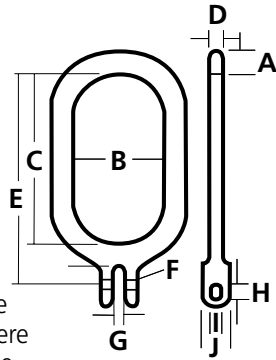

Stock #	Red	ID #	Chain Size			Dimensions (Inches)										Lbs. Per Each	WLL (Lbs.)
			In.	MM	Grade	A	B	C	D	E	F	G	H	I	J		
598350011		K-11	9/32	7	100	0.750	3.000	6.000	0.500	7.125	0.125	0.313	0.406	0.344	0.625	1.9	4,300
598350012		K-12	3/8	10	100	0.750	3.000	6.000	0.500	7.250	0.156	0.438	0.563	0.469	0.875	2.7	8,800
598350013		K-13	1/2	13	100	0.938	3.000	6.000	0.688	7.563	0.188	0.563	0.750	0.656	1.125	4.4	15,000
598350014		K-14	5/8	16	100	1.125	4.000	8.000	0.875	9.938	0.250	0.688	0.938	0.813	1.500	8.2	22,600
598300015		K-15	3/4	20	80	1.250	4.000	8.000	0.875	10.188	0.313	0.813	1.219	1.000	1.750	11.6	28,300

Kuplex® Kuplers®

Kuplers act as a connection device between Master Links and Chain on all multiple leg Kuplex II Chain Slings. On single leg assemblies, they can be used in lieu of the popular Kuplex II Kuplink. Resembling a shackle in appearance, the Kuplers provide a high strength, high integrity connection, when used to connect a special attachment to the alloy chain assembly.

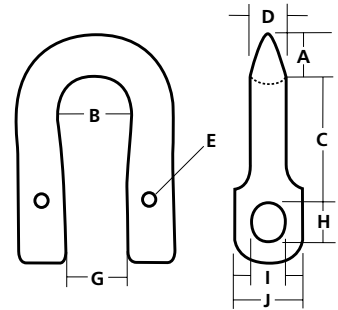

Stock #	Red	ID #	Chain Size			Dimensions (Inches)										Lbs. Per Each	WLL (Lbs.)
			Inches	MM	Grade	A	B	C	D	E	G	H	I	J			
598150020		K-20	9/32	7	80	0.438	0.813	1.313	0.313	0.125	0.719	0.406	0.344	0.625	0.3	3,500	
598150021		K-21	3/8	10	80	0.594	1.063	1.813	0.438	0.156	0.875	0.563	0.469	0.875	0.7	7,100	
598150022		K-22	1/2	13	80	0.750	1.313	2.563	0.563	0.188	1.094	0.750	0.656	1.125	1.3	12,000	
598150023		K-23	5/8	16	80	0.938	1.625	3.000	0.688	0.250	1.344	0.938	0.813	1.500	2.4	18,100	
598100024		K-24	3/4	20	80	1.000	1.938	3.406	0.813	0.313	1.594	1.219	1.000	1.750	4.4	28,300	
598100025		K-25	7/8	22	80	1.125	2.250	3.875	0.938	0.375	1.844	1.281	1.063	2.000	6.3	34,200	
599100026		K-26*	1	26	63	1.250	2.688	4.250	1.063	---	2.000	1.219	1.094	2.375	6.5	35,900	
599100028		K-28*	1-1/4	32	63	1.500	3.500	5.125	1.313	---	2.281	1.500	1.344	2.875	11.4	56,100	

* Kuplex I style, Grade 63.



DO NOT EXCEED CAPACITY!
See the SAFETY GUIDELINES section before using these products. Pages 138-149.



COUPLING LINKS

Coupling Links

V10™ Alloy (Grade 100)

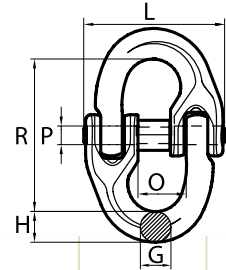

Stock #	Mfr. #	Chain Size		Dimensions (Inches)					Lbs. Per Each	Working Load Limit (Lbs.)
		Inches	MM	G	H	O	R	PXL		
Blue										
8452900	WLK6	7/32	6	0.299	0.307	0.551	1.732	0.19 x 1.54	0.15	2,700
8453100	WLK7	9/32	7	0.354	0.394	0.669	2.008	0.24 x 1.85	0.26	4,300
8453000	WLK8	5/16	8	0.390	0.450	0.730	2.500	0.25 x 2.10	0.42	5,700
8453210	WLK10	3/8	10	0.496	0.543	0.886	2.835	0.32 x 2.48	0.84	8,800
8453300	WLK13	1/2	13	0.657	0.748	1.083	3.465	0.39 x 3.11	1.61	15,000
8453400	WLK16	5/8	16	0.827	0.827	1.299	4.055	0.55 x 4.17	3.15	22,600
8453510	WLK19-20	3/4	20	0.925	1.161	1.634	4.528	0.63 x 4.96	5.86	35,300
8453610	WLK22	7/8	22	1.063	1.142	1.909	5.315	0.63 x 5.75	8.29	42,700
8453700	WLK26	1	26	1.180	1.260	2.200	6.730	0.75 x 6.50	12.57	59,700

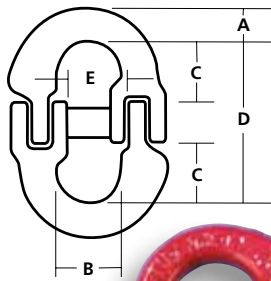

Kuplex® Kuplok®

Kuplok mechanical coupling links, an essential component of mechanically coupled slings, are used to assemble chain legs to the master link and/or attach eye type fittings.

Stock #	Chain Size			Dimensions (Inches)					Lbs. Per Each	WLL (Lbs.)	
	Red	Inches	MM	Grade	A	B	C	D			E
594200400		9/32	7	80	0.375	0.688	0.625	1.813	0.500	0.3	3,500
594200601		3/8	10	80	0.500	1.000	0.938	2.375	0.750	0.6	7,100
594200801		1/2	13	80	0.625	1.250	1.375	3.250	1.000	1.5	12,000
594201001		5/8	16	80	0.750	1.500	1.688	4.000	1.250	2.4	18,100
594201201		3/4	20	80	0.938	1.750	2.000	4.750	1.625	3.6	28,300

NEW! Peer-Lift® (Grade 80)

Stock #	Chain Size		Dimensions (Inches)					Lbs. Per Each	WLL (Lbs.)	
	Black	Inches	MM	G	H	O	R			PxL
8453280*		9/32	7	0.35	0.39	0.67	2.00	0.24 x 1.85	0.26	3,500
8453180		5/16	8	0.39	0.45	0.71	5.42	0.25 x 2.09	0.42	4,500
8453380*		3/8	10	0.50	0.54	0.89	2.83	0.31 x 2.48	0.84	7,100
8453480*		1/2	13	0.66	0.75	1.08	3.46	0.39 x 3.11	1.61	12,000
8453580*		5/8	16	0.83	0.83	1.30	4.06	0.55 x 4.17	3.15	18,100
8453680		3/4	20	0.93	1.16	1.63	4.53	0.63 x 4.84	5.84	28,300
8453780		7/8	22	1.06	1.14	1.91	5.31	0.63 x 5.91	8.27	34,200
8053755		1	26	1.24	1.24	2.36	5.79	0.71 x 6.23	9.48	47,700
8053855		1-1/4	32	1.26	1.57	3.15	7.64	0.98 x 7.68	17.75	72,300

*Replaces: 8553180 - 9/32", 8553280 - 3/8", 8553380 - 1/2", 8553480 - 5/8"

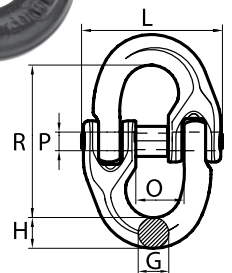

DO NOT EXCEED CAPACITY!
See the SAFETY GUIDELINES section before using these products. Pages 138-149.



Sling Hooks

V10™ Eye Sling Hook w/Latch (Grade 100)

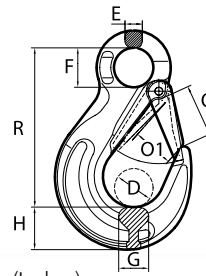

Stock #	Mfr. #	Chain Size		Dimensions (Inches)								Lbs. Per Each	WLL (Lbs.)
		Inches	MM	D	E	F	G	H	O	O1	R		
8417100	SHE6	7/32	6	0.709	0.394	0.787	0.650	0.827	0.984	0.748	3.327	0.73	2,700
8417200	SHE7-8	9/32- 5/16	7-8	0.945	0.433	0.984	0.748	1.063	1.260	0.984	4.173	1.23	5,700
8417400	SHE10	3/8	10	1.181	0.630	1.339	1.024	1.299	1.575	1.220	5.157	2.65	8,800
8417600	SHE13	1/2	13	1.496	0.748	1.693	1.299	1.654	1.890	1.535	6.457	5.18	15,000
8417700	SHE16	5/8	16	1.732	0.984	1.969	1.575	1.969	2.165	1.772	7.185	8.20	22,600
8417800	SHE19-20	3/4	20	2.087	1.063	2.165	1.890	2.126	2.402	2.126	8.071	13.12	35,300
8417900	SHE22	7/8	22	2.500	1.180	2.350	2.040	2.690	2.800	2.580	8.860	17.97	42,700

Accoloy® Eye Sling Hooks

Stock #		Chain Size			Dimensions (Inches)							Lbs. Per Each	WLL (Lbs.)
No-Latch	w/Latch	Inches	MM	Grade	D	E	F	G	H	I	K		
592353080	592300180	9/32	7	100	3.813	1.219	0.625	0.688	5.219	3.625	1.063	1.0	4,300
592353081	592300181	3/8	10	100	5.375	1.625	0.813	0.938	7.250	4.813	1.375	2.5	8,800
592353082	592300182	1/2	13	100	6.563	2.000	1.031	1.188	8.938	6.063	1.813	5.3	15,000
592353083	592300183	5/8	16	100	7.750	2.438	1.250	1.313	10.375	7.156	2.125	7.9	22,600
592303084	592300184	3/4	20	80	8.875	2.688	1.500	1.500	11.938	7.875	2.313	11.2	28,300
592303085	---	7/8	22	80	10.125	3.000	1.750	1.750	13.750	9.156	2.750	19.6	34,200
*592303086	---	1	26	80	11.063	3.375	2.000	1.875	15.000	10.063	3.000	21.8	47,700
*592303088	---	1-1/4	32	80	13.125	4.063	2.250	2.313	18.000	12.313	3.750	44.4	72,300

* Latch eye hole drilled only by request.

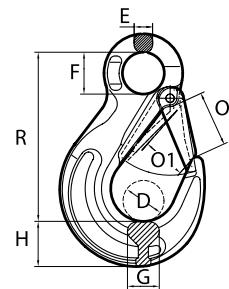
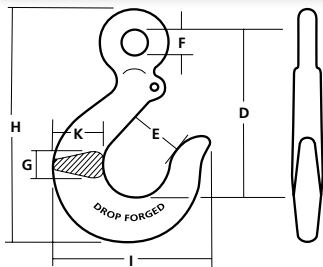

NEW! Peer-Lift® Eye Sling Hook w/Latch (Grade 80)

Stock #	Chain Size		Dimensions (Inches)								Lbs. Per Each	WLL (Lbs.)
Black	Inches	MM	D	E	F	G	H	O	O1	R		
8417280*	9/32-5/16	7-8	0.95	0.43	0.98	0.75	1.06	1.26	0.98	4.17	1.23	4,500
8417480*	3/8	10	1.18	0.63	1.34	1.02	1.30	1.57	1.22	5.16	2.65	7,100
8417680*	1/2	13	1.50	0.75	1.69	1.30	1.65	1.89	1.54	6.46	5.18	12,000
8417780*	5/8	16	1.73	0.98	1.97	1.57	1.97	2.17	1.77	7.19	8.20	18,100
8417880	3/4	20	2.09	1.06	2.17	1.89	2.13	2.40	2.13	8.07	13.12	28,300
8417980	7/8	22	2.36	1.18	2.36	1.97	2.40	2.80	2.40	8.86	17.35	34,200

*Replaces: 8517280 - 9/32", 8517480 - 3/8", 8517680 - 1/2", 8517780 - 5/8"



WARNING

DO NOT EXCEED CAPACITY!
See the SAFETY GUIDELINES section before using these products. Pages 138-149.



SLING HOOKS

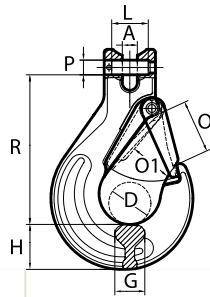

V10™ Clevis Sling Hook w/Latch (Grade 100)

Stock #	Mfr. #	Chain Size		Dimensions (Inches)								Lbs. Per Each	WLL (Lbs.)	
		Inches	MM	A	D	G	H	O	O1	R	PxL			
8418100	SHC6	7/32	6	0.276	0.709	0.650	0.787	0.984	0.748	2.717	0.29 x 0.65		0.60	2,700
8418200	SHC7-8	9/32- 5/16	7-8	0.354	0.984	0.748	1.102	1.260	1.024	3.720	0.38 x 0.91		1.35	5,700
8418400	SHC10	3/8	10	0.453	1.181	0.984	1.299	1.535	1.220	4.291	0.49 x 1.16		2.47	8,800
8418600	SHC13	1/2	13	0.571	1.496	1.181	1.575	1.890	1.535	5.315	0.63 x 1.46		4.52	15,000
8418700	SHC16	5/8	16	0.689	1.732	1.457	1.850	2.165	1.772	6.102	0.79 x 2.05		7.50	22,600
8418800	SHC19-20	3/4	20	0.906	2.047	2.008	1.969	2.402	2.087	7.205	0.94 x 2.87		13.80	35,300
8418900	SHC22	7/8	22	0.965	2.362	1.969	2.402	2.795	2.402	8.346	1.06 x 2.80		19.32	42,700

Kuplex® Clevis Sling Hook

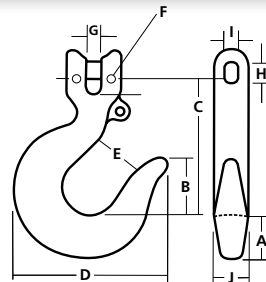

Stock #	Hook #	Stock #	Hook #	Chain Size			Dimensions (Inches)										Lbs. Per Each	WLL (Lbs.)	
				Inches	MM	Grade	A	B	C	D	E	F	G	H	I	J			
				No Latch															
				w/Latch															
598850080	K-80	598800180	K-80-S	9/32	7	100	1.000	1.500	3.313	3.625	1.125	0.125	0.313	0.406	0.344	0.625	1.3	4,300	
598850081	K-81	598800181	K-81-S	3/8	10	100	1.281	2.031	4.781	4.813	1.625	0.156	0.438	0.563	0.469	0.875	3.1	8,800	
598850082	K-82	598800182	K-82-S	1/2	13	100	1.688	2.438	6.125	6.125	2.000	0.188	0.563	0.750	0.656	1.125	6.5	15,000	
598850083	K-83	598800183	K-83-S	5/8	16	100	1.938	2.875	6.813	7.219	2.438	0.250	0.688	0.938	0.813	1.500	10.7	22,600	
598800084	K-84	598800184	K-84-S	3/4	20	80	2.375	3.250	8.531	8.188	2.688	0.313	0.813	1.219	1.000	1.750	15.2	28,300	
598800085	K-85	---	---	7/8	22	80	2.750	3.656	9.625	9.469	3.000	0.375	0.938	1.281	1.063	2.000	25.9	34,200	
599800086	K-86	---	---	1	26	63	3.000	4.063	10.063	10.063	3.375	-	1.375	1.219	1.094	1.875	26.9	35,900	

NEW! Peer-Lift® Clevis Sling Hook w/Latch (Grade 80)

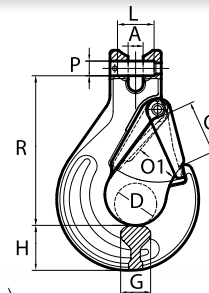

Stock #	Chain Size		Dimensions (Inches)									Lbs. Per Each	WLL (Lbs.)
	Inches	MM	A	D	G	H	O	O1	R	PxL			
8418280*	9/32-5/16	7-8	0.35	0.98	0.75	1.10	1.26	1.02	3.72	0.38 x 0.91		1.34	4,500
8418480*	3/8	10	0.45	1.18	0.98	1.30	1.54	1.22	4.29	0.49 x 1.16		2.47	7,100
8418680*	1/2	13	0.57	1.50	1.18	1.57	1.89	1.54	5.31	0.63 x 1.46		4.65	12,000
8418780*	5/8	16	0.69	1.73	1.46	1.85	2.17	1.77	6.10	0.79 x 2.05		7.50	18,100
8418880	3/4	19-20	0.91	2.05	2.01	2.05	2.40	2.09	7.20	0.94 x 2.87		14.99	28,300
8418980	7/8	22	0.96	2.36	1.97	2.44	2.80	2.40	8.35	1.06 x 2.80		19.84	34,200

*Replaces: 8518280 - 9/32", 8518480 - 3/8", 8518680 - 1/2", 8518780 - 5/8"



DO NOT EXCEED CAPACITY!
See the SAFETY GUIDELINES section before using these products. Pages 138-149.



Grab Hooks

V10™ Eye Shortening Grab Hook (Grade 100)

Stock #	Mfr. #	Chain Size		Dimensions (Inches)					Lbs. Per Each	Working Load Limit (Lbs.)
		Inches	MM	E	F	H	O	R		
8427100	GSE6	7/32	6	0.374	0.492	0.689	0.276	2.205	0.51	2,700
8427200	GSE7-8	9/32- 5/16	7-8	0.512	0.650	0.925	0.374	2.933	1.19	5,700
8427400	GSE10	3/8	10	0.630	0.827	1.142	0.472	3.661	2.34	8,800
8427600	GSE13	1/2	13	0.807	1.083	1.516	0.610	4.764	5.27	15,000
8427700	GSE16	5/8	16	0.984	1.319	1.890	0.728	5.846	9.88	22,600
8427810	GSE19-20	3/4	20	1.063	1.614	2.264	1.024	6.969	14.55	35,300
8427900	GSE22	7/8	22	1.299	1.732	2.441	1.024	7.657	19.29	42,700

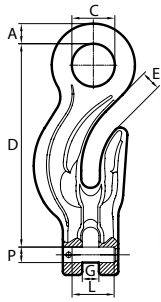
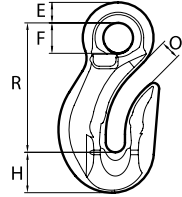

V10™ Eye Grab Hook w/ Clevis Attachment (Grade 100)

Stock #	Mfr. #	Chain Size		Dimensions (Inches)						Lbs. Per Each	Working Load Limit (Lbs.)
		Inches	MM	A	C	D	E	G	P x L		
8420100	GIE6	7/32	6	0.406	0.709	3.484	0.315	0.256	0.29 x 0.65	0.60	2,700
8420200	GIE7-8	9/32- 5/16	7-8	0.531	0.945	4.606	0.354	0.358	0.38 x 0.91	1.35	5,700
8420400	GIE10	3/8	10	0.630	1.220	5.827	0.531	0.453	0.49 x 1.16	2.69	8,800
8420600	GIE13	1/2	13	0.787	1.457	7.283	0.610	0.571	0.63 x 1.46	5.62	15,000
8420700	GIE16	5/8	16	1.043	1.890	9.134	0.787	0.689	0.79 x 2.05	10.80	22,600

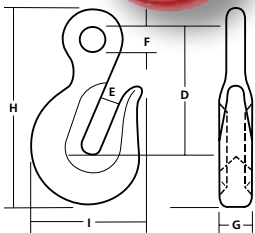

Accoloy® Eye Grab Hook

Stock #	Chain Size			Dimensions (Inches)						Lbs. Per Each	WLL (Lbs.)	
	Red	Inches	MM	Grade	D	E	F	G	H			I
592252072		9/32	7	100	2.069	0.344	0.625	0.609	4.125	2.375	0.7	4,300
592252073		3/8	10	100	3.375	0.484	0.813	0.734	5.031	2.844	1.2	8,800
592252075		1/2	13	100	4.250	0.641	1.031	0.969	6.469	3.719	2.6	15,000
592252076		5/8	16	100	5.281	0.781	1.250	1.188	8.000	4.563	4.9	22,600
592202077		3/4	20	80	6.250	0.938	1.500	1.406	9.469	5.469	8.2	28,300
592202078		7/8	22	80	7.250	1.094	1.750	1.625	11.000	6.375	12.1	34,200
592202079		1	26	80	8.000	1.188	1.875	1.813	12.156	6.750	19.9	47,700
592202051		1-1/4	32	80	10.500	1.500	2.250	2.500	15.563	8.250	40.0	72,300

NEW! Peer-Lift® Eye Cradle Grab Hook (Grade 80)

Stock #	Chain Size		Dimensions (Inches)						Lbs. Per Each	WLL (Lbs.)	
	Black	Inches	MM	E	F	G	H	O			R
8427280*		9/32-5/16	7-8	0.39	0.61	1.18	0.94	0.39	2.36	0.66	4,500
8427480*		3/8	10	0.47	0.81	1.73	1.26	0.51	3.15	1.32	7,100
8427680*		1/2	13	0.63	0.98	2.09	1.50	0.67	4.09	2.87	12,000
8427780*		5/8	16	0.79	1.22	2.52	1.77	0.79	4.49	4.85	18,100
8427880		3/4	20	0.94	1.42	3.35	2.09	0.91	5.31	8.82	28,300
8427980		7/8	22	0.98	1.61	3.82	2.44	1.06	6.22	12.79	34,200

*Replaces: 8527280 - 9/32", 8527480 - 3/8", 8527680 - 1/2", 8527780 - 5/8"

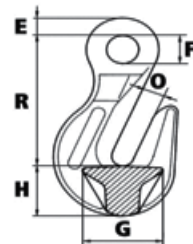

DO NOT EXCEED CAPACITY!
See the SAFETY GUIDELINES section before using these products. Pages 138-149.

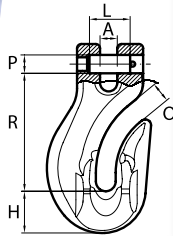

V10™ Clevis Shortening Grab Hook (Grade 100)

Stock #	Mfr. #	Chain Size		Dimensions (Inches)					Lbs. Per Each	WLL (Lbs.)
		Inches	MM	A	H	O	R	P x L		
8428100	GSC6	7/32	6	0.276	0.689	0.276	2.008	0.29 x 0.65	0.55	2,700
8428200	GSC7-8	9/32- 5/16	7-8	0.354	0.925	0.374	2.598	0.38 x 0.91	1.32	5,700
8428400	GSC10	3/8	10	0.453	1.142	0.472	3.228	0.49 x 1.16	2.51	8,800
8428610	GSC13	1/2	13	0.571	1.535	0.650	4.173	0.63 x 1.46	4.63	15,000
8428710	GSC16	5/8	16	0.709	1.811	0.866	5.118	0.79 x 2.05	8.38	22,600
8428810	GSC19-20	3/4	20	0.866	2.224	1.024	6.378	0.94 x 2.87	16.18	35,300
8428910	GSC22	7/8	22	0.984	2.480	1.161	7.008	1.06 x 2.80	21.01	42,700

V10™ Clevis Shortening Grab Hook w/Retainer (Grade 100)

Stock #	Mfr. #	Chain Size		Dimensions (Inches)					Lbs. Per Each	WLL (Lbs.)
		Inches	MM	A	H	O	R	P x L		
8429100	GSC6-S	7/32	6	0.28	0.71	0.31	2.02	0.29 x 0.65	0.55	2,700
8429200	GSC7-8-S	9/32-5/16	7-8	0.37	0.93	0.41	2.58	0.38 x 0.91	1.32	5,700
8429400	GSC10-S	3/8	10	0.46	1.15	0.472	3.24	0.49 x 1.16	2.53	8,800
8429620*	GSC13-S	1/2	13	0.59	1.53	0.67	4.17	0.63 x 1.45	4.67	15,000
8429720*	GSC16-S	5/8	16	0.70	1.82	0.87	5.14	0.79 x 2.05	8.42	22,600

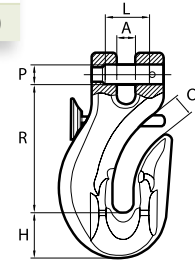
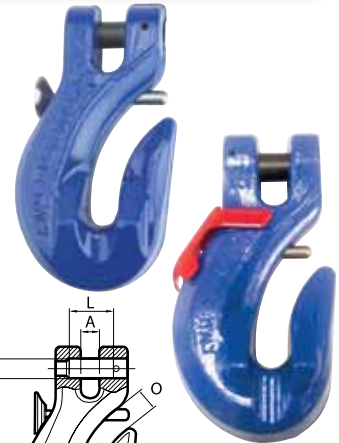

8429620*
8429720*

Kuplex® Clevis Type Grab Hook

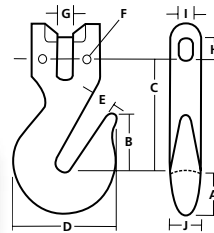

Stock #	Red	ID #	Chain Size		Grade	Dimensions (Inches)										Lbs. Per Each	WLL (Lbs.)
			Inches	MM		A	B	C	D	E	F	G	H	I	J		
598750072		K-72	9/32	7	100	0.688	1.250	2.125	2.125	0.375	0.125	0.313	0.406	0.344	0.625	0.6	4,300
598750073		K-73	3/8	10	100	1.031	1.500	2.875	2.625	0.500	0.156	0.438	0.563	0.469	0.875	1.5	8,800
598750075		K-75	1/2	13	100	1.250	2.000	3.563	3.344	0.625	0.188	0.563	0.750	0.656	1.125	3.4	15,000
598750076		K-76	5/8	16	100	1.625	2.375	4.938	4.250	0.781	0.250	0.688	0.938	0.813	1.500	6.2	22,600
598700077		K-77	3/4	20	80	1.875	2.938	5.094	5.063	0.875	0.313	0.813	1.219	1.000	1.750	10.1	28,300
598700078		K-78	7/8	22	80	2.125	3.500	5.875	6.094	1.125	0.375	0.938	1.281	1.063	2.000	14.8	34,200

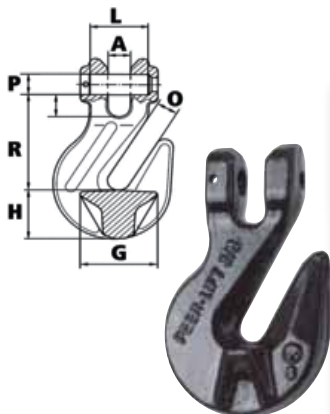

NEW! Peer-Lift® Clevis Cradle Grab Hook (Grade 80)

Stock #	Chain Size		Dimensions (Inches)						Lbs. Per Each	WLL (Lbs.)
	Inches	MM	A	G	H	O	R	PxL		
8428280*	9/32-5/16	7-8	0.35	1.18	0.95	0.39	1.97	0.35 x 0.91	0.66	4,500
8428480*	3/8	10	0.51	1.73	1.22	0.51	2.83	0.51 x 1.24	1.65	7,100
8428680*	1/2	13	0.67	2.09	1.50	0.67	3.46	0.63 x 1.65	3.09	12,000
8428780*	5/8	16	0.83	2.52	1.73	0.79	4.02	0.83 x 2.03	5.51	18,100
8428880	3/4	20	0.94	3.35	2.09	0.94	4.61	0.95 x 2.42	9.48	28,300
8428980	7/8	22	1.02	3.82	2.44	1.06	5.47	1.02 x 2.83	14.11	34,200

*Replaces: 8528280 - 9/32", 8528480 - 3/8", 8528680 - 1/2", 8528780 - 5/8"



DO NOT EXCEED CAPACITY!
See the SAFETY GUIDELINES section before using these products. Pages 138-149.



Foundry Hooks

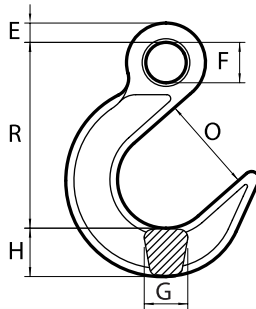

V10™ Eye Foundry Hook (Grade 100)

Stock #	Mfr. #	Chain Size		Dimensions (Inches)						Lbs. Per Each	WLL (Lbs.)
		Inches	MM	E	F	G	H	O	R		
8477200	FHE7-8	9/32- 5/16	7-8	0.531	0.709	1.024	1.220	2.520	4.823	2.49	5,700
8477400	FHE10	3/8	10	0.630	0.866	1.260	1.417	3.071	5.866	4.39	8,800
8477600	FHE13	1/2	13	0.748	1.063	1.535	1.693	3.504	6.949	7.30	15,000
8477700	FHE16	5/8	16	0.945	1.260	1.772	1.969	3.937	8.071	11.69	22,600
8477800	FHE19-20	3/4	20	1.063	1.496	2.008	2.402	4.528	9.331	16.98	35,300

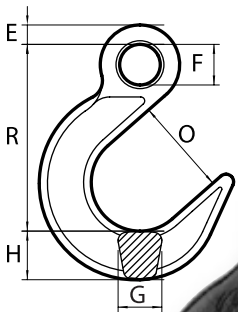

NEW! Peer-Lift® Eye Foundry Hook (Grade 80)

Stock #	Chain Size		Dimensions (Inches)							Lbs. Per Each	WLL (Lbs.)
	Black	Inches	MM	E	F	G	H	O	R		
8477280		9/32-5/16	7-8	0.53	0.71	1.02	1.22	2.48	4.82	2.49	4,500
8477480		3/8	10	0.63	0.87	1.26	1.42	3.03	5.87	4.41	7,100
8477680		1/2	13	0.75	1.06	1.54	1.69	3.46	6.83	7.28	12,000
8477780		5/8	16	0.95	1.26	1.77	1.97	3.94	8.07	11.68	18,100
8477880		7/8	20	1.06	1.50	2.01	2.40	4.53	9.33	16.98	28,300

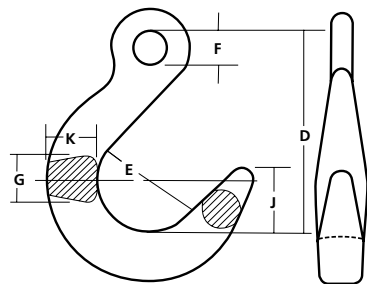

Accoloy® Eye Foundry Hook

Stock #	Chain Size			Dimensions (Inches)							Lbs. Per Each	WLL (Lbs.)
	Red	Inches	MM	Grade	D	E	F	G	J	K		
592454498		9/32	7	100	4.750	2.625	0.625	1.000	1.563	1.125	2.0	4,300
592454499		3/8	10	100	5.750	3.125	0.813	1.250	1.875	1.375	4.1	8,800
592454500		1/2	13	100	6.875	3.750	1.031	1.500	2.250	1.625	7.0	15,000
592454501		5/8	16	100	8.063	4.250	1.250	1.750	2.625	1.875	10.5	22,600
592404502		3/4	20	80	9.250	4.750	1.500	2.000	3.000	2.125	18.2	28,300
592404503		7/8	22	80	10.375	5.250	1.750	2.250	3.375	2.375	26.0	34,200
592404504		1	26	80	11.563	5.750	2.000	2.500	2.750	2.750	35.0	47,700
592404505		1-1/4	32	80	12.750	6.375	2.250	3.000	4.250	3.250	50.0	72,300



DO NOT EXCEED CAPACITY!
See the SAFETY GUIDELINES section before using these products. Pages 138-149.



FOUNDRY HOOKS

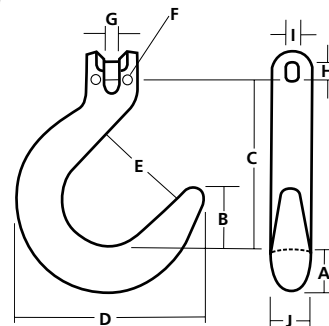

Kuplex® Clevis Foundry Hook

Stock #	Chain Size				Dimensions (Inches)										Lbs. Per Each	WLL (Lbs.)
Red	ID #	Inches	MM	Grade	A	B	C	D	E	F	G	H	I	J		
598250498	K-498	9/32	7	100	1.125	1.563	4.438	4.875	2.625	0.125	0.313	0.406	0.344	0.875	2.1	4,300
598250499	K-499	3/8	10	100	1.375	1.875	5.500	5.875	3.000	0.156	0.438	0.563	0.469	1.125	4.3	8,800
598250500	K-500	1/2	13	100	1.500	2.250	6.625	6.875	3.875	0.188	0.563	0.750	0.656	1.500	8.2	15,000
598250501	K-501	5/8	16	100	2.188	2.563	7.625	8.281	4.125	0.250	0.688	0.938	0.813	1.750	14.4	22,600
598200502	K-502	3/4	20	80	2.750	3.000	8.813	9.625	4.813	0.313	0.813	1.219	1.000	2.000	24.5	28,300
598200503	K-503	7/8	22	80	3.000	3.375	9.938	10.688	5.375	0.375	0.938	1.281	1.063	2.250	33.1	34,200

Self-Locking Hooks

V10™ Eye Self-Locking Hook (Grade 100)

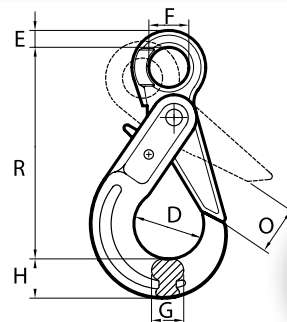

Stock #	Mfr. #	Chain Size		Dimensions (Inches)							Lbs. Per Each	WLL (Lbs.)
		In	MM	D	E	F	G	H	O	R		
8497100	SKE6	7/32	6	1.378	0.433	0.827	0.630	0.807	1.102	4.331	1.17	2,700
8497200	SKE7-8	9/32- 5/16	7-8	1.713	0.472	1.063	0.787	1.024	1.339	5.354	1.96	5,700
8497400	SKE10	3/8	10	2.205	0.591	1.358	0.965	1.181	1.772	6.634	3.48	8,800
8497600	SKE13	1/2	13	2.717	0.787	1.575	1.358	1.575	2.028	8.071	6.97	15,000
8497700	SKE16	5/8	16	3.150	1.063	1.969	1.398	1.969	2.362	9.902	13.34	22,600



NEW! Peer-Lift® Eye Self-Locking Hook (Grade 80)

Stock #	Chain Size		Dimensions (Inches)							Lbs. Per Each	WLL (Lbs.)
Black	Inches	MM	D	E	F	G	H	O (min)	R		
8497280*	9/32-5/16	7-8	1.71	0.47	1.06	0.79	1.02	1.34	5.35	1.96	4,500
8497480*	3/8	10	2.20	0.59	1.36	0.96	1.18	1.77	6.63	3.48	7,100
8497680*	1/2	13	2.72	0.79	1.57	1.36	1.57	2.03	8.07	6.97	12,000
8497780*	5/8	16	3.15	1.06	1.97	1.40	1.97	2.36	9.90	13.34	18,100

*Replaces: 8597280 - 9/32", 8597480 - 3/8", 8597680 - 1/2", 8597780 - 5/8"



DO NOT EXCEED CAPACITY!
See the SAFETY GUIDELINES section before using these products. Pages 138-149.



Self-Locking Hooks cont.

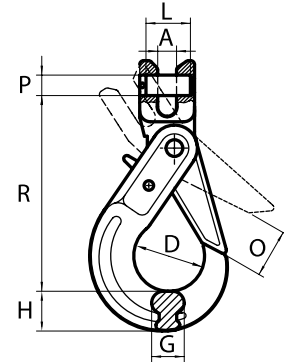

V10™ Clevis Self-Locking Hook (Grade 100)

Stock #	Mfr. #	Chain Size		Dimensions (Inches)							Lbs. Per Each	WLL (Lbs.)
		Inches	MM	A	D	G	H	O	R	PxL		
8498100	SKC6	7/32	6	0.264	1.378	0.630	0.807	1.102	3.700	0.29 x 0.65	1.10	2,700
8498200	SKC7-8	9/32 - 5/16	7-8	0.335	1.713	0.787	1.024	1.339	4.843	0.38 x 0.91	2.12	5,700
8498400	SKC10	3/8	10	0.472	2.205	0.965	1.181	1.772	5.650	0.49 x 1.16	3.53	8,800
8498600	SKC13	1/2	13	0.591	2.717	1.358	1.575	2.028	7.067	0.63 x 1.46	6.90	15,000
8498800	SKC16	5/8	16	0.748	3.150	1.398	1.969	2.362	8.543	0.79 x 2.05	12.79	22,600

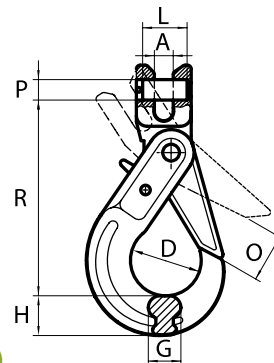

NEW! Peer-Lift® Clevis Self-Locking Hook (Grade 80)

Stock #	Chain Size		Dimensions (Inches)							Lbs. Per Each	WLL (Lbs.)
	Inches	MM	A	D	G	H	O (min)	R	PxL		
8498280*	9/32-5/16	7-8	0.33	1.71	0.79	1.02	1.34	4.84	0.38 x 0.91	2.12	4,500
8498480*	3/8	10	0.47	2.20	0.97	1.18	1.77	5.65	0.49 x 1.16	3.53	7,100
8498680*	1/2	13	0.59	2.72	1.36	1.57	2.03	7.07	0.63 x 1.46	6.90	12,000
8498780*	5/8	16	0.75	3.15	1.40	1.97	2.36	8.54	0.79 x 2.05	12.79	18,100

*Replaces: 8598280 - 9/32", 8598480 - 3/8", 8598680 - 1/2", 8598880 - 5/8"



DO NOT EXCEED CAPACITY!
See the SAFETY GUIDELINES section before using these products. Pages 138-149.



SELF-LOCKING HOOKS

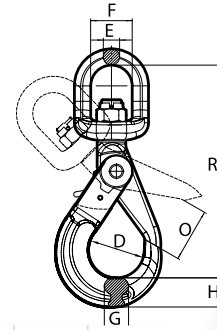

V10™ Swivel Self-Locking Hook (Grade 100)

Stock #	Mfr. #	Chain Size		Dimensions (Inches)							Lbs. Per Each	WLL (Lbs.)
		Inches	MM	D	E	F	G	H	O	R		
8499100	SKS6	7/32	6	1.377	0.512	1.377	0.630	0.807	1.102	6.299	1.76	2,700
8499200	SKS7-8	9/32- 5/16	7-8	1.713	0.512	1.378	0.787	1.024	1.339	7.126	2.43	5,700
8499400	SKS10	3/8	10	2.205	0.630	1.654	0.965	1.181	1.772	8.583	4.41	8,800
8499600	SKS13	1/2	13	2.717	0.787	1.929	1.358	1.575	2.028	10.591	8.82	15,000
8499700	SKS16	5/8	16	3.150	0.945	2.362	1.398	1.969	2.362	12.559	14.99	22,600

V10™ Swivel Self-Locking Hook w/Bearing (Grade 100)

Stock #	Mfr. #	Chain Size		Dimensions (Inches)							Lbs. Per Each	WLL (Lbs.)
		Inches	MM	D	E	F	G	H	O (min)	R		
8491100	SKB6	7/32	6	1.377	0.512	1.377	0.630	0.807	1.102	6.299	1.76	2,700
8491200	SKB7-8	9/32- 5/16	7-8	1.713	0.512	1.378	0.787	1.024	1.339	7.126	2.43	5,700
8491400	SKB10	3/8	10	2.205	0.630	1.654	0.965	1.181	1.772	8.583	4.41	8,800
8491600	SKB13	1/2	13	2.717	0.787	1.929	1.358	1.575	2.028	10.591	8.82	15,000
8491700	SKB16	5/8	16	3.150	0.945	2.362	1.398	1.969	2.362	12.559	14.99	22,600

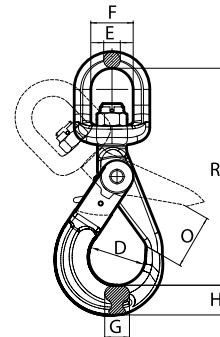
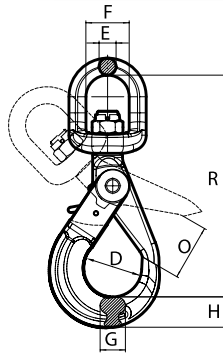

NEW! Peer-Lift® Swivel Self-Locking Hook (Grade 80)

Stock #	Chain Size		Dimensions (Inches)							Lbs. Per Each	WLL (Lbs.)	
	Black	Inches	MM	D	E	F	G	H	O (min)			R
8499280*		9/32	7	1.71	0.51	1.38	0.79	1.02	1.34	7.13	2.43	4,500
8499480*		3/8	10	2.20	0.63	1.65	0.97	1.18	1.77	8.58	4.41	7,100
8499680*		1/2	13	2.72	0.79	1.93	1.36	1.57	2.03	10.59	8.82	12,000
8499780*		5/8	16	3.15	0.94	2.36	1.40	1.97	2.36	12.64	16.09	18,100

*Replaces: 8599280 - 9/32", 8599480 - 3/8", 8599680 - 1/2", 8599780 - 5/8"



DO NOT EXCEED CAPACITY!
See the SAFETY GUIDELINES section before using these products. Pages 138-149.



Replacement Parts for V10™ & Peer-Lift® Components

V10™ & Peer-Lift® Clevis Hook Pin Kits



Stock #	Dia. x Length (inches)	Use with V10 Stock #	Use with Peer-Lift Stock #
8410199	0.291 x 0.650	8418100, 8428100, 8498100	---
8410299	.378 x .906	8420200, 8429200, 8498200, 8918200, 8928200	8418280, 8498280
8410499	.492 x 1.161	8420400, 8429400, 8918400, 8928400, 8998400	8418480, 8498480
8410599	.630 x 1.457	8420600, 8428610, 8429620, 8918600, 8998600	8418680, 8498680
8410699	.787 x 2.047	8418700, 8420700, 8428710, 8429720, 8998800	8418780, 8498780
8410799	.945 x 2.874	8428810, 8918800	8418880
8410899	1.063 x 2.795	8428910, 8918900	8418980
8428262	.35x.91	---	8428280
8428462	.51x1.24	---	8428480
8428662	.63x1.65	---	8428680
8428762	.83x2.03	---	8428780
8428862	.94x2.42	---	8428880
8428962	1.02x2.83	---	8428980

V10™ & Peer-Lift® Sling Hook Latch Kits

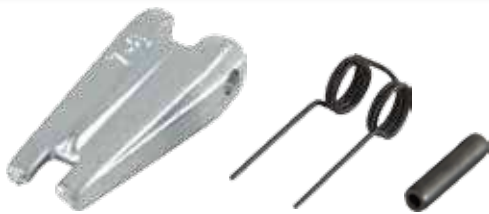

Stock #	Use with V10 Stock #	Use with Peer-Lift Stock #
8410077	8417100, 8418100	---
8410177	8417200, 8418200	8417280, 8418280
8410277	8417400, 8418400	8417480, 8418480
8410377	8417600, 8418600	8417680, 8418680
8410477	8417700, 8418700	8417780, 8418780
8410577	8417800, 8418800	8417880, 8418880
8410677	8417900, 8418900	8417980, 8418980



V10™ Replacement Pin Kits for Retainer Pin Grab Hooks

Stock #	Use with V10 Stock #
8429105	8429100
8429205	8429200
8429405	8429400
8429625	8429620
8429725	8429720

V10™ & Peer-Lift® Self-Locking Hooks Trigger Kits



Stock #	Use with V10 Stock #	Use with Peer-Lift Stock #
8490199	8491100, 8498100, 8497100, 8499100	---
8490299	8491200, 8498200, 8497200, 8499200	8497280, 8498280, 8499280
8490399	8491400, 8498400, 8497400, 8499400	8497480, 8498480, 8499480
8490499	8491600, 8498600, 8497600, 8499600	8497680, 8498680, 8499680
8490599	8491700, 8498800, 8497700, 8499700	8497780, 8498780, 8499780

V10™ & Peer-Lift® Spare Pin & Collar Set Coupling Links



Stock #	Dia. x Length (inches)	Use W/V10 Stock #	Use W/Peer-Lift Stock #
8452999	.19x1.54	8452900	---
8453199	.24x1.83	8453100	8453280
8453099	.25x2.09	8453000	8453180
8453299	.32x2.49	8953210	8453380
8453399	.39x3.11	8453300	8453480
8453499	.55x4.17	8453400	8453580
8453589	.63x4.82	8453510	8453680
8453699	.63x5.65	8453610	8453780
8453789	.71x6.26	---	8053755
8453799	.75x6.50	8453700	---
8453899	.98x7.68	---	8053855



DO NOT EXCEED CAPACITY!
See the SAFETY GUIDELINES section before using these products. Pages 138-149.



Replacement Parts for Accoloy® Kuplex® Components

Kuplex® Load Pins & Retaining Pins

All Kuplex components derive their integrity connection from the special Kuplex Load Pins and Spiral Pins. The load pins are made from alloy steel heat treated to obtain optimum rated performance properties. The load pins are specially shaped to develop strength characteristics and resistance to bending under rated load. The oval shape presents a greater force area than conventional round pins.



Use with Accessories for this Chain Size (Inches)	Hooks & Kuplinks				Kuplers		Retaining Pin	
	Stock No. Load Pin Set*	H (Inches)	I (Inches)	K (Inches)	Stock No. Load Pin Set	K (Inches)	Stock No.	Qty. Per Ctn.
9/32	598950232	0.406	0.313	1.156	598950132	1.531	598900332	100
3/8	598950233	0.563	0.469	1.656	598950133	2.094	598900333	50
1/2	598950234	0.719	0.625	2.219	598950134	2.719	598900334	50
5/8	598950235	0.922	0.781	2.563	598950135	3.219	598900335	25
3/4	598900236	1.188	1.000	3.125	598900136	3.938	598900336	10
7/8	598900237	1.250	1.063	3.563	598900137	4.531	---	---

Important: Use only genuine Kuplex load and retaining pins when assembling slings. Never use rods, bolts or other objects of questionable strength and metallurgy. Failure could cause serious injury or damage to property.

* One Load Pin and two Spiral Pins are bagged.

There is an occasional need for replacement of Spiral Pins and Load Pins. The same Load Pins cannot be used in both Kuplers and Hooks. When ordering these parts separately, be sure to specify whether they are for Kuplers or Hooks and also specify Kupler Number or the Hook Number with which they are to be used.

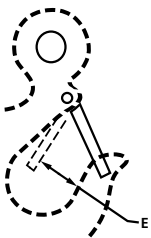

Accoloy® Kuplex® Latch Assembly

For use w/both Accoloy Eye Type & Kuplex Clevis Type Sling Hooks. One per bag.

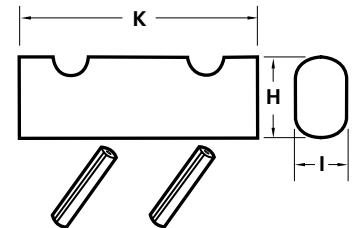

Kuplex® Kuplok® Replacement Pins & Collars

Five pins and 5 collars per bag

Use with Accessories for this Chain Size (Inches)	Latch Assembly Stock #	For Hook:		E (Inches)
		Accoloy® Eye Sling Hook	Kuplex® Clevis Sling Hook	
9/32	599900402	592353080	598850080	1.000
3/8	599900403	592353081	598850081	1.375
1/2	599900404	592353082	598850082	1.625
5/8	599900405	592353083	598850083	2.125
3/4	599900406	592303084	598800084	2.438
7/8	599900407	592303085	598800085	2.625
1	599900408	592303086	599800086	3.250
1-1/4	599900410	592303088	---	3.750

Chain Size (Inches)	Stock#	
	Pin	Collar
9/32	594300403	594300404
3/8	594300603	594300604
1/2	594300803	594300804
5/8	594301003	594301004
3/4	594301203	594301204



DO NOT EXCEED CAPACITY!
See the SAFETY GUIDELINES section before using these products. Pages 138-149.



ID Tags for Slings

Instructions for Assembling:

Punch the information onto the tag as per OSHA Standard 1910.184(e)(i) Sling identification. Alloy steel chain slings shall have permanently affixed durable identification stating size, grade, rated capacity and reach.

Stock #	Description	Finish	Dimensions (Inches)		Carton Qty.
			Length	Width	
440900009	Forged ID Tag w/wire rope & sleeve conn.	Self-Colored	4.75	1.38	50
440900003	Forged ID Tag	Self-Colored	4.75	1.38	100
599920003	Stamped ID Tag w/wire rope & sleeve conn.	Bright Zinc	4.00	1.75	50
8055435	Solid Ring Stamped ID Tag	Bright Zinc	4.00	1.50	50
8055535	Split Ring Stamped ID Tag	Bright Zinc	4.00	1.50	50



440900009

599920003



440900003

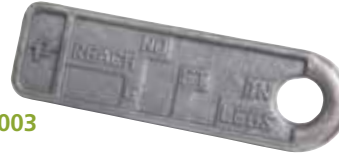

8055435

Peer-Lift® Alloy Screw Pin Anchor Shackles

For applications where frequent pin removal is needed.

- Forged Alloy Body & Pin
- Meet or exceeds FED SPEC RR-C-271 requirements
- Meets ASME B30.26 Requirements
- Hot Dipped Galvanized to ASTM A153
- Proof load at 2.2 times Working Load Limit



Stock #	Trade Size (Inches)	Pin Dia. (D)	Dimensions (Inches)					Qty. Per Package	Lbs. Per Each	Working Load Limit* (Ton)
			W	A	E (Min.)	G (Max.)	B (Min.)			
8058103	3/16	1/4	0.375	0.875	0.560	0.620	0.180	5	0.1	1/2
8058203	1/4	5/16	0.470	1.125	0.750	0.875	0.240	5	0.1	3/4
8058303	5/16	3/8	0.530	1.250	0.810	1.000	0.300	5	0.2	1-1/4
8058403	3/8	7/16	0.655	1.435	0.940	1.120	0.360	5	0.3	2
8059203	7/16	1/2	0.720	1.685	1.060	1.250	0.420	5	0.5	2-2/3
8058503	1/2	5/8	0.815	1.875	1.190	1.380	0.480	5	0.7	3-1/3
8058603	5/8	3/4	1.065	2.405	1.500	1.880	0.590	5	1.4	5
8058703	3/4	7/8	1.250	2.825	1.750	2.120	0.710	5	2.4	7
8058803	7/8	1	1.500	3.310	2.000	2.370	0.830	1	3.6	9-1/2
8058903	1	1-1/8	1.690	3.750	2.310	2.620	0.950	1	5.1	12-1/2
8059003	1-1/4	1-3/8	2.030	4.690	2.880	3.250	1.190	1	9.5	18
8059103	1-1/2	1-5/8	2.375	5.750	3.380	3.750	1.420	1	17.7	25
8059403	1-3/4	2	2.875	7.000	4.500	4.500	1.660	1	30.4	34
8059503	2	2-1/4	3.250	7.750	5.250	5.250	1.900	1	45.0	43

*Ultimate load is 5 times the Working Load Limit. Reduce Working Load Limit for side loading applications, see page 143.

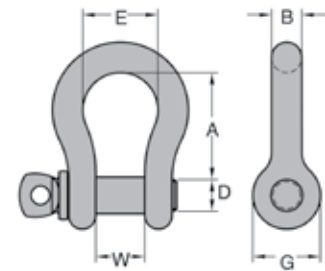

DO NOT EXCEED CAPACITY!
See the SAFETY GUIDELINES section before using these products. Pages 138-149.



Peer-Lift® Galvanized Anchor Shackles

Screw Pin Anchor Shackles are ideal for those applications where frequent pin removal is needed.

- Meets or exceed FED SPEC RR-C-271 requirements
- Hot Dipped Galvanized to ASTM A153
- Proof load at 2.2 times Working Load Limit
- Meets ASME B30.26 requirements

Peer-Lift® Screw Pin Anchor Shackles Forged Carbon Body and Alloy Pin

Stock#	UPC Tagged HDG	Trade Size (Inches)	Pin Dia. (D)	Dimensions (Inches)					Qty. Per Pkg.	Lbs. Per Each	Working Load Limit* (Ton)
				W	A	E (Min.)	G (Max.)	B (Min.)			
8058105		3/16	1/4	0.375	0.875	0.562	0.625	0.180	25	0.06	1/3
8058205		1/4	5/16	0.469	1.125	0.750	0.875	0.240	25	0.11	1/2
8058305		5/16	3/8	0.531	1.250	0.812	1.000	0.300	25	0.19	3/4
8058405		3/8	7/16	0.656	1.438	0.938	1.125	0.360	25	0.31	1
8059205		7/16	1/2	0.750	1.688	1.062	1.250	0.420	25	0.49	1-1/2
8058505		1/2	5/8	0.812	1.875	1.188	1.375	0.480	25	0.73	2
8058605		5/8	3/4	1.062	2.375	1.500	1.875	0.590	25	1.37	3-1/4
8058705		3/4	7/8	1.250	2.812	1.750	2.125	0.710	25	2.36	4-3/4
8058805		7/8	1	1.438	3.312	2.000	2.375	0.830	10	3.62	6-1/2
8058905		1	1-1/8	1.688	3.750	2.312	2.625	0.950	10	5.07	8-1/2
8058005		1-1/8	1-1/4	1.812	4.250	2.625	2.875	1.070	5	7.41	9-1/2
8059005		1-1/4	1-3/8	2.031	4.688	2.875	3.250	1.190	5	9.51	12
8059305		1-3/8	1-1/2	2.250	5.250	3.250	3.500	1.310	5	13.25	13-1/2
8059105		1-1/2	1-5/8	2.375	5.750	3.375	3.750	1.420	1	17.70	17
8059405		1-3/4	2	2.875	7.000	4.500	4.500	1.660	1	30.40	25
8059505		2	2-1/4	3.250	7.750	5.250	5.250	1.900	1	45.04	35

*Ultimate load is 5 times the Working Load Limit. Reduce Working Load Limit for side loading applications, see page 143.

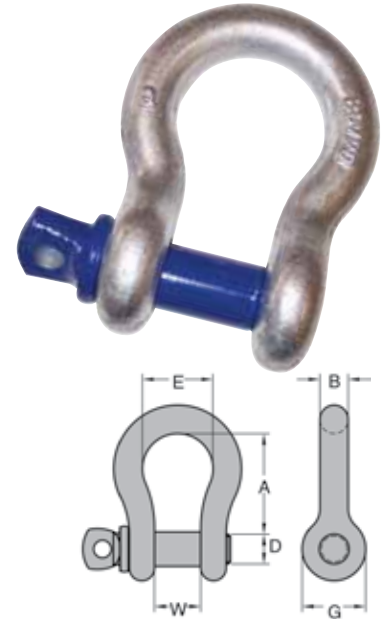

Peer-Lift® Bolt, Nut & Cotter Anchor Shackles Forged Carbon Body and Alloy Bolt

Safety Pin Anchor Shackles are complete with bolt, nut and cotter pin. Use in permanent or long term installations.

Stock#	UPC Tagged HDG	Trade Size (Inches)	Pin Dia. (D)	Dimensions (Inches)					Qty. Per Pkg.	Lbs. Per Each	Working Load Limit* (Ton)
				W	A	E (Min.)	G (Max.)	B (Min.)			
8063005		3/16	1/4	0.375	0.875	0.562	0.625	0.180	25	0.06	1/3
8063105		1/4	5/16	0.469	1.125	0.750	0.875	0.240	25	0.11	1/2
8063205		5/16	3/8	0.531	1.250	0.812	1.000	0.300	25	0.22	3/4
8063305		3/8	7/16	0.656	1.438	0.938	1.125	0.360	25	0.33	1
8063405		7/16	1/2	0.750	1.688	1.062	1.250	0.420	25	0.51	1-1/2
8063505		1/2	5/8	0.812	1.875	1.188	1.375	0.480	25	0.79	2
8063605		5/8	3/4	1.062	2.375	1.500	1.875	0.590	25	1.68	3-1/4
8063705		3/4	7/8	1.250	2.812	1.750	2.125	0.710	25	2.72	4-3/4
8063805		7/8	1	1.438	3.312	2.000	2.375	0.830	10	3.95	6-1/2
8063905		1	1-1/8	1.688	3.750	2.312	2.625	0.950	10	5.67	8-1/2
8064005		1-1/8	1-1/4	1.812	4.250	2.625	2.875	1.070	5	8.28	9-1/2
8064105		1-1/4	1-3/8	2.031	4.688	2.875	3.250	1.190	5	11.73	12
8064205		1-3/8	1-1/2	2.250	5.250	3.250	3.500	1.310	5	15.83	13-1/2
8064305		1-1/2	1-5/8	2.375	5.750	3.375	3.750	1.420	1	18.35	17
8064405		1-3/4	2	2.875	7.000	4.500	4.500	1.660	1	33.93	25
8064505		2	2-1/4	3.250	7.750	5.250	5.250	1.900	1	52.29	35

*Ultimate load is 5 times the Working Load Limit. Reduce Working Load Limit for side loading applications, see page 143.

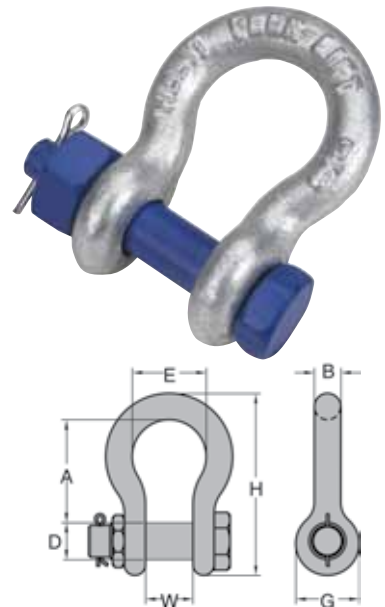

DO NOT EXCEED CAPACITY!
See the SAFETY GUIDELINES section before using these products. Pages 138-149.



Standard Alloy Components

S-Hooks

Alloy components are 8620 or 4130 alloy steel. S-hooks are welded, heat-treated, proof tested and tumble finished.

Stock #	Trade Size (Inches)	Dimensions (Inches)				Lbs. Per Each	Working Load Limit (Lbs.)
		A	B	C	D		
SHA0312	5/16	0.310	2.750	0.750	0.380	0.25	325
SHA0375	3/8	0.380	4.130	1.130	0.560	0.26	425
SHA0500	1/2	0.500	5.500	1.500	0.750	1.00	775
SHA0625	5/8	0.630	7.000	1.880	0.940	1.40	1,225
SHA0750	3/4	0.750	8.250	2.250	1.130	2.30	1,750
SHA0875	7/8	0.880	9.500	2.630	1.310	3.00	2,400
SHA1000	1	1.000	11.000	3.000	1.500	5.50	3,000
SHA1250	1-1/4	1.250	13.750	3.750	1.880	9.90	4,900
SHA1500	1-1/2	1.500	16.500	4.500	2.250	16.60	7,000
SHA1750	1-3/4	1.750	19.250	5.250	2.630	26.50	9,600
SHA2000	2	2.000	22.000	6.000	3.000	39.00	12,500

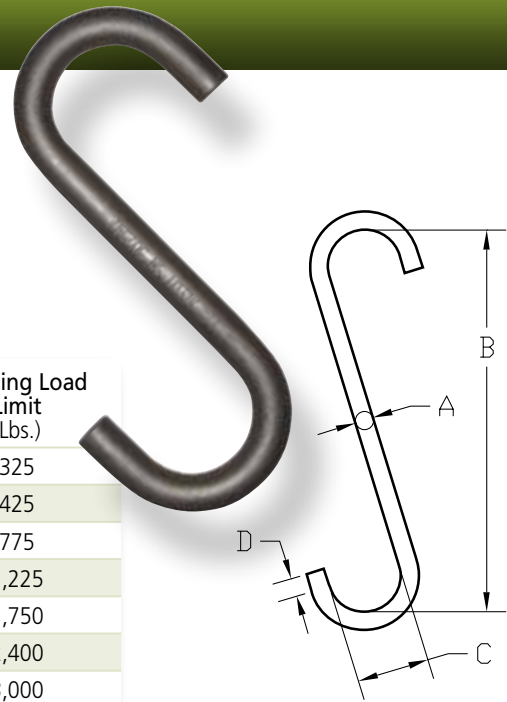

J-Hooks

Alloy components are 8620 or 4130 alloy steel.

Stock # (Self-Colored)			Trade Size (Inches)	Dimensions (Inches)					Lbs. Per Each	WLL (Lbs.)
Style A	Style B	Style C		A	B	C	D	E		
JAA031	JBA031	JCA031	5/16	0.310	5.000	0.750	1.250	0.250	0.40	250
JAA038	JBA038	JCA038	3/8	0.380	6.000	0.750	1.500	0.380	0.42	350
JAA050	JBA050	JCA050	1/2	0.500	8.000	0.750	2.000	0.500	1.17	650
JAA063	JBA063	JCA063	5/8	0.630	9.000	1.000	2.500	0.630	1.50	850
JAA075	JBA075	JCA075	3/4	0.750	10.000	1.000	3.000	0.750	2.31	1,200
JAA088	JBA088	JCA088	7/8	0.880	12.000	1.000	3.500	0.880	5.00	1,500
JAA100	JBA100	JCA100	1	1.000	14.000	1.250	4.000	1.000	5.77	2,000
JAA113	JBA113	JCA113	1-1/8	1.130	15.000	1.250	4.500	1.120	7.90	2,250
JAA125	JBA125	JCA125	1-1/4	1.250	16.000	1.500	5.000	1.250	11.50	2,750
---	JBA138	JCA138	1-3/8	1.380	17.000	1.500	5.500	1.380	14.20	3,000
JAA175	---	---	1-3/4	1.750	20.000	2.500	7.000	1.750	27.50	4,000

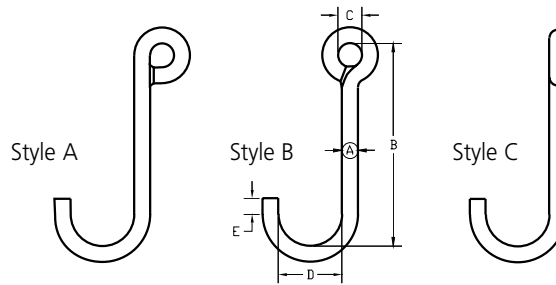

**Working Load Limit is based on bearing point to bearing point pull.*



DO NOT EXCEED CAPACITY!
See the SAFETY GUIDELINES section before using these products. Pages 138-149.



STANDARD ALLOY COMPONENTS

Foundry Sorting Hooks

Alloy components are 8620 or 4130 alloy steel.



Stock #	Self- Colored	Chain Size (Inches)	Dimensions (Inches)					Lbs. Per Each	Working Load Limit (Lbs.)
			A	B	C	D	E		
FSA050		9/32	0.500	6.000	0.750	2.500	0.750	0.75	500
FSA063		9/32	0.630	8.500	0.750	3.500	1.500	1.40	800
FSA075		9/32	0.750	8.500	0.750	3.500	1.500	2.00	1,300
FSA081		3/8	0.810	8.500	0.880	3.500	1.500	2.67	1,600
FSA100		3/8	1.000	8.500	1.000	4.000	1.750	3.70	2,500
FSA113		3/8	1.130	8.500	1.000	4.000	2.000	5.00	3,500
FSA125		1/2	1.250	8.500	1.250	4.000	2.000	7.00	4,500
FSA150		1/2	1.500	8.500	1.250	5.000	1.500	9.50	6,000

Foundry Sorting Hooks - Short Version

Alloy components are 8620 or 4130 alloy steel.

Stock #	Self- Colored	Chain Size (Inches)	Dimensions (Inches)					Lbs. Per Each	Working Load Limit (Lbs.)
			A	B	C	D	E		
FSA050S		9/32	0.500	6.000	0.750	3.000	1.500	1.33	450
FSA063S		9/32	0.630	6.000	0.750	3.000	1.500	2.00	900
FSA075S		9/32	0.750	6.000	0.750	3.000	1.500	2.30	1,400
FSA088S		3/8	0.880	6.000	0.880	3.000	1.500	2.88	2,000
FSA100S		3/8	1.000	6.000	1.000	3.000	1.500	3.80	3,000
FSA113S		3/8	1.130	6.000	1.000	3.000	1.500	4.70	4,000
FSA125S		1/2	1.250	6.000	1.250	3.000	1.500	6.30	5,500

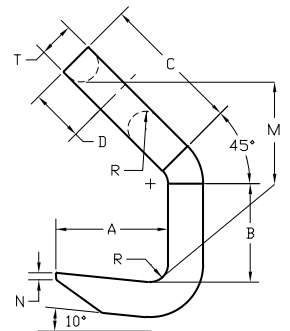
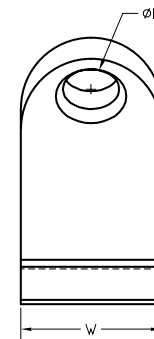
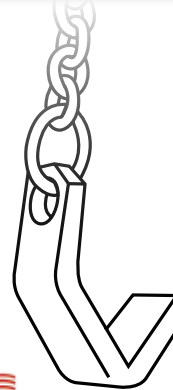
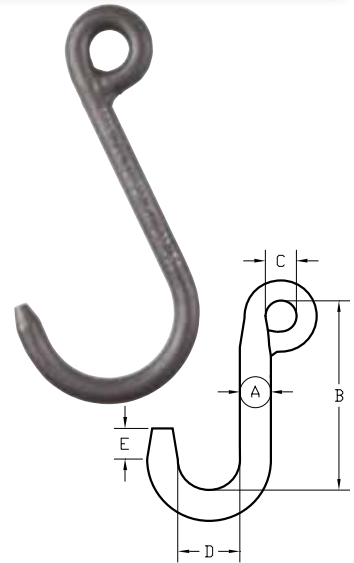

Standard Plate Hook

Stock #	Chain Size		Dimensions (Inches)										Lbs. Per Each	WLL (Lbs.)
	Inches	MM	A	B	C	D	L	M	N	T	W	R		
PHA028	9/32	7	2.000	1.750	2.500	0.930	1.000	3.680	0.120	0.630	2.500	0.310	2.8	4,200
PHA038	3/8	10	2.625	3.000	4.310	1.180	1.120	6.380	0.180	0.750	2.750	0.380	5.7	7,400
PHA050	1/2	13	3.500	4.000	4.380	1.500	1.500	7.370	0.250	1.000	3.500	0.500	11.9	13,000
PHA063	5/8	16	4.375	5.000	5.430	1.870	1.880	9.250	0.310	1.250	5.000	0.630	25.8	20,400
PHA075	3/4	20	5.188	6.000	6.500	2.380	2.250	10.880	0.380	1.500	5.750	0.750	42.0	30,000
PHA088	7/8	22	6.000	7.000	7.630	2.500	2.630	13.130	0.430	1.750	6.000	0.880	62.6	40,000



DO NOT EXCEED CAPACITY!
See the SAFETY GUIDELINES section before using these products. Pages 138-149.



Grade 50/60 Stainless Chain

Stock #	Grade (Inches)	Trade Size (Inches)	Wire Dia. (Inches)	Inside Link Dim. (Inches)		Ft. Per Drum	Lbs. Per Foot	Working Load Limit	
				Length (Nominal)	Width (Min.)			Lbs.	Kgs.
5900023	50	1/8	0.157	0.748	0.276	750	0.20	660	300
5900123	50	3/16	0.197	0.827	0.354	750	0.34	1,100	500
5900223	60	1/4	0.275	0.827	0.409	400	0.74	2,600	1,200
5900323	60	5/16	0.315	0.945	0.409	275	0.94	3,300	1,500
5900423	60	3/8	0.394	1.181	0.531	200	1.48	5,300	2,400
5900623	60	1/2	0.572	1.535	0.665	200	2.55	8,500	3,850
5900823	50	5/8	0.629	1.889	0.819	150	3.83	11,000	5,000



Chain Sling Working Load Limit Specifications

Grade 50 Stainless Steel Chain

Chain Size Inches	Single Leg @ 90°	Double Leg @ 60°	Triple & Quad Leg @ 60°
3/16	1,100	1,900	2,850
1/4	2,600	4,500	6,700
5/16	3,300	5,700	8,500
3/8	5,300	9,100	13,700
1/2	8,500	14,700	22,000
5/8	11,000	19,000	28,500

- DO NOT** load an assembly in excess of the rated working load limits in the chart above.
- DO NOT** put an unequal load on one leg of a sling. Distribute the load evenly.
- DO NOT** expose assembly to impact, rapid lifts or sudden stops.
- DO NOT** tie knots or allow chains to become twisted.
- DO NOT** use chain that appears to be defective, worn or damaged.
- DO NOT** fasten chain over sharp corners or edges. Protect with padding.
- DO NOT** tip load hooks. The latch must NEVER support the load.

When using non-cradle or non-shortening grab hooks in a shortening or choker application, the Working Load Limit (WLL) of the sling must be reduced by 20%. Reference the **Safety Guidelines** section of this catalog for more information.



DO NOT EXCEED CAPACITY!
See the **SAFETY GUIDELINES** section before using these products. Pages 138-149.



316 Stainless Steel Components

V-Notch Coupling Links

V-Notch coupling links are electropolished and ready for welding.

Stock #	Chain Size		Dimensions (Inches)			Lbs. Per Each
	Inches	MM	A	B	C	
CS031	3/16	5.5	0.310	0.630	1.250	0.10
CS038	9/32	7	0.380	0.880	1.500	0.16
CS044	5/16	8	0.440	0.940	1.750	0.25
CS050	3/8	10	0.500	1.000	2.000	0.36
CS063	1/2	13	0.630	1.500	2.500	0.74
CS075	5/8	16	0.750	1.500	3.000	1.21
CS088	3/4	20	0.880	2.000	3.500	2.01
CS100	7/8	22	1.000	2.250	4.500	3.14
CS125	1	26	1.250	2.500	5.000	5.62

NOT FOR OVERHEAD LIFTING.

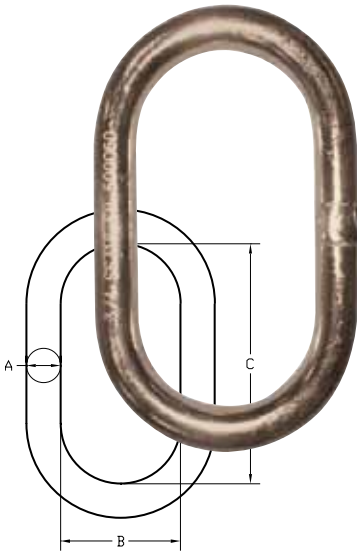
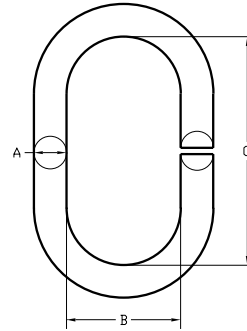

Oblong Master Links

Welded, electropolished and proof tested.

Stock #	Trade Size		Dimensions (Inches)			Lbs. Per Each	Working Load Limit (Lbs.)
	Inches	MM	A	B	C		
OMS038	3/8	10	0.380	2.000	4.000	0.42	750
OMS050	1/2	13	0.500	2.500	5.000	0.94	2,150
OMS063	5/8	16	0.630	2.750	5.500	1.63	2,850
OMS075	3/4	20	0.750	3.000	6.000	2.50	4,600
OMS100	1	26	1.000	3.500	7.000	5.40	7,800
OMS125	1-1/4	32	1.250	4.000	8.000	8.75	11,800
OMS150	1-1/2	38	1.500	5.250	10.500	17.00	18,600

Pear Shape Master Links

Welded, electropolished and proof tested.

Stock #	Trade Size		Dimensions (Inches)				Lbs. Per Each	Working Load Limit (Lbs.)
	Inches	MM	D	E	F	G		
PMS038	3/8	10	0.380	1.000	2.000	4.000	0.30	750
PMS050	1/2	13	0.500	1.250	2.500	5.000	0.80	2,150
PMS063	5/8	16	0.630	1.380	2.750	5.500	1.50	2,850
PMS075	3/4	20	0.750	1.500	3.000	6.000	2.10	4,600
PMS100	1	26	1.000	2.000	4.000	8.000	5.10	7,800
PMS125	1-1/4	32	1.250	3.000	6.000	9.000	9.60	11,800
PMS150	1-1/2	38	1.500	5.000	7.000	10.500	16.50	18,600

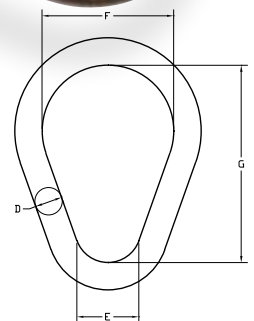

DO NOT EXCEED CAPACITY!
See the SAFETY GUIDELINES section before using these products. Pages 138-149.



316 Stainless Steel Components

Round Rings

Welded, electropolished and proof tested.

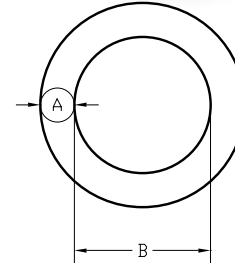

Stock #	Trade Size		Dimensions (Inches)		Lbs. Per Each	Working Load Limit (Lbs.)
	Inches	MM	A	B		
RMS038	3/8	10	0.380	2.000	0.23	750
RMS050	1/2	13	0.500	2.500	0.62	1,300
RMS063	5/8	16	0.630	3.000	1.20	1,850
RMS075	3/4	20	0.750	4.000	1.85	2,800
RMS100	1	26	1.000	4.000	4.00	5,650
RMS125	1-1/4	32	1.250	5.000	7.80	7,650
RMS150	1-1/2	38	1.500	6.000	11.70	9,700

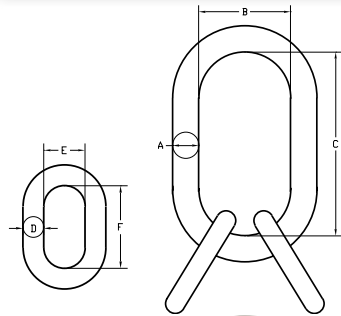

Sub-Assemblies

Welded, electropolished and proof tested.

Stock #	Chain Size		Dimensions (Inches)							Lbs. Per Each	Working Load Limit (Lbs.) @ 60°
	In.	MM	A	B	C	D	E	F			
SMS019	3/16	5.5	0.630	2.750	5.500	0.380	0.880	1.500	2.00	2,850	
SMS025	1/4	6	0.750	3.000	6.000	0.500	1.000	2.000	2.90	3,225	
SMS038	3/8	10	1.000	3.500	7.000	0.750	1.500	3.000	7.10	6,875	
SMS050	1/2	13	1.250	4.000	8.000	0.880	2.000	3.500	12.50	11,675	
SMS063	5/8	16	1.500	5.250	10.500	1.120	2.500	5.000	15.00	15,575	

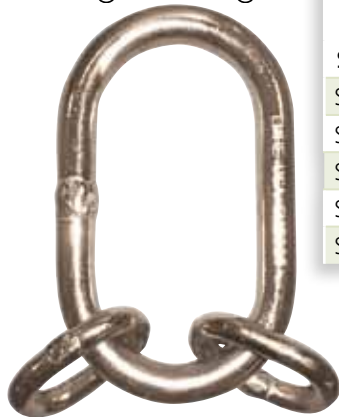

S-Hooks

Stock #	Trade Size	Dimensions (Inches)				Lbs. Per Each	Working Load Limit (Lbs.)
	Inches	A	B	C	D		
SHS025	1/4	0.250	2.750	0.750	0.380	0.07	75
SHS038	3/8	0.380	4.130	1.130	0.560	0.33	165
SHS050	1/2	0.500	5.500	1.500	0.750	0.59	325
SHS063	5/8	0.630	7.000	1.880	0.940	1.23	500
SHS075	3/4	0.750	8.250	2.250	1.130	2.31	660
SHS088	7/8	0.880	9.630	2.630	1.310	3.05	900
SHS100	1	1.000	11.000	3.000	1.500	4.98	1,060

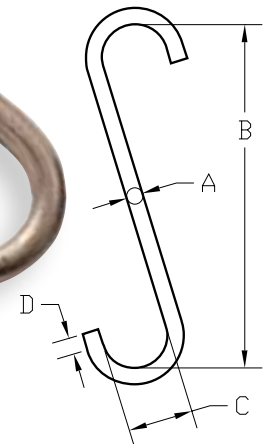
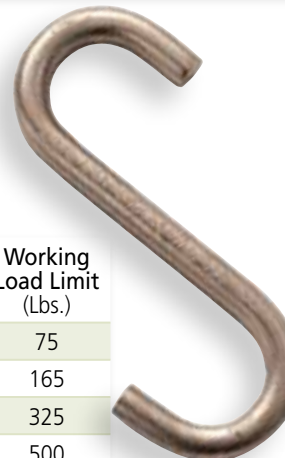

DO NOT EXCEED CAPACITY!
See the SAFETY GUIDELINES section before using these products. Pages 138-149.



Foundry Sorting Hooks

Welded, electropolished and proof tested.

Stock #	Trade Size (Inches)	Dimensions (Inches)					Lbs. Per Each	Working Load Limit (Lbs.)
		A	B	C	D	E		
SFS050	1/2	0.500	6.000	0.560	3.000	1.500	0.70	200
SFS063	5/8	0.630	6.000	0.560	3.000	1.500	1.11	300
SFS075	3/4	0.750	6.000	0.750	3.000	1.500	1.52	500
SFS100	1	1.000	6.000	0.750	3.000	1.500	2.94	900
SFS125	1-1/4	1.250	6.000	1.000	3.000	1.500	5.16	1,500

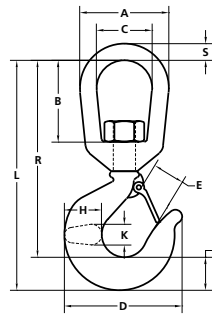
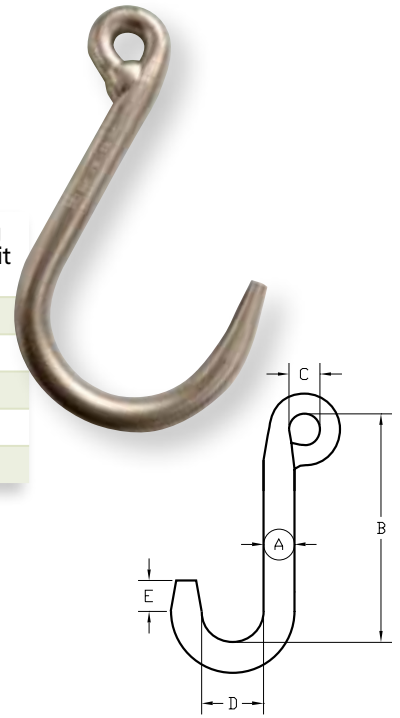

Swivel Hooks

Stock #	Dimensions (Inches)											Lbs. Per Ea.	WLL (Lbs.)
	A	B	C	D	E	G	H	K	L	R	S		
SWS2L	2.000	1.460	1.180	3.000	0.780	0.880	0.880	0.560	5.230	4.350	0.410	0.88	1,000
SWS3L	2.500	1.970	1.380	3.190	0.910	0.880	0.970	0.630	6.080	5.200	0.560	1.50	1,500
SWS4L	2.500	1.970	1.380	3.560	0.980	1.060	1.120	0.720	6.570	5.510	0.560	2.03	2,000
SWS5L	2.820	2.400	1.560	3.880	1.090	1.200	1.310	0.810	7.510	6.310	0.670	2.82	2,500

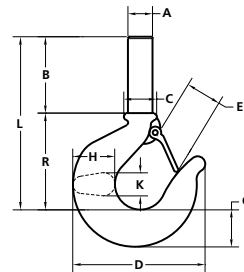

Shank Hooks

Stock #	Dimensions (Inches)										Lbs. Per Ea.	WLL (Lbs.)
	A	B	C	D	E	G	H	K	L	R		
SHS2L	0.560	2.000	0.690	3.000	0.780	0.880	0.880	0.560	5.000	2.310	0.66	1,000
SHS3L	0.610	2.250	0.750	3.190	0.910	0.880	0.970	0.630	5.500	2.440	0.83	1,500
SHS4L	0.720	2.500	0.880	3.560	0.980	1.060	1.120	0.720	6.250	2.750	1.42	2,000
SHS5L	0.840	2.700	1.000	3.880	1.090	1.200	1.310	0.810	6.970	3.060	1.92	2,500



DO NOT EXCEED CAPACITY!
See the SAFETY GUIDELINES section before using these products. Pages 138-149.



Insulated Swivel Hook

Reduce costly handling during welding operations. Avoid shorted fork-lift batteries. Electrically insulated, the insulated hook eliminated current flow that can damage hoists and lifting equipment. Free running bearing allows easy work positioning. Use wherever electrical potentials present a hazard. Safe up to 2,000 volts and 225°F. *Uses SKF bearing for free turning.

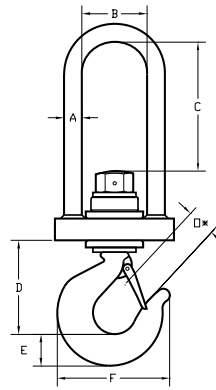

Stock #	Dimensions (Inches)							Lbs. Per Each	WLL (Lbs.)
	A	B	C	D	E	F	O*		
IS04000	0.630	2.250	4.380	2.750	1.150	4.120	1.120	6.0	4,000
IS08000	0.750	2.500	5.000	3.880	1.430	4.940	1.340	8.8	8,000
IS12000	1.000	3.000	6.500	4.750	1.810	6.500	1.780	18.4	12,000
IS20000	1.380	4.000	7.630	6.430	2.560	8.680	2.250	50.0	20,000
IS40000	1.750	6.000	10.380	9.500	3.630	13.630	3.630	119.3	40,000

*Dimension O is clearance under safety latch

PEERLESS **AGCO** **Accoloy** **Kuplex** **Peer-Lift** **ProLok66** **Boatman's Pride**
Auto-Trac **SUPER Z** **SmartBar** **GrabBar** **SecureBar** **QuikBinder Plus**

ALL OF THIS AND MORE FROM A SINGLE SOURCE



WARNING

DO NOT EXCEED CAPACITY!
See the SAFETY GUIDELINES section before using these products. Pages 138-149.

BELOW THE HOOK

Lifting Beams	46-47
Spreader Beams	48
Roll Lifters	49
Tongs	49
Coil Lifters	50-51
Sheet Lifters	51
Pallet Lifters	52-53
Fork Truck Accessories	53-54
Material Handling	54

MEETS INDUSTRY OVERHEAD LIFTING STANDARDS



OVERHEAD LIFTING APPROVED

Product (or products) with this symbol meet or exceed the overhead lifting industry required standards.

LIFTING BEAMS

Product Charts and additional options can be found online at www.peerlesschain.com/products/Peerless-Custom-Lifting-Devices or in the **Below-the-Hook & Material Handling Equipment catalog (27.15)**. Custom Application Forms can be found at www.peerlesschain.com/custom-order-forms.



Includes All Products
On This Page



SSLB

SHORT SPAN LIFTING BEAM PLATE STYLE

Ideal for short span applications, this style of lifting beam can be utilized where headroom is limited and comes supplied with a pair of shackles and one standard spread.



BSLB

BASKET SLING LIFTING BEAM

This style of lifting beam can be utilized where headroom is limited with slings in a basket hitch. Includes two sets of fixed hooks (3' & 4' beams have one set of hooks). Two standard lift points for load adjustment: outside lift point & inside lift point (1/2 the overall length).



SDLB

STANDARD DUTY LIFTING BEAM CHANNEL DESIGN

This style of lifting beam can be utilized where headroom is limited and comes with a pair of swivel hooks and three standard spreads (3' & 4' have two standard spreads). Three standard lift points for load adjustment: outside lift point, middle lift point (outside less 1'), inside lift point (middle less 1').



DCLB

DUAL CRANE LIFTING BEAM

This style of lifting beam is utilized with two cranes, where headroom is limited and comes standard with a swivel hook. Roller bearing hook standard on capacities 30 tons and over.

SDLB

STANDARD DUTY LIFTING BEAM I-BEAM DESIGN w/FLAME CUT BAIL

Standard I-Beam construction with integrated beam stands, this style of lifting beam can be utilized where headroom is limited and comes with a pair of shackles & swivel hooks with three standard spreads. Three standard lift points for load adjustment: outside lift point, middle lift point (outside less 1'), inside lift point (middle less 1').



UNVB

UNIVERSAL LIFTING/SPREADER BEAM

This style of lifting beam can be utilized as a lifting beam where headroom is limited or as a spreader beam where extra stability is required and comes supplied with one upper shackle for adjustable bail positions and two lower shackles for adjustable spreads.



SDLB

STANDARD DUTY LIFTING BEAM I-BEAM DESIGN w/PIN BAIL

Standard I-Beam construction with pin bail & integrated beam stands, this style of lifting beam can be utilized where headroom is limited and comes with a pair of shackles and three standard spreads. Three standard lift points for load adjustment: outside lift point, middle lift point (outside less 1'), inside lift point (middle less 1').



ALB

ADJUSTABLE LIFTING BEAM

This style of lifting beam can lift off center loads easily by adjusting the bail prior to the lift and come supplied with two lower shackles.



DO NOT EXCEED CAPACITY!
See the **SAFETY GUIDELINES** section before using these products. Pages 138-149.



Includes All Products
On This Page



ABLB

ADJUSTABLE BAIL LIFTING BEAM

This style of lifting beam can lift off center loads easily by adjusting the bail prior to the lift and comes standard with one outside spread and two swivel hooks.



LLB

LOAD LEVELING BEAM

This style of lifting beam can lift off center loads easily by adjusting the bail with the standard chain wheel prior to the lift, has unlimited adjustment within the span of the bail and comes standard with one outside spread and two swivel hooks.



TPLB

THREE POINT LIFTING BEAM

This style of lifting beam can be utilized where headroom is limited and when lifting objects that require multiple lift points.



FPLB

FOUR POINT LIFTING BEAM

This style of lifting beam can be utilized where headroom is limited and when lifting objects that require multiple lift points.



FPSL

FOUR POINT SACK LIFTER BEAM

This style of lifting beam is designed to lift bulk container sacks. Standard Sling Keeper design provides improved sling containment during the lift and smooth edge design minimizes wear on lifting straps.



FPAB

FOUR POINT ADJUSTABLE BEAM

This standard four point adjustable spread style of lifting beam can be utilized where headroom is limited and when lifting objects that require multiple lift points. It is supplied with four swivel hooks.



DCRB

DUAL CRANE ROTATING BEAM

This style of lifting beam is designed to be utilized with dual hoists and can rotate the load parallel.

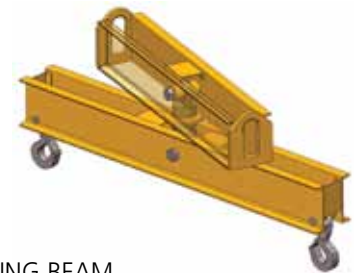

CGCLB

CHLORINE GAS CYLINDER LIFTING BEAM

This style of lifting beam is designed to lift chlorine gas cylinders.



DO NOT EXCEED CAPACITY!
See the SAFETY GUIDELINES section before using these products. Pages 138-149.

SPREADER BEAMS

Product Charts and additional options can be found online at www.peerlesschain.com/products/Peerless-Custom-Lifting-Devices or in the **Below-the-Hook & Material Handling Equipment catalog (27.15)**. Custom Application Forms can be found at www.peerlesschain.com/custom-order-forms.



Includes All Products
On This Page

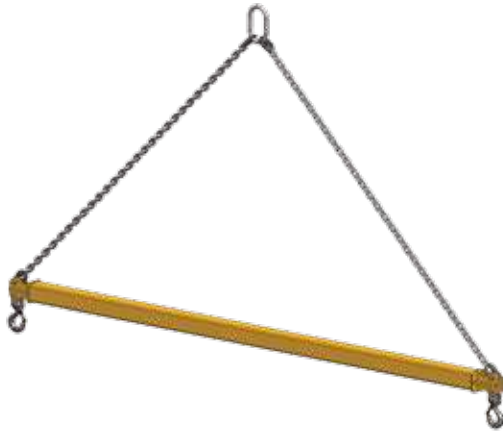

SDSB

STANDARD DUTY SPREADER BEAM

This style of lifter is utilized with upper rigging spread between two lift points that adds extra stability to the lift and comes standard with a pair of swivel hooks.



BXSB

BOX SPREADER BEAM

This style of spreader beam is designed to lift large bulky loads and can be rigged to handle objects with an offset center of gravity.



ATSB

ADJUSTABLE TELESCOPIC SPREADER BEAM

This style of spreader beam is telescopic to accommodate various load sizes – 2 through 15 ton capacities, adjustable increments at 1" and 20 through 40 ton capacities, adjustable increments at 12". It comes standard with a pair of swivel hooks.



ECSB

END CAP SPREADER BEAM

This style of lifter is utilized with upper rigging spread between two lift points that adds extra stability to the lift and comes standard with upper and lower shackles.



DO NOT EXCEED CAPACITY!
See the SAFETY GUIDELINES section before using these products. Pages 138-149.

SPREADER BEAMS, ROLL LIFTERS & TONGS



ROLL LIFTERS

Product Charts and additional options can be found online at www.peerlesschain.com/products/Peerless-Custom-Lifting-Devices or in the **Below-the-Hook & Material Handling Equipment catalog (27.15)**. Custom Application Forms can be found at www.peerlesschain.com/custom-order-forms.

Includes All Products
On This Page

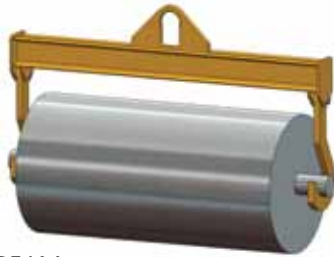

RLB

ROLL LIFTING BEAM

This style of lifting beam is designed to easily lift and position rolls by the mandrel/shaft (when it is through the center of the roll) with plate or bent bar J-hooks and comes with a pair of fixed or pivoting J-hooks.



MRL

MOTORIZED ROLL LIFTER

This style of lifter is designed to easily lift and position rolls by placing the lifting pins securely through the I.D. of the roll.

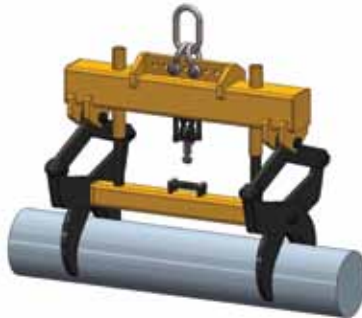

RGT

ROLL GRIPPING TONGS

This style of lifter is designed to easily lift and position rolls by gripping the outer diameter of the roll.



RLCH

ROLL LIFTING C-HOOK

This style of lifter is designed to easily lift and position rolls by placing the lifting arm securely through the I.D. of the roll and is supplied standard with lifter guide handle.

TONGS

Product Charts and additional options can be found online at www.peerlesschain.com/products/Peerless-Custom-Lifting-Devices or in the **Below-the-Hook & Material Handling Equipment catalog (27.15)**. Custom Application Forms can be found at www.peerlesschain.com/custom-order-forms.



BTF

Bar Tong Fixed

This style of fixed diameter tong is ideal for lifting round bars, cast or steel pipe.



BTA

Bar Tong Adjustable

This style of adjustable diameter tong is ideal for lifting round bars, cast or steel pipe of various diameters.



DO NOT EXCEED CAPACITY!
See the SAFETY GUIDELINES section before using these products. Pages 138-149.

COIL LIFTERS

Product Charts and additional options can be found online at www.peerlesschain.com/products/Peerless-Custom-Lifting-Devices or in the **Below-the-Hook & Material Handling Equipment catalog (27.15)**. Custom Application Forms can be found at www.peerlesschain.com/custom-order-forms.



Includes All Products
On This Page



CLNC

COIL LIFTER NARROW COIL

This style of lifter is designed to easily lift and position narrow coils by placing the lifting arm securely through the I.D. of the coil and is supplied with standard lifter guide handle and radius on lifting arm to minimize coil damage.



CLSC

COIL LIFTER SLIT COIL

This style of heavy duty lifter is designed to handle multiple slit coils maximizing efficiency and is supplied with standard lifter guide handle and curved saddle on lifting arm to minimize coil damage.

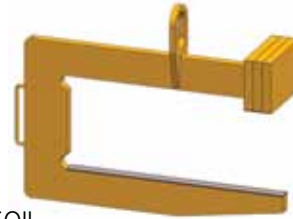

CL

COIL LIFTER

This style of heavy duty lifter is designed to easily lift and position large heavy coils by placing the lifting arm securely through the I.D. of the coil and is supplied with standard lifter guide handle and curved saddle on lifting arm to minimize coil damage.

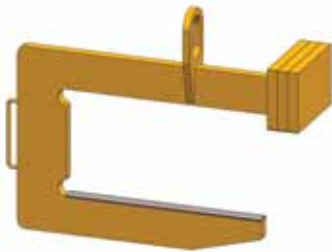

CLV

COIL LIFTER VERTICAL

This style of lifter is designed to handle coils that are stacked vertically and is supplied with standard leg positioning handle with built in positive locking feature.



CLCS

COIL LIFTER CLOSE STACKING

This style of heavy duty lifter is designed with a recessed counterweight to allow for close coil stacking that maximizes floor space and is supplied with standard lifter guide handle and curved saddle on lifting arm to minimize coil damage.



CLVW

COIL LIFTER VERTICAL WIDE

This style of lifter is designed to handle coils that are stacked vertically and is supplied with standard self-adjusting legs that automatically adjust to the I.D. of the coil.



CGV

COIL GRAB VERTICAL

This style of lifter is designed to handle coils that are stacked vertically and is supplied with manual adjusting legs that adjust to the I.D. of the coil with the standard hand wheel or optional chain wheel.



DO NOT EXCEED CAPACITY!
See the SAFETY GUIDELINES section before using these products. Pages 138-149.



Includes All Products
On This Page

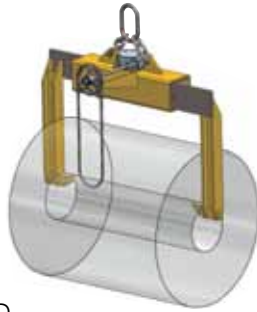

CLT

COIL LIFTER TELESCOPIC TWO-SIDED

This style of lifter is designed to efficiently handle coils with the eye horizontal.



NACL

NARROW ARM COIL LIFTER

This style of lifter is designed to economically handle coils with the eye horizontal and is supplied with standard plate style legs with rounded corners to minimize coil damage.

SHEET LIFTERS

Product Charts and additional options can be found online at www.peerlesschain.com/products/Peerless-Custom-Lifting-Devices or in the **Below-the-Hook & Material Handling Equipment catalog (27.15)**. Custom Application Forms can be found at www.peerlesschain.com/custom-order-forms.



SLHD

SHEET LIFTER HEAVY DUTY

This style of lifter is designed to lift and carry various sizes of bundles, sheets and/or plates.



SLLD

This style of lifter is designed to lift and carry various sizes of bundles, sheets and/or plates.

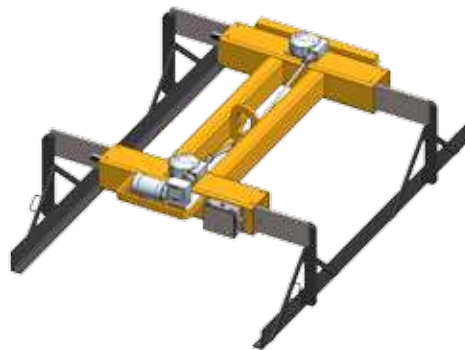

MSLHD

MOTORIZED SHEET LIFTER HEAVY DUTY

This style of lifter is designed to lift and carry various sizes of bundles, sheets and/or plates.



DO NOT EXCEED CAPACITY!
See the SAFETY GUIDELINES section before using these products. Pages 138-149.

PALLET LIFTERS

Product Charts and additional options can be found online at www.peerlesschain.com/products/Peerless-Custom-Lifting-Devices or in the **Below-the-Hook & Material Handling Equipment catalog (27.15)**. Custom Application Forms can be found at www.peerlesschain.com/custom-order-forms.



Includes All Products
On This Page



PL
FIXED FORK PALLET LIFTER

This style of lifter is designed to lift and carry palletized loads efficiently with an overhead crane.



PLHD
FIXED FORK HEAVY DUTY PALLET LIFTER

This style of lifter is designed with a double frame to lift and carry heavy palletized loads efficiently with an overhead crane.



PLAF
ADJUSTABLE FORK PALLET LIFTER

This style of lifter is designed to lift and carry palletized loads efficiently with an overhead crane and is supplied standard with manually adjustable forks that allow the lifter to handle various pallet sizes.



PLHA
ADJUSTABLE FORK HEAVY DUTY PALLET LIFTER

This style of lifter is designed with a double frame to lift and carry heavy palletized loads efficiently with an overhead crane and supplied standard with manually adjustable forks that allow the lifter to handle various pallet sizes.



PLHW
ADJUSTABLE FORK PALLET LIFTER

This style of lifter is designed to lift and carry palletized loads efficiently with an overhead crane and is supplied standard with a hand wheel to adjust forks to allow the lifter to handle various pallet sizes.



PLAH
ADJUSTABLE FORK HEAVY DUTY PALLET LIFTER
w/Hand Wheel

This style of lifter is designed with a double frame and forged forks to lift and carry heavy palletized loads efficiently with an overhead crane and is supplied standard with a hand wheel to adjust forks to allow the lifter to handle various pallet sizes.



DO NOT EXCEED CAPACITY!
See the SAFETY GUIDELINES section before using these products. Pages 138-149.

PALLET LIFTERS & FORK TRUCK ACCESSORIES



Includes All Products
On This Page



PLWL

WHEELED PALLET LIFTER

This style of lifter is designed to lift and carry palletized loads efficiently with an overhead crane and wheeled design allows for ease of movement to the load and dual lift points allow the lifter to hang level when unloaded.



PLLW

LIGHTWEIGHT PALLET LIFTER

This style of lifter is designed to lift and carry palletized loads efficiently with an overhead crane and lightweight design allows for ease of movement to the load and dual lift points allow the lifter to hang level when unloaded.

FORK TRUCK ACCESSORIES

Product Charts and additional options can be found online at www.peerlesschain.com/products/Peerless-Custom-Lifting-Devices or in the **Below-the-Hook & Material Handling Equipment catalog (27.15)**. Custom Application Forms can be found at www.peerlesschain.com/custom-order-forms.



TB

TELESCOPING FORK TRUCK BOOM

This style of fork truck attachment is designed to efficiently lift and carry loads with a telescoping boom and locking pin allowing for multiple hook positions and is supplied with standard restraining chain with grab hook and attached handle for ease of boom extension.

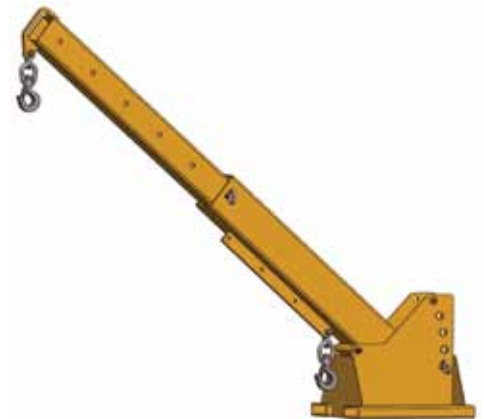

TBP

TELESCOPING PIVOT FORK TRUCK BOOM

This style of fork truck attachment is designed to efficiently lift and carry loads with a telescoping boom and locking pin allowing for multiple hook positions and is supplied with standard restraining chain with grab hook and attached handle for ease of boom extension.



FH

FORK TRUCK HOOK

This style of fork truck attachment is designed to efficiently lift and carry loads on the fork of a lift truck with a single latched fixed or swivel hook.



DO NOT EXCEED CAPACITY!
See the SAFETY GUIDELINES section before using these products. Pages 138-149.

FORK TRUCK ACCESSORIES cont.



Includes All Products
On This Page



FHB

FORK TRUCK HOOK BEAM

This style of fork truck attachment is designed to efficiently lift and carry loads on both forks of a lift truck with a single latched fixed or swivel hook.

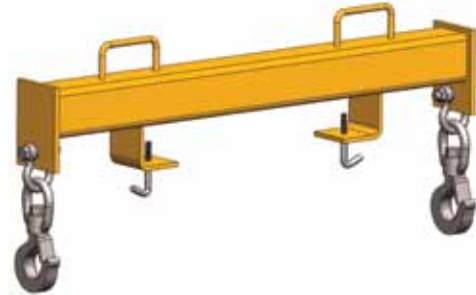

FHBD

Fork Truck Double Hook Beam

This style of fork truck attachment is designed to efficiently lift and carry loads on both forks of a lift truck with two latched swivel hooks.

MATERIAL HANDLING

Product Charts and additional options can be found online at www.peerlesschain.com/products/Peerless-Custom-Lifting-Devices or in the **Below-the-Hook & Material Handling Equipment catalog (27.15)**. Custom Application Forms can be found at www.peerlesschain.com/custom-order-forms.



MSHD

Material Stands Heavy Duty

This style of material handling equipment is designed to hold product at a preset work height.



MBHD

Material Baskets Heavy Duty

This style of material handling equipment is designed to lift, transport and contain product effectively and efficiently.



DO NOT EXCEED CAPACITY!
See the SAFETY GUIDELINES section before using these products. Pages 138-149.

CARGO CONTROL

Grade 70 Transport Chain	56-57
Binder Chain Assemblies	58-60
Load Binders	61-64
Strap Assemblies & Accessories	65-69
Bulk Strap Hardware	70
Winches & Winch Bars	70-72
Corner Guards & Hard Parts	72
Rubber Tie-Downs	73
Auto Tie-Downs	74
Tow Straps	75
Cable Pullers	75
Ag & Utility Trailer Safety Chains	76-77
Winch Line Tail Chain	77
Cargo Bars	78-80
Coil Racks	80



CARGO CONTROL

Grade 70 Domestic Transport Chain (NACM)



Transport chain is considered the chain of choice for load binding applications. It is also well suited for tie-downs, towing and logging operations. Its strength to weight ratio exceeds that of Proof Coil and High Test. Transport chain meets Department of Transportation regulations. Order unit is foot. **NOT FOR OVERHEAD LIFTING**



Full Drum

Stock #	Trade Size		Wire Dia. (Inches)	Inside Link Dim. (Inches)		Ft. Per Drum	Net Wt. (Lbs.)	Working Load Limit	
	Inches	MM		Length (Nominal)	Width (Min.)			Lbs.	Kgs.
5041253	1/4	7	0.274	1.236	0.480	800	508	3,150	1,429
5040353*	5/16	8	0.334	1.120	0.480	550	550	4,700	2,132
5041453	3/8	10	0.392	1.374	0.551	400	544	6,600	2,994
5041653	1/2	13	0.510	1.782	0.750	200	460	11,300	5,127
5040853	5/8	16	0.625	2.016	0.851	150	521	15,800	7,166

*Made to Short Link specs

Half Drum

Stock #	Trade Size		Wire Dia. (Inches)	Inside Link Dim. (Inches)		Ft. Per Drum	Net Wt. (Lbs.)	Working Load Limit	
	Inches	MM		Length (Nominal)	Width (Min.)			Lbs.	Kgs.
5041254	1/4	7	0.274	1.236	0.480	400	254	3,150	1,429
5040354*	5/16	8	0.334	1.120	0.480	275	275	4,700	2,132
5041454	3/8	10	0.392	1.374	0.551	200	272	6,600	2,994
5041654	1/2	13	0.510	1.782	0.750	100	230	11,300	5,127
5040854	5/8	16	0.625	2.016	0.851	75	261	15,800	7,166

*Made to Short Link specs



All G70 domestic chain (5/16, 3/8, 1/2) is stamped with the Working Load Limit every 10 links as shown.

4 & 5 Gallon Square Pail

Stock #	Trade Size		Wire Dia. (Inches)	Inside Link Dim. (Inches)		Ft. Per Pail	Net Wt. (Lbs.)	Working Load Limit	
	Inches	MM		Length (Nominal)	Width (Min.)			Lbs.	Kgs.
5340355*	5/16	8	0.334	1.120	0.480	60	62	4,700	2,132
5340455	3/8	10	0.392	1.374	0.551	40	56	6,600	2,994
5440255	1/4	7	0.274	1.236	0.480	150	96	3,150	1,429
5440355*	5/16	8	0.334	1.120	0.480	100	100	4,700	2,132
5440455	3/8	10	0.392	1.374	0.551	75	102	6,600	2,994

*Made to Short Link specs



Box

Stock #	Trade Size		Wire Dia. (Inches)	Inside Link Dim. (Inches)		Ft. Per Box	Net Wt. (Lbs.)	Working Load Limit	
	Inches	MM		Length (Nominal)	Width (Min.)			Lbs.	Kgs.
5454255	1/4	7	0.274	1.236	0.480	225	148	3,150	1,429
5454355*	5/16	8	0.334	1.120	0.480	150	156	4,700	2,132
5454455	3/8	10	0.392	1.374	0.551	100	140	6,600	2,994

*Made to Short Link specs



Find Transport chain accessories on page 99-100.



DO NOT EXCEED CAPACITY!
See the SAFETY GUIDELINES section before using these products. Pages 138-149.

Grade 70 Import Transport Chain (Short Link)

Grade 70 was designed specifically to provide a light, yet strong chain for binding, tie-downs, towing and construction use. Made from a variety of medium carbon and alloy materials. Induction heat treated, the chain meets all requirements set by the Department of Transportation (DOT), CCMTA & CVSA for truck tie-down use. Manufactured to ASTM 80 short link specs or NACM long link specs for reduced weight. Order unit is foot. **NOT FOR OVERHEAD LIFTING**

Full Drum

Stock #	Trade Size		Wire Dia. (Inches)	Inside Link Dim. (Inches)		Ft. Per Drum	Net Wt. (Lbs.)	Working Load Limit	
	Inches	MM		Length (Nominal)	Width (Min.)			Lbs.	Kgs.
Yellow Zinc									
H0316-0420	1/4	7	0.281	0.980	0.410	800	570	3,150	1,429
H0316-0520	5/16	8	0.343	1.100	0.470	550	630	4,700	2,132
H0316-0620	3/8	10	0.406	1.190	0.550	400	615	6,600	2,994
H0316-0820	1/2	13	0.531	1.600	0.750	200	526	11,300	5,127
H0316-0920	5/8	16	0.630	2.020	0.850	150	563	15,800	7,166

Half Drum

Stock #	Trade Size		Wire Dia. (Inches)	Inside Link Dim. (Inches)		Ft. Per Drum	Net Wt. (Lbs.)	Working Load Limit	
	Inches	MM		Length (Nominal)	Width (Min.)			Lbs.	Kgs.
Yellow Zinc									
H0314-0420	1/4	7	0.281	0.980	0.410	400	285	3,150	1,429
H0314-0520	5/16	8	0.343	1.100	0.470	275	326	4,700	2,132
H0314-0620	3/8	10	0.406	1.190	0.550	200	308	6,600	2,994
H0314-0820	1/2	13	0.531	1.600	0.750	100	263	11,300	5,127

5 Gallon Round Pail

Stock #	Trade Size		Wire Dia. (Inches)	Inside Link Dim. (Inches)		Ft. Per Pail	Net Wt. (Lbs.)	Working Load Limit	
	Inches	MM		Length (Nominal)	Width (Min.)			Lbs.	Kgs.
Yellow Zinc									
H0310-0420	1/4	7	0.281	0.980	0.410	150	110	3,150	1,429
H0310-0520	5/16	8	0.343	1.100	0.470	100	118	4,700	2,132
H0310-0620	3/8	10	0.406	1.190	0.550	75	115	6,600	2,994

Grade 70 Import Transport Chain (NACM) - Full Drum

Stock #	Trade Size		Wire Dia. (Inches)	Inside Link Dim. (Inches)		Ft. Per Drum	Net Wt. (Lbs.)	Working Load Limit	
	Inches	MM		Length (Nominal)	Width (Min.)			Lbs.	Kgs.
Yellow Zinc									
H0317-0420	1/4	7	0.281	1.240	0.380	800	540	3150	1429
H0317-0520	5/16	8	0.343	1.290	0.440	550	586	4700	2132
H0317-0620	3/8	10	0.406	1.380	0.550	400	584	6600	2994
H0317-0820	1/2	13	0.531	1.790	0.720	200	500	11300	5127



DO NOT EXCEED CAPACITY!
See the SAFETY GUIDELINES section before using these products. Pages 138-149.

Binder Chain Assemblies

Peerless can provide binder chain assemblies for all your tie-down requirements. Meets DOT/CVSA/CCMTA requirements. **NOT FOR OVERHEAD LIFTING**



G80 Binder Chain Assembly - NACM

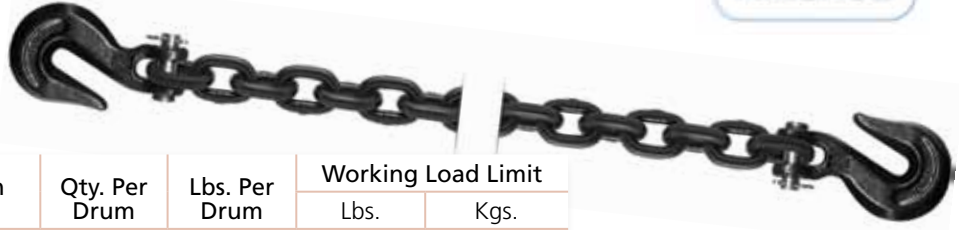

Stock #	Trade Size (Inches)	Length (Feet)	Qty. Per Drum	Lbs. Per Drum	Working Load Limit	
					Lbs.	Kgs.
8607617	3/8	20	10	310	7,100	3,220
8610503	1/2	10	10	285	12,000	5,553
8607630	1/2	20	10	532	12,000	5,553

G70 Binder Chain Assembly - NACM



Stock #		Trade Size (Inches)	Length (Feet)	Qty. Per Drum	Lbs. Per Drum	Qty. Per Ctn.	Lbs. Per Ctn.	Working Load Limit	
Drum	Carton							Lbs.	Kgs.
5261063*	5261060*	5/16	14	25	390	1	16	4,700	2,132
5261154**	--	5/16	16	25	443	--	--	4,700	2,132
5261163*	5261160*	5/16	16	25	443	1	18	4,700	2,132
5261363*	5261360*	5/16	20	25	600	1	24	4,700	2,132
5261463*	5261460*	5/16	25	25	600	1	30	4,700	2,132
5262063	5262060	3/8	14	25	600	1	24	6,600	2,994
5262163	5262160	3/8	16	25	500	1	25	6,600	2,994
5262354**	--	3/8	20	25	722	--	--	6,600	2,994
5262363	5262360	3/8	20	25	722	1	34	6,600	2,994
5262463	5262460	3/8	25	20	500	1	41	6,600	2,994
8605182	8610107	1/2	20	10	560	1	56	11,300	5,126



All G70 domestic chain (5/16, 3/8, 1/2) is stamped with the Working Load Limit every 10 links as shown.

*Made to short link specs. ** UPC Tagged

G43 Binder Chain Assembly - NACM

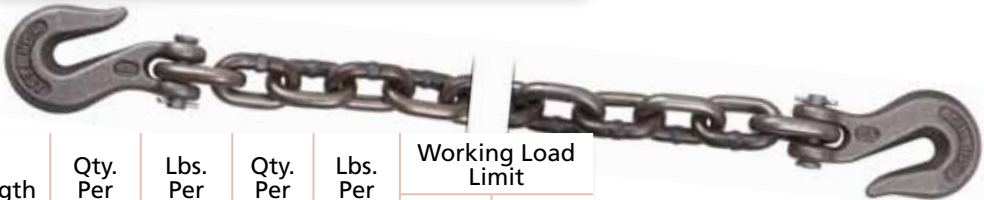

Stock #		Trade Size (Inches)	Length (Feet)	Qty. Per Drum	Lbs. Per Drum	Qty. Per Ctn.	Lbs. Per Ctn.	Working Load Limit	
Drum	Carton							Lbs.	Kgs.
5239462	5239460	5/16	20	25	476	1	19	3,900	1,769
5233462	5233460	3/8	14	25	525	1	21	5,400	2,449
5234462	5234460	3/8	16	25	600	1	24	5,400	2,449
5231424**	--	3/8	20	25	750	--	--	5,400	2,449
5234424**	--	3/8	16	25	600	--	--	5,400	2,449
5231462	5231460	3/8	20	25	750	1	30	5,400	2,449
5231262	5231260	3/8	25	20	720	1	36	5,400	2,449

** UPC Tagged



DO NOT EXCEED CAPACITY!
See the SAFETY GUIDELINES section before using these products. Pages 138-149.

Binder Chain Assemblies Cont.

T80 Binder Chain Assembly - Short Link

T80 Alloy chain assemblies come in a black finish. Meets DOT/CVSA/CCMTA requirements. Packaged bulk in drums or each in retail single packs.

NOT FOR OVERHEAD LIFTING

ASTM Spec. short link for longer life.

Stock #		Trade Size (Inches)	Length (Feet)	Qty. Per Drum	Lbs. Per Drum	Qty. Per Carton	Lbs. Per Carton	Working Load Limit	
Drum	Carton							Lbs.	Kgs.
H3334-5524	H3340-5524	3/8	16	20	520	1	26	7,100	3,220
H3334-5624	H3340-5624	3/8	20	20	640	1	32	7,100	3,220
H3334-6124	H3340-6124	1/2	15	10	430	1	43	12,000	5,443
H3334-6224	H3340-6224	1/2	20	10	550	1	55	12,000	5,443



G70 Binder Chain Assembly - Short Link

G70 assemblies have a yellow zinc finish for easier identification and for protection of the chain. Meets DOT/CVSA/CCMTA requirements. Packaged bulk in drums or each in retail single packs.

NOT FOR OVERHEAD LIFTING

ASTM Spec. short link for longer life.



Stock #		Trade Size (Inches)	Length (Feet)	Qty. Per Drum	Lbs. Per Drum	Qty. Per Carton	Lbs. Per Carton	Working Load Limit	
Drum	Carton							Lbs.	Kgs.
H3226-5020	H3240-5020	5/16	14	30	450	1	15	4,700	2,132
H3226-5120	H3240-5120	5/16	16	30	600	1	20	4,700	2,132
H3226-5220	H3240-5220	5/16	20	25	600	1	24	4,700	2,132
H3226-5320	H3240-5320	5/16	25	20	600	1	30	4,700	2,132
H3226-5420	H3240-5420	5/16	30	15	640	1	32	4,700	2,132
H3226-5920	H3240-5920	3/8	12	30	660	1	22	6,600	2,994
H3226-5720	H3240-5720	3/8	14	25	600	1	24	6,600	2,994
H3226-5520	H3240-5520	3/8	16	20	500	1	25	6,600	2,994
H3226-5620	H3240-5620	3/8	20	20	680	1	34	6,600	2,994
H3226-5820	H3240-5820	3/8	25	15	615	1	41	6,600	2,994
H3226-6020	H3240-6020	1/2	10	20	560	1	48	11,300	5,126
H3226-6120	H3240-6120	1/2	15	10	440	1	44	11,300	5,126
H3226-6220	H3240-6220	1/2	20	10	560	1	56	11,300	5,126



DO NOT EXCEED CAPACITY!
See the SAFETY GUIDELINES section before using these products. Pages 138-149.



G70 Binder Chain Assembly - NACM

NACM spec long link chain has a longer pitch link for less weight per assembly. Pitch is the inside length measurement of a link. **NOT FOR OVERHEAD LIFTING**

Stock #	Trade Size (Inches)	Length (Feet)	Qty. Per Drum	Lbs. Per Drum	Working Load Limit	
					Lbs.	Kgs.
H3275-5220	5/16	20	25	550	4,700	2,132
H3275-5620	3/8	20	20	620	6,600	2,994

G70 Binder Chain Assembly - With Eye Grab Hooks - Short Link

NOT FOR OVERHEAD LIFTING



ASTM Spec. short link for longer life.

Stock #		Trade Size (Inches)	Length (Feet)	Qty. Per Drum	Lbs. Per Drum	Qty. Per Carton	Lbs. Per Carton	Working Load Limit	
Drum	Carton							Lbs.	Kgs.
H3226-5580	H3240-5580	3/8	16	20	500	1	25	6,600	2,994
H3226-5680	H3240-5680	3/8	20	20	640	1	32	6,600	2,994

G43 Binder Chain Assembly - short Link

High Test chain assemblies come in a self color tumbled finish. Meets DOT/CVSA/CCMTA requirements. Packaged bulk in drums or each in retail single packs. **NOT FOR OVERHEAD LIFTING**

ASTM Spec. short link for longer life.

Stock #		Trade Size (Inches)	Length (Feet)	Qty. Per Drum	Lbs. Per Drum	Qty. Per Carton	Lbs. Per Carton	Working Load Limit	
Drum	Carton							Lbs.	Kgs.
H3132-5205	H3140-5205	5/16	20	25	600	1	24	3,900	1,769
H3132-5605	H3140-5605	3/8	20	20	580	1	29	5,400	2,449



Binder Chain Assembly Usage Chart

Calculating the minimum number of Tie-Downs depends on the cargo length, cargo weight and cargo type. The sum of the working load limits from all Tie-Downs must be at least 50% of the weight of the cargo.

Articles 5' or shorter require 1 Tie-Down. Articles 5' or shorter and weighing more than 1100 Lbs. require 2 Tie-Downs. Articles more than 5' up thru 10' require 2 Tie-Downs. Add an additional Tie-Down for articles more than 10' and for each additional 10' or part thereof. (Articles prevented from forward movement by a bulkhead or another load require a Tie-Down for every 10' and for each 10' or part thereof.)

Wheeled or tracked vehicles over 10,000 Lbs. require a minimum of 4 Anchor (Direct) Tie-Downs and 4 Tightening Devices – each with a minimum working load limit of 5000 Lbs. Anchor Tie-Downs are a direct connection between the load and the trailer. All accessory attachments such as booms, shovels, and backhoes must be lowered and properly secured - usually with an additional Tie-Down and Tie-Down Device.

Indirect Tie-Downs (not Anchor Tie-Downs) should form a minimum angle of 30 degrees to the trailer floor. Steel coils, paper rolls, concrete pipe, dressed lumber, boulders, flattened cars, automobiles, light trucks, vans, and containers require special calculations. Always consult FMCSA regarding special applications.

This chart is provided as a guide to meet the basic minimum current in-service requirements in accordance to the FMCSA† and the DOT‡. The following table lists the minimum number of chain assemblies required to secure a load per DOT, CVSA§ and CCMTA. *This chart is only to be used as a reference.

†FMCSA:
Federal Motor Carrier Safety Admin.

‡DOT:
Department of Transportation

§CVSA:
The Commercial Vehicle Safety Alliance

CMTA:
Council of Motor Transportation Administrators

Chain Grade	Chain Size		Working Load Limit (WLL)		Net weight of cargo to be secured in Lbs. (kg.)								
	Inches	MM	Lbs.	Kg	10,000	15,000	20,000	25,000	30,000	35,000	40,000	45,000	50,000
					(4,540)	(6,800)	(9,070)	(11,334)	(13,608)	(15,876)	(18,144)	(20,412)	(22,680)
Alloy G100	9/32	7	4,300	1,950	2	2	3	3	4	4	5	6	6
	5/16	8	5,700	2,600	1	2	2	3	3	4	4	5	5
	3/8	10	8,800	4,000	1	1	2	2	2	2	3	3	3
	1/2	13	15,000	6,800	1	1	1	1	1	2	2	2	2
	5/8	16	22,600	10,300	1	1	1	1	1	1	1	1	2
Alloy G80	9/32	7	3,500	1,570	2	3	3	4	5	5	6	7	8
	5/16	8	4,500	2,000	2	2	3	3	4	4	5	5	6
	3/8	10	7,100	3,200	1	2	2	2	3	3	3	4	4
	1/2	13	12,000	5,400	1	1	1	2	2	2	2	2	3
	5/8	16	18,100	8,200	1	1	1	1	1	1	2	2	2
Transport G70	1/4	7	3,150	1,430	2	3	4	4	5	6	7	8	8
	5/16	8	4,700	2,130	2	2	3	3	4	4	5	5	6
	3/8	10	6,600	2,990	1	2	2	2	3	3	4	4	4
	1/2	13	11,300	5,130	1	1	1	2	2	2	2	2	3
	5/8	16	15,800	7,170	1	1	1	1	1	2	2	2	2
High Test G43	1/4	7	2,600	1,180	2	3	4	5	6	7	8	9	10
	5/16	8	3,900	1,770	2	2	3	4	4	5	6	6	7
	3/8	10	5,400	2,450	1	2	2	3	3	4	4	5	5
	1/2	13	9,200	4,170	1	1	2	2	2	2	3	3	3

Load Binders



Lever Loadbinder



Stock #	Chain Size (In.)		Take-Up (In.)	Handle Length (In.)	Qty. Per Pkg.	Lbs. Per Pkg.	Working Load Limit	
	G70	G43					Lbs.	Kgs.
Blue	G70	G43						
5200120	-	1/4	3.00	11.00	4	13	2,600	1,179
5200420	5/16	3/8	5.00	15.50	4	32	5,400	2,449



Ratchet Loadbinder



Stock #	Chain Size (In.)		Take-Up (In.)	Handle Length (In.)	Qty. Per Pkg.	Lbs. Per Pkg.	Working Load Limit	
	G70	G43					Lbs.	Kgs.
5200320	5/16	3/8	8.00	15.50	4	50	5,400	2,449
*5200675	3/8	1/2	8.00	14.00	4	50	9,200	4,173

*Red in color



DO NOT EXCEED CAPACITY!
See the SAFETY GUIDELINES section before using these products. Pages 138-149.

Load Binders



3 position pawl.



Tamper resistant.

QuikBinder™ A Ratchet Load Binder Like No Other

The QuikBinder™ offers higher working load limits than standard ratchet load binders, and is designed for use with either Grade 70 Transport, Grade 80, or Grade 100 Alloy tie-down chains.

The QuikBinder™ is also easier to install than standard ratchet loadbinders. The 3-position pawl offers the user a choice of ratchet extension, ratchet take-up or a “free spin” setting for fast adjustment in either direction. A load can be secured in half the time. It is available in three sizes and features a vinyl coated barrel for a strong, comfortable grip.

The folding handle makes the QuikBinder™ safer (no handle sticking out) and more convenient to use. Simply fold the handle down after the load is secure or when storing on your cab rack. Stronger, faster, safer and more functional than standard ratchet binders.

The QuikBinder™ can be locked to the tie-down chain with a long shank padlock, making it more difficult to tamper with the binder, assembly or the load. Padlocks with programmable combinations are also available.

Our loadbinders meet all DOT/CVSA/CCMTA requirements. The special hook construction supports the load of the chain and will not bind. Loadbinders are heat treated and proof tested with forged heat treated hooks. The Working Load Limit is permanently marked on the handle. Our loadbinders feature special links with controlled flash welds.

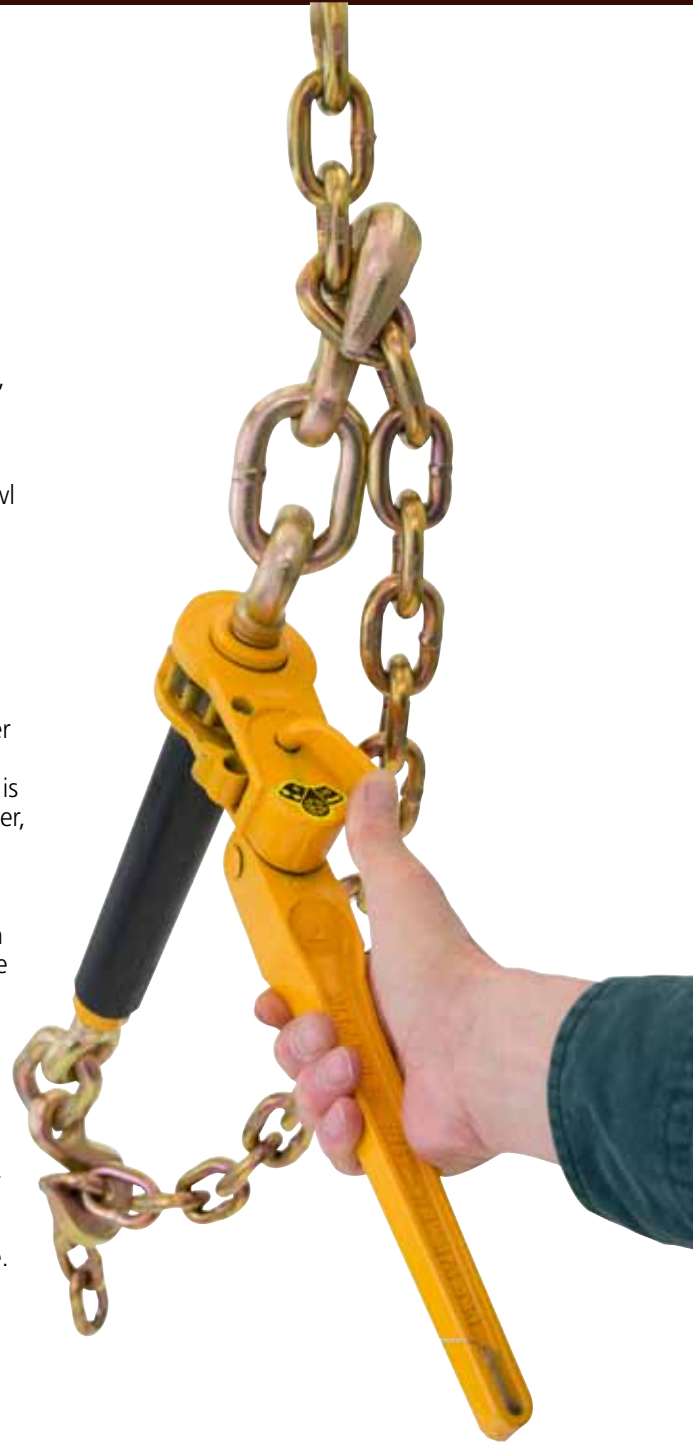
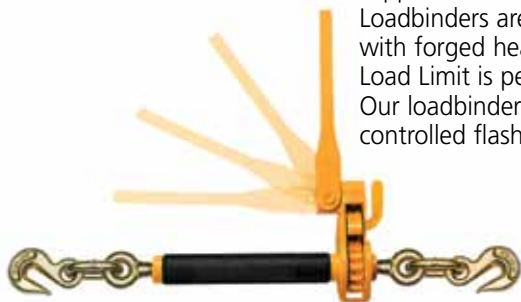

QuikBinder™ Ratchet Loadbinder

Stock #	Chain Grade and Size (Inches)			Take-up (Inches)	Handle Length (In.)		Qty. Per Package	Lbs. Per Package	Working Load Limit	
	G70	G80	G100		Folded	Straight			Lbs.	Kgs.
H5125-0658	5/16 & 3/8	5/16 & 3/8	5/16	6.00	9.50	13.90	4	46	7,100	3,220
H5125-0858	3/8 & 1/2	3/8 & 1/2	3/8	6.00	9.50	13.90	4	56	12,000	5,443
H5125-0958	1/2 & 5/8	1/2 & 5/8	1/2	6.00	9.50	13.90	2	37	18,100	8,210



DO NOT EXCEED CAPACITY!
See the SAFETY GUIDELINES section before using these products. Pages 138-149.

Load Binders Cont.

Our loadbinders meet all DOT/CVSA/CCMTA requirements. Special hook construction supports the load of the chain and will not bind. Loadbinders are heat treated and proof tested with forged heat treated hooks. The Working Load Limit is permanently marked on handle. All loadbinders feature special links with controlled flash welds and are painted with yellow, powdercoat enamel.

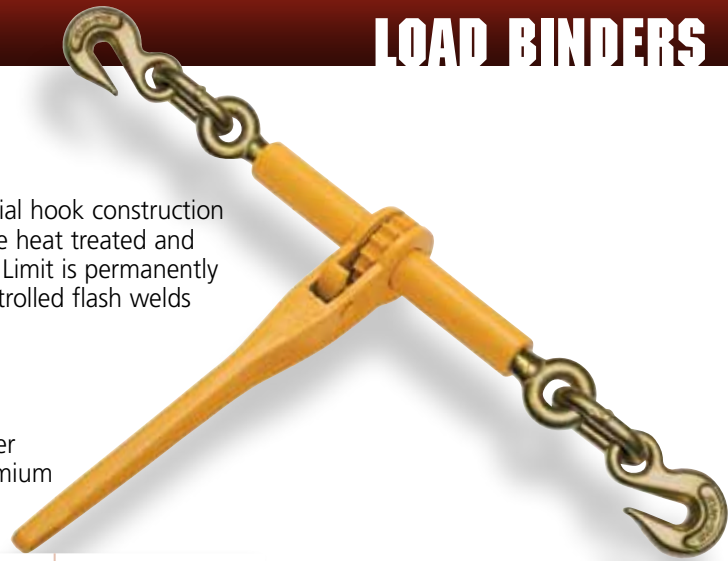

Ratchet Binder Plus Loadbinder

Ratchet Binder Plus has higher strength ratings for use with either Grade 70 Transport or Grade 80 Alloy tie-down chains. This premium binder features high quality yellow zinc plated hooks.

Stock #	Chain Size G70 or G80 (Inches)	Take-Up (Inches)	Handle Length (Inches)	Qty. Per Package	Lbs. Per Package	Working Load Limit	
						Lbs.	Kgs.
H5121-4158	5/16 or 3/8	6.50	13.92	2	22	7,100	3,220
H5121-4258	3/8 or 1/2	6.50	13.92	2	28	12,000	5,443
H5121-4458	1/2 or 5/8	6.50	13.92	2	35	18,100	8,210



Ratchet Loadbinder

Stock #	Chain Size (Inches)		Take-Up (Inches)	Handle Length (Inches)	Qty. Per Package	Lbs. Per Package	Working Load Limit	
	G70	G43					Lbs.	Kgs.
H5123-4052	1/4	5/16	5.00	6.75	2	9	3,900	1,769
H5123-4152	5/16	3/8	6.50	13.92	2	22	5,400	2,449
H5123-4252	3/8	1/2	6.50	13.92	2	26	9,200	4,173
H5123-4452	1/2	5/8	6.50	13.92	2	32	13,000	5,897

ProLok66™ Adjustable Lever Loadbinder

Our adjustable lever loadbinder features the ultimate in ease and versatility in a lever binder with the added safety of a self-locking handle.

ProLok66™ has a built-in knurled adjustable nut feature so the binder doesn't have to be repositioned on the chain (like standard lever binders) to achieve the best possible fit and perfect tension on the chain. The binder adjusts a full 2" to give the user optimum link location. No more problems getting that last extra half link hook-up. The handle's safety latch is automatically engaged when the handle is closed. This locks the handle in the closed position until it is released. This features makes our adjustable binder safer than standard lever binders. The convenient thumb-release latch is easy to use and has no loose parts to misplace.

Stock #	Chain Size G70 (Inches)	Take-Up (Inches)	Handle Length (Inches)	Qty. Per Pack- age	Lbs. Per Pack- age	Working Load Limit	
						Lbs.	Kgs.
H5025-0652	5/16 or 3/8	3.75	15.43	4	43	6,600	2,994



DO NOT EXCEED CAPACITY!
See the SAFETY GUIDELINES section before using these products. Pages 138-149.

Forged Safety Release Lever Loadbinder

This binder design allows the user to release the binder tension without any kickback of the handle typical of a lever style binder. The center body of the binder independently rotates, free of the handle, to release the tension smoothly and easily. This eliminates the chance for injuries from the handle swinging with substantial force when released.

The safety release handle makes this loadbinder less dangerous than other lever style loadbinders on the market today.



Stock #	Chain Size (In.)		Take-Up (In.)	Handle Length (In.)	Qty. Per Pkg.	Lbs. Per Pkg.	Working Load Limit	
	G70	G43					Lbs.	Kgs.
Yellow	G70	G43						
H5250-0658	5/16	3/8	4.00	13.00	4	39	6,600	2,994
H5250-4252	3/8	1/2	4.75	17.24	4	58	9,200	4,173

Lever Loadbinder

Stock #	Chain Size (In.)		Take-Up (Inches)	Handle Length (Inches)	Qty. Per Pkg.	Lbs. Per Pkg.	Working Load Limit	
	G70	G43					Lbs.	Kgs.
Yellow	G70	G43						
H5023-4052	---	1/4	3.00	11.42	6	21	2,600	1,179
H5023-4152	5/16	3/8	3.75	15.43	6	50	5,400	2,449
H5023-4252	3/8	1/2	4.25	17.24	6	73	9,200	4,173
H5023-4452	1/2	5/8	4.75	21.00	4	80	13,000	5,897

Fully Forged Lever Loadbinder

Stock #	Chain Size (In.)		Take-Up (Inches)	Handle Length (Inches)	Qty. Per Pkg.	Lbs. Per Pkg.	Working Load Limit	
	G70	G43					Lbs.	Kgs.
Yellow	G70	G43						
H5225-4152	5/16	3/8	4	15.75	6	48	5,400	2,449
H5225-4252	3/8	1/2	4.75	17.35	6	76	9,200	4,173

Forged Compression Lever Loadbinder

Stock #	Chain Size (In.)		Take-Up (In.)	Handle Length (In.)	Qty. Per Pkg.	Lbs. Per Pkg.	Working Load Limit	
	G70	G43					Lbs.	Kgs.
Yellow	G70	G43						
H5275-4152	5/16	3/8	3.00	15.75	2	30	5,400	2,449
H5275-4252	3/8	1/2	4.00	17.36	2	39	9,200	4,173



Mini Binder

Stock #	Take-Up (Inches)	Handle Length (Inches)	Qty. Per Pkg.	Lbs. Per Pkg.	WLL.	
					Lbs.	Kgs.
Yellow						
H5027-0352	1.85	9.05	12	20	250	113



DO NOT EXCEED CAPACITY!
See the SAFETY GUIDELINES section before using these products. Pages 138-149.

Premium 1" Polyester Straps

All 1" strap assemblies are packaged in tamper-resistant, durable, sonic welded "clam shells". These retail packages are slotted for pegboard hooks and will also stand for counter display. Each package includes complete instructions for use. These versatile straps are great for securing boats, motorcycles, ATVs, etc.

Blue and black 1" straps feature 4,500 Lb. webbing.



Ratchet Tie-Down - With J-Hooks

Strap features a plated "J" hook and floating "D" ring on each end that can be secured through truck stake holes, eye bolts, etc. Premium ratchet-style buckle for easy tightening.

Stock #	Color	Length (Feet)	Qty. Per Package	Lbs. Per Package	Working Load Limit	
					Lbs.	Kgs.
CC1116	Blue	16	10	18	500	227
CC1120*	Blue	20	10	21	1,100	500

**HD Ratchet*

Utility Lashing Strap - With Easy Release CAM Buckle

This universal strap secures anything with a circumference of less than assembly length. Loose end feeds through easy release CAM buckle.

Stock #	Color	Length (Feet)	Qty. Per Package	Lbs. Per Package	Working Load Limit	
					Lbs.	Kgs.
CC1412	Black	2 @ 8	10 Pr.	11	500	227



Easy Release Tie-Down - With S-Hooks

Strap features one vinyl coated hook, one zinc plated hook and an easy release CAM buckle.

Stock #	Color	Length (Feet)	Qty. Per Package	Lbs. Per Package	Working Load Limit	
					Lbs.	Kgs.
CC1612	Black	2 @ 6	10 Pr.	18	500	227
CC1616	Black	16	10	13	500	227

Ratchet Tie-Down - With S-Hooks

One vinyl coated hook, one zinc plated hook. Premium ratchet-style buckle for easy tightening.

Stock #	Color	Length (Feet)	Qty. Per Package	Lbs. Per Package	Working Load Limit	
					Lbs.	Kgs.
CC1815	Blue	15	10	19	500	227
CC1885*	Blue	15	10	22	1,100	500

**HD Ratchet*



DO NOT EXCEED CAPACITY!
See the SAFETY GUIDELINES section before using these products. Pages 138-149.

2" Ratchet Strap Assemblies

All heavy duty 2" cargo strap assemblies are made from premium, yellow, 10,000 Lb. tensile strength tested, polyester webbing for maximum durability. Meets all the requirements of the U.S. Department of Transportation (DOT), Canadian Council of Motor Transport Administrators (CCMTA) and Commercial Vehicle Safety Alliance (CVSA). 2" inline strap assemblies come standard with a 12" fixed end.

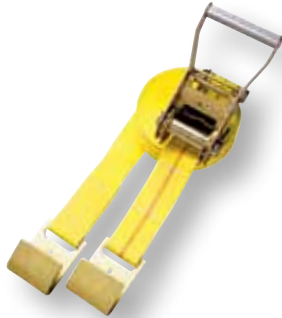

Wide Handle Ratchet - With Flat Hooks

Stock #	Color	Length (Feet)	Qty. Per Package	Lbs. Per Package	Working Load Limit	
					Lbs.	Kgs.
CC2627	Yellow	27	8	46	3,300	1,497
CC2630	Yellow	30	8	49	3,300	1,497
CC2640	Yellow	40	4	26	3,300	1,497

Wide Handle Ratchet - With J-Hooks

Stock #	Color	Length (Feet)	Qty. Per Package	Lbs. Per Package	Working Load Limit	
					Lbs.	Kgs.
CC2827	Yellow	27	8	45	3,300	1,497
CC2830	Yellow	30	8	48	3,300	1,497
CC2557*	Yellow	27	8	77	3,300	1,497



2" Ratchet Strap Components



2" Inline Adjustable End Strap - With Hardware

Stock #	Color	Type	Length (Feet)	Qty. Per Pkg.	Lbs. Per Pkg.	Working Load Limit	
						Lbs.	Kgs.
CC2029	Yellow	Flat Hook	29	8	21	3,300	1,497
CC2059	Yellow	J-Hook	29	8	22	3,300	1,497
CC2079	Yellow	Chain & Hook	29	8	40	3,300	1,497

2" Inline Fixed End Strap - With Hardware

Stock #	Color	Type	Length (Inches)	Qty. Per Pkg.	Lbs. Per Pkg.	Working Load Limit	
						Lbs.	Kgs.
CC2082	Yellow	J-Hook	12	8	6	3,300	1,497
CC2083	Yellow	Flat Hook	12	8	7	3,300	1,497
CC2085	Yellow	Chain & Hook	30	8	26	3,300	1,497

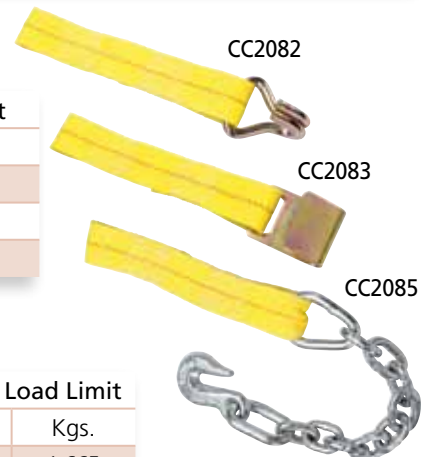

Replacement Ratchet



Stock #	Type	Size (Inches)	Qty. Per Pkg.	Lbs. Per Pkg.	Working Load Limit	
					Lbs.	Kgs.
CC2094	Short Wide	2	8	19	3,670	1,665



DO NOT EXCEED CAPACITY!
See the SAFETY GUIDELINES section before using these products. Pages 138-149.

3" Ratchet Strap Assemblies

All heavy duty 3" cargo strap assemblies are made from premium, yellow, 12,000 Lb. tensile strength tested, polyester webbing for maximum durability. Meets all requirements of the U.S. Department of Transportation (DOT), Canadian Council of Motor Transport Administrators (CCMTA) and Commercial Vehicle Safety Alliance (CVSA). 3" inline strap assemblies come standard with a 18" fixed end.

Flat Hook Strap Assembly

Stock #	Length (Feet)	Qty. Per Package	Lbs. Per Package	Working Load Limit	
				Lbs.	Kgs.
CC3030	30	8	38	4,000	1,814



Standard Handle Ratchet - With Flat Hooks

Stock #	Length (Feet)	Qty. Per Package	Lbs. Per Package	Working Load Limit	
				Lbs.	Kgs.
CC3626	27	4	50	4,000	1,814
CC3629	30	4	52	4,000	1,814

4" Strap Assemblies

All heavy duty 4" cargo strap assemblies are made from premium, yellow, 16,200 Lb. tensile strength tested, polyester webbing for maximum durability. Meets all requirements of the U.S. Department of Transportation (DOT), Canadian Council of Motor Transport Administrators (CCMTA) and Commercial Vehicle Safety Alliance (CVSA). 4" inline strap assemblies come standard with a 18" fixed end.



Flat Hook Strap Assembly

Stock #	Length (Feet)	Qty. Per Package	Lbs. Per Package	Working Load Limit	
				Lbs.	Kgs.
CC4027	27	8	37	5,400	2,450
CC4030	30	8	36	5,400	2,450
CC4060	60	4	35	5,400	2,450

Sewn Loop Strap Assembly

Stock #	Length (Feet)	Qty. Per Package	Lbs. Per Package	Working Load Limit	
				Lbs.	Kgs.
CC4127	27	8	30	5,400	2,450
CC4130	30	8	33	5,400	2,450



DO NOT EXCEED CAPACITY!
See the SAFETY GUIDELINES section before using these products. Pages 138-149.

4" Strap Assemblies Cont.

V-Iron Strap Assembly

Stock #	Length (Feet)	Qty. Per Package	Lbs. Per Package	Working Load Limit	
				Lbs.	Kgs.
CC4527	27	8	36	5,400	2,450
CC4530	30	8	40	5,400	2,450
CC4560	60	4	35	5,400	2,450



Chain & Hook Strap Assembly

Stock #	Length (Feet)	Qty. Per Package	Lbs. Per Package	Working Load Limit	
				Lbs.	Kgs.
CC4227	27	8	54	5,400	2,450
CC4230	30	8	56	5,400	2,450

Standard Handle Ratchet Strap Assembly

- With Flat Hooks

Stock #	Length (Feet)	Qty. Per Package	Lbs. Per Package	Working Load Limit	
				Lbs.	Kgs.
CC4730	30	4	55	5,400	2,450



4" Fixed End Strap - With Flat Hooks

Stock #	Length (Inches)	Qty. Per Package	Lbs. Per Package	Working Load Limit	
				Lbs.	Kgs.
CC4783	18	4	6	5,400	2,450

Roll-Off Container Hook Strap Assembly

Government regulations require that all roll-on/roll-off containers use a securement device. Our bolt-on hook assembly allows for easy strap replacement.

Stock #	Length (Feet)	Qty. Per Package	Lbs. Per Package	Working Load Limit	
				Lbs.	Kgs.
CC4603	5	8	25	5,400	2,450
CC4605	5	8	44	5,400	2,450

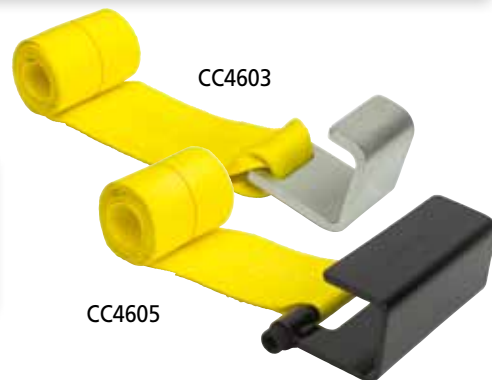

Container Tie-Down Replacement Strap

Stock #	Length (Feet)	Qty. Per Package	Lbs. Per Package	Working Load Limit	
				Lbs.	Kgs.
CC4686	5	8	44	5,400	2,450



WARNING

DO NOT EXCEED CAPACITY!
See the SAFETY GUIDELINES section before using these products. Pages 138-149.

2" Interior Van Straps

Our interior van straps are designed for use inside van trailers equipped with wood or metal rails and E-Series/F-Series track. When used properly they will secure most loads from shifting or falling. All van straps come standard with a 4' fixed end and a captivated adjustable end.



CAM Buckle - With Spring E-Clip

Stock #	Color	Length (Feet)	Qty. Per Pkg.	Lbs. Per Pkg.	Working Load Limit	
					Lbs.	Kgs.
CC3712	Yellow	12	12	21	835	379
CC3716	Gray	16	12	25	835	379
CC3720	Blue	20	8	17	835	379

Ratchet - With Spring E-Clip

Stock #	Color	Length (Feet)	Qty. Per Pkg.	Lbs. Per Pkg.	Working Load Limit	
					Lbs.	Kgs.
CC3812	Yellow	12	8	19	1,000	454
CC3816	Gray	16	8	21	1,000	454
CC3820	Blue	20	8	22	1,000	454



Rope Tie w/E-Clip

Stock #: CC3703
 Length: 6"
 Color: Multi
 Weight: 0.50 Lbs./each
 Factory Package: 8/ctn
 WLL: 1,000Lbs./454 Kgs.
 Order Unit: Each



Boat Trailer Winches

Hand operated winches for boat trailers with either galvanized aircraft cable or webbing and a latch hook. The winches and hooks are zinc plated to protect from rusting. They have a 4.1:1 gear ratio for easier cranking.



Stock #	Description	Length (Feet)	Winch		Qty. Per Pkg.	Lbs. Per Pkg.	Working Load Limit	
			Type	Gear Ratio			Lbs.	Kgs.
CC5707	Hand Winch with 3/16" GAC & Hook	30	2 Way / 1 Speed	4.1:1	6	54	1,200	544
CC5725	Hand Winch with 2" Web Strap & Hook	30	2 Way / 1 Speed	4.1:1	6	48	1,200	544



WARNING DO NOT EXCEED CAPACITY!
 See the SAFETY GUIDELINES section before using these products. Pages 138-149.

Bulk Strap Hardware

RTJ Cluster Hook (3 Link for Chain)

Stock #: **CC92130**
 Finish: Bright Zinc
 WLL: 4,000 Lbs./1,815 Kgs.
 Weight Each: 2.65 Lbs

Factory Package: 10
 Order Unit: Each
 Design Factor: 3:1



RTJ Cluster Hook (1 Link for Web)

Stock #: **CC92132**
 Finish: Bright Zinc
 WLL: 4,000 Lbs./1,815 Kgs.
 Weight Each: 2.28 Lbs.

Factory Package: 10
 Order Unit: Each
 Design Factor: 3:1

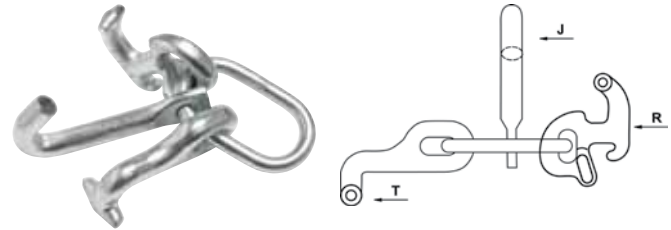

Winches

All winches, when installed properly, provide for a safe and secure method of cargo tie-down on flat bed style trailers. They are made from medium carbon steel and meet all requirements of the DOT, CVSA and the CCMTA. For use with 2", 3" & 4" webbing and cable.

Standard Bottom Mount Weld-On Web Winch

Stock #: **CC5850**
 Finish: Black Powder
 WLL: 6,000 Lbs./2,722 Kgs.
 Weight Each: 9.50 Lbs.

Factory Package: 6
 Order Unit: Each
 Design Factor: 3:1

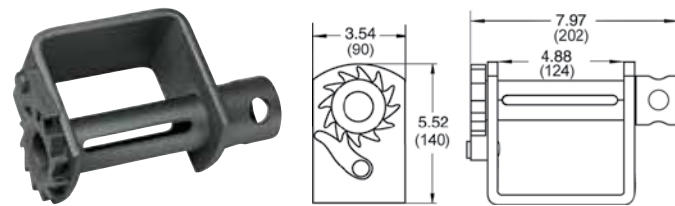

Combination Bottom Mount Weld-On Web & Cable Winch

Stock #: **CC5854**
 Finish: Black Powder
 WLL: 5,500 Lbs./2,495 Kgs.
 Weight Each: 12.30 Lbs.

Factory Package: 6
 Order Unit: Each
 Design Factor: 3:1

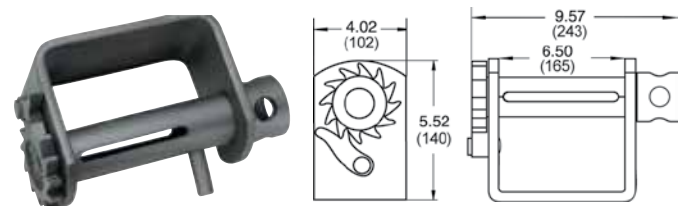

Standard Low-Profile Side Mount Weld-On Web Winch

Stock #: **CC5860**
 Finish: Black Powder
 WLL: 6,000 Lbs./2,722 Kgs.
 Weight Each: 9.00 Lbs.

Factory Package: 6
 Order Unit: Each
 Design Factor: 3:1

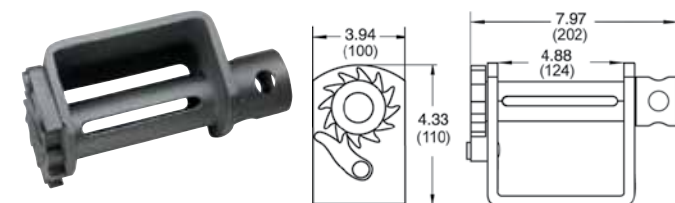

Combination Low Profile Mount Weld-On Web & Cable Winch

Stock #: **CC5864**
 Finish: Black Powder
 WLL: 5,500 Lbs./2,495 Kgs.
 Weight Each: 10.85 Lbs.

Factory Package: 6
 Order Unit: Each
 Design Factor: 3:1

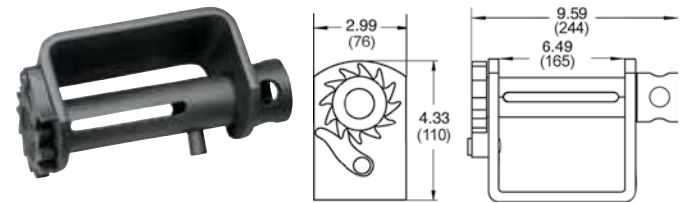

DO NOT EXCEED CAPACITY!
 See the SAFETY GUIDELINES section before using these products. Pages 138-149.

BULK STRAP HARDWARE, WINCHES & WINCH BARS

Standard Slider Winch

Stock #: **CC5900**
 Finish: Black Powder
 WLL: 5,500 Lbs./2,495 Kgs.
 Weight Each: 11.35 Lbs.

Factory Package: 6
 Order Unit: Each
 Design Factor: 3:1

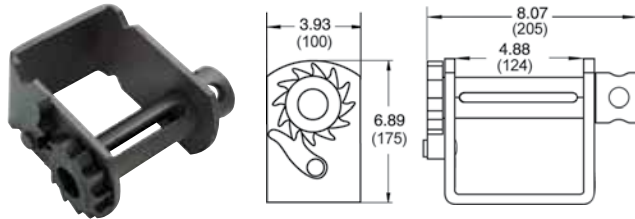

Storable Slider Winch

Stock #: **CC5906**
 Finish: Black Powder
 WLL: 5,500 Lbs./2,495 Kgs.
 Weight Each: 11.50 Lbs.

Factory Package: 6
 Order Unit: Each
 Design Factor: 3:1

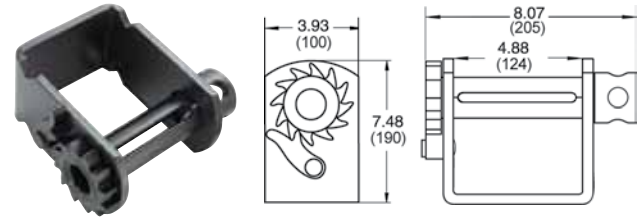

Standard Bottom Mount Portable Web Winch (w/ 2 bolts)

Stock #: **CC5955**
 Finish: Black Powder
 WLL: 6,000 Lbs./2,722 Kgs.
 Weight Each: 10.85 Lbs.

Factory Package: 6
 Order Unit: Each
 Design Factor: 3:1

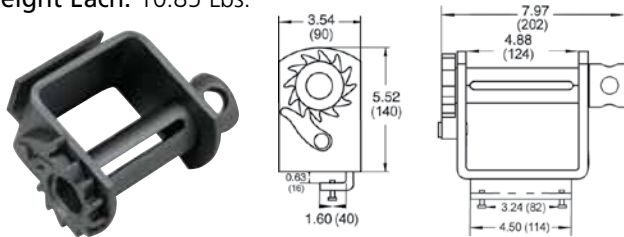

Low-Profile Side Mount Portable Web Winch (w/ 2 bolts)

Stock #: **CC5965**
 Finish: Black Powder
 WLL: 6,000 Lbs./2,722 Kgs.
 Weight Each: 11.50 Lbs.

Factory Package: 6
 Order Unit: Each
 Design Factor: 3:1



Lashing winches, for use with 2" webbing, can be welded or bolted onto a trailer. Winch design offers similar features of a ratchet buckle with its quick release. Hex drive style requires a 1 1/8" hex head wrench or socket.

Lashing Winch (w/ Hex Drive)

Stock #: **CC5820**
 Finish: Black Powder
 WLL: 3,335 Lbs./1,515 Kgs.
 Weight Each: 3.55 Lbs.

Factory Package: 10
 Order Unit: Each
 Design Factor: 3:1

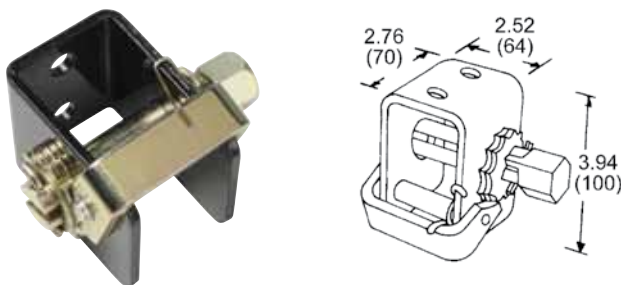

Lashing Winch (w/ Standard Bar Drive)

Stock #: **CC5822**
 Finish: Black Powder
 WLL: 3,335 Lbs./1,515 Kgs.
 Weight Each: 3.10 Lbs.

Factory Package: 10
 Order Unit: Each
 Design Factor: 3:1

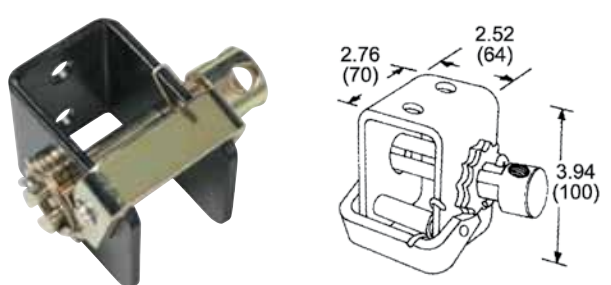

For Proper Winch Use:

- Use extreme caution when tensioning the winch/assembly to assure the latch/pawl is fully engaged in the gear sprocket teeth before releasing the pressure on the winch bar. Always keep hands and fingers away from the winch pawl & keep face, head and body out of path of winch bar.
- Inspect all binding components (winch, strap assembly, chain assembly, loadbinder) prior to each use. Never use damaged or worn equipment. Remove from service and replace with new. Do not attempt to repair. Winch bars are used entirely at the users own risk and the use of a winch bar demonstrates an understanding of the risks and a willingness to accept the consequences of possible property damage, serious personal injury and/or loss of life.
- When using Peerless winch bars with winches the tapered point of the bar must be inserted completely through both holes in the winch cap. Failure to insert bar correctly could cause the bar to slip and result in serious personal injury and/or loss of life. During tightening and before releasing the tie down assembly, check the winch pawl to insure it has properly engaged the gear sprocket. Always grip the winch bar at the knurled section of the bar for increased safety. Reference the SAFETY GUIDELINES section of this catalog for more information.



DO NOT EXCEED CAPACITY!
 See the SAFETY GUIDELINES section before using these products. Pages 138-149.

Winch Bars, Hard Parts & CargoGuard™

Winch Bars

Winch bars feature a knurled handle for a safe grip as well as tapered case hardened ribbed nose piece for strength and to prevent slippage.

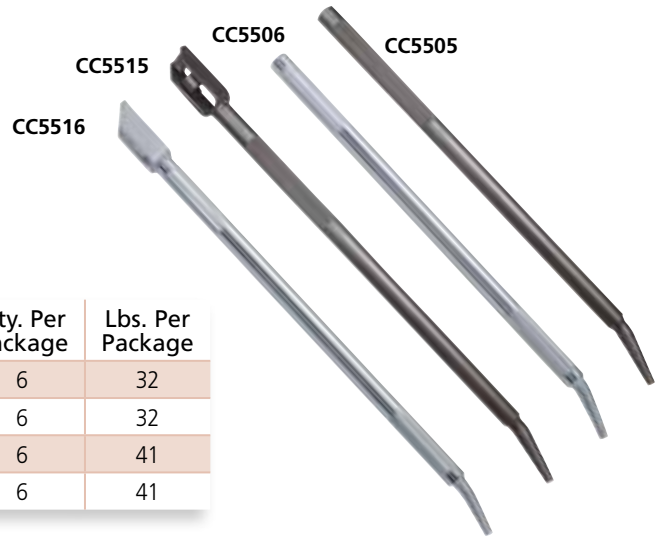

Stock #	Finish	Type	Length (Inches)	Qty. Per Package	Lbs. Per Package
CC5505	Painted	Standard	32.5	6	32
CC5506	Chrome	Standard	32.5	6	32
CC5515	Painted	Combination	37	6	41
CC5516	Chrome	Combination	37	6	41



CargoBar Rack (For Square Bars Only)

Stock #: **CC5620**
Weight: 6.25 Lbs./Ea.
Factory Package: 8/Ctn.
Order Unit: Each



Weld-On C-Hook

Stock #: **CC5626**
Weight: 0.83 Lbs./Ea.
Factory Package: 12/Ctn.
Order Unit: Each



4" Metal Corner

Stock #: **CC5630**
Weight: 1.46 Lbs./Ea.
Factory Package: 24/Ctn.
Order Unit: Each



4" Rubber Corner

Stock #: **CC5634**
Weight: 0.88 Lbs./Ea.
Factory Package: 50/Ctn.
Order Unit: Each



16" Galvanized Corner

Stock #: **CC5635**
Weight: 1.83 Lbs./Ea.
Factory Package: 24/Ctn.
Order Unit: Each



HD Beam Socket

Stock #: **CC5642**
Weight: 0.92 Lbs./Ea.
Factory Package: 12/Ctn.
Order Unit: Each



G-70 Floor Chain Anchor (3/8 Chain)

Stock #: **CC5656**
Weight: 3.45 Lbs./Ea.
Factory Package: 10/Ctn.
Order Unit: Each



4" Plastic Corner

Stock #: **CC5680**
Weight: 0.30 Lbs./Ea.
Factory Package: 24/Ctn.
Order Unit: Each



Strap Winder

Stock #: **CC5695**
Weight: 3.17 Lbs./Ea.
Factory Package: 6/Ctn.
Order Unit: Each

CargoGuard™ Flexible Corner Protectors

CargoGuards feature patented, multiple living hinges that adapt to the form of any cargo, regardless of the shape. It is designed to protect both the strap and the cargo and can be installed even after the strap has been placed on the load. Made from high impact thermo-plastic, 2 or more snap together for any required length. They can be neatly stacked and are available for both 2" and 4" straps.



CargoGuard (For 2" Straps)

Stock #: **CC5681**
Weight: 0.07 Lbs./Ea.
Factory Package: 24/Ctn.
Order Unit: Each

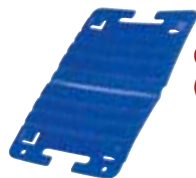

CargoGuard (For 2" & 4" Straps)

Stock #: **CC5682**
Weight: 0.10 Lbs./Ea.
Factory Package: 24/Ctn.
Order Unit: Each



CargoGuard 2 pk (For 2" & 4" Straps)

Stock #: **CC5684**
Weight: 0.21 Lbs./Pkg.
Factory Package: 24/Ctn.
Order Unit: Each



WARNING

DO NOT EXCEED CAPACITY!
See the SAFETY GUIDELINES section before using these products. Pages 138-149.

Rubber Tie-Down Accessories

EPDM Rubber Rope

Stock #	Size (Inches)	Type	Length (Feet)	Qty. Per Package	Lbs. Per Package
CC8170	3/8	Hollow Core	150	1	9
CC8173	3/8	Solid Core	150	1	11
CC8175	7/16	Hollow Core	150	1	12
CC8178	7/16	Solid Core	150	1	14



EPDM Rubber Tarp Strap - With Hooks

Stock #	Strap Length (Inches)	Overall Length (Inches)	Max Stretch (Inches)	Qty. Per Package	Lbs. Per Package
Bulk					
CC8409	9	14	18-20	50	10
CC8415	15	20	24-28	50	11
CC8421	21	26	30-35	50	14
CC8431	31	36	40-48	50	18
CC8441	41	46	50-60	50	22

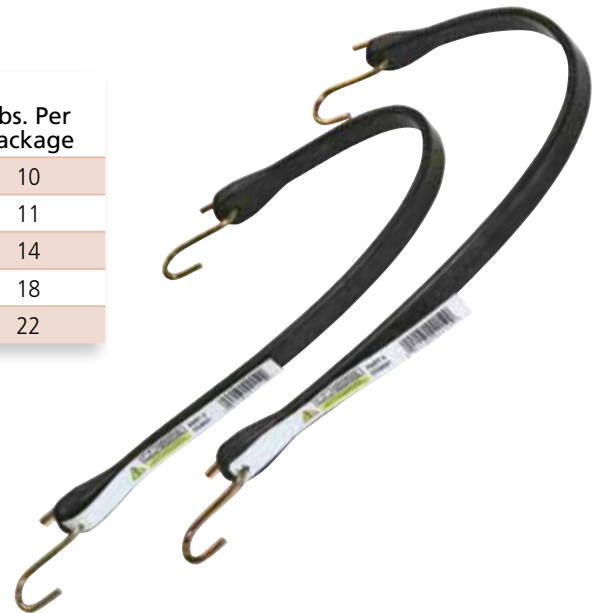

Rubber Rope S-J Hook

Stock #: **CC8199**
 Finish: Bright Zinc
 Wire diameter: 0.160"
 Inside length: 3.0"
 Weight: 0.05 Lbs./Ea.
 Factory Package: 100/Ctn.
 Order Unit: Each



Tarp Strap S-Hook

Stock #: **3501760**
 Finish: Galv Wire
 Wire Diameter: 0.177"
 Inside Length: 2.50"
 Weight: 0.04 Lbs./Ea.
 Factory Package: 100/Bag
 Order Unit: Each

Stock #: **7953935**
 Factory Package: 1000/Ctn.



DO NOT EXCEED CAPACITY!
 See the SAFETY GUIDELINES section before using these products. Pages 138-149.

Auto Tie-Downs & Axle Straps

2" premium polyester, shrink wrapped for retail shelf display. Axle straps feature protective sleeves.

Auto Tie-Down (W/Ratchet, HD Snap Hook & RTJ Hook)

Stock #: CC2574
 Length: 8'
 Weight: 6.00 Lbs./Ea.
 Factory Package: 8/Ctn.
 WLL: 3,300 Lbs./1,497 Kgs.
 Order Unit: Each



Auto Tie-Down (W/Ratchet, Snap Hook & Fixed D-Ring)

Stock #: CC2575
 Length: 8'
 Weight: 4.50 Lbs.
 Factory Package: 8/Ctn.
 WLL: 3,300 Lbs./1,497 Kgs.
 Order Unit: Each



Auto Tie-Down (W/Ratchet, HD Snap Hooks & Floating D-Ring)

Stock #: CC2576
 Length: 8'
 Weight: 5.00 Lbs.
 Factory Package: 8/Ctn.
 WLL: 3,300 Lbs./1,497 Kgs.
 Order Unit: Each



Axle Strap (W/2 D-Rings)

Stock #: CC2578
 Length: 3'
 Weight: 1.00 Lbs./Ea.
 Factory Package: 8/Ctn.
 WLL: 3,300 Lbs./1,497 Kgs.
 Order Unit: Each



Axle Strap (W/ HD Snap Hooks & Floating D-Ring)

Stock #: CC2579
 Length: 4'
 Weight: 1.20 Lbs./Ea.
 Factory Package: 8/Ctn.
 WLL: 3,300 Lbs./1,497 Kgs.
 Order Unit: Each



Auto Tie-Down (W/Carrying Bag)

Stock #: CC2570
 Includes: 2 ea. CC2576 & CC2579
 Weight: 15.50 Lbs./Ea.
 Factory Package: 4 Kits/Ctn.
 WLL: 3,300 Lbs./1,497 Kgs.
 Order Unit: Each



DO NOT EXCEED CAPACITY!
 See the SAFETY GUIDELINES section before using these products. Pages 138-149.



Tow Straps

NOT FOR OVERHEAD LIFTING

Stock #	End Type	Width (Inches)	Length (Feet)	Qty. Per Pkg.	Lbs. Per Pkg.	Working Load Limit	
						Lbs.	Kgs.
CC2002	Loop	2	20	6	15	5,000	2,268
CC2003	Loop	2	30	6	23	5,000	2,268
CC2004	Loop	3	25	4	19	7,800	3,538
CC2005	Loop	4	30	2	15	10,000	4,536

Cable Pullers

2 Ton Cable Puller

Stock #: HT4502
 Cable Size: 3/16"
 Travel: 6'
 Weight: 6.70 Lbs./Ea.
 Factory Package: 6/Ctn.
 Order Unit: Each

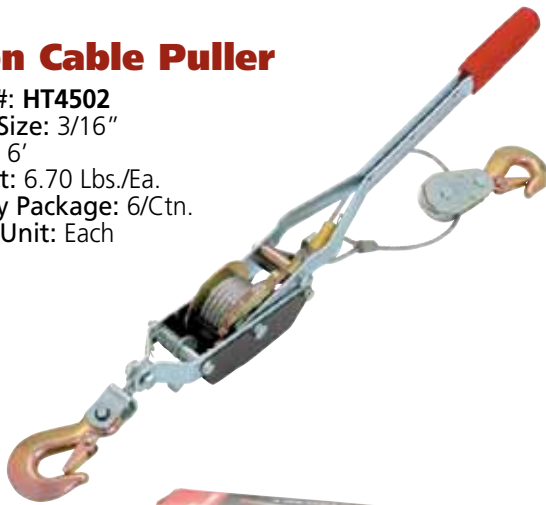

4 Ton Cable Puller

Stock #: HT4504
 Cable Size: 1/4"
 Travel: 6'
 Weight: 12.75 Lbs./Ea.
 Factory Package: 4/Ctn.
 Order Unit: Each

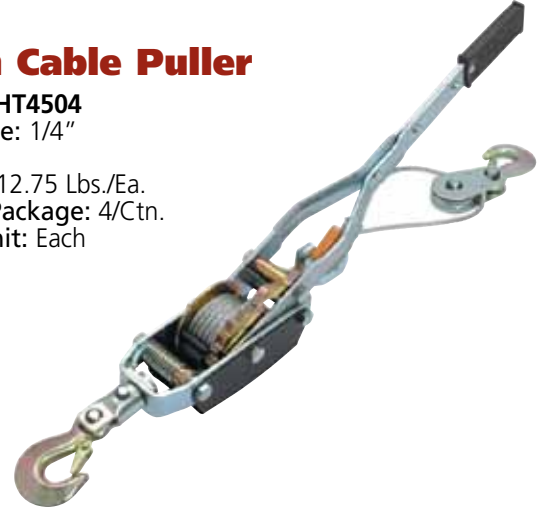

DO NOT EXCEED CAPACITY!
 See the SAFETY GUIDELINES section before using these products. Pages 138-149.

Trailer Chain

S-Hooks - Heat Treated



Stock #	Zinc	Hook No.	Trailer Class	Hooks		Qty. Per Pkg.	Lbs. Per Ea.	GVWR	
				Wire Dia.	Inside Length			Lbs.	Kgs.
7983535		835	1	0.375	2.870	50	0.23	2,000	910
7983935		839	2 & 3	0.454	3.880	50	0.40	5,000	2,270
7983735		837	4	0.531	3.880	50	0.60	7,600	3,447

Hooks W/Latches - Heat Treated



Stock #	Zinc	Hook No.	Trailer Class	Hooks		Qty. Per Pkg.	Lbs. Per Ea.	GVWR	
				Wire Dia.	Inside Length			Lbs.	Kgs.
7993535		935	1	0.375	3.500	50	0.26	2,000	910
7993935		939	2 & 3	0.454	3.500	50	0.40	5,000	2,270
7993735		937	4	0.531	3.500	50	0.60	7,600	3,447

Trailer Chain Class 1

Class 1 - All types of trailers with a trailer Gross Vehicle Weight Rating (GVWR) (trailer weight including its load) not to exceed 2,000 lbs (910 kg). Two chains must be used per trailer.

Stock #	Zinc	Trade Size (Inches)	Length (inches)	Hooks	Qty. Per Drum	Lbs. Per Drum	GVWR	
							Lbs.	Kgs.
6800031		3/16 G30	48	2 (w/Latch)	100	192	2,000	910

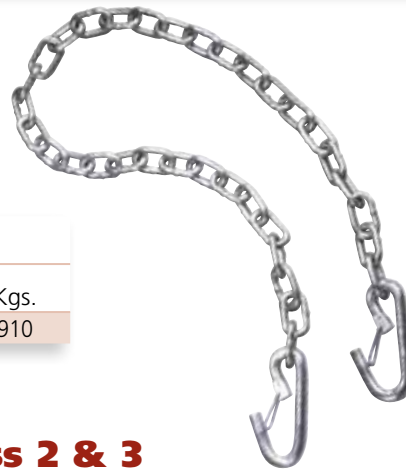

Trailer Chain Class 2 & 3

Class 2 - All types of trailers with a GVWR of over 2,000 lbs (910 kg) and not to exceed 3,500 lbs (1,590 kg) GVWR. Two chains must be used per trailer.

Class 3 - All types of trailers with a GVWR of over 3,500 lbs (1,590 kg) and not to exceed 5,000 lbs (2,270 kg) GVWR. Two chains must be used per trailer. The chains in the chart below meet both class 2 & 3 specifications.



Stock #	Zinc	Trade Size (Inches)	Length (inches)	Hooks	Qty. Per Drum	Lbs. Per Drum	GVWR	
							Lbs.	Kgs.
8640210		1/4 G30	24	1 (S-Hook)	150	209	5,000	2,270
8671115		1/4 G30	30	1 (S-Hook)	100	190	5,000	2,270
8666230		1/4 G30	48	2 (S-Hook)	100	306	5,000	2,270
8650240		1/4 G30	60	2 (S-Hook)	50	186	5,000	2,270
8666250		1/4 G30	72	2 (S-Hook)	50	196	5,000	2,270
6840215		1/4 G30	30	1 (w/Latch)	100	180	5,000	2,270
8610115		1/4 G30	36	1 (w/Latch)	125	248	5,000	2,270
6800032		1/4 G30	48	2 (w/Latch)	100	300	5,000	2,270
6800033		1/4 G30	60	2 (w/Latch)	100	355	5,000	2,270
8610956		1/4 G30	72	2 (w/Latch)	50	195	5,000	2,270



WARNING

DO NOT EXCEED CAPACITY!
See the SAFETY GUIDELINES section before using these products. Pages 138-149.

AG & UTILITY, TRAILER SAFETY & WINCH LINE TAIL CHAIN



Trailer Chain Class 4 & Above

Class 4 - All types of trailers with a GVWR of over 5,000 lbs (2,270 kg) and not to exceed 10,000 lbs (4,540 kg) GVWR. Two chains must be used per trailer.

Stock #	Trade Size (Inches)	Length (inches)	Hooks	Qty. Per Drum	Lbs. Per Drum	GVWR	
						Lbs.	Kgs.
8607006	8/0 (0.342)	30	1 (S-Hook)	100	300	7,600	3,447
8604229	8/0 (0.342)	36	1 (S-Hook)	100	375	7,600	3,447
6807902	8/0 (0.342)	30	1 (w/Latch)	100	300	7,600	3,447
8607260	8/0 (0.342)	36	1 (w/Latch)	100	360	7,600	3,447
8607903	5/16 G30	36	1 Clevis Slip Hook & Latch	100	310	7,600	3,447
6800028*	1/4 G70	36	1 Clevis Slip Hook & Latch	250	590	12,600	5,714
8605734*	3/8 G43	36	1 Clevis Slip Hook & Latch	50	250	16,200	7,348
6800026*	3/8 G70	36	1 Clevis Slip Hook & Latch	100	515	26,400	11,975

*Not defined per SAE J684

Ag Trailer Chain

Peerless Ag chains meet the requirements of ANSI/ASAE Standard S338.5. All chains come with latch-type grab hooks, which ensure that the chain will not separate from the towing vehicle. A permanent ID tag states the gross vehicle pounds for which the chain is intended.

Stock #		Trade Size (Inches)	Length (inches)	Qty. Per Pkg.	Lbs. Per Pkg.	System Strength	
Zinc	Welded Link					Lbs.	Kgs.
8607193	---	1/4	59	50	220	6,400	2,900
8607187	8612424	5/16	59	50	305	10,000	4,535
8607224	---	5/16	60	50	355	16,000	7,250
8607189	8612486	3/8	59	25	225	20,000	9,070
8607191	8612535	7/16	64	20	280	30,000	13,600
8607225	---	1/2	70	20	340	40,000	18,140
8607195	---	5/8	107	1	37	60,000	27,215



Welded Link

Clevis Link

Winch Line Tail Chain

Flexible attachment for use with wire rope. Length specified is exclusive of hook. Use same size chains as wire rope. The hook is dropped forged alloy steel and heat treated for extra durability. The hook is designed to prevent wear on wire rope. Custom orders available upon requests. **NOT FOR OVERHEAD LIFTING**

Low Carbon

Stock #	Trade Size		Lgth.	No. of Links	Wire Rope Dia.	Lbs. Per Ea.	WLL.	
	In.	MM					Lbs.	Kgs.
574280818	1/2	13	18	11	5/16 - 3/8	8.6	9,200	4,172
574281018	5/8	16	18	8	1/2 - 5/8	9.8	13,000	5,896
574281218	3/4	19	18	6	3/4 - 7/8	15.0	20,200	9,161

Design Factor 3.5:1

Alloy

Stock #	Trade Size		Lgth.	No. of Links	Wire Rope Dia.	Lbs. Per Ea.	WLL.	
	In.	MM					Lbs.	Kgs.
574480818	1/2	13	18	8	5/16 - 3/8	6.8	12,000	5,442
574481018	5/8	16	18	7	1/2 - 5/8	8.9	18,100	8,209
574411218	3/4	19	18	6	3/4 - 7/8	15.5	28,300	12,834
574481424	7/8	22	24	8	1 - 1-1/8	22.2	34,200	15,510
574481624	1	26	24	6	1 - 1-1/8	24.0	47,700	21,633

Design Factor 3.5:1



DO NOT EXCEED CAPACITY!
See the SAFETY GUIDELINES section before using these products. Pages 138-149.

SmartBar™

The Most Versatile Loadlock On The Market!

Our SmartBar™, with high leverage and flexible feet, means superior holding power. Square vs. round tubing provides a stronger bar (less susceptible to bending and more surface area to cargo). The SmartBar™ can brace a whole load or just part of one.

- Easier to use and store. 140 SmartBars™ can ship on a standard pallet!
- Up to 20% more holding power than conventional loadlocks.
- Adjusts continuously from 48" - 108". Securement range from small truck bed to full high cube trailer width.

The vinyl coated lever provides smooth, positive operation. Closed bar locking tab is easily locked / unlocked with the convenient thumb release.

The SmartBar™ is designed for use in trailers with flexible walls. The feet have extra cushioning to compensate for the flex of some trailers.

With optional E-Track attachment (#CC5015), the SmartBar™ can easily be adapted for use in A & E track, doubling the front to back holding power.



Stock #	Reach (Inches)	Description	Qty. Per Package	Package	Weight (Lbs./Ea.)
CC5010	48 - 108	3 Section Steel SmartBar™	4	Bundle	13.50



SmartBar™ Parts

E-Track Kit

Stock #: **CC5015**
 Weight: 0.12 Lbs./Ea.
 Factory Package: 12 Kits/Ctn.
 Order Unit: Each



SmartBar™ Repair Kit

Stock #: **CC5016**
 Weight: 0.16 Lbs./Ea.
 Factory Package: 12 Kits/Ctn.
 Order Unit: Each



Replacement Foot (small)

Stock #: **CC5018**
 Weight: 0.40 Lbs./Ea.
 Factory Package: 12/Ctn.
 Order Unit: Each



Replacement Foot (large)

Stock #: **CC5019**
 Weight: 0.45 Lbs./Ea.
 Factory Package: 12/Ctn.
 Order Unit: Each



DO NOT EXCEED CAPACITY!
 See the SAFETY GUIDELINES section before using these products. Pages 138-149.

SecureBar™ & GrabBar™

SecureBar™

Versatile Loadlock For Light Truck & Passenger Vehicles

Durable square tubing provides added strength. It is versatile and can be used in pickups, SUVs, vans and passenger cars. The soft rubber feet provide excellent grip and won't mar surfaces. Retail package is a 46" four color card with pictures and instructions for use. Hangs vertical or horizontal on standard peg hooks.

- Adjusts continuously from 44" to 78".
- Easy operation - Positive locking lever action and quick thumb release.
- Zinc plated for maximum rust protection.

Stock #	Reach (Inches)	Description	Qty. Per Package	Package	Weight (Lbs./Ea.)
Zinc Plated					
CC5225	44 - 78	SecureBar™ CargoBar - Retail Pkg.	4	Carton	5.00



GrabBar™

Designed for cargo stabilization inside trailers with wood or metal rails. Feet adjust to board/rail thickness ranging from 1/3" - 1-3/4". Collapses down to 46" for easy storage, with a full adjustment range to 106". The rubber feet provide excellent grip and will not damage surfaces. Use the GrabBar™ stop collar for rigidity in stake side truck applications. The GrabBar™ can also be used in conjunction with the SmartBar™ (see photo at left).



Stock #	Reach (Inches)	Description	Qty. Per Package	Package	Weight (Lbs./Ea.)
Zinc Plated					
CC5200	46 - 106	GrabBar™	2	Bundle	17.50



SecureBar™ & GrabBar™ Parts

Replacement Foot (Small for CC5225)



Stock #: **CC5238**
 Weight: 0.42 Lbs./Ea.
 Factory Package: 12/Ctn.
 Order Unit: Each

Replacement Foot (Large for CC5225)



Stock #: **CC5239**
 Weight: 0.42 Lbs./Ea.
 Factory Package: 12/Ctn.
 Order Unit: Each

GrabBar™ Stop Collar (For CC5200)



Stock #: **CC5212**
 Weight: 1.00 Lbs./Ea.
 Factory Package: 6/Ctn.
 Order Unit: Each



DO NOT EXCEED CAPACITY!
 See the SAFETY GUIDELINES section before using these products. Pages 138-149.

Loadlocks

Steel Loadlock

Stock #: **CC5050**
 Reach: 88" - 102"
 Weight: 12.80 Lbs./Ea.
 Factory Package: 4/Bundle
 Order Unit: Each

Aluminum Loadlock

Stock #: **CC5150**
 Reach: 88" - 102"
 Weight: 9.50 Lbs./Ea.
 Factory Package: 4/Bundle
 Order Unit: Each



Loadlock Parts

Foot (Large End)

Stock #: **CC5171**
 Weight: 0.92 Lbs./Ea.
 Factory Package: 6/Ctn.
 Order Unit: Each



Foot (Small End)

Stock #: **CC5172**
 Weight: 0.92 Lbs./Ea.
 Factory Package: 6/Ctn.
 Order Unit: Each



Aluminum Handle Assembly (w/Lock)

Stock #: **CC5173**
 Weight: 1.50 Lbs./Ea.
 Factory Package: 6/Ctn.
 Order Unit: Each



Replacement Handle

Stock #: **CC5174**
 Weight: 0.66 Lbs./Ea.
 Factory Package: 6/Ctn.
 Order Unit: Each



Tooth Extension Rack

Stock #: **CC5175**
 Weight: 1.20 Lbs./Ea.
 Factory Package: 6/Ctn.
 Order Unit: Each



Coil Racks

Coil racks are used to assist in stabilization of metal coils during transport.

Coil Rack (Heavy Duty)

Stock #: **CC5649**
 Gauge: 6
 Color: Black
 Weight: 15.25 Lbs./Ea.
 Factory Package: 4/Ctn.
 Order Unit: Each

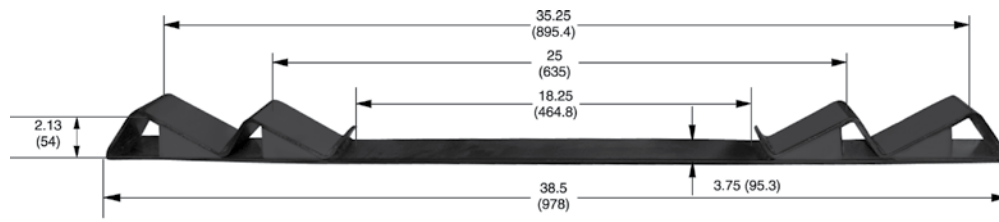

Coil Rack (Light Duty)

Stock #: **CC5647**
 Gauge: 10
 Color: Black
 Weight: 5.00 Lbs./Ea.
 Factory Package: 10/Ctn.
 Order Unit: Each

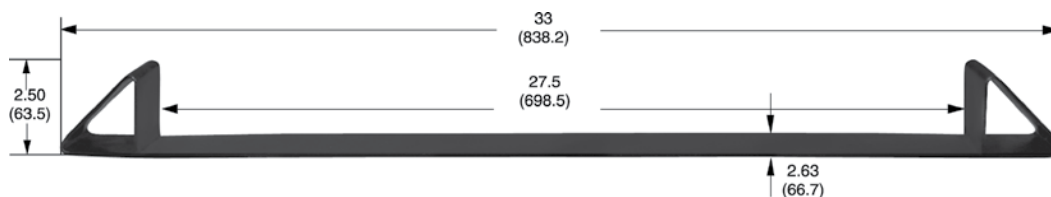

DO NOT EXCEED CAPACITY!
 See the SAFETY GUIDELINES section before using these products. Pages 138-149.



HARDWARE CHAIN

Grade 43 Chain	82-84
Grade 30 Chain	85-88
Straight & Twist Link Coil Chain	89-91
Straight & Twist Link Machine Chain	91-92
Passing Link Chain	92
Twin Loop Chain	93
Brass Plumbers Chain	93
Sash Chain	94
Jack Chain	94
Lock Link Chain	95
Decorative Chain	95
Pet Tie-Outs	95
Plastic Chain & Accessories	96

Grade 43 High Test Chain (NACM)

Grade 43 Chain features both high tensile strength and resistance to wear needed by modern hauling and heavy duty trucking, farm and construction firms. Working load limits exceed those of ordinary low carbon or general utility chain. Order unit is foot.

NOT FOR OVERHEAD LIFTING

Full Drum

Stock #			Trade Size		Wire Dia. (In.)	Inside Link Dim. (Inches)		Ft. Per Drum	Net Wt. (Lbs.)	Working Load Limit	
Self-Colored	Zinc	HDG	In.	MM		Length (Nominal)	Width (Min.)			Lbs.	Kgs.
5031213	5031233	5630247	1/4	7	0.274	1.236	0.480	800	508	2,600	1,180
5031313	5031333	5630347	5/16	8	0.328	1.285	0.480	550	512	3,900	1,770
5031413	5031433	5630447	3/8	10	0.392	1.374	0.551	400	544	5,400	2,450
5031613	5031633	5630647	1/2	13	0.509	1.782	0.750	200	460	9,200	4,174
5030813	---	5630847	5/8	16	0.625	2.016	0.851	150	554	13,000	5,897
5030913	---	5030947	3/4	20	0.781	2.610	1.020	100	542	20,200	9,163
5031013	---	5031047	7/8	22	0.904	2.570	1.260	75	582	24,500	11,113
5301113	---	5301147	1	26	1.032	2.870	1.420	60	606	30,000	13,608



Half Drum

Stock #			Trade Size		Wire Dia. (In.)	Inside Link Dim. (Inches)		Ft. Per Drum	Net Wt. (Lbs.)	Working Load Limit	
Self-Colored	Zinc	HDG	In.	MM		Length (Nominal)	Width (Min.)			Lbs.	Kgs.
5031214	5031234	5630248	1/4	7	0.274	1.236	0.480	400	254	2,600	1,180
5031314	5031334	5630348	5/16	8	0.328	1.285	0.480	275	256	3,900	1,770
5031414	5031434	5630448	3/8	10	0.392	1.374	0.551	200	272	5,400	2,450
5031614	5031634	5630648	1/2	13	0.509	1.782	0.750	100	230	9,200	4,174

5 Gallon Square Pail

Stock #	Trade Size		Wire Dia. (In.)	Inside Link Dim. (Inches)		Ft. Per Pail	Net Wt. (Lbs.)	Working Load Limit	
Self-Colored	In.	MM		Length (Nominal)	Width (Min.)			Lbs.	Kgs.
5431215	1/4	7	0.274	1.236	0.480	150	96	2,600	1,180
5431315	5/16	8	0.328	1.285	0.480	100	93	3,900	1,770
5431415	3/8	10	0.392	1.374	0.551	75	102	5,400	2,450



WARNING

DO NOT EXCEED CAPACITY!
See the SAFETY GUIDELINES section before using these products. Pages 138-149.



Grade 43 Import High Test Chain (NACM)

A general utility chain for farm, industrial and home applications such as: log chain, cargo lashing, pipeline hanging, tailgate, guard rail, tow and switch chain. Order unit is foot. **NOT FOR OVERHEAD LIFTING**

Full Drum

Stock #		Trade Size		Wire Dia. (In.)	Inside Link Dim. (Inches)		Ft. Per Drum	Net Wt. (Lbs.)	Working Load Limit	
Self-Colored	Zinc	In.	MM		Length (Nominal)	Width (Min.)			Lbs.	Kgs.
6713202	6702203	1/4	7	0.276	1.240	0.480	800	508	2,600	1,180
6735302	6724303	5/16	8	0.343	1.290	0.480	550	503	3,900	1,770
6757402	6746403	3/8	10	0.406	1.380	0.550	400	544	5,400	2,450



5 Gallon Square Pail

Stock #	Trade Size		Wire Dia. (In.)	Inside Link Dim. (Inches)		Ft. Per Pail	Net Wt. (Lbs.)	Working Load Limit	
	Zinc	In.		MM	Length (Nominal)			Width (Min.)	Lbs.
6202207	1/4	7	0.276	1.240	0.380	150	96	2,600	1,180
6224307	5/16	8	0.343	1.290	0.440	100	93	3,900	1,770
6246407	3/8	10	0.406	1.380	0.550	75	102	5,400	2,450



Box

Stock #	Trade Size		Wire Dia. (In.)	Inside Link Dim. (Inches)		Ft. Per Box	Net Wt. (Lbs.)	Working Load Limit	
	Self-Colored	Inches		MM	Length (Nominal)			Width (Min.)	Lbs.
5453415	3/8	10	0.406	1.380	0.550	100	140	5,400	2,450



DO NOT EXCEED CAPACITY!
See the SAFETY GUIDELINES section before using these products. Pages 138-149.



G43 Import High Test Chain (Short Link)

Order unit is foot. **NOT FOR OVERHEAD LIFTING**

Full Drum

Stock #		Trade Size (In.)	Wire Dia. (In.)	Inside Dimensions (Inches)		Qty. Per Drum	Net Wt. (Lbs.)	Working Load Limit	
Self-Colored	HDG			Length (Nominal)	Width (Minimum)			Lbs.	Kgs.
H0216-0400	H0216-0415	1/4	0.281	0.980	0.410	800	600	2,600	1,180
H0216-0500	H0216-0515	5/16	0.343	1.100	0.480	550	633	3,900	1,770
H0216-0600	H0216-0615	3/8	0.406	1.340	0.570	400	640	5,400	2,450
H0216-0800	H0216-0815	1/2	0.531	1.500	0.750	200	540	9,200	4,174

Half Drum

Stock #		Trade Size (In.)	Wire Dia. (In.)	Inside Dimensions (Inches)		Qty. Per Drum	Net Wt. (Lbs.)	Working Load Limit	
Self-Colored				Length (Nominal)	Width (Minimum)			Lbs.	Kgs.
H0214-0400		1/4	0.281	0.980	0.410	400	300	2,600	1,180
H0214-0500		5/16	0.343	1.100	0.480	275	316	3,900	1,770
H0214-0600		3/8	0.406	1.340	0.570	200	320	5,400	2,450
H0214-0800		1/2	0.531	1.500	0.750	100	270	9,200	4,174

5 Gallon Pail

Stock #		Trade Size (In.)	Wire Dia. (In.)	Inside Dimensions (Inches)		Qty. Per Pail	Net Wt. (Lbs.)	Working Load Limit	
Self-Colored	Zinc			Length (Nominal)	Width (Minimum)			Lbs.	Kgs.
H0210-0405	H0210-0411	1/4	0.281	0.980	0.410	150	105	2,600	1,180
H0210-0505	H0210-0511	5/16	0.343	1.100	0.480	100	119	3,900	1,770
H0210-0605	H0210-0611	3/8	0.406	1.340	0.570	75	124	5,400	2,450
H0210-0805	---	1/2	0.531	1.500	0.750	40	114	9,200	4,174



DO NOT EXCEED CAPACITY!
See the SAFETY GUIDELINES section before using these products. Pages 138-149.

Grade 30 Proof Coil Chain (NACM)

NOT FOR OVERHEAD LIFTING.



A general utility chain for farm, industrial and home applications such as: log chain, cargo lashing, pipeline hanging, tailgate, guard rail, tow and switch chain. Order unit is foot.



Full Drum

Stock #			Trade Size		Wire Dia. (In.)	Inside Link Dim. (Inches)		Ft. Per Drum	Net Wt. (Lbs.)	Working Load Limit	
Self-Colored	Zinc	HDG	In.	MM		Length (Nom.)	Width (Min.)			Lbs.	Kgs.
5011113	5011133	5610147	3/16	5.5	0.217	0.950	0.405	800	320	800	363
5011213	5011233	5610247	1/4	7	0.274	1.236	0.480	800	508	1,300	590
5011313	5011333	5610347	5/16	8	0.328	1.285	0.480	550	512	1,900	862
5011413	5011433	5610447	3/8	10	0.392	1.374	0.551	400	544	2,650	1,202
5011613	5011633	5610647	1/2	13	0.509	1.782	0.750	200	460	4,500	2,042
5010813	5010833	5610847	5/8	16	0.625	2.016	0.851	150	554	6,900	3,131
5010913	---	5010947	3/4	20	0.781	2.610	1.020	100	542	10,600	4,808
5011013	---	5011047	7/8	22	0.904	2.570	1.260	75	573	12,800	5,806
5101113	---	5101147	1	26	1.032	2.900	1.435	60	606	17,900	8,119

Half Drum

Stock #			Trade Size		Wire Dia. (In.)	Inside Link Dim. (Inches)		Ft. Per Drum	Net Wt. (Lbs.)	Working Load Limit	
Self-Colored	Zinc	HDG	In.	MM		Length (Nom.)	Width (Min.)			Lbs.	Kgs.
5011114	5011134	5610148	3/16	5.5	0.217	0.950	0.405	400	160	800	363
5011214	5011234	5610248	1/4	7	0.274	1.236	0.480	400	254	1,300	590
5011314	5011334	5610348	5/16	8	0.328	1.285	0.480	275	256	1,900	862
5011414	5011434	5610448	3/8	10	0.392	1.374	0.551	200	272	2,650	1,202
5011614	5011634	5610648	1/2	13	0.509	1.782	0.750	100	230	4,500	2,042

5 Gallon Square Pail

Stock #		Trade Size		Wire Dia. (In.)	Inside Link Dim. (Inches)		Ft. Per Pail	Net Wt. (Lbs.)	Working Load Limit	
Zinc	HDG	In.	MM		Length (Nominal)	Width (Min.)			Lbs.	Kgs.
5411135	5411165	3/16	5.5	0.217	0.950	0.405	250	100	800	363
5411235	5411265	1/4	7	0.274	1.236	0.480	141	90	1,300	590
5411335	5411365	5/16	8	0.328	1.285	0.480	92	86	1,900	862
5411435	5411465	3/8	10	0.392	1.374	0.551	63	86	2,650	1,202
5411635	---	1/2	13	0.509	1.782	0.750	35	81	4,500	2,042

Box

Stock #	Trade Size		Wire Dia. (In.)	Inside Link Dim. (Inches)		Ft. Per Box	Net Wt. (Lbs.)	Working Load Limit	
	Inches	MM		Length (Nominal)	Width (Min.)			Lbs.	Kgs.
5451135	3/16	5.5	0.217	0.980	0.400	375	155	800	363
5451235	1/4	7	0.276	1.240	0.460	225	146	1,300	590
5451335	5/16	8	0.331	1.290	0.550	150	122	1,900	862



DO NOT EXCEED CAPACITY!
See the SAFETY GUIDELINES section before using these products. Pages 138-149.

HARDWARE CHAIN

Grade 30 Import Proof Coil Chain (NACM)

A general utility chain for farm, industrial and home applications such as: log chain, cargo lashing, pipeline hanging, tailgate, guard rail, tow and switch chain. Order unit is foot. **NOT FOR OVERHEAD LIFTING**



Full Drum

Stock #			Trade Size		Wire Dia. (In.)	Inside Link Dim. (Inches)		Ft. Per Drum	Net Wt. (Lbs.)	WLL	
Self-Colored	Zinc	HDG	In.	MM		Length (Nominal)	Width (Min.)			Lbs.	Kgs.
H0117-0300	H0117-0311	H0117-0315	3/16	5.5	0.217	0.980	0.400	1500	525	800	363
H0117-0400	H0117-0411	H0117-0415	1/4	7	0.276	1.240	0.460	800	448	1,300	590
H0117-0500	H0117-0511	H0117-0515	5/16	8	0.331	1.290	0.550	550	457	1,900	862
H0117-0600	H0117-0611	H0117-0615	3/8	10	0.394	1.380	0.550	400	568	2,650	1,202
H0117-0800	H0117-0811	H0117-0815	1/2	13	0.512	1.790	0.720	200	524	4,500	2,042



Half Drum

Stock #	Trade Size		Wire Dia. (In.)	Inside Link Dim. (Inches)		Ft. Per Drum	Net Wt. (Lbs.)	WLL	
Zinc	In.	MM		Length (Nominal)	Width (Min.)			Lbs.	Kgs.
H0115-0411	1/4	7	0.276	1.240	0.460	400	224	1,300	590
H0115-0511	5/16	8	0.331	1.290	0.550	275	228	1,900	862
H0115-0611	3/8	10	0.394	1.380	0.550	200	284	2,650	1,202

5 Gallon Square Pail

Stock #	Trade Size		Wire Dia. (In.)	Inside Link Dim. (Inches)		Ft. Per Pail	Net Wt. (Lbs.)	WLL	
Zinc	In.	MM		Length (Nominal)	Width (Min.)			Lbs.	Kgs.
H0111-0211	1/8	4	0.156	0.940	0.250	500	110	400	181
H0111-0311	3/16	5.5	0.217	0.980	0.400	250	88	800	363
H0111-0411	1/4	7	0.276	1.240	0.460	141	79	1,300	590
H0111-0511	5/16	8	0.331	1.290	0.550	92	76	1,900	862
H0111-0611	3/8	10	0.394	1.380	0.550	63	89	2,650	1,202



DO NOT EXCEED CAPACITY!
See the SAFETY GUIDELINES section before using these products. Pages 138-149.



Grade 30 Import Proof Coil Chain (NACM) Cont.

Order unit is foot. **NOT FOR OVERHEAD LIFTING**



5 Gallon Round Pail

Stock #			Trade Size		Wire Dia. (Inches)	Inside Link Dim. (Inches)		Ft. Per Pail	Net Wt. (Lbs.)	Working Load Limit	
Self Colored	Zinc	HDG	Inches	MM		Length (Nominal)	Width (Min.)			Lbs.	Kgs.
-	H0110-0211	H0110-0215	1/8	4	0.156	0.940	0.250	500	110	400	181
H0110-0300	H0110-0311	H0110-0315	3/16	5.5	0.217	0.980	0.400	250	88	800	363
H0110-0400	H0110-0411	H0110-0415	1/4	7	0.276	1.240	0.460	141	79	1,300	590
H0110-0500	H0110-0511	H0110-0515	5/16	8	0.331	1.290	0.550	92	76	1,900	862
H0110-0600	H0110-0611	H0110-0615	3/8	10	0.394	1.380	0.550	63	89	2,650	1,202
H0110-0800	H0110-0811	H0110-0815	1/2	13	0.512	1.790	0.720	40	105	4,500	2,042

12" Reel

Stock #	Trade Size		Wire Dia. (Inches)	Inside Link Dim. (Inches)		Ft. Per Reel	Net Wt. (Lbs.)	Working Load Limit	
	Inches	MM		Length (Nominal)	Width (Min.)			Lbs.	Kgs.
H0107-0311	3/16	5.5	0.217	0.980	0.400	100	35	800	363
H0107-0411	1/4	7	0.276	1.240	0.460	75	42	1,300	590
H0107-0511	5/16	8	0.331	1.290	0.550	70	58	1,900	862
H0107-0611	3/8	10	0.394	1.380	0.550	45	64	2,650	1,202



DO NOT EXCEED CAPACITY!
See the SAFETY GUIDELINES section before using these products. Pages 138-149.

G30 Import Proof Coil Chain (Short Link)

Order unit is foot. **NOT FOR OVERHEAD LIFTING.**

Full Drum

Stock #			Trade Size (In.)	Wire Dia. (In.)	Inside Dimensions (Inches)		Qty. Per Drum	Net Wt. (Lbs.)	Working Load Limit	
Self-Colored	Zinc	HDG			Length (Nominal)	Width (Minimal)			Lbs.	Kgs.
H0116-0300	H0116-0311	H0116-0315	3/16	0.218	0.990	0.420	1500	615	800	363
H0116-0400	H0116-0411	H0116-0415	1/4	0.281	1.040	0.490	800	608	1,300	590
H0116-0500	H0116-0511	H0116-0515	5/16	0.343	1.140	0.490	550	561	1,900	862
H0116-0600	H0116-0611	H0116-0615	3/8	0.406	1.280	0.610	400	568	2,650	1,202
H0116-0800	H0116-0811	H0116-0815	1/2	0.531	1.560	0.810	200	524	4,500	2,042
H0116-0900	---	H0116-0915	5/8	0.656	1.940	1.000	150	533	6,900	3,131
H0116-1000	---	H0116-1015	3/4	0.787	2.760	1.000	100	550	10,600	4,810

Half Drum

Stock #			Trade Size (In.)	Wire Dia. (In.)	Inside Dimensions (Inches)		Qty. Per Drum	Net Wt. (Lbs.)	Working Load Limit	
Self-Colored	Zinc	HDG			Length (Nominal)	Width (Minimal)			Lbs.	Kgs.
---	---	H0114-0215	1/8	0.156	0.940	0.250	1000	230	400	181
H0114-0300	H0114-0311	H0114-0315	3/16	0.218	0.990	0.420	750	308	800	363
H0114-0400	H0114-0411	H0114-0415	1/4	0.281	1.040	0.490	400	304	1,300	590
H0114-0500	H0114-0511	H0114-0515	5/16	0.343	1.140	0.490	275	281	1,900	862
H0114-0600	H0114-0611	H0114-0615	3/8	0.406	1.280	0.610	200	284	2,650	1,202
H0114-0800	H0114-0811	H0114-0815	1/2	0.531	1.560	0.810	100	262	4,500	2,042



DO NOT EXCEED CAPACITY!
See the SAFETY GUIDELINES section before using these products. Pages 138-149.

Straight Link Coil Chain

Straight link coil chain is a welded chain easily identified by its link design. The link is long and relatively narrow in proportion. It's an excellent choice for tailgates, trailer safety chain and barrier chain. Order unit is foot. **NOT FOR OVERHEAD LIFTING.**

Pails & Drums

Stock #	Zinc Trade Size	Wire Dia. (Inches)	Inside Link Dim. (In.)		Pkg. Type	Ft. Per Pkg.	Net Wt. (Lbs.)	WLL	
			Length	Width				Lbs.	Kgs.
8605951	4	0.119	1.120	0.220	Drum	1,000	103	205	93
5360235	2	0.147	1.180	0.270	Pail	400	62	310	141
8606374	2	0.147	1.180	0.270	Drum	2,500	385	310	141
5361035	1/0	0.175	1.240	0.320	Pail	250	56	440	200
8605310	1/0	0.175	1.240	0.320	Drum	2,000	450	440	200
5362035	2/0	0.190	1.310	0.340	Pail	250	68	520	236
H0810-2111	2/0	0.190	1.310	0.340	Pail	350	101	520	236
8605739	2/0	0.190	1.310	0.340	Drum	1,000	281	520	236
5364035	4/0	0.217	1.390	0.410	Pail	200	73	670	304
6044033	4/0	0.217	1.390	0.410	Drum	1,500	364	670	304
5365035	5/0	0.247	1.520	0.480	Pail	150	74	880	399
6045033	5/0	0.247	1.520	0.480	Drum	1,000	490	880	399
5367035	7/0	0.311	1.850	0.560	Pail	100	75	1,375	623
8610818	7/0	0.311	1.850	0.560	Drum	500	375	1,375	623



DO NOT EXCEED CAPACITY!
See the SAFETY GUIDELINES section before using these products. Pages 138-149.



Straight Link Coil Chain Cont.

Reels & Cartons

Stock #	Trade Size	Wire Dia. (Inches)	Inside Link Dim. (In.)		Pkg. Type	Ft. Per Pkg.	Net Wt. (Lbs.)	WLL	
			Length	Width				Lbs.	Kgs.
6040450	4	0.119	1.120	0.220	Reel	65	7	205	93
6040432	4	0.119	1.120	0.220	Carton	100	10	205	93
6040250	2	0.147	1.180	0.270	Reel	65	10	310	141
6040232	2	0.147	1.180	0.270	Carton	100	15	310	141
6041050	1/0	0.175	1.240	0.320	Reel	75	17	440	200
6041032	1/0	0.175	1.240	0.320	Carton	100	23	440	200
6042085*	2/0	0.190	1.310	0.340	Reel	50	15	445	202
6042050	2/0	0.190	1.310	0.340	Reel	60	17	520	236
H0807-2111	2/0	0.190	1.310	0.340	Reel	125	36	520	236
6042032	2/0	0.190	1.310	0.340	Carton	100	28	520	236
6044056	4/0	0.217	1.390	0.410	Reel	50	19	670	304
6044050	4/0	0.217	1.390	0.410	Reel	100	36	670	304
6044032	4/0	0.217	1.390	0.410	Carton	100	36	670	304
6045050	5/0	0.247	1.520	0.480	Reel	75	37	880	399
6045032	5/0	0.247	1.520	0.480	Carton	100	49	880	399
6047050	7/0	0.311	1.850	0.560	Reel	40	30	1,375	623
6047032	7/0	0.311	1.850	0.560	Carton	100	75	1,375	623

*Stainless Steel Finish



Pails & Drums

Yellow Powder Coat & Hot Dip Galvanized.

Stock #	Finish	Trade Size	Wire Dia. (Inches)	Inside Link Dim. (Inches)		Pkg. Type	Ft. Per Pkg.	Net Wt. (Lbs.)	WLL	
				Length	Width				Lbs.	Kgs.
5362039	Yell. Pwdr. Coat	2/0	0.190	1.310	0.340	Pail	200	56	520	236
460114011	Yell. Pwdr.Coat	4/0	0.217	1.390	0.410	Drum	400	142	670	304
460144008	HDG	4/0	0.217	1.390	0.410	Pail	250	91	670	304
460144003	HDG	4/0	0.217	1.390	0.410	Drum	1,500	546	670	304



WARNING

DO NOT EXCEED CAPACITY!
See the SAFETY GUIDELINES section before using these products. Pages 138-149.

TWIST LINK COIL, STRAIGHT LINK MACHINE CHAIN

Twist Link Coil Chain

A modification of straight link coil chain which allows the chain to lay flatter. Order unit is foot. **NOT FOR OVERHEAD LIFTING**

Square Pails, Reels & Cartons

Stock #	Trade Size	Wire Dia. (Inches)	Inside Link Dim. (Inches)		Pkg. Type	Ft. Per Pkg.	Net Wt. (Lbs.)	Working Load Limit	
			Length	Width				Lbs.	Kgs.
6050432	4	0.120	1.090	0.220	Carton	100	10	195	88
6051050	1/0	0.175	1.220	0.320	Reel	70	17	415	188
5351035	1/0	0.175	1.220	0.320	Pail	250	59	415	188
6052032	2/0	0.192	1.240	0.380	Carton	100	28	495	225
H0520-2111	2/0	0.192	1.240	0.380	Carton	100	28	495	225
6054032	4/0	0.218	1.330	0.420	Carton	100	39	635	288

Straight Link Machine Chain

Straight link machine chain is a welded chain noted for its flexibility. Used for overhead doors, tailgates and agricultural implements. Order unit is foot. **NOT FOR OVERHEAD LIFTING**

Pails, Reels & Cartons

Stock #	Trade Size	Wire Dia. (Inches)	Inside Link Dim. (Inches)		Pkg. Type	Ft. Per Pkg.	Net Wt. (Lbs.)	Working Load Limit	
			Length	Width				Lbs.	Kgs.
6010450	4	0.120	0.550	0.220	Reel	125	16	215	98
6010432	4	0.120	0.550	0.220	Carton	100	13	215	98
H0708-2411	4	0.120	0.550	0.220	Reel	200	22	215	98
H0710-2411	4	0.120	0.550	0.220	Pail	800	90	215	98
6010332	3	0.135	0.590	0.240	Carton	100	15	270	123
6010250	2	0.148	0.630	0.270	Reel	70	13	325	148
6010232	2	0.148	0.630	0.270	Carton	100	19	325	148
6011050	1/0	0.177	0.740	0.320	Reel	75	20	465	212
6011032	1/0	0.177	0.740	0.320	Carton	100	27	465	212
6012050	2/0	0.192	0.780	0.350	Reel	70	22	545	247
6012032	2/0	0.192	0.780	0.350	Carton	100	32	545	247
H0710-2111	2/0	0.192	0.780	0.350	Pail	300	101	545	247
6014032	4/0	0.218	0.950	0.400	Carton	100	42	700	317
6015032	5/0	0.250	1.070	0.450	Carton	100	53	925	419



DO NOT EXCEED CAPACITY!
See the SAFETY GUIDELINES section before using these products. Pages 138-149.

Twist Link Machine Chain

A modification of straight link chain which allows the chain to lay flatter. Order unit is foot. **NOT FOR OVERHEAD LIFTING**

Pails, Reels & Cartons

Stock #	Zinc	Trade Size	Wire Dia. (Inches)	Inside Link Dim. (Inches)		Pkg. Type	Ft. Per Pkg.	Net Wt. (Lbs.)	Working Load Limit	
				Length	Width				Lbs.	Kgs.
6020532		5	0.105	0.470	0.150	Carton	100	10	155	70
6020450		4	0.120	0.520	0.180	Reel	160	22	205	93
6020432		4	0.120	0.520	0.180	Carton	100	13	205	93
H0608-2411		4	0.120	0.520	0.180	Reel	200	27	205	93
6020332		3	0.135	0.560	0.190	Carton	100	16	255	116
6020232		2	0.148	0.580	0.220	Carton	100	20	310	140
6021032		1/0	0.177	0.680	0.270	Carton	100	30	440	199
6022050		2/0	0.192	0.730	0.290	Reel	65	24	520	236
H0608-2111		2/0	0.192	0.730	0.290	Reel	75	25	520	236
H0610-2111		2/0	0.192	0.730	0.290	Pail	300	101	520	236
6022032		2/0	0.192	0.730	0.290	Carton	100	35	520	236
6024032		4/0	0.218	0.890	0.340	Carton	100	44	670	303



Passing Link Chain

A welded chain with links sufficiently wide to allow them to pass one another freely, eliminating the tendency to kink. It is used for gates, farm machinery and general utility industry. Order unit is foot. **NOT FOR OVERHEAD LIFTING**

Pails, Reels & Cartons

Stock #	Zinc	Trade Size	Wire Dia. (Inches)	Inside Link Dim. (Inches)		Pkg. Type	Ft. Per Pkg.	Net Wt. (Lbs.)	Working Load Limit	
				Length	Width				Lbs.	Kgs.
6072050		2/0	0.192	0.860	0.470	Reel	95	31	450	204
6072032		2/0	0.192	0.860	0.470	Carton	100	33	450	204
H0910-2111		2/0	0.192	0.860	0.470	Pail	300	101	450	204
6074032		4/0	0.218	0.860	0.500	Carton	100	44	600	272



DO NOT EXCEED CAPACITY!
See the SAFETY GUIDELINES section before using these products. Pages 138-149.

TWIN LOOP & BRASS PLUMBERS CHAIN



Twin Loop Chain

A weldless chain that combines strength, flexibility, light weight and neat appearance. It is an all purpose chain for a wide variety of uses including swing sets, animal chains and hammocks. Note: It is recommended that no twin loop chain smaller than 1/0 be used for swing sets. Order unit is foot. **NOT FOR OVERHEAD LIFTING**

Reels, Cartons & Square Pails

Stock #	Zinc	Trade Size	Wire Dia. (Inches)	Inside Link Dim. (Inches)		Pkg. Type	Ft. Per Pkg.	Net Wt. (Lbs.)	WLL	
				Length	Width				Lbs.	Kgs.
7010550	5	0.063	1.325	0.270	Reel	250	10	55	25	
7010532	5	0.063	1.325	0.270	Carton	100	4	55	25	
7010450	4	0.072	1.000	0.239	Reel	200	10	70	32	
7010432	4	0.072	1.000	0.239	Carton	100	5	70	32	
7010350	3	0.080	1.530	0.275	Reel	150	9	90	41	
7010332	3	0.080	1.530	0.275	Carton	100	6	90	41	
5370335	3	0.080	1.530	0.275	Pail	500	30	90	41	
7010232	2	0.092	2.000	0.350	Carton	100	8	115	52	
7010150	1	0.105	2.000	0.350	Reel	85	9	155	70	
7010132	1	0.105	2.000	0.350	Carton	100	10	155	70	
5370135	1	0.105	2.000	0.350	Pail	300	30	155	70	
7011050	1/0	0.120	2.173	0.398	Reel	150	18	200	91	
7011032	1/0	0.120	2.173	0.398	Carton	100	12	200	91	
7012050	2/0	0.135	2.211	0.388	Reel	125	21	255	116	
7012080*	2/0	0.135	2.211	0.388	Reel	80	14	255	116	
7012032	2/0	0.135	2.211	0.388	Carton	100	17	255	116	
7052035	2/0	0.135	2.211	0.388	Carton	250	43	255	116	
5372035	2/0	0.135	2.211	0.388	Pail	225	38	255	116	
7013050	3/0	0.148	2.170	0.408	Reel	110	24	305	138	
7013032	3/0	0.148	2.170	0.408	Carton	100	22	305	138	
5373035	3/0	0.148	2.170	0.408	Pail	200	44	305	138	
7014032	4/0	0.160	2.190	0.405	Carton	100	25	365	165	

*Green Vinyl Sleeve

Brass Plumbers Chain

Plumbers chain is a stamped and formed solid brass chain used for plumbing fixtures, as well as other uses requiring a light flat metal chain. Order unit is foot.

NOT FOR OVERHEAD LIFTING

Reels & Cartons

Stock #	Trade Size	Wire Dia. (Inches)	Inside Link Dim. (Inches)		Pkg. Type	Ft. Per Pkg.	Net Wt. (Lbs.)	Working Load Limit	
			Length	Width				Lbs.	Kgs.
7651050	1/0	0.023	0.505	---	Reel	200	6	35	16
7651012	1/0	0.023	0.505	---	Carton	100	3	35	16
7652012	2/0	0.018	0.545	---	Carton	100	2	23	11

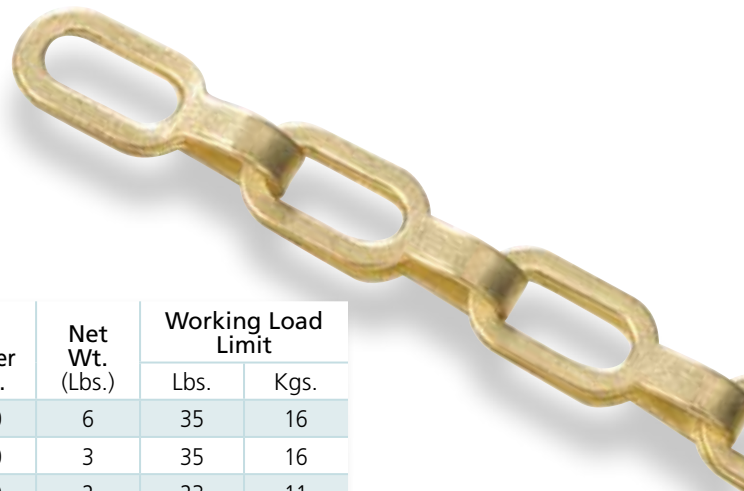

DO NOT EXCEED CAPACITY!
See the SAFETY GUIDELINES section before using these products. Pages 138-149.

Sash Chain

Sash chain is a stamped, formed chain slightly stronger than Jack chain. It is used for operating heater controls on ducts and dampers, as well as window sashes in double hung windows. Order unit is foot. **NOT FOR OVERHEAD LIFTING**

Reels & Cartons

Stock #	Trade Size	Wire Dia. (Inches)	Inside Link Dim. (Inches)		Pkg. Type	Ft. Per Pkg.	Net Wt. (Lbs.)	Working Load Limit	
			Length	Width				Lbs.	Kgs.
7700832	8	0.035	0.560	---	Carton	100	4	75	34
7702532	25	0.042	0.560	---	Carton	100	5	94	43
7703550	35	0.035	0.560	---	Reel	100	6	106	48
7703532	35	0.035	0.560	---	Carton	100	6	106	48
7704032	40	0.042	0.570	---	Carton	100	7	131	59
7705032	50	0.060	0.630	---	Carton	100	12	225	102

Jack Chain

Single Jack chain is the lightest and smallest of regular commercial chain formed from wire. It is used in applications where high strength is not required. Order unit is foot. **NOT FOR OVERHEAD LIFTING**

Reels & Cartons

Stock #	Trade Size	Wire Dia. (Inches)	Inside Link Dim. (Inches)		Pkg. Type	Ft. Per Pkg.	Net Wt. (Lbs.)	Working Load Limit	
			Length	Width				Lbs.	Kgs.
7501650	16	0.062	0.500	---	Reel	200	6	10	5
7501655*	16	0.062	0.500	--	Reel	200	6	10	5
7501632	16	0.062	0.500	---	Carton	100	3	10	5
7501450	14	0.080	0.630	---	Reel	100	5	16	7
7501432	14	0.080	0.630	---	Carton	100	5	16	7
7501250	12	0.105	0.750	---	Reel	100	9	29	13
7501232	12	0.105	0.750	---	Carton	100	9	29	13
7501032	10	0.135	0.930	---	Carton	100	14	43	20
7500832	8	0.162	1.090	---	Carton	100	21	60	27
7500632	6	0.192	1.240	---	Carton	100	30	88	40

*Yellow Chromate



DO NOT EXCEED CAPACITY!
See the SAFETY GUIDELINES section before using these products. Pages 138-149.

LOCK LINK, DECORATIVE CHAIN & PET TIE OUTS



Lock Link Chain

The strongest weldless chain with all links facing in the same direction, making it ideal for pipe suspension and operating overhead doors and steam valves. Order unit is foot. **NOT FOR OVERHEAD LIFTING**

Cartons

Stock #	Trade Size	Wire Dia. (Inches)	Inside Link Dim. (Inches)		Ft. Per Carton	Net Wt. (Lbs. /ft.)	Working Load Limit	
			Length	Width			Lbs.	Kgs.
250320201	2	0.091	1.090	0.350	100	0.10	155	70
250321001	1/0	0.120	1.290	0.430	100	0.17	265	120
7022032	2/0	0.135	1.490	0.450	100	0.24	340	154
250324001	4/0	0.162	1.780	0.520	100	0.29	485	220
250325001	5/0	0.177	2.140	0.630	100	0.34	580	263

**Made with pre-galvanized wire*

Decorative Chain



Reels

Stock #	Finish	Wire Dia. (Inches)	Inside Link Dim. (Inches)		Pkg. Type	Ft. Per Pkg.	Net Wt. (Lbs.)	Working Load Limit	
			Length	Width				Lbs.	Kgs.
4505150	Brass	0.12	1.25	0.62	Reel	50	7	25	11
4505250	Black	0.12	1.25	0.62	Reel	50	7	25	11
4505350	Antique Brass	0.12	1.25	0.62	Reel	50	7	25	11
4505450	White	0.12	1.25	0.62	Reel	50	7	25	11
4505550	Brushed Nickel	0.12	1.25	0.62	Reel	50	7	25	11
4505650	Oil-Rubbed Bronze	0.12	1.25	0.62	Reel	50	7	25	11

Pet Tie-Outs



10' Dog Tie Out/Runner

Stock#: **8330560**
Weight: 0.74 Lbs./Ea.
Factory Package: 5/Ctn.
Order Unit: Each



15' Light Weight Pet Tie-Out

Stock#: **4831135**
Weight: 1.28 Lbs./Ea.
Factory Package: 2/Ctn.
Order Unit: Each



20' Heavy Duty Pet Tie-Out

Stock#: **4837060**
Weight: 4.10 Lbs./Ea.
Factory Package: 2/Ctn.
Order Unit: Each



DO NOT EXCEED CAPACITY!
See the SAFETY GUIDELINES section before using these products. Pages 138-149.



Plastic Chain & Accessories

A light duty plastic chain made of polypropylene used mainly for decorative purposes, as a barrier or to guide traffic. Plastic chain is durable, light weight and weather resistant. Order unit is foot.

NOT FOR OVERHEAD LIFTING

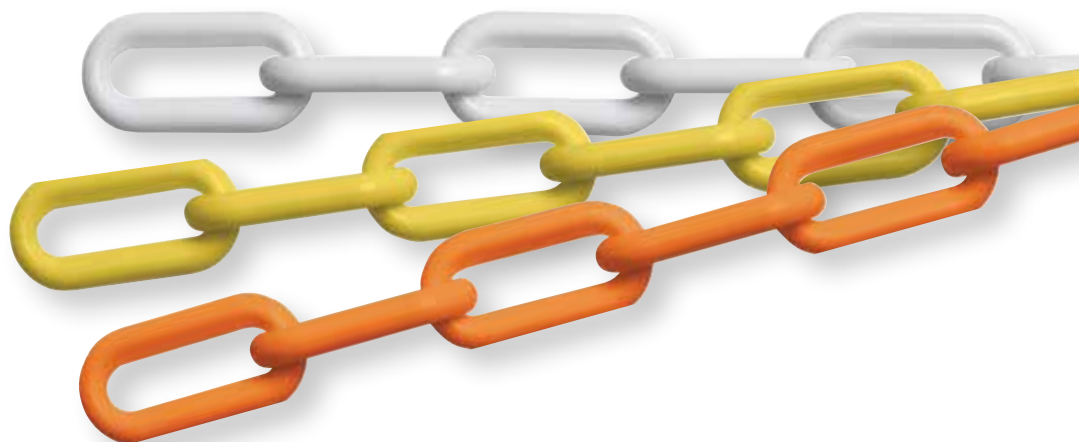

4.25 Gallon Square Pails

Stock #				Trade Size		Dia. (In.)	Inside Link Dim. (In.)		Ft. Per Pail	Net Wt. (Lbs.)	Working Load Limit	
White	Yellow	Red	Hot Orange	In.	MM		Length	Width			Lbs.	Kgs.
H2612-0450	H2612-0452	H2612-0454	H2612-0455	1/4	6	0.230	1.000	0.320	200	11.50	25	11
H2612-0550	H2612-0552	H2612-0554	H2612-0555	5/16	8	0.305	1.520	0.390	150	12.50	40	18

Reels

Stock #				Trade Size	Dia. (In.)	Inside Link Dim. (In.)		Ft. Per Reel	Net Wt. (Lbs.)	Working Load Limit	
White	Yellow	Black	Hot Orange			Length	Width			Lbs.	Kgs.
4540351	4540352	4540353	4540354	#8	0.29	1.31	.50	60	5	20	9

Connecting Links

Split links of plastic chain used to connect two pieces of plastic chain together.

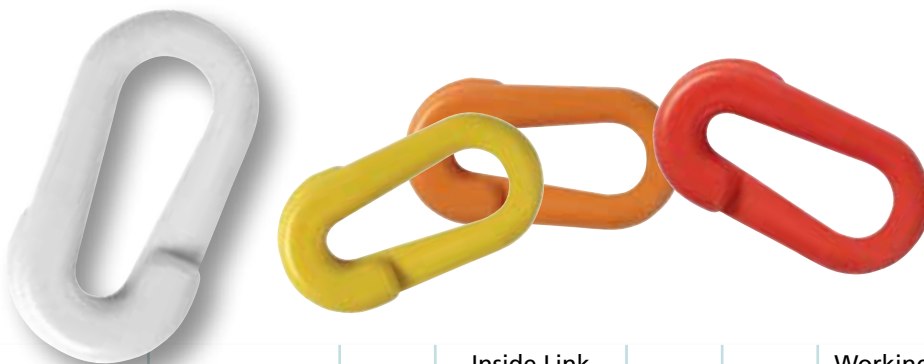

Stock #				Trade Size		Dia. (In.)	Inside Link Dim. (In.)		Qty. Per Pkg.	Net Wt. (Lbs.)	Working Load Limit	
White	Yellow	Red	Hot Orange	(In.)	(MM)		Length	Width			Lbs.	Kgs.
H2698-0450	H2698-0452	H2698-0454	H2698-0455	1/4	6	0.230	1.051	0.307	25	0.35	25	11
H2698-0550	H2698-0552	H2698-0554	H2698-0555	5/16	8	0.305	1.461	0.355	25	0.50	40	18



DO NOT EXCEED CAPACITY!
See the SAFETY GUIDELINES section before using these products. Pages 138-149.



PEERLESS
A KITO GROUP COMPANY

**ALL OF THIS AND
MORE FROM A SINGLE
SOURCE!**

www.peerlesschain.com



PEERLESS  **PEERLESS** Custom Lifting Accoloy Kuplex Peer-Lift ProLok66
Boatman's Pride Auto-Trac SUPER Z SmartBar GrabBar SecureBar QuikBinder Plus

CHAIN ACCESSORIES

- Clevis & Eye Type Hooks 99-102
- Coupling Links 100
- Double Clevis Links 100, 102
- Weld-On Grab Hook 102
- Shackles 103
- Repair Lap Links 103
- Cold Shuts 104
- Connecting Links 104
- Quick Links 104, 109
- Spring Links 105, 109
- Hitch Pin Clips 105
- S-Hooks 105
- Swivel Eye Pulleys 106
- Screw Eyes 106
- Rope Accessories 106
- Snaps & Swivels 107-108
- Stainless Steel Chain Accessories 109

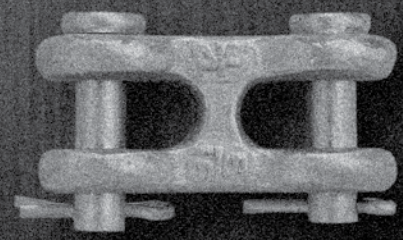
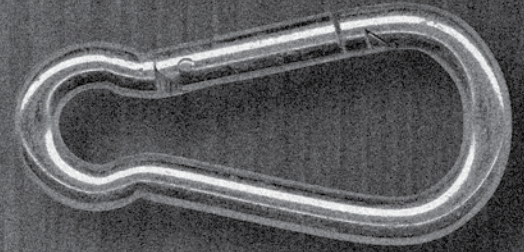
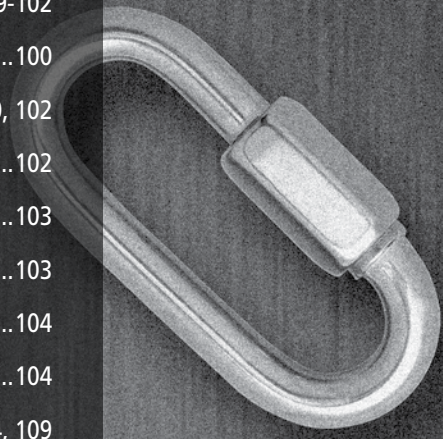

Forged Hooks NOT FOR OVERHEAD LIFTING

Transport (T80) Clevis Grab Hook - Domestic

Stock # UPC Tagged	Chain Size (Inches)	Dimensions (Inches)				Qty. Per Pkg.	Lbs. Per Each	Working Load Limit	
		A	B	C	D			Lbs.	Kgs.
8024215	1/4	0.310	0.380	0.330	1.880	10	0.42	3,500	1,588
8024315	5/16	0.380	0.440	0.390	2.380	10	0.72	4,500	2,041
8024415	3/8	0.450	0.500	0.500	2.630	10	1.14	7,100	3,221
8024615	1/2	0.590	0.660	0.590	3.310	10	2.32	12,000	5,443
8024815	5/8	0.750	0.780	0.750	3.940	5	4.08	18,100	8,210

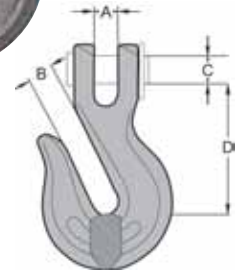

Transport (T80) Clevis Grab Hook

Stock # UPC Tagged	Chain Size (Inches)	Dimensions (Inches)				Qty. Per Pkg.	Lbs. Per Each	Working Load Limit	
		A	B	C	D			Lbs.	Kgs.
8008450	3/8	0.480	0.500	0.470	2.630	10	1.00	7,100	3,220
8008650	1/2	0.750	0.660	0.630	3.190	10	2.20	12,000	5,443

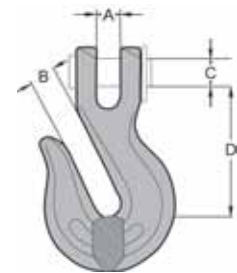
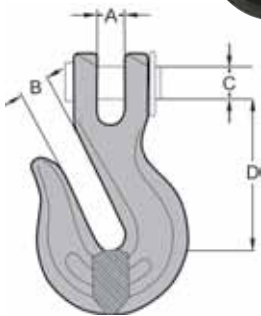

Transport (G70) Clevis Grab Hook

Stock #			Chain Size (Inches)	Dimensions (Inches)				Qty. Per Pkg.	Lbs. Per Each	Working Load Limit	
UPC Tagged	UPC Tagged	Bulk		A	B	C	D			Lbs.	Kgs.
Self-Colored	Yellow Zinc										
8022215	8022230	8022255	1/4	0.360	0.400	0.380	1.970	10	0.4	3,150	1,429
8022315	8022330	8022355	5/16	0.380	0.440	0.440	2.340	10	0.72	4,700	2,132
8022415	8022430	8022455	3/8	0.450	0.500	0.470	2.660	10	1.07	6,600	2,994
8022615	8022630	8022655	1/2	0.750	0.620	0.630	3.280	5	2.16	11,300	5,127
---	---	8022855	5/8	0.910	0.780	0.750	3.780	5	3.75	15,800	7,166



DO NOT EXCEED CAPACITY!
See the SAFETY GUIDELINES section before using these products. Pages 138-149.

CHAIN ACCESSORIES

Forged Hooks & Connectors

NOT FOR OVERHEAD LIFTING

Transport (G70) Clevis Slip Hook - w/Latch

Stock #		Chain Size (Inches)	Dimensions (Inches)				Qty. Per Pkg.	Lbs. Per Each	Working Load Limit	
Bulk	UPC Tagged		A	B	C	D			Lbs.	Kgs.
Yellow Zinc										
8015275	8015266	1/4	0.440	0.750	0.380	2.610	10	0.65	3,150	1,429
8015375	8015366	5/16	0.455	0.900	0.440	2.870	10	0.87	4,700	2,132
8015475	8015466	3/8	0.545	1.135	0.470	3.310	10	1.30	6,600	2,994
8015675	8015666	1/2	0.700	1.345	0.630	4.000	5	2.85	11,300	5,127
8015875	---	5/8	0.900	1.750	0.750	4.940	5	5.30	15,800	7,166

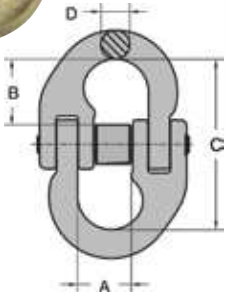
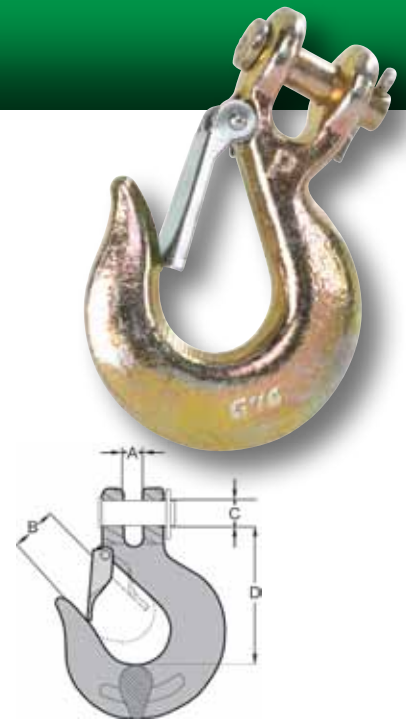

Transport (G70) Coupling Link

Stock #		Chain Size (Inches)	Dimensions (Inches)				Qty. Per Pkg.	Lbs. Per Each	Working Load Limit	
UPC Tagged	Yellow Zinc		A	B	C	D			Lbs.	Kgs.
8153055		1/4	0.580	0.700	1.800	0.380	5	0.28	3,150	1,429
8153155		5/16	0.630	0.900	2.250	0.400	5	0.58	4,700	2,132
8153255		3/8	0.880	1.000	2.650	0.510	5	0.75	6,600	2,994
8153355		1/2	1.000	1.450	3.400	0.630	5	1.60	11,300	5,127
8153455		5/8	1.33	1.75	4.1	0.75	5	2.50	15,800	7,166

Transport (G70) Double Clevis Link

Drop forged, quenched & tempered. Use with G70 chain.

Stock #		Chain Size (Inches)	Dimensions (Inches)				Qty. Per Pkg.	Lbs. Per Each	Working Load Limit	
Bulk	UPC Tagged		A	R	D	G			Lbs.	Kgs.
8057235	8057230	1/4-5/16	0.470	1.180	0.380	0.430	10	0.33	4,700	2,132
8057435	---	3/8	0.530	1.400	0.450	0.480	10	0.60	6,600	2,994
---	8057530	3/8-5/16	0.510	1.400	0.440	0.450	10	0.57	6,600	2,994
8057635	8057630	7/16-1/2	0.650	1.750	0.560	0.630	10	1.00	11,300	5,127

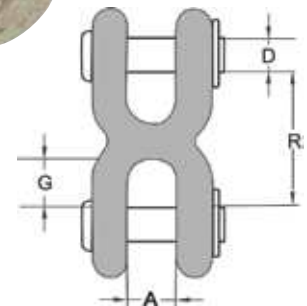

DO NOT EXCEED CAPACITY!
See the SAFETY GUIDELINES section before using these products. Pages 138-149.

G43 Clevis Grab Hook

Stock #			Chain Size (In.)	Dimensions (Inches)				Qty. Per Pkg	Lbs. Per Each	Working Load Limit	
UPC Tagged		Bulk		A	B	C	C			Lbs.	Kgs.
Self Color	Zinc										
8023215	8023230	8023235	1/4	0.360	0.400	0.380	1.970	10	0.47	2,600	1,179
8023315	8023330	8023335	5/16	0.400	0.440	0.440	2.260	10	0.75	3,900	1,769
8023415	8023430	8023435	3/8	0.480	0.500	0.470	2.630	10	1.10	5,400	2,450
8023615	8023630	8023635	1/2	0.750	0.660	0.630	3.190	10	2.52	9,200	4,173

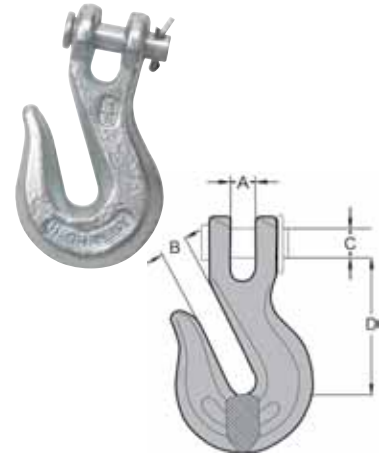

G43 Clevis Slip Hook - w/Latch

Stock #			Chain Size (Inches)	Dimensions (Inches)				Qty. Per Pkg.	Lbs. Per Each	Working Load Limit	
UPC Tagged		Bulk		A	B	C	D			Lbs.	Kgs.
Zinc											
8016266	8016275	8016275	1/4	0.440	0.790	0.380	2.560	10	0.59	2,600	1,179
8016366	8016375	8016375	5/16	0.500	0.930	0.440	2.870	10	0.93	3,900	1,769
8016466	8016475	8016475	3/8	0.590	1.140	0.470	3.250	10	1.30	5,400	2,450
8016666	8016675	8016675	1/2	0.750	1.420	0.630	4.000	5	3.21	9,200	4,173

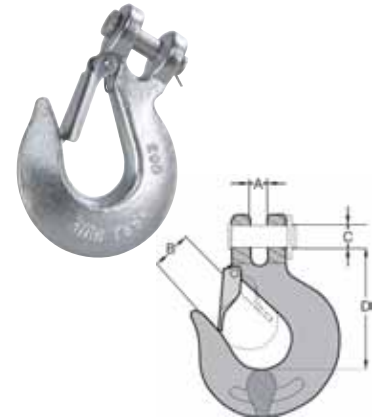

G43 Clevis Slip Hook

Stock #			Chain Size (Inches)	Dimensions (Inches)				Qty. Per Pkg.	Lbs. Per Each	Working Load Limit	
UPC Tagged		Bulk		A	B	C	D			Lbs.	Kgs.
Zinc											
8013230	8013235	8013235	1/4	0.440	0.940	0.370	2.560	10	0.45	2,600	1,179
8013330	8013335	8013335	5/16	0.500	1.060	0.440	2.870	10	0.69	3,900	1,769
8013430	8013435	8013435	3/8	0.590	1.310	0.470	3.250	10	1.10	5,400	2,450
8013630	8013635	8013635	1/2	0.750	1.690	0.630	4.000	5	2.45	9,200	4,173



G43 Eye Grab Hook

Stock #			Chain Size (Inches)	Dimensions (Inches)			Qty. Per Pkg.	Lbs. Per Each	Working Load Limit	
UPC Tagged		Bulk		A	B	C			Lbs.	Kgs.
Self Color	Zinc									
8025215	8025230	8025235	1/4	0.310	1.900	0.340	10	0.28	2,600	1,179
8025315	8025330	8025335	5/16	0.400	2.250	0.440	10	0.45	3,900	1,769
8025415	8025430	8025435	3/8	0.440	2.620	0.500	10	0.79	5,400	2,450
8025615	8025630	8025635	1/2	0.560	3.380	0.660	10	1.80	9,200	4,173



DO NOT EXCEED CAPACITY!
See the SAFETY GUIDELINES section before using these products. Pages 138-149.

CHAIN ACCESSORIES

Chain Accessories

NOT FOR OVERHEAD LIFTING

G43 Eye Slip Hook - w/Latch

Stock#	Chain Size (Inches)	Dimensions (Inches)				Qty. Per Pkg.	Lbs. Per Each	Working Load Limit	
		A	B	C	D			Lbs.	Kgs.
8011275	1/4	0.500	2.560	0.750	0.790	10	0.42	2,600	1,179
8011375	5/16	0.630	2.950	0.880	0.790	10	0.72	3,900	1,769
8011475	3/8	0.720	3.360	1.100	1.020	10	1.03	5,400	2,450
8011675	1/2	0.940	4.280	1.380	1.300	10	2.45	9,200	4,173

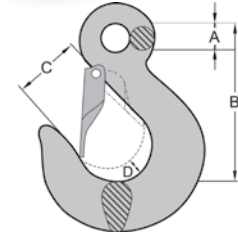

G43 Eye Slip Hook

Stock #		Chain Size (In.)	Dimensions (Inches)			Qty. Per Pkg	Lbs. Per Each	Working Load Limit	
UPC Tagged	Bulk		A	B	C			Lbs.	Kgs.
8011230	8011235	1/4	0.500	2.560	0.940	10	0.40	2,600	1,179
8011330	8011335	5/16	0.630	2.950	1.060	10	0.70	3,900	1,769
8011430	8011435	3/8	0.720	3.360	1.310	10	1.00	5,400	2,450
8011630	8011635	1/2	0.940	4.280	1.690	10	2.40	9,200	4,173



G43 Double Clevis Link

Stock #	Chain Size (Inches)	Dimensions (Inches)				Qty. Per Pkg.	Lbs. Per Each	Working Load Limit	
		A	R	D	G			Lbs.	Kgs.
8027235	1/4-5/16	0.470	1.180	0.380	0.430	10	0.30	3,900	1,769
8027435	3/8	0.530	1.340	0.470	0.480	10	0.40	5,400	2,450
8027635	7/16-1/2	0.650	1.750	0.560	0.630	10	0.98	9,200	4,173

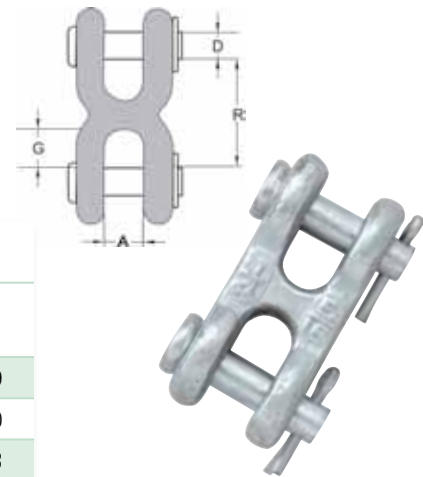

Weld-On Grab Hook

Stock #	Chain Size (Inches)	Qty. Per Pkg.	Working Load Limit	
			Lbs.	Kgs.
8023490	3/8	10	5,400	2,450



DO NOT EXCEED CAPACITY!
See the SAFETY GUIDELINES section before using these products. Pages 138-149.

Screw Pin Chain Shackles (RR-C-271F, Type IVB, Grade A, Class 2)

- Meets or exceeds FED SPEC RR-C-271 requirements.

Stock# UPC Tagged	Trade Size (Inches)	Pin Dia. (D)	Dimensions (Inches)				Qty. Per Pkg.	Lbs. Per Each	WLL (Ton)
			C	A	G (Max)	B (Min)			
8060005	3/16	1/4	0.375	0.750	0.625	0.180	25	0.05	1/3
8060105	1/4	5/16	0.469	0.875	0.875	0.240	25	0.11	1/2
8060205	5/16	3/8	0.531	1.031	1.000	0.300	25	0.18	3/4
8060305	3/8	7/16	0.656	1.125	1.250	0.360	25	0.30	1
8060505	1/2	5/8	0.812	1.625	1.375	0.480	10	0.59	2
8060605	5/8	3/4	1.062	2.000	1.875	0.590	10	1.27	3-1/4
8060705	3/4	7/8	1.250	2.375	2.125	0.710	10	2.60	4-3/4
8060805	7/8	1	1.438	2.812	2.375	0.830	5	3.15	6-1/2
8060905	1	1-1/8	1.688	3.188	2.625	0.950	5	4.75	8-1/2
8061005	1-1/8	1-1/4	1.812	3.562	2.875	1.070	5	6.75	9-1/2
8061105	1-1/4	1-3/8	2.031	3.938	3.250	1.190	5	9.00	12
8061205	1-3/8	1-1/2	2.250	4.438	3.500	1.310	1	15.00	13-1/2
8061305	1-1/2	1-5/8	2.375	4.875	3.750	1.420	1	22.00	17

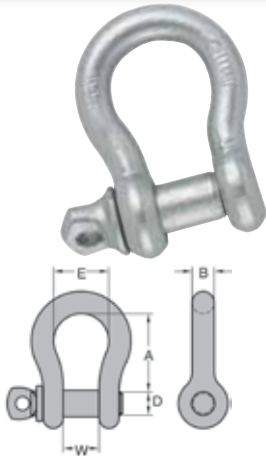
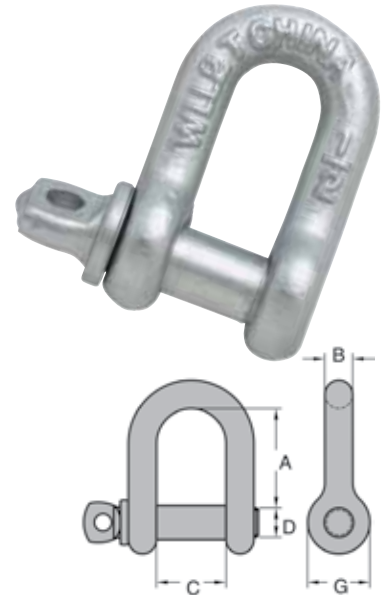

Commercial Grade Screw Pin Anchor Shackles

Stock#		Trade Size (Inches)	Pin Dia. (D)	Dimensions (Inches)				Qty. Per Pkg.	Lbs. Per Each	WLL (Ton)
UPC Tagged	UPC Tagged			W	A	E	B			
8065005	8065805	3/16	1/4	0.350	0.870	0.630	0.200	10	0.04	1/4
8065105	8065905	1/4	5/16	0.470	1.100	0.750	0.240	10	0.08	1/3
8065205	8066005	5/16	3/8	0.590	1.220	0.830	0.280	10	0.13	1/2
8065305	8066105	3/8	7/16	0.630	1.420	1.020	0.360	10	0.23	3/4
8065405	---	7/16	1/2	0.630	1.770	1.070	0.400	10	0.31	1
8065505	---	1/2	5/8	0.870	1.890	1.300	0.480	10	0.55	1-1/2
8065605	---	5/8	3/4	1.100	2.320	1.620	0.590	5	1.08	2-1/4
8065705	---	3/4	7/8	1.300	2.640	1.930	0.750	4	1.76	3-1/4

Repair Lap Links

Lap links are used to temporarily repair low carbon steel chains and add coupling attachments. To install the lap link, you must insert the link between the two other links or an attachment, and hammer the lap link to seal it shut. Low carbon steel. For temporary chain repair and coupling of attachments with chain. Use one size larger than chain size.

Stock #			Trade Size (Inches)	Dimensions (Inches)		Qty. Per Pkg.	Lbs. Per Each	Working Load Limit	
Bulk	*UPC Tagged			A	B			Lbs.	Kgs.
Self Color	Zinc								
8030125	8030135	4417640	3/16	1.000	0.505	100	0.03	225	100
8030225	8030235	4417740	1/4	1.250	0.512	50	0.07	325	140
8034225	8034235	---	1/4	2.000	0.680	50	0.10	325	140
8030325	8030335	4417840	5/16	1.510	0.730	50	0.15	675	300
8030425	8030435	4417940	3/8	1.625	0.785	50	0.23	1050	475
8034425	8034435	4417040	3/8	2.000	0.840	50	0.27	1000	450
8034625	---	8034630	1/2	2.500	1.010	50	0.59	1525	690

*All UPC Tagged products come 20/carton except 8034630, which comes 10/carton.



DO NOT EXCEED CAPACITY!
See the SAFETY GUIDELINES section before using these products. Pages 138-149.

CHAIN ACCESSORIES

Cold Shuts

Cold Shut Links are used to repair low carbon steel chains, as well as installing coupling attachments. After sliding the cold shut link between two other links, or an attachment, use a hammer to pound the end of the cold shut through the eye. To seal the link, you must peen the extended end of the cold shut, which prevents the link from opening. Low carbon steel. For temporary chain repair and coupling of attachments. When using chain, use one size larger than chain size.

Stock #		Trade Size (Inches)	Dimensions (Inches)		Qty. Per Pkg.	Lbs. Per Each	Working Load Limit	
Bulk	UPC Tagged		A	B			Lbs.	Kgs.
Self Colored	Zinc							
8040115	8040140	3/16	0.87	0.44	20	0.03	400	180
8040215	8040235	1/4	0.83	0.40	25	0.05	800	360
8040315	8040335	5/16	0.92	0.45	25	0.10	1,300	590
8040415	8040440	3/8	1.21	0.58	20	0.17	1,900	860
8040615	8040630	1/2	1.22	0.68	25	0.39	3,500	1,588



Connecting Links

Low carbon steel. For temporary chain repair and coupling of attachments with chain.

Stock #		Trade Size (Inches)	Dimensions (Inches)		Qty. Per Pkg.	Lbs. Per Each	Working Load Limit	
Bulk	UPC Tagged		A	B			Lbs.	Kgs.
Self Colored	HDG							
8050215	440840403	1/4	0.880	0.440	10	0.06	1,300	590
8050315	440840503	5/16	0.940	0.500	10	0.11	1,900	862
8050415	440840603	3/8	1.200	0.560	10	0.18	2,650	1,202
8050615	440840802	1/2	1.440	0.660	10	0.36	4,500	2,042



Quick Links

Quick links are the most popular and easiest to use when repairing a chain. They are usually used to repair low carbon steel chains or add coupling attachments. Quick links are two-sided thread links that you can easily slide onto two original links and tighten the thread with a wrench. They are designed to be reusable and moveable. Low carbon steel. Fast, easy connection for permanent or temporary connection.

Stock#		Trade Size (Inches)	Diameter		Dimensions (Inches)			Qty. Per Pkg.	Lbs. Per Each	Working Load Limit	
Bulk	UPC Tagged		Inches	MM	Inside Length	Inside Width	Opening			Lbs.	Kgs.
	Zinc										
8056035	4421040	1/8	0.125	3	1.200	0.410	0.180	20	0.02	220	100
8056135	4421140	3/16	0.197	5	1.560	0.500	0.270	20	0.05	616	279
8056235	4421240	1/4	0.240	6	1.900	0.630	0.310	20	0.08	880	400
8056335	4421340	5/16	0.310	8	2.300	0.750	0.370	20	0.18	1,540	699
8056435	4421440	3/8	0.350	9	2.560	0.780	0.440	10	0.24	1,900	862
8056635	4423640	1/2	0.470	12	3.270	0.890	0.540	10	0.53	2,650	1,202



Wide Jaw Quick Links

Stock#		Trade Size (Inches)	Diameter		Dimensions (Inches)		Qty. Per Pkg.	Lbs. Per Each	Working Load Limit	
UPC Tagged	Zinc		Inches	MM	Overall Length	Jaw Opening			Lbs.	Kgs.
4428040		1/8	0.125	3	1-13/16	3/8	20	0.02	220	100
4428140		3/16	0.197	5	2-7/16	1/2	20	0.05	615	279
4428240		1/4	0.240	6	2-3/4	9/16	20	0.08	880	400
4428340		5/16	0.310	8	3-7/16	11/16	10	0.18	1,540	699
4428440		3/8	0.350	9	3-3/4	3/4	10	0.24	1,980	898



DO NOT EXCEED CAPACITY!
See the SAFETY GUIDELINES section before using these products. Pages 138-149.

SHUTS, LINKS, CLIPS & S-HOOKS

Spring Links

Low carbon steel. Fast, easy connection for permanent or temporary connection.

Stock# UPC Tagged	Trade Size (Inches)	Diameter		Length (Inches)	Qty. Per Pkg.	Lbs. Per Each	Working Load Limit	
		Inches	MM				Lbs.	Kgs.
Zinc								
4412240	1/8	0.155	4	1.600	10	0.03	70	30
4412840	3/16	0.188	5	2.000	10	0.04	100	45
4410440	1/4	0.240	6	2.375	10	0.06	175	79
4410640	9/32	0.276	7	2.750	10	0.09	225	102
4410240	5/16	0.310	8	3.125	10	0.16	350	159
4426040	11/32	0.350	9	3.500	10	0.23	400	181
4425240	3/8	0.393	10	4.000	10	0.32	425	193
4426140	7/16	0.433	11	4.750	10	0.45	750	340
4427140	1/2	0.465	12	5.560	10	0.55	1,200	544



Hitch Pin Clips

Stock #		Trade Size	Wire Diameter (Inches)	Dimensions (Inches)			Qty. Per Pkg.	Lbs. Per Each
Bulk	UPC (Per Bag)			Gauge	Overall Length	Shaft Diameter		
Zinc								
3440335	3450335	3	0.091	11	1.630	1/4 to 1/2	50	0.01
3440635	3450635	6	0.177	5	3.380	5/8 to 1	14	0.05
3440735	3450735	7	0.091	11	2.310	1/4 to 5/8	50	0.10
3440835	3450835	8	0.177	5	3.750	7/8 to 1-1/4	20	0.60
3440935	3450935	9	0.148	7	2.450	3/4 to 1-1/8	20	0.33
3441135	---	11	0.125	8	2.620	7-16 to 3/4	36	0.18
3441935	3451935	19	0.243	3	4.060	1 to 1-1/2	12	0.12

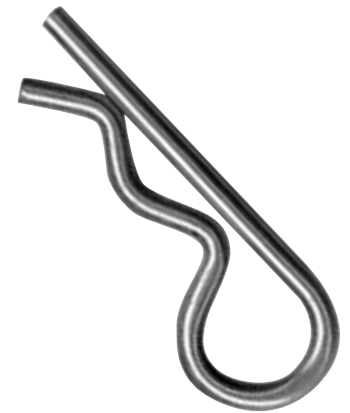

S-Hooks - Low Carbon Steel

Stock#		Hook No.	S-Hook Type	Diameter (Inches)		Qty. Per Pkg.	Lbs. Per Each	Working Load Limit	
Bulk	UPC Tagged			Wire Dia.	Inside Length			Lbs.	Kgs.
Zinc									
7902735	7992735	27	II	0.080	1.000	1,000	0.01	12	5
7906335	7996335	63	II	0.105	1.000	1,000	0.01	31	14
7900835	7990835	8	II	0.120	1.000	1,000	0.01	46	21
7904335	---	43	II	0.120	1.000	1,000	0.01	48	22
7900935	7990935	9	II	0.162	1.000	1,000	0.02	106	48
7949835	7999835	498	II	0.120	1.500	1,000	0.01	28	13
7901035	7991035	10	I	0.135	1.500	1,000	0.02	25	11
7900635	7990635	6	I	0.192	1.500	1,000	0.03	70	32
7911035	7991135	110	II	0.192	1.500	1,000	0.03	117	53
7900435	7990435	4	I	0.225	1.500	1,000	0.05	129	59
7901435	7991435	14	I	0.187	2.000	1,000	0.04	53	24
7953235	7993235	532	I	0.249	2.000	1,000	0.07	142	64
7952635	7992635	526	II	0.249	2.000	500	0.07	189	86
7962935	7992935	629	II	0.312	2.000	500	0.12	450	204
7953935*	3501760*	539	I	0.177	2.500	1,000	0.04	41	19
7901735	7991735	17	I	0.312	2.500	500	0.14	255	116
7901835	---	18	I	0.375	2.500	250	0.21	457	207
7906635	7996635	66	II	0.375	2.500	250	0.22	428	194

*Made from Galvanized Wire.

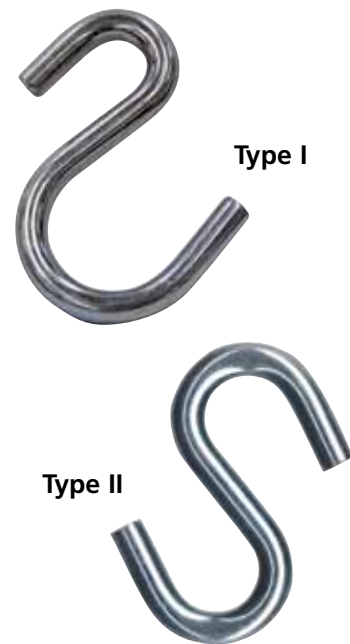

DO NOT EXCEED CAPACITY!
See the SAFETY GUIDELINES section before using these products. Pages 138-149.

CHAIN ACCESSORIES

Swivel Eye Single Pulley

Stock #	Trade Size (Inches)	Qty. Per Pkg.	Lbs. Per Package
Zinc			
4411840	3/4	40	0.07
4411540	1	40	0.13
4412740	1-1/4	10	0.29
4410840	1-1/2	10	0.35
4410740	2	10	0.55



Fixed Eye Single Pulley

Stock #	Trade Size (Inches)	Qty. Per Pkg.	Lbs. Per Package
Zinc			
4412040	3/4	40	0.08
4411640	1	40	0.11
4416740	1-1/4	10	0.25
4411140	1-1/2	10	0.26
4411240	2	10	0.53



Swivel Eye Double Pulley

Stock #	Trade Size	Qty. Per Pkg.	Lbs. Per Package
Zinc			
4412640	1	20	0.19



Fixed Eye Double Pulley

Stock #	Trade Size (Inches)	Qty. Per Pkg.	Lbs. Per Package
Zinc			
4434040	1-1/4	10	0.30

Screw Eyes



Stock #	Size (Inches)	Qty. Per Pkg.	Lbs. Per Each
4416140	3/4 x 3-1/8	20	0.10
4416240	1 x 3-1/2	20	0.14
4416340	5/8 x 3-7/8	20	0.10

2" Hitch Ring Screw

Stock #: 4416540
Weight: 0.28 Lbs./Ea.
Factory Package: 10/Ctn.
Order Unit: Each



2" Hitching Ring & Plate

Stock #: 4416640
Weight: 0.24 Lbs./Ea.
Factory Package: 10/Ctn.
Order Unit: Each



Rope Accessories

4-1/2" Rope Cleat

Stock #: 4412540
Weight: 3.45 Lbs./Ea.
Factory Package: 10/Ctn.
Order Unit: Each



3-1/2" Rope Binding Hook

Stock #: 4416040
Weight: 0.17 Lbs./Ea.
Factory Package: 20/Ctn.
Order Unit: Each



3/8 or 1/2" Rope Clamp

Stock #: 4415640
Weight: 0.05 Lbs./Ea.
Factory Package: 20/Ctn.
Order Unit: Each



1/4" Screw Hook

Stock #: 4415940
Weight: 0.13 Lbs./Ea.
Factory Package: 20/Ctn.
Order Unit: Each



2-5/16" Flange Eye

Stock #: 4416440
Weight: 0.09 Lbs./Ea.
Factory Package: 20/Ctn.
Order Unit: Each



1-1/2" Harness Ring

Stock #: 4435940
Weight: 0.07 Lbs./Ea.
Factory Package: 20/Ctn.
Order Unit: Each



DO NOT EXCEED CAPACITY!
See the SAFETY GUIDELINES section before using these products. Pages 138-149.

Snaps

Snaps - Brass Finish

Stock #	Dimensions (Inches)		Type*	Qty. Per Pkg.	Lbs. Per Each
	Eye Dia.	Overall Lgth.			
4433440	9/16	3-1/4	Swivel Eye Quick Snap (B)	20	0.15
4415340	3/4	3-5/8	Swivel Eye Quick Snap (B)	20	0.17
4415140	1-1/8	2-3/4	Swivel Eye Trigger Snap (F)	20	0.12
4433240	3/4	3-1/8	Swivel Eye Bolt Snap (J)	20	0.15
4415240	1	3-1/2	Swivel Eye Bolt Snap (J)	10	0.17
4414840	1-1/8	4-5/8	Swivel Eye Bolt Snap (J)	10	0.34
4424840	3/8	3-1/2	Double End Bolt Snap (P)	20	0.14
4426740	1/2	3	Swivel Strap Eye Bolt Snap (A)	20	0.09
4424740	5/8	3-7/16	Fixed Eye Quick Snap (I)	20	0.15
4433340	11/16	4-3/8	Swivel Eye Boat Snap (B)	20	0.32
4434340	3/4	4-1/4	Snap Hook (O)	10	0.35

*See page 108.

Snaps - Zinc Finish

Stock #	Dimensions (Inches)		Type*	Qty. Per Pkg.	Lbs. Per Each
	Eye Dia.	Overall Lgth.			
4426540	3/8	2-15/16	Swivel Eye Bolt Snap (J)	20	0.09
4426640	5/8	4-1/4	Swivel Eye Bolt Snap (J)	20	0.14
4414240	3/8	3-1/8	Open End Swivel Snap (G)	20	0.07

*See page 108.

Snaps - Multi-Colored Finish

Stock #	Dimensions (Inches)		Type*	Qty. Per Pkg.	Lbs. Per Each
	Eye Dia.	Overall Lgth.			
4427040	-	3	Anodized Spring Link (Q)	25	0.05
4428640	--	3	Camo Spring Link-Gear Clip (Q)	25	0.05

*See page 108.



DO NOT EXCEED CAPACITY!
See the SAFETY GUIDELINES section before using these products. Pages 138-149.

CHAIN ACCESSORIES

Snaps - Nickel Finish

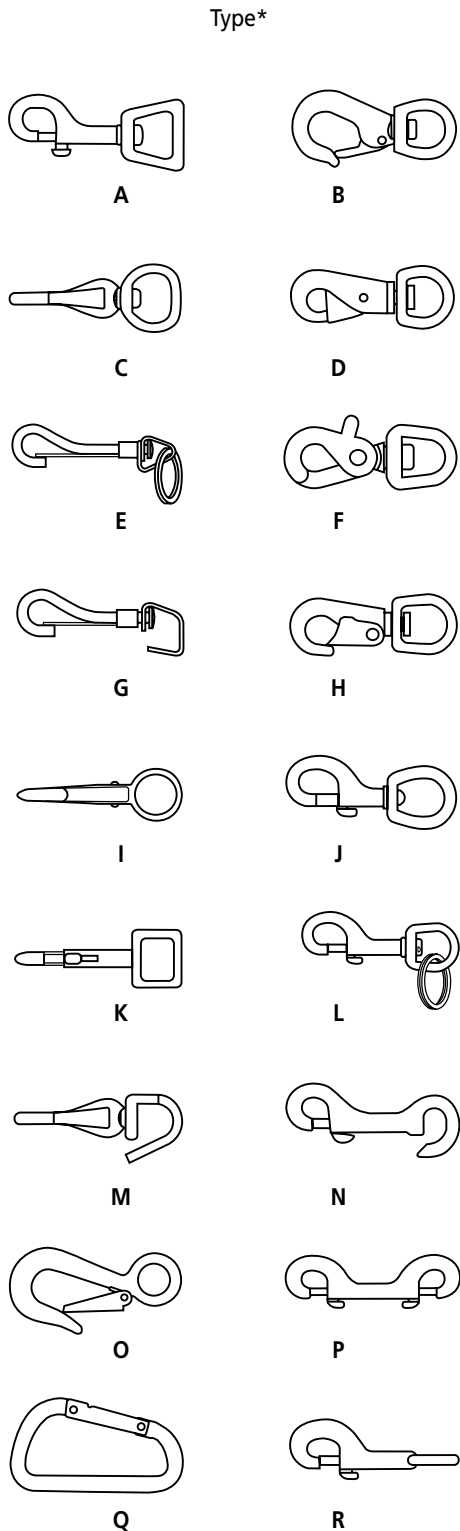

Stock #	Dimensions (Inches)		Type*	Qty. Per Pkg.	Lbs. Per Each	
	UPC Tagged Nickel	Eye Dia.				Overall Lgth.
4414440		3/4	3-1/4	Swivel Eye Quick Snap (B)	40	0.14
4410340		7/8	4	Swivel Eye Bull Snap (D)	20	0.34
4414340		3/4	2-9/16	Swivel Eye Trigger Snap (F)	40	0.1
4410540		3/4	3-7/8	Swivel Eye Trigger Snap (F)	20	0.21
4424540		3/4	3-3/8	Swivel Eye Cap Snap (H)	30	0.17
4410940		1	3-5/8	Swivel Eye Cap Snap (H)	30	0.14
4410040		3/4	3-3/16	Swivel Eye Bolt Snap (J)	40	0.08
4414040		7/8	3-3/16	Swivel Eye Bolt Snap (J)	20	0.11
4413540		1	4	Swivel Eye Bolt Snap (J)	20	0.21
4415440		1	3-3/4	Key Ring Swivel Eye Bolt Snap (L)	30	0.12
4414140		1/2	3-1/2	Open End Bolt Snap (N)	20	0.12
4418040		1/4	3-1/2	Double End Bolt Snap (P)	20	0.10
4410140		5/8	4-5/8	Double End Bolt Snap (P)	20	0.16
4414640		5/8	3-5/16	Fixed Eye Bolt Snap (R)	30	0.13
4425340		1	3-1/4	Fixed Strap Eye Bolt Snap (K)	20	0.14
4415540		7/8	4-1/2	Key Ring Swivel Spring Snap (E)	20	0.12
4417340		1/4	2-7/8	Open End Swivel Snap (G)	20	0.06
4412340		3/8	2-1/2	Open End Spring Snap (M)	60	0.04
4414540		3/4	3-1/2	Fixed Eye Safety Snap (O)	20	0.26
4431240		3/8	4	Double End Bolt Snap (P)	20	0.12
4431540		1-1/8	4-3/8	Mall Swivel Snap (H)	20	0.20
4432440		3/8	1-3/4	Swivel Simplex Snap (S)	40	0.02
4432840		1/4	2	Swivel Spring Snap (T)	40	0.03
4432940		3/8	2-1/2	Swivel Spring Snap (T)	40	0.04
4433040		1/2	2-1/2	Swivel Trigger Snap (F)	20	0.08
4434140		3/8	3-1/4	Mall Open Snap (N)	20	0.09
4434240		1-1/8	4-5/16	Swivel Eye Panic Snap (U)	10	0.40
4437140		1	3-1/4	Swivel Bolt Snap (A)	10	0.11

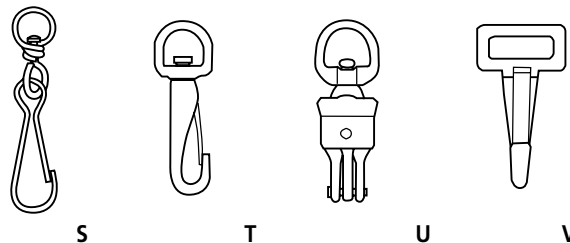

DO NOT EXCEED CAPACITY!
See the SAFETY GUIDELINES section before using these products. Pages 138-149.

Stainless Steel Chain Accessories

NOT FOR OVERHEAD LIFTING

A316 Stainless Steel Screw Pin Anchor Shackle

Stock # UPC Tagged	Trade Size	Dimensions (Inches)					Qty. Per Pkg.	Lbs. Per Each	Working Load Limit	
		D	W	E	L	T			Lbs.	Kgs.
Stainless	In									
H8624-0340	3/16	0.250	0.374	0.591	0.866	0.551	5	0.04	400	181
H8624-0440	1/4	0.313	0.472	0.787	1.102	0.610	5	0.07	750	340
H8624-0540	5/16	0.375	0.512	0.827	1.220	0.748	5	0.15	1,060	481
H8624-0640	3/8	0.438	0.630	1.024	1.417	0.906	5	0.29	1,600	726
H8624-0840	1/2	0.625	0.827	1.299	1.890	1.181	5	0.50	2,800	1,270
H8624-0940	5/8	0.750	1.063	1.693	2.362	1.496	5	1.09	4,900	2,200
H8624-1040	3/4	0.875	1.260	2.008	2.795	1.811	5	2.18	6,500	3,000
H8624-1140	7/8	1.000	1.417	2.283	3.307	2.087	5	2.87	7,300	3,300
H8624-1240	1	1.125	1.693	2.677	3.740	2.362	5	3.97	8,400	4,000

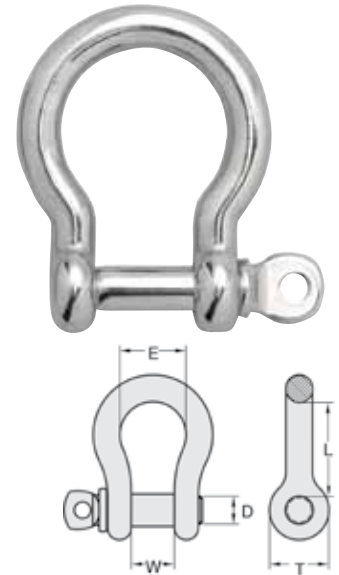

A316 Stainless Steel Screw Pin Chain Shackle

Stock # UPC Tagged	Trade Size	Dimensions (Inches)				Qty. Per Pkg.	Lbs. Per Each	Working Load Limit	
		D	W	L	T			Lbs.	Kgs.
Stainless	In								
H8924-0340	3/16	0.200	0.430	0.280	0.400	5	0.04	400	181
H8924-0440	1/4	0.240	0.470	0.320	0.430	5	0.07	750	340
H8924-0540	5/16	0.280	0.670	0.390	0.630	5	0.16	1,060	481
H8924-0640	3/8	0.350	0.830	0.510	0.790	5	0.27	1,600	726
H8924-0840	1/2	0.430	0.980	0.830	0.910	5	0.44	2,800	1,270

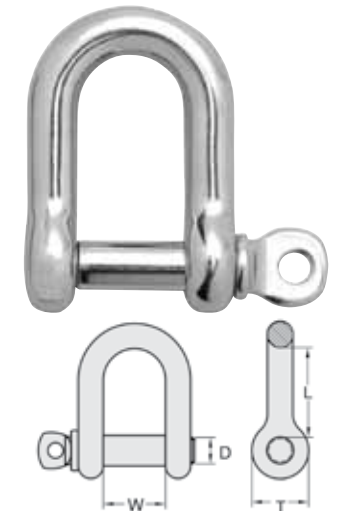

A316 Stainless Steel Quick Link

Stock # UPC Tagged	Trade Size	Dia.		Dimensions (Inches)			Qty. Per Pkg.	Lbs. Per Each	WLL	
		In.	MM	Inside Length	Inside Width	Opening			Lbs.	Kgs.
Stainless	(In.)									
H8224-0240	1/8	0.125	3	1.300	0.390	0.200	5	0.04	220	100
H8224-0340	3/16	0.197	5	1.500	0.550	0.240	5	0.04	660	299
H8224-0440	1/4	0.240	6	1.780	0.550	0.280	5	0.07	880	399
H8224-0540	5/16	0.310	8	2.290	0.710	0.390	5	0.15	1,760	798
H8224-0640	3/8	0.390	10	2.710	0.870	0.470	5	0.259	2,200	990
H8224-0840	1/2	0.470	12	3.150	0.980	0.590	5	0.50	2,600	1,170



A316 Stainless Steel Spring Link

Stock # UPC Tagged	Trade Size	Diameter		Overall Length	Qty. Per Pkg.	Lbs. Per Each	WLL	
		Inches	MM				Inches	Kgs.
Stainless	Inches							
H8724-0340	3/16	0.200	5.5	1.970	5	0.04	100	45
H8724-0440	1/4	0.240	6	2.360	5	0.07	140	64
H8724-0540	5/16	0.320	8	3.150	5	0.15	250	113
H8724-0640	3/8	0.400	10	3.940	5	0.29	400	181
H8724-0840	1/2	0.470	12	5.510	5	0.50	600	272

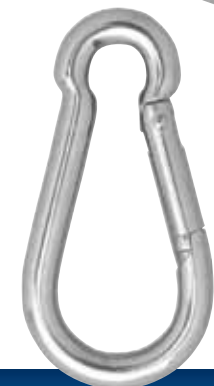

DO NOT EXCEED CAPACITY!
See the SAFETY GUIDELINES section before using these products. Pages 138-149.

MISC. HARDWARE

- Chain & Fitting Displays 111-114
- Solid Braided Nylon Rope 115
- Manila Rope 115
- Poly Truck Rope 115
- Twisted Nylon Rope 115
- Twisted Poly Rope 115
- Galvanized Wire Rope 116-117
- Wire Rope Accessories 118-121
- Anti-Theft Chain & Padlocks 122

WIRE ROPE

FINISH	SIZES AVAILABLE	WORKING LOAD LIMIT
Galvanized	1/16" 7 x 7	96
Vinyl Coated	1/16" - 9/64" 1 x 7	100
Vinyl Coated	1/16" - 1/8" 7 x 7	96
Galvanized	3/32" 7 x 7	184
Vinyl Coated	3/32" - 3/16" 7 x 7	184
Galvanized	1/8" 7 x 19	184
Stainless Steel	1/8" 7 x 19	400
Vinyl Coated	1/8" - 3/16" 7 x 7	352
Galvanized	3/16" - 1/4" 7 x 19	340
Galvanized	3/16" 7 x 7	840
Stainless Steel	3/16" 7 x 19	740
Galvanized	3/16" 7 x 19	840
Galvanized	1/4" 7 x 19	840
Galvanized	5/16" 7 x 19	1400
Fiber Core	3/8" 7 x 19	2000
	1/2" 6 x 19	4280

APPLICATIONS • Clothesline • Dog Runs • Winches • Garage Doors • Guy Wires

ACCESSORIES • Wire Rope Clips • Thimbles • Ferrules & Stops • Turnbuckles

WARNING: DO NOT USE FOR OVERHEAD LIFTING
MATCH THE WORKING LOAD LIMIT TO THE JOB.
DO NOT EXCEED THE WORKING LOAD LIMIT OF THE LOWEST RATED COMPONENT.



Binder Chain & Load Binder Display

Item	Consisting of Stock #	Description	Pkg Qty.	Initial Order Qty.	Display Rack Qty.
DISPLAY #1 - Domestic Binder Chains, QuikBinders, Standard Style Ratchet & Lever Load binders. DISPLAY STOCK #4120085 <small>*Short-Link, **NACM Link</small>	5261363	5/16" x 20' G70 Binder Chain Assembly*	25	25	25
	5262363	3/8" x 20' G70 Binder Chain Assembly**	25	25	25
	H5125-0658	5/16" or 3/8" G70 or G80 QuikBinder	4	4	4
	H5123-4152	5/16" G70 or 3/8" G43 Ratchet Load Binder	2	4	4
	H5123-4252	3/8" G70 or 1/2" G43 Ratchet Load Binder	2	4	4
	H5023-4152	5/16" G70 or 3/8" G43 Lever Load Binder	6	6	6
	4120090	Binder Chain & Load Binder Rack	1	1	1
DISPLAY #2 - Domestic Binder Chains, QuikBinders, Ratchet Binder Plus & Prolok 66. DISPLAY STOCK #4120086 <small>*Short-Link, **NACM Link</small>	5261363	5/16" x 20' G70 Binder Chain Assembly*	25	25	25
	5262363	3/8" x 20' G70 Binder Chain Assembly**	25	25	25
	H5125-0658	5/16" or 3/8" G70 or G80 QuikBinder	4	4	4
	H5121-4158	5/16" or 3/8" G70 or G80 Ratchet Binder Plus	2	6	6
	H5025-0652	5/16" or 3/8" G70 ProLok66 Lever Load Binder	4	4	4
	4120090	Binder Chain & Load Binder Rack	1	1	1
DISPLAY #3 - Import Binder Chains, QuikBinders, Standard Style Ratchet & Lever Load binders. DISPLAY STOCK #4120087 <small>*Short-Link</small>	H3226-5220	5/16" x 20' G70 Binder Chain Assembly*	25	25	25
	H3226-5620	3/8" x 20' G70 Binder Chain Assembly*	20	20	20
	H5125-0658	5/16" or 3/8" G70 or G80 QuikBinder	4	4	4
	H5123-4152	5/16" G70 or 3/8" G43 Ratchet Load Binder	2	4	4
	H5123-4252	3/8" G70 or 1/2" G43 Ratchet Load Binder	2	4	4
	H5023-4152	5/16" G70 or 3/8" G43 Lever Load Binder	6	6	6
	4120090	Binder Chain & Load Binder Rack	1	1	1
DISPLAY #4 - Import Binder Chains, QuikBinders, Ratchet Binder Plus & Prolok 66. DISPLAY STOCK #4120088 <small>*Short-Link</small>	H3226-5220	5/16" x 20' G70 Binder Chain Assembly*	25	25	25
	H3226-5620	3/8" x 20' G70 Binder Chain Assembly*	20	20	20
	H5125-0658	5/16" or 3/8" G70 or G80 QuikBinder	4	4	4
	H5121-4158	5/16" or 3/8" G70 or G80 Ratchet Binder Plus Load Binder	2	6	6
	H5025-0652	5/16" or 3/8" G70 ProLok66 Lever Load Binder	4	4	4
	4120090	Binder Chain & Load Binder Rack	1	1	1
DISPLAY #5 - Import Binder Chains, QuikBinders, Standard Style Ratchet & Lever Load binders. DISPLAY STOCK #4120089 <small>**NACM Link</small>	H3275-5220	5/16" x 20' G70 Binder Chain Assembly**	25	25	25
	H3275-5620	3/8" x 20' G70 Binder Chain Assembly**	20	20	20
	H5125-0658	5/16" or 3/8" G70 or G80 QuikBinder	4	4	4
	H5123-4152	5/16" G70 or 3/8" G43 Ratchet Load Binder	2	4	4
	H5123-4252	3/8" G70 or 1/2" G43 Ratchet Load Binder	2	4	4
	H5023-4152	5/16" G70 or 3/8" G43 Lever Load Binder	6	6	6
	4120090	Binder Chain & Load Binder Rack	1	1	1



DO NOT EXCEED CAPACITY!
See the SAFETY GUIDELINES section before using these products. Pages 138-149.

H9800-0400 - Chain & Fittings Assortment

Free standing display rack & welded chain assortment with 6 pails and 18 different chain accessories.



Rack measures:
29" Wide,
68" High,
24" Deep.

Item	UPC Stock #	Trade Size	Description	Finish	Assorted Qty.	Assorted Wt./Lbs.
1	H0110-0311	3/16" x 250'	Proof Coil Pail	BZ	1	88.00
2	H0110-0411	1/4" x 141'	Proof Coil Pail	BZ	1	80.51
3	H0110-0511	5/16" x 92'	Proof Coil Pail	BZ	1	76.36
4	H0110-0611	3/8" x 63'	Proof Coil Pail	BZ	1	88.00
5	H0810-2111	2/0 x 350'	Straight Link Coil Pail	BZ	1	101.15
6	H0910-2111	2/0 x 300'	Passing Link Pail	BZ	1	102.00
7	8013230	1/4"	Clevis Slip Hooks	BZ	10	4.85
8	8013330	5/16"	Clevis Slip Hooks	BZ	10	6.90
9	8013430	3/8"	Clevis Slip Hooks	BZ	10	11.20
10	8023230	1/4"	Clevis Grab Hooks	BZ	10	4.60
11	8023330	5/16"	Clevis Grab Hooks	BZ	10	7.85
12	8023430	3/8"	Clevis Grab Hooks	BZ	10	11.80
13	4417640	3/16"	Repair Lap Links	BZ	60	3.36
14	4417740	1/4"	Repair Lap Links	BZ	60	3.72
15	4417840	5/16"	Repair Lap Links	BZ	60	11.16
16	4417940	3/8"	Repair Lap Links	BZ	60	16.86
17	4421240	1/4"	Quick Links	BZ	40	3.92
18	4421340	5/16"	Quick Links	BZ	40	7.68
19	4421440	3/8"	Quick Links	BZ	20	5.08
20	8027235	1/4" - 5/16"	Double Clevis	BZ	20	6.00
21	4412840	3/16"	Spring Links	BZ	60	2.10
22	4410440	1/4"	Spring Links	BZ	60	3.54
23	4410240	5/16"	Spring Links	BZ	20	3.24
24	4425240	3/8"	Spring Links	BZ	20	6.36
25	4000244	---	Hydraulic Chain Cutter	---	1	36.00
---	H9850-0500	---	Display Rack with 18 Bins	---	1	57.00
---	H9850-9999	---	Laminated Chain Chart & Bin Tags	---	1	0.50
---	H9800-0400	---	Complete Rack & Assortment Listed above	---	---	765.74



DO NOT EXCEED CAPACITY!
See the SAFETY GUIDELINES section before using these products. Pages 138-149.

H9800-0450 - Hardware Chain & Fittings Assortment

Pail stackers & welded chain assortment with 6 pails of welded chain. Also includes 19 different chain accessories and bins. (Gondola not included)

Item	UPC Stock #	Trade Size	Description	Finish	Assorted Qty.	Assorted Wt./Lbs.
1	H0110-0311	3/16" x 250'	Proof Coil Pail	BZ	1	104.00
2	H0110-0411	1/4" x 141'	Proof Coil Pail	BZ	1	80.51
3	H0110-0511	5/16" x 92'	Proof Coil Pail	BZ	1	76.36
4	H0110-0611	3/8" x 63'	Proof Coil Pail	BZ	1	88.00
5	H0810-2111	2/0 x 350'	Straight Link Coil Pail	BZ	1	101.15
6	H0910-2111	2/0 x 300'	Passing Link Pail	BZ	1	102.00
7	8013230	1/4"	Clevis Slip Hooks	BZ	20	9.70
8	8013330	5/16"	Clevis Slip Hooks	BZ	20	13.80
9	8013430	3/8"	Clevis Slip Hooks	BZ	10	11.20
10	8023230	1/4"	Clevis Grab Hooks	BZ	20	9.20
11	8023330	5/16"	Clevis Grab Hooks	BZ	20	15.00
12	8023430	3/8"	Clevis Grab Hooks	BZ	20	23.60
13	4417640	3/16"	Repair Lap Links	BZ	60	3.36
14	4417740	1/4"	Repair Lap Links	BZ	60	3.72
15	4417840	5/16"	Repair Lap Links	BZ	60	11.16
16	4417940	3/8"	Repair Lap Links	BZ	60	16.86
17	4421140	3/16"	Quick Links	BZ	60	2.76
18	4421240	1/4"	Quick Links	BZ	40	3.92
19	4421340	5/16"	Quick Links	BZ	40	7.68
20	4421440	3/8"	Quick Links	BZ	20	5.08
21	8027235	1/4" - 5/16"	Double Clevis	BZ	20	6.00
22	4412840	3/16"	Spring Links	BZ	60	2.10
23	4410440	1/4"	Spring Links	BZ	60	3.54
24	4410240	5/16"	Spring Links	BZ	20	3.24
25	4425240	3/8"	Spring Links	BZ	20	6.36
26	4000244	---	Hydraulic Style Welded Chain Cutter	---	1	36.00
27	H9830-0224	---	Small, Long Plastic Bins	---	11	5.39
28	H9830-0230	---	Large Plastic Bins	---	8	4.80
29	H9850-0128	---	E-Z Load Stackers (pair)	---	3	42.00
30	H9850-0130	---	Hydraulic Cutter Mounting Kit for Pail Stackers	---	1	1.25
31	H9850-0915	---	48" Retail Display Sign w/Mounting Hardware	---	1	1.50
---	H9850-9999	---	Laminated Chain Chart & Bin Tags	---	1	0.50
---	H9800-0450	---	Complete Rack & Assortment Listed Above	---	---	801.74



Rack measures:
48" Wide,
60" High,
16" Deep.



DO NOT EXCEED CAPACITY!
See the SAFETY GUIDELINES section before using these products. Pages 138-149.

H9800-0460 - Heavy Duty Chain & Fittings Assortment

Pail stackers & welded chain assortment with 6 pails of welded chain. Also includes 19 different chain accessories and bins. (Gondola not included)



Rack measures:
48" Wide,
60" High,
16" Deep.

Item	Stock #	Trade Size	Description	Finish	Assorted Qty.	Assorted Wt./Lbs.
1	H0310-0420	1/4" x 150'	1/4" G70 Transport Chain	YZ	1	109.95
2	H0310-0520	5/16" x 100'	5/16" G70 Transport Chain	YZ	1	118.00
3	H0310-0620	3/8" x 75'	3/8" G70 Transport Chain	YZ	1	114.98
4	H0210-0405	1/4" x 150'	1/4" G43 High Test Chain	SC	1	106.05
5	H0210-0505	5/16" x 100'	5/16" G43 High Test Chain	SC	1	114.00
6	H0210-0605	3/8" x 75'	3/8" G43 High Test Chain	SC	1	107.03
7	8015266	1/4"	G70 Clevis Slip Hooks w/Latch	YC	10	5.40
8	8015366	5/16"	G70 Clevis Slip Hooks w/Latch	YC	10	8.66
9	8015466	3/8"	G70 Clevis Slip Hooks w/Latch	YC	10	13.00
10	8022230	1/4"	G70 Clevis Grab Hooks	YC	10	4.00
11	8022330	5/16"	G70 Clevis Grab Hooks	YC	10	7.36
12	8022430	3/8"	G70 Clevis Grab Hooks	YC	10	11.65
13	8016266	1/4"	G43 Clevis Slip Hooks w/Latch	ZP	10	6.40
14	8016366	5/16"	G43 Clevis Slip Hooks w/Latch	ZP	10	9.95
15	8016466	3/8"	G43 Clevis Slip Hooks w/Latch	ZP	10	14.10
16	8023230	1/4"	G43 Clevis Grab Hooks	ZP	10	4.60
17	8023330	5/16"	G43 Clevis Grab Hooks	ZP	10	7.85
18	8023430	3/8"	G43 Clevis Grab Hooks	ZP	10	11.80
19	8057230	1/4" - 5/16"	1/4" - 5/16" G70 Double Clevis	YC	10	3.50
20	8057430	3/8"	3/8" G70 Double Clevis	YC	10	5.95
21	8027235	1/4" - 5/16"	1/4" - 5/16" G43 Double Clevis	ZP	10	3.00
22	8027435	3/8"	3/8" G43 Double Clevis	ZP	10	4.00
23	8058303	5/16"	5/16" Alloy Screw Pin Anchor Shackle	HDG	5	0.95
24	8058403	3/8"	3/8" Alloy Screw Pin Anchor Shackle	HDG	5	1.55
25	8058503	1/2"	1/2" Alloy Screw Pin Anchor Shackle	HDG	5	3.65
26	4000288	--	Hydraulic Cutter 3/8" G70	--	1	46.00
27	H9850-0130	--	Hyd Cutter Mounting Kit for Stackers	--	1	1.25
28	H9850-0128	--	E-Z Load Pail Stackers (Pair)	--	3	5.39
29	H9830-0224	--	Red Plastic Bin; Long-Small	--	11	5.88
30	H9830-0230	--	Red Plastic Bin; Large	--	8	4.80
31	H9850-0915	--	48" "CHAIN CENTER" Sign	--	1	1.50
32	H9850-9999	--	Laminated Chain Chart & Bin Tags	--	1	0.50
33	H9800-0460		Complete rack & assortment listed above	--	--	898.82



DO NOT EXCEED CAPACITY!
See the SAFETY GUIDELINES section before using these products. Pages 138-149.

Solid Braided Nylon Rope - Reels

Stock #	Diameter (Inches)	Ft. Per Package	Lbs. Per Package	Working Load Limit	
				Lbs.	Kgs.
White					
2804893	1/4	800	11	160	72
2805332	5/16	600	15	280	127
2804894	3/8	330	11	330	149
2804895	1/2	165	11	400	181
2804892	3/16	1000	9	82	37



Manila Rope - Reels

Stock #	Diameter (Inches)	Ft. Per Package	Lbs. Per Package	Working Load Limit	
				Lbs.	Kgs.
Natural					
2880025	3/8	600	25	122	55
2880030	1/2	600	56	240	109
2880035	5/8	600	80	400	181
2880040	3/4	600	95	490	222

Poly Truck Rope - Reels

Stock #	Diameter (Inches)	Ft. Per Package	Lbs. Per Package	Working Load Limit	
				Lbs.	Kgs.
Natural					
2871290	3/8	600	20	270	122
2871295	1/2	300	15	420	190



Twisted Nylon Rope - Reels

Stock #	Diameter (Inches)	Ft. Per Package	Lbs. Per Package	Working Load Limit	
				Lbs.	Kgs.
White					
2804896	1/4	600	9	165	75
2804897	3/8	300	9	370	168
2805378	5/8	120	12	1,000	454

Twisted Poly Rope - Reels

Stock #	Diameter (Inches)	Ft. Per Package	Lbs. Per Package	Working Load Limit	
				Lbs.	Kgs.
Yellow					
2804902	1/4	600	8	125	57
2804903	3/8	300	10	270	122
2804904	1/2	150	7	420	191



DO NOT EXCEED CAPACITY!
See the SAFETY GUIDELINES section before using these products. Pages 138-149.

MISCELLANEOUS HARDWARE

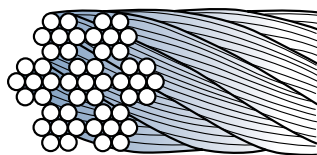

7 x 7 Construction

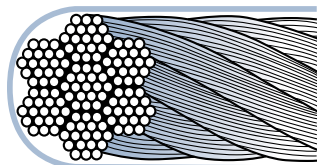

7 x 19 Construction
(Available with vinyl coating)

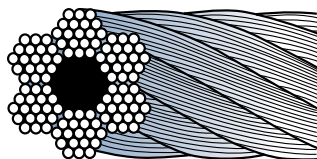

6 x 19 Construction
(Fiber Core)

Three Common wire ropes for consumer applications.

7 x 7 construction with seven strands of seven wires, uses heavier gauge wire which offers better abrasion resistance than 7 x 19, but it is not as strong and less flexible.

7 x 19 construction is the most practical. With its seven strands of nineteen wires each, it is stronger than the other two types, has excellent flexibility and good abrasion resistance.

6 x 19 fiber core wire rope is the most economical where large diameters are required and it offers very good abrasion resistance. It is less flexible and not as strong as the other types. Often used for longer, straight runs.

Galvanized Wire Rope

▪ Small Reels

Stock #	Diameter (Inches)	Construction	Ft. Per Pkg.	Lbs. Per Pkg.	Working Load Limit	
					Lbs.	Kgs.
4501090	1/16	7 x 7	500	5	96	43
4500905	3/32	7 x 7	250	5	184	83
4500990	3/32	7 x 7	500	10	184	83
4501104	1/8	7 x 7	250	8	340	154
4501190	1/8	7 x 7	500	15	340	154
4442565	1/8	7 x 7	30	1	340	154
4501185*	1/8	7 x 7	250	2	352	160
4503285*	3/16	7 x 7	250	15	840	381
4503215	3/16	7 x 7	500	30	740	335
4503308	1/4	7 x 7	250	28	1,220	553
4501110	1/8	7 x 19	250	8	400	181
4501115	1/8	7 x 19	500	15	400	181
4520111	3/16	7 x 19	50	3.5	840	381
4503290	3/16	7 x 19	250	18	840	381
4503210	3/16	7 x 19	500	35	840	381
4520211	1/4	7 x 19	50	5.5	1400	635
4503317	1/4	7 x 19	250	28	1,400	635
4503320	1/4	7 x 19	500	55	1,400	635
4520411	5/16	7 x 19	50	8.5	1960	889
4503405	5/16	7 x 19	500	85	2,000	907
4503501	3/8	7 x 19	250	60	2,880	1,306
4503505	3/8	7 x 19	500	120	2,880	1,306

*Stainless Steel



Galvanized Wire Rope

▪ Large Spools

Stock #	Diameter (Inches)	Construction	Ft. Per Pkg.	Lbs. Per Pkg.	Working Load Limit	
					Lbs.	Kgs.
H4008-0011	1/16	7 x 7	1,000	16	96	43
H4008-0111	3/32	7 x 7	1,000	19	184	83
H4008-0211	1/8	7 x 7	1,000	29	340	154
H3808-0211	1/8	7 x 19	1,000	32	400	181
H3808-0311	3/16	7 x 19	1,000	70	840	381
H3808-0411	1/4	7 x 19	1,000	119	1,400	635
H3808-0511	5/16	7 x 19	1,000	184	2,000	907
H3808-0611	3/8	7 x 19	1,000	243	2,880	1,306



DO NOT EXCEED CAPACITY!
See the SAFETY GUIDELINES section before using these products. Pages 138-149.



IWRC* & Fiber Core Wire Rope - Small Reels

Stock #	Diameter (Inches)	Construction	Core Type	Ft. Per Package	Lbs. Per Package	Working Load Limit	
						Lbs.	Kgs.
4503315	1/4	6 x 19	Fiber	500	55	1,096	497
4500105	5/16	6 x 19	Fiber	500	80	1,704	773
4500205	3/8	6 x 19	Fiber	500	120	2,400	1089
4500305	1/2	6 x 19	Fiber	250	105	4,280	1,941
4500350	1/2	6 x 19	IWRC*	250	115	4,600	2,087

*Independent Wire Rope Core

4501008



Vinyl Coated Wire Rope - Small Reels

Stock #	Diameter (Inches)	Diameter w/Coating (Inches)	Construction	Ft. Per Pkg.	Lbs. Per Pkg.	Working Load Limit	
						Lbs.	Kgs.
4501008*	1/16	1/8	1 x 7	250	5	96	43
4501091	1/16	1/8	7 x 7	500	7	96	43
4501290	3/32	3/16	7 x 7	250	8	184	83
4442665	3/32	3/16	7 x 7	30	1	184	83
4500805	1/8	3/16	7 x 7	250	10	340	154
4501390	3/16	1/4	7 x 19	100	9	840	381
4501308	3/16	1/4	7 x 19	250	21	840	381
4500705	1/4	5/16	7 x 19	200	25	1,400	635

* Green



DO NOT EXCEED CAPACITY!
See the SAFETY GUIDELINES section before using these products. Pages 138-149.

MISCELLANEOUS HARDWARE

Turnbuckles

Stock #	UPC Tagged	Trade Size (Inches)	Take-Up (Inches)	Type	Qty. Per Pkg.	Lbs. Per Pkg.	Working Load Limit	
							Lbs.	Kgs.
4530220		3/8	6	Hook & Eye	10	10	1,000	454
4530345		1/2	9	Hook & Eye	10	21	1,500	680
4530010		1/4	4	Eye & Eye	10	4	400	181
4530210		3/8	6	Eye & Eye	10	8	1,200	544
4530335		1/2	9	Eye & Eye	10	21	2,200	998
4530360		1/2	12	Eye & Eye	10	25	2,200	998



Malleable Wire Rope Clips - Commercial Grade

Stock #	UPC Tagged	Trade Size (Inches)	Min. No. Clips Req.	Wire Rope Turn Back (Inches)	Tightening Torque (Ft./Lbs.)	Qty. Per Pkg.	Lbs. Per Pkg.
4503140		1/8	3	4.75	3	50	1.90
4503340		3/16	3	5.50	4.5	50	3.25
4503440		1/4	3	7.00	15	10	1.23
4503540		5/16	3	7.75	15	10	1.35
4503640		3/8	3	9.50	30	10	2.30
4503840		1/2	4	15.25	45	10	3.48
4503940		5/8	4	16.00	75	10	5.19
4504040		3/4	5	22.25	75	10	8.57

Forged Wire Rope Clips

FED SPEC # FF-C-450D T1, C1 (Type1, Class 1)

Stock #	Trade Size (Inches)	Min. No. Clips Req.	Wire Rope Turn Back (Inches)	Tightening Torque (Ft./Lbs.)	Qty. Per Pkg.	Lbs. Per Pkg.
H4345-0215	1/8	2	3.25	4.5	100	6
H4345-0315	3/16	2	3.75	7.5	100	10
H4345-0415	1/4	2	4.75	15	100	20
H4345-0515	5/16	2	5.25	30	100	30
H4345-0615	3/8	2	6.50	45	100	47
H4345-0715	7/16	3	7.00	65	50	38
H4345-0815	1/2	3	11.50	65	50	40
H4345-0915	5/8	3	12.00	95	50	53
H4345-1015	3/4	4	18.00	130	25	38
H4345-1115	7/8	4	19.00	225	25	53
H4345-1215	1	5	26.00	225	10	26
H4345-1315	1-1/8	6	34.00	225	10	29

UPC on PKG



DO NOT EXCEED CAPACITY!
See the SAFETY GUIDELINES section before using these products. Pages 138-149.

Aluminum Oval Sleeves & Stops

Stock #		For Cable Size (Inches)	Qty. Per Pkg.		Lbs. Per Pkg.	
Sleeves	Stops		Sleeves	Stops	Sleeves	Stops
H3629-0014	H3728-0014	1/16	50	25	0.05	0.03
H3629-0114	H3728-0114	3/32	50	25	0.10	0.05
H3629-0214	H3728-0214	1/8	50	25	0.30	0.08
H3629-0314	H3728-0314	3/16	50	25	0.75	0.25
H3629-0414	H3728-0414	1/4	25	25	0.63	0.53
H3629-0514	H3728-0514	5/16	25	25	0.63	0.53
H3629-0614	H3728-0614	3/8	25	25	0.63	0.53

UPC on PKG



Aluminum Oval Sleeves & Stops Kit

Stock #	For Cable Size (Inches)	Quantity Ten Cards Per Pack	Lbs. Per Each
4424038	1/16	2 Sleeves & 2 Stops Per Card	0.02
4424138	3/32	2 Sleeves & 2 Stops Per Card	0.03
4413338	1/8	2 Sleeves & 2 Stops Per Card	0.03
4413238	3/16	2 Sleeves & 2 Stops Per Card	0.06
4413138	1/4	2 Sleeves & 2 Stops Per Card	0.11

Thimble & Clip Sets

Stock #		For Cable Size (Inches)	Quantity Five Cards Per Pack	Lbs. Per Each
Zinc	Stainless Steel			
4418638	4418685	1/8	3 Clips & 1 Thimble Per Card	0.14
4418738	4418785	3/16	3 Clips & 1 Thimble Per Card	0.25
4421638	--	1/4	3 Clips & 1 Thimble Per Card	0.46



Wire Rope Thimbles

Stock #	Trade Size (Inches)	Quantity Per Package	Lbs. Per Package
UPC Tagged			
Zinc			
4514040	1/8	10	2.88
4514140	3/16	10	2.96
4514240	1/4	10	3.20
4514340	5/16	10	2.76
4514440	3/8	10	2.76
4514540	1/2	10	2.52



DO NOT EXCEED CAPACITY!
See the SAFETY GUIDELINES section before using these products. Pages 138-149.

MISCELLANEOUS HARDWARE

Wire Rope Thimbles Heavy Duty Type III

FED SPEC # FF-T-276B, TYPE III

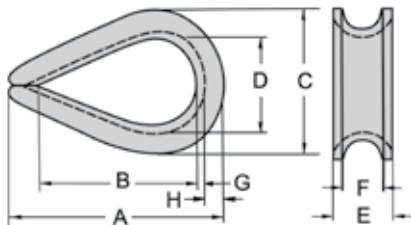

Stock #	Trade Size (Inches)	Dimensions (Inches)								Qty. Per Pkg.	Lbs. Per Pkg.
		A	B	C	D	E	F	G	H		
H4230-0415	1/4	2.19	1.63	1.50	0.88	0.41	0.28	0.06	0.23	100	7
H4230-0515	5/16	2.50	1.88	1.81	1.06	0.50	0.34	0.08	0.28	100	13
H4230-0615	3/8	2.88	2.13	2.13	1.13	0.63	0.41	0.11	0.34	100	26
H4230-0715	7/16	3.25	2.38	2.38	1.25	0.72	0.47	0.13	0.38	50	18
H4230-0815	1/2	3.63	2.75	2.75	1.50	0.81	0.53	0.14	0.41	50	30
H4230-0915	5/8	4.25	3.25	3.13	1.75	0.97	0.66	0.16	0.50	50	37
H4230-1015	3/4	5.00	3.75	3.81	2.00	1.22	0.78	0.22	0.66	25	41
H4230-1115	7/8	5.50	4.25	4.25	2.25	1.38	0.94	0.22	0.75	25	45
H4230-1215	1	6.13	4.50	4.94	2.50	1.56	1.06	0.25	0.88	10	31

Wire Rope Turnback Procedure

- 1 Double the wire rope around a wire rope thimble of the appropriate size, making sure that the "dead end turn back" is at least as long as stated in the Malleable Wire Rope Clips or Forged Wire Rope Clips product charts.
- 2 Place the first clip at least as far from the dead end of the cable as the width of the clip base, with the U-bolt part of the clip securing the dead end of the wire rope. Nuts should be tightened equally to the torque values listed in the Malleable Wire Rope Clips or Forged Wire Rope Clips product charts.
- 3 The second clip should be placed as close to the thimble as possible. If additional clips are required (see clips specs listed in charts referenced above for recommendations) space them evenly between the first two.
- 4 Tighten all clips to the recommended torque value, making sure that there is no slack in the wire rope between the clips.

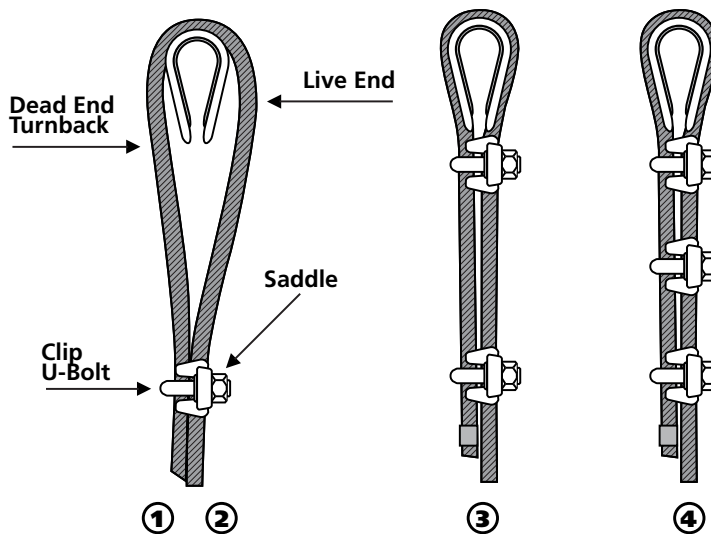

WARNING: When a load is first applied to this assembly, the nuts must be re-tightened to the torque values shown. To maintain the assembly in safe working order nuts should be checked regularly and re-tightened as needed.

WARNING: Do not exceed working load limit. Make all wire rope clip terminations/splices as illustrated. Do not use on coated cable without stripping away coating in the area to be terminated before installing clips. Tighten nuts to recommended torque and recheck frequently.

Malleable grade clips are not designed for overhead lifting. Thimbles are designed as a wear reduction pad for cable and wire rope, and are not intended to support loads. Thimbles should be used whenever an eye is formed in a cable or wire rope. Always match the correct size thimble to the cable. Never use a smaller thimble, as it will pinch and cut wire strands in the cable, reducing the load capacity of the assembly.



DO NOT EXCEED CAPACITY!
See the SAFETY GUIDELINES section before using these products. Pages 138-149.

Wire & Cable Swaging Tools

Stock #	Overall Length (Inches)	Capacity (Inches)	Quantity Per Package	Lbs. Per Package
UPC Tagged				
4529710	14	1/16" - 1/8" Cable	1	2
4529910	24	1/16" - 3/16" Cable	1	6



Wire & Cable Cutters

Stock #	Overall Length (Inches)	Capacity (Inches)	Quantity Per Package	Lbs. Per Package
UPC Tagged				
4528910	30	1/2" Dia.	1	9
4528810	23	3/8" Dia.	1	5
4528710	14	1/4" Dia.	1	3
*4528610	6	3/16" Dia.	1	1
4528510	6	3/16" Dia.	1	1

*Heavy Duty



Chain & Bolt Cutters

Stock #	Overall Length (Inches)	Capacity (Inches)	Quantity Per Package	Lbs. Per Package
UPC Tagged				
4101410	14	3/16" Proof Coil	1	3
4101810	18	1/4" Proof Coil	1	4
4102410	24	5/16" Proof Coil	1	5
4103010	30	5/16" Proof Coil	1	7



Hydraulic Cutters

- For Display Racks

Stock #	Description	Capacity (Inches)	Quantity Per Package	Lbs. Per Package
UPC Tagged				
4000244	Hydraulic	3/8" High Test	1	30
4000288	Hydraulic	3/8" Transport	1	30



Mechanics Sledge Hammer

Stock #	Head Size (Lbs.)	Length (Inches)	Quantity Per Package	Lbs. Per Package
UPC Tagged				
4200210	2	15	6	16
4200310	3	15	6	21
4200410	4	15	6	28
4200610	6	16	6	41



DO NOT EXCEED CAPACITY!
See the SAFETY GUIDELINES section before using these products. Pages 138-149.

Anti-Theft Padlocks Brass Combination Locks

These locks feature a brass plated zinc die cast body for resistance to rust. The shackle is tempered alloy steel. They have a re-settable combination so each lock can be customized with the users personal key code or all set to the same combination. The long shackle model works very well with QuikBinder™ Plus to keep the binder, chain & load locked and secure. H4927-2730 is retail packaged in a tamper-proof clamshell.

STOCK #: H4927-2730
Trade size: 2" Case (50mm)
Shackle length: 1"
Finish: Brass
Weight: 0.60 Lbs./Ea.
Factory package: 12/Ctn.
Order unit: Each



STOCK #: H4927-3030
Trade size: 2" Case (50mm)
Shackle length: 2-1/4"
Finish: Brass
Weight: 0.75 Lbs./Ea.
Factory package: 12/Ctn.
Order unit: Each



Weatherproof Locks

These locks are designed with the elements in mind. This specialty lock is completely sealed from the weather. It is constructed of laminated steel with a double locking device for extra protection. The internal lock cylinder is solid brass, has pin tumblers and stainless steel springs. Two solid brass, nickel plated keys accompany each lock.

STOCK #: H4924-1261
Trade Size: 1-1/2" Case (40mm)
Shackle Length: 1-1/4"
Weight: 0.61 Lbs./Ea.
Factory Package: 12/Ctn
Order Unit: Each



STOCK #: H4925-2461
Trade Size: 1-1/2" Case (40mm)
Shackle Length: 2-1/2"
Weight: 0.69 Lbs./Ea.
Factory Package: 12/Ctn
Order Unit: Each



"Hex" Anti-Theft Chain Lock

Padlock body is made from Stainless A304 material with a magnesium shackle. The lock body extends up to protect the shackle from allowing bolt cutters to access it. Lock comes with 4 double notch cut reversible keys that can not be removed unless the lock is closed and secure. This lock is a great partner with Hex Chain for maximum security.

STOCK #: H4920-1200
Shackle Length: 1"
Finish: Stainless
Weight: 1.60 Lbs./Ea.
Factory Package: 1/Ctn.
Order Unit: Each



"Hex" Anti-Theft Chain

Hex chain is a high alloy chain drawn in a six sided (hexagonal) shape and heat treated to be extremely hard. The hex shape does not allow a bolt cutter to get the proper bite to permit them to cut the chain. It is ideal for securing equipment or portable tools at a job site or for general purpose security use. Sold in full drums or custom cut at the factory to the users required length.

STOCK #: H2914-0812
Trade Size: 7/16" x 200'
Finish: Blue
Weight: 370 Lbs./Per Half Drum
Factory Package: Half Drum
Order Unit: Ft.

STOCK #: 8612621
Trade Size: 7/16"
Finish: Blue
Factory Package: Custom Cut
Order Unit: Ft.



WARNING

DO NOT EXCEED CAPACITY!
See the SAFETY GUIDELINES section before using these products. Pages 138-149.



Grade 70 ISO Chain	124
Grade 43 ISO Chain	125, 128
Grade 30 ISO Chain	126, 129
BBB Chain	127
Anchor Lead Chain	130
Marine Chain Accessories	131-133
Mooring Chain	134
Deck Lashing Chain	134
Tuna Chain	135
Trawlex Chain	136
Trawl Door Chain	136
Scallop Chain & Accessories	137
Tickler Chain	137

ACCO® G70 ISO Chain

NOT FOR OVERHEAD LIFTING



Full Drum

HDG	Trade Size (In.)	Wire Dia. (In.)	Inside Dimensions (Inches)		Qty. Per Drum	Net Wt. (Lbs.)	Working Load Limit	
			Length (Nominal)	Width (Minimum)			Lbs.	Kgs.
520140402	1/4	0.279	0.870	0.441	800	616	2,835	1,285
520140502	5/16	0.332	1.111	0.505	550	554	4,230	1,910
520140602	3/8	0.404	1.226	0.576	400	623	5,940	2,690

Half Drum

HDG	Trade Size (In.)	Wire Dia. (In.)	Inside Dimensions (Inches)		Qty. Per Drum	Net Wt. (Lbs.)	Working Load Limit	
			Length (Nominal)	Width (Minimum)			Lbs.	Kgs.
520140401	1/4	0.279	0.870	0.441	400	308	2,835	1,285
520140501	5/16	0.332	1.111	0.505	275	277	4,230	1,910
520140601	3/8	0.404	1.226	0.576	200	312	5,940	2,690

5 Gallon Pail

HDG	Trade Size (In.)	Wire Dia. (In.)	Inside Dimensions (Inches)		Qty. Per Drum	Net Wt. (Lbs.)	Working Load Limit	
			Length (Nominal)	Width (Minimum)			Lbs.	Kgs.
521340401	1/4	0.279	0.870	0.441	150	116	2,835	1,285
521340501	5/16	0.332	1.111	0.505	100	101	4,230	1,910



DO NOT EXCEED CAPACITY!
See the SAFETY GUIDELINES section before using these products. Pages 138-149.

ACCO® G43 Domestic High Test ISO Chain



A high tensile strength carbon steel anchor (windlass) chain with an ISO short link. The short link makes it more flexible and ideally suited as a windlass chain. Check fit or contact windlass manufacturer before purchase. This extra thick hot dip galvanized finish is recommended for all marine applications.

NOT FOR OVERHEAD LIFTING



Hallmark: G4

Full Drum

Stock #		Trade Size (In.)	Wire Dia. (In.)	Inside Dimensions (In.)		Qty. Per Drum	Net Wt. (Lbs.)	WLL	
Self-Colored	HDG			Length (Nom.)	Width (Min.)			Lbs.	Kgs.
500110402	500140402	1/4	0.274	0.845	0.410	800	586	2,600	1,180
500110502	500140502	5/16	0.329	1.030	0.500	550	570	3,900	1,770
500110632	500140632	3/8	0.394	1.220	0.600	400	595	5,400	2,450
500110702	500140702	7/16	0.467	1.400	0.660	300	645	7,200	3,266
500110802	500140802	1/2	0.510	1.590	0.770	200	507	9,200	4,174
500110902	500140902	5/8	0.625	1.790	0.910	150	582	13,000	5,897



Half Drum



Stock #		Trade Size (In.)	Wire Dia. (In.)	Inside Dimensions (In.)		Qty. Per Drum	Net Wt. (Lbs.)	WLL	
Self-Colored	HDG			Length (Nom.)	Width (Min.)			Lbs.	Kgs.
500110401	500140401	1/4	0.274	0.845	0.410	400	293	2,600	1,180
500110501	500140501	5/16	0.329	1.030	0.500	275	285	3,900	1,770
500110631	500140631	3/8	0.394	1.220	0.600	200	297	5,400	2,450
500110701	500140701	7/16	0.467	1.400	0.660	150	322	7,200	3,266
500110801	500140801	1/2	0.510	1.590	0.770	100	253	9,200	4,174

5 Gallon Square Pail

Stock #		Trade Size (In.)	Wire Dia. (In.)	Inside Dimensions (In.)		Qty. Per Pail	Net Wt. (Lbs.)	WLL	
Self-Colored	HDG			Length (Nom.)	Width (Min.)			Lbs.	Kgs.
501310401	501340401	1/4	0.274	0.845	0.410	134	98	2,600	1,180
501310501	501340501	5/16	0.329	1.030	0.500	90	93	3,900	1,770
501310601	501340601	3/8	0.394	1.220	0.600	64	95	5,400	2,450



Wood Crate



Stock #	Trade Size (In.)	Wire Dia. (In.)	Inside Dimensions (In.)		Qty. Per Crate	Net Wt. (Lbs.)	WLL	
HDG	Length (Nom.)	Width (Min.)	Lbs.	Kgs.				
500191733	1/4	0.274	0.845	0.410	3,600	2,628	2,600	1,180
500191734	5/16	0.329	1.030	0.500	2,800	2,903	3,900	1,770
500191735	3/8	0.394	1.220	0.600	1,800	2,672	5,400	2,450
500191736	1/2	0.510	1.590	0.770	1,000	2,533	9,200	4,174
8610327	5/8	0.625	1.790	0.910	600	2,328	13,000	5,897



DO NOT EXCEED CAPACITY!
See the SAFETY GUIDELINES section before using these products. Pages 138-149.

ACCO® G30 Domestic Proof Coil ISO Chain



NOT FOR OVERHEAD LIFTING

Full Drum

Stock #		Trade Size (In.)	Wire Dia. (In.)	Inside Dimensions (Inches)		Qty. Per Drum	Net Wt. (Lbs.)	Working Load Limit	
Self-Colored	HDG			Length (Nominal)	Width (Minimum)			Lbs.	Kgs.
400100432	400140432	1/4	0.279	1.000	0.507	800	599	1,300	590
400100502	400140502	5/16	0.342	1.100	0.507	550	614	1,900	862
400100602	400140602	3/8	0.404	1.230	0.620	400	644	2,650	1,202
400100802	400140802	1/2	0.512	1.500	0.820	200	525	4,500	2,042
400101032	400141032	5/8	0.628	1.900	1.020	150	557	6,900	3,131
400101232	400141232	3/4	0.779	2.200	1.100	100	595	10,600	4,810

Half Drum

Stock #		Trade Size (In.)	Wire Dia. (In.)	Inside Dimensions (Inches)		Qty. Per Drum	Net Wt. (Lbs.)	Working Load Limit	
Self-Colored	HDG			Length (Nominal)	Width (Minimum)			Lbs.	Kgs.
400100431	400140431	1/4	0.279	1.000	0.507	400	299	1,300	590
400100501	400140501	5/16	0.342	1.100	0.507	275	308	1,900	862
400100601	400140601	3/8	0.404	1.230	0.620	200	322	2,650	1,202
400100801	400140801	1/2	0.512	1.500	0.820	100	262	4,500	2,042

5 Gallon Square Pail

Stock #		Trade Size (In.)	Wire Dia. (In.)	Inside Dimensions (Inches)		Qty. Per Pail	Net Wt. (Lbs.)	Working Load Limit	
Self-Colored	HDG			Length (Nominal)	Width (Minimum)			Lbs.	Kgs.
401100431	401140431	1/4	0.279	1.000	0.507	141	106	1,300	590
401100501	401140501	5/16	0.342	1.100	0.507	92	103	1,900	862
401100601	401140601	3/8	0.404	1.230	0.620	63	101	2,650	1,202
401100801	401140801	1/2	0.512	1.500	0.820	36	94	4,500	2,042



Hallmark: G3



WARNING

DO NOT EXCEED CAPACITY!
See the SAFETY GUIDELINES section before using these products. Pages 138-149.



ACCO® BBB Chain

A low carbon steel, general purpose chain, with a short compact link. The short link is ideally suited for anchor chain. Check fit for windlass manufacturer's specifications before purchase.

NOT FOR OVERHEAD LIFTING

Full Drum

Stock #	Trade Size (Inches)	Wire Dia. (Inches)	Inside Dimensions (Inches)		Qty. Per Drum	Net Wt. (Lbs.)	Working Load Limit	
			Length (Nominal)	Width (Minimum)			Lbs.	Kgs.
410140402	1/4	0.274	0.870	0.430	800	590	1,300	590
410140502	5/16	0.328	1.000	0.500	550	646	1,900	862
410140602	3/8	0.392	1.090	0.620	400	640	2,650	1,202
410140802	1/2	0.509	1.340	0.750	200	546	4,500	2,042

5 Gallon Square Pail

Stock #	Trade Size (Inches)	Wire Dia. (Inches)	Inside Dimensions (Inches)		Qty. Per Pail	Net Wt. (Lbs.)	Working Load Limit	
			Length (Nominal)	Width (Minimum)			Lbs.	Kgs.
411140402	1/4	0.274	0.870	0.430	141	104	1,300	590
411140502	5/16	0.328	1.000	0.500	92	108	1,900	862
411140602	3/8	0.392	1.090	0.620	63	100	2,650	1,202

Wood Crate

Stock #	Trade Size (Inches)	Wire Dia. (Inches)	Inside Dimensions (Inches)		Qty. Per Crate	Net Wt. (Lbs.)	Working Load Limit	
			Length (Nominal)	Width (Minimum)			Lbs.	Kgs.
400191733	1/4	0.274	0.870	0.430	3600	2,657	1,300	590
400191734	5/16	0.328	1.000	0.500	2800	3,286	1,900	862
400191735	3/8	0.392	1.090	0.620	1800	2,878	2,650	1,202
400191736	1/2	0.509	1.340	0.750	1000	2,732	4,500	2,042



Hallmark: 3B



DO NOT EXCEED CAPACITY!
See the SAFETY GUIDELINES section before using these products. Pages 138-149.

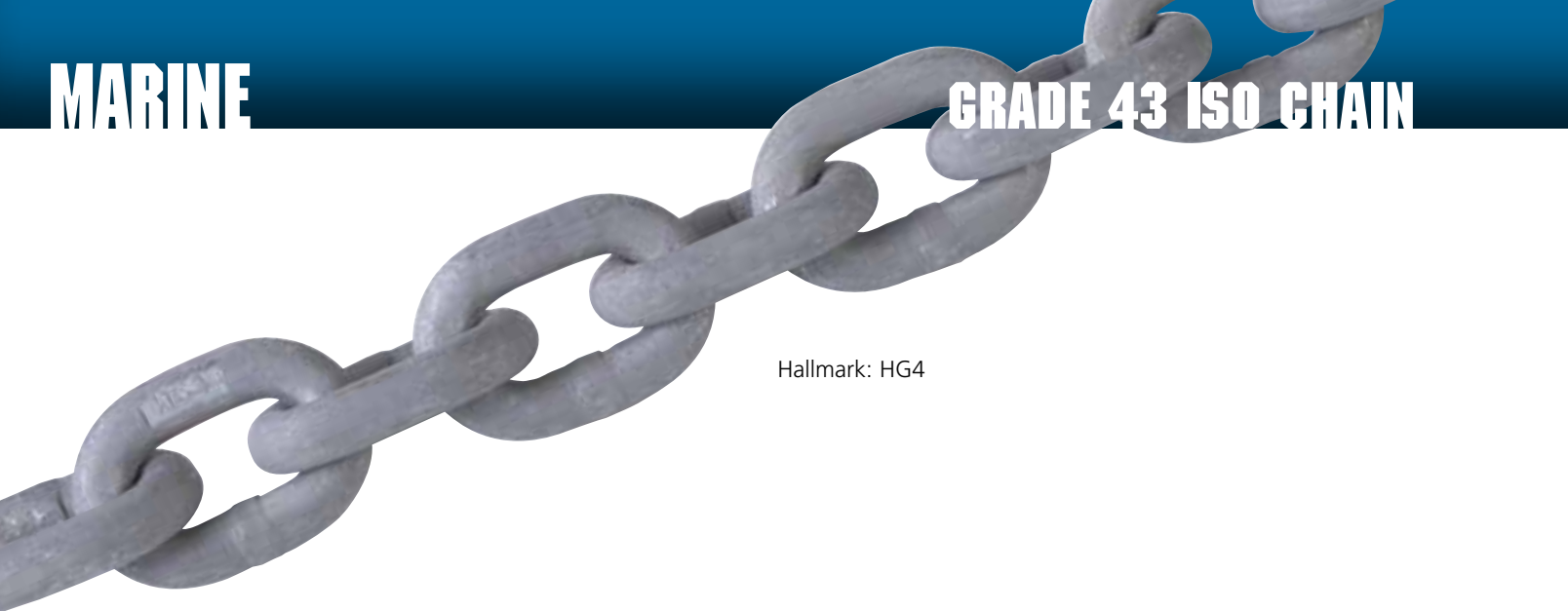

Hallmark: HG4

Boatman's Pride™ G43 High Test ISO Chain

NOT FOR OVERHEAD LIFTING

Full Drum

Stock #	Trade Size (Inches)	Wire Dia. (Inches)	Inside Dimensions (Inches)		Qty. Per Drum	Net Wt. (Lbs.)	Working Load Limit	
			Length (Nominal)	Width (Minimum)			Lbs.	Kgs.
700140402	1/4	0.274	0.845	0.400	800	598	2,600	1,180
700140502	5/16	0.330	1.030	0.490	550	584	3,900	1,770
700140632	3/8	0.399	1.220	0.580	400	594	5,400	2,450

Half Drum

Stock #	Trade Size (Inches)	Wire Dia. (Inches)	Inside Dimensions (Inches)		Qty. Per Drum	Net Wt. (Lbs.)	Working Load Limit	
			Length (Nominal)	Width (Minimum)			Lbs.	Kgs.
700140401	1/4	0.274	0.845	0.400	400	299	2,600	1,180
700140501	5/16	0.330	1.030	0.490	275	292	3,900	1,770
700140631	3/8	0.399	1.220	0.580	200	297	5,400	2,450

Pail

Stock #	Trade Size (Inches)	Wire Dia. (Inches)	Inside Dimensions (Inches)		Qty. Per Pail	Net Wt. (Lbs.)	Working Load Limit	
			Length (Nominal)	Width (Minimum)			Lbs.	Kgs.
700191732	1/4	0.274	0.845	0.400	100	75	2,600	1,180
701340801	5/16	0.330	1.030	0.490	125	133	3,900	1,770

Wood Crate

Stock #	Trade Size (Inches)	Wire Dia. (Inches)	Inside Dimensions (Inches)		Qty. Per Drum	Net Wt. (Lbs.)	Working Load Limit	
			Length (Nominal)	Width (Minimum)			Lbs.	Kgs.
700191733	1/4	0.274	0.845	0.400	3,600	2,693	2,600	1,180
700191734	5/16	0.330	1.030	0.490	2,800	2,971	3,900	1,770
8610833	3/8	0.399	1.220	0.580	1,800	2,673	5,400	2,450



DO NOT EXCEED CAPACITY!
See the SAFETY GUIDELINES section before using these products. Pages 138-149.



Hallmark: HG3

Boatman's Pride™ G30 Proof Coil ISO Chain

NOT FOR OVERHEAD LIFTING

Full Drum

Stock #	Trade Size (Inches)	Wire Dia. (Inches)	Inside Dimensions (Inches)		Qty. Per Drum	Net Wt. (Lbs.)	Working Load Limit	
			Length (Nominal)	Width (Minimum)			Lbs.	Kgs.
600140432	1/4	0.279	1.000	0.507	800	584	1,300	590
600140502	5/16	0.342	1.100	0.507	550	600	1,900	862
600140602	3/8	0.399	1.230	0.620	400	628	2,650	1,202

Half Drum

Stock #	Trade Size (Inches)	Wire Dia. (Inches)	Inside Dimensions (Inches)		Qty. Per Drum	Net Wt. (Lbs.)	Working Load Limit	
			Length (Nominal)	Width (Minimum)			Lbs.	Kgs.
600140431	1/4	0.279	1.000	0.507	400	292	1,300	590
600140501	5/16	0.342	1.100	0.507	275	300	1,900	862
600140601	3/8	0.399	1.230	0.620	200	314	2,650	1,202

Pail

Stock #	Trade Size (Inches)	Wire Dia. (Inches)	Inside Dimensions (Inches)		Qty. Per Pail	Net Wt. (Lbs.)	Working Load Limit	
			Length (Nominal)	Width (Minimum)			Lbs.	Kgs.
601140431	1/4	0.279	1.000	0.507	141	103	1,300	590
601140501	5/16	0.342	1.100	0.507	92	100	1,900	862
601140601	3/8	0.399	1.230	0.620	63	99	2,650	1,202



DO NOT EXCEED CAPACITY!
See the SAFETY GUIDELINES section before using these products. Pages 138-149.

Boatman's Pride™ Anchor Lead Chains

Double Coated for Double Duty

- Protects Decks and Hulls
- Hot Dipped Galvanized Undercoat
- Heat Cured White Polymer Overcoat or Heavy Duty Vinyl Coating

Available in three chain sizes and 2 coatings. Pre-cut leads have a large end link welded on one end for easy hook up to the anchor line. Heavy duty protection assures years of dependable service.

NOT FOR OVERHEAD LIFTING.



Heavy
Duty Hot
Galvanized
Plating



Polymer
or Vinyl Coated
(Vinyl coated shown)



5 Gallon Square Pail

Stock #	Trade Size (Inches)	Wire Dia. (Inches)	Inside Dimensions (Inches)		Qty. Per Pail	Net Wt. (Lbs.)	Working Load Limit	
			Length (Nominal)	Width (Minimum)			Lbs.	Kgs.
White Polymer Coated HDG Chain								
402080302	3/16	0.217	0.950	0.405	154	70	800	363
402080402	1/4	0.274	1.236	0.480	96	65	1,300	590
402080502	5/16	0.328	1.285	0.480	60	68	1,900	862

Pre-cut Anchor Lead Chains - Shelf Pack (4 boxes per pkg.)

Stock #	Trade Size	Wire Dia. (Inches)	Inside Dimensions (Inches)		Qty. Per Package	Lbs. Per Package	Working Load Limit	
			Length (Nominal)	Width (Minimum)			Lbs.	Kgs.
White Polymer Coated HDG Chain								
406980405	1/4" x 5'	0.274	1.236	0.480	4	15	1,300	590
406980506	5/16" x 6'	0.328	1.285	0.480	4	26	1,900	862

Pre-cut Anchor Lead Chains - Shelf Pack (5 bags per pkg.)

Stock #	HDG	Trade Size	Wire Dia. (Inches)	Inside Dimensions (Inches)		Qty. Per Pkg.	Coated HDG Lbs. Per Pkg.	HDG Lbs. Per Pkg.	Working Load Limit	
				Length (Nominal)	Width (Minimum)				Lbs.	Kgs.
White Vinyl Coated HDG Chain										
406980324	406940304	3/16" x 4'	0.217	0.950	0.405	5	12	9	800	363
406980425	406940405	1/4" x 5'	0.274	1.236	0.480	5	22	16	1,300	590
406980526	406940506	5/16" x 6'	0.328	1.285	0.480	5	36	24	1,900	862



WARNING

DO NOT EXCEED CAPACITY!
See the SAFETY GUIDELINES section before using these products. Pages 138-149.

Anchor Rode Swivel

- Easy Swiveling Design
- Stainless Steel Pin Locks
- Grade 40 High Test Steel
- Hot Dip Galvanized

NOT FOR OVERHEAD LIFTING

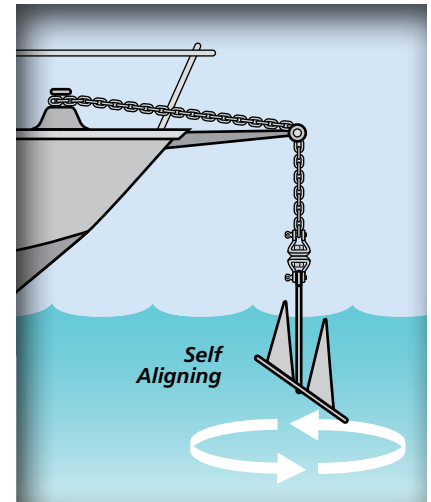

Stock #	UPC	Trade Size (Inches)	Qty. Per Package	Lbs. Per Each	Working Load Limit	
					Lbs.	Kgs.
440640011		1/4-5/16	25	30	1,500	681

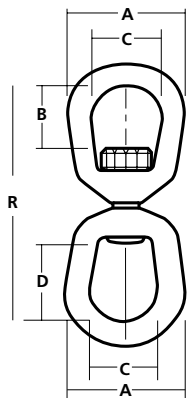

Forged Anchor Eye-Eye Swivels

Stock #	UPC	Trade Size (Inches)	Dimensions (Inches)					Qty. Per Pkg.	Lbs. Per Each	Working Load Limit	
			A	B	C	D	R			Lbs.	Kgs.
8170241		1/4	1.250	0.688	0.750	1.063	2.938	25	0.22	850	386
8170341		5/16	1.625	0.813	1.000	1.250	3.563	25	0.33	1,250	567
8170441		3/8	2.000	0.938	1.250	1.500	4.313	10	0.66	2,250	1,021
8170541		1/2	2.500	1.313	1.500	2.000	5.438	10	1.43	3,600	1,634
8170641		5/8	3.000	1.563	1.750	2.375	6.563	5	2.49	5,200	2,360
8170741		3/4	3.500	1.750	2.000	2.625	7.188	5	4.08	7,200	3,268
8170841		7/8	4.000	2.060	2.250	3.060	8.380	5	6.25	10,000	4,535
8170941		1	4.500	2.310	2.500	3.500	9.630	5	8.95	12,500	5,670



NOT FOR OVERHEAD LIFTING

NOT FOR OVERHEAD LIFTING

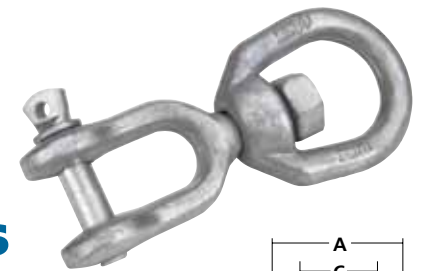

Forged Anchor Jaw-Eye Swivels

Stock #	UPC	Trade Size (Inches)	Dimensions (Inches)						Qty. Per Pkg.	Lbs. Per Each	Working Load Limit		
			A	B	C	K	D	Pin Dia.			R	Lbs.	Kgs.
8171241		1/4	1.250	0.688	0.750	0.469	0.875	0.250	2.625	25	0.21	850	386
8171341		5/16	1.625	0.813	1.000	0.500	0.875	0.313	2.938	25	0.32	1,250	567
8171441		3/8	2.000	0.938	1.250	0.625	1.063	0.375	3.625	10	0.61	2,250	1,021
8171541		1/2	2.500	1.313	1.500	0.750	1.313	0.500	4.500	10	1.24	3,600	1,634
8171641		5/8	3.000	1.563	1.750	0.938	1.500	0.625	5.313	5	2.56	5,200	2,360
8171741		3/4	3.500	1.750	2.000	1.125	1.750	0.750	6.063	5	4.17	7,200	3,268
8171841		7/8	4.000	2.060	2.250	1.190	2.060	0.880	7.000	5	5.87	10,000	4,535
8171941		1	4.500	2.310	2.500	1.750	2.810	1.130	8.560	5	9.84	12,500	5,670

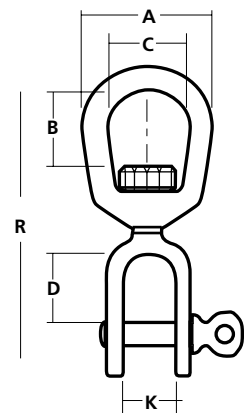

DO NOT EXCEED CAPACITY!
See the SAFETY GUIDELINES section before using these products. Pages 138-149.

**NOT FOR
OVERHEAD
LIFTING.**

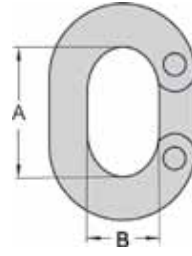

Oval Connecting Links

Stock #	UPC	Trade Size (Inches)	Dimensions (Inches)		Qty. Per Pkg.	Lbs. Per Each	Working Load Limit	
			A	B			Lbs.	Kgs.
440840403		1/4	0.880	0.440	10	0.06	1,300	590
440840503		5/16	0.940	0.500	10	0.11	1,900	862
440840603		3/8	1.200	0.560	10	0.18	2,650	1,202
440840802		1/2	1.440	0.660	10	0.36	4,500	2,042
6800035		5/8	1.810	0.780	60	0.75	10,800	4,900



**NOT FOR
OVERHEAD
LIFTING.**

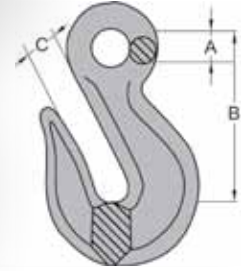

G30 Eye Grab Hooks

Stock #	UPC	Trade Size (Inches)	Dimensions (Inches)			Qty. Per Pkg.	Lbs. Per Each	Working Load Limit	
			A	B	C			Lbs.	Kgs.
440242442		5/16	0.600	2.180	0.360	10	0.52	1,900	862
440242443		3/8	0.710	2.630	0.430	10	0.78	2,650	1,202
440242445		1/2	0.920	3.400	0.560	5	1.60	4,500	2,042



**NOT FOR
OVERHEAD
LIFTING**

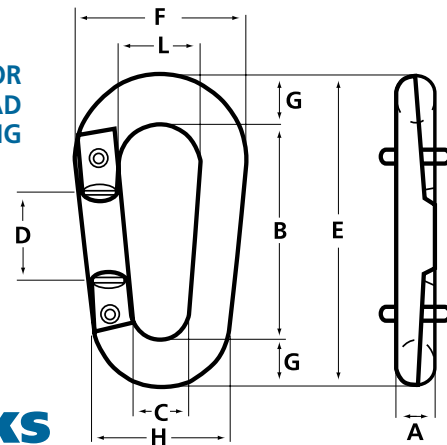

Pear Shaped Connecting Links

Stock #	Trade Size (Inches)	Dimensions (Inches)									Qty. Per Pkg.	Lbs. Per Each	Working Load Limit	
		A	B	C	E	D	F	G	H	L			Lbs.	Kgs.
6800023	3/8	0.440	2.010	0.560	0.830	2.950	1.660	0.470	1.440	0.780	200	0.31	2,250	1,021
6800021	1/2	0.500	2.490	0.690	1.000	3.630	2.000	0.570	1.720	1.000	100	0.56	4,000	1,815



WARNING

DO NOT EXCEED CAPACITY!
See the SAFETY GUIDELINES section before using these products. Pages 138-149.

Peer-Lift® Screw Pin Anchor Shackles

Ideal for those applications where frequent pin removal is needed.

- Forged carbon body and alloy pin
- Meets or exceed FED SPEC RR-C-271 requirements
- Hot Dipped Galvanized to ASTM A153
- Proof load at 2.2 times Working Load Limit

Stock #	UPC	Trade Size (Inches)	Pin Dia. (D)	Dimensions (Inches)				Qty. Per Pkg.	Lbs. Per Each	Working Load Limit* (Ton)	
				W	A	E (Min)	G (Max)				B (Min)
8058105		3/16	1/4	0.375	0.875	0.562	0.625	0.180	25	0.06	1/3
8058205		1/4	5/16	0.469	1.125	0.750	0.875	0.240	25	0.11	1/2
8058305		5/16	3/8	0.531	1.250	0.812	1.000	0.300	25	0.19	3/4
8058405		3/8	7/16	0.656	1.438	0.938	1.125	0.360	25	0.31	1
8059205		7/16	1/2	0.750	1.688	1.062	1.250	0.420	25	0.49	1-1/2
8058505		1/2	5/8	0.812	1.875	1.188	1.375	0.480	25	0.73	2
8058605		5/8	3/4	1.062	2.375	1.500	1.875	0.590	25	1.37	3-1/4
8058705		3/4	7/8	1.250	2.812	1.750	2.125	0.710	25	2.36	4-3/4
8058805		7/8	1	1.438	3.312	2.000	2.375	0.830	10	3.62	6-1/2
8058905		1	1-1/8	1.688	3.750	2.312	2.625	0.950	10	5.07	8-1/2
8058005		1-1/8	1-1/4	1.812	4.250	2.625	2.875	1.070	5	7.41	9-1/2
8059005		1-1/4	1-3/8	2.031	4.688	2.875	3.250	1.190	5	9.51	12
8059305		1-3/8	1-1/2	2.250	5.250	3.250	3.500	1.310	5	13.25	13-1/2
8059105		1-1/2	1-5/8	2.375	5.750	3.375	3.750	1.420	1	17.70	17
8059405		1-3/4	2	2.875	7.000	4.500	4.500	1.660	1	30.40	25
8059505		2	2-1/4	3.250	7.750	5.250	5.250	1.900	1	45.04	35

*Ultimate load is 5 times the Working Load Limit. Reduce Working Load Limit for side loading applications, see page 143.

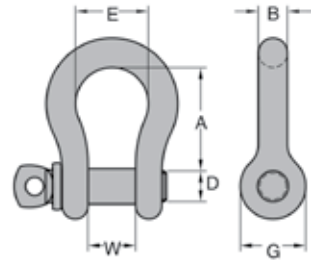

NOT FOR OVERHEAD LIFTING

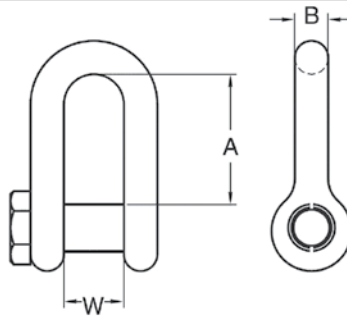

Forged Trawling Shackles

Stock #	Black Powder Coat	Trade Size (Inches)	Pin Dia. (D)	Dimensions (Inches)			Qty. Per Pkg.	Lbs. Per Each	Working Load Limit (Ton)
				W	A	B			
H9626-0824		1/2	5/8	0.830	1.690	0.473	10	0.60	5/8
H9626-0924		5/8	3/4	1.100	1.970	0.590	10	1.25	1
H9626-1024		3/4	7/8	1.340	2.360	0.740	10	2.20	1-3/8
H9626-1124		7/8	1	1.420	2.880	0.820	5	3.00	1-7/8
H9626-1224		1	1-1/8	1.690	3.030	0.940	5	4.50	2-1/2



DO NOT EXCEED CAPACITY!
See the SAFETY GUIDELINES section before using these products. Pages 138-149.

Use a Shackle for Maximum Flexibility

Use a shackle to add on to an existing span of chain or connect it in the middle of a span for maximum versatility.

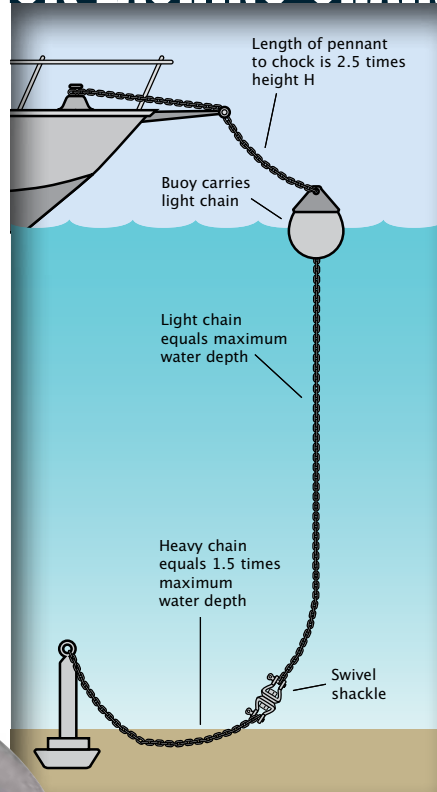
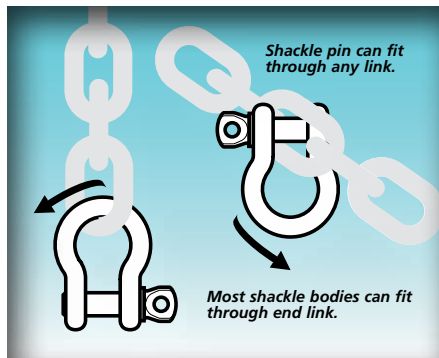

Embossed: MC every 8-10 links
USA: every link



ACCO[®] Mooring Chain

The Best Chain for a Tough Job

Compare ACCO's mooring chain to proof coil chain and it's easy to see that ACCO mooring chain is stronger.

Plus the hot dip galvanized coating has 30% more zinc per unit volume than mechanical coating.

The long link design permits the hook-up of shackles anywhere on the chain, not just on end links as with most chains.

NOT FOR OVERHEAD LIFTING.

High Quality Steel
Hot Dip Galvanized
Long Link Design

Full Drum

Stock #	Trade Size (Inches)	Wire Dia. (Inches)	Inside Link Dimensions (Inches)		Qty. Per Drum	Net Wt. (Lbs.)	Working Load Limit	
			Length (Nominal)	Width (Minimum)			Lbs.	Kgs.
500140650	3/8	0.394	1.630	0.650	200	287	4,050	1,837
500140850	1/2	0.519	2.000	0.870	200	503	6,900	3,130
500141052	5/8	0.630	2.530	0.920	150	500	9,750	4,422
500141050	5/8	0.630	2.530	0.920	200	665	9,750	4,422
500141150	3/4	0.781	2.990	1.040	100	532	15,000	6,804

Deck Lashing Chain

Stock #	Trade Size (Inches)	Wire Dia. (Inches)	Inside Link Dimensions (Inches)		Qty. Per Pkg. (ft.)	Net Wt. (Lbs.)	Working Load Limit	
			Length (Nominal)	Width (Minimum)			Lbs.	Kgs.
560141301	1/2	0.531	3.150	0.930	460	1,004	9,000	4,080
8612312	1/2	0.531	3.150	0.930	1,000	2,182	9,000	4,080



DO NOT EXCEED CAPACITY!
See the SAFETY GUIDELINES section before using these products. Pages 138-149.

ACCO® Tuna Chain

The Best Chain for a Tough Job.

ACCO uses high quality steel, especially formulated and heat treated for tuna fishing. Every heat treated lot is sampled and destructively tested for material strength and link elongation. All Tuna Net Chain is then proof tested, 100%, every link.

ACCO Tuna Net Chain is then continuously Hot Dip Galvanized to provide the deep strong protective coating you have come to expect which with over 30% more zinc per unit volume than mechanical coating. In the hot dip process the galvanized zinc coating is alloyed with the base steel creating a METALLURGICAL bond that is several orders of magnitude stronger than mechanical bonding. This zinc-steel bond is immune to further corrosion for the life of the zinc. If the chain's steel base is exposed by cuts or nicks, the base steel will not rust until the nearby zinc is consumed.



**NOT FOR
OVERHEAD
LIFTING**

Full Steel Drum

Stock #	Trade Size (Inches)	Wire Dia. (Inches)	Inside Link Dimensions (Inches)		Qty. Per Drum	Net Wt. (Lbs.)	Working Load Limit	
			Length (Nominal)	Width (Minimum)			Lbs.	Kgs.
520140692	3/8	0.394	1.330	0.570	400	580	6,600	2,994
520140792	7/16	0.467	1.370	0.750	300	670	8,750	3,969
520140892	1/2	0.519	1.720	0.750	200	485	11,300	5,125
520140992	9/16	0.551	1.700	0.850	200	601	12,150	5,510
520141092	5/8	0.630	1.930	0.865	150	566	15,800	7,167
520141292	3/4	0.750	2.420	1.140	200	575	24,700	11,202



DO NOT EXCEED CAPACITY!
See the SAFETY GUIDELINES section before using these products. Pages 138-149.

ACCO® Long-Link & Mid-Link Trawlex Chain

• Packing - steel drums (Pallet boxes available on request)

• High strength special steels, hardened and tempered, resistance to shock loading and wear

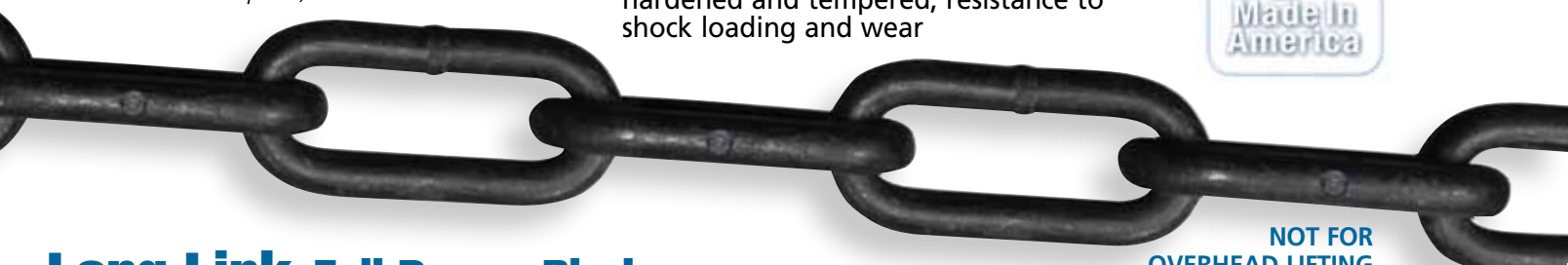

Long-Link Full Drum - Black

NOT FOR OVERHEAD LIFTING

Stock #		Nominal Dia. (MM)	Inside Dimensions (MM)		Weight (Kgs/Mtr)	Working Load Limit		Mtrs./ Drum	Kgs./Drum
Black	Code		Length	Width		Lbs.	Kgs.		
5590923	TLL-9-8	9	53	15	1.4	5,620	2,550	200	308
5591123	TLL-11-10	11	64	19	2.2	10,195	4,625	150	345
5591323	TLL-13-10	13	80	23	3.2	14,602	6,620	150	505
5591623	TLL-16-10	16	100	26	4.8	22,050	10,000	100	507
5591923	TLL-19-10	19	100	28	7.3	31,415	14,250	75	567
5592223	TLL-22-10	22	120	34	8.8	38,575	17,495	50	462

Mid-Link Full Drum - Black

Stock #	Trade Size (Inches)	Wire Dia. (Inches)	Inside Dimensions (Inches)		Qty. Per Drum	Net Wt. (Lbs.)	Working Load Limit	
			Length (Nom.)	Width (Min.)			Lbs.	Kgs.
550110601	3/8	0.404	1.630	0.650	200	286	7,100	3,221
550110802	1/2	0.528	2.000	0.870	200	494	12,000	5,443
550111002	5/8	0.630	2.530	0.920	200	666	18,100	8,210

Wood Crate - Black

Stock #	Trade Size (Inches)	Wire Dia. (Inches)	Inside Dimensions (Inches)		Qty. Per Crate	Net Wt. (Lbs.)	Working Load Limit	
			Length (Nom.)	Width (Min.)			Lbs.	Kgs.
550110603	3/8	0.404	1.630	0.650	2000	2,860	7,100	3,221
550110803	1/2	0.528	2.000	0.870	1000	2,470	12,000	5,443
550111003	5/8	0.630	2.530	0.920	1000	3,330	18,100	8,210

ACCO® Trawl Door Chain - Full Drum - (Steel) NOT FOR OVERHEAD LIFTING

Stock #	Trade Size (Inches)	Wire Dia. (Inches)	Inside Dimensions (Inches)		Qty. Per Drum	Net Wt. (Lbs.)	Working Load Limit	
			Length (Nom.)	Width (Min.)			Lbs.	Kgs.
500140612	3/8	0.392	1.297	0.580	400	582	5,400	2,449
500140611	3/8	0.392	1.297	0.580	200	291	5,400	2,449
500140812	1/2	0.512	1.595	0.620	200	498	9,200	4,173



DO NOT EXCEED CAPACITY!
See the SAFETY GUIDELINES section before using these products. Pages 138-149.

SCALLOP & TICKLER CHAIN



ACCO® Scallop Sweep Chain

NOT FOR OVERHEAD LIFTING

Stock #		Trade Size (In.)	Wire Dia. (In.)	Inside Dimensions (Inches)		Qty. Per Package	Net Wt. (Lbs.)	Working Load Limit	
Self-Colored	Black			Length (Nom.)	Width (Min.)			Lbs.	Kgs.
5000151002	---	5/8	0.630	1.930	0.865	150 ft/drum	615	14,000	6,350
8611255	---	5/8	0.630	1.930	0.865	700 ft/pallet box	2869	14,000	6,350
---	500152002	3/4	0.750	2.190	0.985	75 ft/drum	397	20,200	9,160
---	8612476	3/4	0.750	2.190	0.985	500 ft/pallet box	2645	20,200	9,160

ACCO® Welded Scallop Rings

5 Gallon Square Pail



ACCO® Scallop Links - 5 Gallon Square Pail

Stock #	Trade Size (Inches)	Wire Dia. (Inches)	Qty. Per Pail	Lbs. Per Pail
8371241	3/8	0.375	350	50

Stock #	Trade Size (Inches)	Wire Dia. (Inches)	Qty. Per Pail	Lbs. Per Pail
8370841	7/16 x 4	0.438	82	50



ACCO® Super-Tuf Tickler Chain

Full Drum - (Steel)

Stock #	Trade Size (Inches)	Wire Dia. (Inches)	Inside Dimensions (Inches)		Qty. Per Drum	Net Wt. (Lbs.)
			Length (Nom.)	Width (Min.)		
5641384	5/16	0.332	1.111	0.465	275	276
5641484	3/8	0.404	1.600	0.630	400	544
5641684	1/2	0.528	2.035	0.860	200	460
5641884	5/8	0.625	2.530	0.902	200	666



DO NOT EXCEED CAPACITY!
See the SAFETY GUIDELINES section before using these products. Pages 138-149.

SAFETY GUIDELINES

General Safety Guidelines

As a manufacturer of chain, Peerless Industrial Group can only control the specifications of our chain products in accordance with industry and governmental standards for chain manufacturing. It would be impossible for any warning to contain all of the possible misapplication associated with the use of Peerless Industrial Group products. Our warnings are intended to identify only those risks which are most common. The responsibility and understanding of the proper safe use and application of the products in our catalog ultimately rest with the end user. We are not responsible for the end user's assembly which our products may be used. Failure of the product can occur due to misapplication, abuse, intentional alteration or improper maintenance. Product failure can result in property damage, personal injury or death.

Working Load Limit (WLL)

The "Working Load Limit" (rated capacity) is the maximum load, which at any time or under any condition should ever be applied to chain or sling components when the load is evenly applied in direct tension to an undamaged straight length of chain, strap or fittings.

The following factors or abuses will lessen the load that the chain assembly will withstand and should be avoided:

- Tip loading of hooks
- Twisting of the chain
- Disfigurement
- Deterioration of chain or component by wear, usage or corrosion.
- Jerking or the sudden impact of a load multiplies the stress on the chain very rapidly.
- Use other than that for which the chain or components was intended.

CAUTION: Chain and component assemblies should be rated according to the working load limit of the weakest component. Care should be taken to select attachments of the same type, grade, size and working load limit as the chain.

Proof Test

The "Proof Test" (manufacturing test force) is a term designating the minimum tensile force which has been applied to a chain under constantly increasing force in direct tension during the manufacturing process. These loads are manufacturing integrity tests and shall not be used as criteria for service or design purposes.

Minimum Breaking Force

The "Minimum Breaking Force" is the minimum force at which the chain during manufacture has been found by testing to break when a constantly increasing force is applied in direct tension. Breaking force values are not guarantees that all chain segments will endure these loads. This test is a manufacturer's attribute acceptance test and shall not be used as a criteria for service or design purposes.

It is very important to know that the Working Load Limit and all other associated safety factor of each Peerless product may be affected by wear, misuse, overloading, corrosion, deformation, intentional alteration and other use conditions. Regular inspection should be performed per OSHA 1910.184 and any chain sling with visible deformation or degeneration should be removed from service. The terms "Working Load Limit", "Proof Test" and "Minimum Breaking Force" contain no implication of what load the chain will withstand if the chain is used in such conditions of abuse and misuse. Peerless Industrial Group accepts no liability for abuse or misuse of their products.

All Working Load Limits (WLL) shown in this catalog apply only to new or "like new" condition products

PEERLESS INDUSTRIAL GROUP PRODUCTS ARE INTENDED TO BE USED AT OR BELOW THE MAXIMUM WORKING LOAD LIMITS SPECIFIED IN CONSTANTLY INCREASING FORCE APPLICATIONS UNDER DIRECT TENSION OR IN A STRAIGHT LINE PULL.

SHOCK LOADING IS PROHIBITED, AND SIDE LOADING MUST BE AVOIDED AS IT EXERTS ADDITIONAL DYNAMIC FORCES ON THE LOAD, WHICH THE PRODUCT IS NOT DESIGNED TO ACCOMMODATE.

All chains and attachments in this catalog are capable of creating sparks unless otherwise noted

Any welding of Peerless Industrial Group load support parts or products can be hazardous. Knowledge of materials, heat treatment and welding procedures are necessary for proper welding.

CONSULT PEERLESS INDUSTRIAL GROUP FOR ADDITIONAL INFORMATION OR QUESTIONS REGARDING THE USE AND APPLICATION OF THE PRODUCTS COVERED IN THIS CATALOG.

Regarding CHAIN:

"Physics" of a chain link. Chain link stress:

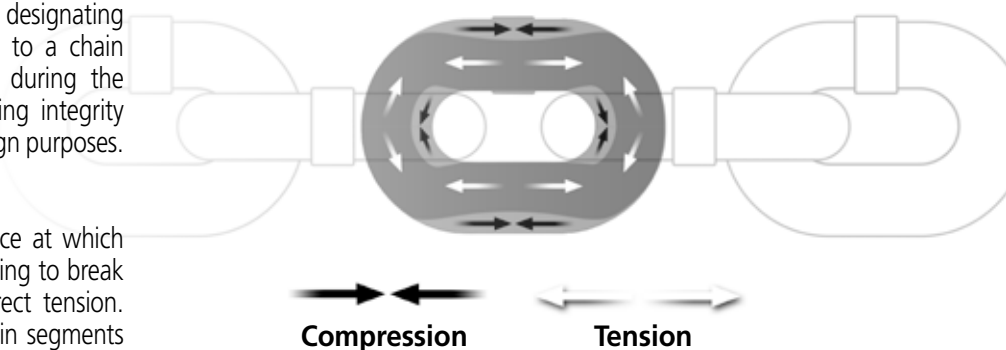

Types of Chain:

Welded		Weldless
Grade 100 (G100) Alloy Chain	Trawl Door Chain	Twin Loop Chain
Grade 80 (G80) Alloy Chain	Scallop Sweep Chain	Brass Plumber Chain
Grade 70 (G70) Transport Chain	Straight Link Coil Chain	Jack Chain
Grade 70 (G70) ISO Chain	Twist Link Coil Chain	Sash Chain
Grade 43 (G43) High Test Chain	Straight Link Machine Chain	Lock Link Chain
Grade 43 (G43) High Test ISO Chain	Twist Link Machine Chain	Plastic Chain
Grade 30 (G30) Proof Coil Chain	Passing Link Chain	Décor Chain
Grade 30 (G30) Proof Coil ISO Chain	Spinning & Cathead Chain	---
Stainless Steel Chain	Debarking Chain	---
BBB Chain	Logging Chain	---
Mooring Chain	Hand Brake Rail Chain	---
Deck Lashing Chain	Magnet Chain	---
Tuna Chain	Studio Chain	---
Trawllex Chain	Theatrical Rigging Alloy Chain	---

How to Measure Chain:

In this catalog, all dimensions shown are nominal and all weights are approximate. See individual pages for Working Load Limits.

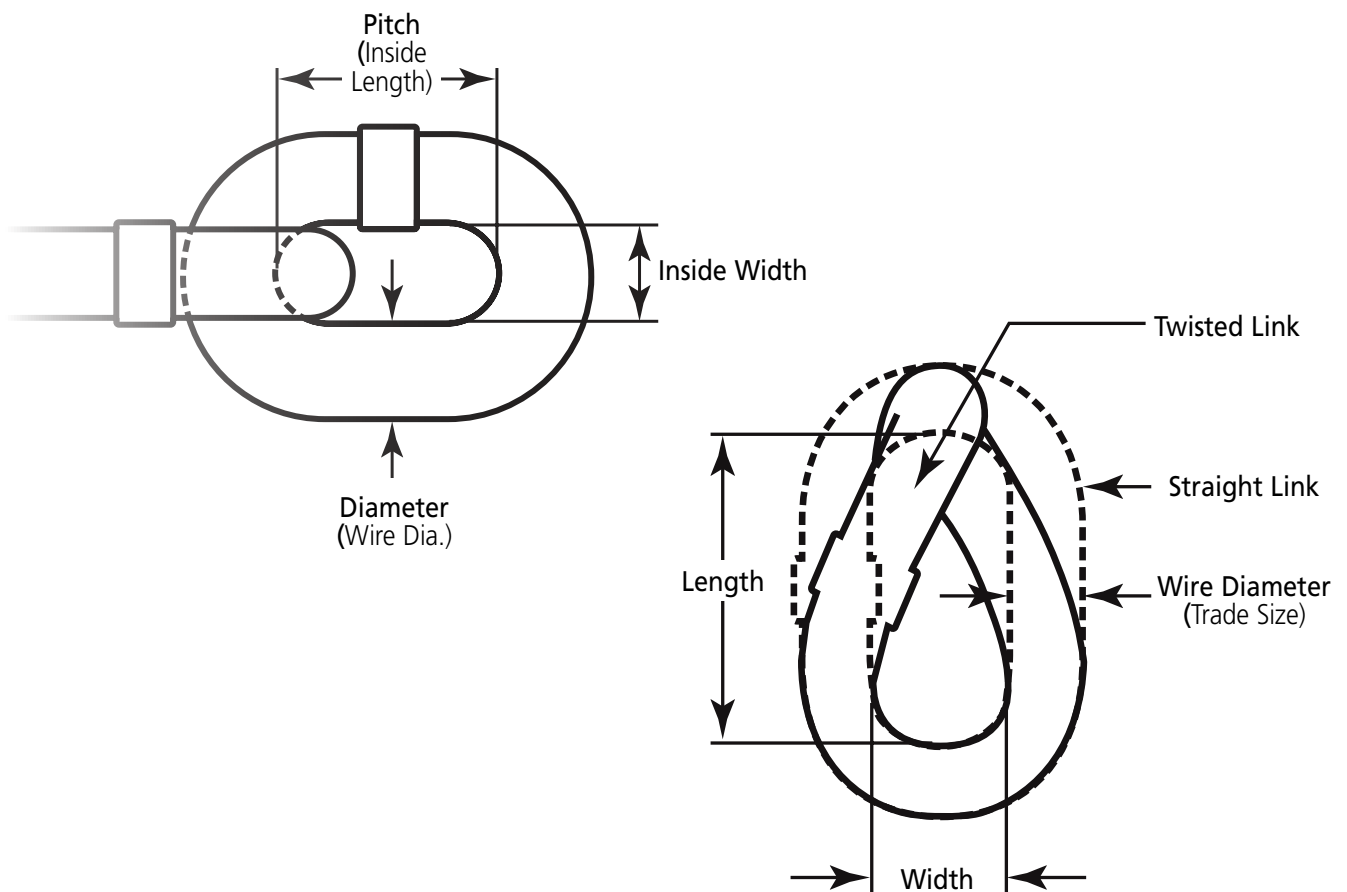

SAFETY GUIDELINES

Temperature & Chain Guidelines

“Hot Dip Galvanizing exposes chain to elevated temperatures which results in reduced working load limits for heat treated chains. Grade 70 chain working load limit is reduced by 10%, grade 80 chain is reduced by 20% and grade 100 chain is reduced by 30%. All users must be notified of this reduction in working load limits”

Use of Grade 80 Chain Under Heat Conditions

Effect of Elevated Temperature on the Working Load Limit of Grade 80 Alloy Chain.

Chains should not be used outside of the -40° F to 1000° F (-40° C to 538° C) temperature range without consulting the chain manufacturer. The specific working load limit reductions for Grade 80 chains used at and after exposure to elevated temperatures have been established and are shown below.

Grade 80 Heat Conditions		
Maximum Temperature of Chain	Reduction of Working Load Limit While At Temperature	Reduction of Working Load Limit After Exposure to Temperature
Below 400°	None	None
400°	10%	None
500°	15%	None
600°	20%	5%
700°	30%	10%
800°	40%	15%
900°	50%	20%
1000°	60%	25%
Over 1000°	* (see below)	* (see below)

*** OSHA 1910.184 requires all slings exposed to temperatures over 1000° F to be removed from service.**

Use of Grade 100 Chain Under Heat Conditions

Effect of Elevated Temperature on the Working Load Limit of Grade 100 Alloy Chain.

Chains should not be used outside of the -40° F to 1000° F (-40° C to 538° C) temperature range without consulting the chain manufacturer. The specific working load limit reductions for Grade 100 chains used at and after exposure to elevated temperatures have been established and are shown below.

Grade 100 Heat Conditions		
Maximum Temperature of Chain	Reduction of Working Load Limit While At Temperature	Reduction of Working Load Limit After Exposure to Temperature
Below 400°	None	None
400°	15%	None
500°	25%	5%
600°	30%	15%
700°	40%	20%
800°	50%	25%
900°	60%	30%
1000°	70%	35%
Over 1000°	* (see below)	* (see below)

*** OSHA 1910.184 requires all slings exposed to temperatures over 1000° F to be removed from service.**

CONDITIONS INVOLVING THE USE OF CHAIN IN CERTAIN ENVIRONMENTAL SITUATIONS SUCH AS UNUSUAL (HIGH OR LOW) TEMPERATURE, EXPOSURE TO CHEMICALS INCLUDING ACIDS AND/OR CORROSIVE LIQUIDS CAN CAUSE CHANGES IN CHAIN PERFORMANCE (REDUCING PERFORMANCE).

Table of Wear

All chain should be removed from service if, at any location on the chain, the material thickness is less than the minimum thickness.

Minimum Allowable Chain Link Thickness at Any Point			
Nominal Chain Size		Minimum Thickness	
(in.)	(mm)	(in.)	(mm)
7/32	5.5	0.19	4.8
9/32	7	0.24	6.07
5/16	8	0.27	6.93
3/8	10	0.34	8.69
1/2	13	0.44	11.26
5/8	16	0.55	13.87
3/4	20	0.69	17.45
7/8	22	0.75	19.05
1	26	0.89	22.53
1-1/4	32	1.09	27.71

Refer to ASME B30.9

Regarding Slings:

The Working Load Limit of a sling or assembly must not exceed the lowest Working Load Limit of the components in the sling or assembly. Use only Peerless Industrial Group approved parts as replacements when servicing or repairing original Peerless Industrial Group slings or assemblies.

USE ONLY GRADE 80 OR GRADE 100 ALLOY CHAIN AND ATTACHMENTS FOR OVERHEAD LIFTING

Please refer to the Overhead Lifting section for more information regarding alloy chain Working Load Limits in relation to the angle of lift.

For more comprehensive use and safety information regarding Chain Slings, please see the Peerless Chain Sling User's Manual publication 10.20.

Sling Angle Factor Chart	
Sling (Horizontal) Angle	Load Angle Factor
90	1.000
85	1.004
80	1.015
75	1.035
70	1.064
65	1.104
60	1.155
55	1.211
50	1.305
45	1.414
40	1.555
35	1.742
30	2.000
25	2.364
20	2.924
15	3.861
10	5.747
5	11.490

Sling Angles

60° provides excellent load control with minimal mechanical force applied to sling. Use caution over 60° as the load can become unstable with multiple slings depending on load and hitch.

Most desirable Angles are **90°**, **60°**, **45°** and **30°**. Use caution with all other angles.

AVOID RIGGING TO ANGLES LESS THAN 30°

- Determine sling angle
- Locate angle on chart
- Use corresponding Angle Factor
- Multiply Angle Factor by weight carried in leg
- Never go below 30°

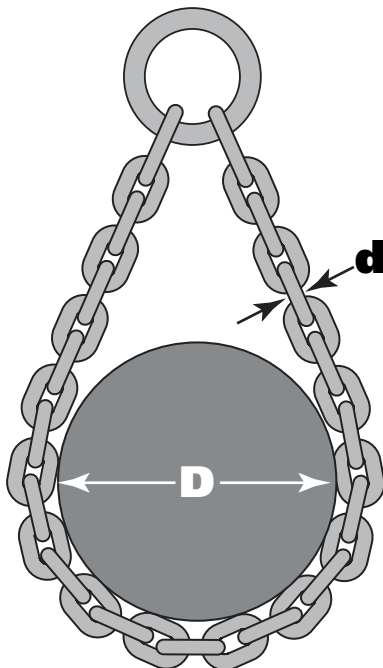

D/d De-rating Recommendations of Basket Hitch according to the Rigging Institute, LLC

Slings & D/d Ratio – Alloy Chain Slings

D/d ratio is the diameter of curvature around which a sling is bent affecting its capacity. The upper case 'D' refers to the diameter of the object to which the sling hitch is applied, and the lower case 'd' represents the diameter of the chain link of the sling.

Alloy Chain D/d Ratio Efficiency	
D/d Ratio	% of Rated Capacity
Less than 2	Not Recommended
2	60
3	70
4	80
5	90
6 and Greater	100

Chain & Sling Guidelines

Check #1 Inspections

Visually examine the sling before each use. Look for stretched, gouged, bent or worn links and components, including hooks, with open throats, cracks or distortion, if damaged, remove from service.



BENT



GOUGED

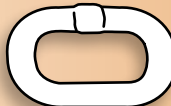

STRECHED



WORN

Check #2 Balance

Know the load — determine the weight, center of gravity, angle of lift and select the proper size of sling.



Check #3 Overload

Never overload the sling — check the working load limit on the identification tag. Always consider the effect of Angle of Lift — the tension on each leg of the sling is increased as the angle of lift, from horizontal, decreases. Use the chart in this catalog or in the Peerless Chain Sling User's Manual for this purpose.

Check #4 Knots, Twists & Kinks

Make sure chain is not twisted, knotted or kinked before lifting load. Slings shall not be shortened with knots, bolts or other make-shift devices.



Check #5 Sharp Edges

Protect chain with padding when lifting sharp edged loads.

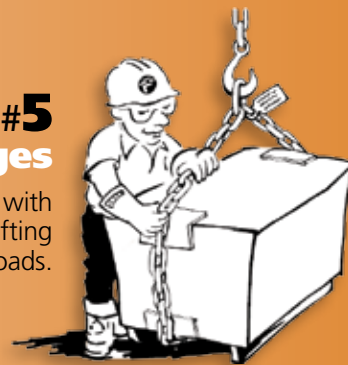

Check #6 Abrupt Movement

Lift and lower loads smoothly. Do not jerk. Shock loading is prohibited!

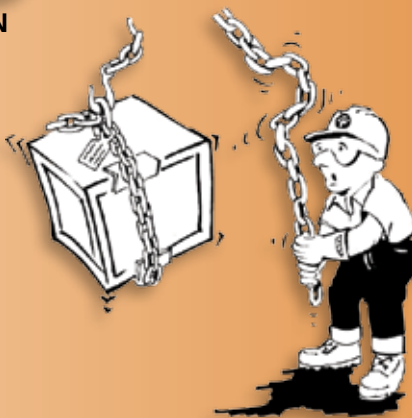

Check #7 High Temperatures

Do not expose alloy chain or sling to temperatures of 400° F (204° C) or higher. Do not drag slings on the floor.



Check #8 Chain Care

Store slings properly on an A-Frame and protect chainslings from corrosion during storage. Do not drag slings on the floor.



General Hook & Latch Guidelines

Important Safety Information - Read & Follow

- Always inspect hook & latch before using.
- Never use a latch that is distorted or bent.
- Always make sure spring will force the latch against the tip of the hook.
- Always make sure hook supports the load. Do not point load hooks—load should bear on the bowl of hook. The latch must never support the load. (See Figure 1 & 2).
- Latches are intended to retain loose sling or devices under slack conditions.
- Latches are not intended to be an anti-fouling device.

Fig.1 Right



Fig.2 Wrong

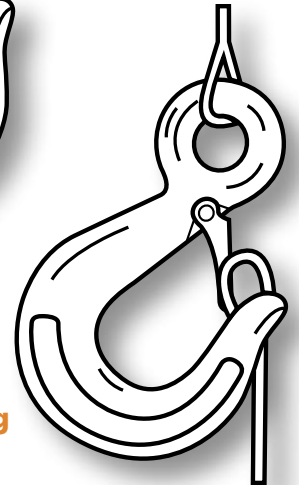

AVOID RIGGING TO ANGLES LESS THAN 30°

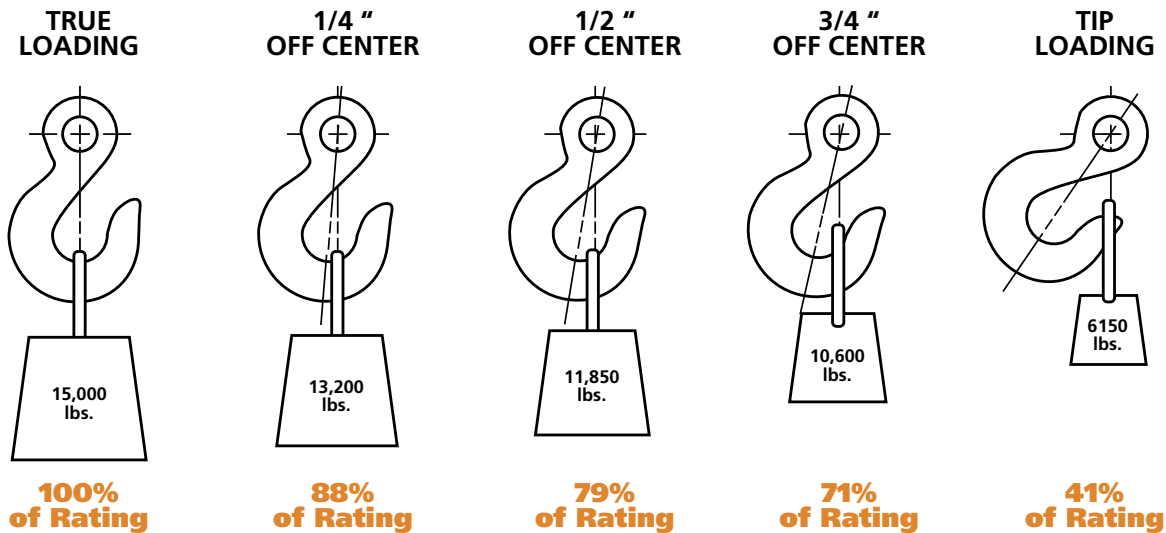

Shackle Included Angle

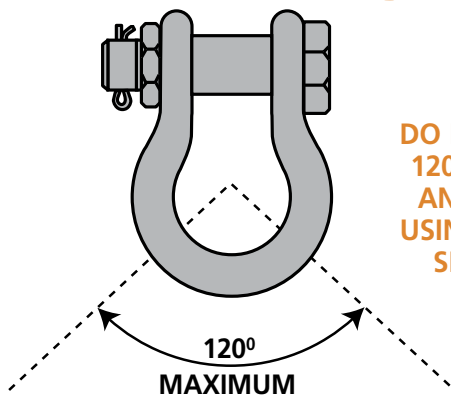

DO NOT EXCEED 120° INCLUDED ANGLE WHEN USING MULTIPLE SLING LEGS

Symmetrical Loading

Shackles symetrically loaded with two legs at a maximum angle of 120° can be used to full Working Load Limit.

Shackle Side Loading

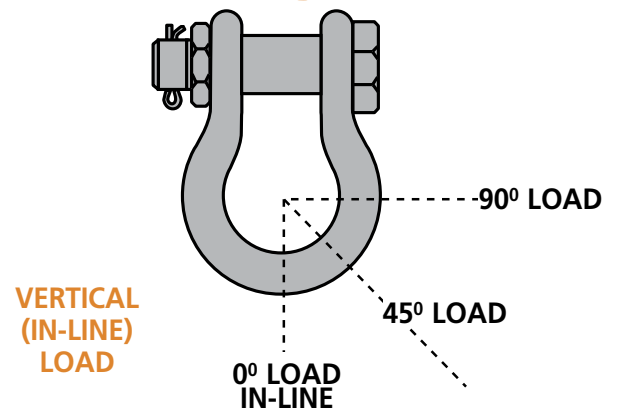

Angle of Side Load	% of Load Reduction
0° - 5° In-Line	0%
6° - 45° from In-Line	30%
46° - 90° from In-Line	50%

Do not side-load round pin shackles.

Industry Standards

The American Society of Mechanical Engineers (ASME) developed standards that apply specifically to the devices Peerless Industrial Group designs and manufacturers. These standards serve as a guide to government authorities, manufacturers, purchasers and operators of below-the-hook lifting devices.

ASME B30.20-2013

- Provides detailed information on the classifications, marking, construction, installation, inspection, testing, maintenance and operation of below-the-hook lifting devices.

ASME BTH-1-2017

- Provides detailed information on the design criteria of below-the-hook lifting devices

Markings, Identification and General Construction

The rated load of the lifting device is visibly marked on the main structure of the device, as well as on a tag attached to the lifter. If the below-the-hook lifting device consists of individually detachable lifters, then each of the individual lifters shall be marked and tagged with their individual rated loads.

All Peerless Industrial Group below-the-hook lifting devices are tagged with the following information:

- Manufacturer's name and address
- Serial number
- Lifter weight, if over 100 lbs. (45 kg)
- Cold current (amps) (when applicable)
- Rated voltage (when applicable)
- Rated load
- Manufacture date
- ASME BTH-1 Design category
- ASME BTH-1 Service class

All Peerless structural and mechanical lifting devices are designed and manufactured by qualified personnel. Peerless designs are in accordance with ASME BTH-1 and take into consideration the stresses that result from the application of the rated load along with the weight of the actual lifter and are designed to ASME BTH-1 Design Category B. Service Class is determined by taking into consideration the fatigue life criteria based on the expected number of load cycles

Design Category

Design category B shall be utilized when the size, scale, and variation of loads applied to the lifter are not always predictable or clearly defined, and where the environmental and loading conditions vary or could be severe.

Service Class

- Service Class is determined by the specified fatigue life of the lifter.
- Service Class 0 is 0 to 20,000 load cycles.
- Service Class 1 is 20,001 to 100,000 load cycles.
- Service Class 2 is 100,001 to 500,000 load cycles.
- Service Class 3 is 500,001 to 2,000,000 load cycles.
- Service Class 4 is over 2,000,000 load cycles

Service Class Life					
Cycles per Day	Desired Life (Years)				
	1	5	10	20	30
5	0	0	0	1	1
10	0	0	1	1	2
25	0	1	1	2	2
50	0	1	2	2	3
100	1	2	2	3	3
200	1	2	3	3	4
300	2	3	3	4	4
750	2	3	4	4	4
1,000	2	3	4	4	4

All welding shall be in accordance with ANSI/AWS D14.1 and ASME BTH-1

Exposed moving parts such as gears, projecting shafts and chain drives that constitute a hazard under normal operating conditions are guarded.

Electrical equipment and wiring shall comply with ANSI/NFPA 70 and ASME BTH-1.

FOR INFORMATION ON MODIFICATIONS OR REPAIRS TO YOUR LIFTING DEVICE, CONTACT PEERLESS INDUSTRIAL GROUP TO ENSURE COMPLIANCE WITH THE CURRENT ASME STANDARDS

Cont.

Industry Standards *cont.*

Proof Test

100% OF ALL PEERLESS BELOW-THE-HOOK LIFTING DEVICES ARE PROOF-TESTED TO 125% CAPACITY AND CERTIFICATES SUPPLIED AT NO ADDITIONAL CHARGE.

Requirements and Recommendations

Requirements of the ASME standard are noted by the word **shall**.

Recommendations of the ASME standard are noted by the word **should**.

Operation Practices for Lifting devices

BELOW-THE-HOOK LIFTING DEVICES SHALL ONLY BE OPERATED BY THE FOLLOWING QUALIFIED PERSONNEL:

- Personnel designated to operate the lifter.
 - Trainees who are under the direct supervision of designated personnel.
 - Personnel designated to maintenance and/or conduct testing on the lifter.
 - Personnel designated to inspect the lifter.
- The below-the-hook lifting device shall not be overloaded beyond its manufactured rated capacity nor shall it be utilized to handle any load that it was not designed to handle.
 - When rigging is utilized in conjunction with the lifter, the operator shall ensure that it is not kinked and the multiple part lines are not twisted around each other.
 - The operator shall ensure that the load is correctly distributed for the lifter prior to the lift.
 - The operator shall ensure that the temperature of the load does not exceed the maximum allowable limits of the lifting device.
 - The operator shall ensure that the lifter is moved into place over the load in such a way as to minimize swinging.
 - The operator shall ensure that sudden acceleration or deceleration of the load is prevented.

- The operator shall ensure that the lifter and the load do not come into contact with any obstruction.
- The operator shall ensure that the load is not transported over people.
- The operator shall ensure that the lifter is not utilized for side pulls or sliding the load unless explicitly authorized by a qualified person.
- The operator shall ensure that suspended loads are not left unattended.

Miscellaneous Operating Practices

- An operator shall not utilize a below-the-hook lifter that has an "out of service" tag or has been designated as non-functioning.
- Only authorized personnel shall be given the authority to remove "Out of service" tags on lifting devices.
- When not in use the below-the-hook device should be stored in an assigned location.
- Lifter markings and tags shall not be removed or damaged. Lifter markings and tags that are missing or illegible shall be replaced.

SAFETY GUIDELINES

Inspection

Initial inspection:

Prior to initial use, all new, altered, modified, or repaired lifting devices shall be inspected by a designated person to ensure compliance with the provisions of the ASME B30.20 standard.

Inspection intervals:

Below-the-hook lifters in regular service require three general types of inspection classification procedures; every lift, frequent, and periodic. The intervals for inspection are determinant upon the severity of use of the below-the-hook device, the extent of the exposure to wear and tear, as well as any history of malfunction experienced by the lifter.

Every lift inspection:

A visual examination performed by the operator of the below-the-hook lifter conducted prior to and during every lift.

Frequent inspections:

Are comprised of visual inspections performed by either the lifter operator or other assigned personnel (records are not required by the ASME standard).

- Normal use – once a month
- Heavy use – once a week to once a monthly
- Severe use – once a day to once a week
- Special or infrequent use – outlined as specified by a qualified individual prior to and following each use.
The following items listed below shall be included within the regular inspection schedule and shall be thoroughly inspected and an assessment formed as to the extent of the issue and the level of subsequent hazard resulting from it.

- Structural deformation
- Cracks in welds or structural members
- Excessive wear
- Loose or missing parts, tags, safety guards, fasteners, stops, and/or housings.
- Out of adjustment conditions that interfere with the normal operation and functionality of all mechanisms including automatic hold and release components.
- Contact Peerless Industrial Group for replacements of missing identification tags and nameplates

Periodic inspections:

Are comprised of visual inspections performed by assigned personnel who record the current condition of the below-the-hook lifter in order to provide the basis for a continuing program of recorded evaluation. In lieu of records, a visible inspection mark placed on the lifter is acceptable

- Normal use – annual inspection typically performed on-site.
- Heavy use – disassembly by a qualified individual should be performed semi-annually in order to facilitate a detailed inspection.
- Special or infrequent use – outlined as specified by a qualified individual prior to and following each use

Below-the-hook lifting devices shall undergo a thorough inspection based upon the previously defined intervals of every lift, frequent, and periodic. Any and all issues such as the following (as listed below) shall be investigated and a conclusion made as to if the extent of the issue and to if it is severe enough in its nature to represent a hazard.

- All requirements outlined within the frequent inspection process.
- Missing or loose nuts, bolts, or fasteners.
- Fractured gears, pulleys, sheaves, sprockets, bearings, chain and belts.
- Excessive wear of linkages, gears, pulleys, sprockets, sheaves, chain, belts, bearings, hardware, and other mechanical parts.
- Excessive wear at the bail or other load bearing points.

Maintenance

Preventive maintenance:

A preventive maintenance program shall be established and be based on recommendations made by Peerless Industrial Group. It can be determined to be appropriate as designated by a qualified person to add to the maintenance program following a review of the use of the below-the-hook lifter.

Any hazards disclosed during an inspection shall be corrected before the lifting device is put back into service. Any repairs and/or adjustments shall be done only under the direction of or by a qualified person.

Replacement parts shall be equivalent to the Peerless Industrial Group's specifications.

For more information or to purchase a copy of the standard, visit ASME website, www.ASME.org.

All Cargo Control Products

WARNING: Observe all tie down requirements of the Commercial Vehicle Safety Alliance (CVSA.), Federal Department of Transportation (DOT), CCMTA (Canadian Council of Motor Transport Administrators) or other local regulations governing cargo restraint and tie down. Use only products that are rated and/or identified with working load limits (WLL) for cargo tie down applications.

SAFE USE: Inspect all tie down components prior to each use. Never use items that are damaged, worn or defective. Remove them from service immediately and replace with new. Do not attempt to repair. The following conditions constitute a damaged tie down strap: acid or caustic burns, melting of any part of the web surface, broken or worn stitching, distortion of eyes or fittings, or web snags, cuts, tears, and punctures. Only tie down straps with legible identification tags should be used. Keep all tags and labels away from the load, vehicle body and winch to avoid tag damage rendering the tag non-readable and the strap assembly therefore unusable. The following conditions constitute a damaged tie down chain assembly: damaged or distorted links, distortion of eyes or hooks, nicks or gouges in the chain or hooks. If in doubt about the safety of a tie down component or assembly do not use it. Loadbinders should not be used if any of the previous conditions exist or if the handles are bent or distorted.

WINCHES

INSTALLATION: Mount & position the winch so that the latch/pawl drops into the gear sprocket teeth by its own weight. Portable and slider winches must be positioned not to interfere with any other trailer components.

MAINTENANCE: The winch assembly should be protected from corrosion by application of a rust inhibiting paint. Avoid paint build up in the latch/pawl area that may inhibit the free movement of its parts. A light oil should be used to keep these parts moving freely to insure safe operation.

PROPER USE: The loose end of the web assembly should be inserted through the web slot in the winch mandrel and the excess web pulled through. After tensioning, there must be 2-3 full wraps of webbing around the mandrel. Less wraps may result in web slippage. More wraps will cause additional strain to be exerted on the winch assembly and reduce the load capacity of the winch. Cable/wire rope must be used only on winches designed for their use. To use, twist an eye on the end of the cable with at least

2 feet of loose tail. Place the eye over the cable pin on the winch mandrel and tighten the winch, wrapping the cable over the loose tail a minimum of 4 times to secure the cable from slippage.

CAUTION: Inspect all strap and winch assembly components prior to each use for damage or deterioration. Remove damaged product from service immediately and replace. Do not attempt to repair. Use extreme caution when tensioning the winch assembly to assure the latch/pawl is fully engaged in the gear sprocket teeth before releasing the pressure on the winch bar. Always keep hands and fingers away from the winch pawl. Always make sure that the load is adequately secured prior to movement of the vehicle using a sufficient quantity of appropriate strength tie downs. Never exceed the Working Load Limit of either the tie down or the hardware/winch. Remember, all assemblies are only as strong as their weakest point, including the point of attachment. All component parts must meet or exceed CVSA guidelines, Federal DOT Regulation, CCMTA regulations as well as local regulations. Tie downs must be checked periodically during transit and re-tensioned as needed to maintain a secure load. Never modify a winch to perform any use other than that for which it was specifically designed. Misuse or modification of any type will result in voiding any or all of the warranty and liability by the manufacturer/seller.

WINCH BARS

PROPER USE: Use extreme caution when tensioning the winch/assembly to assure the latch/pawl is fully engaged in the gear sprocket teeth before releasing the pressure on the winch bar. Always keep hands and fingers away from the winch pawl & keep face, head and body out of path of winch bar.

Inspect all binding components, (winch, strap assembly, chain assembly, loadbinder) prior to each use. Never use damaged or worn equipment. Remove from service and replace with new. Do not attempt to repair. Winch bars are used entirely at the users own risk and the use of a winch bar demonstrates an understanding of the risks and a willingness to accept the consequences of possible property damage, serious personal injury and/or loss of life. When using winch bars with winches: the tapered point of the bar must be inserted completely through both holes in the winch cap. Failure to insert bar correctly could cause the bar to slip and result in serious personal injury and/or loss

cont.

SAFETY GUIDELINES

All Cargo Control Products cont.

WINCH BARS cont.

of life. During tightening and before releasing the tie down assembly, check the winch pawl to insure it has properly engaged the gear sprocket. Always grip the winch bar at the knurled section of the bar for increased safety.

When using winch bar with binders: only use combination winch bars designed with a binder cradle to assist in tightening a loadbinder. Insure that the loadbinder handle is fully inserted into the winch bar cradle and locked in place. Keep head and body out of the path of the loadbinder handle in case of slippage or kickback. Failure to do so may result in serious personal injury and/or loss of life.

TOW STRAPS & CHAINS

DANGER: PLEASE READ AND UNDERSTAND ALL OF THESE INSTRUCTIONS PRIOR TO USING ANY Tow Chain or Tow Strap. Towing or recovery of a vehicle presents a very real danger of property damage, serious personal injury and/or loss of life. Never attach fittings that have a strength rating (WLL) less than the assembly to which they are being attached. Insure that the chain or strap is attached to a secure part on both vehicles capable of withstanding the forces involved in towing or recovery. Woven fabric straps store energy that when released could cause a whipping action and endanger operators and bystanders. Keep all persons away from the vehicles and strap or chain during towing or recovery. USE OF THESE PRODUCTS DEMONSTRATES AN UNDERSTANDING OF THESE WARNINGS AND THE RISKS INVOLVED.

PROPER USE: Tow chains and tow straps are designed for general purpose towing and recovery only. They are not intended to be used for highway towing or for extended periods of time. In these cases, a tow bar is required for safe operation. Tow chains/straps should never be used in a manner where failure of either the chain/strap, attachments or vehicle anchor points could result in personal injury. Keep all persons a safe distance away from all vehicles during a tow or recovery operation.

The Working Load Limit shown in this catalog or on the package or assembly should never be exceeded. This is the maximum safe load that the assembly should ever be exposed to when in a like new condition. Apply tension in a gradual and

uniform manner to avoid shock loading the assembly which could cause failure. Be sure that the assembly is not twisted, kinked, or knotted. Never subject the chain or strap to sharp edges as these can damage the chain or even cut the strap. If unavoidable, use caution and pad the area with rubber or similar material (a cut section of tire can be used for this purpose). Inspect all assemblies and attachments prior to use for any visible signs of damage.

The following will reduce the Working Load Limit of the assembly: a.) Tip loading of hooks, twisting, kinks, knots or improper attachments; b.) Deterioration of the assembly or attachments caused by wear, usage, UV degradation, chemicals, acids, corrosion, cuts, abrasions, high heat exposure, misuse or abuse; c.) Impact caused by jerking or snatching. After use, inspect assembly and attachments for any visible signs of damage prior to storage. Clean and store in a cool and dry place, out of direct sunlight, where damage to the assembly or attachments is not likely to occur.

CARGO BARS & LOADLOCKS

WARNING: Failure to understand these instructions and warnings could cause serious personal injury or property damage. Use of these products demonstrates an understanding of these warnings/instructions and the risks involved. Do not use bars to support ANY vertical loads. SmartBars™ and loadlocks are NOT designed to be used as a shoring beam. Using these bars as a step is not advised and could result in serious personal injury. Cargo bars and loadlocks are not designed to secure cargo inside a trailer, only to assist in the stability of a load. SmartBars™ and loadlocks are designed to push out approximately one inch against flexible van trailer walls and can be damaged if used against immovable objects such as door frames. To avoid damaging the bars and trailer, never use more than one hand to close the lever. On the SmartBar™ push handle release button when fully retracted to extend. A stop keeps the bar from sliding open when fully retracted and must be released before operating the lever or the bar can be damaged. To disengage lock, push on handle release tabs.

Trailer Safety Chain Guidelines

Trailer Safety Chains as defined in SAE standard J684 of May, 2014 for trailer couplings, hitches and safety chains - AUTOMOTIVE TYPE:

7.1 Definitions and Purpose - "Safety Chain" is defined as an assembly which provides a secondary means of connection between the rear of the towing vehicle and the front of the trailer (or towed vehicle); it includes link chain and all attaching means. The purpose of Safety Chain is to retain connection between the towing vehicle and trailer in the event of separation of the trailer coupling from the ball or the ball from the hitch, long enough to bring the vehicles to a stop. It should not be construed that safety chains can ensure that vehicle control or connection will be maintained in the event of vehicle incidents such as loss of control, rollover, jackknife, collision, etc.

For the purpose of this section:

A. The "hitch" assembly (including ball and ball support platform) is considered part of the towing vehicle.

B. The "safety chain" is considered part of the trailer.

C. "Attaching means" are defined as the hooks, bolts, anchorages, or other devices used to fasten or connect link chain, or its equivalent, to the trailer tongue and to the rear of the towing vehicle including hitch assembly devices provided for such connection.

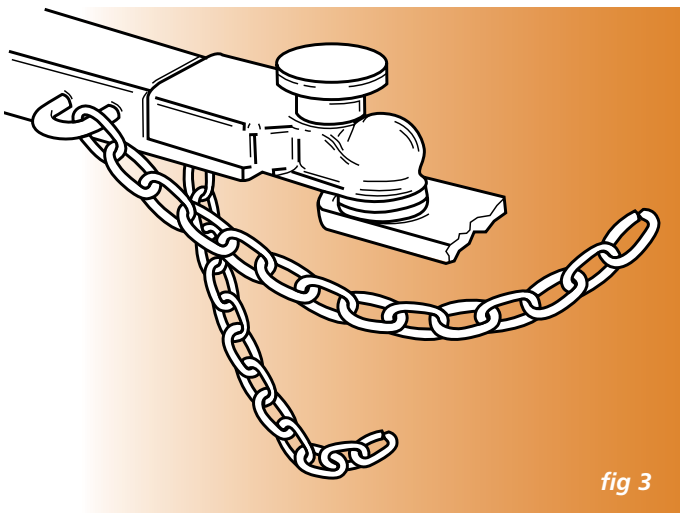

7.2 Strength Requirements - Each individual safety chain, and all attaching means, shall meet the minimum breaking force tensile load as indicated in Table 4 (each chain and attachment INDEPENDANTLY, NOT COMBINED), and where applicable such load shall be applied in a direction parallel to the trailer's or towing vehicle's longitudinal axis. Any operation performed on the safety chain subsequent to its manufacture shall not reduce its strength below the requirements of Table 4.

Strength Requirements for Safety Chain & Attaching Means*	
Safety Chain or Trailer Classification	Breaking Force - Minimum
Class 1	2000 lbs. (8.9 kN)
Class 2	3500 lbs. (15.6 kN)
Class 3	5000 lbs. (22.2 kN)

Class 4 - The strength rating of each length of safety chain or its equivalent and its attachments shall be equal to or exceed in minimum breaking force the GVWR of the trailer.
 * When conducting a tensile strength test of a length of chain or equivalent and its attaching means, when the minimum load specified in Table 4 is applied, such load shall be maintained for a minimum of 1 minute.

Table 4

7.5 Installation

7.5.1 Two safety chains shall be permanently fastened (i.e., bolted, anchored) to the trailer tongue, one on each side. The safety chains shall be connected from the trailer tongue to the hitch assembly or to other towing vehicle members meeting the strength requirements of 7.2.

7.5.2 Safety chain shall be connected to the towing vehicle and trailer so the slack of each length of chain is approximately the same when the vehicles are aligned on a common front to rear centerline. There shall be no more slack than necessary to permit proper turning of the vehicles. The safety chain shall be crossed under the trailer tongue and connected to the hitch assembly or to other towing vehicle members.

NOTE: Crossing the chains under the tongue typically reduces the probability of stressing or breaking the chains when turning. See Figure 3.

7.5.3 Safety chains shall not be attached to the towing vehicle by use of the fasteners that secure the ball to its supporting hitch member, nor shall they be connected directly to any part of the ball.

How to Chose a Safety Chain to Correctly Handle the Load				
Class Designation >>>	CLASS I	CLASS II	CLASS III	CLASS IV
Maximum Load Capacity:	Up to 2,000 lbs. gross trailer wt.	Up to 3,500 lbs. gross trailer wt.	Up to 5,000 lbs. gross trailer wt.	Up to 10,000 lbs. gross trailer wt.
	Up to 200 lbs. gross tongue wt.	Up to 300 lbs. gross tongue wt.	Up to 500 lbs. gross tongue wt.	Up to 1,000 lbs. gross tongue wt.

INDEX

A	ACCOLY®-KUPLEX® COMPONENT REFERENCE	16	ACCOLY® STANDARD MAGNET CHAINS	14	ACCOLY® STEADY-LIFT MAGNETIC CHAINS	14	REPLACEMENT PARTS	14	AG TRAILER CHAIN	77	ALLOY CHAIN	5-6	ALLOY ACCESSORIES	18-33, 36-39	FOUNDRY HOOKS	30-31	GRAB HOOKS	28-29	J-HOOKS	38	OBLONG MASTER LINKS	18-20	PEAR SHAPE MASTER LINKS	21	PEERLESS ROUND RINGS	29	PLATE HOOKS	31	S-HOOKS	38	SELF-LOCKING HOOKS	31-33	SHACKLES	36-37	SLING HOOKS	26-27	SORTING HOOKS	39	SUB-ASSEMBLIES	22-23	SWIVEL HOOKS	33	V-NOTCHED COUPLING LINKS	21	ANCHOR LEAD CHAIN	130	ANCHOR ROAD SWIVEL	131	ANCHOR SHACKLES	133	ANCHOR SWIVELS	131	ANTI-THEFT CHAIN & PADLOCKS	122																										
B	BBB CHAIN	127	BINDER CHAIN & LOADBINDER DISPLAY	111	BINDER CHAIN ASSEMBLIES	58-60	BOAT TRAILER WINCHES	69	BOATMAN'S PRIDE ANCHOR LEAD CHAIN	130	BRASS PLUMBERS CHAIN	93	BULK STRAP HARDWARE	70	BUOY CHAIN	134																																																																
C	CABLE PULLERS	75	CARGO BARS	78-80	CARGO CONTROL PRODUCTS	55-80	CARGOGUARD™	72	CHAIN	122	ANTI-THEFT	85-88, 126, 129	GRADE 30	82-84, 125, 128	GRADE 70	56-57, 124	GRADE 80	6	GRADE 100	5	OTHER WELDED	89-92	WELDLESS	93-96	STAINLESS (GRADE 50)	40	PLASTIC	96	CHAIN & FITTING DISPLAY	112-114	CHAIN SLING INFORMATION	7-13	CLEVIS SLIP HOOKS	100-101	COIL LIFTERS	50-51	CGV	50	CL	50	CLCS	50	CLNC	50	CLSC	50	CLT	51	CLV	50	CLVW	50	NACL	51	COIL RACKS	80	COLD SHUTS	104	CONNECTING LINKS	104	CORDAGE	115	COUPLING LINKS	25	KUPLEX® KUPLOK®	25	PEER-LIFT® MECHANICAL	25	V10™ ALLOY	25	CUSTOM LIFTING PRODUCTS	45-54	CUTTERS - BOLT, CABLE, CHAIN & WIRE	121						
D	DECK LASHING CHAIN	134	DECORATIVE CHAIN	95	DISPLAY RACKS	111-114	DOUBLE CLEVIS LINK	100, 102																																																																								
E	EYE SLIP HOOKS	102																																																																														
F	FORGED WIRE ROPE CLIPS	118	FORK TRUCK ACCESSORIES	53-54	FH	53	FHB	54	FHBD	54	TB	53	TBP	53	FOUNDRY HOOKS	30-31																																																																
G	GALVANIZED WIRE ROPE	116	GRABBAR® & PARTS	79	GRAB HOOKS	28-29	ACCOLY® EYE GRAB HOOK	28	G43 CLEVIS GRAB	101	G43 EYE GRAB HOOK	101	KUPLEX® CLEVIS TYPE GRAB HOOK	29	PEER-LIFT® CLEVIS CRADLE GRAB HOOK	29	PEER-LIFT® EYE CRADLE GRAB HOOK	28	V10™ CLEVIS SHORTENING GRAB HOOK	29	V10™ CLEVIS SHORTENING GRAB HOOK w/RETAINER	29	V10™ EYE GRAB HOOK w/ CLEVIS ATTACHEMENT	28	V10™ EYE SHORTENING GRAB HOOK	28	GRADE 30 PROOF COIL CHAIN	85-88, 126, 129	GRADE 30 BBB CHAIN	127	GRADE 43 HIGH TEST CHAIN	82-84, 125, 128	GRADE 50 STAINLESS STEEL CHAIN	40	GRADE 70 ISO CHAIN	124	GRADE 70 TRANSPORT CHAIN	56-57	GRADE 80 CHAIN	6	GRADE 100 CHAIN	5																																						
H	HARDWARE CHAIN & CHAIN ACCESSORIES	81-114	HITCH PIN (HAIR PIN) CLIPS	105	HIGH TEST GRADE 43	82-84, 125, 128	HOOKS	101-102, 132	GRADE 70	99-100	ALLOY	26-33, 38-39	FOUNDRY	30-31, 39	GRAB	28-29	J-HOOKS	38	PLATE	39	S-HOOKS	38	SELF-LOCKING	32-33	SLING	26-27	SWIVEL	33	HYDRAULIC CUTTERS	121																																																		
I	I.D. TAGS FOR SLINGS	36	INSULATED SWIVEL HOOK	44	ISO CHAIN	124-126, 128-129																																																																										
J	J-HOOKS	38	JACK CHAIN	94																																																																												
K	KUPLERS	24	KUPLINKS	24	KUPLOKS	25																																																																										
L	LATCH KITS	34-35	LIFTING BEAMS	46-47	ABLB	47	ALB	46	BSLB	46	CGCLB	47	DCLB	46	DCRB	47	FPAB	47	FPLB	47	FPSL	47	LLB	47	SDLB	46	SSLB	46	TPLB	47	UNVB	46	LOAD BINDERS	61-64	LOADLOCKS	78-80	LOCK LINK CHAIN	95																																										
M	MAGNET CHAINS	14	STANDARD	14	STEADY-LIFT	14	MATERIAL HANDLING	54	MBHD	54	MSHD	54	MECHANICAL CHAIN SLINGS	8-13	MECHANICAL ADJUSTABLE DOUBLE SLINGS	12	MECHANICAL ADJUSTABLE DOUBLE LOOP SLINGS	13	MECHANICAL ADJUSTABLE SINGLE SLINGS	12	MECHANICAL ADJUSTABLE SINGLE LOOP SLINGS	13	MECHANICAL DOUBLE CHAIN SLINGS	10	MECHANICAL QUADRUPLE CHAIN SLINGS	11	MECHANICAL SINGLE CHAIN SLINGS	10	MECHANICAL TRIPLE CHAIN SLINGS	11	MALLABLE WIRE ROPE CLIPS	118																																																
MA	MARINE PRODUCTS	123-137	MOORING CHAIN	134																																																																												
O	OBLONG MASTER LINKS	18-20	ACCOLY®-KUPLEX®	20	PEERLESS FORGED	18	PEERLESS WELDED	18	V10™ ALLOY	19	OVAL CONNECTING LINKS	104, 132	OVERHEAD LIFTING	4-44																																																																		
P	PALLET LIFTERS	52-53	PL	52	PLAF	52	PLAH	52	PLHA	52	PLHD	52	PLHW	52	PLLW	53	PLWL	53	PASSING LINK CHAIN	92	PEAR SHAPED CONNECTING LINKS	21, 132	PEERLESS ALLOY ROUND RINGS	21	PEERLESS PEAR SHAPE MASTER LINKS	21	PET TIE-OUTS	95	PLATE HOOK	39	PLASTIC CHAIN & ACCESSORIES	96	PLUMBERS CHAIN	93	PULLEYS	106	PROOF COIL GRADE 30	85-88, 126, 129																																										
Q	QUICKBINDER™	62	QUICK LINKS	104, 109																																																																												
R	RATCHET STRAPS	65-69	REPAIR LAP LINKS	103	REPLACEMENT PARTS FOR ACCOLY®-KUPLEX®	35	COMPONENTS	35	REPLACEMENT PARTS FOR V10™ COMPONENTS	34	ROLL LIFTERS	49	MRL	49	RG	49	RGT	49	RLB	49	RLCH	49	ROPE	115	MANILA ROPE	115	POLY TRUCK	115	SOLID BRAIDED NYLON	115	TWISTED POLY	115	TWISTED NYLON	115	ROPE ACCESSORIES	106																																												
S	S-HOOKS	38	S-HOOKS FOR TRAILER SAFETY CHAIN	76	SAFETY GUIDELINES	138-149	SASH CHAIN	94	SCALLOP LINKS	137	SCALLOP RINGS	137	SCALLOP SWEEP CHAIN	137	SCREW EYES	106	SECUREBAR™ & PARTS	79	SELF-LOCKING HOOKS	32-33	PEER-LIFT® CLEVIS SELF-LOCKING HOOK	32	PEER-LIFT® EYE SELF-LOCKING HOOK	31	PEER-LIFT® SWIVEL SELF-LOCKING HOOK	33	V10™ CLEVIS SELF-LOCKING HOOK	32	V10™ EYE SELF-LOCKING HOOK	31	V10™ SWIVEL SELF-LOCKING HOOK	33	V10™ SWIVEL SELF-LOCKING HOOK w/BEARING	33	SHACKLES	36-37, 103, 109, 133	COMMERCIAL GRADE SCREW PIN ANCHOR SHACKLES	103	FORGED TRAWLING SHACKLES	133	PEER-LIFT® BOLT, NUT & COTTER ANCHOR SHACKLES	37	PEER-LIFT® GALVANIZED ANCHOR SHACKLES	37	PEER-LIFT® ALLOY SCREW PIN ANCHOR SHACKLES	36	MARINE	133	SCREW PIN CHAIN SHACKLES	103	STAINLESS STEEL	109	SHEET LIFTERS	51	MSLHD	51	SLHD	51	SLLD	51	SHORTENING GRAB HOOKS	28-29	SLEDGE HAMMERS	121	SLEEVES & STOPS	119	SLING HOOKS	26-27	ACCOLY® EYE SLING HOOKS	26	ACCOLY® EYE SLING HOOKS w/LATCH	26	KUPLEX® CLEVIS SLING HOOKS	27	KUPLEX® CLEVIS SLING HOOKS w/LATCH	27	PEER-LIFT® CLEVIS SLING HOOK w/LATCH	27	PEER-LIFT® EYE SLING HOOK w/LATCH	26
V	V10™ COMPONENT REFERENCE	17	V-NOTCHED COUPLING LINKS	21, 41	VAN STRAPS	69	VINYL ANCHOR LEAD CHAIN	130																																																																								
W	WEATHER PROOF LOCKS	122	WELDED CHAIN SLINGS	8-9	WELD-ON GRAB HOOK	102	WIDE JAW QUICK LINKS	104	WINCHES	70-71	WINCH BARS	72	WINCH LINE TAIL CHAIN	77	WINDLASS CHAIN	124-129	WIRE ROPE	116-117	CLIPS	118	IVRC & FIBER CORE	117	SLEEVES & STOPS	119	THIMBLES	119-120	VINYL COATED	117	WIRE ROPE CLIPS	118	WIRE & CABLE CUTTERS	121	WIRE ROPE THIMBLES	119-120																																														

PART NUMBER INDEX

2804892	115	4414840	107	4501091	117	5011414	85	5262160	58	5630648	82
2804893	115	4415140	107	4501104	116	5011433	85	5262163	58	5630847	82
2804894	115	4415240	107	4501110	116	5011434	85	5262354	58	5641384	137
2804895	115	4415340	107	4501115	116	5011613	85	5262360	58	5641484	137
2804896	115	4415440	108	4501185	116	5011614	85	5262363	58, 111	5641684	137
2804897	115	4415540	108	4501190	116	5011633	85	5262460	58	5641884	137
2804902	115	4415640	106	4501290	117	5011634	85	5262463	58	5900023	40
2804903	115	4415940	106	4501308	117	5030813	82	5301113	82	5900123	40
2804904	115	4416040	106	4501390	117	5030913	82	5301147	82	5900223	40
2805332	115	4416140	106	4503040	118	5030947	82	5340355	56	5900323	40
2805378	115	4416240	106	4503140	118	5031013	82	5340455	56	5900423	40
2871290	115	4416340	106	4503210	116	5031047	82	5351035	91	5900623	40
2871295	115	4416440	106	4503215	116	5031213	82	5360235	89	5900823	40
2880025	115	4416540	106	4503285	116	5031214	82	5361035	89	6010232	91
2880030	115	4416640	106	4503290	116	5031233	82	5362035	89	6010250	91
2880035	115	4416740	106	4503308	116	5031234	82	5362039	89	6010332	91
2880040	115	4417040	103	4503315	117	5031313	82	5364035	90	6010432	91
3440355	105	4417340	108	4503317	116	5031314	82	5365035	89	6010450	91
3440635	105	4417640	103	4503320	116	5031333	82	5367035	89	6011032	91
3440735	105	4417640	112, 113	4503340	118	5031334	82	5370135	93	6011050	91
3440835	105	4417740	103, 112, 113	4503405	116	5031413	82	5370335	93	6012032	91
3440935	105	4417840	103, 112, 113	4503440	118	5031414	82	5372035	93	6012050	91
3441135	105	4417940	103, 112, 113	4503501	116	5031433	82	5373035	93	6014032	91
3441935	105	4418040	108	4503505	116	5031434	82	5411135	85	6015032	91
3450335	105	4418638	119	4503540	118	5031613	82	5411165	85	6020232	92
3450635	105	4418685	119	4503640	118	5031614	82	5411235	85	6020332	92
3450735	105	4418738	119	4503840	118	5031633	82	5411265	85	6020432	92
3450835	105	4418785	119	4503940	118	5031634	82	5411335	85	6020450	92
3450935	105	4421040	104	4504040	118	5040353	56	5411365	85	6020532	92
3451935	105	4421140	104, 113	4505150	95	5040354	56	5411435	85	6021032	92
3501760	73, 105	4421240	104, 112, 113	4505250	95	5040853	56	5411465	85	6022032	92
4000244	112, 113, 121	4421340	104, 112, 113	4505350	95	5040854	56	5411635	85	6022050	92
4000288	114, 121	4421440	104, 112, 113	4505450	95	5041253	56	5431215	82	6024032	92
4101410	121	4421638	119	4505550	95	5041254	56	5431315	82	6040232	90
4101810	121	4423640	104	4505650	95	5041453	56	5431415	82	6040250	90
4102410	121	4424038	119	4514040	119	5041454	56	5440255	56	6040432	90
4103010	121	4424138	119	4514140	119	5041653	56	5440355	56	6040450	90
4120085	111	4424540	108	4514240	119	5041654	56	5440455	56	6041032	90
4120086	111	4424740	107	4514340	119	5050223	6	5451135	85	6041050	90
4120087	111	4424840	107	4514440	119	5050224	6	5451235	85	6042032	90
4120088	111	4425240	105, 112, 113	4514540	119	5050323	6	5451335	85	6042050	90
4120089	111	4425340	108	4520111	116	5050324	6	5453415	83	6042085	90
4120090	111	4426040	105	4520211	116	5050423	6	5454255	56	6044032	90
4200210	121	4426140	105	4520411	116	5050424	6	5454355	56	6044033	89
4200310	121	4426540	107	4528510	121	5050623	6	5454455	56	6044050	90
4200410	121	4426640	107	4528610	121	5050624	6	5510223	5	6044056	90
4200610	121	4426740	107	4528710	121	5050823	6	5510224	5	6045032	90
4410040	108	4427040	107	4528810	121	5050923	6	5510323	5	6045033	89
4410140	108	4427140	105	4528910	121	5051023	6	5510324	5	6045050	90
4410240	105, 112, 113	4428040	104	4529710	121	5051123	6	5510423	5	6047032	90
4410340	108	4428140	104	4529910	121	5051223	6	5510424	5	6047050	90
4410440	105, 112, 113	4428240	104	4530010	118	5051323	6	5510623	5	6050432	91
4410540	108	4428340	104	4530210	118	5051423	6	5510624	5	6051050	91
4410640	105	4428440	104	4530220	118	5051523	6	5510823	5	6052032	91
4410740	106	4428640	107	4530335	118	5101113	85	5510824	5	6054032	91
4410840	106	4431240	108	4530345	118	5101147	85	5510923	5	6072032	92
4410940	108	4431540	108	4530360	118	5200120	61	5511023	5	6072050	92
4411140	106	4432440	108	4540351	96	5200320	61	5511123	5	6074032	92
4411240	106	4432840	108	4540352	96	5200420	61	5511223	136	6202207	83
4411540	106	4432940	108	4540353	96	5200675	61	5591123	136	6224307	83
4411640	106	4433040	108	4540354	96	5231260	58	5591323	136	6246407	83
4411840	106	4433240	107	4831135	95	5231262	58	5591623	136	6246407	83
4412040	106	4433340	107	4837060	95	5231424	58	5591923	136	6713202	83
4412240	105	4433440	107	5010813	85	5231460	58	5592223	136	6724303	83
4412340	108	4434040	106	5010833	85	5231462	58	5610147	85	6735302	83
4412540	106	4434140	108	5010913	85	5233460	58	5610148	85	6746403	83
4412640	106	4434240	108	5010947	85	5233462	58	5610247	85	6757402	83
4412740	106	4434340	107	5011013	85	5234424	58	5610248	85	6800021	132
4412840	105, 112, 113	4435940	106	5011047	85	5234462	58	5610347	85	6800023	132
4413138	119	4437140	108	5011113	85	5239460	58	5610348	85	6800026	77
4413238	119	4442565	116	5011114	85	5239462	58	5610447	85	6800028	77
4413338	119	4442665	117	5011133	85	5261060	58	5610448	85	6800031	76
4413540	108	4500105	117	5011134	85	5261063	58	5610647	85	6800032	76
4414040	108	4500205	117	5011213	85	5261154	58	5610648	85	6800033	76
4414140	108	4500305	117	5011214	85	5261160	58	5610847	85	6800035	132
4414240	107	4500350	117	5011233	85	5261163	58	5630247	82	6807902	77
4414340	108	4500705	117	5011234	85	5261360	58	5630248	82	6840215	76
4414440	108	4500805	117	5011313	85	5261363	58, 111	5630347	82	7010132	93
4414540	108	4500905	116	5011314	85	5261460	58	5630348	82	7010150	93
4414640	108	4500990	116	5011333	85	5261463	58	5630447	82	7010232	93
		4501008	117	5011334	85	5262060	58	5630448	82	7010332	93
		4501090	116	5011434	85	5262063	58	5630647	82	7010350	93

PART NUMBER INDEX

7010432	93	8011435	102	8030135	103	8060905	103	8417900	26	8452600	23
7010450	93	8011475	102	8030225	103	8061005	103	8417980	26	8452610	22
7010532	93	8011630	102	8030235	103	8061105	103	8418100	27	8452700	23
7010550	93	8011635	102	8030325	103	8061205	103	8418200	27	8452710	22
7011032	93	8011675	102	8030335	103	8061305	103	8418280	27	8452900	25
7011050	93	8013230	101, 112, 113	8030425	103	8063005	37	8418400	27	8452999	34
7012032	93	8013235	101	8030435	103	8063105	37	8418480	27	8453000	25
7012050	93	8013330	101, 112, 113	8034225	103	8063205	37	8418600	27	8453099	34
7012080	93	8013335	101	8034235	103	8063305	37	8418680	27	8453100	25
7013032	93	8013430	101, 112, 113	8034425	103	8063405	37	8418700	27	8453180	25
7013050	93	8013435	101	8034435	103	8063505	37	8418780	27	8453199	34
7014032	93	8013630	101	8034625	103	8063605	37	8418800	27	8453210	25
7022032	95	8013635	101	8034630	103	8063705	37	8418880	27	8453280	35
7052035	93	8015266	100, 114	8040115	104	8063805	37	8418900	27	8453299	34
7500632	94	8015275	100	8040140	104	8063905	37	8418980	27	8453300	25
7500832	94	8015366	100, 114	8040215	104	8064005	37	8420100	28	8453380	25
7501032	94	8015375	100	8040235	104	8064105	37	8420200	28	8453399	34
7501232	94	8015466	100, 114	8040315	104	8064205	37	8420400	28	8453400	25
7501250	94	8015475	100	8040335	104	8064305	37	8420600	28	8453480	25
7501432	94	8015666	100	8040415	104	8064405	37	8420700	28	8453499	34
7501450	94	8015675	100	8040440	104	8064505	37	8427100	28	8453510	25
7501632	94	8015875	100	8040615	104	8065005	103	8427200	28	8453580	25
7501650	94	8016266	101, 114	8040630	104	8065105	103	8427280	28	8453589	34
7501655	94	8016275	101	8050215	104	8065205	103	8427400	28	8453610	25
7651012	93	8016366	101, 114	8050315	104	8065305	103	8427480	28	8453680	25
7651050	93	8016375	101	8050415	104	8065405	103	8427600	28	8453699	34
7652012	93	8016466	101, 114	8050615	104	8065505	103	8427680	28	8453700	25
7700832	94	8016475	101	8053755	25	8065605	103	8427700	28	8453780	25
7702532	94	8016666	101	8053855	25	8065705	103	8427780	28	8453789	34
7703532	94	8016675	101	8055435	36	8065805	103	8427810	28	8453799	34
7703550	94	8022215	99	8055535	36	8065905	103	8427880	28	8453899	34
7704032	94	8022230	99, 114	8056035	104	8066005	103	8427900	28	8477200	30
7705032	94	8022255	99	8056135	104	8066105	103	8427980	28	8477280	30
7900435	105	8022315	99	8056235	104	8153055	100	8428100	29	8477400	30
7900635	105	8022330	99, 114	8056335	104	8153155	100	8428200	29	8477480	30
7900835	105	8022355	99	8056435	104	8153255	100	8428262	34	8477600	30
7900935	105	8022415	99	8056635	104	8153355	100	8428280	29	8477680	30
7901035	105	8022430	99, 114	8057230	100, 114	8153455	100	8428400	29	8477700	30
7901435	105	8022455	99	8057235	100	8170241	131	8428462	34	8477780	30
7901735	105	8022615	99	8057430	114	8170341	131	8428480	29	8477800	30
7901835	105	8022630	99	8057435	100	8170441	131	8428610	29	8477880	30
7902735	105	8022655	99	8057530	100	8170541	131	8428662	34	8490199	34
7904335	105	8022855	99	8057630	100	8170641	131	8428680	29	8490299	34
7906335	105	8023215	101	8057635	100	8170741	131	8428710	29	8490399	34
7906635	105	8023230	101, 112, 113, 114	8058005	37, 133	8170841	131	8428762	34	8490499	34
7911035	105	8023330	101, 112, 113, 114	8058103	36	8170941	131	8428780	29	8490599	34
7949835	105	8023235	101	8058105	37, 133	8171241	131	8428810	29	8491100	33
7952635	105	8023315	101	8058203	36	8171341	131	8428862	34	8491200	33
7953235	105	8023330	101, 112, 113, 114	8058205	37, 133	8171441	131	8428880	29	8491400	33
7953935	73	8023335	101	8058303	36, 114	8171541	131	8428910	29	8491600	33
7953935	105	8023335	101	8058305	37, 133	8171641	131	8428962	34	8491700	33
7962935	105	8023415	101	8058403	36, 114	8171741	131	8428980	29	8491710	30
7983535	76	8023430	101, 112, 113, 114	8058405	37, 133	8171841	131	8429100	29	8497200	31
7983735	76	8023435	101	8058503	36, 114	8171941	131	8429105	34	8497280	31
7983935	76	8023490	102	8058505	37, 133	8330560	95	8429200	29	8497400	31
7990435	105	8023615	101	8058603	36	8370841	137	8429205	34	8497480	31
7990635	105	8023615	101	8058605	37, 133	8371241	137	8429400	29	8497600	31
7990835	105	8023630	101	8058703	36	8410077	34	8429405	34	8497680	31
7990935	105	8023635	101	8058705	37, 133	8410177	34	8429620	29	8497700	31
7991035	105	8024215	99	8058803	36	8410199	34	8429625	34	8497780	31
7991135	105	8024315	99	8058805	37, 133	8410277	34	8429720	29	8498100	32
7991435	105	8024415	99	8058903	36	8410299	34	8429725	34	8498200	32
7991735	105	8024615	99	8058905	37, 133	8410377	34	8451000	19	8498280	32
7992635	105	8024815	99	8059003	36	8410477	34	8451100	19	8498400	32
7992735	105	8025215	101	8059005	37, 133	8410499	34	8451200	19	8498480	32
7992935	105	8025230	101	8059103	36	8410577	34	8451300	19	8498600	32
7993235	105	8025235	101	8059105	37, 133	8410599	34	8451400	19	8498680	32
7993535	76	8025315	101	8059203	36	8410677	34	8451500	19	8498780	32
7993735	76	8025330	101	8059205	37, 133	8410699	34	8451600	19	8498800	32
7993935	76	8025335	101	8059305	37, 133	8410799	34	8451700	19	8499100	33
7996335	105	8025415	101	8059403	36	8410899	34	8451800	19	8499200	33
7996635	105	8025430	101	8059405	37, 133	8417100	26	8451900	19	8499280	33
7999835	105	8025435	101	8059503	36	8417200	26	8452100	23	8499400	33
8008450	99	8025615	101	8059505	37, 133	8417280	26	8452110	22	8499480	33
8008650	99	8025630	101	8060005	103	8417400	26	8452200	23	8499600	33
8011230	102	8025635	101	8060105	103	8417480	26	8452210	22	8499680	33
8011235	102	8027235	102, 112, 113, 114	8060205	103	8417600	26	8452300	23	8499700	33
8011275	102	8027435	102	8060305	103	8417680	26	8452310	22	8499780	33
8011330	102	8027435	114	8060505	103	8417700	26	8452400	23	8604229	77
8011335	102	8027635	102	8060605	103	8417780	26	8452410	22	8605182	58
8011375	102	8030125	103	8060705	103	8417800	26	8452500	23	8605310	89
8011430	102			8060805	103	8417880	26	8452510	22	8605734	77

PART NUMBER INDEX

8605739	89	401340601	125	520140992	135	598150023	24	600140431	129	CC4230	68
8605951	89	402080302	130	520141092	135	598200502	31	600140432	129	CC4527	68
8606374	89	402080402	130	520141292	135	598200503	31	600140501	129	CC4530	68
8607006	77	402080502	130	521340401	124	598250498	31	600140502	129	CC4560	68
8607187	77	406940304	130	521340501	124	598250499	31	600140601	129	CC4603	68
8607189	77	406940405	130	537101600	14	598250500	31	600140602	129	CC4605	68
8607191	77	406940506	130	537101610	14	598250501	31	601140431	129	CC4686	68
8607193	77	406980324	130	537101620	14	598300015	24	601140501	129	CC4730	68
8607195	77	406980405	130	537101630	14	598300022	20	601140601	129	CC4783	68
8607224	77	406980425	130	537102000	14	598300025	20	700140401	128	CC5010	78
8607225	77	406980506	130	537102010	14	598300030	20	700140402	128	CC5015	78
8607260	77	406980526	130	537102020	14	598300034	20	700140501	128	CC5016	78
8607617	58	410140402	127	537102030	14	598300036	20	700140502	128	CC5018	78
8607630	58	410140502	127	537301000	14	598300038	20	700140631	128	CC5019	78
8607903	77	410140602	127	537301200	14	598300047	20	700140632	128	CC5050	80
8610107	58	410140802	127	537301400	14	598300048	20	700191732	128	CC5150	80
8610115	76	411140402	127	537301600	14	598300049	20	700191733	128	CC5171	80
8610327	125	411140502	127	537302000	14	598300052	20	700191734	128	CC5172	80
8610503	58	411140602	127	550110601	136	598310006	20	701340801	128	CC5173	80
8610818	89	440242442	132	550110603	136	598350001	20	ABLB	47	CC5174	80
8610833	128	440242443	132	550110802	136	598350002	20	ALB	46	CC5175	80
8610956	76	440242445	132	550110803	136	598350003	20	ATSB	48	CC5200	79
8611255	137	440640011	131	550111002	136	598350004	20	BSLB	46	CC5212	79
8612312	134	440840403	104, 132	550111003	136	598350005	20	BTA	49	CC5225	79
8612424	77	440840503	104, 132	560141301	134	598350011	24	BTF	49	CC5238	79
8612476	137	440840603	104, 132	574280818	77	598350012	24	BXSB	48	CC5239	79
8612486	77	440840802	104, 132	574281018	77	598350013	24	CAN038	21	CC5505	72
8612535	77	440900003	36	574281218	77	598350014	24	CAN050	21	CC5506	72
8612621	122	440900009	36	574411218	77	598700077	29	CAN069	21	CC5515	72
8640210	76	460114011	90	574480818	77	598700078	29	CAN081	21	CC5516	72
8650240	76	460144003	90	574481018	77	598750072	29	CAN094	21	CC5620	72
8666230	76	460144008	90	574481424	77	598750073	29	CAN106	21	CC5626	72
8666250	76	500110401	125	574481624	77	598750075	29	CAN125	21	CC5630	72
8671115	76	500110402	125	592202051	28	598750076	29	CAN150	21	CC5634	72
8810003	18	500110501	125	592202077	28	598800084	27	CAN175	21	CC5635	72
8810005	18	500110502	125	592202078	28	598800085	27	CAN200	21	CC5642	72
8810014	18	500110631	125	592202079	28	598800180	27	CAN225	21	CC5647	80
8810015	18	500110632	125	592252072	28	598800181	27	CC1116	65	CC5649	80
8810024	18	500110701	125	592252073	28	598800182	27	CC1120	65	CC5656	72
8810025	18	500110702	125	592252075	28	598800183	27	CC1412	65	CC5680	72
8810029	18	500110801	125	592252076	28	598800184	27	CC1612	65	CC5681	72
8810030	18	500110802	125	592300180	26	598850080	27	CC1616	65	CC5682	72
8810034	18	500110902	125	592300181	26	598850081	27	CC1815	65	CC5684	72
8810035	18	500140401	125	592300182	26	598850082	27	CC1885	65	CC5695	72
8810039	18	500140402	125	592300183	26	598850083	27	CC2002	75	CC5707	69
8810040	18	500140501	125	592300184	26	598900136	35	CC2003	75	CC5725	69
250320201	95	500140502	125	592303084	26	598900137	35	CC2004	75	CC5820	71
250321001	95	500140611	136	592303085	26	598900236	35	CC2005	75	CC5822	71
250324001	95	500140612	136	592303086	26	598900237	35	CC2029	66	CC5850	70
250325001	95	500140631	125	592303088	26	598900332	35	CC2059	66	CC5854	70
400100431	126	500140632	125	592353080	26	598900333	35	CC2079	66	CC5860	70
400100432	126	500140650	134	592353081	26	598900334	35	CC2082	66	CC5864	70
400100501	126	500140701	125	592353082	26	598900335	35	CC2083	66	CC5900	71
400100502	126	500140702	125	592353083	26	598900336	35	CC2085	66	CC5906	71
400100601	126	500140801	125	592404502	30	598950132	35	CC2094	66	CC5955	71
400100602	126	500140802	125	592404503	30	598950133	35	CC2557	66	CC5965	71
400100801	126	500140812	136	592404504	30	598950134	35	CC2570	74	CC8170	73
400100802	126	500140850	134	592404505	30	598950135	35	CC2574	74	CC8173	73
400101032	126	500140902	125	592454498	30	598950232	35	CC2575	74	CC8175	73
400101232	126	500141050	134	592454499	30	598950233	35	CC2576	74	CC8178	73
400140431	126	500141052	134	592454500	30	598950234	35	CC2578	74	CC8199	73
400140432	126	500141150	134	592454501	30	598950235	35	CC2579	74	CC8409	73
400140501	126	500151002	137	594200400	25	599100026	24	CC2627	66	CC8415	73
400140502	126	500152002	137	594200601	25	599100028	24	CC2630	66	CC8421	73
400140601	126	500191733	125	594200801	25	599401201	23	CC2640	66	CC8431	73
400140602	126	500191734	125	594201001	25	599401401	23	CC2827	66	CC8441	73
400140801	126	500191735	125	594201201	25	599401601	23	CC2830	66	CC92130	70
400140802	126	500191736	125	594300403	35	599402001	23	CC3030	67	CC92132	70
400141032	126	501310401	125	594300404	35	599450401	23	CC3626	67	CGCLB	47
400141232	126	501310501	125	594300603	35	599450601	23	CC3629	67	CGV	50
400191733	127	501310601	125	594300604	35	599450801	23	CC3712	69	CL	50
400191734	127	501340401	125	594300803	35	599451001	23	CC3716	69	CLCS	50
400191735	127	501340501	125	594300804	35	599800086	27	CC3720	69	CLNC	50
400191736	127	520140401	124	594301003	35	599900402	35	CC3812	69	CLSC	50
401100431	126	520140402	124	594301004	35	599900403	35	CC3816	69	CLT	51
401100501	126	520140501	124	594301203	35	599900404	35	CC3820	69	CLV	50
401100601	126	520140502	124	594301204	35	599900405	35	CC4027	67	CLVW	50
401100801	126	520140601	124	598100024	24	599900406	35	CC4030	67	CS031	41
401140431	126	520140602	124	598100025	24	599900407	35	CC4060	67	CS038	41
401140501	126	520140692	135	598150020	24	599900408	35	CC4127	67	CS044	41
401140601	126	520140792	135	598150021	24	599900410	35	CC4130	67	CS050	41
401140801	126	520140892	135	598150022	24	599920003	36	CC4227	68	CS063	41

PART NUMBER INDEX

CS075.....41	H0116-0600.....88	H2698-0550.....96	H4345-0415.....118	H9850-9999.....113	PMA200.....21
CS088.....41	H0116-0611.....88	H2698-0552.....96	H4345-0515.....118	H9850-9999.....114	PMS038.....41
CS100.....41	H0116-0615.....88	H2698-0554.....96	H4345-0615.....118	HT4502.....75	PMS050.....41
CS125.....41	H0116-0800.....88	H2698-0555.....96	H4345-0715.....118	HT4504.....75	PMS063.....41
DCLB.....46	H0116-0811.....88	H2914-0812.....122	H4345-0815.....118	IS04000.....44	PMS075.....41
DCRB.....47	H0116-0815.....88	H3132-5205.....60	H4345-0915.....118	IS08000.....44	PMS100.....41
ECSEB.....48	H0116-0900.....88	H3132-5605.....60	H4345-1015.....118	IS12000.....44	PMS125.....41
FH.....53	H0116-0915.....88	H3140-5205.....60	H4345-1115.....118	IS20000.....44	PMS150.....41
FHB.....54	H0116-1000.....88	H3140-5605.....60	H4345-1215.....118	IS40000.....44	RGT.....49
FHBD.....54	H0116-1015.....88	H3226-5020.....59	H4345-1315.....118	JAA031.....38	RLB.....49
FPAB.....47	H0117-0300.....86	H3226-5120.....59	H4920-1200.....122	JAA038.....38	RLCH.....49
FPLB.....47	H0117-0311.....86	H3226-5220.....59, 111	H4924-1261.....122	JAA050.....38	RMA050.....21
FPSL.....47	H0117-0315.....86	H3226-5320.....59	H4925-2461.....122	JAA063.....38	RMA063.....21
FSA050.....39	H0117-0400.....86	H3226-5420.....59	H4927-2730.....122	JAA075.....38	RMA075.....21
FSA050S.....39	H0117-0411.....86	H3226-5520.....59	H4927-3030.....122	JAA088.....38	RMA088.....21
FSA063.....39	H0117-0415.....86	H3226-5580.....60	H5023-4052.....64	JAA100.....38	RMA100.....21
FSA063S.....39	H0117-0500.....86	H3226-5620.....59, 111	H5023-4152.....64, 111	JAA113.....38	RMA125.....21
FSA075.....39	H0117-0511.....86	H3226-5680.....60	H5023-4252.....64	JAA125.....38	RMA150.....21
FSA075S.....39	H0117-0515.....86	H3226-5720.....59	H5023-4452.....64	JAA175.....38	RMA175.....21
FSA081.....39	H0117-0600.....86	H3226-5820.....59	H5025-0652.....63, 111	JBA031.....38	RMA200.....21
FSA081S.....39	H0117-0611.....86	H3226-5920.....59	H5027-0352.....64	JBA038.....38	RMS038.....42
FSA100.....39	H0117-0615.....86	H3226-6020.....59	H5121-4158.....63, 111	JBA050.....38	RMS050.....42
FSA100S.....39	H0117-0800.....86	H3226-6120.....59	H5121-4258.....63	JBA063.....38	RMS063.....42
FSA113.....39	H0117-0811.....86	H3226-6220.....59	H5121-4458.....63	JBA075.....38	RMS075.....42
FSA113S.....39	H0117-0815.....86	H3240-5020.....59	H5123-4052.....63	JBA088.....38	RMS100.....42
FSA125.....39	H0210-0405.....84, 114	H3240-5120.....59	H5123-4152.....63, 111	JBA100.....38	RMS125.....42
FSA125S.....39	H0210-0411.....84	H3240-5220.....59	H5123-4252.....63, 111	JBA113.....38	RMS150.....42
FSA150.....39	H0210-0505.....84, 114	H3240-5320.....59	H5123-4452.....63	JBA125.....38	SDLB.....46
H0107-0311.....87	H0210-0511.....84	H3240-5420.....59	H5125-0658.....62, 111	JBA138.....38	SFSB.....48
H0107-0411.....87	H0210-0605.....84, 114	H3240-5520.....59	H5125-0858.....62	JCA031.....38	SFS050.....43
H0107-0511.....87	H0210-0611.....84	H3240-5580.....60	H5125-0958.....62	JCA038.....38	SFS063.....43
H0107-0611.....87	H0210-0805.....84	H3240-5620.....59	H5225-4152.....64	JCA050.....38	SFS075.....43
H0110-0211.....87	H0214-0500.....84	H3240-5680.....60	H5225-4252.....64	JCA063.....38	SFS100.....43
H0110-0215.....87	H0214-0600.....84	H3240-5720.....59	H5250-0658.....64	JCA075.....38	SFS125.....43
H0110-0300.....87	H0214-0800.....84	H3240-5820.....59	H5250-4252.....64	JCA088.....38	SHA0312.....38
H0110-0311.87, 112, 113	H0216-0400.....84	H3240-5920.....59	H5275-4152.....64	JCA100.....38	SHA0375.....38
H0110-0315.....87	H0216-0415.....84	H3240-6020.....59	H5275-4252.....64	JCA113.....38	SHA0500.....38
H0110-0400.....87	H0216-0500.....84	H3240-6120.....59	H8224-0240.....109	JCA125.....38	SHA0625.....38
H0110-0411.87, 112, 113	H0216-0515.....84	H3240-6220.....59	H8224-0340.....109	JCA138.....38	SHA0750.....38
H0110-0415.....87	H0216-0600.....84	H3275-5220.....60, 111	H8224-0440.....109	LLB.....47	SHA0875.....38
H0110-0500.....87	H0216-0615.....84	H3275-5620.....60, 111	H8224-0540.....109	MBHD.....54	SHA1000.....38
H0110-0511.87, 112, 113	H0216-0800.....84	H3334-5524.....59	H8224-0640.....109	MRL.....49	SHA1250.....38
H0110-0515.....87	H0216-0815.....84	H3334-5624.....59	H8224-0840.....109	MSHD.....54	SHA1500.....38
H0110-0600.....87	H0310-0420.....57, 114	H3334-6124.....59	H8624-0340.....109	MSLHD.....51	SHA1750.....38
H0110-0611.87, 112, 113	H0310-0520.....57, 114	H3334-6224.....59	H8624-0440.....109	NACL.....51	SHA2000.....38
H0110-0615.....87	H0310-0620.....57, 114	H3340-5524.....59	H8624-0540.....109	OMA041.....18	SHS025.....42
H0110-0800.....87	H0314-0420.....57	H3340-5624.....59	H8624-0640.....109	OMA200.....18	SHS038.....42
H0110-0811.....87	H0314-0520.....57	H3340-6124.....59	H8624-0840.....109	OMA200P.....18	SHS050.....42
H0110-0815.....87	H0314-0620.....57	H3340-6224.....59	H8624-0940.....109	OMA225.....18	SHS063.....42
H0111-0211.....86	H0314-0820.....57	H3629-0014.....119	H8624-1040.....109	OMA225P.....18	SHS075.....42
H0111-0311.....86	H0316-0420.....57	H3629-0114.....119	H8624-1140.....109	OMA250.....18	SHS088.....42
H0111-0411.....86	H0316-0520.....57	H3629-0214.....119	H8624-1240.....109	OMA50P.....18	SHS100.....42
H0111-0511.....86	H0316-0620.....57	H3629-0314.....119	H8724-0340.....109	OMA275.....18	SHS2L.....43
H0111-0611.....86	H0316-0820.....57	H3629-0414.....119	H8724-0440.....109	OMA275P.....18	SHS3L.....43
H0114-0215.....88	H0316-0920.....57	H3629-0514.....119	H8724-0540.....109	OMS038.....41	SHS4L.....43
H0114-0300.....88	H0317-0420.....57	H3629-0614.....119	H8724-0640.....109	OMS050.....41	SHS5L.....43
H0114-0311.....88	H0317-0520.....57	H3728-0014.....119	H8724-0840.....109	OMS063.....41	SLHD.....51
H0114-0315.....88	H0317-0620.....57	H3728-0114.....119	H8924-0340.....109	OMS075.....41	SLLD.....51
H0114-0400.....88	H0317-0820.....57	H3728-0214.....119	H8924-0440.....109	OMS100.....41	SMA028.....22
H0114-0411.....88	H0520-2111.....91	H3728-0314.....119	H8924-0540.....109	OMS125.....41	SMA038.....22
H0114-0415.....88	H0608-2111.....92	H3728-0414.....119	H8924-0640.....109	OMS150.....41	SMA050.....22
H0114-0500.....88	H0608-2411.....92	H3728-0514.....119	H8924-0840.....109	PHA028.....39	SMA063.....22
H0114-0511.....88	H0610-2111.....92	H3728-0614.....119	H9626-0824.....133	PHA038.....39	SMA075.....22
H0114-0515.....88	H0708-2411.....91	H3808-0211.....116	H9626-0924.....133	PHA050.....39	SMA088.....22
H0114-0600.....88	H0710-2111.....91	H3808-0311.....116	H9626-1024.....133	PHA063.....39	SMA100.....22
H0114-0611.....88	H0710-2411.....91	H3808-0411.....116	H9626-1124.....133	PHA075.....39	SMA125.....22
H0114-0615.....88	H0807-2111.....90	H3808-0511.....116	H9626-1224.....133	PHA088.....39	SMS019.....42
H0114-0800.....88	H0810-2111.89, 112, 113	H3808-0611.....116	H9800-0400.....112	PL.....52	SMS025.....42
H0114-0811.....88	H0910-2111.92, 112, 113	H4008-0011.....116	H9800-0450.....113	PLAF.....52	SMS038.....42
H0114-0815.....88	H2014-0400.....84	H4008-0111.....116	H9800-0460.....114	PLAH.....52	SMS050.....42
H0115-0411.....86	H2612-0450.....96	H4008-0211.....116	H9830-0224.....113	PLHA.....52	SMS063.....42
H0115-0511.....86	H2612-0452.....96	H4230-0415.....120	H9830-0224.....114	PLHD.....52	SSLB.....46
H0115-0611.....86	H2612-0454.....96	H4230-0515.....120	H9830-0230.....113	PLHW.....52	SW52L.....43
H0116-0300.....88	H2612-0455.....96	H4230-0615.....120	H9830-0230.....114	PLLW.....53	SW53L.....43
H0116-0311.....88	H2612-0550.....96	H4230-0715.....120	H9850-0128.....113	PLWL.....53	SW54L.....43
H0116-0315.....88	H2612-0552.....96	H4230-0815.....120	H9850-0128.....114	PMA050.....21	SW55L.....43
H0116-0400.....88	H2612-0554.....96	H4230-0915.....120	H9850-0130.....113	PMA063.....21	TB.....53
H0116-0411.....88	H2612-0555.....96	H4230-1015.....120	H9850-0130.....114	PMA075.....21	TBP.....53
H0116-0415.....88	H2698-0450.....96	H4230-1115.....120	H9850-0500.....112	PMA100.....21	TPLB.....47
H0116-0500.....88	H2698-0452.....96	H4230-1215.....120	H9850-0915.....113	PMA125.....21	UNVB.....46
H0116-0511.....88	H2698-0454.....96	H4345-0215.....118	H9850-0915.....114	PMA150.....21	
H0116-0515.....88	H2698-0455.....96	H4345-0315.....118	H9850-9999.....112	PMA175.....21	



PEERLESS®

A KITO GROUP COMPANY

Our Product Offerings

In addition to this catalog, we have other available literature for specific industries:



Below-the-Hook & Material Handling Equipment (27.15)

- Lifting Beams
- Spreader Beams
- Roll Lifters
- Coil Lifters
- Tongs
- Sheet Lifters
- Pallet Lifters
- Fork Truck Accessories
- Material Handling

Retail Catalog (26.70)

- Industrial chain
- Accessories
- Miscellaneous Hardware
- Cargo control products
- Overhead lifting

Traction Products & Technical Guide (27.76)

- Cable Chain - featuring our Z® products
- Link Chain - Auto-Trac™ to Square Rod Truck Chain
- Tractor Link Chain
- OTR Chain
- And more!

Chain Sling User's Manual (10.20)

- Principal Chain Requirements
- Basic Safety Guidelines
- Evaluating the Load
- Selecting the Proper Sling
- Rigging
- Inspection
- Inspection Procedures
- Ways to Avoid Chain Failure
- 25 Things to Consider When Creating a Lift Plan
- Also available in Spanish! (10.20S)

Visit Us Online: www.peerlesschain.com | 800.873.1916



PEERLESS
A KITO GROUP COMPANY

Headquarters:

Winona, Minnesota

PH: 800-873-1916 | FAX: 800-356-1149

Custom Lifting Device Manufacturing:

Mount Pleasant, Pennsylvania

PH: 800-395-2445 | FAX: 800-997-3192

South Holland, Illinois

PH: 800-334-5643 | FAX: 800-334-5643

Distribution Centers:

Clackamas, Oregon

PH: 800-547-6806 | FAX: 800-468-4430

Reno, Nevada

Elizabethtown, Pennsylvania

Dallas, Texas

Necedah, Wisconsin

REQUEST A QUOTE

Warranty:

The goods sold in this catalog are warranted free from defects in workmanship and materials for 12 months from the ship date.

Disclaimer of warranties:

No other warranty, express or implied, including the implied warranty of merchantability or fitness for particular purpose, is given and no affirmation of Peerless Industrial Group, by words or action, shall constitute a warranty. Peerless Industrial Group will not pay any claim for labor on any of its products or for delays or damages by reason on their use.

Buyer's Remedies:

Buyer's sole remedy for breach of any warranty is limited exclusively to obtaining, at the discretion of Peerless Industrial Group, either repair or replacement of any product sold hereunder and manufactured by Peerless Industrial Group. In no event shall Peerless Industrial Group be liable for any incidental or consequential damages. Buyer must notify Peerless Industrial Group, in writing, within 10 days of discovery of the alleged defect, if within the warranty period stated above. After receiving authorization from Peerless Industrial Group, product shall be returned to the Peerless Industrial Group plant, transportation prepaid, within 30 days.

Return Goods Policy: Items purchased from this catalog are returnable ONLY when pre-authorized by a Peerless Industrial Group Customer Service Representative, who will issue a Return Authorization Number. This number must be displayed PROMINENTLY on the return material shipping containers AND the carrier's freight bill. UNAUTHORIZED SHIPMENTS WILL BE REFUSED AND RETURNED AT THE SENDER'S EXPENSE. All authorized returns must be sent prepaid to Winona, MN, South Holland, IL, Jeannette, PA, or Clackamas OR, and are subject to restocking and repackaging charges. Any product not returned in original saleable condition will be subject to an additional reconditioning charge.

Claims and Shortages: Peerless is willing to assist you in collecting claims for lost or damaged goods, however we are not responsible for collection of claims or replacement of merchandise. All requests for assistance must be accompanied by a copy of the freight bill noting the shortage or damage and signed by the delivering carrier's driver. All requests made to Peerless Industrial Group must be received within 30 days of date of delivery.

Minimum Invoice: The minimum invoice allowed is \$100.

A \$10 charge will be applied to any invoice below this amount.



Peerless Industrial Group, Inc.
1416 East Sanborn • P.O. Box 5349 • Winona, MN 55987-0349
www.peerlesschain.com • custserv@peerlesschain.com

Specifications are subject to change without notice. © 2018 Peerless Industrial Group Inc. | 27.12

REQUEST A QUOTE