



NAVIGATING HIGH PERFORMANCE WALL SYSTEMS



USING INSULATED COMPOSITE PANELS
AND INTEGRATED WINDOWS



CENTRIA is a registered provider with The American Institute of Architects Continuing Education Systems. Credit earned on completion of this program will be reported to CES records for AIA members. Certificates of Completion for non-AIA members available upon request.





This program is registered with AIA/CES for continuing education. As such, it does not include content that may be deemed, or construed to be, an approval or endorsement by AIA of any material of construction or any method or manner of handling, using, distributing or dealing in any materials or product. Questions related to specific materials, methods and services will be addressed at the conclusion of this presentation.





This presentation is protected by U.S. and International copyright laws. Reproduction, distribution, display and use of the presentation without written permission of the speaker is strictly prohibited.





Key Learning Objectives

- Identify key wall performance issues from a consultant's experience
- Recognize how Insulated Composite Panels can address some of the key wall performance issues
- Review new code requirements and the impact on wall system design
- Review thermal performance of panels and windows
- Demonstrate how value engineering can impact the wall performance
- Review steps that will aid in achieving a quality installation



Terminology

- **ICP:** Insulated Composite Panels with a foam core, gage metal skins and integrated joinery
- **IMP:** Insulated Metal Panels is a term used by the Metal Construction Association for ICP.
- **ICBP:** Insulated Composite Backup Panels are ICPs used as a backup system behind other various claddings
- **MCWS:** Multiple Component Wall System where different materials are used to create the critical performance barriers



PITFALLS

Common Pitfalls

Not understanding the concepts of moisture movement and control, and barrier selection and design

- Rainwater control
- Water in air/ air transport
- Water in air/ vapor diffusion
- Water entrapment or water management

– by Vince Cammalleri, Simpson Gumpertz & Heger (SGH)
& Keith Boyer



PITFALLS

Entrapped moisture

Framing Damage





PITFALLS

Entrapped moisture

Window Perimeter Leaks





PITFALLS

Poor material selection

- Will weather barrier remain adhered to the substrate?
- Will tapes stay adhered?
- Compatibility of tapes or WRBs and sealants
- UV exposure effects on WRBs
- Insulation efficiency
 - Thermal shorts
 - Condensation and energy loss
 - Thermal continuity
- Fire performance of wall assembly
 - With foam plastics
 - With asphalt based barriers





PITFALLS

Poor detailing

- Erectable
- Discontinuous air barriers
 - Material joinery
 - One wall type to another
 - Air barrier breaks > energy loss and moisture movement via air transport and water entrapment

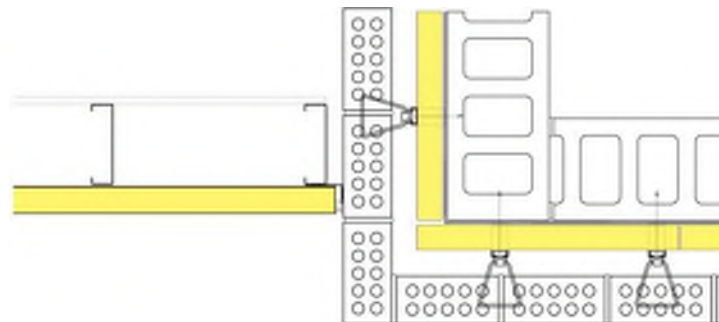



PITFALLS

Insufficient redundancy of barriers

- Need methods to avoid moisture buildup / entrapment
- Need methods to assure air tightness

– By Vince Cammalleri, SGH



PITFALLS

Poor installation / QA procedures / Monitoring

Need steps to assure quality installation

– By Vince Cammalleri, SGH





PITFALLS

What happens when...

- ...board stock foam has gaps at joints or Z's penetrating joints?
- ...combustible weather wraps are used in an architectural wall assembly?

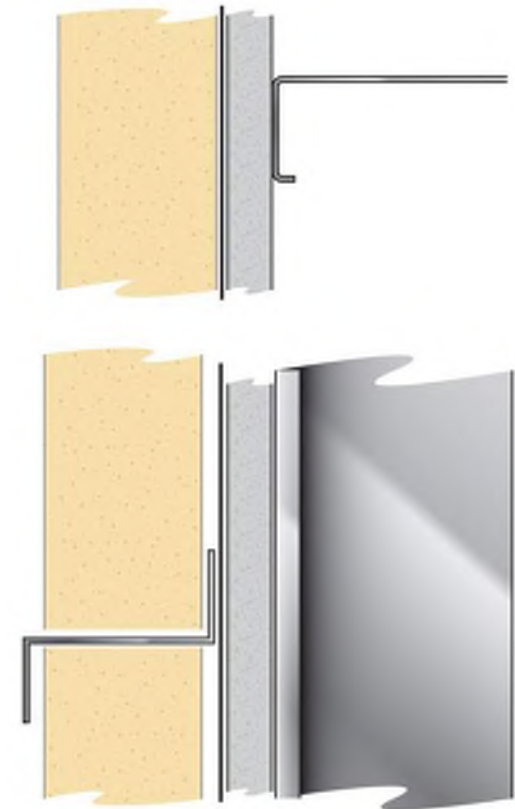



PITFALLS

What happens when...

...moisture is entrapped within an insulated composite side joint?

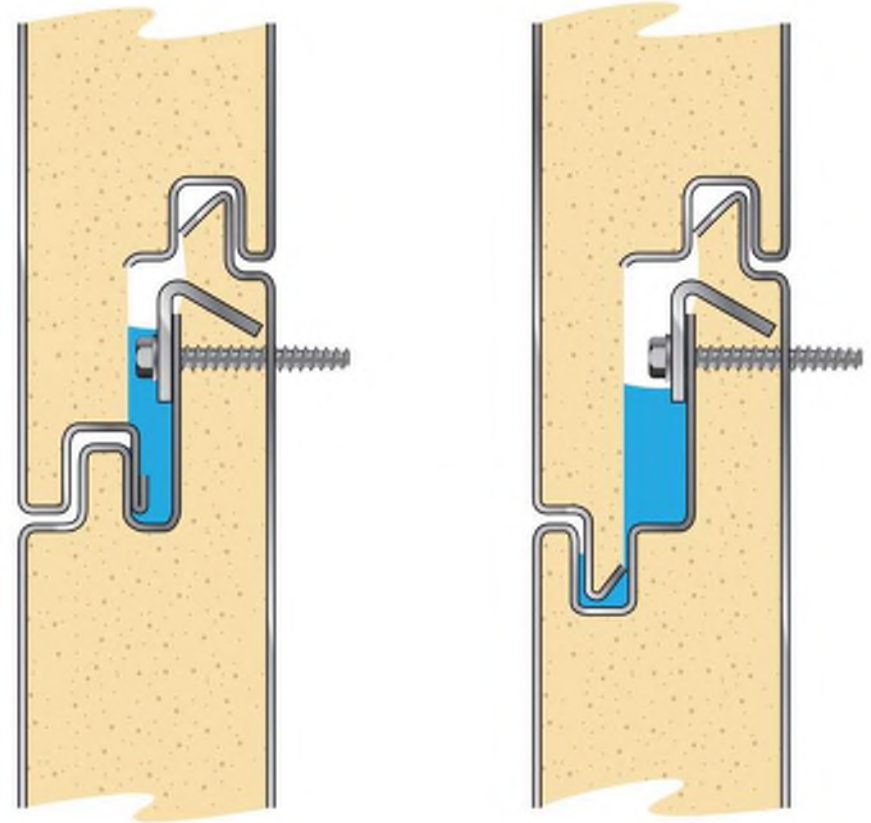



IECC 2015 / Panel R-values

Minimum R-Values* - Opaque Thermal Envelope for Steel Framed Walls

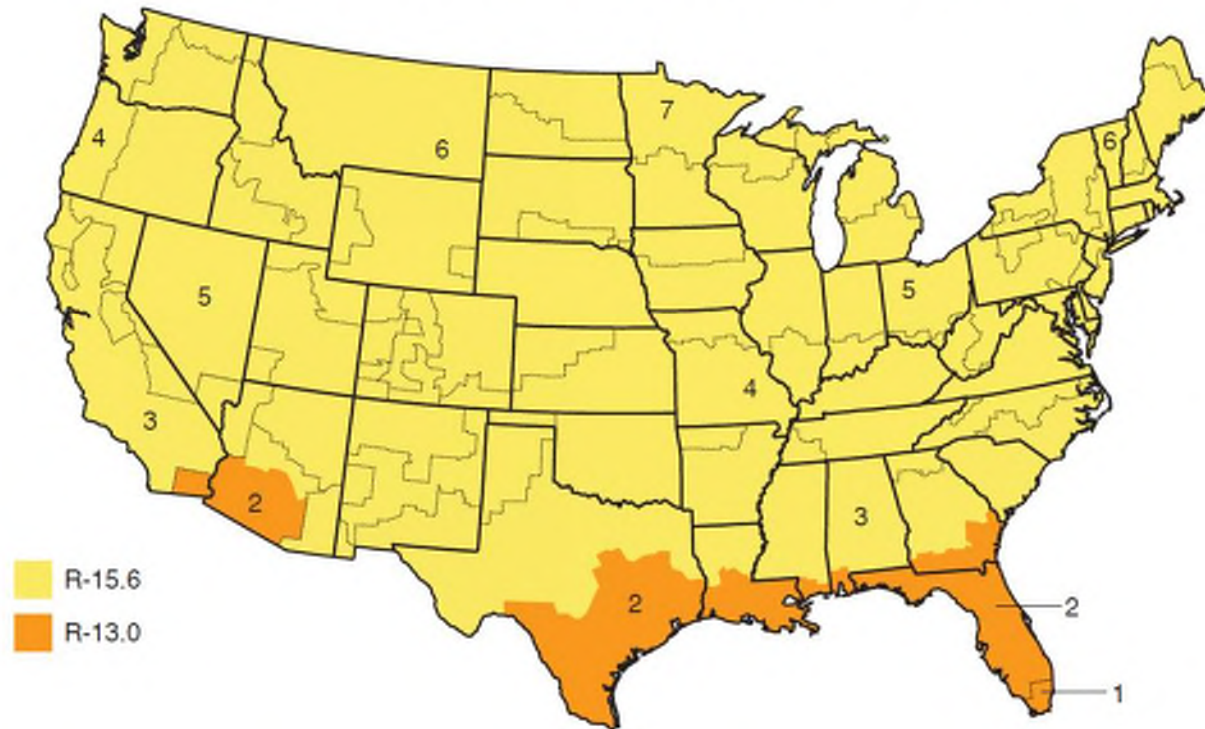

*Minimum R-Values = 1/(Assembly Maximum U-Values)



Code mandated R-Values for opaque wall areas

OPAQUE WALL THERMAL REQUIREMENTS FOR STEEL-FRAMED WALLS
AS STATED IN THE ASHRAE / IESNA STANDARD 90.1 - 2004

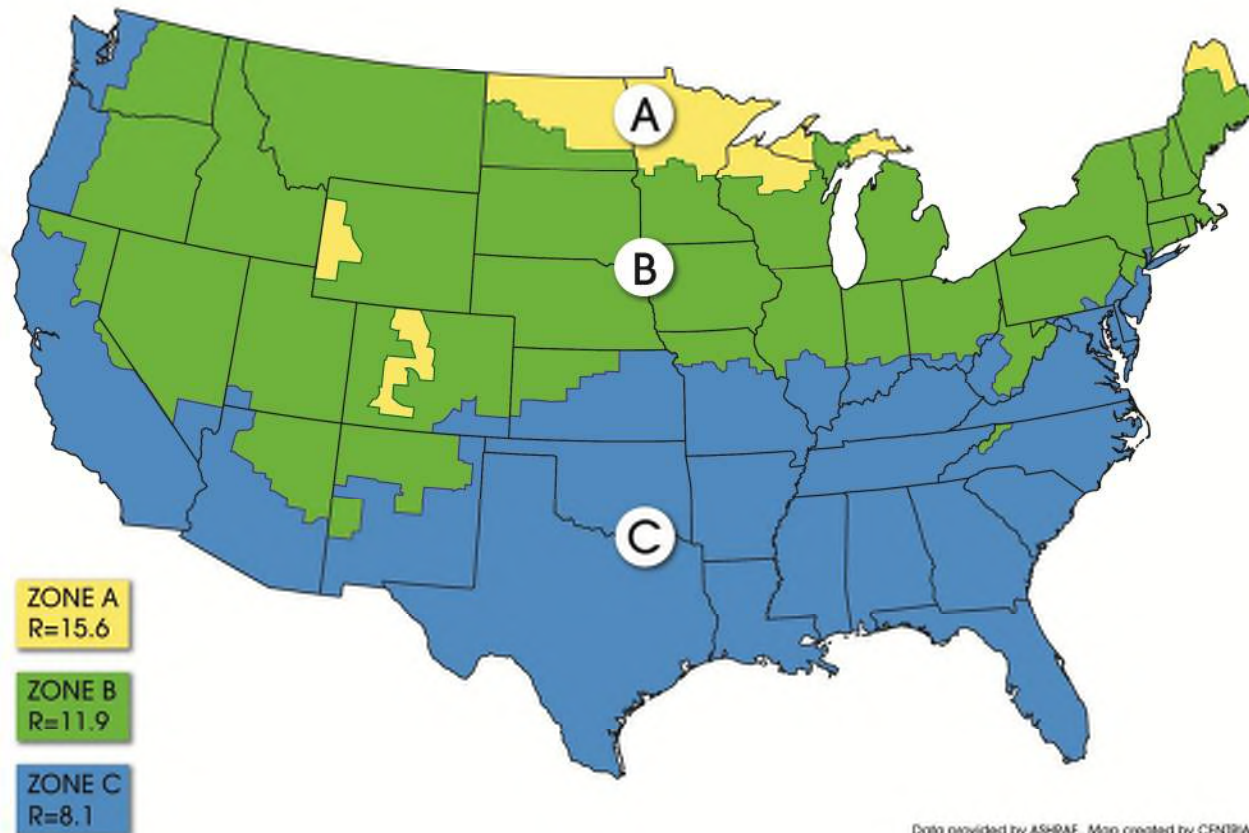



Code mandated R-Values for opaque wall areas

OPAQUE WALL THERMAL REQUIREMENTS FOR STEEL-FRAMED WALLS AS STATED IN THE ASHRAE / IESNA STANDARD 90.1 - 2004

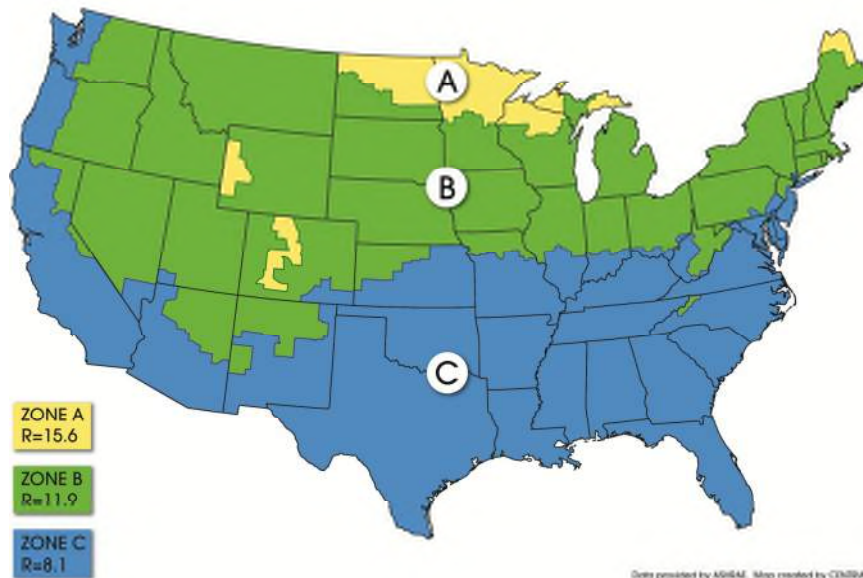

OPAQUE WALL THERMAL REQUIREMENTS FOR STEEL FRAMED WALLS 2015 IBC / IECC

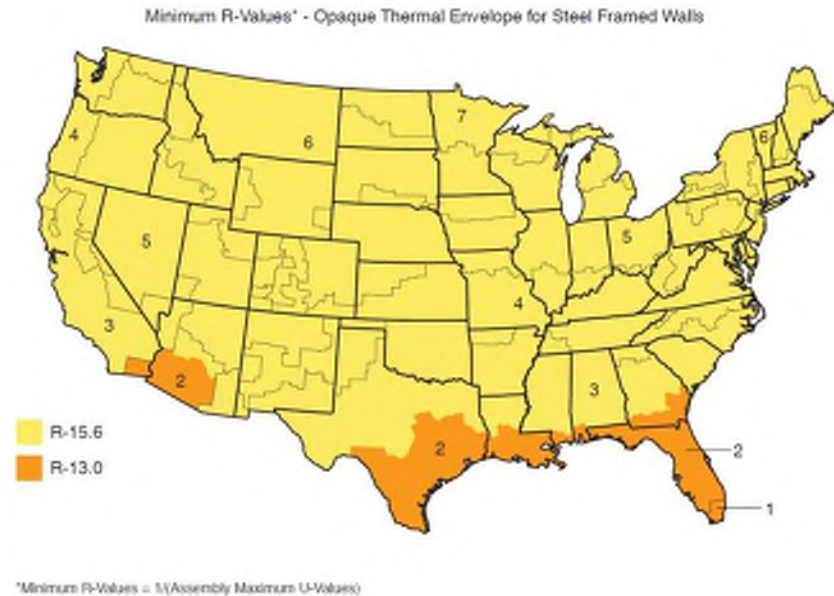



Commercial State Energy Code Status AS OF JULY 1, 2015

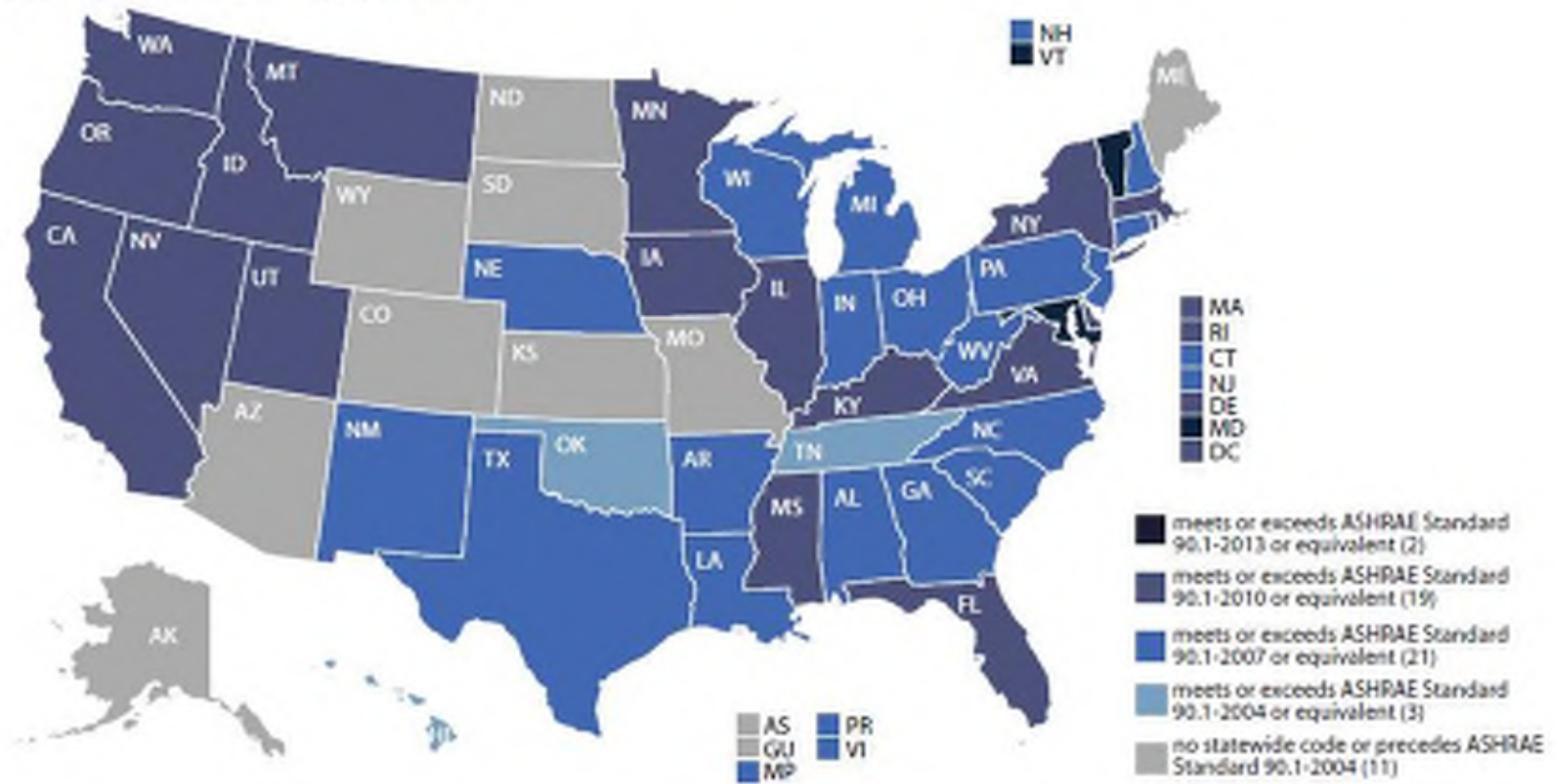



ASHRAE 90.1 climate zone 5 Fixed Fenestration

- Code mandated minimum R-values

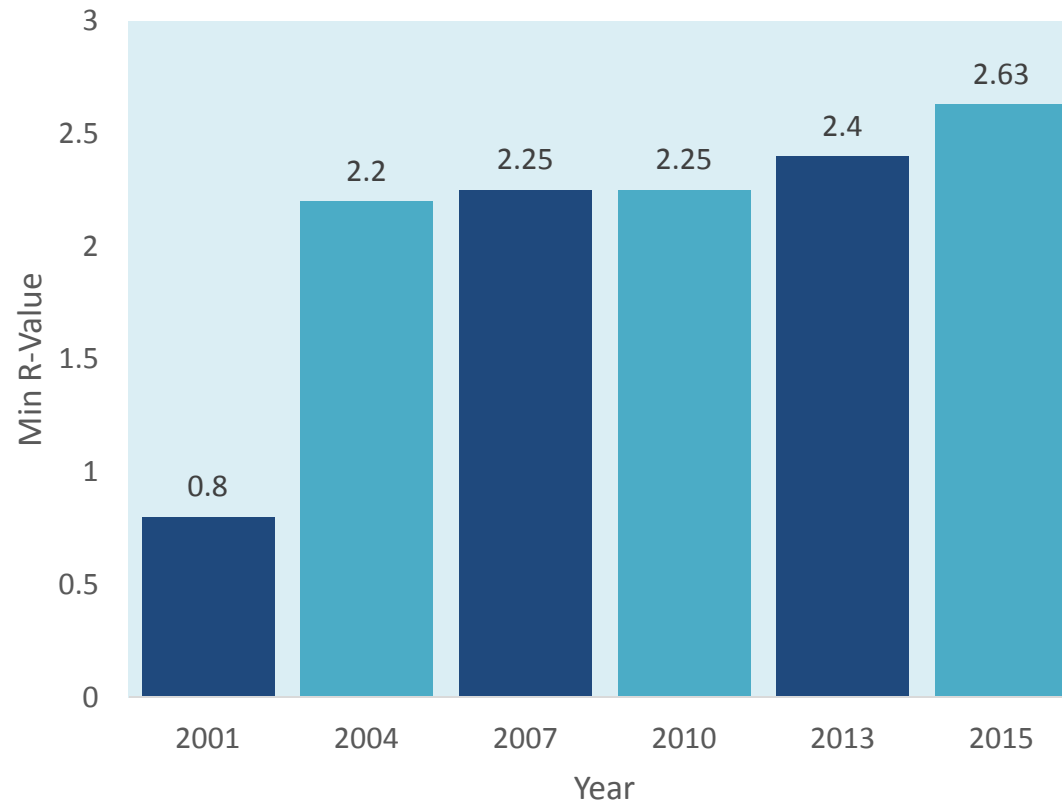



Whole wall analysis

- Windows and opaque wall areas
- Cold climate performance / conductive heat loss / flow
- Use ASHRAE U_0 concept for parallel heat flow
 - Does not consider solar heat gain, radiation or the effects of air leakage



Parallel heat flow whole wall thermal efficiency

- Similar analysis to parallel resistors
- ASHRAE Fundamentals, U_0 concept

$$U_0 = \frac{U_{\text{wall}} A_{\text{wall}} + U_{\text{window}} A_{\text{window}}}{A_0}$$

$$R = 1/U$$



Overall wall R-value with varying window area

- Know 100% opaque area $> R-14$
- Know 100% window area $> R-2$
- With 50% window area, what is the whole wall R-value ?



Windows vs. opaque areas

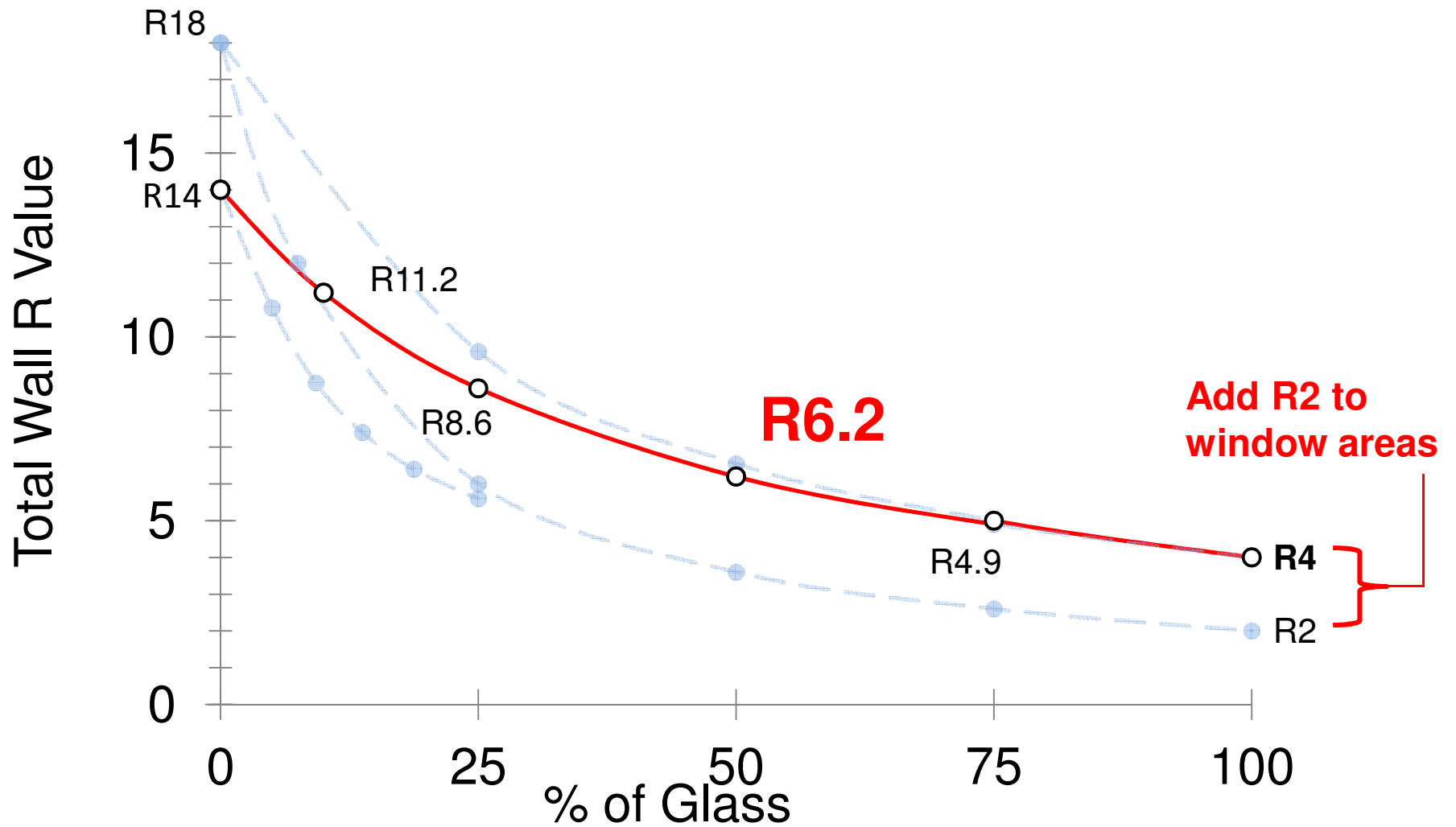



Summary – Windows vs. opaque areas

Windows have significant impact on the whole building performance...

To improve the whole wall performance

- Use high efficiency windows
- Use fewer windows

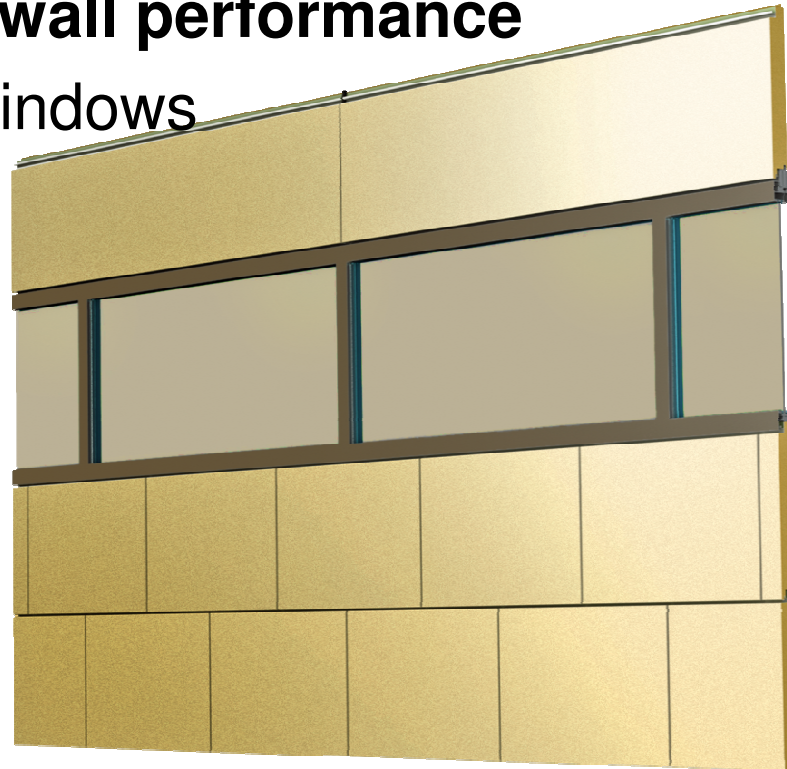



Thermal Modeling and Whole Wall Performance

- Thermal efficiency of the window and opaque products is only part of the solution.
- Let's look at the impact of the **interface details**...



What can we learn from thermal modeling?

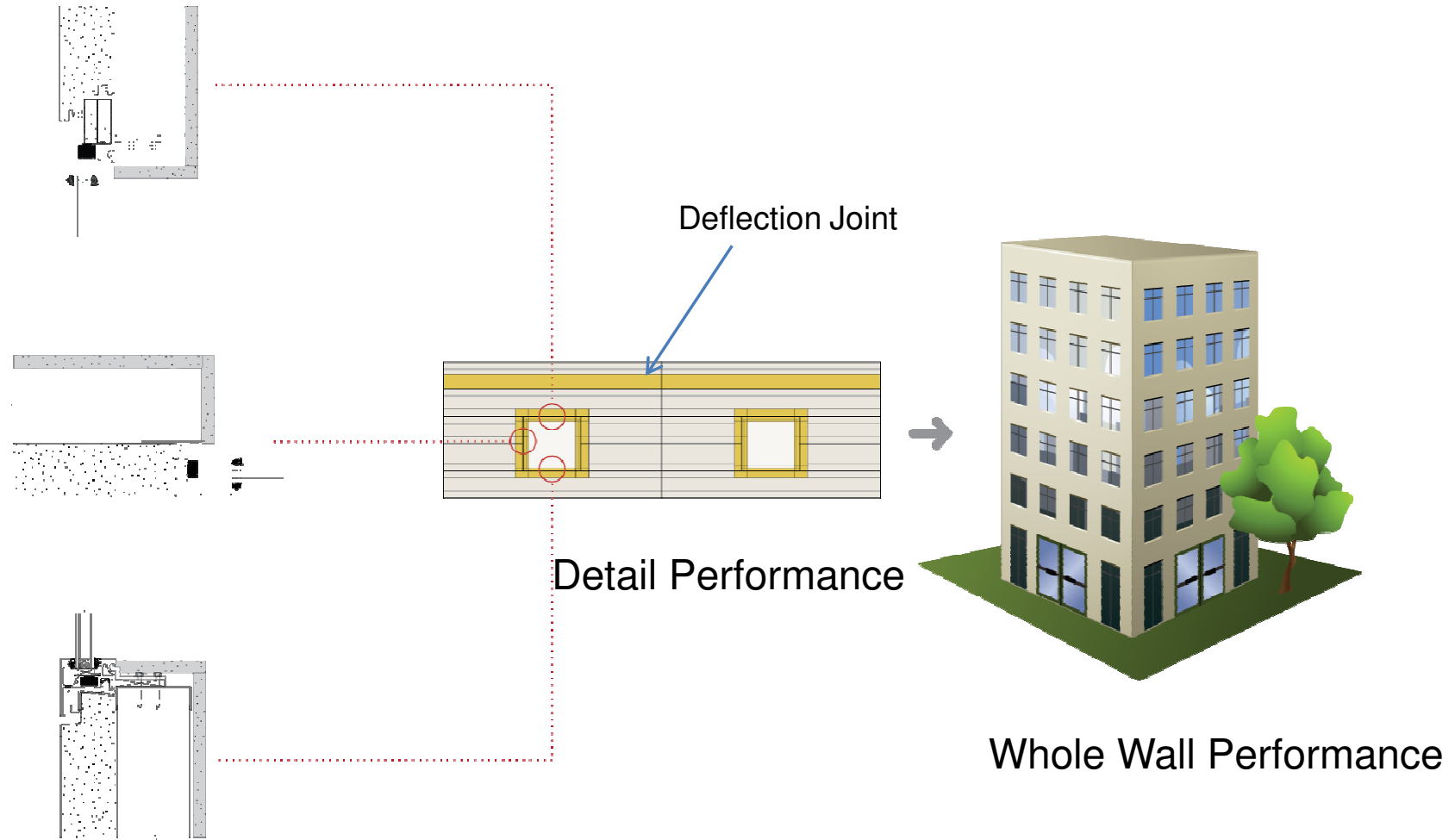



Integrated window head and ICP

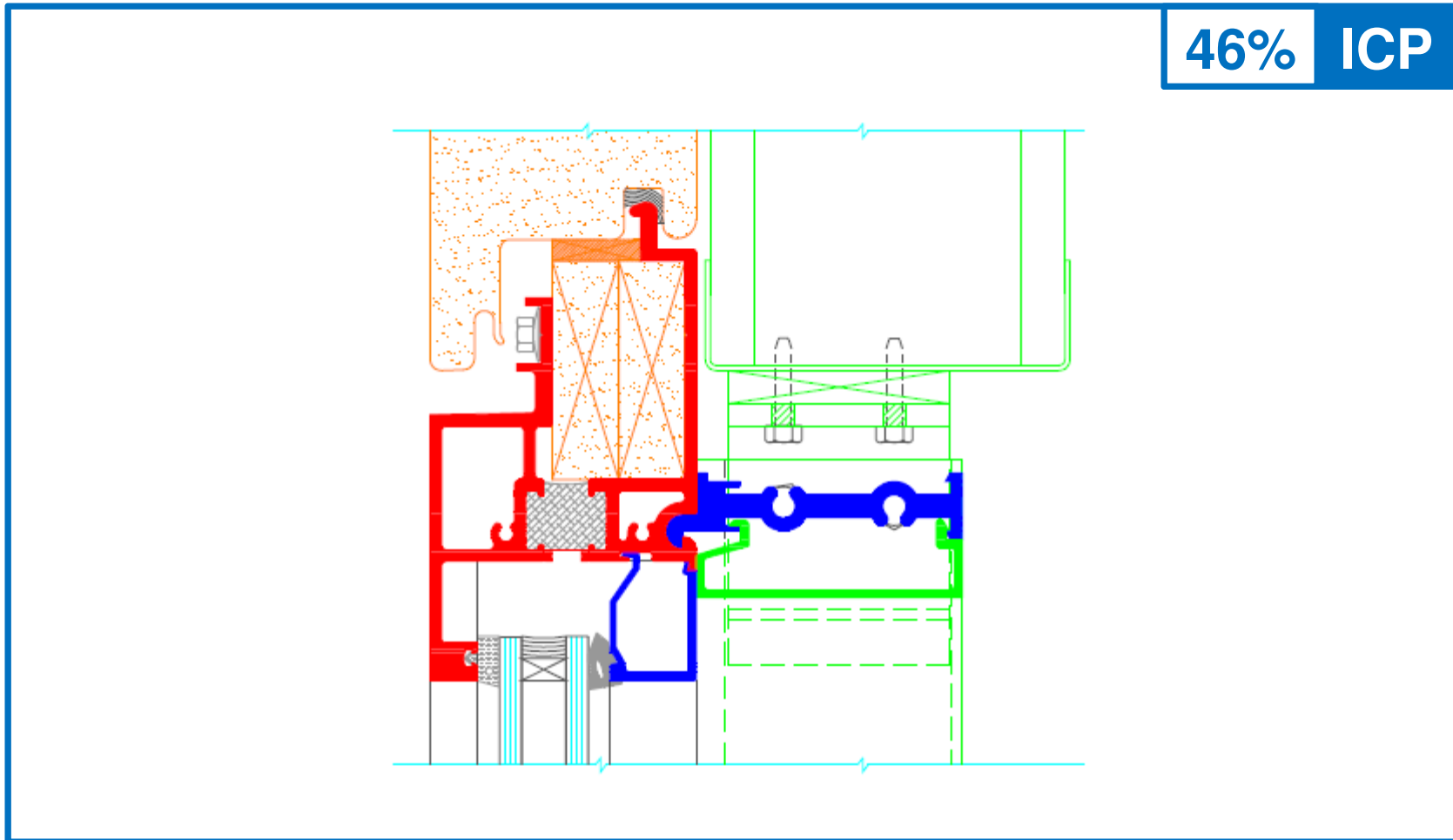



Integrated window sill and ICP

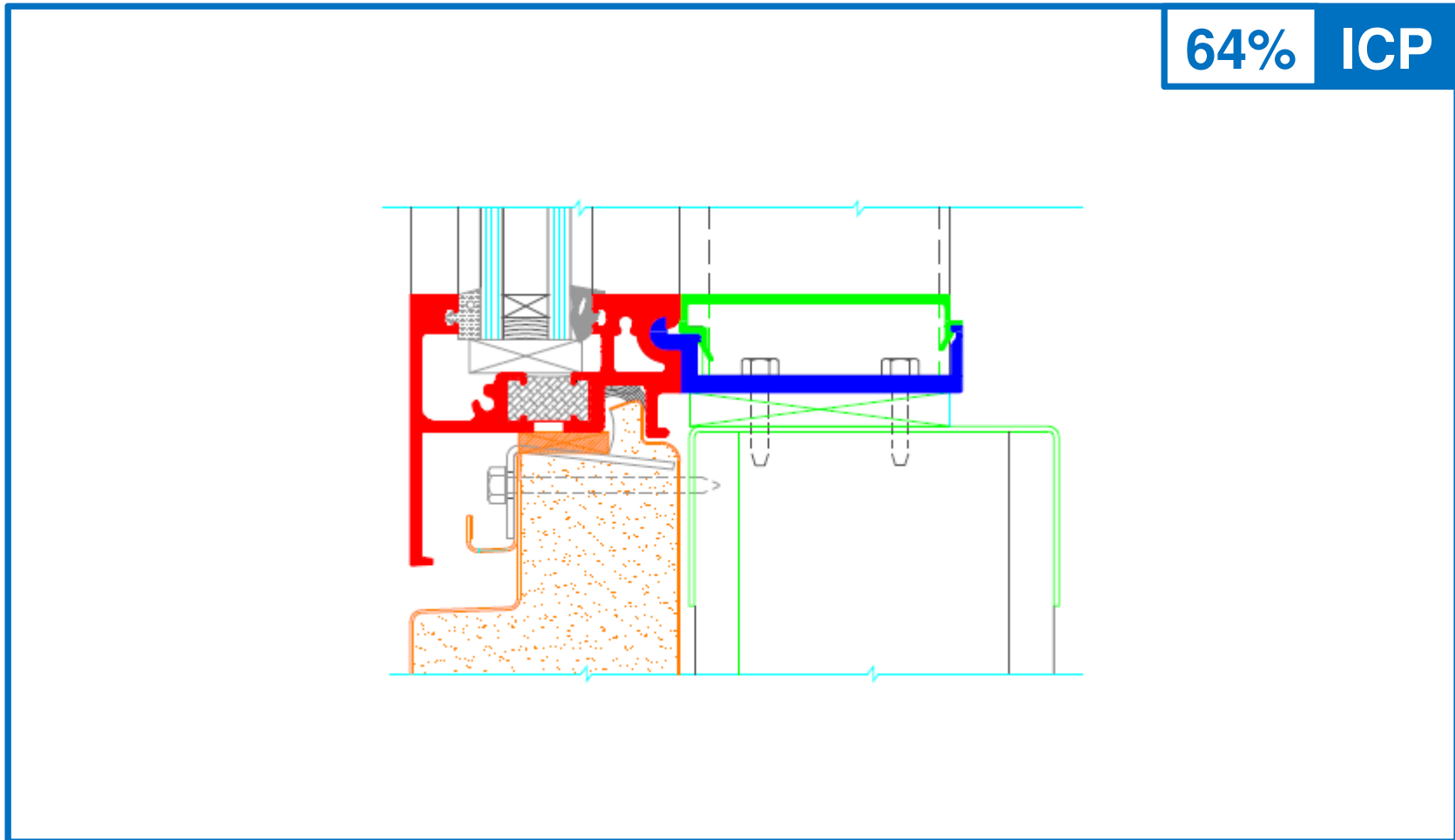



Non-integrated window with flash detail

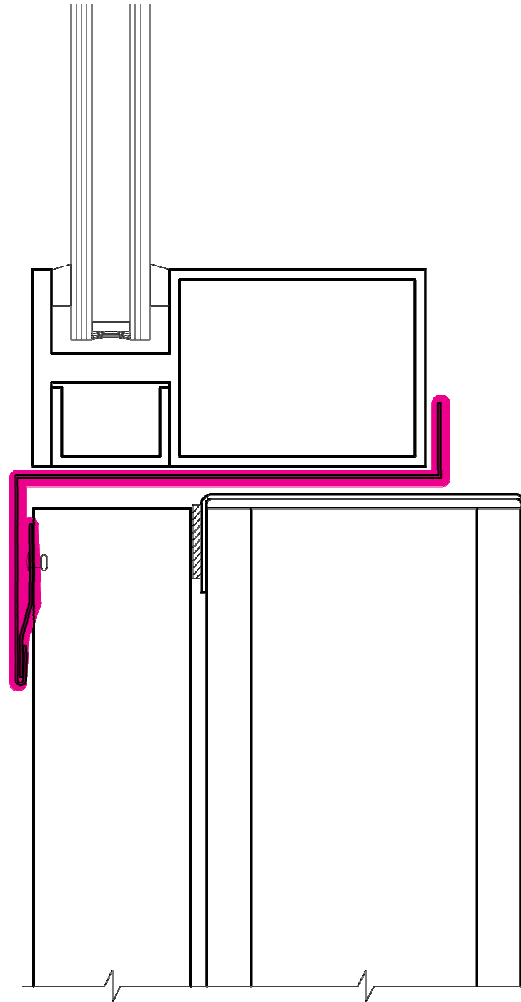



Integrated windows vs. non-integrated

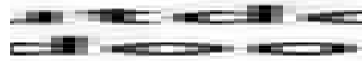

50%

NON-INTEGRATED

INTEGRATED



Thermal modeling

- Check for interior surface temperatures to avoid condensation





What can we learn from thermal modeling?

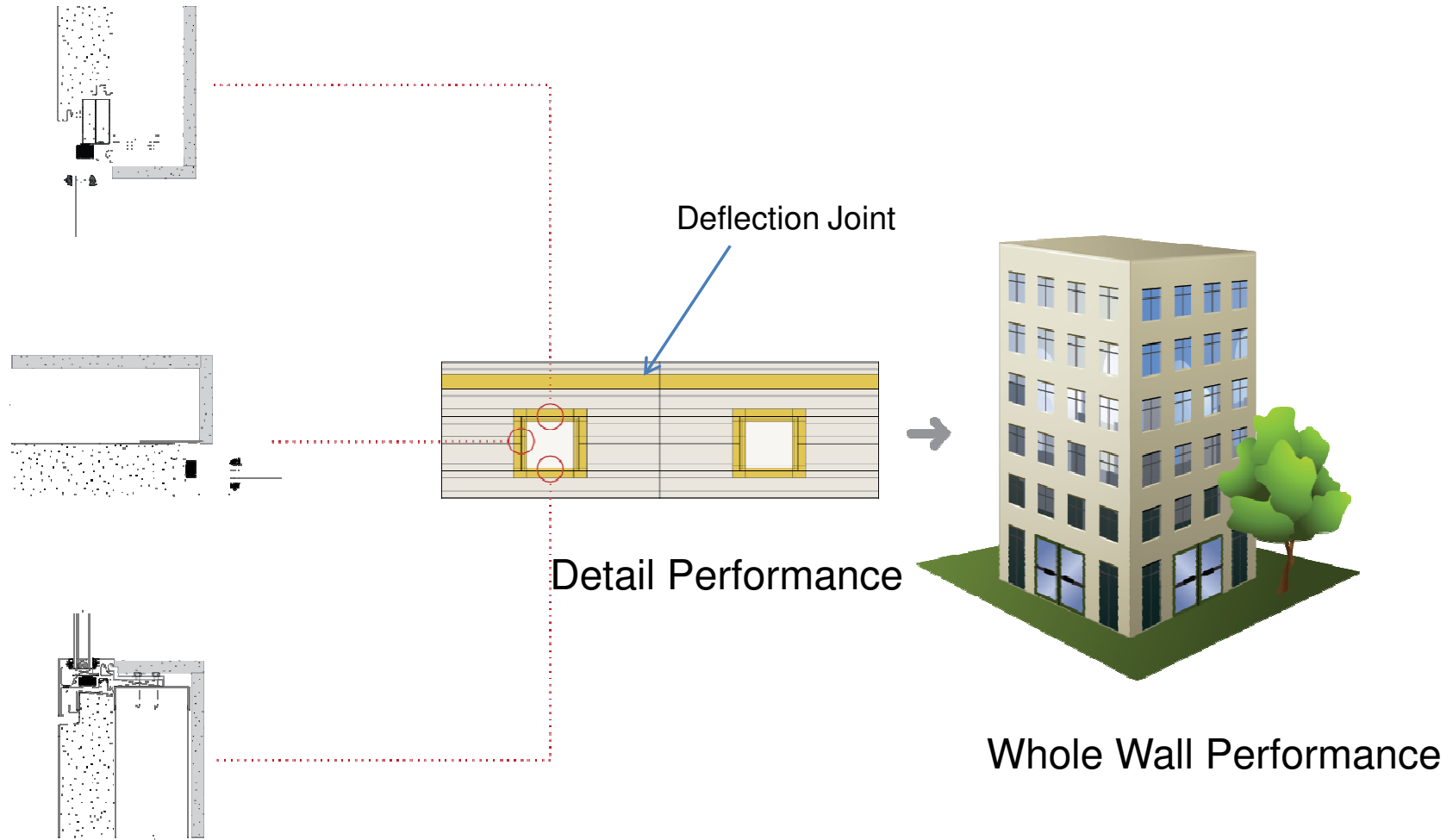



Un-insulated Deflection Joint

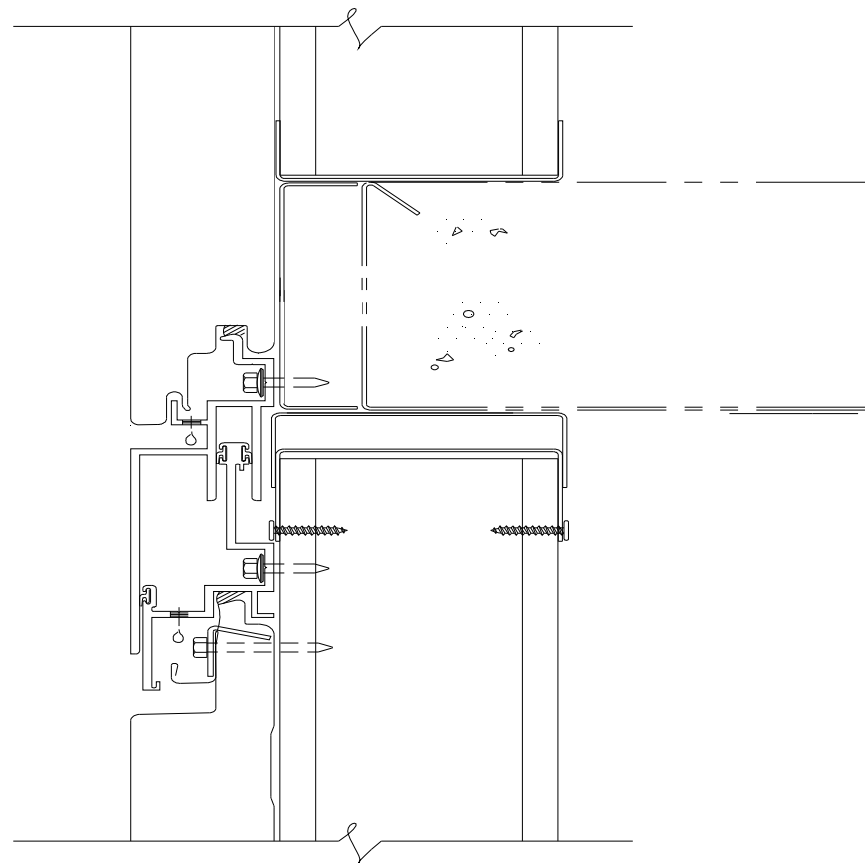



Deflection joint

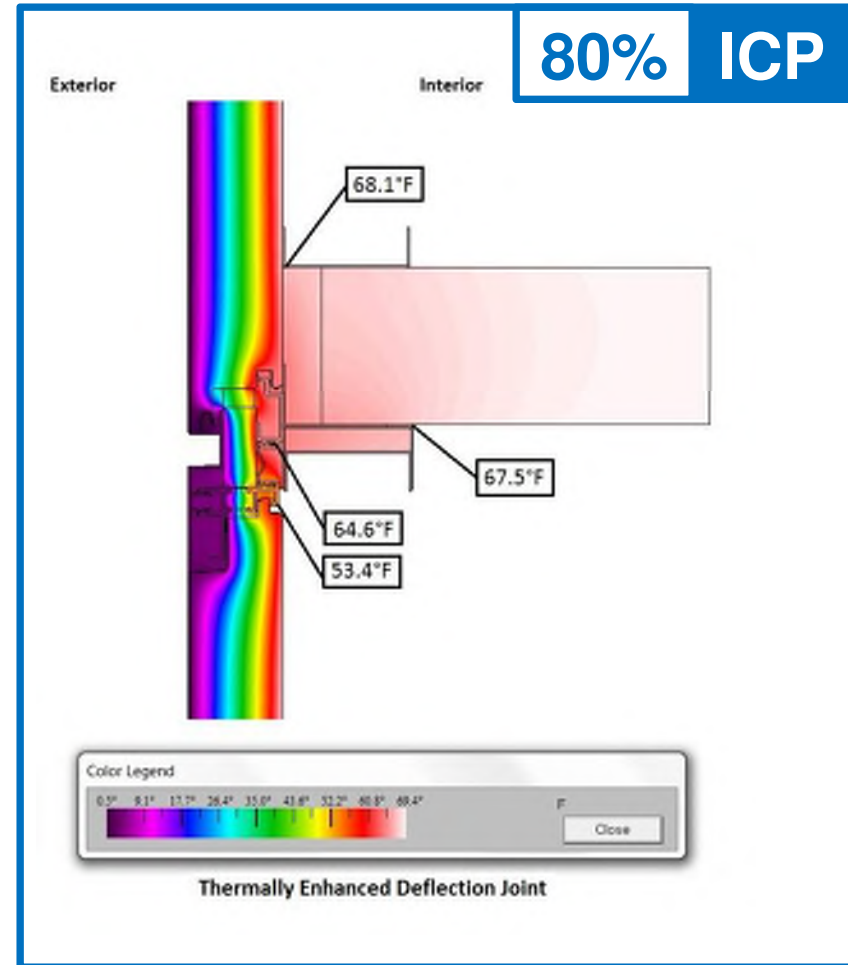
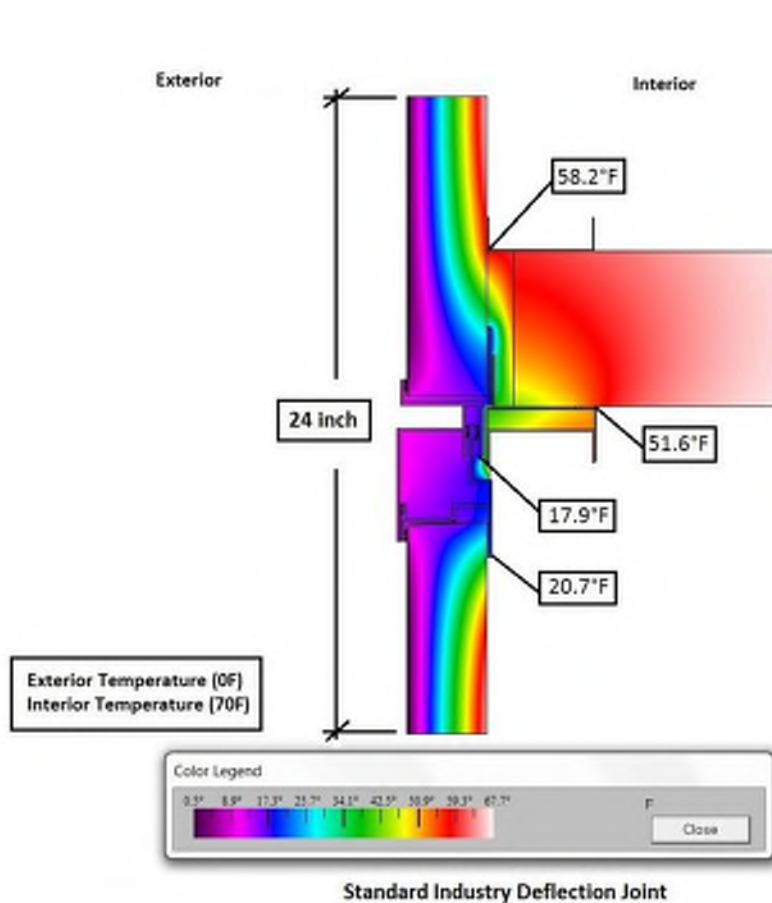



High thermal efficiency side joint

ICP

Exterior Temperature (0F)
Interior Temperature (70F)

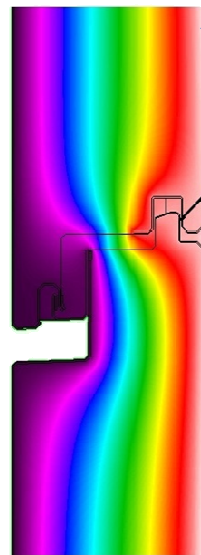

68°F mid width

65.1°F

64.2°F

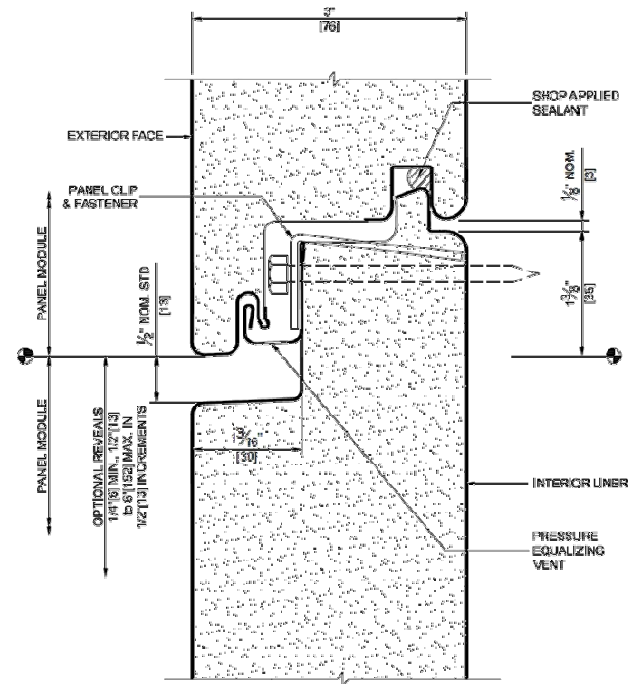
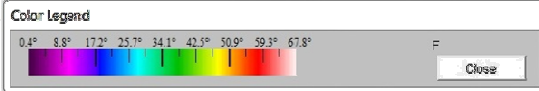

Horizontal Joint



High efficiency vertical joint

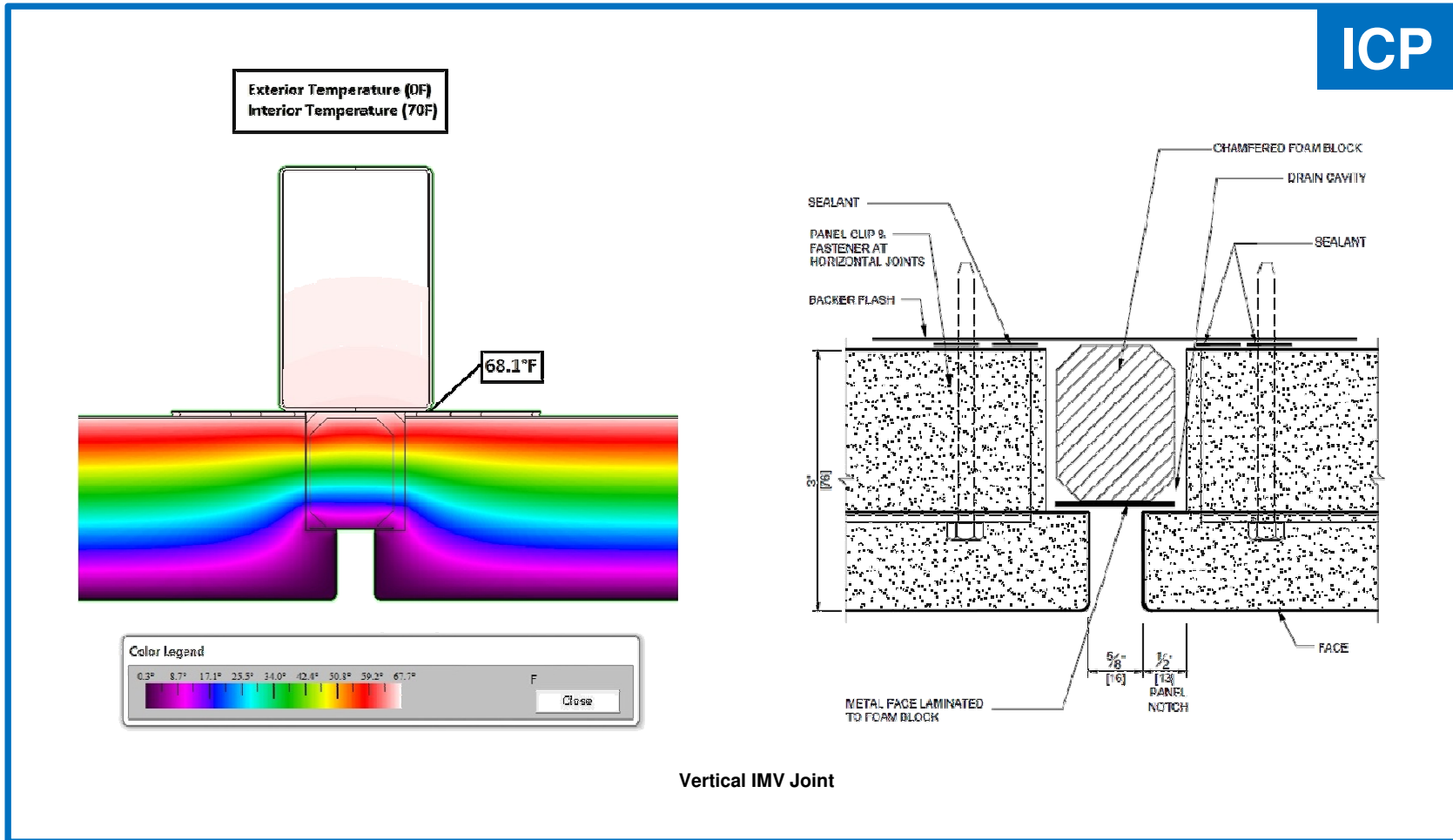



UBC 17-6 / UBC 26-4 Test In Progress

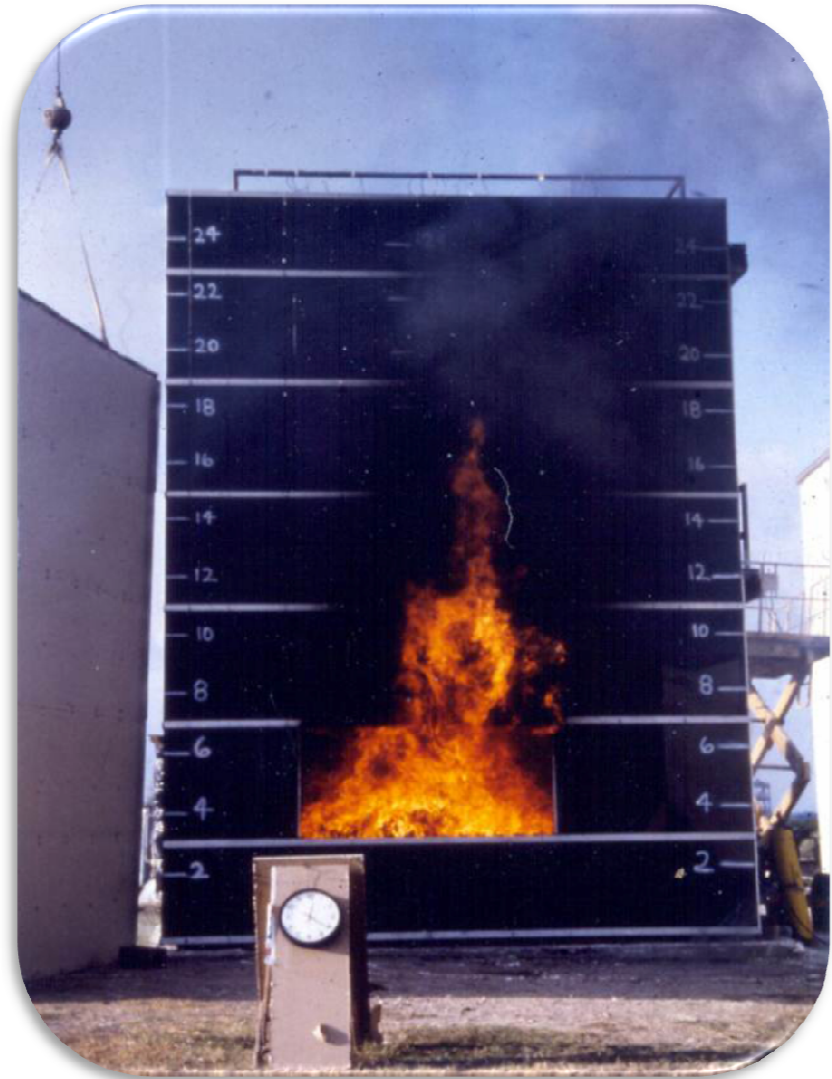



NFPA 285 – Side view

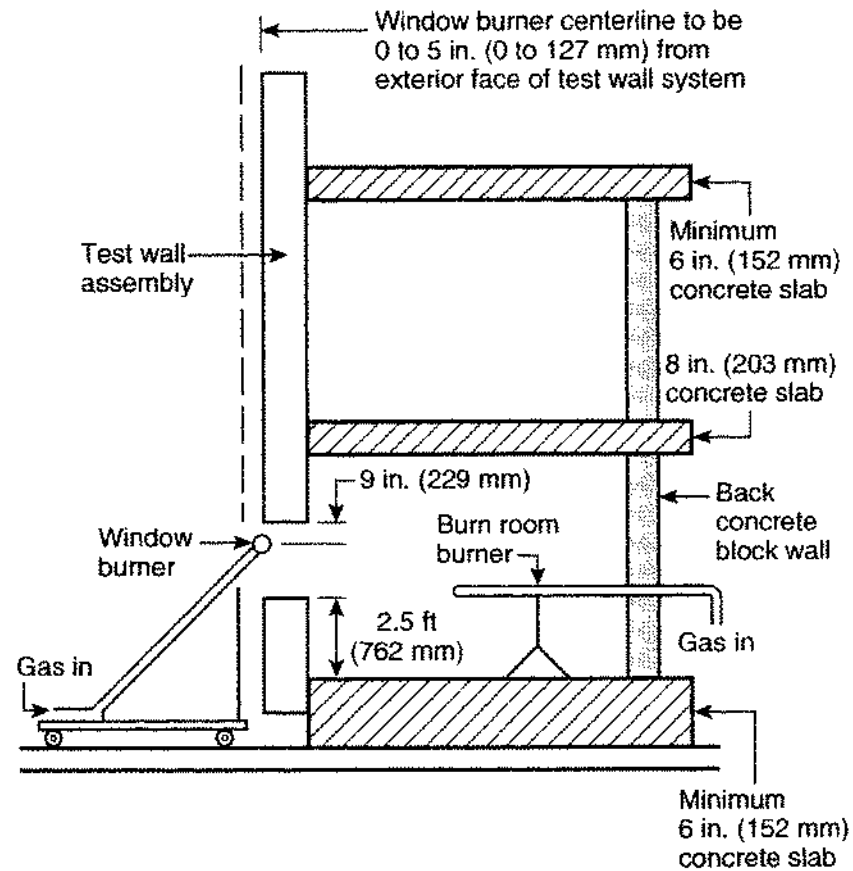

FIGURE A.4.4.8 Side View of Burner Placement in First-Story Test Room (not to scale).



NFPA 285 – Vertical limits

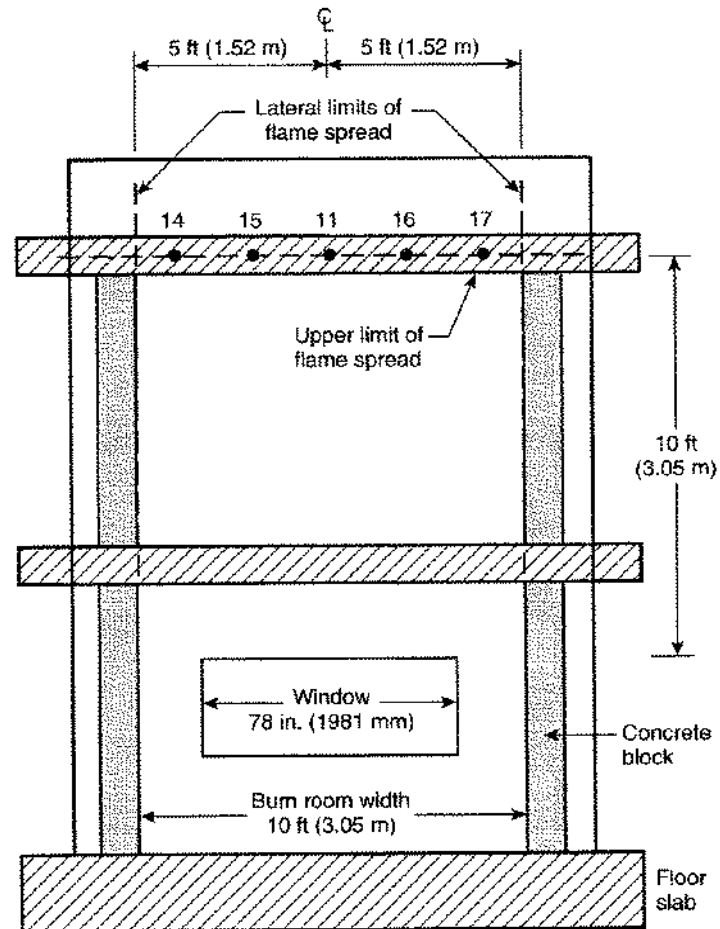

FIGURE 10.2.1.2 Limits of Flame Propagation (not to scale).



- NFPA 285 Test In Progress
 - Test duration: 30 minutes
 - Test cost : \$20,000 - \$25,000
- Beitel-Spiewak paper
- Engineering judgments
- Work with suppliers/ review tested options





BID & CONTRACT STAGE

NAVIGATING HIGH PERFORMANCE WALL SYSTEMS



Bid challenge

- End with what you designed and specified...
...Especially the aesthetics and performance items





Case 1 Deflection joints influence on performance

- Job designed with through tubes with no moving joints in the panel field
 - Movement taken at tube connection to slab edge
- To cut costs the GC wants to use studs inset from the slab edge
 - Creates a moving joints in the wall plane
 - One joint per floor around the whole building



BID & CONTRACT STAGE





BID & CONTRACT STAGE

Infill
Framing





Case 1 Deflection joints influence on performance

With deflection joints at every floor...

The Challenge

- How to make weather tight (air and water)
- How to handle the movement range
- How to make thermally efficient



Case 1 Deflection joints influence on performance

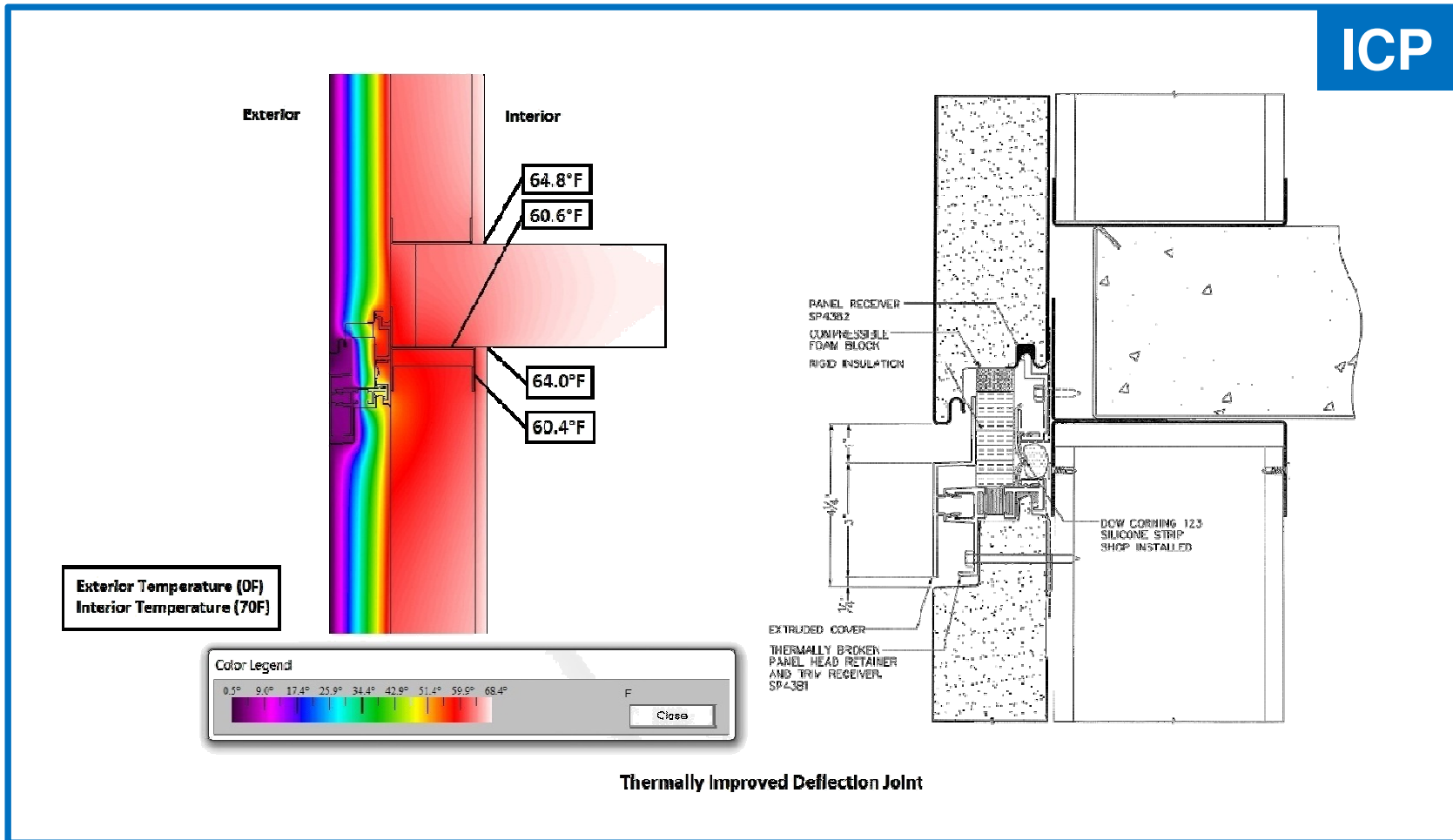



Case 1 Deflection joints influence on performance

- Impact on the **whole wall** thermal efficiency
 - Compare to through tube without movement joints
 - With insulated joint / 30% more heat loss
 - With un-insulated joint / 100% more heat loss

 - When making comparisons...Consider the energy costs, material, schedule impact, and labor to create the more complex deflection joints



Case 2 Integrated vs. non-integrated windows

- The job had an ICP & integrated windows specified
- The GC wants to use a non-integrated window
 - To install this in the panel area, perimeter trim is needed

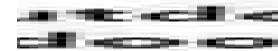

NON-INTEGRATED

INTEGRATED



Case 2 Integrated vs. non-integrated windows

- The result of using a non-integrated window can reduce the thermal performance by about 50% at the head, sill and jamb details

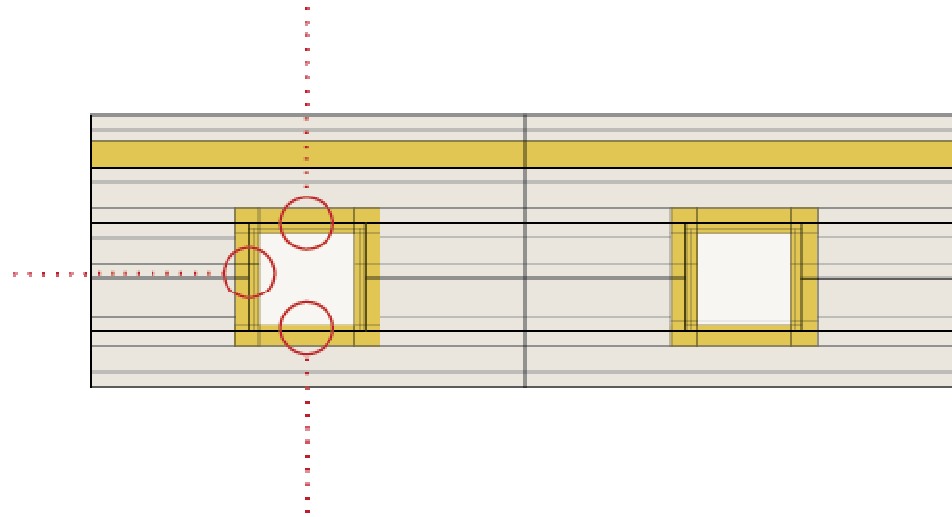



Case 2 Integrated vs. non-integrated windows

- The effect on the **whole wall** thermal performance is also in the 40 to 60% area depending on the window to panel ratio.





Case 2 Integrated vs. non-integrated windows

- In a winter climate zone the temperature of the interior window extrusions can now be 10 degrees colder and may be a condensation issue.





Case 3 Use of thermally improved panel extrusions

- The project specifies thermally improved panel trim and transition extrusions
- To cut costs it is desired to use non-thermally improved details.



Panel base

48% ICP

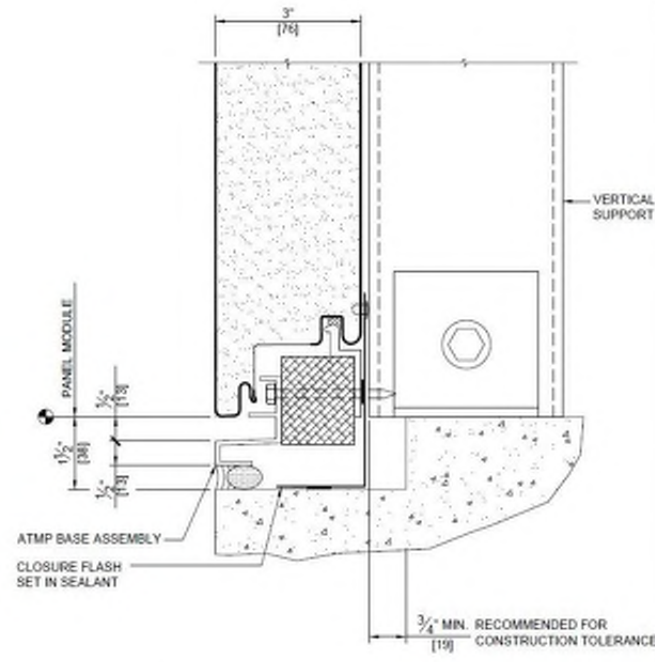
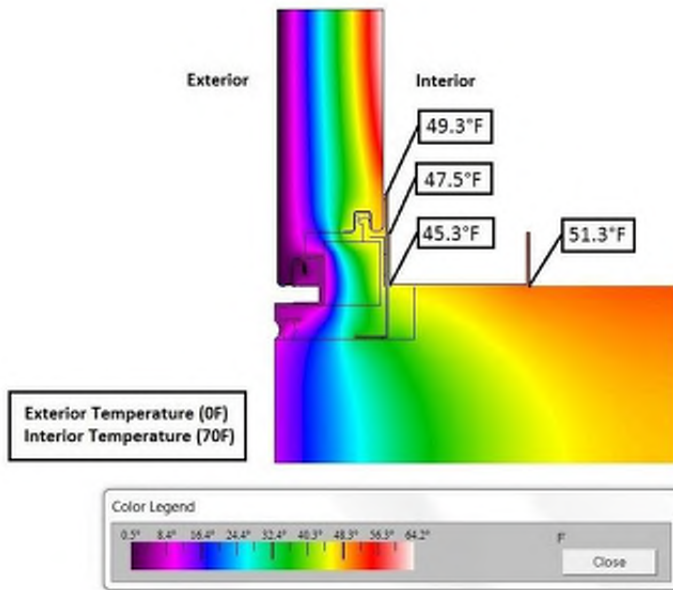

Thermally Improved Base Detail



Case 3 Use of thermally improved panel extrusions

- The percent reduction in heat loss for the thermally improved base, deflection and stack details is 48%, 80% and 66% compared to the non thermally improved details.
- The impact on the whole wall can be significant and is dependent on the panel layout.
- The temperatures on the interior at the details can be 20 to 30 degrees cooler for a 0 degree exterior air temperature raising concern for condensation in cold climates.



Summary – Value engineering

- Use thermal modeling to understand the effects of any changes to details and to the whole wall performance.
- If possible, perform whole building energy analysis to evaluate the impact that the building enclosure may have on the building energy usage.
- Consider material, labor, schedule and energy savings when evaluating design changes...
- For the most efficient details
 - Eliminate moving joints
 - Use integrated windows
 - Use thermally improved panel details



INSTALLATION STAGE

NAVIGATING HIGH PERFORMANCE WALL SYSTEMS



INSTALLATION STAGE

Construction stage

- Support coordination
- Training
- Field hose test
- Field mockup



Support Coordination

- *Through tubes are in panel and window contract
- *Studs by others
 - Minimum gage
 - Alignment
 - Low profile fasteners at stud to track connections





Training

At corporate facilities

On site





Field Mockup

Check installation methods

Test assembly

Establish expected quality





Field Hose Test

Check at various stages

Check each crew





INSTALLATION STAGE

Field Hose Test





Field Hose Test



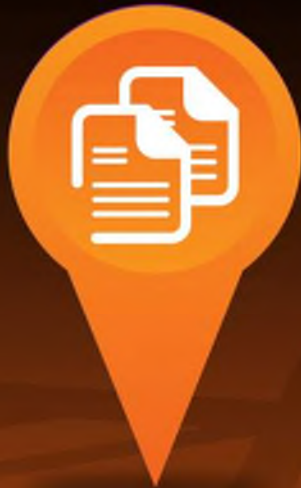

SUMMARY

NAVIGATING HIGH PERFORMANCE WALL SYSTEMS



Learn from the consultants

- Understand moisture movement and management
- Make good material and design decisions
- Monitor and control installation





Consider using ICPs to establish the 4 barriers

- As a finished product
- As a backup system to other claddings
- As a method to establish a consistent barrier system from one cladding type to another
- As a system that works in any climate





Select an efficient ICP

- Check side joints for potential water traps
- Check the thermal model of the panel side joint
- Where possible use redundant air and water seals





- Use efficient windows and scrutinize the interface details
- Check thermal models for interior temperatures and heat loss





Use thermally improved ICP details

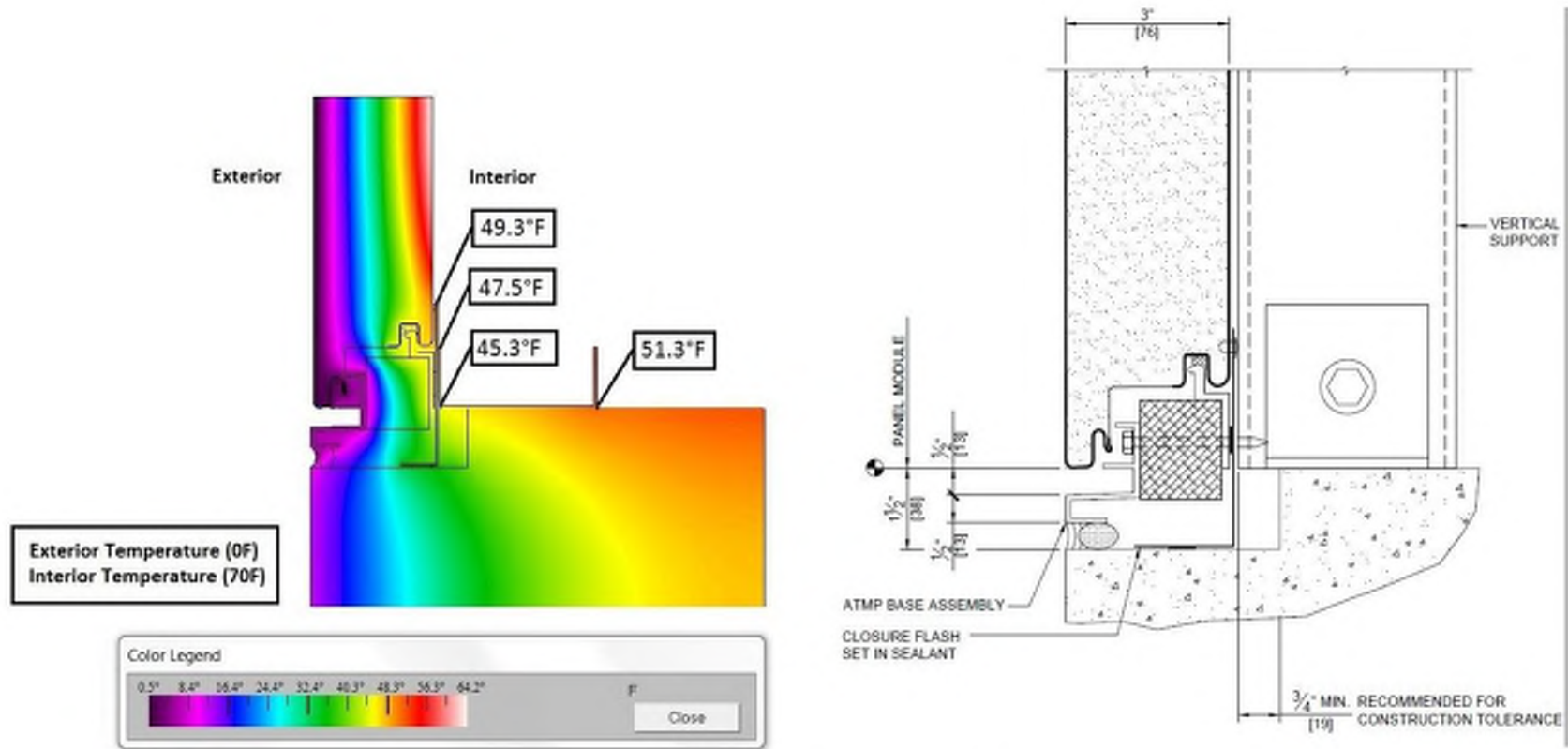

Thermally Improved Base Detail



Know the code / foam plastics

- Consult the experts for wall assemblies with foam plastics
- Use materials that have been tested in NFPA 285
- Require submittal of pertinent NFPA 285 tests





Watch Value Engineering and its impact on performance

- Use thermal modeling to verify decisions
- Consider all the factors: material, labor, schedule differences, and building operating costs





Support System Coordination

- Assure that the support systems work with the chosen cladding
 - Alignment
 - Gage
 - Spacing
 - Inter-story Deflection
- Tubes in a through tube system part of the window system and contract



Use proper field measures in training and testing

- Train the installers
- Implement testing protocols
 - Test early in the construction stage (not after completion)





ICP or ICBP with Integrated Windows

- ...properly **designed, contracted and installed** ... offers high performance air and water tightness, and thermally efficiency for the entire wall system.



NAVIGATING
HIGH PERFORMANCE WALL SYSTEMS



USING INSULATED COMPOSITE PANELS
AND INTEGRATED WINDOWS