



FUEL STORAGE SYSTEMS

**HYTEK**  
FUEL & LUBRICATION  
EQUIPMENT

# Technical Data

## AOFILL.N

### OVERFILL LIMITER VALVE

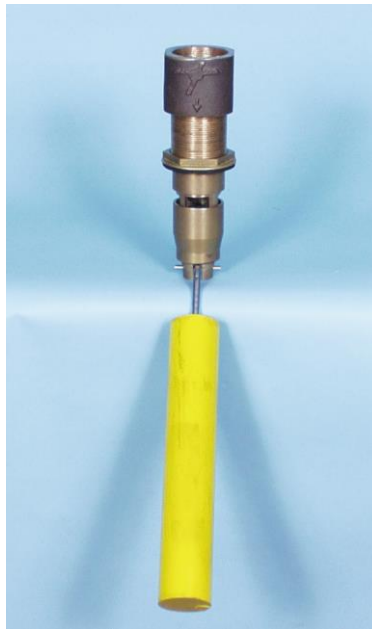

**Applies to the following models only**

- AOFILL.N
- AOFILL.N.3

Please read carefully before commencing installation

Registered Office: HYTEK (GB) LIMITED, Delta House, Green Street, Elsenham, Bishop's Stortford CM22 6DS  
UK. Registered in England No. 1915382  
Tel: +44 (0) 1279 815 600 Fax: +44 (0) 1279 812 978 email: info@hytekgb.com Web: www.hytekgb.com

S273/6

## **ENVIRONMENTAL INFORMATION**

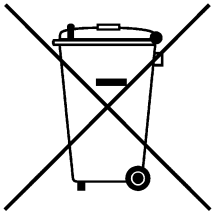

European Directives 2002/96/EC and 2003/108/EC require that the equipment bearing this symbol on the product an/or its packaging must not be disposed of with unsorted municipal waste. The symbol indicates that this product must be disposed of separately from regular household waste streams. It is your responsibility to dispose of this and other electric and electronic equipment via designated collection facilities appointed by the government or local authorities.

## **IMPORTANT WARNING NOTES**

1. This Hytek AOFILL overfill limiter valve is only intended for use on above ground fuel storage tanks.
2. This valve must not be used on tanks containing petrol or any other flammable liquid.
3. Installation of this valve and its associated pipe-work should only be undertaken by qualified installation engineers.
4. Installation of this valve must conform to all relevant local authority standards and guidelines. When the fuel storage tank has been filled to its maximum capacity fuel will continue to flow through this valve at a minimal rate. An overfill will occur unless the fuel delivery is halted.

## **PARTS LIST**

<b>PART DESCRIPTION</b>	<b>PART NUMBER</b>	
	<b>AOFILL.N</b>	<b>AOFILL.N.3</b>
Overfill Valve Body	AOF.BODY	AOF.3.BODY
Valve Sleeve	AOF.SLEEVE	AOF.3.SLEEVE
Brass Nut	AOF.NUT2	AOF.NUT3
Sealing Washer	LWASH.25F	LWASH.88
Float	AOF.FLOAT300	AOF.FLOAT300
Float Rod	AOF.ROD	AOF.ROD
Stainless Steel Pin 30mm Long	PIN.5.30SS	PIN.5.30SS
Stainless Steel Pin 50mm Long	PIN.5.50SS	PIN.5.50SS

# HYTEK - AOFILL.N OVERFILL LIMITER VALVE

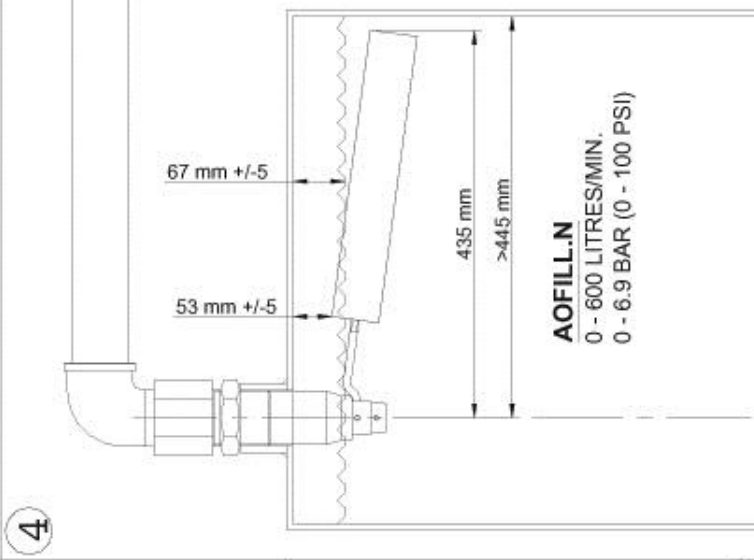
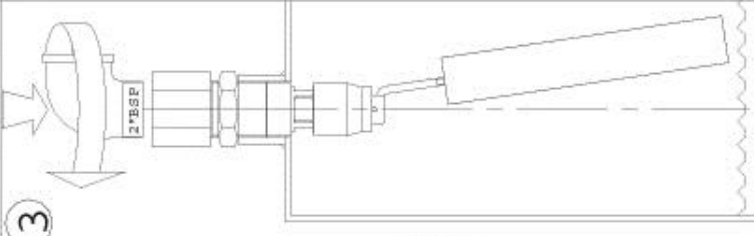
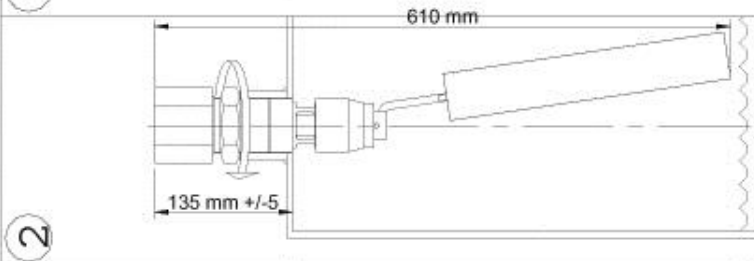
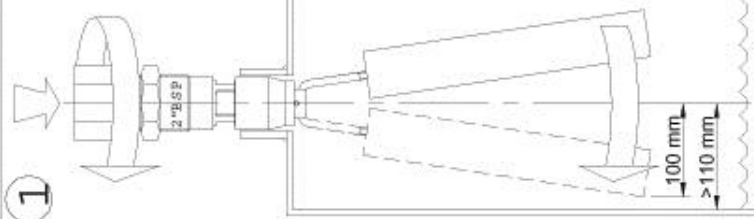

## WARNING

WHEN THE FUEL STORAGE TANK HAS BEEN FILLED TO MAXIMUM CAPACITY FUEL WILL CONTINUE TO FLOW THROUGH THE AOFILL.N AT A MINIMAL RATE. AN OVERFILL WILL OCCUR UNLESS THE FUEL DELIVERY IS HALTED.

# HYTEK - AOFILL.N3 OVERFILL LIMITER VALVE

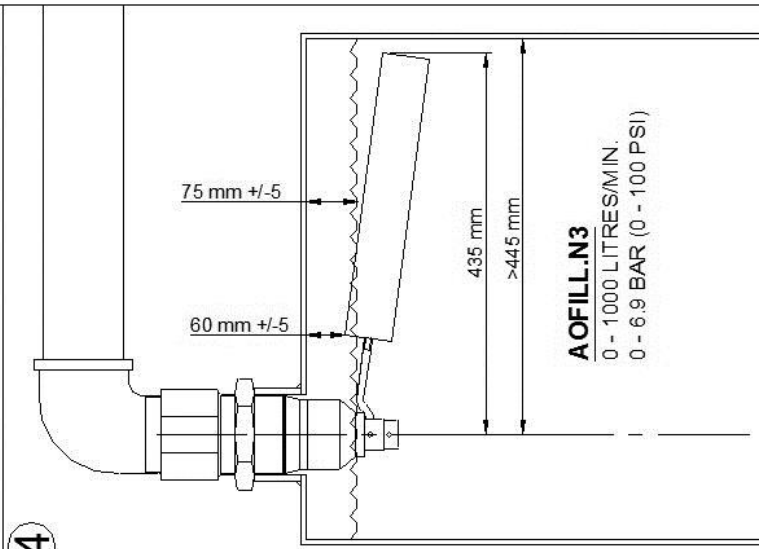
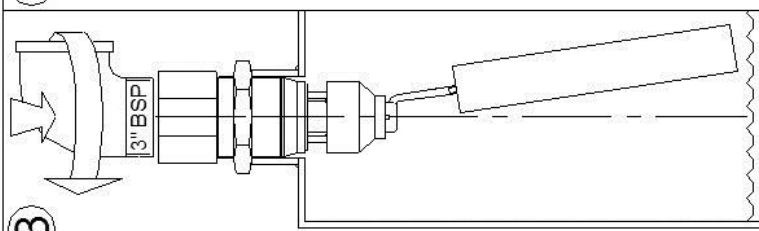
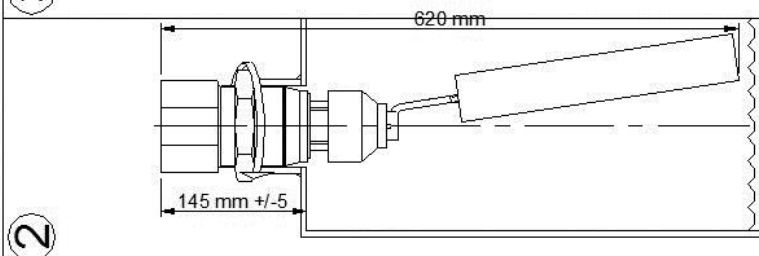
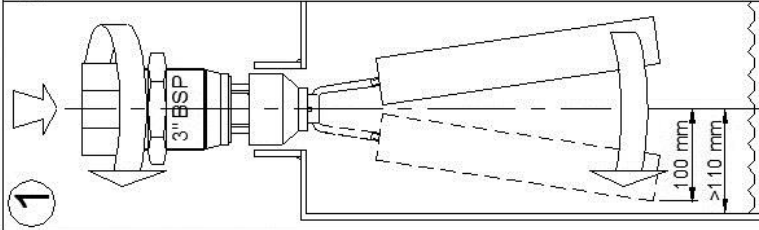

## WARNING

WHEN THE FUEL STORAGE TANK HAS BEEN FILLED TO MAXIMUM CAPACITY FUEL WILL CONTINUE TO FLOW THROUGH THE AOFILL.N3 AT A MINIMAL RATE. AN OVERFILL WILL OCCUR UNLESS THE FUEL DELIVERY IS HALTED.





## **E.C. DECLARATION OF CONFORMITY**

**HYTEK**  
FUEL & LUBRICATION  
EQUIPMENT

Company Name: **Hytek (GB) Ltd**

Address: **Delta House, Green Street  
Elsenham, Bishops Stortford  
Hertfordshire  
CM22 6DS, UK**

Date of Issue: **24<sup>th</sup> April 2017**

Equipment Details: **AOFILL.N and AOFILL.N.3 Above  
Ground Overfill Limiter Valves**

Applicable Directives:  
& Standards **2006/42/EC Machinery Directive**  
**2014/68/EU Pressure Equipment  
Directive (effective date 19<sup>th</sup> Jul 2016)**

Declaration Number: **EU047/5**

On behalf of the above named company, I declare under our sole responsibility that, on the date the equipment accompanied by this declaration is placed on the market, the equipment conforms with all technical and regulatory requirements of the above listed directives.

*Clive Wellings*

Clive Wellings  
Technical Manager

THE INFORMATION CONTAINED IN THIS DOCUMENT IS PROTECTED BY COPYRIGHT © AND PROPERTY LAWS AND IS THE SOLE PROPERTY OF HYTEK (GB) LTD. ANY REPRODUCTION IN PART OR AS A WHOLE WITHOUT THE WRITTEN PERMISSION OF HYTEK (GB) LTD IS PROHIBITED.