

Cornice
Drapery
Drapery Track
Eclipse Double Layer Shade
Honeycomb Cellular Shade
Roller Shade
Roman Shade

CATALOG JANUARY 2023

VERSION 2023.1



#561-752-5585

1220 SW 35TH AVENUE STE A
BOYNTON BEACH, FL 33426
www.shadingsource.com

PAGE GUIDE & INSTRUCTIONS

CORNICE	PG 2
DRAPERY	
GROMMET	PG 3
PINCH PLEAT	PG 3
SPECIALTY PLEAT	PG 4
RIPPLEFOLD	PG 5
ROD POCKET	PG 6
LINING OPTIONS	PG 6
DRAPERY TRACK TECHNICAL INFORMATION	
MANUAL DRAPERY TRACK	PG 7
CRESTRON DRAPERY TRACK	PG 8
LUTRON DRAPERY TRACK	PG 9
SOMFY DRAPERY TRACK	PG 10
ECLIPSE DOUBLE LAYER SHADE	PG 11
HONEYCOMB CELLULAR SHADE	PG 12
STANDARD FABRIC FOR ROLLER AND ROMAN SHADES	PG 13
ROLLER SHADE TECHNICAL INFORMATION	
STANDARD ROLLER SHADE	PG 14
4" FASCIA ROLLER SHADE	PG 14
SHADING SOURCE POCKET / FLAP / END CAPS	PG 15
STANDARD SIDE CHANNEL	PG 15
STANDARD BOTTOM RAIL FOR SIDE CHANNEL	PG 15
FLAP AND HANGING STRIP	PG 15
COULISSE ROLLER SHADE	PG 16
COULISSE 3" / 5" FASCIA SHADE	PG 16
COULISSE DUAL ROLLER SHADE	PG 17
COULISSE DUAL ROLLER 5" FASCIA SHADE	PG 17
COULISSE SEMI OPEN CASSETTE	PG 18
COULISSE ULTIMATE CASSETTE	PG 18
COULISSE SQUARE CASSETTE	PG 19
COULISSE SIDE CHANNEL	PG 19
COULISSE BOTTOM RAIL FOR SIDE CHANNEL	PG 19
COULISSE MOTORIZATION	PG 20
CRESTRON MOTORIZATION	PG 20
LUTRON MOTORIZATION	PG 20
SOMFY MOTORIZATION	PG 21
GOLIATH SHADE	PG 22
ROMAN SHADE TECHNICAL INFORMATION	
ROMAN SHADE STYLES	PG 23
ROMAN SHADE STANDARDS AND INFORMATION	PG 24
CORDLOCK ROMAN SHADE – COORDINATING HEADRAIL	PG 25
COULISSE TOP DOWN BOTTOM UP	PG 25
COULISSE ABSOLUTE	PG 26
COULISSE CASSETTE WITH OR WITHOUT FABRIC INSERT	PG 26
BOARD MOUNT OPTIONS	PG 27
VALANCE OPTIONS	PG 27
ROMAN SHADE SPECIFICATIONS AND TECHNICAL INFORMATION	PG 28
DECORATIVE BOTTOM RAIL OPTIONS	
STANDARD BOTTOM RAIL	PG 29
ULTIMATE BOTTOM RAIL	PG 29
WARRANTY / SHIPPING INFORMATION	PG 30

CORNICE



WIDTH: 12" – 200"
HEIGHT: 4" – 24"
DUST CAP & RETURN: 0" – 12"

FINISH OPTIONS:
SELF WELT BORDER\
NAILHEADS – FRENCH PEWTER / NICKEL / BRASS
DACRON PAD
HINGE

FABRIC OPTIONS:
COM DRAPERY / UPHOLSTERY FABRIC
STANDARD ROLLER FABRIC

DRAPERY - GROMMET



GROMMET COLOR OPTIONS:

ANTIQUE BRASS
ANTIQUE COPPER
ANTIQUE NICKEL
ANTIQUE SILVER
BLACK MATTE
BRASS
NICKEL
SATIN NICKEL

FULLNESS 200%

TOP OF GROMMET TO
TOP OF DRAPERY PANEL $\frac{3}{4}$ "



DRAPERY – PINCH PLEAT



PLEAT OPTIONS – DOUBLE OR TRIPLE
TACK OPTIONS – TACK TOP OR BOTTOM
FULLNESS – DOUBLE 200%
FULLNESS – TRIPLE 200% / 250% / 300%

BUCKRAM SIZES – 2 / 3 / 4 / 5
SINGLE OR DOUBLE TURNED TOP FOR UNLINED
CLEAN FINISHED TOP FOR LINED
MICROFLEX PINS INCLUDED

Pleater to hide seams on front or back side of pleat.
Spacing and pleat size will change from left to right.

Panel will finish at exact width from pleat to pleat for operable panels. Stationary panels may vary.

Lead & Returns are added to the width measurement and should be specified for each panel.



DRAPERY – SPECIALTY PLEAT



GOBLET PLEAT
INVERTED PLEAT
FULLNESS – 200%

BUCKRAM SIZES – 2 / 3 / 4 / 5
SINGLE OR DOUBLE TURNED TOP FOR UNLINED
CLEAN FINISHED TOP FOR LINED
MICROFLEX PINS INCLUDED

Pleater to hide seams on front or back side of pleat.
Spacing and pleat size will change from left to right.



Panel will finish at exact width from pleat to pleat for operable panels. Stationary panels may vary.

Lead & Returns are added to the width measurement and should be specified for each panel.



MICROFLEX PINS:
PLEATER SEWS INTO PLEATS
ADJUSTABLE ON SITE
SET TO ANY HEIGHT UPON ORDER ENTRY

DRAPERY - RIPPLEFOLD



FULLNESS 60 / 80 / 100 / 120%

ENTERED WIDTH IS FOR TRACK WIDTH AND EVEN QTY OF SNAPS

LEAD AND RETURN ADDED TO TRACK WIDTH AND EVEN SNAPS
SNAP DISTANCES FOR LEAD MUST MATCH THE LEAD SIZE
HIDDEN SEAMS INCLUDED

STANDARD RIPPLEFOLD CARRIER DISTANCES

FOREST
DRAPERY HARDWARE

KIRSCH

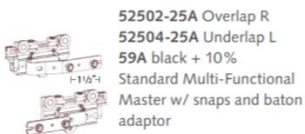

52502-25A Overlap R
52504-25A Underlap L
59A black + 10%
Standard Multi-Functional
Master w/ snaps and baton
adaptor

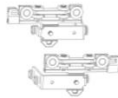

52411-25A Butt R
52412-25A Butt L
24A gold, 59A black,
65A brown, 90A silver
Wheeled Butt Master
w/snap adaptor
Designed for hidden baton



Overlap Master
Cord Draw
One-Way/Two-Way
(84103xxx)



Overlap Master
Baton Draw
One-Way/Two-Way
(84204xxx)



Butt Master
Cord Draw
One-Way/Two-Way
(84111xxx)

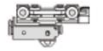

Butt Master
Baton Draw
One-Way/Two-Way
(84211xxx)

FOREST CS OVERLAP - 52502A/52504A = 5.75 (1.5-4.25)
Snap 1-2= 1.5
Snap 2-3=4.25

FOREST CS BUTT - 52411A/52412A = 5.25 (1-4.25)
Snap 1-2= 1
Snap 2-3=4.25

KIRSCH OVERLAP - 84103/84204 = 7 (2.75-4.25)
Snap 1-2= 2.75
Snap 2-3= 4.25

KIRSCH BUTT BATON - 84211 = 5.25 (1-4.25)
Snap 1-2= 1
Snap 2-3= 4.25

KIRSCH BUTT CORD - 84111 = 1 (1-0)
Snap 1-2= 1
Snap 2-3= 0

somfy

Overlap Arm - #1782320

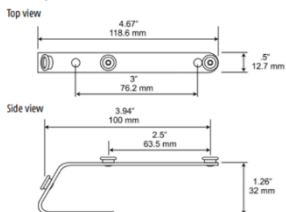

SOMFY OVERLAP #1782320 = 6.75 (2.5-4.25)
Snap 1-2= 2.5
Snap 2-3=4.25

Straight Arm - #1782321

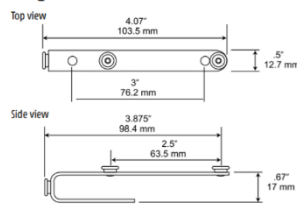

SOMFY STRAIGHT #1782321 = 4.25 (4.25-0)
Snap 1-2= 4.25
Snap 2-3=0

One Way Butt Arm - #1782319

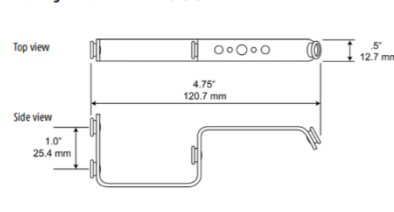

SOMFY ONE WAY BUTT #1782319 = 5.25 (1-4.25)
Snap 1-2= 1
Snap 2-3=4.25

Butt Master Arm Center Opening - #1780953

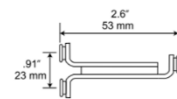

SOMFY CENTER BUTT #1780953 = 5.25 (1-4.25)
Snap 1-2= 1
Snap 2-3=4.25

DRAPERY – ROD POCKET



ORDERED BY # OF WIDTHS
 ½ WIDTH INCREMENTS

3" FLANGE OPTIONAL
 MAX POCKET SIZE – 3" WITH 3" FLANGE

DRAPERY – LINING OPTIONS

Lining Type	Content	Colors
Privacy	50/50 Poly Cotton	White & Ivory
	100% Cotton Sateen	White & Ivory
Blackout	50/50 Poly Cotton	White
	100% Cotton Outblack	White & Ivory
Thermal	100% Polyester	White & Ivory
Napped	100% Cotton	White & Ivory
Interlining	100% Cotton	White & Ivory

Specialty Lining Options
Self-Lined with Face Fabric
Self Interlined with Face + Interlining
Contrast Fabric Lined
Contrast Fabric Interlined

MANUAL DRAPERY TRACKS



CEILING



3" WALL

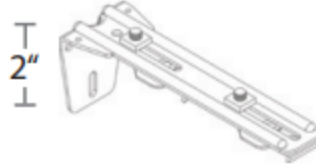

6" ADJUSTABLE
DOUBLE WALL

INCLUDED OPTIONS:

STATIONARY OR OPERABLE
OPERABLE INCLUDE FIBERGLASS WAND
36-48-60-72 LENGTHS AVAILABLE

BRACKET OPTIONS:

CEILING
WALL
DOUBLE WALL

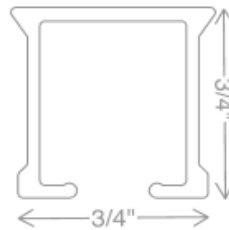

SPECIFIC SPLICE LOCATIONS

PINCH PLEAT:

CARRIER OPTIONS – OVERLAP OR BUTT

RIPPLEFOLD:

FULLNESS 60 / 80 / 100 / 120%
CARRIER OPTIONS – OVERLAP OR BUTT

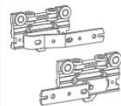

52502-25 Overlap R
52504-25 Underlap L

Standard Multi-Functional Master
Use stiffener w/ exposed baton
or hooks w/ hidden baton

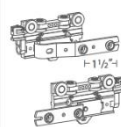

52502-25A Overlap R
52504-25A Underlap L
59A black + 10%

Standard Multi-Functional
Master w/ snaps and baton
adaptor

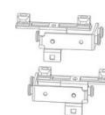

52410-25 Butt R
52409-25 Butt L
59 black + 10%
Standard Butt Master
w/ snaps and for baton use

MOTORIZED DRAPERY TRACKS

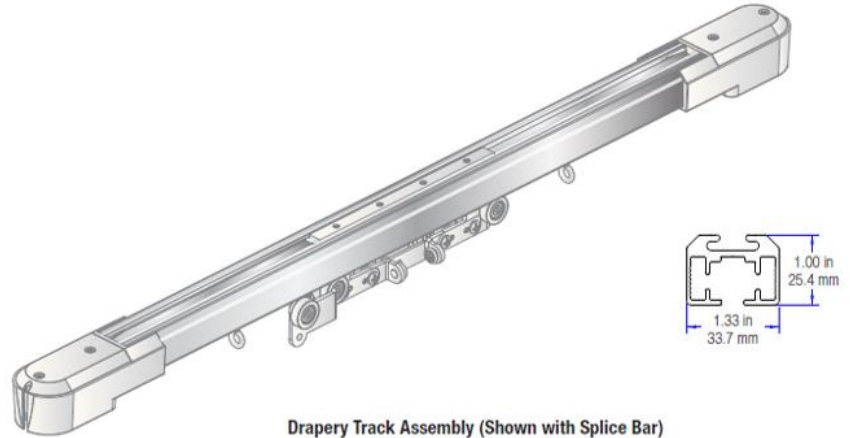

Drapery Track Assembly (Shown with Splice Bar)
(CSA-DRP-TRACK-ASM)

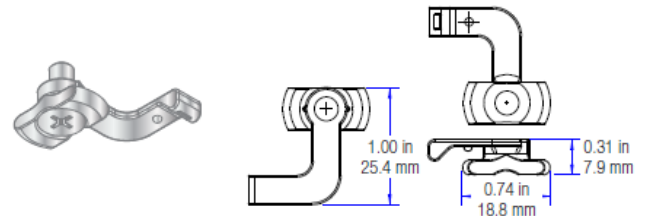

Cam Lock Mounting Bracket (Qty. 2)
(CSA-DRP-CAM-LOCK)

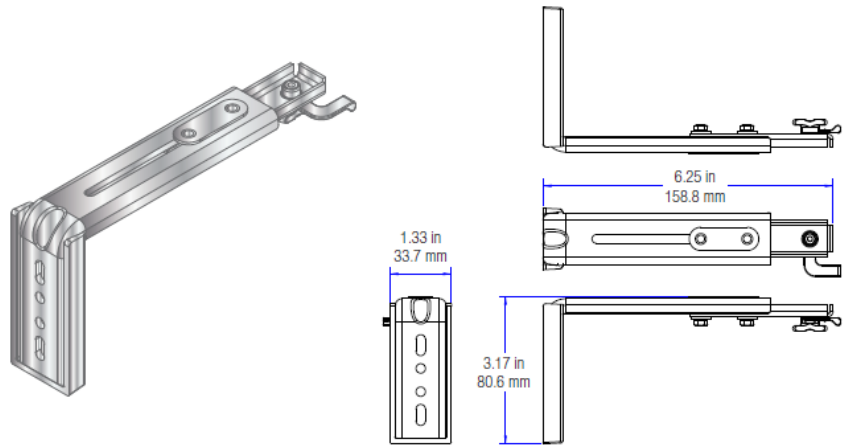

Mounting Bracket, Single (Qty. 2)
(CSA-DRP-BRKT)

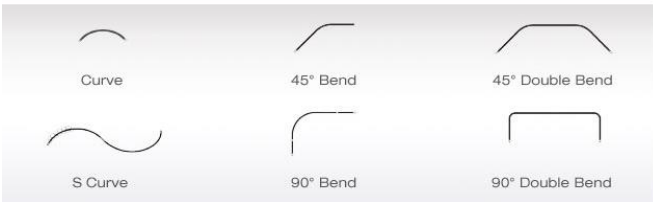

CRESNET	PINCH PLEAT	MAX WIDTH	240
		MAX LBS	145
INFINITEX	RIPPLEFOLD	MAX WIDTH	240
		MAX LBS	145

MOTORIZED DRAPERY TRACKS



Ceiling mount application

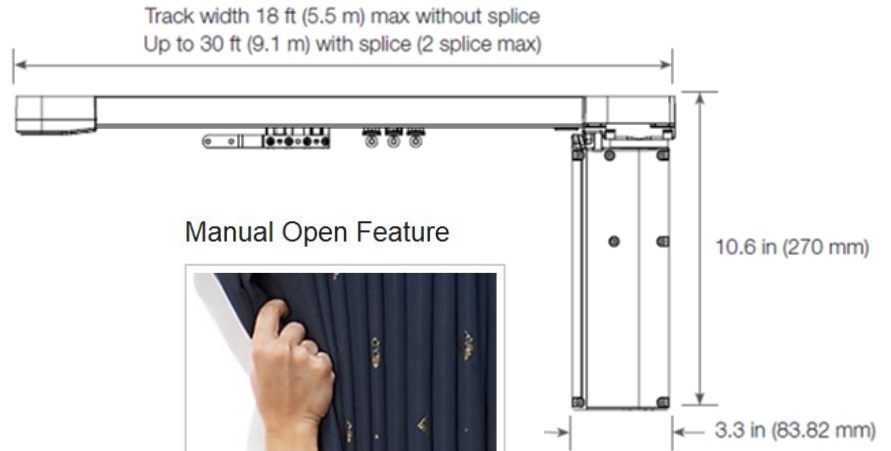
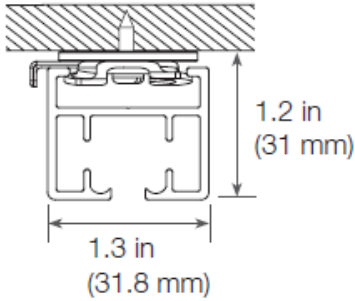

Manual Open Feature



Pocket mount application

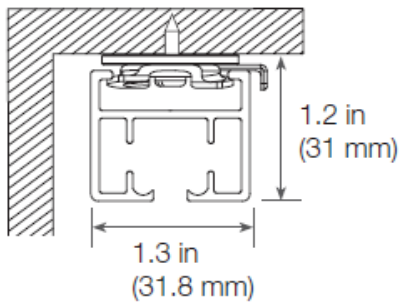

Wall mount bracket

Minimum extension

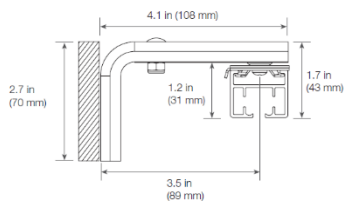

Maximum extension

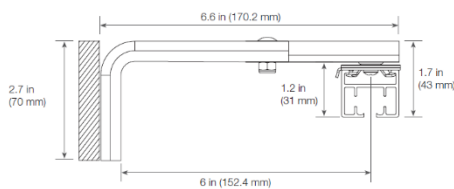

Curve

D105, D145, or D175



Bend

D105, D145, or D175

Double bend system can be created with tandem single-bend systems.



Double Curve

D145 or D175

Double curve tracks will typically incorporate a splice along a middle straight section for ease of shipping.



Double Bend

D145 or D175

Double bend tracks will typically incorporate a splice along the middle straight section for ease of shipping.

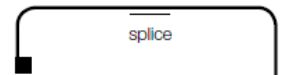

D105	PINCH PLEAT	WIDTH	32	44	56	68	84	108	132	168
		LBS	20	30	40	55	65	80	100	80
D105	RIPPLEFOLD	WIDTH	32	44	56	68	84	108	132	168
		LBS	30	40	55	70	85	65	65	65
D145	PINCH PLEAT	WIDTH	32	44	56	68	84	108	132	168
		LBS	20	30	40	55	65	80	105	145
D145	RIPPLEFOLD	WIDTH	32	44	56	68	84	108	132	168
		LBS	30	40	55	70	85	105	140	125
D175	PINCH PLEAT	WIDTH	32	44	56	68	84	108	132	168
		LBS	20	30	40	55	65	80	105	130
D175	RIPPLEFOLD	WIDTH	32	44	56	68	84	108	132	168
		LBS	30	40	55	70	85	105	140	165

MOTORIZED DRAPERY TRACKS



CEILING BRACKET

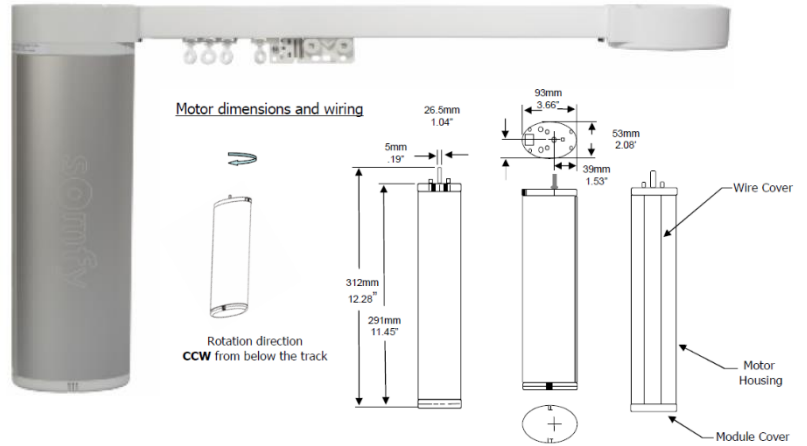
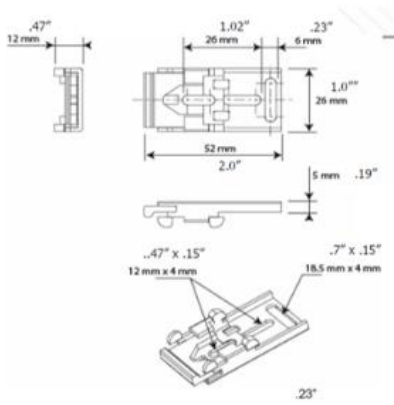

WALL BRACKET

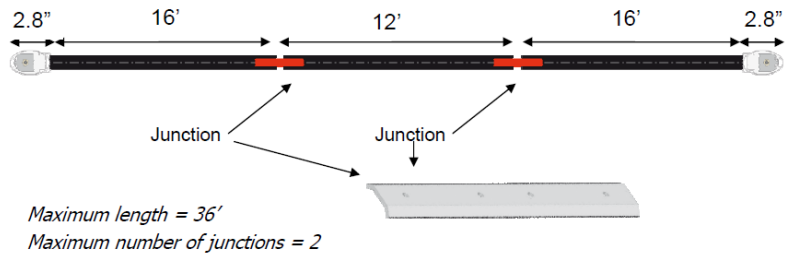
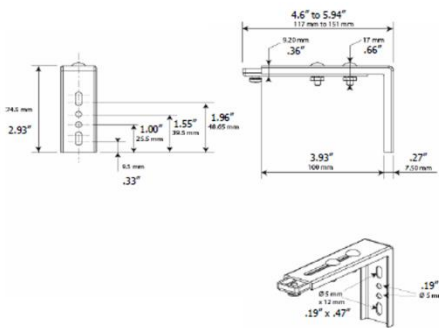

For bending and curving tracks length and radius limitation please refer to the specific data sheet

PINCH PLEAT

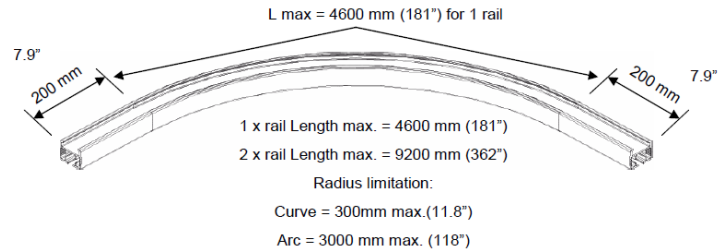
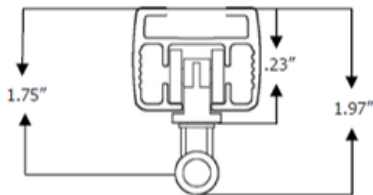

Due to the bending process 200 mm (7.87") of the rail still straight on the both side of the curve or arc shape.

RIPPLEFOLD

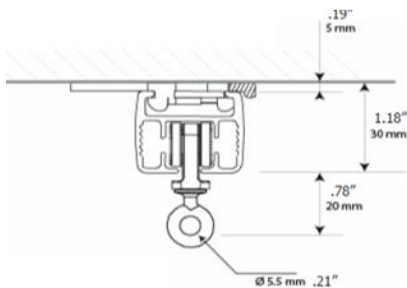

	MOTOR	LB LIMIT
GLYDEA	60E	132
	WIRED	132
IRISMO	12V	99

ECLIPSE DOUBLE LAYER SHADE

SEMI OPEN CASSETTE COLORS

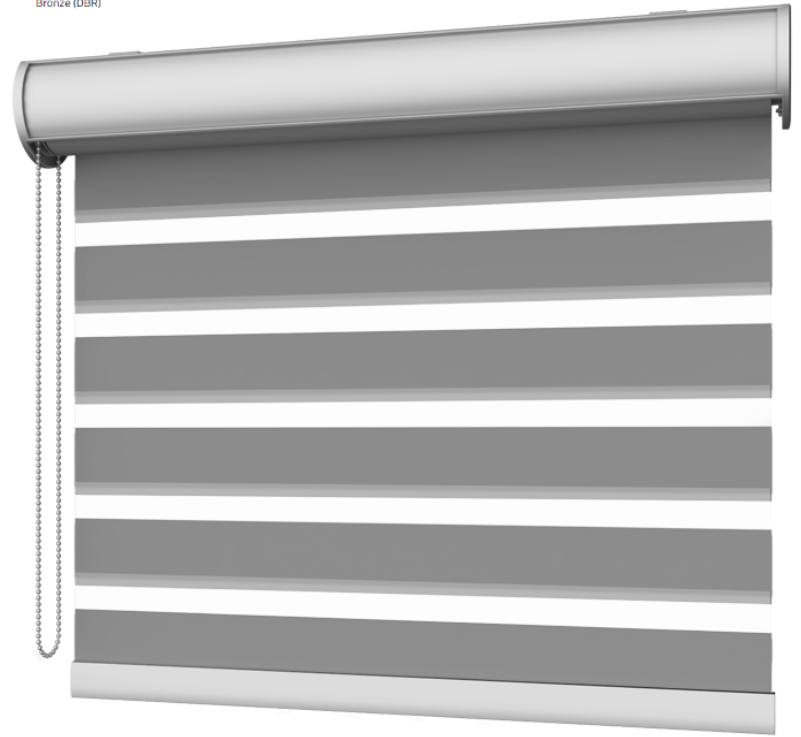
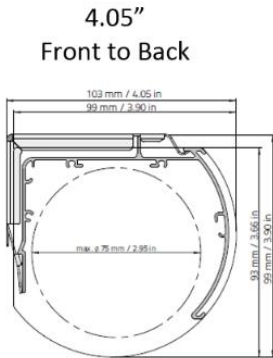

coulisse

somfy

LIFT OPTIONS AVAILABLE:
CONTINUOUS
TWIN PULL
CM-02 WAND PULL
CM-03 WAND PULL / RTS
CM-09 HARD WIRE SWITCH
CM-09 110V RTS

LIFT OPTIONS AVAILABLE:
MOTORIZED ST28 LI-ION
MOTORIZED ST30 24V RTS
MOTORIZED ST30 LI-ION UQ RTS
MOTORIZED 403 RTS LI-ION
MOTORIZED 404 RTS

DOUBLE LAYER SHADE FABRICS

FABRIC NAME	STYLE	FR	MANUFACTURER	PRICE	WIDTH
Dixie	LIGHT FILTERING	N	Top	2	96
Linen	SCR	N	Top	3	96
Mambo	SHEER	N	Top	2	96
Seasons	LIGHT FILTERING	N	Top	1	96
Tango	BLACKOUT	N	Top	5	96

HONEYCOMB CELLULAR SHADE

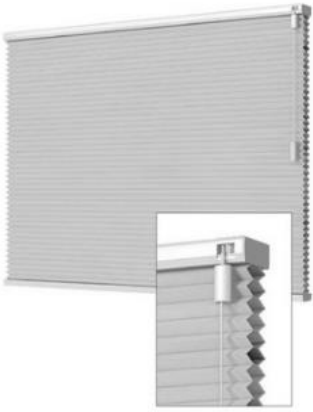

CORDLOCK

BOTTOM UP OR
TOP DOWN BOTTOM UP

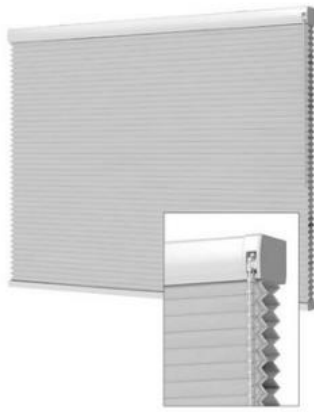

CONTINUOUS CORD

BOTTOM UP OR
TOP DOWN BOTTOM UP

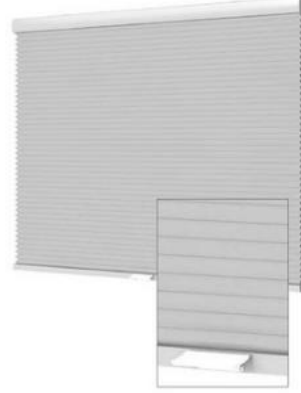

CORDLESS

BOTTOM UP OR
TOP DOWN BOTTOM UP



MOTORIZED WAND PULL

CM03 WAND OR RTS
RECHARGEABLE

MOTORIZED SOMFY REMOTE

TL25 RTS – BATTERY WAND

BOTTOM UP ONLY



HEADRAILS & CORDS COLOR COORDINATED TO FABRICS

2.5" DEPTH

WAND IS SILVER FOR MOTOR 24" – 48" – 60"

DEPENDING ON SHADE LENGTH



White (W)

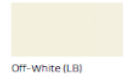

Off-White (LB)



Grey (GR) / Anodized (A)



Anthracite (AN)

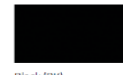

Black (BK)

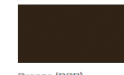

Bronze (DBR)

HONEYCOMB CELLULAR SHADE FABRICS

FABRIC NAME	STYLE	FR	MANUFACTURER	PRICE GROUP	WIDTH
Devon	LIGHT FILTERING	N	Coulisse	5	144
Halifax	BLACKOUT	N	Coulisse	3	144
Halifax	LIGHT FILTERING	N	Coulisse	2	144
Rioja	BLACKOUT	N	Coulisse	2	144
Rioja	LIGHT FILTERING	N	Coulisse	1	144

STANDARD SHADE FABRICS

FABRIC NAME	STYLE	FR	MANUFACTURER	PRICE GROUP	WIDTH	ROLLER RAILROAD	ROMAN RAILROAD OR SEAM
3000 Series 1% (Essential)	SCR	Y	Coulisse	2	118	YES	RAILROAD
3000 Series 3% (Essential)	SCR	Y	Coulisse	2	98	YES	RAILROAD
3000 Series 5% (Essential)	SCR	Y	Coulisse	2	118	YES	RAILROAD
3000 Series 10% (Essential)	SCR	Y	Coulisse	2	98	YES	RAILROAD
Aretha	TRANS		Coulisse	4	94	NO	SEAM - MAX WIDTH 168"
Bali	WOVEN		Coulisse	3	79	NO	SEAM - MAX WIDTH 168"
Beijing	WOVEN		Coulisse	2	94	NO	SEAM - MAX WIDTH 168"
Berlin Blackout	BO		Coulisse	2	98	YES	RAILROAD
Berlin Transparent	TRANS		Coulisse	1	98	YES	RAILROAD
Bombay	TRANS		Coulisse	6	94	NO	SEAM - MAX WIDTH 168"
C Screen Linen	SCR	N	Top Window Coverings	2	110	NO	SEAM - MAX WIDTH 168"
Como	BO	Y	Coulisse	4	110	NO	SEAM - MAX WIDTH 168"
Durban	WOVEN		Coulisse	5	110	NO	SEAM - MAX WIDTH 168"
Esvedra	TRANS		Coulisse	1	110	YES	RAILROAD
Graphic JA 21001	TRANS		Coulisse	4	110	NO	SEAM - MAX WIDTH 168"
Gunsang & Gun Spangl	WOVEN		Coulisse	6	79	NO	SEAM - MAX WIDTH 168"
Hampton	BO		Coulisse	6	110	NO	SEAM - MAX WIDTH 168"
Hampton	TRANS		Coulisse	5	110	NO	SEAM - MAX WIDTH 168"
Hong Kong	WOVEN		Coulisse	3	71	NO	SEAM - MAX WIDTH 168"
Lin	WOVEN		Coulisse	2	71	NO	SEAM - MAX WIDTH 168"
Linen	TRANS		Coulisse	5	98	YES	RAILROAD
Mexico	BO	Y	Coulisse	5	110	NO	SEAM - MAX WIDTH 168"
Mambo	TRANS		Top Window Coverings	2	110	NO	SEAM - MAX WIDTH 168"
Miami	BO	Y	Coulisse	4	110	YES	RAILROAD
Mombassa	BO		Coulisse	6	118	NO	SEAM - MAX WIDTH 168"
Mombassa	TRANS		Coulisse	5	118	NO	SEAM - MAX WIDTH 168"
PAP1	WOVEN		Coulisse	2	71	NO	SEAM - MAX WIDTH 168"
PAP 2 - PAP 7	WOVEN		Coulisse	2	94	NO	SEAM - MAX WIDTH 168"
Orient	BO	Y	Top Window Coverings	2	110	YES	RAILROAD
Orient	TRANS	Y	Top Window Coverings	1	110	YES	RAILROAD
Paris	TRANS	Y	Coulisse	4	94	YES	RAILROAD
Puglia	TRANS		Top Window Coverings	2	110	NO	SEAM - MAX WIDTH 168"
Rimini	TRANS		Top Window Coverings	2	110	NO	SEAM - MAX WIDTH 168"
Rings	SCR		Coulisse	4	118	NO	SEAM - MAX WIDTH 168"
Salvador	TRANS		Coulisse	4	94	YES	RAILROAD
Santiago	BO	Y	Coulisse	4	110	YES	RAILROAD
Style 3%	SCR		Coulisse	4	118	NO	SEAM - MAX WIDTH 168"
SW 2360	SCR	Y	Phifer	3	126	YES	RAILROAD
SW 2390	SCR	Y	Phifer	3	126	YES	RAILROAD
SW 2410	SCR	Y	Phifer	3	126	YES	RAILROAD
SW 2500	SCR	Y	Phifer	4	126	YES	RAILROAD
SW 5000	SEE SWATCH CARD	*	Phifer	4	98	YES	RAILROAD
SW 7000	BO	Y	Phifer	6	118	YES	RAILROAD
SW 7400	BO	Y	Phifer	6	118	NO	SEAM - MAX WIDTH 168"
SW 7450	TRANS		Phifer	5	118	NO	SEAM - MAX WIDTH 168"
SW 7800	BO	Y	Phifer	6	118	NO	SEAM - MAX WIDTH 168"
SW 7850	TRANS	Y	Phifer	5	118	NO	SEAM - MAX WIDTH 168"

* Please consult the manufacturer specification for FR ratings on each color of this fabric

STANDARD ROLLER SHADES

ROLLEASE PARTS OR EQUAL
 R16 CLUTCH 1:1 (WHITE ONLY)
 BRACKETS (WHITE ONLY)
 END PLUG (WHITE ONLY)
 CONTINUOUS LOOP CHAIN
 1.5" OR 2" TUBE
 SEALED HEMBAR POCKET

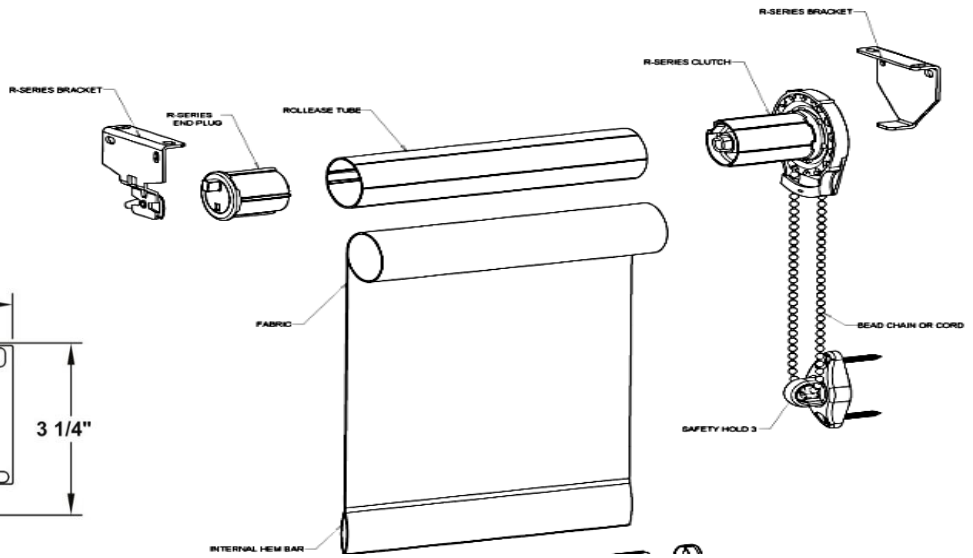
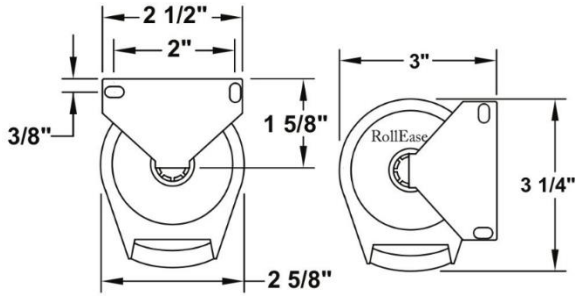

STANDARD 4" FASCIA

4" FASCIA COLORS

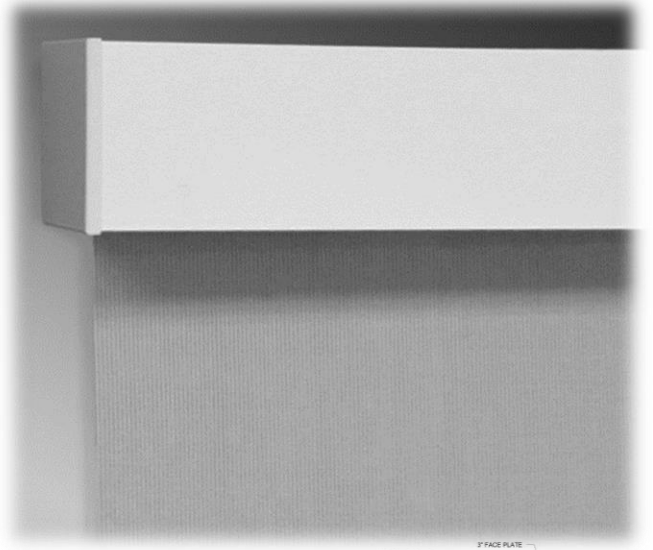
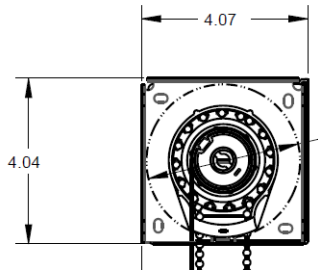

MANUAL LIFT OPTIONS AVAILABLE:
 CONTINUOUS

MOTORIZED LIFT OPTIONS AVAILABLE:



LIFT OPTIONS AVAILABLE:
 MOTORIZED ST28 LI-ION
 MOTORIZED ST30 24V RTS
 MOTORIZED ST30 LI-ION RTS
 MOTORIZED 403 RTS LI-ION
 MOTORIZED 404 RTS
 MOTORIZED 506 RTS

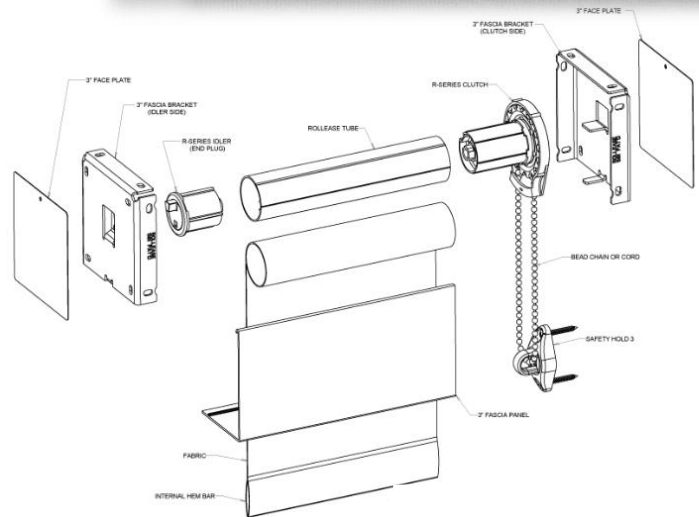

SHADING SOURCE METAL EXTRUSIONS

POCKET ENCLOSURE / RECESSED

4.75" x 5" Pocket / Flap / End Caps

Standard: White

Special Order Powder Coat Available

All Motors Available in this top treatment

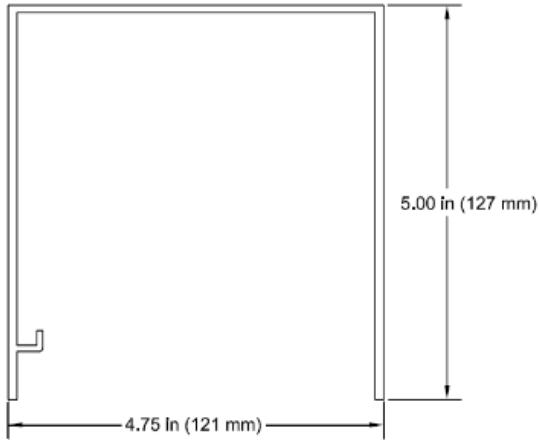

3.5" x 3.5" Pocket / Flap / End Caps

Standard: White

Special Order Powder Coat Available

Motors Available:

Crestron – 163 Decor

Lutron – QS 64

Somfy – ST28 and ST30

Somfy – 404 and 409

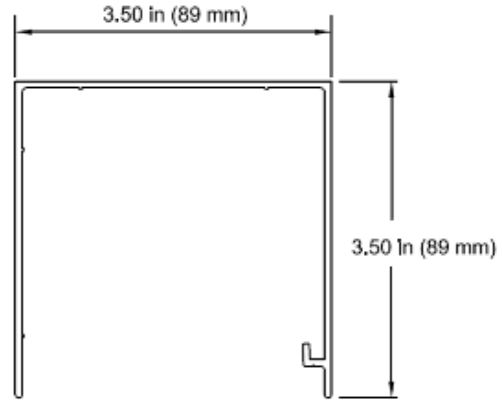

STANDARD SIDE CHANNEL

1.5" Side Channel

Standard: White

Brush in Front and Back

Felt: Black / Grey / White

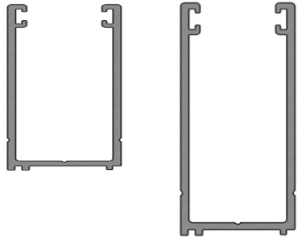

2.5" Side Channel

Standard: White / Anodized

Brush in Front and Back

Felt: Black / Grey / White

STANDARD BOTTOM RAIL

1 1/4" Standard Bottom Rail

Standard: White / Anodized

Fits into Side Channel

Coordinating Plastic End Caps

Felt: Black / Grey / White



FLAP & HANGING STRIP

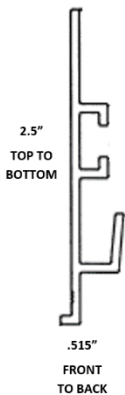

Hanging Strip

Standard: White

Fits 2.38" or 6" Flap



2.38" Flap
Standard: White



6" Flap
Standard: White

COULISSE ROLLER SHADES

PLASTIC END CAP COLORS



METAL END CAP COLORS



LIFT OPTIONS AVAILABLE:
CONTINUOUS
CORDLESS
CM-02 WAND PULL
CM-09 HARD WIRE SWITCH
CM-09 110V RTS

LIFT OPTIONS AVAILABLE:
MOTORIZED ST28 LI-ION
MOTORIZED ST30 24V RTS
MOTORIZED ST30 LI-ION RTS
MOTORIZED 403 RTS LI-ION
MOTORIZED 404 RTS

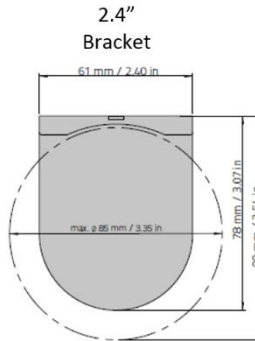

3.54"
Top of
Bracket to
bottom of
shade



COULISSE 3" OR 5" FASCIA

3" FASCIA COLORS

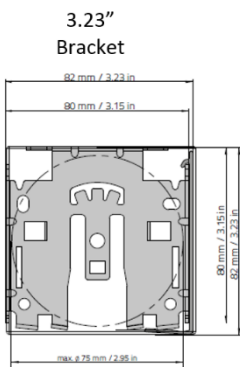

3.23"
Bracket

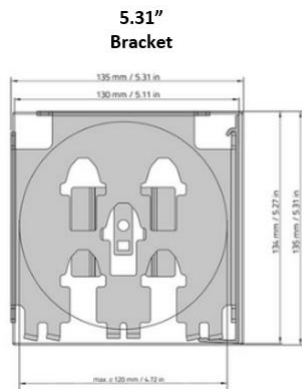

5.31"
Bracket



LIFT OPTIONS AVAILABLE:
CONTINUOUS
CORDLESS
CM-02 WAND PULL
CM-09 HARD WIRE SWITCH
CM-09 110V RTS

LIFT OPTIONS AVAILABLE:
MOTORIZED ST28 LI-ION
MOTORIZED ST30 24V RTS
MOTORIZED ST30 LI-ION RTS
MOTORIZED 403 RTS LI-ION
MOTORIZED 404 RTS



COULISSE DUAL ROLLER SHADES

BRACKET COLORS

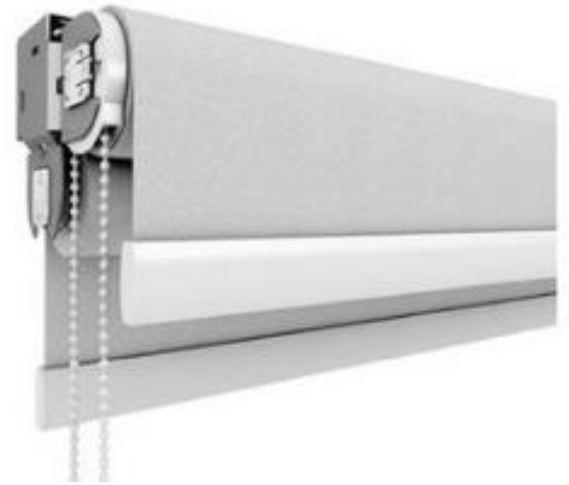
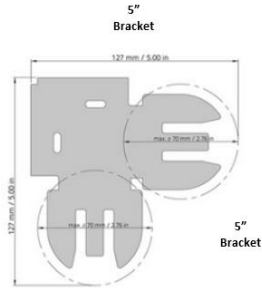

coulisse

somfy

LIFT OPTIONS AVAILABLE:
CONTINUOUS
CORDLESS
CM-02 WAND PULL
CM-09 HARD WIRE SWITCH
CM-09 110V RTS

LIFT OPTIONS AVAILABLE:
MOTORIZED ST28 LI-ION
MOTORIZED ST30 24V RTS
MOTORIZED ST30 LI-ION RTS
MOTORIZED 403 RTS LI-ION
MOTORIZED 404 RTS

COULISSE DUAL 5" FASCIA

5" FASCIA COLORS

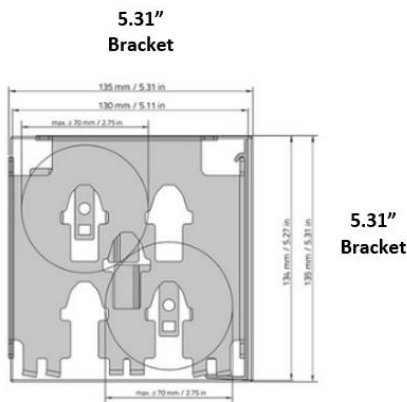

coulisse

somfy

LIFT OPTIONS AVAILABLE:
CONTINUOUS
CORDLESS
CM-02 WAND PULL
CM-09 HARD WIRE SWITCH
CM-09 110V RTS

LIFT OPTIONS AVAILABLE:
MOTORIZED ST28 LI-ION
MOTORIZED ST30 24V RTS
MOTORIZED ST30 LI-ION RTS
MOTORIZED 403 RTS LI-ION
MOTORIZED 404 RTS

COULISSE SEMI OPEN CASSETTE

SEMI OPEN CASSETTE COLORS

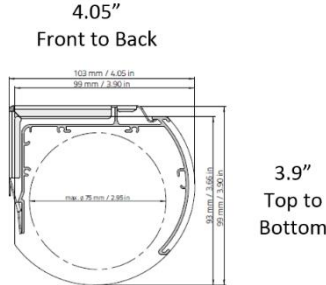

coulisse

somfy

LIFT OPTIONS AVAILABLE:
CONTINUOUS
CORDLESS
CM-02 WAND PULL
CM-09 HARD WIRE SWITCH
CM-09 110V RTS

LIFT OPTIONS AVAILABLE:
MOTORIZED ST28 LI-ION
MOTORIZED ST30 24V RTS
MOTORIZED ST30 LI-ION RTS
MOTORIZED 403 RTS LI-ION
MOTORIZED 404 RTS

COULISSE ULTIMATE CASSETTE

ULTIMATE CASSETTE COLORS

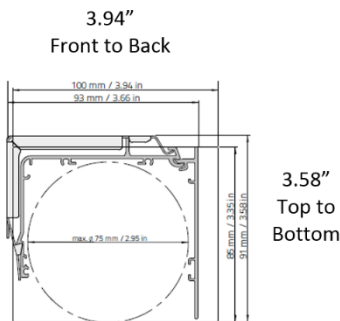
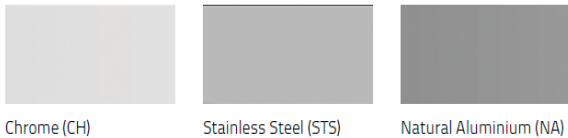

coulisse

somfy

LIFT OPTIONS AVAILABLE:
CONTINUOUS
CORDLESS
CM-02 WAND PULL
CM-09 HARD WIRE SWITCH
CM-09 110V RTS

LIFT OPTIONS AVAILABLE:
MOTORIZED ST28 LI-ION
MOTORIZED ST30 24V RTS
MOTORIZED ST30 LI-ION RTS
MOTORIZED 403 RTS LI-ION
MOTORIZED 404 RTS

COULISSE SQUARE CASSETTE

SQUARE CASSETTE & SIDE CHANNEL COLORS



3.66"
Front to Back

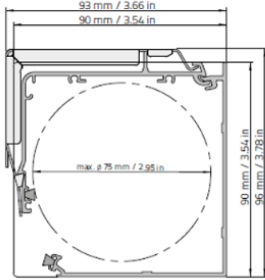

3.78"
Top to Bottom



coulisse

somfy

LIFT OPTIONS AVAILABLE:
CONTINUOUS
CORDLESS
CM-02 WAND PULL
CM-09 HARD WIRE SWITCH
CM-09 110V RTS

LIFT OPTIONS AVAILABLE:
MOTORIZED ST28 LI-ION
MOTORIZED ST30 24V RTS
MOTORIZED ST30 LI-ION RTS
MOTORIZED 403 RTS LI-ION
MOTORIZED 404 RTS

OPTIONAL SIDE CHANNEL - BOTTOM RAIL - BOTTOM CHANNEL FOR SQUARE CASSETTE / 3" FASCIA / 5" FASCIA

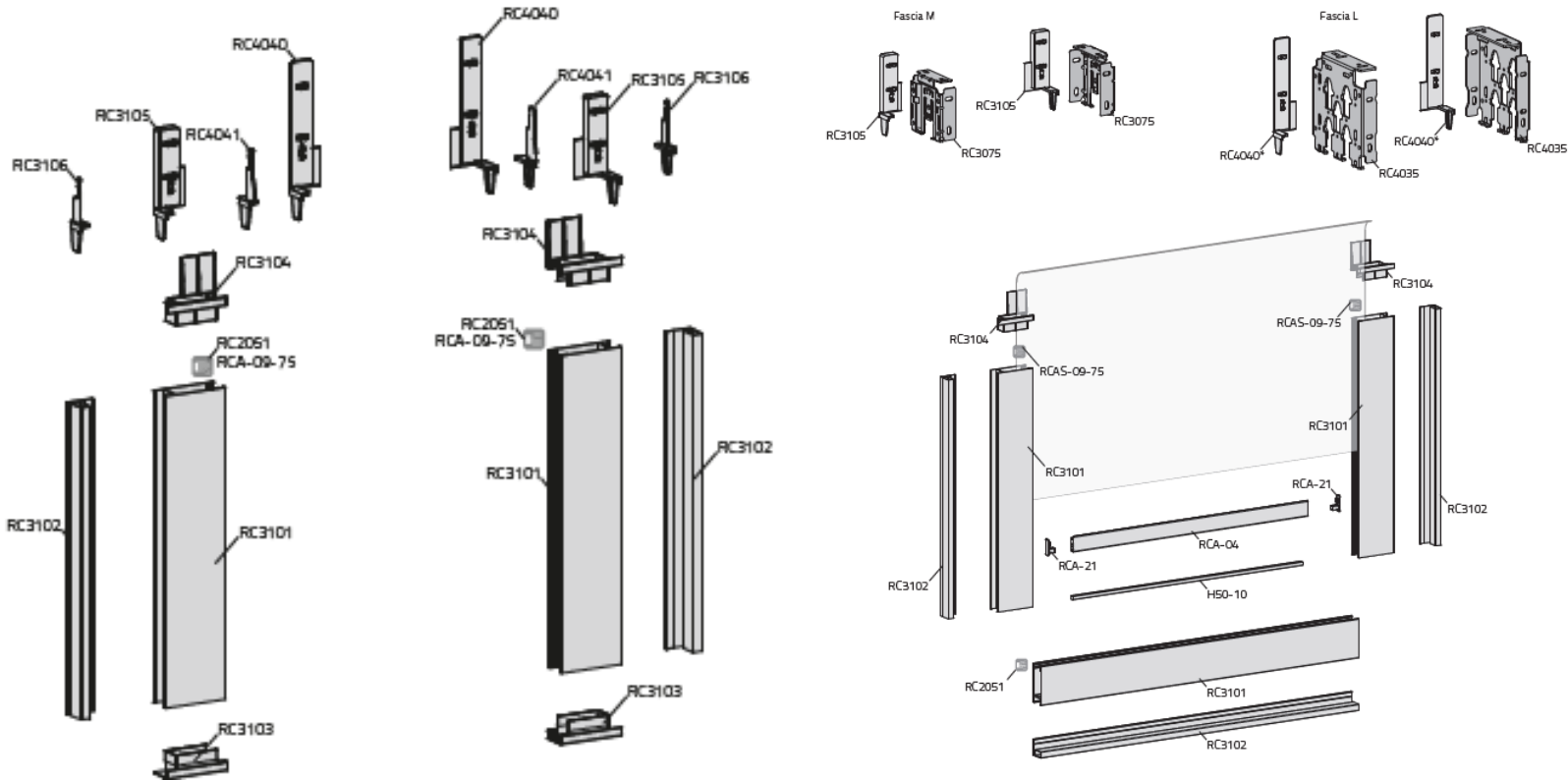

MOTORIZED ROLLER SHADES

coulisse

		MIN WIDTH	COUPLE
CM-02	WAND PULL BATTERY 12V		N
CM-09-MC	120V WIRE MOTOR WITH SWITCH		N
CM-09-QC120	120V RTS MOTOR		N

COULISSE ACCESSORIES
1 CHANNEL REMOTE BLACK
5 CHANNEL REMOTE BLACK
15 CHANNEL REMOTE BLACK
1 CHANNEL WALL REMOTE WHITE

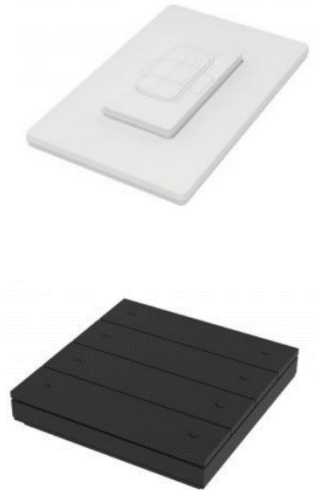

		MIN WIDTH	POCKET	COUPLE
163 CRESNET / INFINETEX	MAX 64 SF OR 96" WIDTH	17	3.5 X 3.5	N
250 CRESNET / INFINETEX	MAX 200 SF OR 144" WIDTH	24	4.75 X 5	Y
275 CRESNET / INFINETEX	MAX 200 SF OR 180" WIDTH	30	4.75 X 5	Y

CRESTRON ACCESSORIES	
INLINE COUPLER	1 FOR 2 PANEL COUPLED
ANGLED COUPLER	1 FOR 2 PANEL COUPLED
CORNER COUPLER	1 FOR 2 PANEL COUPLED
PYNG HUB	WIRELESS CONTROL



QS WIRED MOTORS		MIN WIDTH	POCKET	COUPLE
64-QS	MAX 64 SF OR 96"	18.5"	3.5 X 3.5	N
100-QS	MAX 100 SF OR 180"	24"	4.75 X 5	Y
150-QS	MAX 150 SF OR 180"	24"	4.75 X 5	Y
300-QS	MAX 300 SF OR 180"	27"	4.75 X 5	Y

LUTRON ACCESSORIES	
INLINE COUPLER	MAX 3 PANELS
ANGLED COUPLER	MAX 3 PANELS
DUAL BRACKET	
DUAL COUPLED BRACKET	
CASETA SMART BRIDGE	WIRELESS CONTROL
DONGLE	RF RECEIVER - 1 PER SHADE
PICO SINGLE CHANNEL	1 CHANNEL REMOTE
PICO MULTI CHANNEL	5 CHANNEL REMOTE
SINGLE POWER SUPPLY	POWER FOR 1 MOTOR
QSPS 10 POWER SUPPLY	POWER FOR 10 MOTORS



PICO SINGLE SHADE REMOTE



MULTI SHADE REMOTE

MOTORIZED ROLLER SHADES



AUTOMATION & CONTROLS

SOMFY SONESSE RADIO TRANSMITTED					MIN WIDTH	RPM	COUPLE
ST28	SONESSE	12V	RTS	BATTERY - MAX SF 65	15	27	N
ST30	SONESSE	12V	RTS	LI-ION BATTERY WITH CHARGE CORD	27	27	N
ST30	SONESSE	24V	RTS	TRANSFORMER - MAX SF 130	15	27	N
S403	SONESSE	12V	RTS	LI-ION BATTERY WITH CHARGE CORD	36	36	Y
S404	SONESSE	120V	RTS	USE IN CASSETTES ONLY	24	36	N
S506	SONESSE	120V	RTS	MAX SF 196	30	32	Y
SOMFY ULTRA QUIET RADIO TRANSMITTED					MIN WIDTH	RPM	COUPLE
S506	ULTRA	120V	RTS	MAX SF 196	30	24	Y
S506	ULTRA	24V	RTS	MAX SF 220	32	24	Y
SOMFY ALTUS RADIO TRANSMITTED					MIN WIDTH	RPM	COUPLE
S525	ALTUS	120V	RTS	MAX SF 287 - USE FOR 3 PANEL COUPLED	30	38	Y
SOMFY 4 WIRE					MIN WIDTH	RPM	COUPLE
S404	SONESSE	120V	4 WIRE	USE IN CASSETTES ONLY	24	36	Y
S506	SONESSE	120V	4 WIRE	MAX SF 196	30	32	Y

SOMFY ACCESSORIES

RTS ACCESSORIES

SITUO 1	1 CHANNEL REMOTE
SITUO 4	5 CHANNEL REMOTE
SITUO 16	16 CHANNEL REMOTE
DECOFLEX 1	1 CHANNEL WALL SWITCH
DECOFLEX 5	5 CHANNEL WALL SWITCH
BATTERY WAND FOR ST28	FOR BATTERY MOTORS
CHARGER	CHARGER FOR LI-ION MOTOR
CHARGER + EXTENSION	CHARGER + 8' EXTENSION CORD
URTSI	UNIVERSAL RTS INTERFACE II
MY LINK	SMART PHONE / PAD INTERFACE

500 SERIES EXTENSION / CORD REPLACEMENT

6' CORD - SHORTER THAN STANDARD
12' CORD - EXTENSION
24' CORD - EXTENSION

COUPLERS & DUAL COUPLERS

INLINE COUPLER	1 PER COUPLER
ANGLED COUPLER	1 PER COUPLER
CORNER COUPLER	1 PER COUPLER



ALL ACCESSORIES ADDED TO
MANUFACTURED ROLLER
SHADES INCLUDE FABRICATION
AND PROGRAMMING

GOLIATH ROLLER SHADE



PRODUCTION INFO:

MAXIMUM SIZE 24 FEET X 40 FEET

SPECIFIC SEAM PLACEMENT
AVAILABLE TO ALIGN WITH
WINDOW MULLIONS

SPECIAL PREPARATION TO CEILING
REQUIRED DUE TO WEIGHT OF
SHADE

SCAFFOLDING AND WENCH
REQUIRED FOR INSTALLATION

CONTACT YOUR SALES REP FOR
PRICING AND SPECS

MOTORIZATION OR
INTEGRATION COMPATIBLE FOR:



ROMAN SHADE STYLES

STANDARD FABRIC STYLES – SAME AS ROLLER SHADE



FLAT FOLD



**FLAT FOLD
FRONT TUNNEL**



SOFT FOLD



**TRADITIONAL
(NATURE ONLY)**

COM FABRIC STYLES – DRAPERY WEIGHT FABRIC ONLY



FLAT FOLD



**FLAT FOLD
FRONT TUNNEL**



RELAXED



SOFT FOLD



TRADITIONAL

ROMAN SHADE STANDARDS

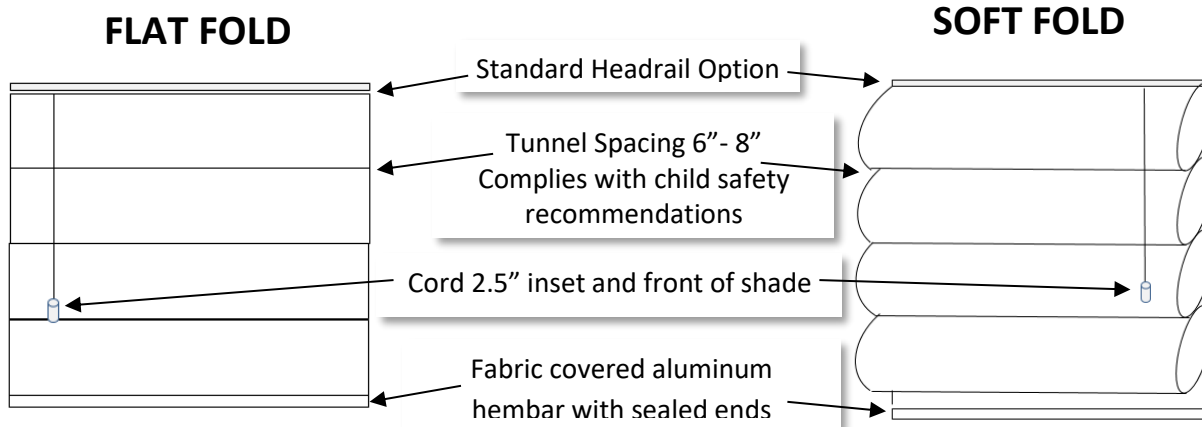

VERTICAL SEAMING & OPTIONS



<--- 12" - 39" ---> <----- 48" - 90" -----> <--- 12" - 39" --->

<-----**MAX WIDTH 168"**----->

Vertical seam placement is factory selected based on overall width of all shades manufactured on the same order. Specific seam placement is available upon request a surcharge of 30% will apply to each seamed shade.

Vertical seams are machine welded for best aesthetic possible.

Blackout Sealant



Specialty tape applied during sewing to cover all stitch holes for truly blackout treatment

Stack Heights

STACK HEIGHT CHART	
SHADE LENGTH	APPROX STACK
15" - 42"	5" - 7"
43" - 62"	6" - 8"
63" - 82"	7" - 9"
83" - 102"	8" - 10"
103" - 122"	9" - 11"
123" - 142"	10" - 12"

Lining Options

Privacy – White
 Privacy – Ivory
 Blackout – White
 C.O.M.

ROMAN MANUAL HEADRAIL OPTIONS

CORDLOCK (STANDARD PRICE LIST)

The color cord lock headrail is included in the price charts and offers 8 colors to choose from. The aluminum headrail encloses all lift mechanisms with a slender profile measuring 5/8" high and 1 1/2" deep with an easy to install bracket. Child safety compliant break away cord, headrail end caps, safety shrouds and lift cords are color coordinated to the headrails. Stainless steel tassel finishes this product.

8 colors to choose from: Headrail colors are factory coordinated or can be chosen at order entry.



AVAILABLE LIFT OPERATION		
CORDLOCK		Y
CONTINUOUS		N
CORDLESS		N
12V BATTERY MOTOR	COULISSE	N
12V BATTERY MOTOR	SOMFY	N
120V MOTOR	COULISSE	N
120V MOTOR	SOMFY	N

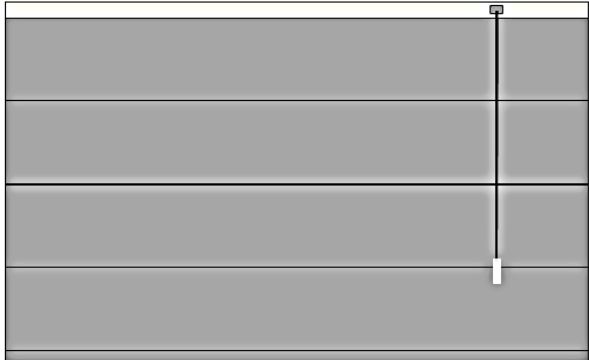

<--- 1 1/2" --->



COULISSE TOP DOWN BOTTOM UP

The absolute top down / bottom up headrail is white with white universal tensioner devices. The aluminum headrail encloses all lift mechanisms with a slender profile measuring 2" high and 1 1/2" deep with an easy to install bracket. Continuous chain options in all available colors.

AVAILABLE LIFT OPERATION		
CORDLOCK		N
CONTINUOUS		Y
CORDLESS		N
12V BATTERY MOTOR	COULISSE	N
12V BATTERY MOTOR	SOMFY	N
120V MOTOR	COULISSE	N
120V MOTOR	SOMFY	N

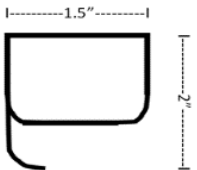

ROMAN MULTI LIFT HEADRAIL OPTIONS

COULISSE ABSOLUTE

The absolute headrail is white and is covered with fabric, attached by velcro for easy adjustment onsite. The headrail is not visible from the front of the shade. End caps are white only. A self lined valance is available for this headrail. Valance is available with or without returns.



AVAILABLE LIFT OPERATION		
CORDLOCK		N
CONTINUOUS		Y
CORDLESS		N
12V BATTERY MOTOR	COULISSE	Y
12V BATTERY MOTOR	SOMFY	N
120V MOTOR	COULISSE	N
120V MOTOR	SOMFY	N

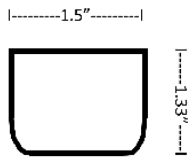

COULISSE CASSETTE

Metal Semi-Open Cassette with coordinating plastic end caps and components. Fabric Insert is available at no extra charge.



AVAILABLE LIFT OPERATION		
CORDLOCK		N
CONTINUOUS		Y
CORDLESS		Y
12V BATTERY MOTOR	COULISSE	Y
12V BATTERY MOTOR	SOMFY	Y
120V MOTOR	COULISSE	Y
120V MOTOR	SOMFY	Y

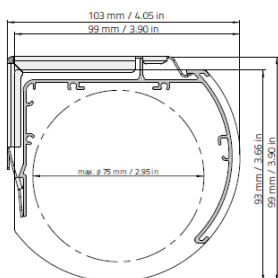

ROMAN BOARD MOUNT OPTIONS

Boards are mill finished in white with exposed wood on sides. All lift options available.

Standard 6" or custom height valance is available with or without returns.

Shown on 2.5" Board with Fabric off Back with Front Valance & Fabric Off Front with Back Valance



**BOARD MOUNT
CONTINUOUS OR CORDLOCK**

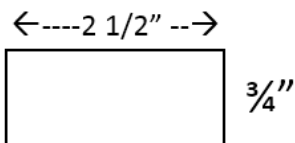

**BOARD MOUNT MOTORIZED
OR MOTOR READY**

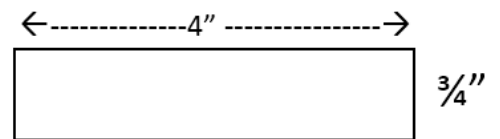

ROMAN VALANCE OPTIONS

STANDARD VALANCE – 6"
CUSTOM VALANCE – 4" - 20"
SELF LINED VALANCE – 6"



Standard or Custom Valance
Shade off back / Valance off Front
Shown with returns
Available without returns
Available with board mount only



Standard or Custom Valance
Shade off front / Valance off back
Shown with returns
Available without returns
Available with board mount only



Self Lined Valance
Show with returns
Available without returns
Available on Absolute & TDBU
Covers headrail and end caps

ROMAN SPECIFICATIONS

ROMAN HEADRAIL SYSTEM	MIN WIDTH	MAX WIDTH	MAX LBS.	INSIDE MOUNT		OUTSIDE MOUNT		FABRIC MOUNT	
				FABRIC	HEADRAIL	FABRIC	HEADRAIL	FABRIC	FABRIC MOUNT HEADRAIL
ABSOLUTE 12V SOMFY MOTORIZED TL25	13	144	10	-0.25	-0.25	-0.25	ORDER	ORDER	ORDER + .25
ABSOLUTE CONTINUOUS	13	144	13	-0.75	-0.25	-0.5	ORDER	ORDER	ORDER + .5
BOARD MOUNT 120V COULISSE MOTORIZED - CM02 (OFF FRONT)	20	168	22	-0.25	-0.25	ORDER	ORDER	ORDER	ORDER
BOARD MOUNT 120V COULISSE MOTORIZED - CM02 (OFF BACK)	20	168	22	-0.25	-0.25	ORDER	ORDER	ORDER	ORDER
BOARD MOUNT 120V COULISSE MOTORIZED - CM09 (OFF FRONT)	20	168	22	-0.25	-0.25	ORDER	ORDER	ORDER	ORDER
BOARD MOUNT 120V COULISSE MOTORIZED - CM09 (OFF BACK)	20	168	22	-0.25	-0.25	ORDER	ORDER	ORDER	ORDER
BOARD MOUNT 12V SOMFY MOTORIZED - ST28 (OFF FRONT)	15	78	13	-0.25	-0.25	ORDER	ORDER	ORDER	ORDER
BOARD MOUNT 12V SOMFY MOTORIZED - ST28 (OFF BACK)	15	78	13	-0.25	-0.25	ORDER	ORDER	ORDER	ORDER
BOARD MOUNT 12V SOMFY MOTORIZED - ST30 (OFF FRONT)	17	78	13	-0.25	-0.25	ORDER	ORDER	ORDER	ORDER
BOARD MOUNT 12V SOMFY MOTORIZED - ST30 (OFF BACK)	17	78	13	-0.25	-0.25	ORDER	ORDER	ORDER	ORDER
BOARD MOUNT 120V SOMFY MOTORIZED - 403 (OFF FRONT)	36	168	22	-0.25	-0.25	ORDER	ORDER	ORDER	ORDER
BOARD MOUNT 120V SOMFY MOTORIZED - 403 (OFF BACK)	26	168	22	-0.25	-0.25	ORDER	ORDER	ORDER	ORDER
BOARD MOUNT 120V SOMFY MOTORIZED - 404 (OFF FRONT)	26	168	22	-0.25	-0.25	ORDER	ORDER	ORDER	ORDER
BOARD MOUNT 120V SOMFY MOTORIZED - 404 (OFF BACK)	26	168	22	-0.25	-0.25	ORDER	ORDER	ORDER	ORDER
BOARD MOUNT 120V SOMFY MOTORIZED - 506 (OFF FRONT)	32	168	33	-0.25	-0.25	ORDER	ORDER	ORDER	ORDER
BOARD MOUNT 120V SOMFY MOTORIZED - 506 (OFF BACK)	32	168	33	-0.25	-0.25	ORDER	ORDER	ORDER	ORDER
BOARD MOUNT CONTINUOUS (OFF FRONT)	12	139	15	-0.5	-0.25	-0.5	ORDER	ORDER	ORDER + .5
BOARD MOUNT CONTINUOUS (OFF BACK)	12	139	15	-0.25	-0.25	ORDER	ORDER	ORDER	ORDER
BOARD MOUNT CORDLESS (OFF FRONT OR BACK)	21	78	6	-0.25	-0.25	ORDER	ORDER	ORDER	ORDER
BOARD MOUNT CORDLOCK - (OFF FRONT OR BACK)	12	108	10	-0.25	-0.25	ORDER	ORDER	ORDER	ORDER
CORDLOCK (STANDARD)	12	78	10	-0.375	-0.25	-0.125	ORDER	ORDER	ORDER + 0.125
SEMI -OPEN CASSETTE 120V COULISSE MOTORIZED	27	137	35	-0.5	-0.25	-0.5	ORDER	ORDER	ORDER + .5
SEMI -OPEN CASSETTE 120V SOMFY MOTORIZED	26	168	50	-0.5	-0.25	-0.5	ORDER	ORDER	ORDER + .5
SEMI -OPEN CASSETTE 12V COULISSE MOTORIZED	20	168	22	-0.5	-0.25	-0.5	ORDER	ORDER	ORDER + .5
SEMI -OPEN CASSETTE 12V SOMFY MOTORIZED	17	78	13	-0.5	-0.25	-0.5	ORDER	ORDER	ORDER + .5
SEMI -OPEN CASSETTE CONTINUOUS	10	137	15	-0.5	-0.25	-0.5	ORDER	ORDER	ORDER + .5
SEMI -OPEN CASSETTE CORDLESS	28	78	6	-0.5	-0.25	-0.5	ORDER	ORDER	ORDER + .5
TOP DOWN BOTTOM UP	24	144	13	-0.5	-0.25	-0.5	ORDER	ORDER	ORDER + .5

ROLLER / ROMAN DECORATIVE BOTTOM RAIL

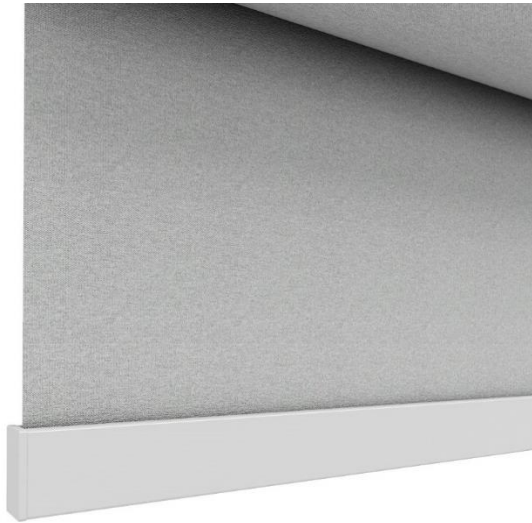

SQUARE BOTTOM RAIL



ULTIMATE BOTTOM RAIL

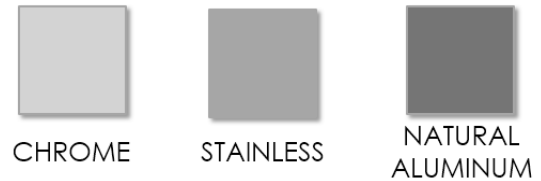

ROLLER / ROMAN CONTINUOUS CHAIN COLOR

PLASTIC CHAIN COLORS (2' 3' 4' 5' 6' 7' 8') * INDICATES CM

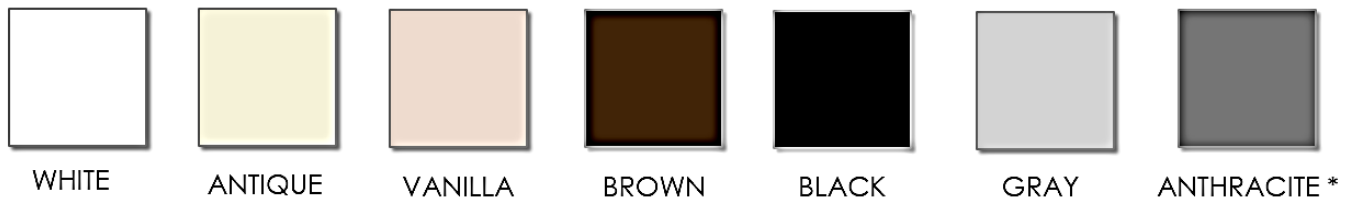

METAL CHAIN COLORS (2' 3' 4' 5' 6' 7' 8')



MANUFACTURED PRODUCT WARRANTY

NON-TRANSFERABLE LIMITED LIFETIME WARRANTY

Included:

Custom made roller & roman shades & drapery tracks are warrantied against manufacturing defects (flaws in product design, materials and workmanship) that may cause the product to malfunction.

Exceptions:

1. Cords are warrantied for 2 years from date of purchase.
2. Somfy warranties its motors to be free from defects in material and workmanship under normal and proper use for a period of 5 years starting from the date stamped on the motor. Accessories are warrantied for 5 years from date of invoice.

Not included:

The warranty does not cover damages and deterioration due to the following reasons:

1. Normal wear and tear of the product including:

Abuse	Exposure to salt air	Improper Operation
Accident	Improper cleaning	Misapplication
Alterations	Improper handling	Misuse
Damage from pets	Improper installation	High wind conditions

In the event that multiple shades are in the same room, only the defective shade will be replaced.

THIS WARRANTY IS GIVEN IN LIEU OF ALL OTHER WARRANTIES, LIABILITIES OR OBLIGATIONS OF SHADING SOURCE INC. NO REPRESENTATIVE OF SHADING SOURCE INC IS AUTHORIZED TO MODIFY OR SUBSTITUTE THIS WARRANTY.

