

**ViaLiteHD**  
**SATCOM6**  
**Outdoor enclosure**

User Manual

HEA-xx-HB-4

CR3974

21/12/18



## Instrument Care and Safety Information

Please read the whole of this section before using your **ViaLiteHD** product. It contains important safety information and will enable you to get the most from your Fibre Optic link.

### Electrical Safety

The **ViaLiteHD** SATCOM6 enclosure provides the termination for power inputs and can be fitted with power supplies.



The **ViaLiteHD** SATCOM6 enclosure is a Safety Class 1 product (having metal chassis directly connected to earth via the power supply cable).

When operating the equipment note the following precautions:

- Hazardous voltages exist within the equipment.
- The enclosure earth stud SHOULD be connected to the safety earth.
- When using a 2 pin power supply cable the enclosure earth stud MUST be connected to the safety earth.
- PSU modules are fused on the mains live feed only. A second fuse should be used for the neutral connection where the polarity of the connectors can be reversed.

### ESD Precautions



Precautions for handling electro-static sensitive devices should be observed when handling all **ViaLiteHD** modules. Technicians should ensure that they use effective personal grounding (i.e. ESD wrist strap etc.) when servicing the equipment. Any equipment or tools used should be grounded to prevent static charge build-up. Good practice should be observed at all times. For reference see relevant standards. EN 61340-5-1, "Protection of Electronic Devices from Electrostatic Phenomena – General Requirements"

### Optical Safety



The **ViaLiteHD** SATCOM6 enclosure may be fitted with optical units

The **ViaLiteHD** RF Transmitter and Transceiver modules contain laser diode sources operating at nominal wavelengths of 1270nm to 1610nm.

These devices are rated as EN60825-1:2007 CLASS 1 radiation emitting devices. A class 1 laser is safe under all conditions of normal use.

When operating the equipment note the following precautions:

- Never look into the end of an optical fibre directly or by reflection either with the naked eye or through an optical instrument.
- Never leave equipment with radiating bare fibres – always cap the connectors.
- Do not remove equipment external covers when operating.

### Hot surface



When operated under full load and elevated temperature the SATCOM6 enclosure can become hot.

Suitable precaution should be taken when handling this device.

- Allow to cool for 10 minutes
- Do not touch metallic surfaces or printed circuit board when hot.

## TABLE OF CONTENTS

1	INITIAL INSPECTION .....	4
2	INTRODUCTION TO THE <i>VIALITEHD</i> RANGE .....	4
3	SATCOM6 SYSTEM DESCRIPTION .....	5
3.1	Backplane connections .....	7
3.2	Glandplate connections .....	9
3.3	External interface connectors and fuses.....	10
3.4	Power system .....	10
3.4.1	Power supplies .....	10
3.4.2	Power Requirements .....	10
3.4.3	Power supply specification .....	11
3.4.4	Thermal load .....	11
4	ENCLOSURE INSTALLATION.....	12
4.1	Cold weather option .....	12
4.2	Cabinet climate option .....	12
5	SYSTEM CONFIGURATION.....	13
5.1	Slots configuration .....	13
5.2	Summary alarm configuration .....	14
5.3	SNMP card configuration .....	14
5.4	Fan operation.....	14
5.5	External D25 connector .....	15
5.6	Using LNBS.....	15
5.6.1	Internal LNBS (up to two LNB power cards may be fitted to the SATCOM6) .....	15
5.6.2	External LNB, power routed via mother board .....	15
5.6.3	External LNB/BUC, using bias tee modules.....	15
5.7	Module Interface ratings.....	15
5.7.1	Logic interface, TTL 5V .....	15
5.7.2	Logic interface, RS232 .....	16
5.7.3	Logic interface, RS422/485 .....	16
5.7.4	Logic interface, I2C.....	16
5.7.5	Logic interface, Open Drain, output .....	16
5.7.6	Power interface, +12V, input.....	16
5.7.7	Relay contacts.....	16
5.7.8	Cabinet power input, AC.....	16
5.7.9	Cabinet power input, 12VDC .....	16
5.7.10	Cabinet power input, 24VDC .....	17
5.7.11	Cabinet power input, 48VDC .....	17
6	ADDITIONAL AUXILIARY MODULES .....	18
6.1	70029 High current Bias Tee, 50 ohms .....	18
6.2	70030 High current Bias T DC, 75 ohms .....	19
6.3	70042 Low current Bias T DC Injector, 50 ohms .....	19
6.4	70021 Low current Bias T DC Injector, 50 ohms .....	20
6.5	56097 RF splitter/combiner, 2 way, 10-2500MHz, 50 ohms .....	20
6.6	56098 RF splitter/combiner, 2 way, 10-2500MHz, 75 ohms .....	21
6.7	56100 RF splitter/combiner 3 way, 700-2400MHz, 50 ohms .....	21
6.8	56140 RF splitter/combiner 4 way, 400-2400MHz, 50 ohms .....	22
6.9	56088 Diplexer and Bias Tee, 4 port, 10MHz + L-Band + DC, 50 ohms .....	22
6.10	56089 Diplexer and Bias Tee, 3 port, 10MHz + L-Band + DC, 50 ohms .....	23
6.11	53236 CWDM 4 channel module, wave length 1550nm, 1570nm, 1590nm, 1610nm .....	23
6.12	53237 CWDM 8 channel high isolation module, wave length 1470 - 1610nm.....	24
6.13	53238 CWDM 8 channel standard isolation module, wave length 1470 - 1610nm.....	24
6.14	54150 Ancillary Ethernet module .....	25
6.15	56213 RF splitter/combiner 6 way, 10-200MHz, 50 ohms .....	25
6.16	56214 RF splitter/combiner 3 way, 5-500MHz, 50 ohms .....	26
6.17	92223 Tray fusion splice holder .....	26
7	SATCOM6 SPECIFICATION.....	27
8	SATCOM6 PART NUMBER MATRIX.....	28

## 1 Initial Inspection

Unpack and inspect the equipment as soon as possible. If there is any sign of damage or any parts missing, do not install the equipment before seeking advice from PPM or your local agent.

The equipment received should match the delivery note that is shipped with the equipment. Contact **ViaLite Communications** or your local agent in case of any discrepancies.

## 2 Introduction to the ViaLiteHD Range

The **ViaLiteHD** range has been developed to provide a modular solution to the transmission of a wide range of analogue and digital data where traditional 'copper wire' systems cannot be used, for example, in electrically noisy environments or over long distances.

The range is ideal for permanent and semi-permanent installation in Satellite communications, GPS, antenna remoting and other related applications.

The variety of links available includes low frequency timing (2kHz) to wideband RF (4.2GHz), RF splitters, Oscillators, Amplifiers and Protection switches; they also include a full suite of supporting functions including RS232/422/485, Ethernet (to 1000 BT) and control systems to monitor and control the system with both Web and SNMP interfaces.

All **ViaLiteHD** equipment operates over high quality glass fibre optic cable, which can be supplied in low-cost 3mm jacket, riser and outdoor specifications. The links can also be used with existing cable systems at customer premises.

A **ViaLiteHD** system can be added to at any time, enabling the system to evolve with the needs of the user.

**ViaLiteHD** is a product brand manufactured by Pulse Power and Measurement Ltd (PPM). **ViaLite Communications** is a division of Pulse Power and Measurement Ltd (PPM).

### 3 SATCOM6 System Description

The SATCOM6 is a stainless steel, weatherproof enclosure designed specifically to be mounted near or by the antenna at teleports and ground stations. The enclosure accepts up to six **ViaLiteHD** modules including all RF, digital and ancillary modules. The enclosure can be fitted with dual power supplies, switch and splitter modules to enable full redundancy. The electrical and optical interfaces are highly configurable. There is also space in the cabinet for ancillary components such as a multi-way splitter, duplexer, high power bias-tees, fibre dressing and a fibre splice tray. The motherboard offers optional LNA/LNB power routing as well as 13/18/22V and 22kHz tone.

Key features:

- Wall or pole mount
- Dual power supplies
- Integrated SNMP for remote monitor and control
- LNB powering
- Built in Ethernet switch (option with SNMP card)

The mainboard accepts up to six **ViaLiteHD** modules. Additionally two LNB units can be populated to the rear side of the motherboard. Standard RX/TX **ViaLiteHD** modules units can be placed in any of the six slots, some ancillary **ViaLiteHD** modules offer full functionality only if placed in particular slots.

Slot number	1	2	3	4	5	6	7	8	9	10	11
Connector reference	J12	J13	J14	J15	J16	J17	J18	J19	J25	J7	J8
Module Type											
RF standard	x	x	x	x	x	x					
RF + digital			x			x					
RF - High power	x	x	x	x	x	x					
Amplifier	x	x	x	x	x	x					
Splitter		x			x						
Switch		x			x						
Serial Digital			x			x					
Ethernet	x	x	x	x	x	x					
PSU - LNB (13/18V)							x	x			
SNMP									x		
Summary Alarm									x		
PSU main (12V)										x	
PSU reserve (12V)											x
PSU LNA (3.3-48V)											x

Table 1 Motherboard slots population matrix

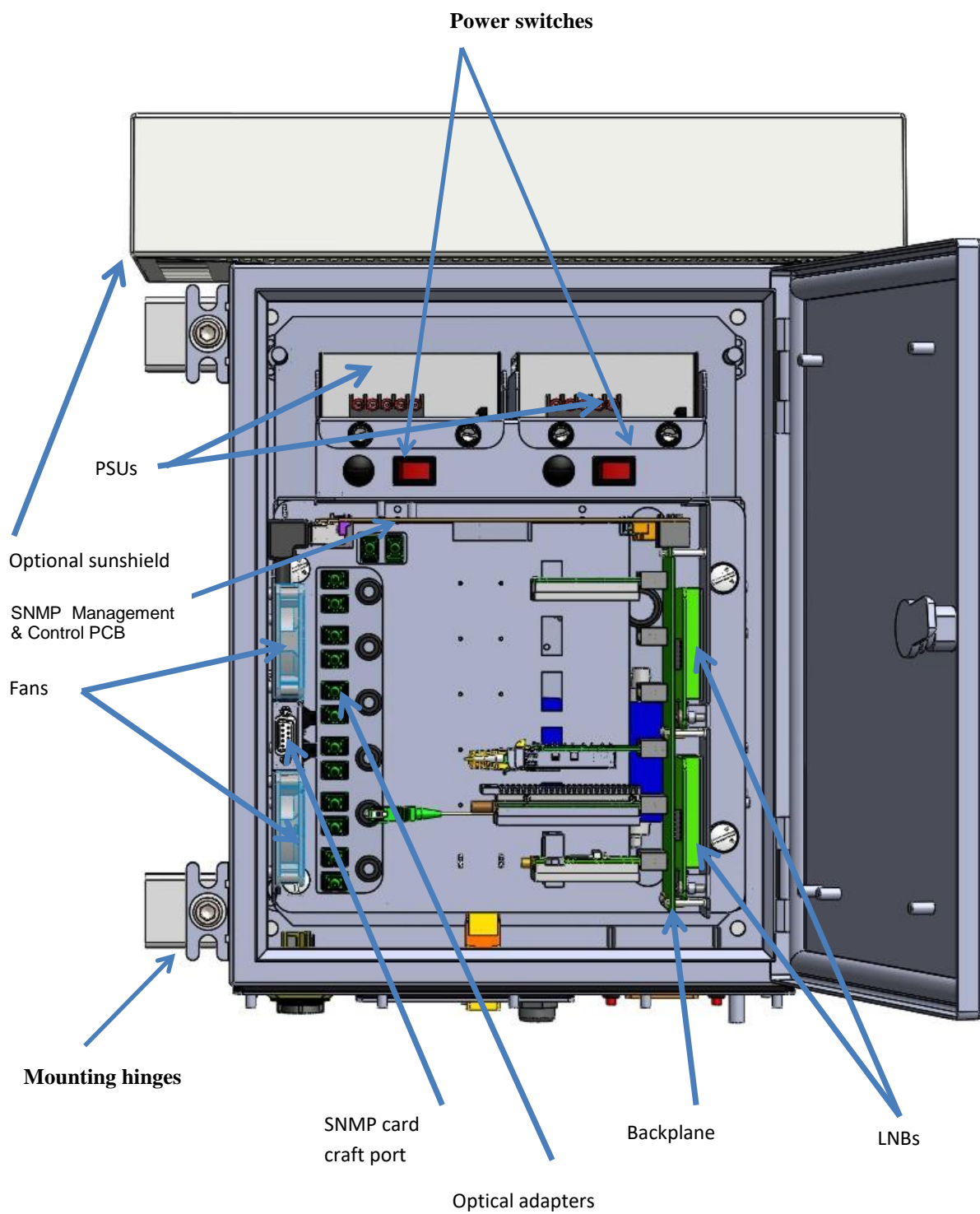

Figure 1 SATCOM6 enclosure, illustrated are several EDGE modules mounted to the Backplane PCB

3.1 **Backplane connections**

Your cabinet should be delivered fully configured as per your order, and ready to operate. The details of the default backplane configuration will be contained in your order specific handbook that your SATCOM6 is delivered with.



Note that J18 and J19 are located on the other side of the board

Figure 2 Location of switch and jumpers on the backplane





Switch/ jumper	Function description	Configuration example	Configuration example description
J11	'POWER' (jumper down) connects the output of the LNB to the BUC FEED pin of the fibre optic receiver; 'DATA' (jumper up) allows using serial interface.		<ul style="list-style-type: none"> <li>Serial digital card used in SLOT3</li> <li>LNB2 supplied to pin 1 (BUC feed) of SLOT6</li> </ul>
J21	'POWER' (jumper down) connects the output of the LNB to the LNB FEED pin of the fibre optic transmitter; 'DATA' (jumper up) allows using serial interface.		<ul style="list-style-type: none"> <li>Serial digital card used in SLOT6</li> <li>LNB1 supplied to pin 1 (LNB feed) of SLOT2</li> </ul>
J30	Used to specially configure the serial digital module in SLOT 3 (refer to HRS-HB-6 SUPPORT MODULE HANDBOOK Section 3.4).		If used this would normally be connected to special interface cable.
J31	Used to specially configure the serial digital module in SLOT 6 (refer to HRS-HB-6 SUPPORT MODULE HANDBOOK Section 3.4).		If used this would normally be connected to special interface cable.
J2	Connects the output of LNB1 (SLOT7) to the external voltage feed (J5 & J26). J2 is highlighted in red.	 J2 is the 4 pin connector next to J8	<ul style="list-style-type: none"> <li>LNB1 connected to J5 &amp; J26</li> </ul> <p>These jumpers are electrically in parallel, both should be fitted.</p>
J3	Connects the output of LNB2 (SLOT8) to the external voltage feed (J5 & J26). J3 is highlighted in red.		<ul style="list-style-type: none"> <li>LNB2 connected to J5 &amp; J26</li> </ul> <p>These jumpers are electrically in parallel, both should be fitted.</p>
SW1	'EMPTY' position masks the alarms from unused modules. 'USED' should be set if the slot is occupied.		<ul style="list-style-type: none"> <li>Slots 1, 2 and 4 set as empty</li> <li>Slots 3, 5, 6, 7 and 8 set as used</li> </ul> <p>Alarm lines from slots 1, 2 and 4 will be ignored.</p>
SW2	Connects the alarm lines from adjacent slots to the RF switch. 'ON' if RF switch is populated in the slot, 'OFF' otherwise.		<p>DIP switch 1 + 2</p> <ul style="list-style-type: none"> <li>SLOT2 used for the switch module, ON</li> <li>SLOT2 used for general purpose, OFF</li> </ul> <p>DIP switch 3 + 4</p> <ul style="list-style-type: none"> <li>SLOT5 used for the switch module, ON</li> <li>SLOT5 used for general purpose, OFF</li> </ul>

Table 2 List of jumpers and switches on the backplane

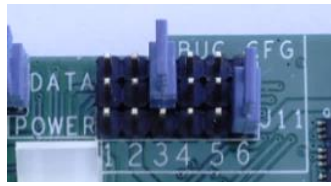
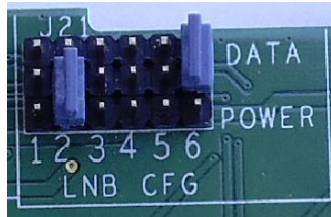

3.2 **Glandplate connections**

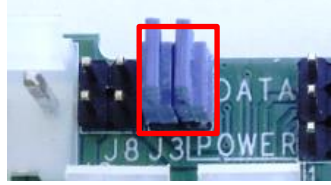
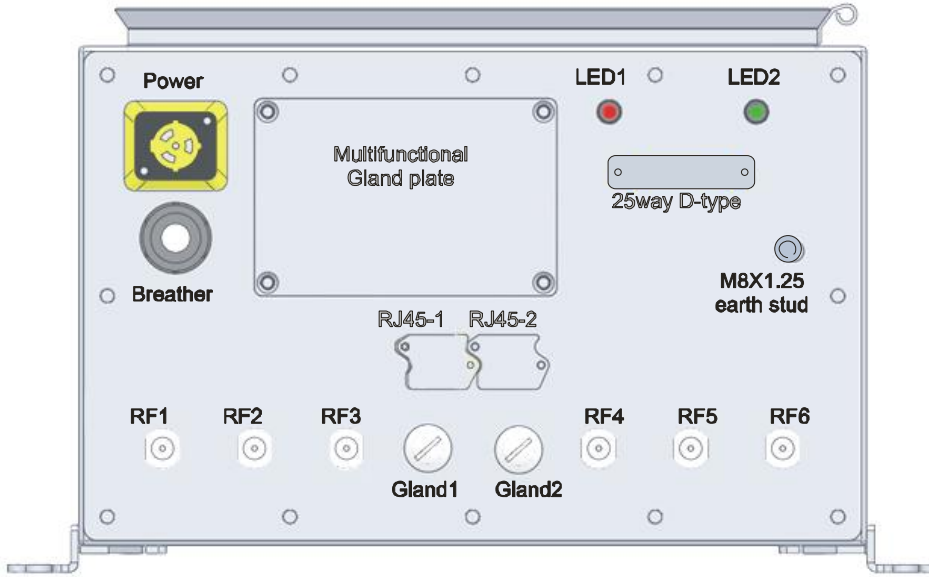

Figure 3 SATCOM6 enclosure - bottom view

Any unused connections will be environmentally sealed.

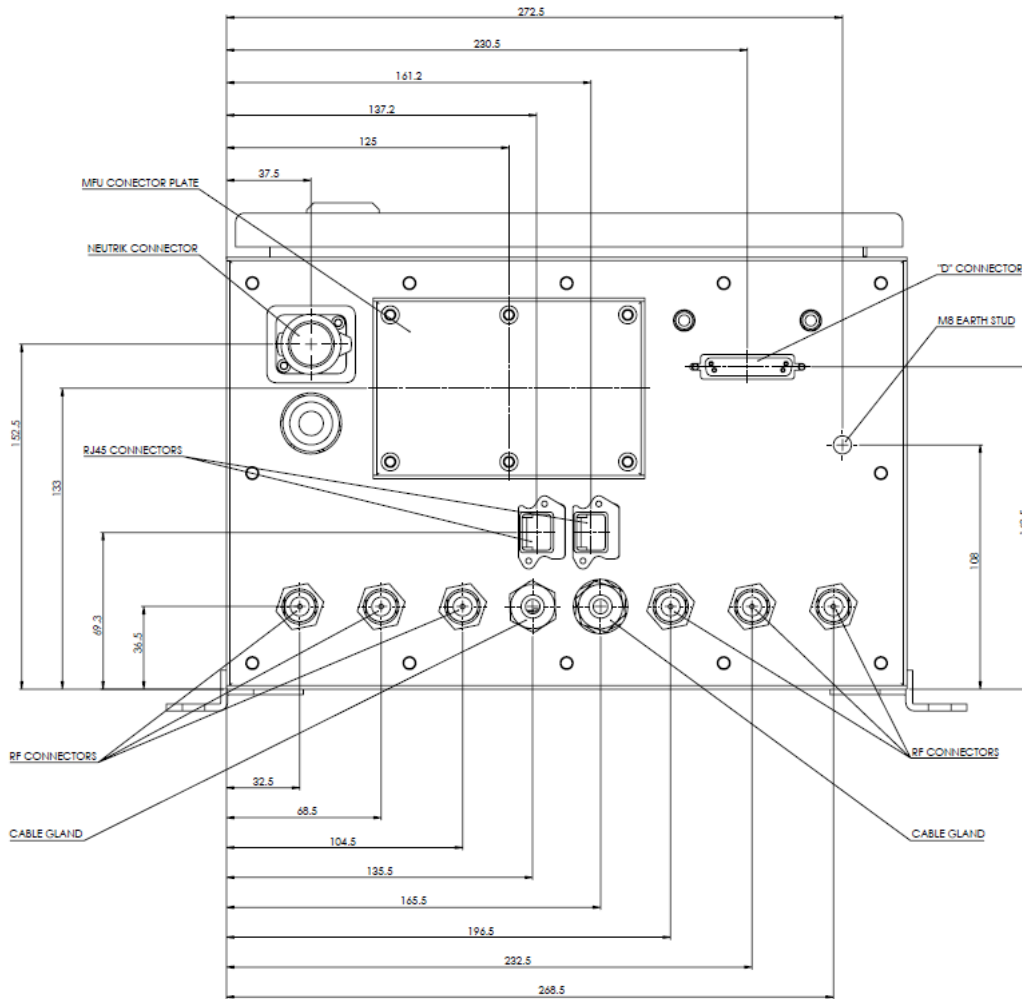

Figure 4 SATCOM6 glandplate with dimensions

### 3.3 External interface connectors and fuses

RF connector: N-Type female, impedance to match your RF modules  
 Power connector:\* Circular plug [Neutrik Powercon True1]  
 Gland: M16 Gland accommodate wire diameters 2 to 7mm [Lapp Kabel 53112110]  
 \* If no power cable is supplied a mating half will be supplied unwired, with assembly instructions

A range of preterminated power cables are available contact **ViaLite Communications** for more details.

- 55036 Connector, Neutrik Powercon, Mains, 16A, Female, Cable mounting, spare
- 73922 Mains Lead, Neutrik extension cable, 1.5m, Neutrik Powercon, male to female
- 93426 Mains Lead, UK 3 pin plug to Neutrik Powercon, 2m long,
- 93427 Mains Lead, UK 3 pin plug to Neutrik Powercon, 3m long,
- 93428 Mains Lead, Neutrik Powercon to 16A Commando plug, 3m long



Figure 5 Neutrik Powercon True1, power connector

### 3.4 Power system

The SATCOM6 can be fitted with up to two power supplies, this consists of either one or two main power supplies and up to one LNA power supply; dependent on the required configuration, see section 3, Table 1. If two main power supplies are fitted they will run as main and redundant. The main and redundant power supplies are OR'd by high efficiency MOSFET switches, only one actively supplies current, changeover between power supplies is automatic. The configuration of your system will be detailed in the order specific handbook that your SATCOM6 is delivered with.

#### 3.4.1 Power supplies

Power supplies can be fitted as either main power supplies or LNA power supplies. The main power supplies available are:

- HPS-6 Mains Power Supply, 90-264VAC i/p, 50W, +12V output
- HPS-7 DC Power Supply, 9.2-18VDC i/p, 25W, +12V output
- HPS-8 DC Power Supply, 19-36VDC i/p, 25W, +12V output
- HPS-9 DC Power Supply, 36-72VDC i/p, 25W, +12V output

The LNA power supply can be used to provide power directly to a connected LNA or BUC, either via the fitted EDGE transmitter modules or via bias tee modules fitted within the enclosure. LNA power supply modules available are:

- HPS-6 Mains Power Supply, 90-264VAC i/p, 50W, +12V output
- HPS-6-15 Mains Power Supply, 90-264VAC i/p, 50W, +15V output
- HPS-6-24 Mains Power Supply, 90-264VAC i/p, 50W, +24V output
- HPS-6-48 Mains Power Supply, 90-264VAC i/p, 50W, +48V output
- HPS-7 DC Power Supply, 9.2-18VDC i/p, 25W, +12V output
- HPS-7-24 DC Power Supply, 9.2-18VDC i/p, 25W, +24V output
- HPS-8 DC Power Supply, 19-36VDC i/p, 25W, +12V output
- HPS-8-24 DC Power Supply, 19-36VDC i/p, 25W, +24V output
- HPS-9 DC Power Supply, 36-72VDC i/p, 25W, +12V output
- HPS-9-24 DC Power Supply, 36-72VDC i/p, 25W, +24V output

Note: Power supply output voltage can be trimmed to match specific applications, other options are also available. Contact **ViaLite Communications** for more details.

#### 3.4.2 Power Requirements

Ensure that the power supplies fitted in your system are sufficient to power the complete system. The power supplies are designed to operate in dual redundancy, without current sharing. Hence power capability of one supply must be sufficient to power the complete chassis.

The details below maybe used to approximate the power output requirements from the main power supplies.

EDGE Transmitter	2.0 W typical per slot, excluding LNA/LNB power
EDGE DWDM Transmitter	3.2 W / 4.0W / 6.0 typical per slot at 25/50/60°C
EDGE Receiver	1.5 W typical
EDGE Amplifier	2.4W typical
EDGE Serial Digital	0.7W typical

EDGE Switch	0.4W typical
EDGE Splitter	0.4W typical
EDGE Ethernet	1.9W typical
SNMP controller	4.0 W typical
EDGE LNB PSU	7.1W typical (@ output 18V, 350mA)
EDGE LNB PSU efficiency	88% typical, for HRP-1-00-0N-00
AC to DC efficiency	84.5% typical, for HPS-6, more details see section 3.4.3
DC to DC efficiency	75% typical, for HPS-7/8/9, more details see section 3.4.3

The input power requirements can be calculated by using the power supply efficiency below.

### 3.4.3 Power supply specification

	HPS-6	HPS-7/8/9
Description	Wide input range AC power supply	Wide input range DC power supply
Dimensions, external (W x H x D)	153 x 101 x 53 mm	
Weight	0.5kg	
Input Supply Power	110VAC or 230VAC nominal at 50/60Hz 88 - 264VAC absolute range at 47/63Hz	HPS-7 9.2-18VDC HPS-8 19-36VDC HPS-9 36-72VDC
Efficiency, typical	HPS-6 84.5% HPS-6-15 86% HPS-6-24 88% HPS-6-48 89%	HPS-7 72% HPS-7-24 75% HPS-8 75% HPS-8-24 78% HPS-9 78% HPS-9-24 81%
Switch on current	<33A @ 230Vac	<10A
Output voltage	HPS-6 12V +/- 0.5V HPS-6-15 15V +/- 0.5V HPS-6-24 24V +/- 1.0V HPS-6-48 24V +/- 1.0V	HPS-7 12V +/- 0.5V HPS-7-24 24V +/- 1.0V HPS-8 12V +/- 0.5V HPS-8-24 24V +/- 1.0V HPS-9 12V +/- 0.5V HPS-9-24 24V +/- 1.0V
Output ripple	120mV for output voltages 12V and 15V, 200mV for output voltages of 24V and 48V	
Maximum input current	1.3A at 115VAC 0.8A at 230VAC	HPS-7 3.2A at 12VDC HPS-8 1.6A at 24VDC HPS-9 0.8A at 48VDC
Maximum output power at +50°C	50 W	25 W
Minimum load power	No minimum load current	
Derating >+50°C	2.0% / °C, absolute maximum 70°C	2% / °C, absolute maximum 60°C
Hot-swapping	Yes, using cabinet hardware	
Dual Redundant	Yes, with appropriate cabinet configuration	
Output current overload	Switches output OFF and automatically restarts at 125% nominal current	
Output over voltage	Switches output OFF and automatically restarts at 125% nominal voltage	
Status Indicators	GREEN power LED	
MTBF @25°C	228 000 hours	365 000 hours

### 3.4.4 Thermal load

The SATCOM6 is design to work with a “full configuration thermal load” across the full specified operating temperature range.

A full thermal load consist of

- 6 EDGE Transmitters
- 2 EDGE LNB power supplies (250mA @13V each)
- 1 SNMP and web controller
- 2 Main power supplies (HPS-6)

The “full configuration thermal load” is 21 watts typically, this includes and allows for module power dissipation (EDGE TX + SNMP and web controller), LNB efficiency and main power supply efficiency. Thermal loads in excess of this will affect the maximum operating temperature. Thermal loads in excess of the “full configuration thermal load” will typically linearly reduce the maximum operating temperature.

**ViaLite Communications** will advise the maximum configuration for cabinets fitted with EDGE DWDM transmitters as these have significantly different thermal characteristics and different thermal interaction with other modules due to their active cooling.

**ViaLite Communications** will evaluate if your requested build configuration exceeds the “full configuration thermal load” and advise you of any impact. Any issues will be noted in the order specific handbook that your SATCOM6 is delivered with, contact **ViaLite Communications** for more details.

## 4 Enclosure installation

The SATCOM6 enclosure has been designed to work in harsh environments. The maximum ambient temperature for the enclosure is +55°C. When installing the enclosure pay attention to the following:

1. Leave open space around the enclosure to allow air circulation (minimum gap of 15cm is recommended).
2. Avoid installation in places with direct exposure to the sun. Consider using the optional sunshield if the unit will be in direct sunlight. Please contact **ViaLite Communications** for assistance to identify the correct part if you want to use a sunshield.
3. In the event that both internal cooling fans fail, the maximum ambient temperature that the SATCOM6 can operate in will be reduced by 10°C, to +45°C.

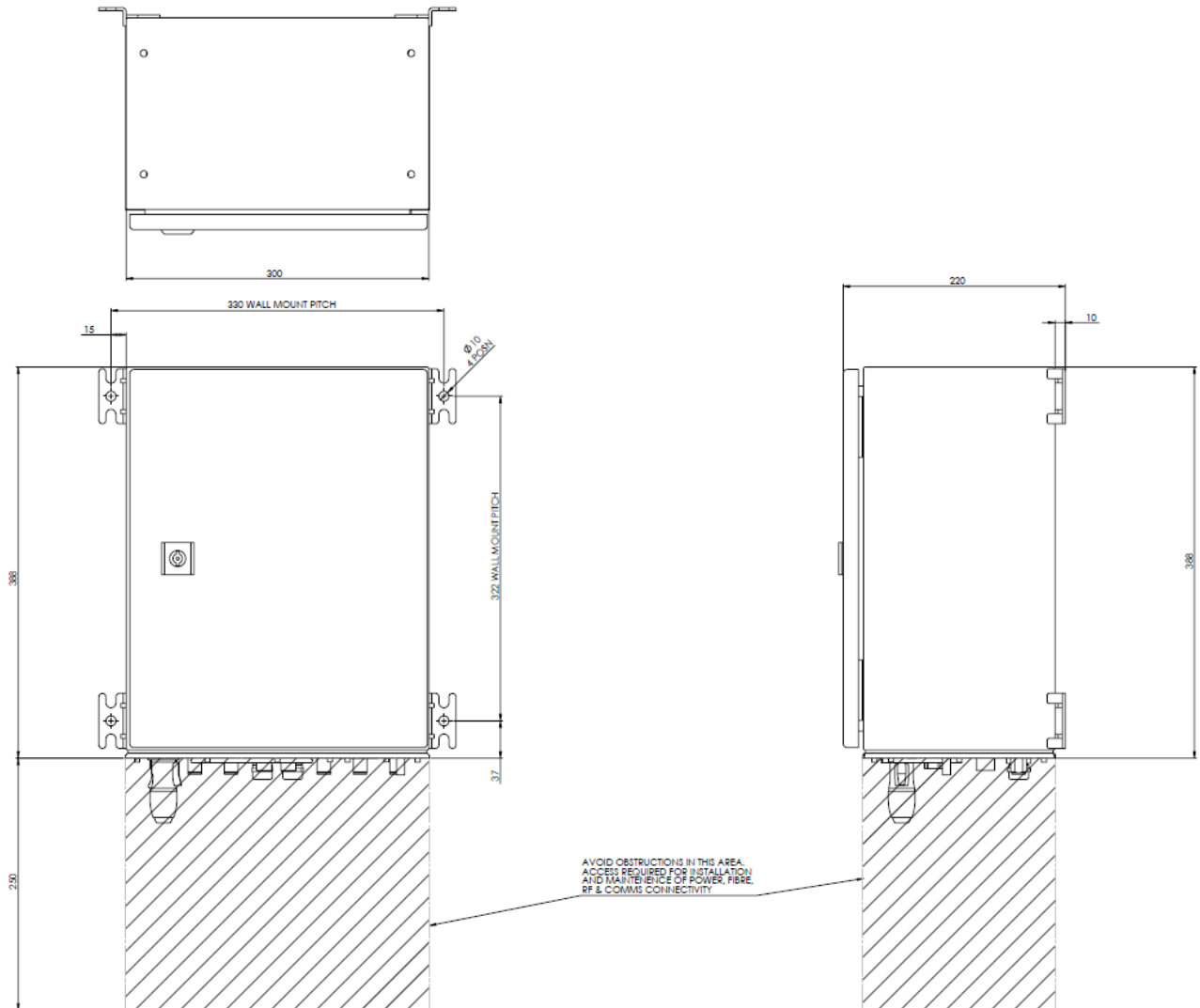

Figure 6 SATCOM6 wall mounting, including dimensions of fixing centres

### 4.1 Cold weather option

The SATCOM6 can operate down to -10°C without a heater. If lower temperature operation is required contact **ViaLite Communications**, there are several heater options available for the SATCOM6.

Heater mats 76194 and 76197 are fitted with a built in thermal switch which enable thermal output at a temperatures below 10 degrees centigrade. Heater mats 76194 and 76197 are powered by the internal +12V supply.

### 4.2 Cabinet climate option

- 70052 SATCOM6 Solar Shield
- 76194 SATCOM6 enclosure, Heater mat, +12V, 15 Watt, for cold climate
- 76197 SATCOM6 enclosure, Heater mat, +12V, 6 Watt, for cold climate

## 5 System configuration

### 5.1 Slots configuration

Your SATCOM6 should be delivered preconfigured to your order instructions. To check the configuration, please follow the procedure below.

1. Check if the module is suitable to be used in the slot according to the pin outs it has (see table 1 in section 3).
2. Using jumpers J11 and J21 configure pins 1 and 9 of the slot. Setting the jumper to 'POWER' connects the relevant pin to the output of the LNB card. Setting to 'DATA' activates serial data interface (for serial digital modules in slots 3 or 6). If using LNB power generated from SATCOM6 LNB power cards then slots 1, 2 and 3 are powered by LNB 1 (slot 7), and slots 4, 5 and 6 are powered by LNB 2 (slot 8).
3. If an RF switch card is fitted to a slot check SW2 is in 'YES' position, otherwise place it in the 'NO' position.
4. Serial digital cards can only be used in slots 3 and 6. They can be configured via SNMP or manually. To set parameters manually use jumpers J30/J31. Refer to the *ViaLiteHD* RF Support Module handbook for more information about configurable parameters.
5. Check the position of jumpers J2/J3. If jumpers are closed the external LNB is connected.
6. For all populated slots set SW1 switch to 'USED' position. If a slot is left empty set the SW1 switch to the 'EMPTY' position.

Refer to section 3.1 for detailed description of all jumpers and switches on the motherboard.

The pin-out of the slots can be found in the tables below.

Pin number	Pin description
1	BUC FEED (configurable via J11)
2	NC
3	NC
4	GND
5	VCC
6	NC
7	NC
8	NC
9	LNB FEED (configurable via J21)
10	NC
11	NC
12	ALARM
13	NC
14	SCL
15	SDA

Table 3 Slots 1 and 4 pin-outs

Pin number	Pin description
1	BUC FEED (configurable via J11)
2	NC
3	NC
4	GND
5	VCC
6	NC
7	NC
8	NC
9	LNB FEED (configurable via J21)
10	ALARM LEFT (switchable via SW2)
11	NC
12	ALARM
13	ALARM RIGHT (switchable via SW2)
14	SCL
15	SDA

Table 4 Slots 2 and 5 pin-outs

Pin number	Pin description
1	BUC FEED or TX422 IN+ (configurable via J11)
2	TX422 IN-
3	TX232 IN
4	GND
5	VCC
6	RX422 OUT+
7	RX422 OUT-
8	RX232 OUT
9	LNB FEED or RTS (configurable via J21)
10	Serial CFG1
11	Serial CFG2
12	ALARM
13	Serial CFG3
14	SCL
15	SDA

Table 5 Slots 3 and 6 pin-outs

Pin number	Pin description
1	NC
2	NC
3	NC
4	NC
5	NC
6	NC
7	NC
8	NC
9	LNB FEED output
10	NC
11	NC
12	ALARM
13	NC
14	SCL
15	SDA

Table 6 Slots 7 and 8 pin-outs

## 5.2 Summary alarm configuration

The SATCOM6 enclosure is equipped with the summary alarm indication by mean of two external LEDs. Green indicates normal operation, and red indicates an alarm condition in one or more of the slots. No light indicates a power failure. Alarm circuitry is open drain type, requiring each unit to actively pull down to indicate normal mode of operation. In such circuit topology an empty slot would raise an alarm. To prevent such a situation DIP switch SW1 should be set according to the configuration, switch to 'USED' position if the slot is occupied 'EMPTY' if the slot is unoccupied. The switch allows masking of alarms from any of the 6 main slots or the 2 additional LNB slots.

## 5.3 SNMP card configuration

SATCOM6 can be monitored and controlled via a web browser or SNMP management system. Before first use the system has to be configured. Refer to HRC-1 handbook to find more details about the set-up process.

## 5.4 Fan operation

To allow reliable operation under harsh environmental conditions the SATCOM6 is equipped with two fans enabling internal air circulation. The speed of the fans is dependent on internal temperature. D6 LED indicates the status of the fans.

D6 LED state	Fan status
Off	Internal temperature below the limit, fans off
Blinking GREEN	Fans working between 40% and 100%
Solid GREEN	Fans working at 100%
RED	Fans' failure

Table 7 Fan diode status

## 5.5 External D25 connector

The external D25 connector provides access to serial interface if serial digital cards are installed in slot 3 or 6. Refer to the serial digital cards handbook for more information. Dry relay contacts to indicate alarms are also available.

Pin	Pin description	Description	Pin	Pin description	Description
1	GND		14	RX 422 OUT- 6	RS422 interface – SLOT6
2	RX 422 OUT+ 3	RS422 interface – SLOT3	15	TX 232 IN 6	RS232 interface – SLOT6
3	TX 422 IN+ 3	RS422 interface – SLOT3	16	RX232 OUT 6	RS232 interface – SLOT6
4	RX 422 OUT- 3	RS422 interface – SLOT3	17	GND	
5	TX 422 IN- 3	RS422 interface – SLOT3	18	RTS 6	RTS – SLOT6
6	RX232 OUT 3	RS232 interface – SLOT3	19	RELAY 1	Dry relay contact (NO – normally open)
7	TX 232 IN 3	RS232 interface – SLOT3	20	GND	
8	RTS 3	RTS – SLOT3	21	RELAY 2	Dry relay (COM – common)
9	GND		22	VCC	
10	GND		23	RELAY 3	Dry relay contact (NC – normally closed)
11	TX 422 IN+ 6	RS422 interface – SLOT6	24	EXT V+	External power +
12	RX 422 OUT+ 6	RS422 interface – SLOT6	25	EXT V-	External power -
13	TX 422 IN- 6	RS422 interface – SLOT6			

Table 8 Normal Pin-out of the D25 connector, may differ for some special applications, see cabinet specific handbook

NOTE: Relay contacts are available only if SNMP or SUMMARY ALARM card are fitted.

NOTE: Check jumpers J11 and J21 before connecting D25.

## 5.6 Using LNBS

### 5.6.1 Internal LNBS (up to two LNB power cards may be fitted to the SATCOM6)

1. Make sure that J2 and J3 jumpers are not populated.
2. Place the LNB unit in slot 7 or slot 8. Configure the LNB, for details refer to the LNB manual. The LNB card in slot 7 supplies voltage to slots 1-3, and the LNB card in slot 8 supplies voltage to slot 4-6.
3. Using jumpers J11 and J21 connect the LNB to the modules. Use J11 if an optical receiver is used or J21 for a transmitter. J11 in 'POWER' position connects the power from the LNB to the BUC FEED pin of the receiver. J21 connects the power from LNB to the LNB FEED pin of the transmitter.

### 5.6.2 External LNB, power routed via mother board

If an external power supply is used instead of LNB units follow this procedure:

1. Connect power to the J5 connector
2. By closing J2 jumper the power is routed to the output of the LNB1 internal module (slot 7). Closing J3 jumper routes the power to the output of the LNB2 module (slot 8). Before closing one of the jumpers make sure that relevant slots are not populated.
3. Using jumpers J11 or J21 route the power to the appropriate slots – refer to 'Internal LNBS' section above for more details.

NOTE: Do not exceed voltage or current rating of modules, higher voltage can cause permanent damage. The voltage range of LNA/LNB feeds is 0 to +28V and for BUC feeds it is -36 to +36V. Please check the handbook specific to the module you are using.

### 5.6.3 External LNB/BUC, using bias tee modules

It is possible to provide a LNB/BUC power using separate bias Tee module fixed in the base of the SATCOM6. Wiring and other details of these bias Tees will be shown in the cabinet specific handbook.

## 5.7 Module Interface ratings

Where relevant please consult module handbooks for the individual modules you are using in each slot.

### 5.7.1 Logic interface, TTL 5V

Absolute maximum voltage rating	-0.5 to +5.5V	No damage
Input, Logic Low (max)	<0.8V	
Input, Logic High (min)	>2.0V	
Output, Logic Low (max)	<0.4V no load	
Output, Logic High (min)	>4.8V no load	
Drive capability	1k ohms	
Short circuit protection	No	

**5.7.2 Logic interface, RS232**

Absolute maximum voltage rating	-15 to +15V	No damage
Input, Logic Low (max)	<0.8V	
Input, Logic High (min)	>2.6V	
Output, Logic Low (max)	<-3.2V no load	
Output, Logic High (min)	>+3.2V no load	
Drive capability	3k ohms	
Short circuit protection	Yes	

**5.7.3 Logic interface, RS422/485**

Absolute maximum voltage rating	-12 to +12V	No damage
Input, Logic Low (max)	<0.8V	Common mode referenced to GND
Input, Logic High (min)	>2.0V	Common mode referenced to GND
Output, Logic Low (max)	<0.8V at 27 ohms	Common mode referenced to GND
Output, Logic High (min)	>2.0V at 27 ohms	Common mode referenced to GND
Output Differential	>1.5V at 27 ohms	
Output Differential	>2.0V at 50 ohms	
Drive capability	27 ohms	
Short circuit protection	Yes	

**5.7.4 Logic interface, I2C**

Absolute maximum voltage rating	-0.3 to +5.3V	No damage
Input, Logic Low (max)	<1.5V	
Input, Logic High (min)	>3.5V	
Output, Logic Low (max)	<0.6V no load	
Output, Logic High (min)	>4.3V no load	
Drive capability	1k ohms	
Short circuit protection	No	

**5.7.5 Logic interface, Open Drain, output**

Operational pull up voltage	0 to 15V	No damage
Maximum load current	50mA	
Short circuit protection	No	

Negative voltage on the output will be clamped by the FET body diode, you must ensure that these do not exceed current rating.

**5.7.6 Power interface, +12V, input**

Nominal input voltage	12V
Typical input voltage range	11 to 13V
Maximum operational voltage range	9 to 16V

**5.7.7 Relay contacts**

Contacts type	Form C break before make, dry contact, volt free
Maximum voltage & current	50V @ 1A, all voltages are relative to ground
Initial contact resistance	75 mΩ

**5.7.8 Cabinet power input, AC**

Nominal input voltage	110V AC and 230VAC
Maximum operational voltage range	88 - 264VAC
See section 3.4.3 for more details	

**5.7.9 Cabinet power input, 12VDC**

Nominal input voltage	12VDC
Maximum operational voltage range	9.2-18VDC
See section 3.4.3 for more details	



**5.7.10 Cabinet power input, 24VDC**

Nominal input voltage 24VDC  
Maximum operational voltage range 19-36VDC  
See section 3.4.3 for more details

**5.7.11 Cabinet power input, 48VDC**

Nominal input voltage 48VDC  
Maximum operational voltage range 36-72VDC  
See section 3.4.3 for more details

## 6 Additional auxiliary modules

The space for auxiliary modules is provided under the metal work holding the motherboard. The wide range of passive units includes diplexers, RF splitters, bias Tees. Fibre components including fibre splice trays, CWDM filters and optical splitters can also be installed in this area.

Contact **ViaLite Communications** or your local representative for more information.

- 70029 High current Bias Tee, 50 ohms
- 70030 High current Bias T DC, 75 ohms
- 70042 Low current Bias T DC Injector, 50 ohms
- 70021 Low current Bias T DC Injector, 75 ohms
- 56097 RF splitter/combiner, 2 way, 10-2500MHz, 50 ohms
- 56098 RF splitter/combiner, 2 way, 10-2500MHz, 75 ohms
- 85035 RF splitter/combiner 3 way, 700-2400MHz, 50 ohms
- 56140 RF splitter/combiner 4 way, 400-2400MHz, 50 ohms
- 56088 Diplexer and Bias Tee, 4 port, 10MHz + L-Band + DC, 50 ohms
- 56089 Diplexer and Bias Tee, 3 port, 10MHz + L-Band + DC, 50 ohms
- 53236 CWDM 4 channel module, wave length 1550nm, 1570nm, 1590nm, 1610nm
- 53237 CWDM 8 channel high isolation module, wave length 1470 - 1610nm
- 53238 CWDM 8 channel standard isolation module, wave length 1470 - 1610nm
- 54150 Ancillary Ethernet module
- 56213 RF splitter/combiner 6 way, 10-200MHz, 50 ohms
- 56214 RF splitter/combiner 3 way, 5-500MHz, 50 ohms
- 92223 Tray fusion splice holder

Contact **ViaLite Communications** or your local representative for more information.

### 6.1 70029 High current Bias Tee, 50 ohms

Uses part number 56086 in upto 3 positions

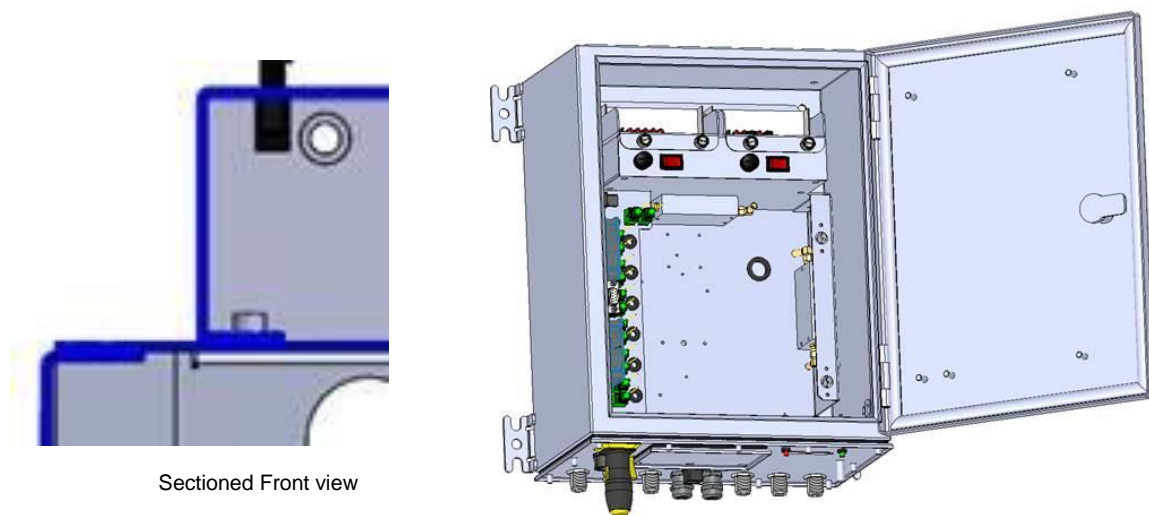
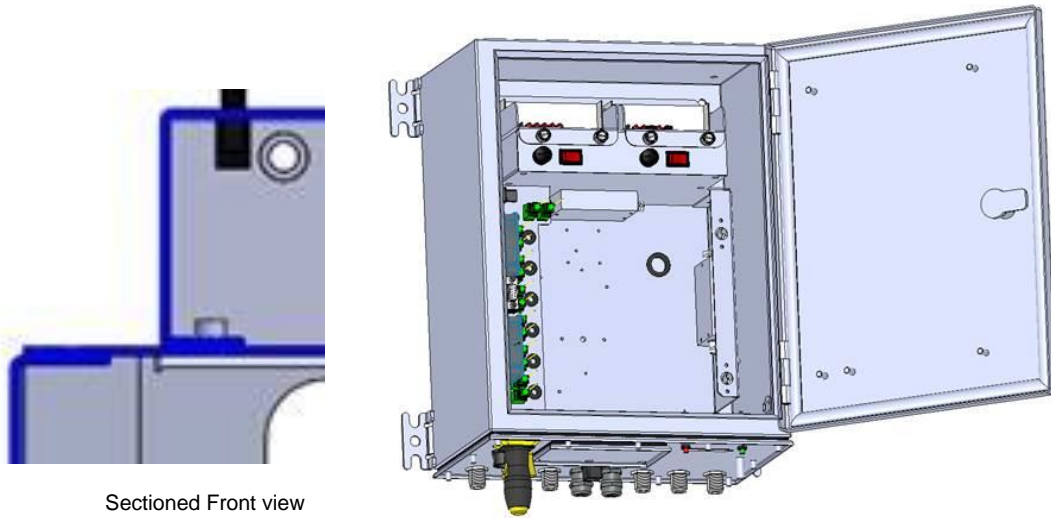

Figure 7 SATCOM6 position of 70029

**6.2 70030 High current Bias T DC, 75 ohms**

Uses part number 56087 in upto 3 positions



Sectioned Front view

Figure 8 SATCOM6 position of 70030

**6.3 70042 Low current Bias T DC Injector, 50 ohms**

Uses part number 56094, upto 3 can be mounted on a single internal bracket

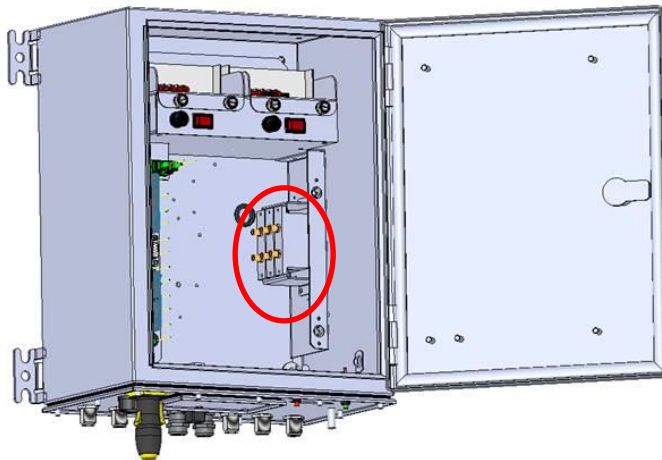

Figure 9 SATCOM6 position of 70042

**6.4 70021 Low current Bias T DC Injector, 50 ohms**

Uses part number 56099 in upto 3 positions

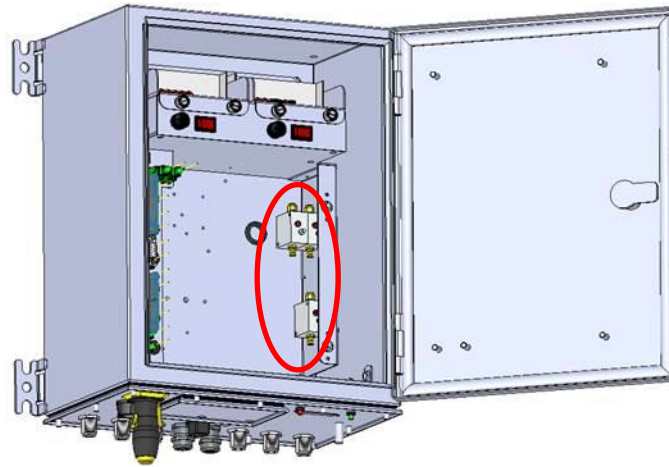

Figure 10 SATCOM6 position of 70021

**6.5 56097 RF splitter/combiner, 2 way, 10-2500MHz, 50 ohms**

Uses part number 56097 in upto 3 positions

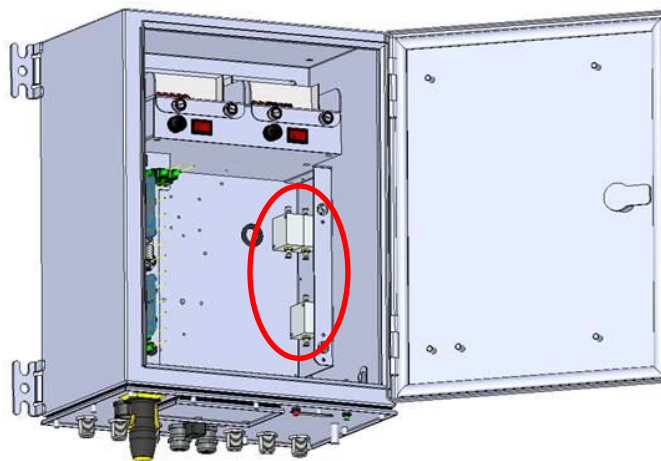

Figure 11 SATCOM6 position of 56097

**6.6 56098 RF splitter/combiner, 2 way, 10-2500Mhz, 75 ohms**

Uses part number 56098 in upto 3 positions

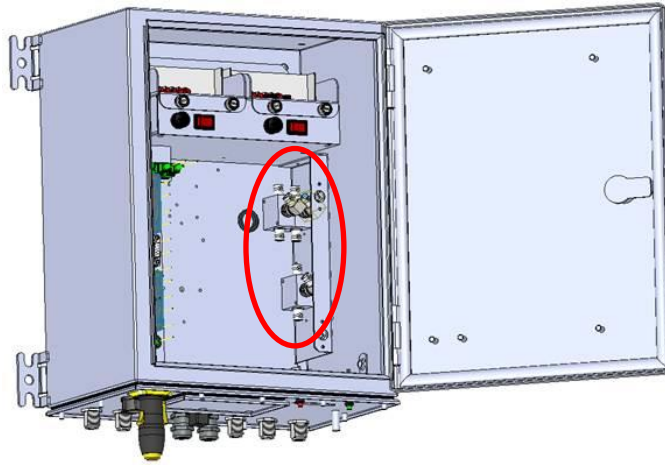
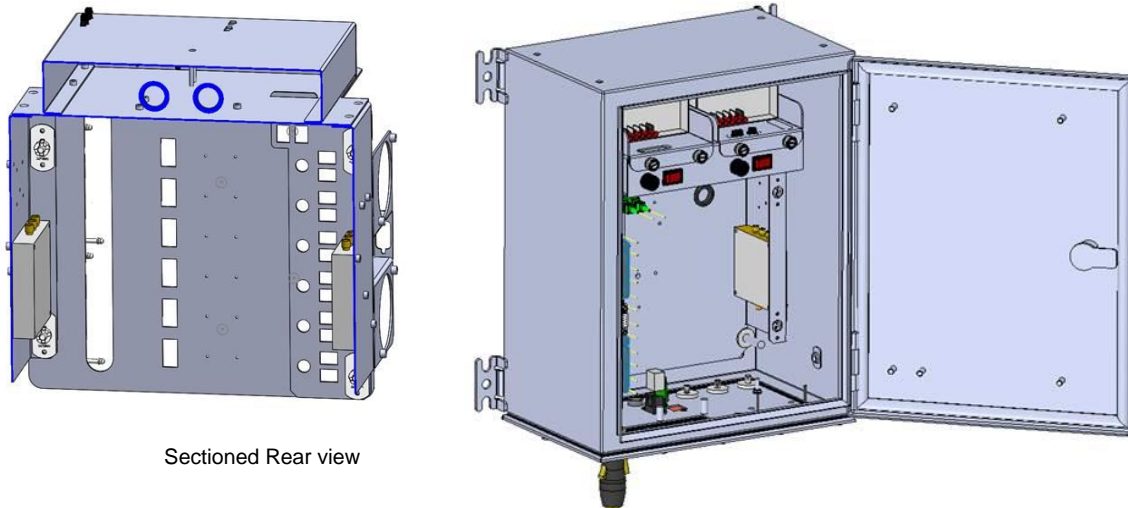

Figure 12 SATCOM6 position of 56098

**6.7 56100 RF splitter/combiner 3 way, 700-2400MHz, 50 ohms**

Uses part number 56100 in upto 2 positions



Sectioned Rear view

Figure 13 SATCOM6 position of 56100

**6.8 56140 RF splitter/combiner 4 way, 400-2400MHz, 50 ohms**

Uses part number 56140 in 1 position

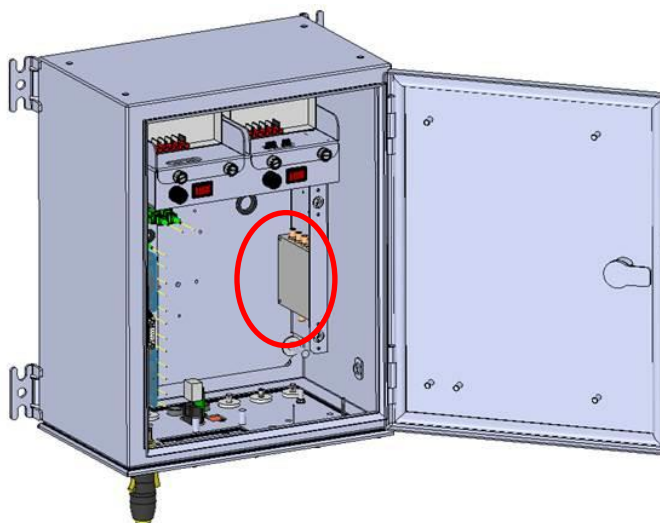

Figure 14 SATCOM6 position of 56140

**6.9 56088 Diplexer and Bias Tee, 4 port, 10MHz + L-Band + DC, 50 ohms**

Uses part number 56088 in upto 3 positions

This module has four separate ports for L-Band, 10MHz, DC and common

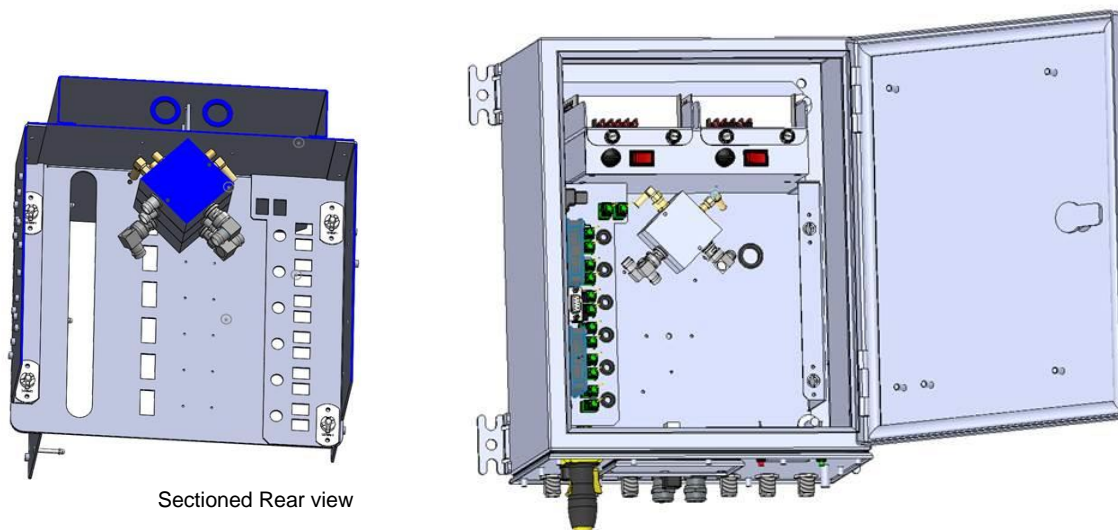

Figure 15 SATCOM6 position of 56088

**6.10 56089 Diplexer and Bias Tee, 3 port, 10MHz + L-Band + DC, 50 ohms**

Uses part number 56089 in upto 3 positions  
 This module has four separate ports for L-Band +DC, 10MHz and common

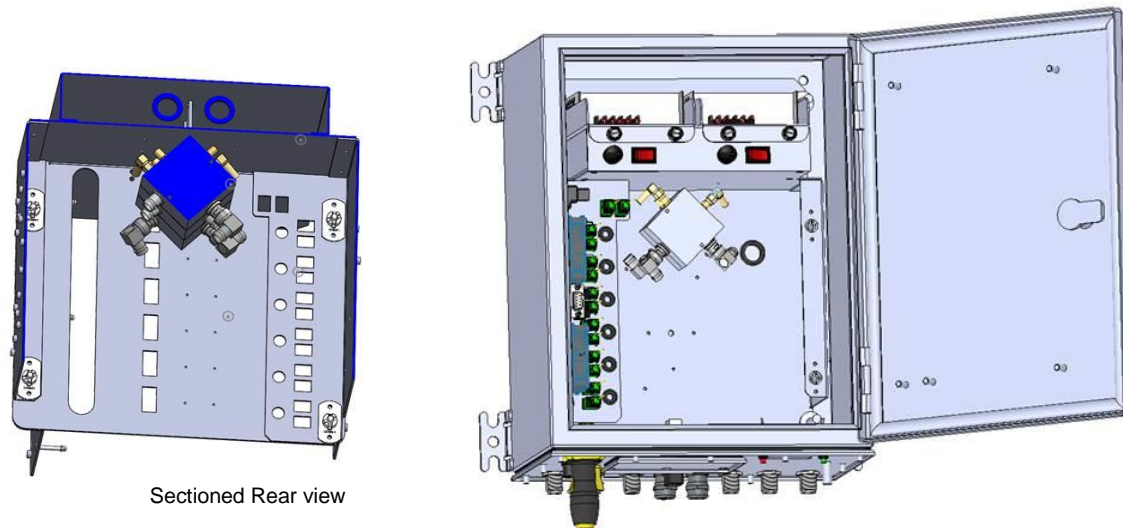

Figure 16 SATCOM6 position of 56089

**6.11 53236 CWDM 4 channel module, wave length 1550nm, 1570nm, 1590nm, 1610nm**

Uses part number 53236 in 1 position

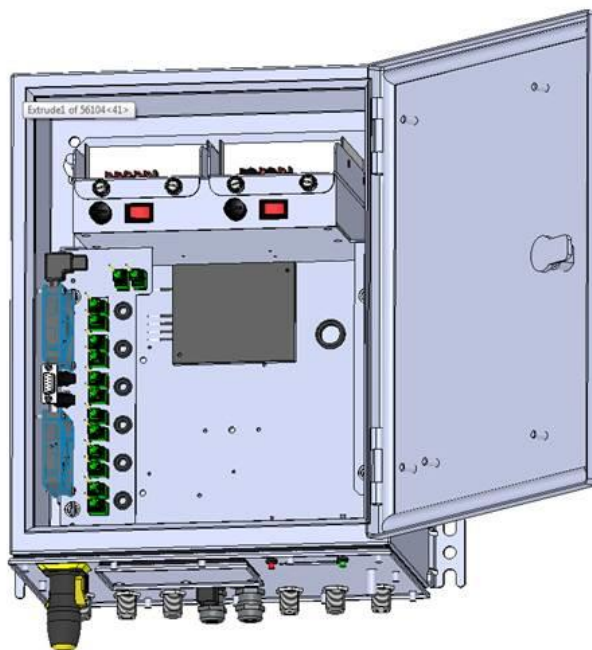

Figure 17 SATCOM6 position of 53236

**6.12 53237 CWDM 8 channel high isolation module, wave length 1470 - 1610nm**

Uses part number 53237 in 1 position

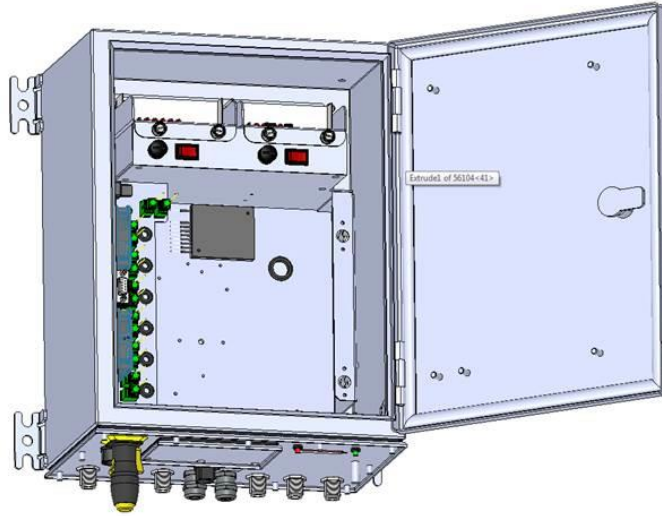

Figure 18 SATCOM6 position of 53237

**6.13 53238 CWDM 8 channel standard isolation module, wave length 1470 - 1610nm**

Uses part number 53238 in 1 position

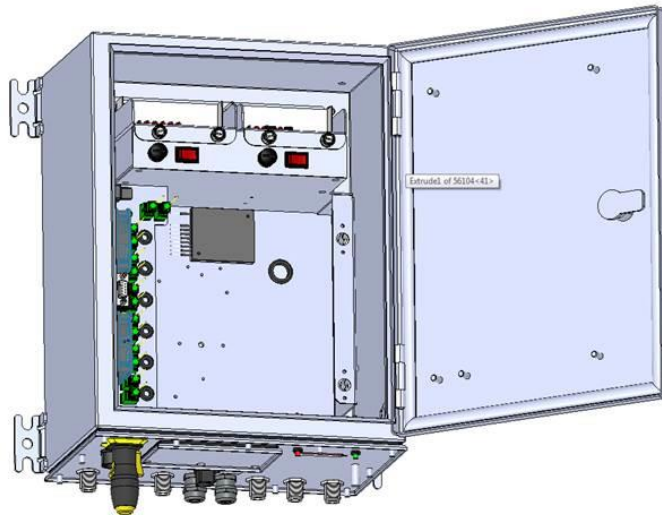

Figure 19 SATCOM6 position of 53238



**6.14 54150 Ancillary Ethernet module**

Uses part number 5150 in 1 position

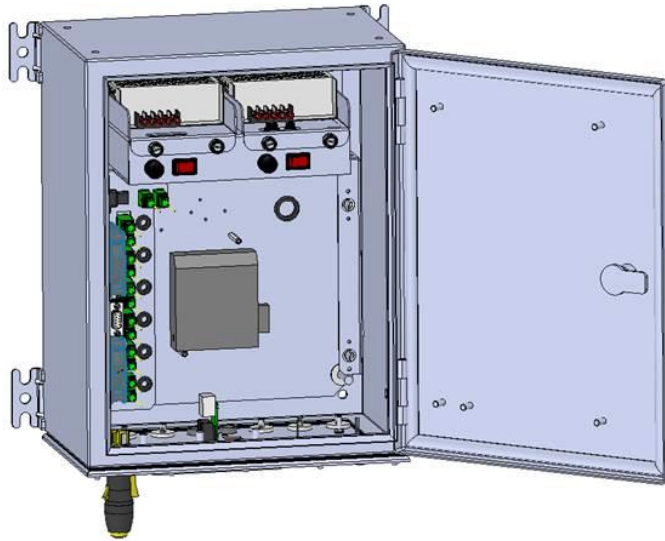

Figure 20 SATCOM6 position of 54150

**6.15 56213 RF splitter/combiner 6 way, 10-200MHz, 50 ohms**

Uses part number 53213 in 1 position

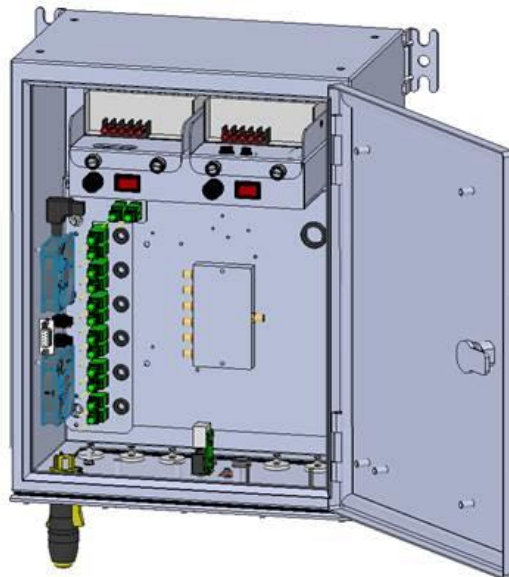

Figure 21 SATCOM6 position of 54213

**6.16 56214 RF splitter/combiner 3 way, 5-500MHz, 50 ohms**

Uses part number 53214 in upto 2 positions

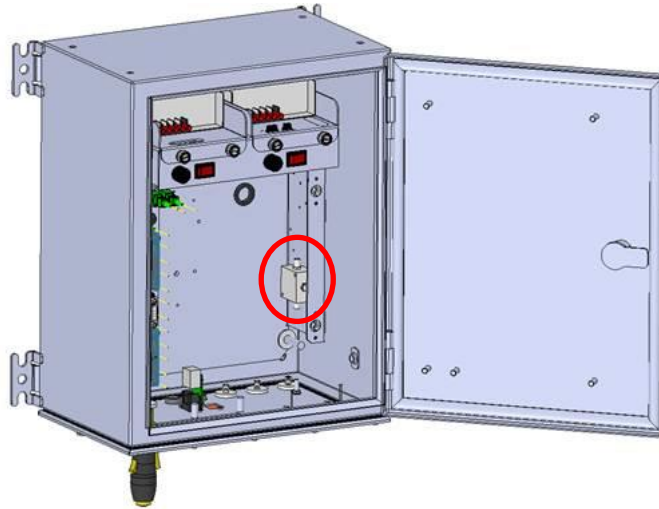

Figure 22 SATCOM6 position of 54214

**6.17 92223 Tray fusion splice holder**

Uses part number 92223 in 1 position

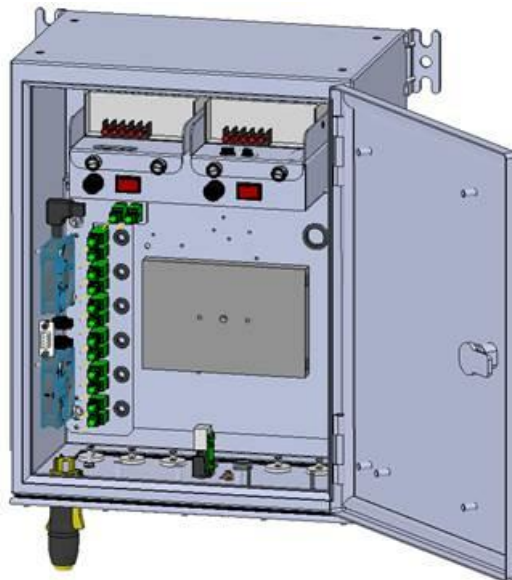
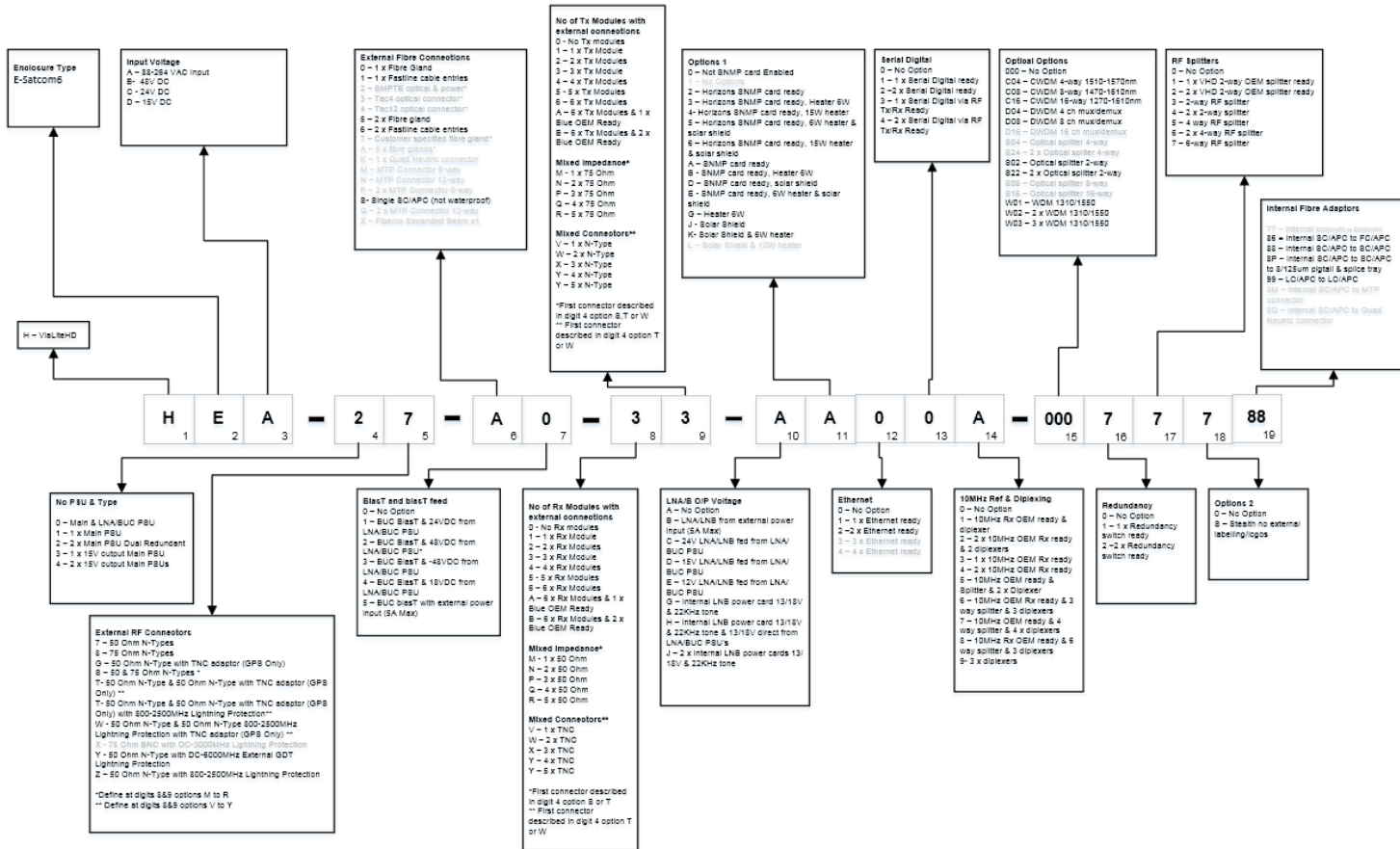

Figure 23 SATCOM6 position of 92223

## 7 SATCOM6 specification

<b>SATCOM6 ViaLiteHD Outdoor Enclosure</b>	
Number of RF links	1 to 6
IP Rating	IP66
External Dimensions (H:W:D)	380mm : 300mm : 210mm
Weight (without modules)	Approx. 15kg
Material	304 stainless steel
<b>Interface</b>	
RF Input / Output Connectors	N-type (50Ω or 75Ω ) type Female
Optical Fibre Connections	Up to 2, Optical cable to fit M16 gland (2-7mm diameter) or Fastline cross site cable
Power Supply Connections	Neutrik Powercon True1
<b>Electrical Specifications</b>	
Supply Voltage Options	AC: 88-264v, DC: 15, 24 or 48v
LNB powering options	On board 12/18/24v + 22kHz (manual and SNMP switchable)
BUC Supply Voltage Options	Optional, BUC bias T internal or external input (+24v, -48v, +48v), external 5A plug
<b>Alarm Indications</b>	
Indicator Type	External LED
Channels Monitored	PSU voltage rail, digital module alarms, analogue monitors
SNMP monitor and control	Optional
<b>Environmental Specifications</b>	
Operating Temperature Range	-10°C to +55°C without heater, -20°C to +55°C with single DC heater -30°C to +55°C with dual DC heaters -40°C to +55°C with AC heater
Storage Temperature Range	-40°C to +70°C
Climate Control	Humidity ventilator, heater (optional), sunshield (optional)

# 8 SATCOM6 part number matrix



Note: Note not all combinations of options are available. Contact **ViaLite Communications** for more details