



Instructions for Use
175038EN B

The Midas Rex™ MR8™ Electric High-Speed Drill System

MR8 Electric, MR8 Electric Plus, and MR8 Electric Touch Motors

Customer service

Contact your Medtronic Neurosurgery sales representative or call:

Medtronic Neurosurgery Service Group

(800) 335-9557 or (817) 788-6440

RS.DFWrepairs@medtronic.com

Outside the U.S.A., contact your Medtronic regional distributor or Medtronic Neurosurgery sales representative.

- EN** To obtain a copy of this manual in your local language contact your local Medtronic representative or go to **manuals.medtronic.com**.
- BG** За да получите екземпляр от това ръководство на Вашия език, можете да се свържете с местния представител на Medtronic или да посетите **manuals.medtronic.com**.
- CS** Máte-li zájem o kopii této příručky ve svém jazyce, kontaktujte místního zástupce společnosti Medtronic nebo navštivte webové stránky **manuals.medtronic.com**.
- DA** Du kan få en kopi af denne vejledning på dit sprog ved at kontakte den lokale Medtronic-repræsentant eller gå til **manuals.medtronic.com**.
- DE** Eine Kopie dieses Handbuchs in der jeweiligen Landessprache kann vom örtlichen Medtronic-Vertreter angefordert oder unter **manuals.medtronic.com** bezogen werden.
- EL** Για να λάβετε αντίγραφο του παρόντος εγχειριδίου στην τοπική σας γλώσσα, επικοινωνήστε με τον τοπικό αντιπρόσωπο της Medtronic ή επισκεφθείτε την ιστοσελίδα **manuals.medtronic.com**.
- ES** Para obtener una copia de este manual en su idioma local, póngase en contacto con su representante local de Medtronic o visite **manuals.medtronic.com**.
- ET** Võtke ühendust oma ettevõtte Medtronic esindajaga või külastage veebisaiti **manuals.medtronic.com**, et hankida juhendist koopia kohalikus keeles.
- FI** Jos haluat tämän käyttöoppaan omalla kielelläsi, ota yhteyttä paikalliseen Medtronicin edustajaan tai siirry osoitteeseen **manuals.medtronic.com**.
- FR** Pour obtenir un exemplaire de ce manuel dans votre langue, veuillez contacter votre représentant Medtronic local ou visiter la page **manuals.medtronic.com**.
- HR** Da biste dobili kopiju ovog priručnika na svom jeziku, obratite se lokalnom zastupniku tvrtke Medtronic ili posjetite web-mjesto **manuals.medtronic.com**.
- HU** Ha szeretne egy saját nyelvű példányt a jelen kézikönyvből, vegye fel a kapcsolatot a Medtronic helyi képviselőjével, vagy látogasson el a **manuals.medtronic.com** weboldalra.
- IT** Per ottenere una copia del presente manuale nella lingua locale, contattare il rappresentante Medtronic di zona o visitare la pagina **manuals.medtronic.com**.
- LT** Norėdami gauti šio vadovo kopiją vietos kalba, susisiekite su vietos „Medtronic“ atstovais arba apsilankykite adresu **manuals.medtronic.com**.
- LV** Lai saņemtu šīs rokasgrāmatas eksemplāru vietējā valodā, sazinieties ar savu vietējo Medtronic pārstāvi vai apmeklējiet vietni **manuals.medtronic.com**.
- MK** За да добиете копија од овој прирачник на вашиот локален јазик, контактирајте со вашиот локален претставник на Medtronic или појдете на **manuals.medtronic.com**.
- NL** Neem contact op met uw vertegenwoordiger van Medtronic of ga naar **manuals.medtronic.com** voor een exemplaar van deze handleiding in uw taal.
- NO** Du kan få et eksemplar av denne håndboken på ditt språk ved å kontakte din lokale Medtronic-representant eller gå til **manuals.medtronic.com**.
- PL** Aby uzyskać egzemplarz niniejszego podręcznika w wybranym języku, należy się skontaktować z lokalnym przedstawicielem firmy Medtronic lub odwiedzić stronę **manuals.medtronic.com**.
- PT-BR** Para obter uma cópia deste manual em seu idioma local, entre em contato com o representante local da Medtronic ou acesse **manuals.medtronic.com**.
- PT-PT** Para obter uma cópia deste manual no seu idioma local, contacte o seu representante local Medtronic ou visite **manuals.medtronic.com**.
- RO** Pentru a obține o copie a acestui manual în limba locală, contactați reprezentantul local Medtronic sau accesați **manuals.medtronic.com**.
- RU** Для получения экземпляра этого руководства на вашем языке обратитесь к местному представителю Medtronic или посетите сайт **manuals.medtronic.com**.
- SK** Ak chcete získať kópiu tejto príručky vo vašom miestnom jazyku, kontaktujte miestneho zástupcu spoločnosti Medtronic alebo navštívte stránku **manuals.medtronic.com**.
- SL** Če želite izvod tega priročnika v svojem jeziku, se obrnite na lokalnega predstavnika za Medtronic ali pa ga poiščite na spletnem mestu **manuals.medtronic.com**.
- SR** Da biste dobili kopiju ovog priručnika za korisnike na svom jeziku, kontaktirajte lokalno predstavništvo kompanije Medtronic ili posetite lokaciju **manuals.medtronic.com**.
- SV** För att erhålla en kopia av denna handbok på ditt språk kontaktar du din lokala representant för Medtronic eller går till **manuals.medtronic.com**.
- TR** Bu kılavuzun kendi dilinizde bir kopyasını almak için, bölgenizdeki Medtronic temsilcinize başvurun veya **manuals.medtronic.com** adresine gidin.
- UK** Щоб отримати копію цього посібника вашою місцевою мовою, зв'яжіться зі своїм місцевим представником Medtronic або відвідайте веб-сайт **manuals.medtronic.com**.

The following are trademarks or registered trademarks of Medtronic, Inc. in the United States and other countries: IntelliFlow™, IPC™, Legend™, Midas Rex™, and MR8™. All other trademarks, service marks, registered trademarks or registered service marks are the property of their respective owners in the United States and other countries.

Contents

Glossary	1
General information	1
Indications for use	1
MR8 system description	1
MR8 electric motors	1
MR8 attachments	1
MR8 surgical dissecting tools	1
Contraindications	1
Special notices	1
Warnings	1
System	1
System cables	2
Tools and disposable components	2
Cautions	3
IPC set up	4
Connection to IPC	4
IPC pump detection	4
IPC touchscreen controls	4
Speed	4
Irrigation	5
Acceleration and deceleration	5
Rotation (FWD and REV)	5
Safe mode (SAFE)	5
MR8 electric motors	6
MR8 electric and electric plus motors	7
Multifunction foot control unit	7
Technical specifications	7
MR8 electric touch motors	8
Finger lever controls	8
Technical specifications	9
Guidance and manufacturer's declaration - electrical safety EMC (electromagnetic compatibility)	9
Functional standards for electrical systems	9
Part-1: Electromagnetic immunity	9
Part-1: Electromagnetic emissions	10
Recommended separation distances between portable and mobile RF communications equipment and the MR8 system	10
Part-2: Guidance and manufacturer's declaration – electromagnetic immunities	10
MR8 surgical dissecting tools	11
Assembly	11
Tool nomenclature	11
MR8 attachments	14
Straight attachments	15
Angled attachments	16
Variable exposure straight and angled attachments	17
Angled double lock (DK) attachments	17
Fixed footed attachments	18
Rotating footed attachments	20
Metal cutting attachments	21
Telescoping attachments and tubes	22
Perforator driver attachments	23
Jacobs chuck attachments	24
J-latch attachments	25
Irrigation tubing set	25
System accessories: disposable components	26
Cleaning brushes	26
System accessories: non-disposable components	26
Instrument trays	26
Rigid sterilization containers (sterilization cases)	27

MR8 system reprocessing instructions	27
Warnings and cautions.....	27
Limitations on reprocessing.....	27
Point of use.....	27
Containment and transportation	27
Preparation for cleaning: automated.....	28
Cleaning: automated	29
Cleaning: manual	30
Disinfection	31
Drying.....	31
Maintenance, inspection, and testing	31
Packaging.....	32
Sterilization.....	34
Storage.....	34
Use	34
Return policy for devices exposed to TSE (transmissible spongiform encephalopathies)	35
Planned maintenance.....	35
For scheduled maintenance intervals 1, 2, 3, 5, 6, 7, 9, 10, and 11	35
For scheduled maintenance intervals 4, 8, 12	36
Storage	36
Disposal.....	36
Troubleshooting	36
MR8 motor	36
MR8 attachments or telescoping tubes.....	37
MR8 dissecting tools.....	37
Medtronic Midas Rex MR8 electric high speed systems limited warranty*	38
Symbols.....	39

Glossary

The following words and acronyms may be used in this guide.

DK	Double locking
FCU	Foot Control Unit
FWD	Forward - Rotation is clockwise
IPC	Integrated Power Console
MR8	Midas Rex, 8th Generation
REV	Reverse - Rotation is counter-clockwise

General information

Read and understand this manual before use of the MR8 system. The MR8 system is designed for use by medical professionals familiar with powered surgical instrumentation. The surgeon is responsible for learning the proper techniques in the use of this system, as inappropriate use may potentially be harmful. It is strongly recommended that the surgeon and dedicated operating room personnel are knowledgeable with the use of this equipment by being trained in Medtronic Midas Rex Hands-On Workshops or by one of the local authorized representatives.

Indications for use

The Medtronic MR8 drill system is indicated for the incision/cutting, removal, drilling, and sawing of soft and hard tissue, bone, and biomaterials in Neurosurgical (Cranial and Craniofacial including Craniotomy); Ear, Nose, and Throat (ENT), Maxillofacial, Orthopedic, Arthroscopic, Spinal, Sternotomy, and general surgical procedures.

Additionally, the MR8 drill system is indicated for the incision/cutting, removal, drilling, and sawing of soft and hard tissue, bone, and biomaterials during open and minimally invasive spine procedures, which may incorporate application of various surgical techniques during the following lumbar spinal procedures:

- Lumbar Microdiscectomy
- Lumbar Stenosis Decompression
- Posterior Lumbar Interbody Fusion (PLIF)
- Transforaminal Lumbar Interbody Fusion (TLIF)
- Anterior Lumbar Interbody Fusion (ALIF)
- Direct Lateral Interbody Fusion (DLIF)

MR8 system description

MR8 electric motors

Electric motors provide power to operate interchangeable, disposable surgical dissecting tools. These motors are designed to interface with a series of attachments and surgical dissecting tools utilizing a standard quick-disconnect locking mechanism. Motors operate in the same manner whether controlled by a finger mechanism or FCU.

MR8 attachments

Attachments are designed to align the surgical tools with the motor to provide support and stability during various surgical procedures. Attachment options include regular (straight, and angled), variable exposure (straight and angled), footed (craniotomes), and telescoping attachments and tubes. There are a variety of specialty attachments, such as the perforator, Jacobs chuck, J-latch, and metal cutting that are also available. This allows flexibility with the length and style of attachment for surgeries.

MR8 surgical dissecting tools

Surgical dissecting tools are designed and intended to resect, drill, or saw soft and hard tissue, bone, biomaterials, and metals during various surgical procedures. The surgical dissecting tools vary in length and the distal tips of the tools vary in shape and style. The tip designs include the following universal shapes: acorn, match head, ball or round, cylinder, oval, and tapered or side-cutting. Specialized tools such as metal cutters, twist drills, hole-makers, hole saws, and reverse tapered tools are also available.

Contraindications

None.

Special notices

The words warning, caution, and note have special meanings in this manual and should be carefully reviewed:

Warning: A warning indicates that the personal safety of the patient or physician may be involved. Disregarding this information could result in injury to the patient or user.

Caution: A caution indicates that there is a risk of damaging equipment.

Note: A note is intended to provide additional information, which may be useful but is not essential to complete the procedure.

Warnings

System

- W1 The MR8 system operator must be familiar with this **Instructions for Use**, the **IPC User's Guide**, their precautions, procedures, and safety issues.
- W2 The MR8 system and its associated equipment should be used only by qualified medical professionals who are thoroughly trained and experienced in performing surgery with Medtronic computer-assisted surgery systems.
- W3 Always inspect the components before and after use for any damage. If damage is observed, do not use damaged component until it is repaired by Medtronic or replaced.
- W4 Use adequate irrigation during dissection to prevent thermal necrosis.
- W5 Do not use an overheated device, as it may cause thermal injury to the patient or operator.
- W6 Heavy side loads and/or long operating periods may cause the device to overheat.
 - W6a Never place an overheated motor on the patient or draping during the surgery.
 - W6b Discontinue use and rest the motor by using it intermittently or wrap the motor/attachment interface with a moist sterile towel.
 - W6c If the motor is passed off, the receiver should grasp the motor by the proximal end close to the motor cable.
- W7 Do not use excessive force to pry or push bone with the attachment or dissecting tool during surgery.
- W8 Use only dissecting tools specifically designed for use with this drill system. Match the nomenclature and color code on the MR8 dissecting tool packaging to the same nomenclature and color band on the MR8 attachment.
- W9 Do not use the MR8 system without proper cleaning and sterilization.
- W10 Sterilize and dry the reusable device before storing. Decrease the likelihood of cross-contamination with timely sterilization. After each procedure, properly clean and sterilize all reusable system components.
- W11 All service must be performed by Medtronic qualified personnel only.

The Midas Rex MR8 electric high-speed drill system

- W12 Employ visualization, including the use of imaging techniques (for example, fluoroscopy, image guided surgery), when using rotating powered accessories. Discontinue the powered application if visualization to the surgical site is lost.
- W13 Do not attempt to remove a dissecting tool or attachment while the motor is running or when the motor or attachment is in an overheated state to prevent laceration of the user and/or cross contamination through a compromised glove.
- W14 Do not immerse the system components, except when recommended by the cleaning instructions in this Instructions for Use.
- W15 The MR8 motors will not run unless the attachment is in the locked position.
- W16 Do not modify any components of the system; performance could be diminished.
- W17 Do not use the MR8 system if the motor continues to run after releasing the foot pedal or finger lever.
- W18 Do not place the motor, attachment, or dissecting tool on the patient or in an unsecured location during surgery.
- W19 Do not use an attachment and dissecting tool combination that results in tool flail or excessive vibration.
- W20 Do not attempt to run the MR8 motors immediately after autoclaving. Allow an adequate cooling period after steam sterilization.
- W21 Verify functionality prior to reuse:
 - W21a Conduct a visual inspection of the cables for cracks, tears, or corrosion.
 - W21b Check attachments for proper appearance. Install the attachment and dissecting tool, then briefly run the motor.
 - W21c Check motor for overheating.
 - W21d Check attachment for overheating.
 - W21e Check dissecting tool for flail.
 - W21f Check for bent or missing pins in the cable connectors.
- W22 Do not place MR8 motor in the proximity of a magnetic field, such as magnetic drape or Magnetic Resonance Imaging (MRI) equipment, to avoid inadvertent motor activation.
- W23 The MR8 system complies with IEC/EN60601-1-2, ed. 3.0 and ed. 4.0 safety standard for electromagnetic compatibility (EMC), requirements and test. However, if this equipment is operated in the presence of high levels of electromagnetic interference (EMI) or highly sensitive equipment, interference may be encountered, and the user should take whatever steps are necessary to eliminate or reduce the source of the interference. Diminished performance may lengthen operating time for anesthetized patient.
- W24 Medical electrical equipment needs special precautions regarding EMC and needs to be installed and put into service according to the EMC information provided in this system's Instructions for Use.
- W25 Portable and mobile radio frequency (RF) communications equipment can affect medical electrical equipment.
- W26 Use of accessories other than those specified and sold by Medtronic may result in increased emissions and decreased EM immunity of this unit.
- W27 Do not use metal-cutting attachment or tools to cut/resect bone.
- W28 For metal transection, observe the following safety guidelines:
 - W28a Wear eye protection.
 - W28b Irrigate well to cool the cutting surfaces.
 - W28c Protect the wound site from metal debris.
 - W28d Use a clamp or grasping device to control loose fragments during transection of any metal component.
- W29 Do not use any parts other than Medtronic system components, as damage or substandard performance could result.
- W30 When using MR8 variable exposure attachments, surgeons should become familiar with the performance of dissecting tools before use and should explore the effect of various levels of tool exposure on tool stability. If the tool exhibits excessive chatter, vibration, or movement, decrease the tool exposure.
- W31 Motors and attachments may fail due to extended use resulting in component(s) detaching and falling from the motor or attachment and may cause patient injury.
- W32 Electrical contacts must be dry prior to use.
- W33 When using the MR8 non-DK variable exposure attachments, ensure that the attachment is still in the locked position after each adjustment of the tool exposure. Attempting to increase the tool exposure too far may result in the attachment accidentally being unlocked.
- W34 Remove MR8 footed attachments cautiously and slowly, as per instructions to avoid injury to the operator.
- W35 Excessive side loading could cause non-DK angled attachments to unlock accidentally from motor.
- W36 Place MR8 touch motor in Safe mode ("0") while not in use.
- W37 When not operating the motor, eliminate accidental foot control activation.
- W38 Do not use the MR8 system in the presence of flammable anesthetics to avoid potential ignition or explosion of gases.
- W39 Do not operate the MR8 system without eye protection.
- W40 Do not sterilize and supply for surgical use any device that is not visibly clean and free of particulates. If particulates are present, repeat reprocessing, starting with the Preparation for Cleaning step.
- W41 Do not load more than one MR8 motor inside the instrument tray per sterilization cycle.
- W42 Do not wrap the rigid sterilization container.
- W43 Use the MR8 instrument tray and the rigid sterilization container for sterilizing the re-usable MR8 devices only.
- W44 Do not use alkaline cleaning for the instrument tray or the rigid sterilization container.
- W45 Use the instrument tray and the rigid sterilization container for sterilization only. The MR8 system devices must be cleaned separate from the trays.
- W46 Do not use the instrument tray and rigid sterilization container for cleaning or disinfection of the re-usable devices.
- W47 Devices cannot be sterilized to an adequate Sterility Assurance Level (SAL) without prior cleaning and decontamination.

System cables

- W48 Do not use cables or power cables with cracks, tears, or corrosion.

Tools and disposable components

- W49 Tool flutes are sharp and may perforate surgical gloves. Tool stems may be grasped with a hemostat to aid in installation and removal. Use methods at the operative site to control bleeding that do not compromise patient safety during surgery.
- W50 Keep the cutting area of the tool away from fingers and loose clothing to prevent laceration of the user and cross-contamination through a compromised glove.
- W51 A tool's size and geometry may create excessive vibration at certain speeds. Increase or decrease the speed of the motor to prevent vibration. Change to a new tool to prevent unintended tissue damage.
- W52 Excessive noise from the tool when drilling close to the cochlea or ossicular chain may cause patient hearing damage.
- W53 Consult the cranial perforator manufacturer device labeling for the recommended speed specifications.
- W54 Tools with "L" identification are longer tools intended for light bone dissection. The increased tool head/stem configuration may affect dissection stability.
- W55 Dissecting tools are for **single-use only**. Do not attempt to sterilize them. The dissecting tools are packed sterile and not intended for repeat use. To prevent contamination, use only once.

- W56 Excessive pressure applied to a tool may cause tool fracture. Should a tool fracture in use, extreme care must be exercised to ensure that all the fragments of the tool are removed from the patient. Unremoved tool fragments may cause tissue damage to the patient.
- W57 Do not sterilize disposable devices. They are sterilized at the factory and are not intended for repeat use. To prevent contamination, use only once.
- W58 Do not use an accessory if its packaging is damaged or opened outside the sterile field. Sterility may be compromised if packaging is opened or damaged.
- W59 Do not use dull tools. Use of dull tools can reduce cutting effectiveness and can cause the motor temperature to increase.
- W60 Fluted tools are designed to be used in forward mode. Diamond tools may be used in forward or reverse modes.
- W61 Exposure of tool packaging to ambient light for extended periods of time may cause damage to packaging.
- W62 The MR8 system operator should take appropriate measures in ensuring that sensitive anatomy is protected during drilling and use of the MR8 system.

Cautions

- C1 When using a non-DK angled attachment, hold the motor assembly by the attachment so that the attachment does not inadvertently loosen from the motor.
- C2 Do not use a twist drill at an operating speed over 62,000 rpm.
- C3 Remove devices from instrument tray before placing into washer-disinfector and allow devices to drain. Orient devices in the washer-disinfector by following manufacturer recommendations.
- C4 Do not use low-temperature hydrogen peroxide gas plasma sterilization due to the lumen internal diameter and length restrictions.
- C5 Do not use low-temperature liquid peracetic acid sterilization due to immersion procedure.
- C6 Remove and discard accessories following local regulations for disposal of contaminated materials.
- C7 Do not soak or submerge MR8 system devices.
- C8 Do not use ultrasonic cleaners for MR8 system devices.
- C9 Do not use chlorine-based or corrosive cleaning agents such as bleach, lye, acetone, sodium hypochlorite or bleach, sodium hydroxide, formic acid, or solutions containing glutaraldehyde.
- C10 Use only nylon cleaning brushes. Non-nylon cleaning brushes leave residue that may prevent the tool from being secured properly in the motor.
- C11 Do not expose these devices to sterilization temperatures greater than 137°C (279°F). Exposure to temperatures greater than 137°C (279°F) may impact the performance of the device and also the efficacy of the sterilization cycle.
- C12 Because of the variability in cleaning efficiencies and sterilizer operating parameters, all given parameters (temperature, time, etcetera) should be validated by persons who have training and expertise in sterilization processes. Deviation from the recommended sterilization processes is at the risk of the user facility.
- C13 Devices should be cleaned within 30 minutes (30:00) of use to limit fixation of contaminants.

The Midas Rex MR8 electric high-speed drill system

IPC set up

The following instructions for the electric MR8 motors are in addition to the general assembly instructions found in the **Integrated Power Console User's Guide**. To obtain a copy of the **IPC User's Guide**, please contact Medtronic or your local distributor.

Use an IPC device that has software version V2.7.3.0 or later, or update the IPC device to the latest software by contacting your Medtronic Neurosurgery Group sales representative. If outside the USA, contact your Medtronic regional distributor or Medtronic Neurosurgery Group sales representative.

Connection to IPC

Locate the MR8 motors, and Foot Control Unit (FCU) ports on the IPC connector panel (Figure 1) and insert the multi-pin connector.

Note: To insert multi-pin connectors (indicated by a silver or red mark on the connector), align the mark on the connector to the mark on the console, then insert the connector.

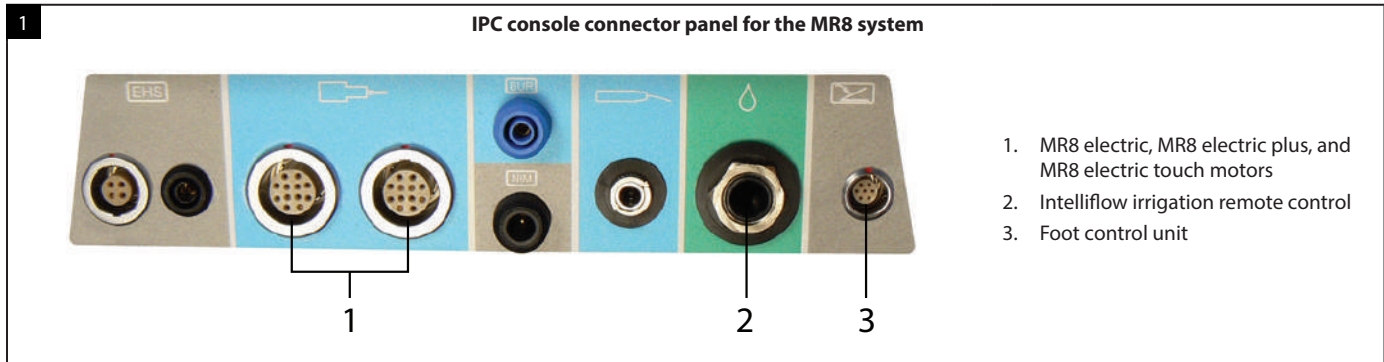

IPC pump detection

The IPC incorporates the MR8 electric, MR8 electric plus, and MR8 electric touch motor irrigation at Pump 1. If you do not use irrigation for the MR8 motors, manually change Pump 1 to **None**. Refer to the **IPC User's Guide, Set up and Prime Pumps** for more information.

When the system detects the MR8 electric or MR8 electric plus motor, Pump 2 defaults to **None**.

When the IPC detects both the MR8 electric or MR8 electric plus motor, the system defaults Pump 2 to the Shared configuration. Use the pumps screen to override the Shared default by selecting the MR8 electric motor for Pump 1. Refer to the **IPC User's Guide, Set up and Prime Pumps** for more information.

Control the operation of the MR8 electric, MR8 electric plus and MR8 electric touch motors with the IPC touchscreen and the multifunction foot control unit.

IPC touchscreen controls

To set or adjust the MR8 electric (Figure 2-1), the MR8 electric plus (Figure 2-2), or MR8 electric touch (Figure 2-3) motor controls, on the IPC touchscreen, in the control box, do the following:

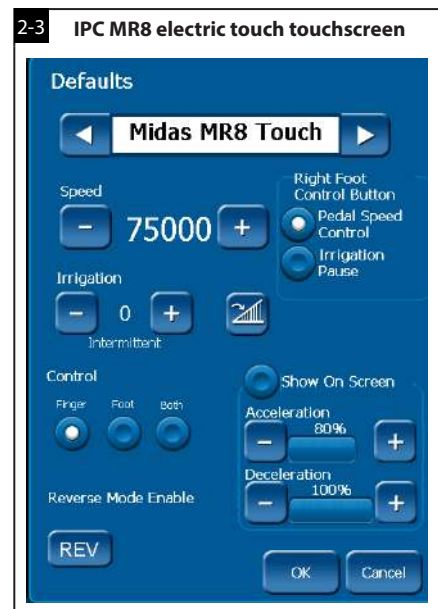
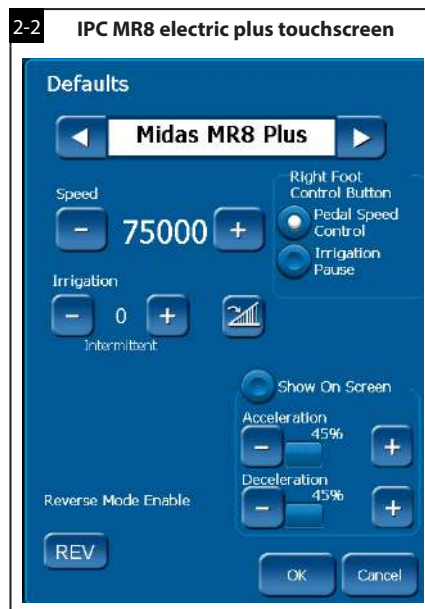
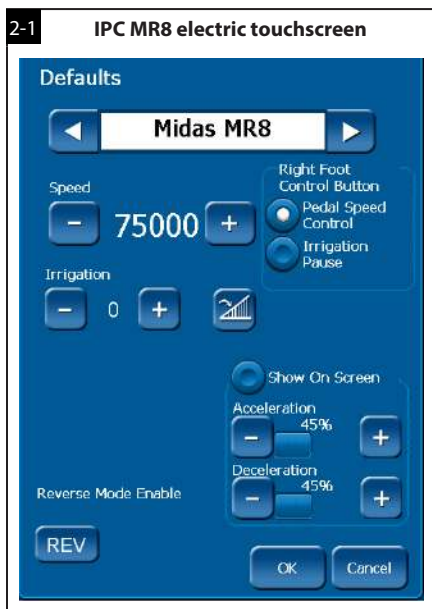

Speed

- The MR8 electric, MR8 electric touch, and MR8 electric plus motors have a default speed of 75,000 rpm and a variable speed adjustment of 200 to 75,000 rpms.
- To adjust speed in Forward (FWD) or Reverse (REV) mode, in the Speed control box, press the plus button to increase speed or the minus button to decrease speed. **+ -**

Note: When the MR8 electric touch motor is in safe mode, the Speed control box displays SAFE (Figure 4). Refer to the **Safe mode (SAFE)** topic for additional information.

Irrigation

- To adjust the irrigation flow rate, in the irrigation control box, press the plus button to increase flow rate or the minus button to decrease flow rate. If intermittent flow is available, pressing the plus or minus button progresses the system through intermittent and continuous flow. The system displays Intermittent when in intermittent flow mode.
Note: To adjust flow rate, you can use the touchscreen or the IntelliFlow irrigation remote control.
- The default flow rate is 0cc per minute in the Forward or Reverse mode.
- For additional instructions see the **IPC User's Guide**.

Acceleration and deceleration

- To adjust acceleration and deceleration, on the Defaults menu (Figure 2-1, 2-2, and 2-3), press the corresponding plus or minus button. Acceleration is the rate at which the motor speeds up to reach the target speed. Deceleration is the rate at which the motor slows down to reach the target speed or stop.
Note: While in the default menu, the motor will not be active to demonstrate the selected acceleration and deceleration. To determine the desired values, adjust the acceleration and deceleration during motor operation and note the preferred values.
- To enable adjustment of acceleration or deceleration during motor operation and to display the acceleration and deceleration adjustment options on the motor operational screen; On the Defaults menu, select Show On Screen and then press [OK]. To hide the acceleration and deceleration during motor operation, on the Defaults menu, deselect Show On Screen.

Rotation (FWD and REV)

- To change rotation mode, in the Mode control box, select FWD (forward) or REV (reverse).
Important: System configuration may be different from the default. If the REV (reverse) button appears raised (Figure 3-1) and does not have a selectable radio button, you cannot select the Reverse mode. If the REV button appears concave (Figure 3-2) and has a selectable radio button, you can select the Reverse mode via the touchscreen or the multifunction foot control unit.
- Confirm rotational direction on the IPC display prior to running a finger/foot control system check.

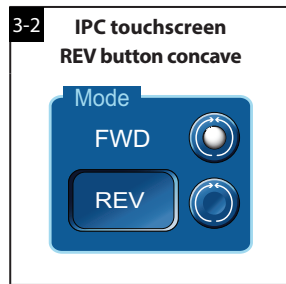
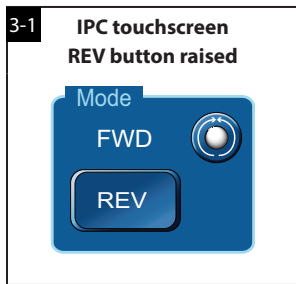

Safe mode (SAFE)

- The MR8 electric touch motor comes with a safe mode option. When the motor is in safe mode, it is inoperable until the safety is turned off. The Speed control box on the IPC touchscreen displays SAFE when the MR8 electric touch motor is the active motor and set to safe mode (Figure 4).
- Switch the device to safe mode any time it is attached to the console, but not currently being used. To set the motor to safe mode, on the MR8 electric touch motor, switch the safe mode switch to off (Figure 5).
- When more than one motor is attached to the console, use the safety switch of an inactive motor to activate that motor and make it ready for use.

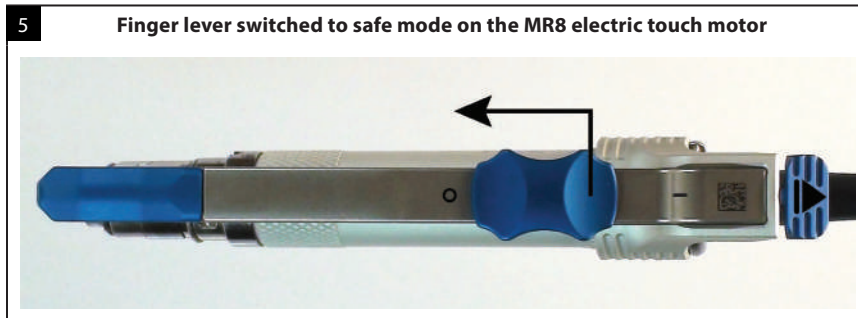
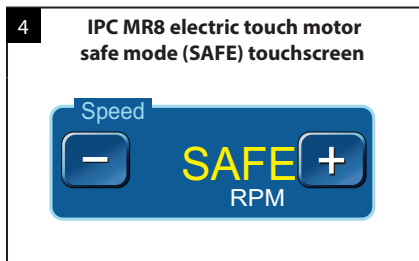

The Midas Rex MR8 electric high-speed drill system

MR8 electric motors

The MR8 electric motor (Figure 6) is a smaller and more compact version of the MR8 electric plus motor (Figure 7). The MR8 electric touch motor (Figure 8) is a small compact motor that includes a rotating and removable finger lever.

The MR8 electric motors are high-speed, high-torque, reversible electric motors used to dissect bone and biomaterial at selectable speeds from 200 to 75,000 rpm. These motors are designed to interface with a series of interchangeable attachments and dissecting tools utilizing a standard locking mechanism. The MR8 electric motors provide the power to operate disposable surgical dissecting tools, intended for use in various surgical procedures.

The MR8 electric motors can be controlled either by using the FCU or through the finger control mechanism. The finger-controlled electric motors operate in the same manner as the foot-controlled electric motors. Pressing the finger control increases the speed and lifting off of the finger control reduces the speed to a stop. The electric motors are reusable devices that are supplied non-sterile and require cleaning and sterilization prior to each surgical use.

Note: All motor cables are integrated and cannot be removed from the motor.

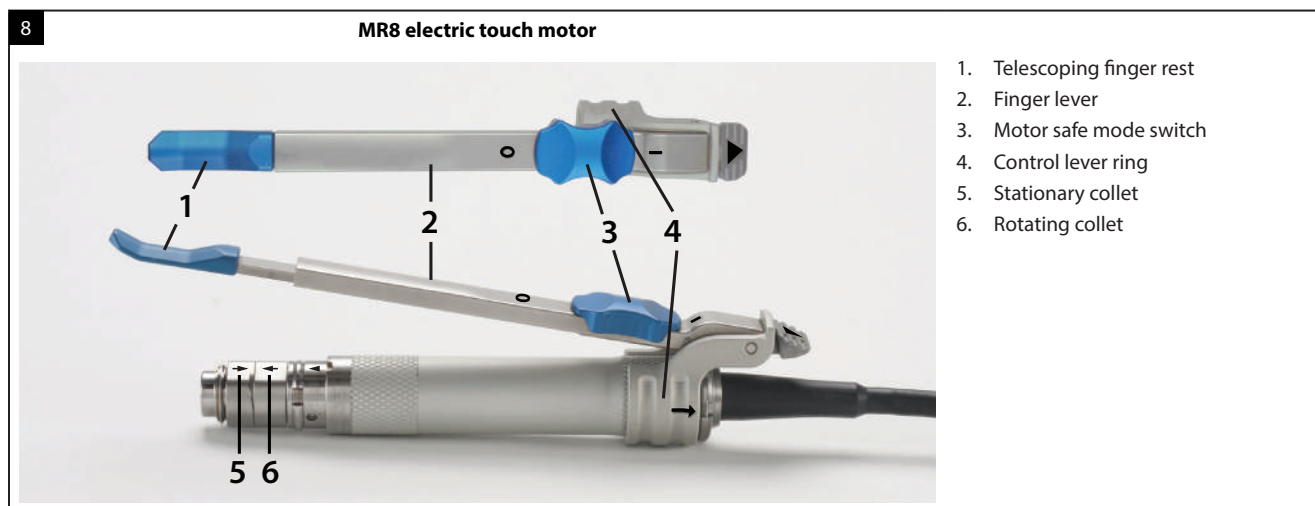
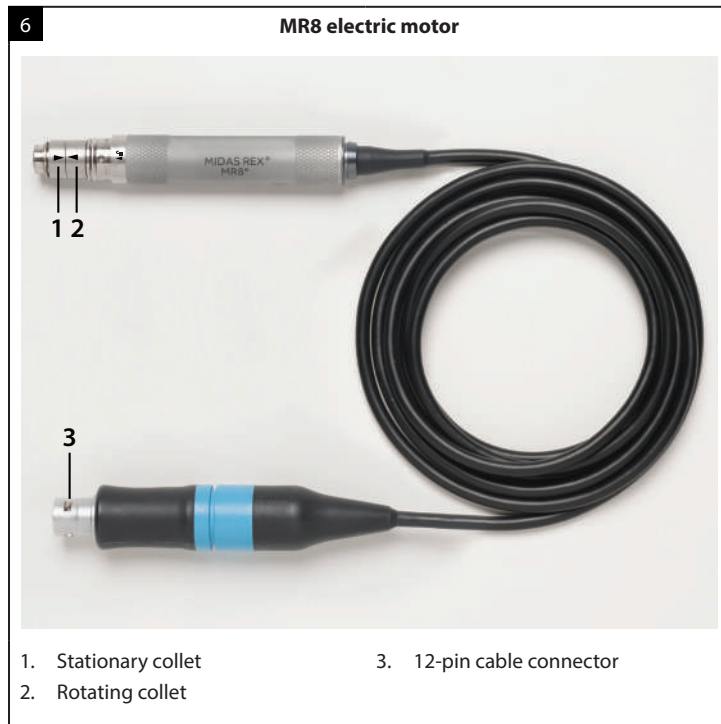



MR8 electric and electric plus motors

Multifunction foot control unit

Note: Conduct a system check by pressing the foot pedal to briefly run the motor and confirm proper function prior to any procedure.

Important: By default, the foot control unit is activated by pressing the corresponding button for at least 100 milliseconds (mS). Use the IPC touch screen settings screen to change the default value.

To use the multifunction foot control unit (Figure 9) to control the motor, do the following:

- To select Forward or Reverse mode, press the mode button (Figure 9, Number 1). 
- To start or adjust the speed of a motor in variable mode, press the foot pedal (Figure 9, Number 5).
- To toggle between the start/stop mode and variable speed mode, press the control button (Figure 9, Number 3). 

Note: Functionality of the control button may be changed in the motor Defaults menu to pause irrigation. Refer to **Change System Settings**, in the **Pre-Operating** instructions section of the **IPC User's Guide**.
- To change the motor, press the motor button (Figure 9, Number 2). 

Cleaning the multifunction foot control unit

For cleaning instructions refer to the section, **Clean the multifunction foot control unit**, in the **Cleaning and sterilization** section of the **IPC User's Guide**.

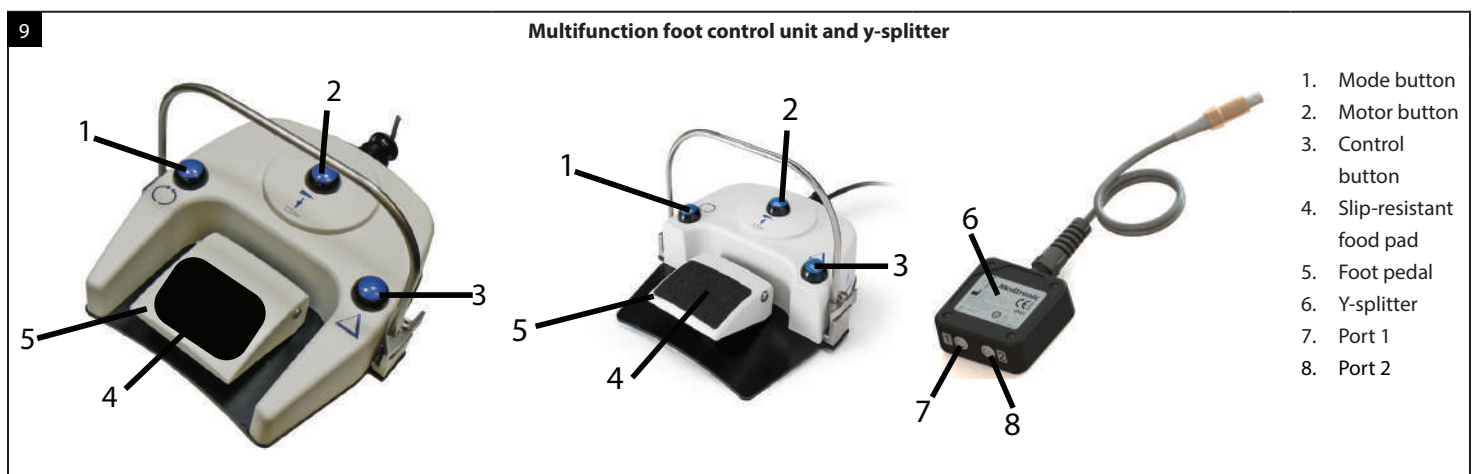

Technical specifications

Table 1: MR8 electric motor technical specifications

MR8 electric motor (EM800)			
Size	Weight	Speed	Duty cycle for applied part
Length: 9.73 cm (3.83 in) x Diameter: 1.55 cm (0.61 in) Length of motor cable: 460 cm (181 in)	87 grams	75,000 rpm forward/reverse	For operating room temperatures up to 40°C (104°F), the MR8 electric motor is rated for 3 minutes (03:00) of continuous cutting time at 75,000 rpm, all followed by 25 minutes (25:00) of rest. For normal operating room temperatures (typically 20°C/68°F), the MR8 electric motor is rated for continuous cutting at 75,000 rpm.

Table 2: MR8 electric plus motor technical specifications

MR8 electric plus motor (EM850)			
Size	Weight	Speed	Duty cycle for applied part
Length: 9.73 cm (3.83 in) x Diameter: 2.10 cm (0.83 in) Length of motor cable: 460 cm (181 in)	171 grams	75,000 rpm forward/reverse	For operating room temperatures up to 40°C (104°F), the MR8 electric plus motor is rated for 3 minutes (03:00) of continuous cutting time at 75,000 rpm, all followed by 25 minutes (25:00) of rest. For normal operating room temperatures (typically 20°C/68°F), the MR8 electric plus motor is rated for continuous cutting at 75,000 rpm.

The Midas Rex MR8 electric high-speed drill system

MR8 electric touch motors

Note: Conduct a system check by pressing the finger control to briefly run the motor and confirm proper function prior to any procedure.

The MR8 electric touch motor functions exactly as the electric motors that are controlled using the electric FCU but offers the operator an option to control the motor with a finger control mechanism. The MR8 electric touch motor also offers the user an option to control the motor with the foot via an electric FCU.

The IPC touchscreen control modes can engage/disengage the finger and foot controls on the MR8 electric touch motor (Figure 10).

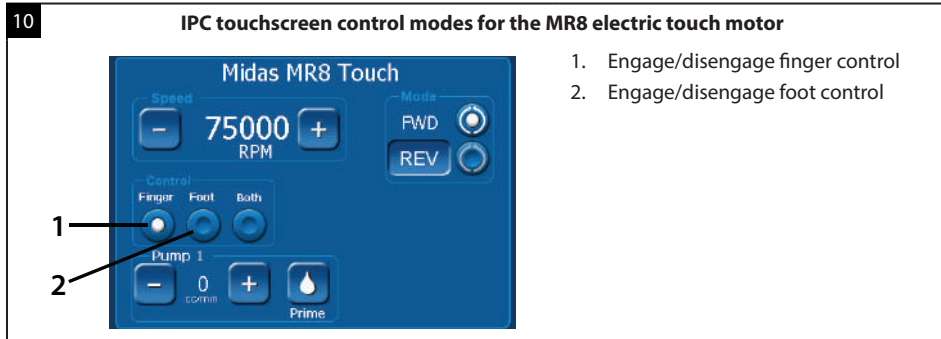

Finger lever controls

The MR8 electric touch motor includes a removable and rotating finger lever.

Assembly

1. Slide the finger lever onto the motor.
2. Align the arrow (Figure 11) with the alignment slots until the lever clicks into position.
Note: There is also an arrow on the unlock lever (Figure 11) that can be used to initially align the finger lever assembly to the alignment slots.
3. Conduct a system check by pressing the finger control to briefly run the motor and confirm proper function prior to any procedure.

Rotation

1. Unlock the finger lever by pressing the unlock lever forward (Figure 12).
2. Rotate the lever clockwise or counter clockwise until the arrow aligns with the alignment slots and lever clicks into position (Figure 13).

Disassembly:

1. Unlock the finger lever by pressing forward (Figure 12).
2. Slide the finger lever completely off the motor.

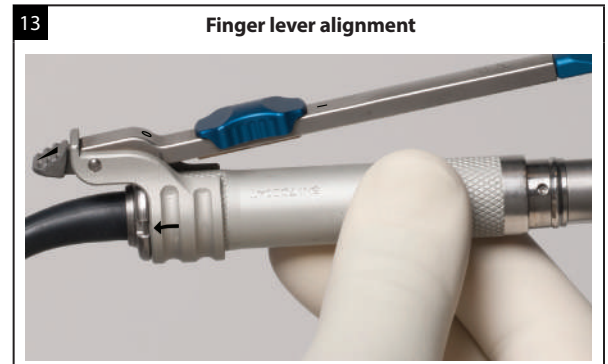
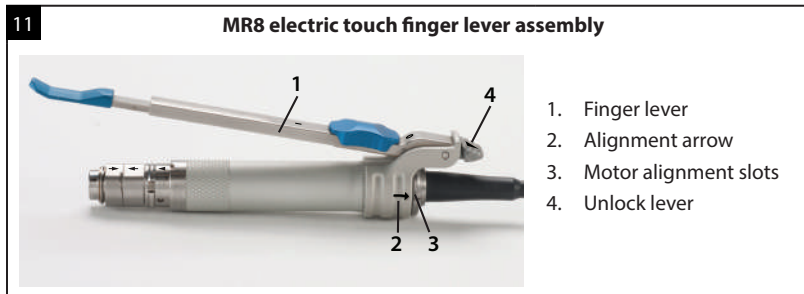

Technical specifications

Table 3: MR8 electric touch technical specifications

MR8 electric touch motor (EM810)			
Size	Weight	Speed	Duty cycle for applied part
Length: 10.38 cm (4.09 in) x Diameter: 1.59 cm (0.62 in) • Length of motor cable: 460 cm (181 in)	90 grams	75,000 rpm forward/reverse	For operating room temperatures up to 40°C (104°F), the MR8 electric touch motor is rated for 3 minutes (03:00) of continuous cutting time at 75,000 rpm, all followed by 25 minutes (25:00) of rest. For normal operating room temperatures (typically 20°C/68°F), the MR8 electric touch motor is rated for continuous cutting at 75,000 rpm.

Guidance and manufacturer's declaration - electrical safety EMC (electromagnetic compatibility)

Functional standards for electrical systems

ANSI/AAMI ES60601-1	Medical electrical equipment - Part 1: General requirements for basic safety and essential performance 2005, CORR. 1:2009, AMMEND. 1:2012
IEC 60601-1	Medical electrical equipment - Part 1: General requirements for basic safety and essential performance 2005, CORR. 1:2006, CORR. 2:2007, AMMEND. 1:2012
EN 60601-1	Medical electrical equipment - Part 1: General requirements for basic safety and essential performance 2006, AMMEND. 12:2014
IEC 60601-1-4	Medical electrical equipment - Part 1: General requirements for safety, Part 4: Programmable electrical medical systems 1996, AMMEND. 1:1999
IEC 60601-1-2	Medical electrical equipment - Part 1-2: General requirements for safety, collateral standard: electromagnetic compatibility - requirements and tests ED. 3.0:2007, ED. 4.0:2014
CAN/CSA C22.2#60601-1	Medical electrical equipment - Part 1: General requirements for safety ED. 3.0:2014

Environment of intended use:

- Professional healthcare facility environment

Part-1: Electromagnetic immunity

The MR8 system is intended for use in the electromagnetic environment specified below. The customer or the user of the MR8 system should assure that it is used in such an environment.

Immunity test	Test level (IEC/EN 60601-1-2)	Compliance level	Electromagnetic environment – guidance
Electrostatic discharge (ESD) IEC 61000-4-2	± 8 kV contact	± 8 kV contact	The relative humidity should be at least 5%.
	± 15 kV air	± 15 kV air	Note 1 and 3
Electrical fast transient/burst IEC 61000-4-4	± 2 kV for power supply lines ± 1 kV for input/output lines	± 2 kV for power supply lines ± 1 kV for input/output lines	Mains power quality should be that of a typical commercial or hospital environment.
Surge IEC 61000-4-5	±1 kV line to line ±2 kV line to earth	±1 kV line to line ±2 kV line to earth	Mains power quality should be that of a typical commercial or hospital environment.
Voltage dips, short interruptions and voltage variations on power supply input lines IEC 61000-4-11	0 % U_T (100 % dip in U_T) for 0.5 cycle at 0°, 45°, 90°, 135°, 180°, 225°, 270°, and 315°	0 % U_T (100 % dip in U_T) for 0.5 cycle at 0°, 45°, 90°, 135°, 180°, 225°, 270°, and 315°	Mains power quality should be that of a typical commercial or hospital environment. If the user of the MR8 system requires continued operation during power mains interruptions, it is recommended that the MR8 system be powered from a uninterruptible power supply or a battery.
	0 % U_T (100 % dip in U_T) for 1 cycle at 0°	0 % U_T (100 % dip in U_T) for 1 cycle at 0°	
	40 % U_T (60 % dip in U_T) for 5 cycles	40 % U_T (60 % dip in U_T) for 5 cycles	Note 1 and 3
	70 % U_T (30 % dip in U_T) for 0.5 sec	70 % U_T (30 % dip in U_T) for 0.5 sec	
	0 % U_T (100 % dip in U_T) for 5 sec	0 % U_T (100 % dip in U_T) for 5 sec	
Power frequency (50/60 Hz) magnetic field IEC 61000-4-8	30 A/m	30 A/m	Power frequency magnetic fields should be at levels characteristic of a typical location in a typical commercial or hospital environment

Note:

- U_T is the mains voltage prior to application of the test level.
- When the console is powered and connected to the foot switch, application of -15KV air discharge onto the foot switch buttons may cause the console to freeze. Power cycle the console to re-establish normal operation.
- All MR8 electric motors are compliant with IEC/EN60601-1-2, ed. 3.0 and ed. 4.0 standards. Refer to the **IPC User's Guide** to determine specific standard compliance for the system.

The Midas Rex MR8 electric high-speed drill system

Part-1: Electromagnetic emissions

The MR8 system is intended for use in the electromagnetic environment specified below. The customer or the user of the MR8 system should assure that it is used in such an environment.

Emissions test	Compliance	Electromagnetic environment – guidance
RF emission CISPR 11	Group 1	The MR8 system uses RF energy only for its internal function. Therefore, its RF emissions are very low and are not likely to cause any interference in nearby electronic equipment.
RF emission CISPR 11	Class A	The MR8 system is suitable for use in all establishments, other than domestic and those directly connected to the public low-voltage power supply network that supplies buildings for domestic purpose.
Harmonic emissions IEC 61000-3-2	Class A	
Voltage fluctuations/flicker emissions IEC 61000-3-3	Complies	

Recommended separation distances between portable and mobile RF communications equipment and the MR8 system

The MR8 system is intended for use in an electromagnetic environment in which radiated RF disturbances are controlled. The customer or the user of the MR8 system can help prevent electromagnetic interference by maintaining a minimum distance between portable and mobile RF communications equipment (transmitters) and the MR8 system as recommended below, according to the maximum output power of the communications equipment.

Rated maximum power of transmitter W	Separation distance (in meters) according to frequency of transmitter						
	380MHz-390MHz d = 0.22√P	430MHz-470MHz d = 0.22√P	704MHz-787MHz d = 0.67√P	800MHz-960MHz d = 0.22√P	1.7GHz-1.99GHz d = 0.22√P	2.4GHz-2.57GHz d = 0.22√P	5.1GHz-5.8GHz d = 0.67√P
0.01	0.03	0.03	0.07	0.03	0.03	0.03	0.07
0.1	0.07	0.07	0.21	0.07	0.07	0.07	0.21
1	0.22	0.22	0.67	0.22	0.22	0.22	0.67
10	0.7	0.7	2.12	0.7	0.7	0.7	2.12
100	2.2	2.2	6.7	2.2	2.2	2.2	6.7

For transmitters rated at a maximum output power not listed above, the recommended separation distance *d* in meters (m) can be determined using the equation applicable to the frequency of the transmitter, where *P* is the maximum output power rating of the transmitter in watts (W) according to the transmitter manufacturer.

Note: These guidelines may not apply in all situations. Electromagnetic propagation is affected by absorption and reflection from structures, objects and people.

Part-2: Guidance and manufacturer’s declaration – electromagnetic immunities

The MR8 system is intended for use in the electromagnetic environment specified below. The customer or the user of the MR8 system should assure that it is used in such an environment.

Immunity test	Test level (IEC/EN 60601-1-2)	Compliance level	Electromagnetic environment - guidance
Conducted RF IEC 61000-4-6	3 Vrms 150 kHz to 80 MHz	3 Vrms 150 kHz to 80 MHz	Portable RF communications equipment (including peripherals such as antenna cables and external antennas) should be used no closer than 30 cm (12 inches) to any part of the MR8 system, including cables specified by the manufacturer. Otherwise, degradation of the performance of this equipment may result.
	6 Vrms 150 kHz to 80 MHz in ISM bands	6 Vrms 150 kHz to 80 MHz in ISM bands	
Radiated RF IEC 61000-4-3	3 V/m 80 MHz to 2.7 GHz	3 V/m 80 MHz to 2.7 GHz	Portable and mobile RF communications equipment should be used no closer to any part of the MR8 system including cables, than the recommended separation distance calculated from the equation applicable to the frequency of the transmitter. Recommended separation distance: $d = \frac{6}{E} \sqrt{P}$ Where <i>P</i> is the maximum output power rating of the transmitter in watts (W) according to the transmitter manufacturer, <i>E</i> is the immunity test levels in volt per meter (V/m), and <i>d</i> is the recommended separation distance in meters (m). Interference may occur in the vicinity of equipment marked with the following symbol: 
	9 – 28 V/m Spot frequencies 385MHz to 5.785 GHz	9 – 28 V/m Spot frequencies 385MHz to 5.785 GHz	
	Pulse modulation	Pulse modulation	

Note: These guidelines may not apply in all situations. Electromagnetic propagation is affected by absorption and reflection from structures, objects and people.

MR8 surgical dissecting tools

The MR8 surgical dissecting tools (Figure 14) are designed and intended to resect, drill, or saw soft and hard tissue, bone, biomaterials, and metals during various surgical procedures. Angled, metal cutting and telescoping attachments feature a tool lock mechanism that secures tool in the attachment. For other attachments, the tool is locked in the motor collet at the same time as the attachment is locked on the motor.

All MR8 surgical dissecting tools are similarly constructed in that they have a dissecting tip (head) of various shapes and are provided in various lengths and geometries for different surgical needs. The head designs of the surgical dissecting tools include the following universal shapes: match head, ball or round, oval, hole maker, hole saw, cylinder, acorn, tapered or side cutting, twist drill, metal cutter, and reverse tapered. Tool heads may be fluted or diamond coated.

Assembly

Refer to the applicable attachment assembly instructions in this Instructions for Use for details on the assembly of an attachment to a motor.

Tool nomenclature

Part numbers for MR8 surgical dissecting tools follow a nomenclature, which is described in the diagram below (Figure 15). Standard tool part numbers consist of the associated attachment length, the tool family identifier, and the tool head diameter. Part numbers may also include a variety of prefixes to identify specific attachment types, as well as a variety of suffixes to provide additional information about the dissecting tool.

Note: The surgical tools are designed and labeled for single-use only. The tools are supplied Gamma sterilized, in sealed packaging.

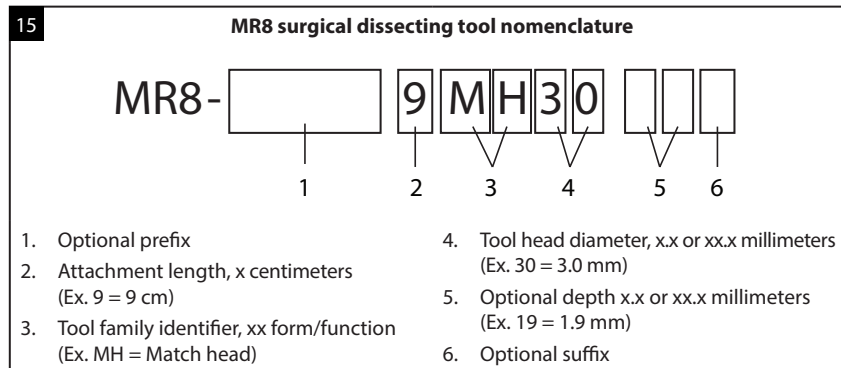

Tool number prefixes

Note: A single part number will use only one prefix.

Prefix	Tool attachments
F	Footed attachments
T	Telescoping tube





Tool family identifier (form/function)



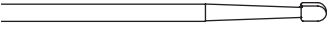

AC	Acorn
BA	Ball
CY	Cylinder
HM	Hole maker
HS	Hole saw
MC	Metal cutter
MH	Match head
OV	Oval
RT	Reverse taper
TA	Tapered or side cutter
TD	Twist drill

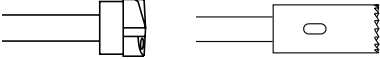
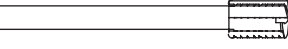
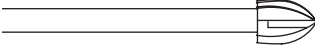
Tool number suffixes

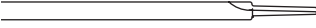
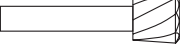
Note: More than one suffix may be combined in a single part number.

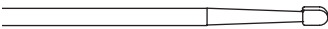
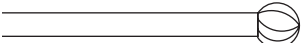
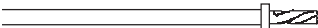
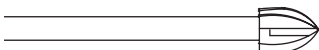
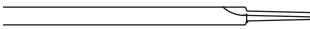
Suffix	Tool head cutting modifiers
B	Ball
BR	Barrel
C	Carbide
CS	Cornerstone
D	Diamond
DC	Diamond coarse
DF	Diamond fine
DX	Diamond extra coarse
DXF	Diamond extra fine
F	Fine
M	Match flute (on telescoping tools)
S	Spiral flutes
T	3-Flute or symmeTRI
X	Extra
XF	Extra fine
Tool length modifiers	
L	Long

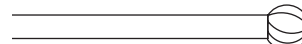
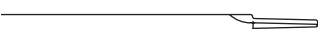
Surgical application	Commonly used attachments	Commonly used dissecting tools
Spine	MR8 9, MR8 14, and MR8 15	Match head  Elongated spherical design allows controlled, delicate dissection. For entry hole, nerve decompression, osteophyte removal, sinus dissection, etcetera.
		Ball  Helical cutting flutes dissect bone or cement effectively from a wide variety of approach angles. For debridement, decortication, sinus dissection, etcetera.
		Oval  Helical cutting flutes and curved design blend acorn and ball styles to vary dissection efficiency with approach angle. For decortication, laminotomy, entry hole, nerve decompression, osteophyte removal, etcetera.
		Hole maker and hole saw  Matched sets of hole makers and hole saws are efficient and effective for interbody fusion.
		Cylinder  Effective bone sculpting and planing. For graft shaping, debridement, corpectomy, decortication, interbody fusion, fusion takedown, etcetera.
		Acorn  Curved design varies dissection efficiency with varied approach angles. For entry hole, laminotomy, bone shaping, debridement, corpectomy, decortication, fusion takedown, etcetera.
Spine	MR8 telescoping	Match head  Elongated spherical design allows controlled, delicate dissection. For entry hole, nerve decompression, osteophyte removal, sinus dissection, etcetera.
		Tapered  Slender design for precise dissection with minimal bone loss. For transection, osteotomy, graft harvesting, bone shaping, entry hole, suture hole, midface advancement, etcetera.
Spine	MR8 footed, MR8 straight	Reverse tapered  Semi-trapezoidal shape with helical cutting flutes and a smooth cutting tip designed for efficient bone sculpting and planing. For graft shaping, debridement, and decortication.

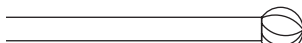
Surgical application	Commonly used attachments	Commonly used dissecting tools
Neurosurgical—cranial	MR8 7, MR8 9, MR8 10, MR8 14, and MR8 15	<p>Match head  Elongated spherical design allows controlled, delicate dissection. For entry hole, nerve decompression, osteophyte removal, sinus dissection, etcetera.</p> <p>Ball  Helical cutting flutes dissect bone or cement effectively from a wide variety of approach angles. For debridement, decortication, sinus dissection, etcetera.</p> <p>Twist drill  Helical design with stop produces a hole with a precise depth. Ideal for plating.</p> <p>Acorn  Curved design varies dissection efficiency with varied approach angles. For entry hole, laminotomy, bone shaping, debridement, corpectomy, decortication, fusion takedown, etcetera.</p> <p>Tapered  Slender design for precise dissection with minimal bone loss. For transection, osteotomy, graft harvesting, bone shaping, entry hole, suture hole, midface advancement, etcetera.</p>
	MR8 footed	
General surgery and plastic surgery (craniofacial/ maxillofacial/ sternotomy)	MR8 7, MR8 9, MR8 10, and MR8 14	<p>Match head  Elongated spherical design allows controlled, delicate dissection. For entry hole, nerve decompression, osteophyte removal, sinus dissection, etcetera.</p> <p>Ball  Helical cutting flutes dissect bone or cement effectively from a wide variety of approach angles. For debridement, decortication, sinus dissection, etcetera.</p> <p>Tapered  Slender design for precise dissection with minimal bone loss. For transection, osteotomy, graft harvesting, bone shaping, entry hole, suture hole, midface advancement, etcetera.</p> <p>Twist drill  Helical design with stop produces a hole with a precise depth. Ideal for plating.</p>
Ear, nose, and throat (otology, neurotology)	MR8 7, MR8 10	<p>Ball  Helical cutting flutes dissect bone or cement effectively from a wide variety of approach angles. For debridement, decortication, sinus dissection, etcetera.</p>

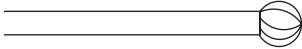
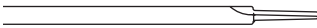
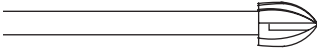
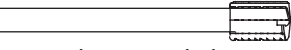
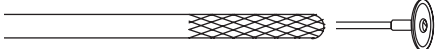
Surgical application	Commonly used attachments	Commonly used dissecting tools
Orthopaedics	MR8 9, MR8 14, MR8 21, MR8 26, MR8 footed, and MR8 telescoping	Ball  Helical cutting flutes dissect bone or cement effectively from a wide variety of approach angles. For debridement, decortication, sinus dissection, etcetera.
		Tapered  Slender design for precise dissection with minimal bone loss. For transection, osteotomy, graft harvesting, bone shaping, entry hole, suture hole, midface advancement, etcetera.
		Acorn  Curved design varies dissection efficiency with varied approach angles. For entry hole, laminotomy, bone shaping, debridement, corpectomy, decortication, fusion takedown, etcetera.
		Cylinder  Effective bone sculpting and planing. For graft shaping, debridement, corpectomy, decortication, interbody fusion, fusion takedown, etcetera.
Biometals/bioceramics/ biomaterials	MR8 MC9, MR8 MC14	Metal cutter  Cutting flutes or diamond wheel design remove metals, ceramics and other biomaterials effectively from a variety of approach angles. For cutting rods, pins, plates, implants, screws, etcetera.

MR8 attachments

Note: To assemble DK attachments, follow the instructions for the respective attachment. To disassemble DK attachments, push the attachment distally before rotating. The attachments provide support and stability to the rotating surgical tools during use in various surgical procedures. The attachments are reusable devices, supplied non-sterile, and require cleaning and sterilization prior to each surgical use. Attachments feature a tool lock mechanism that secures and aligns the tool to the attachment. Arrow icons (Figure 16-1) are etched onto attachments and motors to guide the user to lock (Figure 16-2) or unlock (Figure 16-3) the attachment from the motor.

MR8 attachments are available in various designs, lengths, and diameters to facilitate a variety of surgical procedures. The attachments family includes a variety of MR8 standard attachments, fixed and rotating footed (craniotomes), telescoping, and specialty attachments (metal cutters, Jacobs chuck, J-latch, and perforator attachments). MR8 standard attachments consist of straight and angled configurations, which are offered either as fixed or variable exposure. The availability of the Medtronic attachments allows the surgeon flexibility to choose the appropriate length and style for each type of surgical procedure, including minimal access surgeries. They are marked and color-coded to correspond with their associated dissecting tools. Angled and straight attachments with the same length, marking, and color band share the same dissecting tool. Telescoping tubes with the same length, marking, and color band also share the same dissecting tool.

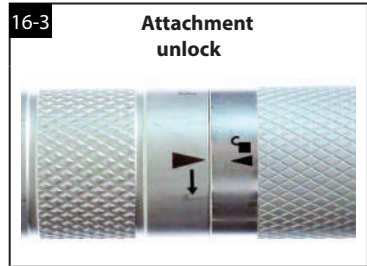
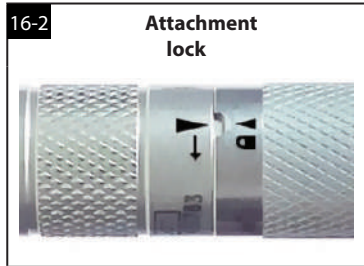
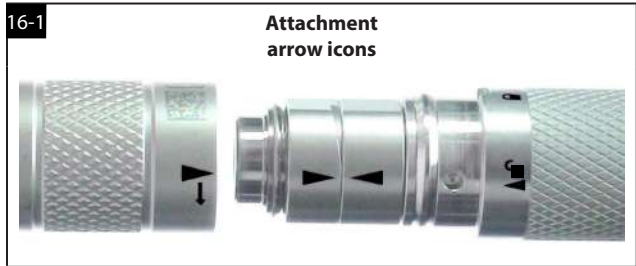

Straight attachments

Warnings:

- The MR8 motors do not run at all, if not locked.
- Use only dissecting tools specifically designed for use with this drill system. Match the nomenclature and color code on the MR8 dissecting tool packaging to the same nomenclature and color band on the MR8 attachment.

Note: An attachment will not seat on the motor if the arrows on the collet flats are not in proper alignment.

Assembly:

1. Slide a straight attachment over the motor collet aligning the triangular arrows on the attachment and the motor case (Figure 17-1). An audible click, heard and perceptible by touch, confirms that the attachment is fully seated.
2. Insert the tool into the attachment with a slight rotational motion (Figure 17-2). An audible click, heard and perceptible by touch, confirms that the tool is fully seated.
3. Rotate the attachment in the direction indicated by arrow on the attachment until the attachment alignment mark is directly in line with the locked symbol (Figure 17-3).
Note: When a click is heard the attachment is fully seated and the collet brake fully released.
4. Gently pull on the tool to ensure that it is locked into the motor.
Note: Tool should rotate freely. If not, unlock the attachment, re-seat the tool, and re-lock the attachment.

Disassembly

1. Hold the motor in palm of hand. Rotate the attachment to the unlocked position. In this position, the arrows in the attachment and motor will line up as in Figure 17-2.
2. Pull the dissecting tool from the attachment and discard the tool.
3. Use thumb and index finger to lift the attachment off of the motor.

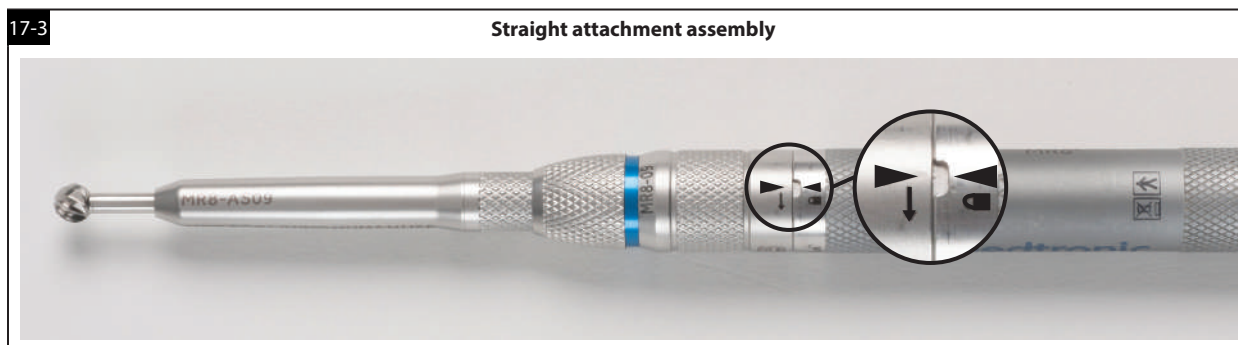
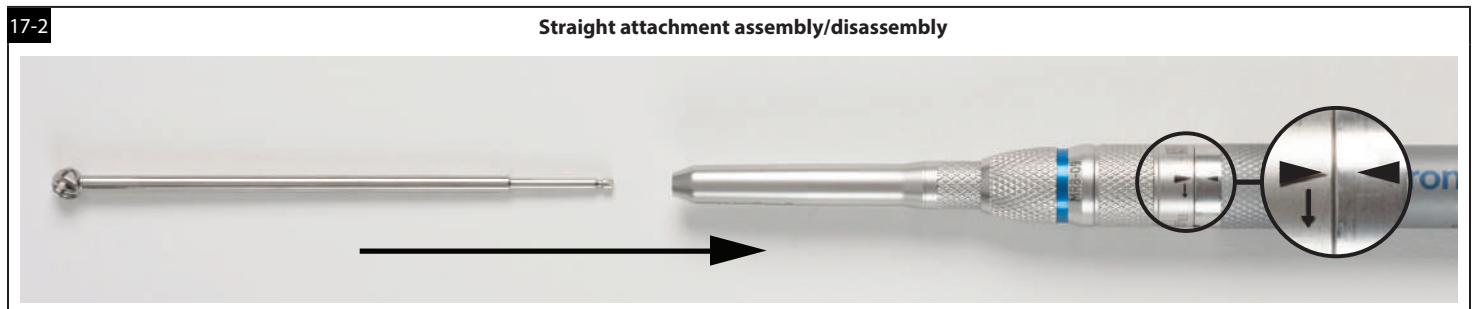
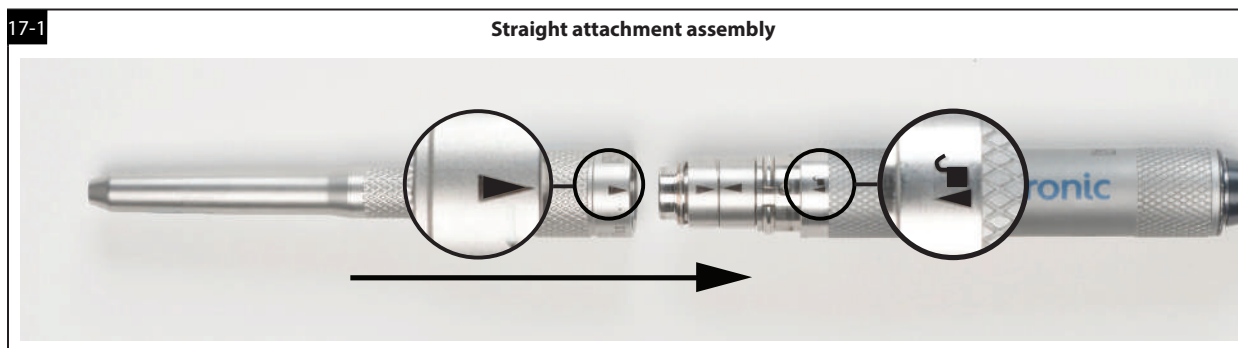

The Midas Rex MR8 electric high-speed drill system

Angled attachments

Warnings:

- The MR8 motors do not run at all, if not locked.
- Use only dissecting tools specifically designed for use with this drill system. Match the nomenclature and color code on the MR8 dissecting tool packaging to the same nomenclature and color band on the MR8 attachment.

Notes:

- An attachment will not seat on the motor if the arrows on the collet flats are not in proper alignment.
- To assemble DK attachments, follow the instructions for the respective attachment. To disassemble DK attachments, pull the attachment distally before rotating.
- A dissecting tool may be installed and locked in the attachment before the angled attachment is installed onto the motor.
- Angled and straight attachments with the same length, marking, and color band share the same dissecting tools.

Assembly

1. With the tool lock in the unlocked position, insert a tool into the angled attachment with a slight rotational motion (Figure 18-1). An audible click, heard and perceptible by touch, confirms that the tool is fully seated.
2. Rotate the tool lock/unlock sleeve in the direction indicated by arrow until the tool lock alignment mark is directly in line with the locked symbol (Figure 18-2).
3. Gently pull on the tool to ensure that it is locked into the motor.
Note: Tool should rotate freely. If not, unlock the attachment, re-seat the tool, and re-lock the attachment.
4. Slide the angled attachment over the motor collet aligning the triangular arrows on the attachment and the motor case. An audible click, heard and perceptible by touch, confirms that the attachment is fully seated.
5. Rotate the attachment in the direction indicated by the arrow until attachment alignment mark is directly in line with the locked symbol.
Note: When a click is heard the attachment is fully seated and the collet brake fully released.
6. Verify that both the attachment to motor alignment mark and the tool lock alignment mark are directly in line with the locked symbols (Figure 18-3).

Disassembly

1. Rotate the tool lock to the unlocked position to remove the tool from the attachment.
2. Rotate the attachment to the unlocked position and lift attachment off of the motor.

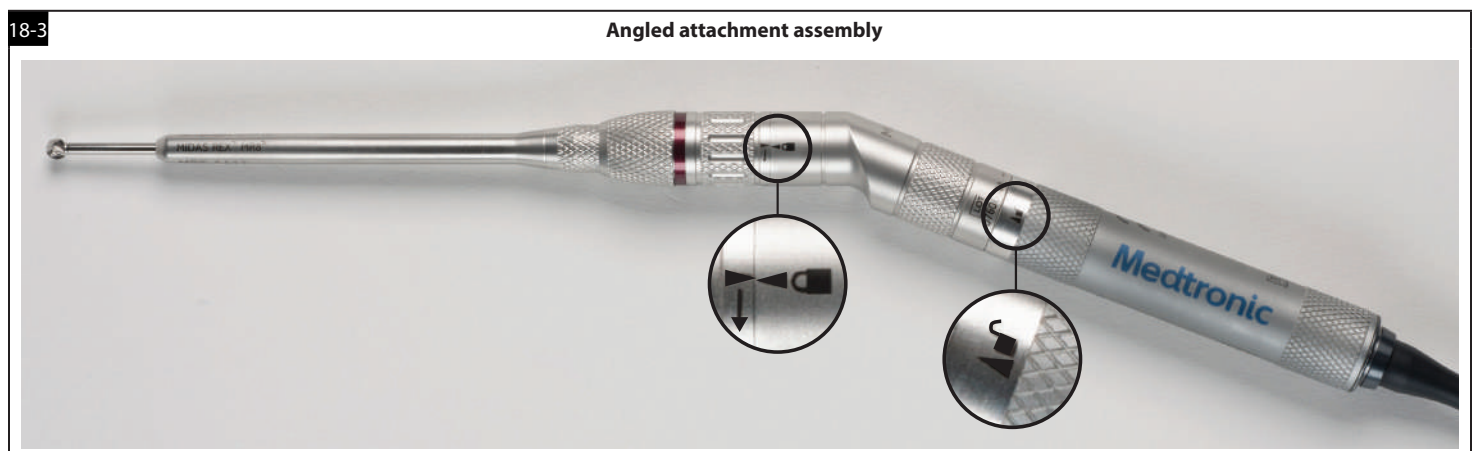
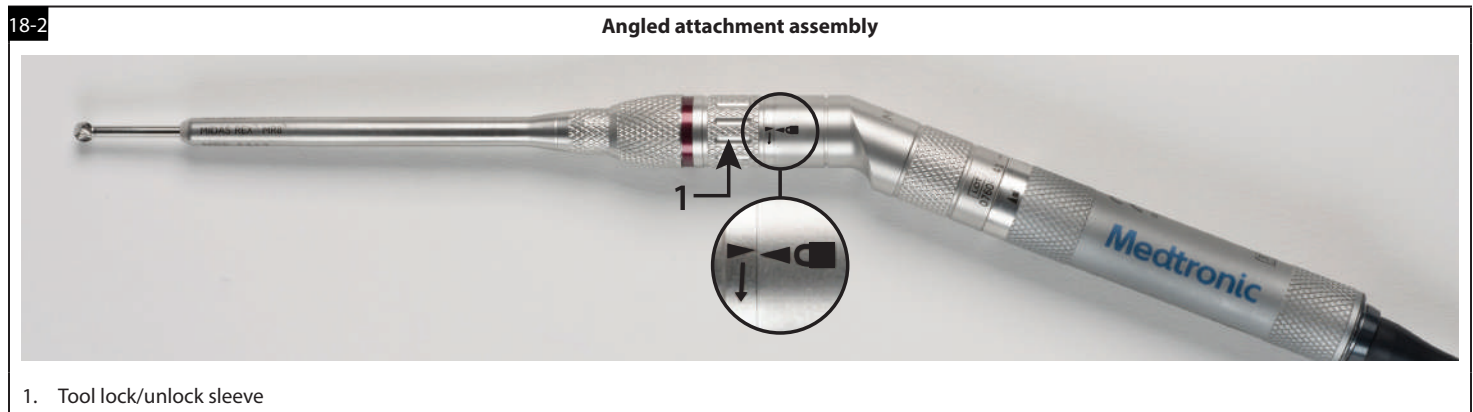
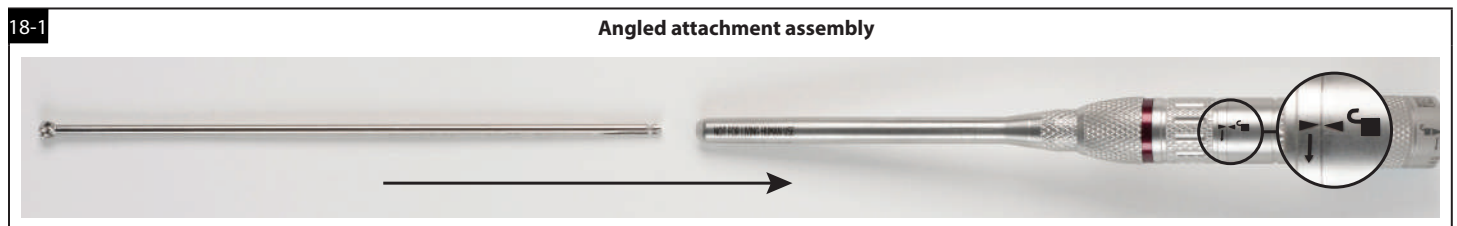

Variable exposure straight and angled attachments

The variable exposure attachments allow the user to vary the exposure of the tool by adjusting the attachment tube. Match the color band on the attachment to the color code on the dissecting tool packaging.

Warning: Surgeons should familiarize themselves with the performance of dissecting tools before use and should explore the effect of various levels of tool exposure on dissection stability. If the tool exhibits excessive chatter, vibration, or movement, decrease the tool exposure.

Notes:

- For fixed and variable straight attachments, the tool is locked in the motor collet. On fixed and variable angled attachments, the tool is locked in the attachment collet.
- There is a rotatable dial on the MR8 variable exposure attachment, not included on the fixed attachment.
- Dissecting tool size and geometry may contribute to excessive vibration at certain speeds. Increase or decrease speed by adjusting the foot or finger control, or by changing the console speed setting. If necessary, use a different dissecting tool.
- Do not use the variable exposure attachment if the tube adjustment dial spins freely or fails to click into place with each adjustment, as the exposure may change without warning.
- Do not use the end of the tube as a depth gauge or depth stop.
- Make sure that the tool and attachment are still locked after making any adjustments to the tool exposure on variable exposure attachments. If the attachment is unlocked, the system will not function. If the tool is unlocked, it can cause reduced speed and overheating.

Assembly:

1. Assemble the variable exposure straight attachment using the **Straight attachments Assembly** instructions and the variable exposure angled attachments using the **Angled attachments Assembly** instructions.
2. After assembly, use the tube adjustment ring to adjust the exposure of the dissecting tool (Figure 19-1). With the tool pointing away from you, turn the ring to the right to increase the length of the tube, thereby decreasing the exposure of the tool. Turn the ring to the left to decrease the length of the tube, thereby increasing the exposure of the tool.

Disassembly:

Remove the variable exposure straight attachment using the **Straight attachments Disassembly** instructions and the variable exposure angled attachments using the **Angled attachments Disassembly** instructions.



Angled double lock (DK) attachments

Notes:

- Angled attachments with the same length, marking, and color band share the same dissecting tools.
- You can insert and lock a tool in the attachment before the angled attachment is installed on the motor.

Assembly:

1. Assemble the attachment onto the motor using the **Angled attachments Assembly** instructions.
2. Insert the tool into the attachment with a slight rotational motion. An audible click, perceptible by touch, confirms that the tool is fully seated (Figure 20-1).
3. Rotate the tool lock in direction indicated by arrow until the tool lock alignment mark is directly in line with the locked symbol (Figure 20-2).
Note: Pull on the tool to ensure that it is secured in the attachment.
4. The tool should rotate freely. If not, unlock the attachment, re-seat the tool, and re-lock the attachment.
5. Verify that both the attachment to motor and the tool-lock alignment mark is directly in line with the corresponding locked symbol.

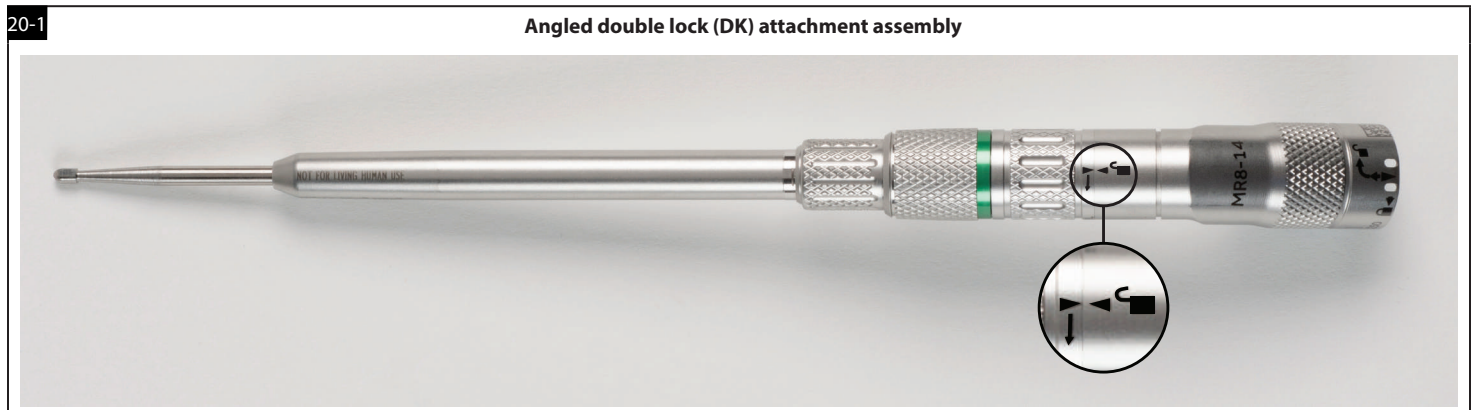

The Midas Rex MR8 electric high-speed drill system

20-2

Angled double lock (DK) attachment assembly

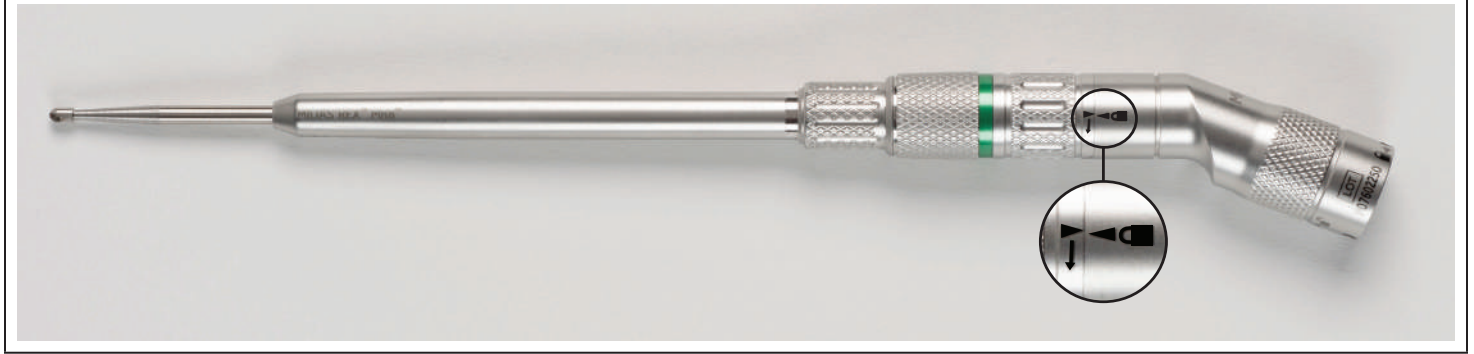

Disassembly:

1. To remove the attachment, hold the motor in the palm of your hand, and push the attachment distally while turning the attachment to the unlocked position (Figure 20-3).
2. Release and remove the attachment.

20-3

Angled double lock (DK) attachment disassembly

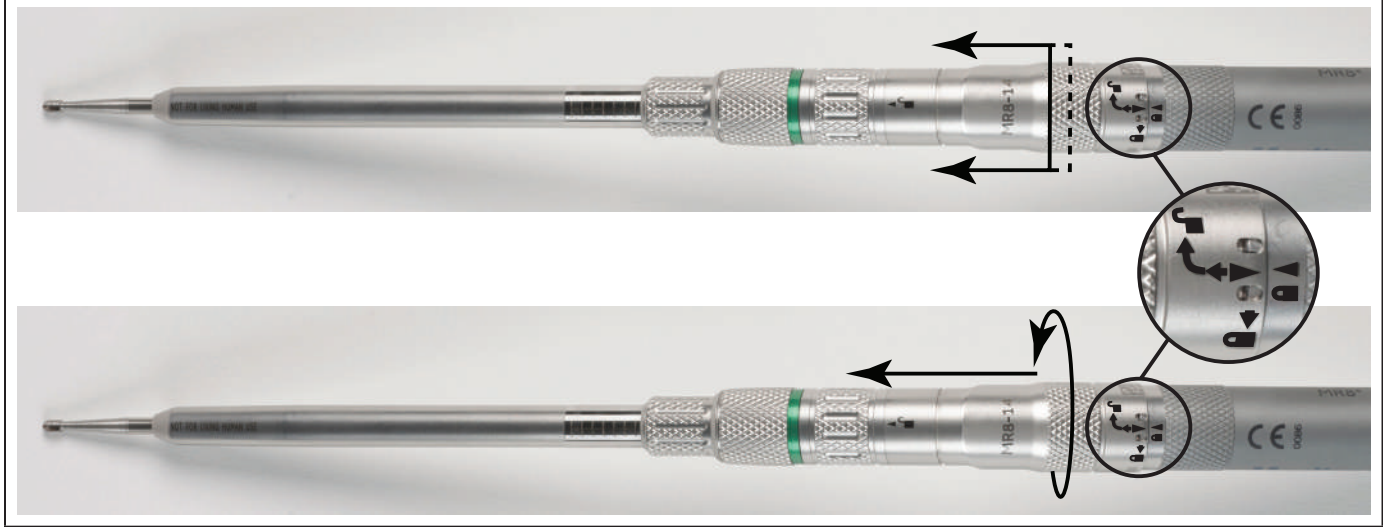

Fixed footed attachments

Warning: Use only dissecting tools specifically designed for use with this drill system. Match the nomenclature and color code on the MR8 dissecting tool packaging to the same nomenclature and color band on the MR8 attachment.

Notes:

- Ensure proper installation of tool in footed attachment. Failure to follow instructions may result in the tool tip contacting the foot of the attachment causing damage to the attachment and/or harm to patient.
- To avoid injury from the dissecting tool, use thumb and index finger to cautiously and slowly lift the attachment off of the motor and away from the dissecting tool.

Assembly

1. Insert a dissecting tool into the motor collet with a slight rotational motion (Figure 21-1). An audible click, heard and perceptible by touch, confirms that the tool is fully seated.
2. Slide the fixed footed attachment over the dissecting tool onto the motor aligning triangular arrows on the attachment and the motor case (Figure 21-2).
3. Pull the fixed footed attachment towards the motor and rotate the attachment to the locked position on the motor case (Figure 21-3).
4. Check to ensure a gap exists between the tip of the tool and the foot of the attachment as shown in Figure 21-4. This will prevent damage to the attachment and/or injury to patient.

21-1

Fixed footed attachment assembly

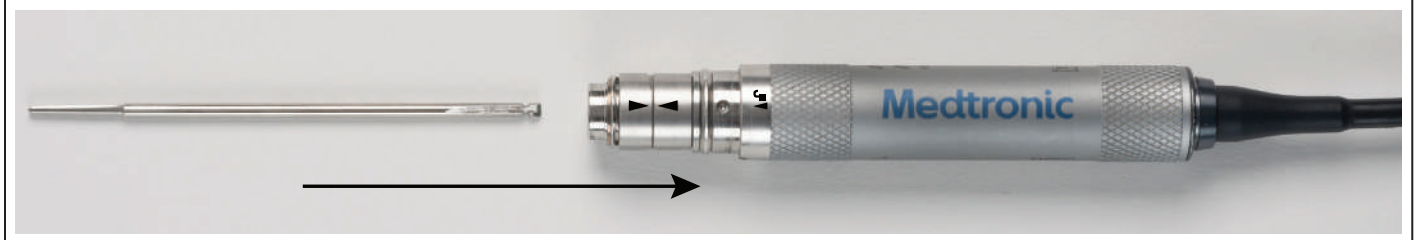

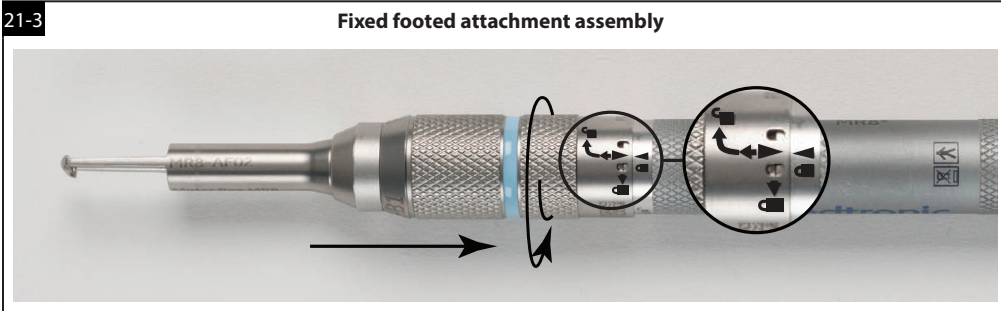
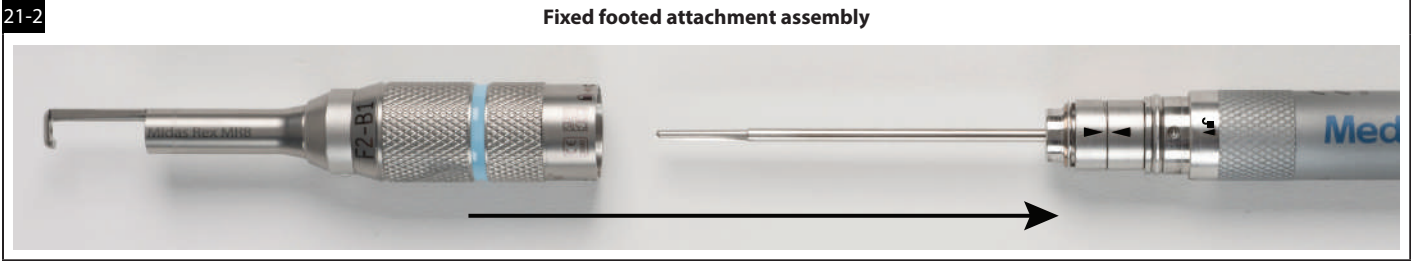

Disassembly

1. To remove the fixed footed attachment, hold the motor in the palm of your hand. Push the fixed footed attachment distally while rotating the attachment to the unlocked position on the motor case and then release the sleeve (Figure 21-5).
2. To avoid injury from the dissecting tool, use thumb and index finger to cautiously and slowly lift the attachment off of the motor and away from the dissecting tool (Figure 21-6).
3. Pull the dissecting tool out of the motor collet and discard the tool (Figure 21-7).

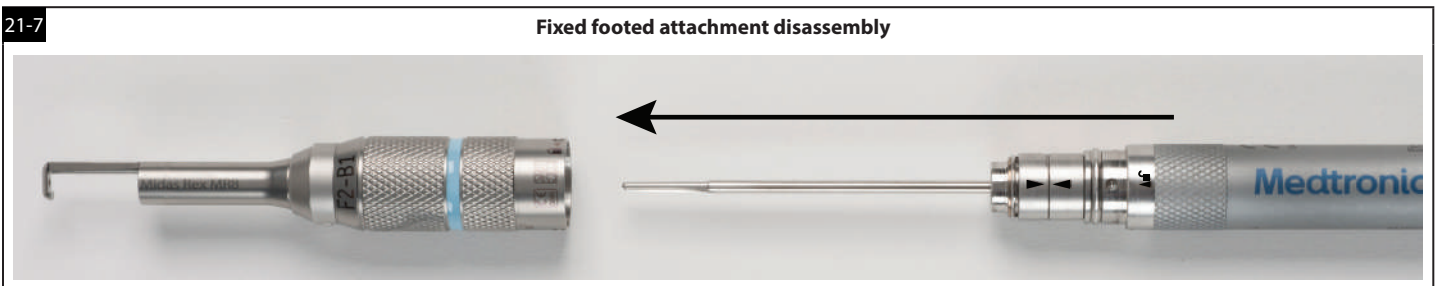
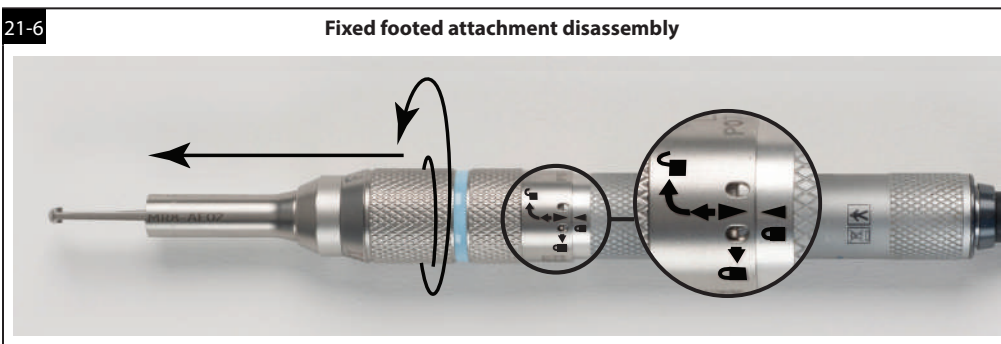
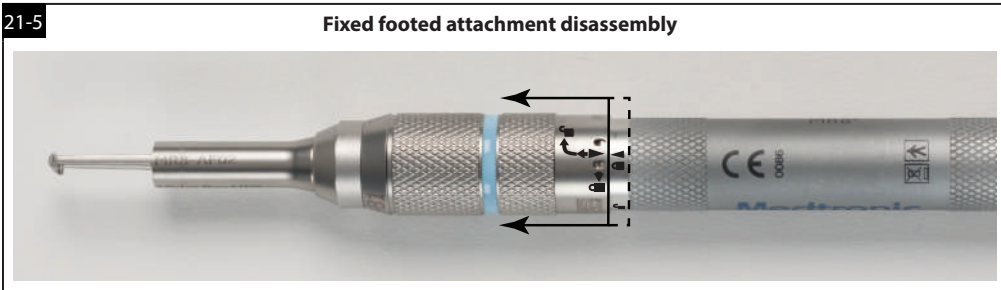

The Midas Rex MR8 electric high-speed drill system

Rotating footed attachments

Notes:

- Rotating and fixed footed attachments with the same length, marking and color band share the same dissecting tools.
- The footed end of the attachment has 360° of unrestricted rotation.
- Ensure proper installation of tool in footed attachment. Failure to follow instructions may result in the tool tip contacting the foot of the attachment causing damage to the attachment and/or harm to patient.
- To avoid injury from the dissecting tool, use thumb and index finger to cautiously and slowly lift the attachment off of the motor and away from the dissecting tool.

Assembly:

1. Insert a dissecting tool into the motor collet with a slight rotational motion (Figure 22-1). An audible click, heard and perceptible by touch, confirms that the tool is fully seated.
2. Slide the rotating footed attachment over the dissecting tool onto the motor aligning triangular arrows on the attachment and the motor case (Figure 22-2).
3. Pull the rotating footed attachment towards the motor and rotate the attachment to the locked position on the motor case (Figure 22-3).
4. Check to ensure a gap exists between the tip of the tool and the foot of the attachment as shown in Figure 22-4. This will prevent damage to the attachment and/or injury to patient.

Disassembly:

1. Hold the motor in palm of hand. Rotate the attachment to the unlocked position. In this position, the arrows in the attachment and motor will line up.
2. Use thumb and index finger to lift the attachment off of the motor.
3. Remove the dissecting tool from the motor collet and discard the tool.

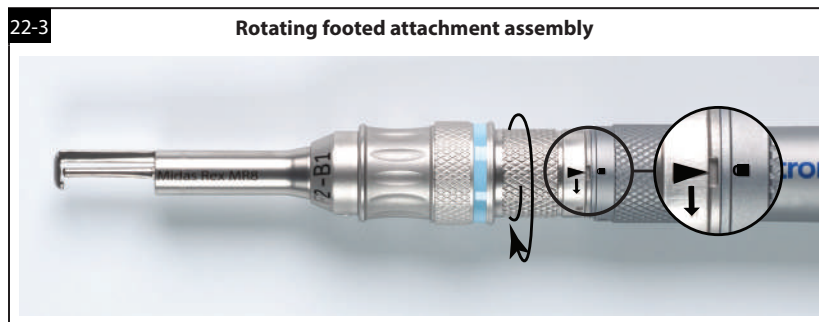
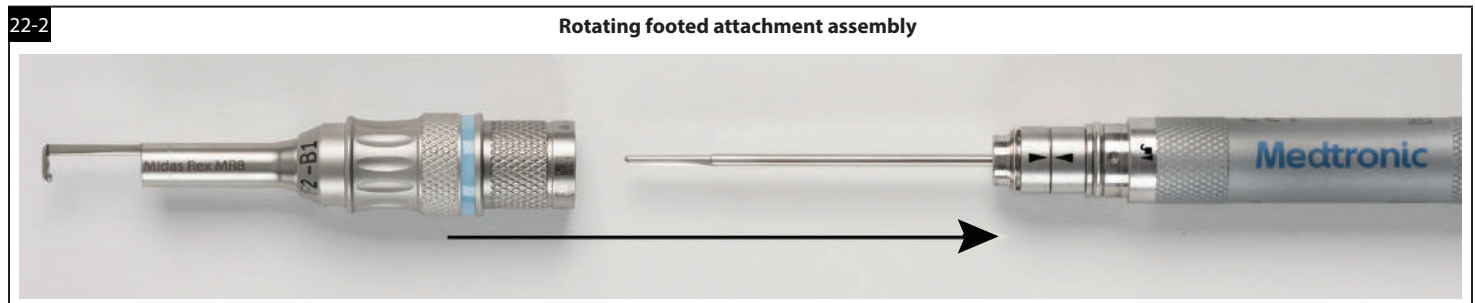
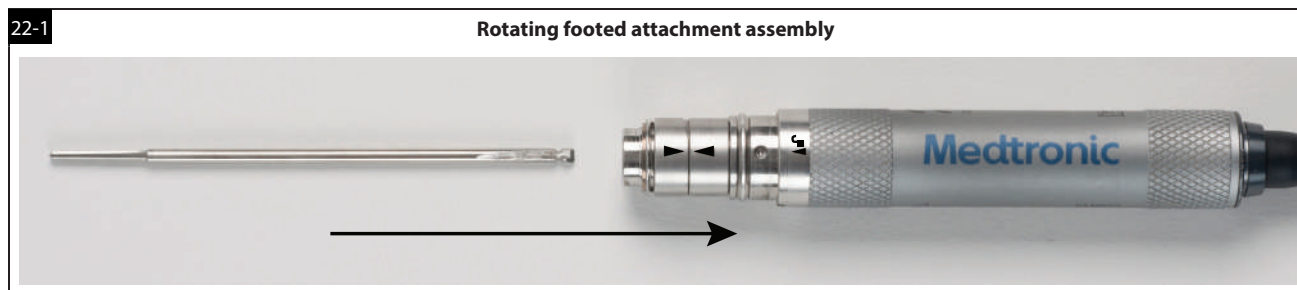

Metal cutting attachments

Warnings:

- Do not use metal cutting dissecting tools on bone.
- For metal transection, observe the following safety guidelines:
 - a. Wear eye protection.
 - b. Irrigate well to cool the cutting surfaces.
 - c. Protect the wound site from metal debris.
 - d. Use a clamp or grasping device to control loose fragments during transection of any metal component.
- Use only dissecting tools specifically designed for use with this drill system. Match the nomenclature and color code on the MR8 dissecting tool packaging to the same nomenclature and color band on the MR8 attachment.

Notes:

- The metal cutting attachments use the tungsten carbide or diamond wheel dissecting tools.
- A dissecting tool may be installed and locked in the attachment before the metal cutting attachment is installed on the motor.
- The Legend system metal cutter dissecting tool can be used with the MR8-ASMC9 attachment. Match the color code on the metal cutter Legend dissecting tool packaging to the same color band on the MR8 attachment.

All metal cutting dissecting tools have an "MC" attachment prefix in their nomenclature (for example MR8-9MC30). Metal cutting dissecting tools should not be installed into other attachments.

The MR8 metal cutting attachments come in a double locking (DK) configuration.

Assembly:

1. Slide the metal cutting attachment over the motor collet aligning triangular marks on the attachment and the motor case. An audible click, heard and perceptible by touch, confirms that the attachment is fully seated.
2. Rotate the attachment to the locked position on the motor case.
3. To insert the tool, make sure that the tool locking ring is in the unlocked position, and insert the dissecting tool into the top of the tube (Figure 23).
4. Rotate the dissecting tool until it drops into position and is fully seated (Figure 23).
5. Rotate the tool locking ring to the locked position. Gently pull on the shaft of the dissecting tool to verify proper installation.

Disassembly:

1. Rotate the tool locking ring to the unlocked position. Pull the dissecting tool from the attachment.
2. Discard the tool.
3. Push the attachment distally, then rotate the attachment to the unlocked position on the motor case and lift the attachment off the motor.



The Midas Rex MR8 electric high-speed drill system

Telescoping attachments and tubes

Telescoping attachments provide support to the rotating dissecting tool. Telescoping tubes are disposable following multiple uses and should be discarded when heat or excessive vibration is noticed or insertion of tools becomes difficult. Telescoping attachment MR8-AT10ADK is provided in a double locking (DK) configuration. The straight telescoping attachment (MR8-AT10) is available in both a DK and non-DK configuration.

Warnings: Use only dissecting tools specifically designed for use with this drill system. Match the nomenclature and color code on the MR8 dissecting tool packaging to the same nomenclature and color band on the MR8 attachment.

Notes:

- To assemble DK attachments, follow the instructions for the respective attachment. To disassemble DK attachments, push the attachment distally before rotating.
- The Legend system 12 cm, 14 cm, 15 cm, and 18 cm telescoping tubes and dissecting tools can be used with the MR8 system. Match the color code on the telescoping Legend dissecting tool packaging to the same color band on the MR8 telescoping tube.

Assembly

1. Slide the attachment over the motor collet aligning the triangular markers. A tactile click confirms the attachment is fully seated.
Note: A dissecting tool and telescoping tube may be installed and locked in the attachment before the telescoping attachment is installed on the motor.
2. Rotate the attachment to the locked position.
3. Rotate the tube locking ring toward the unlocked icon (Figure 24-1).
4. Insert the base of the telescoping tube into the attachment (Figure 24-2).
5. To lock the tube in place, rotate the tube locking ring towards the locked icon. Verify that the tube is secure by gently pulling on the tube. Do not over tighten the tube locking ring.
6. To insert the tool, make sure that the tool locking ring is in the unlocked position, and insert the dissecting tool into the top of the tube (Figure 24-3). A tactile click confirms that the tool is fully seated.
7. Rotate the tool locking ring to the locked position. Gently pull on the shaft of the dissecting tool to verify proper installation (Figure 24-4).
8. If the tube position needs to be changed, rotate the tube locking ring toward the unlocked icon and reposition the tube. Then, rotate the tube locking ring toward the locked icon.

Disassembly

1. To remove the attachment, rotate the tool locking ring and the tube locking ring to the unlocked position, and pull the telescoping tube and tool out of the attachment.
2. Rotate the attachment to the unlocked position and lift the attachment off the motor.
Note: Telescoping tubes should be discarded when heat or excessive vibration is noticed, or when insertion of the tool becomes difficult.

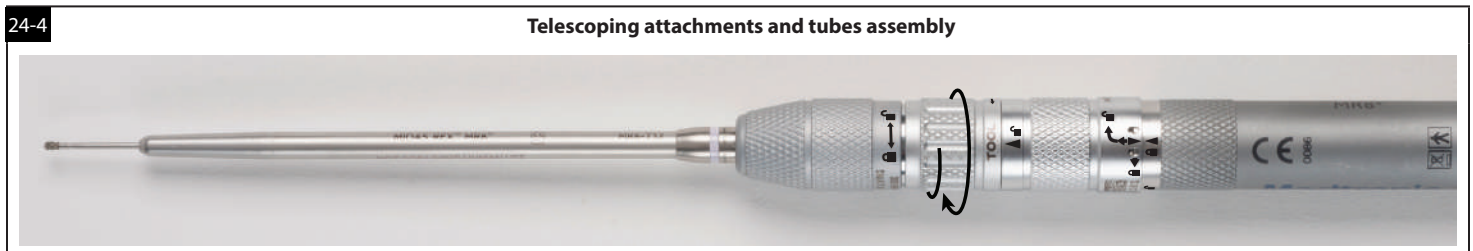
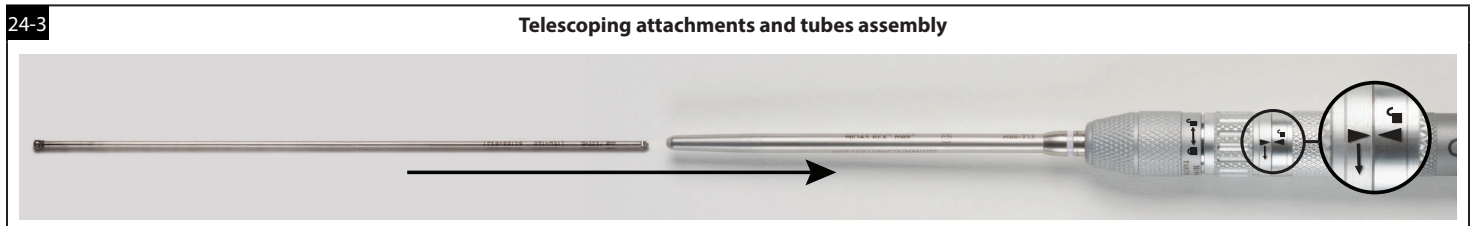
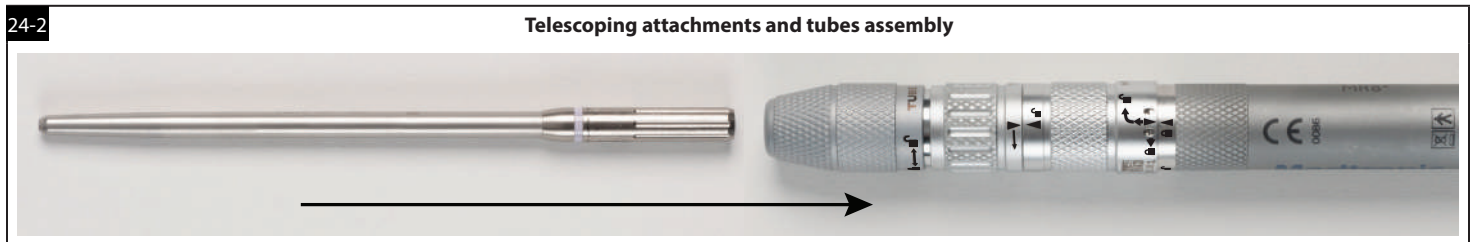
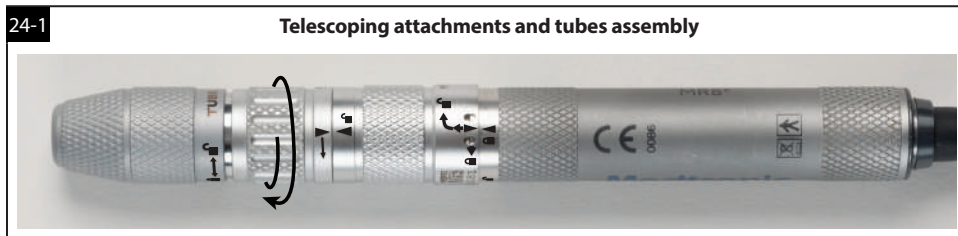

Perforator driver attachments

The perforator attachment has a Hudson chuck to drive any device with a Hudson shank (for example: the cranial perforator device).

Warning: Consult the cranial perforator device labeling for the recommended speed specifications.

Note: A cranial perforator device may be installed in the attachment before the attachment is installed on the motor.

Assembly

1. Slide the perforator driver over the motor collet, aligning the triangular markers (Figure 25-1). A tactile click confirms the attachment is fully seated.
2. Rotate the attachment to the locked position (Figure 25-2).
3. To install a cranial perforator device with a Hudson shank, pull back on the collar of the attachment (Figure 25-3).
4. Insert the device into the attachment with a slight rotational motion and release the collar.
5. The speeds achievable by the MR8-AD03 attachments are provided in Table 4.

Disassembly

1. Pull back proximally on the collar of the perforator attachment and then remove the cranial perforator device.
2. Rotate the perforator attachment to the unlocked position and lift the attachment off of the motor.

Console setting	MR8-AD03
60000 rpm	830 rpm
70000 rpm	965 rpm
72000 rpm	995 rpm
74000 rpm	1020 rpm
75000 rpm	1035 rpm

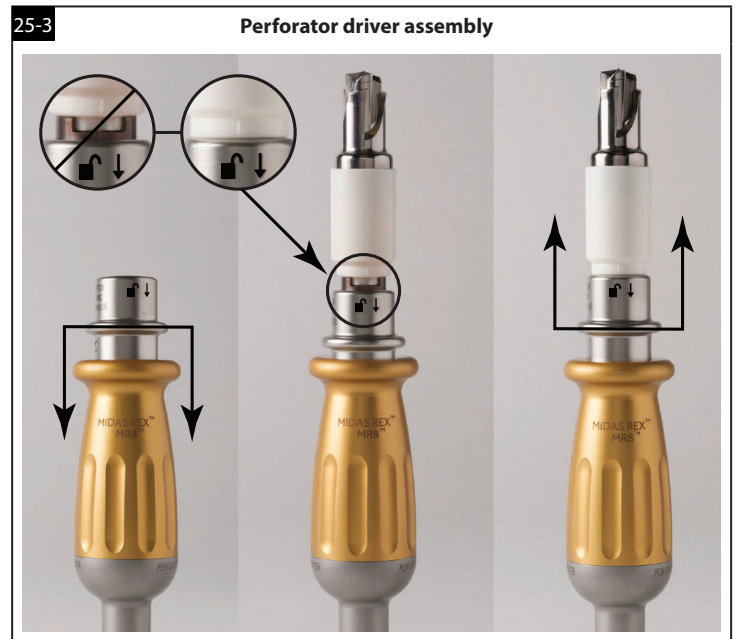

The Midas Rex MR8 electric high-speed drill system

Jacobs chuck attachments

The Jacobs chuck attachment is a non-cannulated, 5/32" chuck with key for drilling.

Note: A drill bit may be installed in the attachment before the Jacobs chuck attachment is installed on the motor.

Assembly

1. Slide the attachment over the motor collet aligning the triangular markers (Figure 26-1). A tactile click confirms that the attachment is fully seated.
2. Rotate the attachment to the locked position (Figure 26-2).
3. To install a drill bit, rotate the Jacobs chuck key counterclockwise to open the jaw as shown in Figure 26-3.
4. Insert the drill bit and rotate the Jacobs key clockwise to tighten the jaws until the drill bit is secure.

Disassembly

To open the jaws, turn the Jacobs chuck key counterclockwise. Remove and discard the drill bit. Rotate the Jacobs chuck attachment to the unlocked position and lift the attachment off of the motor.

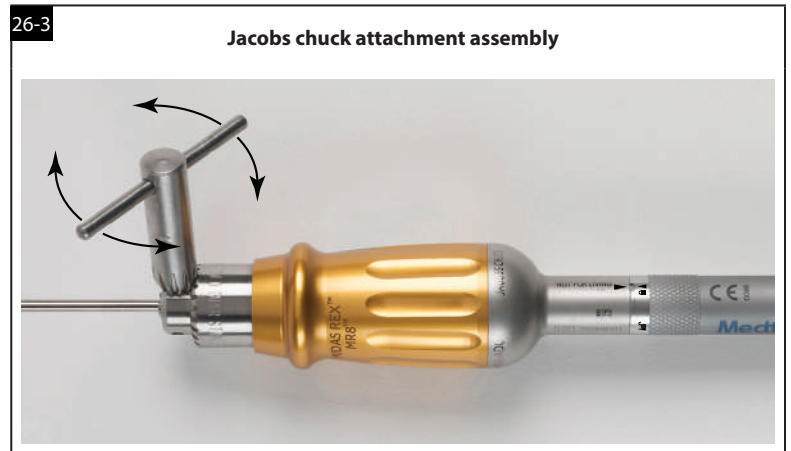

J-latch attachments

This attachment is designed for use with industry standard J-latch dissecting tools. Refer to the dissecting tool's labeling for information on specific operating requirements and limitations.

Assembly:

1. Assemble and secure the attachment onto the motor using the **Straight attachments Assembly** instructions (Figure 27-1).
2. Insert the tool into the attachment with a slight rotational motion. An audible click, perceptible by touch, confirms that the tool is fully seated (Figure 27-2).
3. Turn the tool lock sleeve in the direction shown on the attachment to lock the tool (Figure 27-3). Gently pull on the tool to ensure that it is locked into the motor.

Disassembly:

1. Turn the tool lock sleeve in the direction shown on the attachment to unlock the tool.
2. Remove the dissecting tool from the attachment and discard it.
3. Rotate the attachment on motor to the unlocked position.
4. Lift the attachment off of the motor.

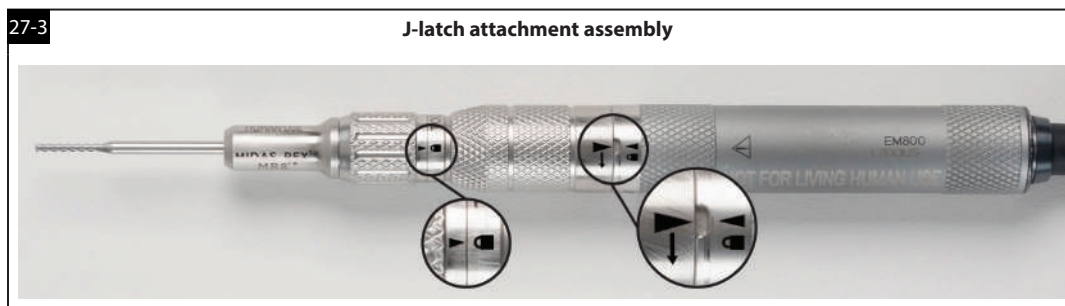
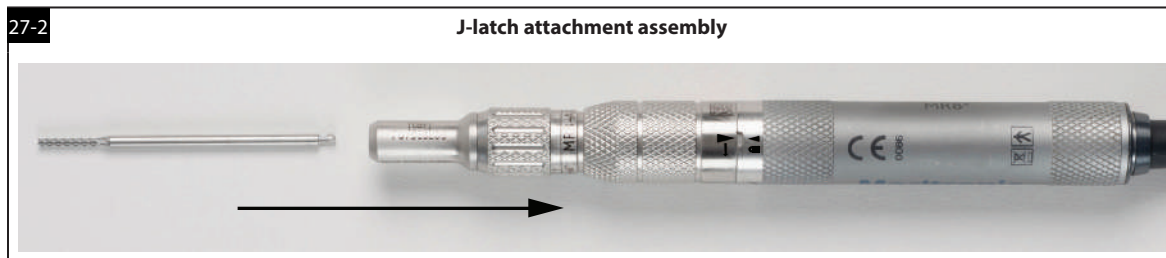
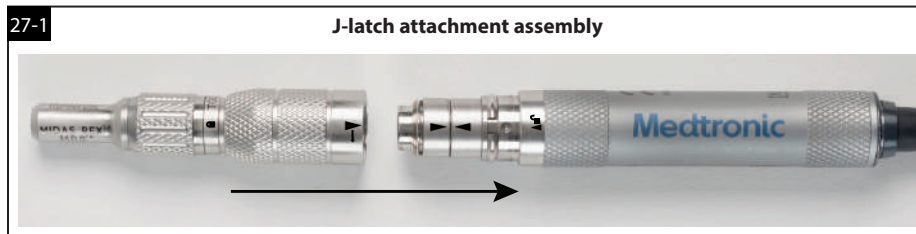

Irrigation tubing set

Refer to the IPC manual for instructions to attach the tubing set to the IPC.

Note: Clip may not fasten to small bore attachment after having been used on large bore attachment.

Assembly:

1. Adjust the location of plastic clip on the stainless-steel irrigation tube (Figure 28).
2. Bend the irrigation tube to the desired angle.
3. Snap the clip onto the distal end of attachment (near the tool).

Disassembly:

1. Remove irrigation tubing set from attachment by pulling on the clip to detach it.
2. Similarly detach all clips.
3. Discard the irrigation tubing set per local regulations.



The Midas Rex MR8 electric high-speed drill system

System accessories: disposable components

Cleaning brushes

Clean debris from lumen of attachments and telescoping tubes with the appropriate cleaning brushes.

The disposable cleaning brushes are sized for MR8 attachments and telescoping tubes, but they will not pass through the angled, metal cutting, perforator, or Jacobs chuck attachments, because they are not cannulated.

Table 5: Disposable cleaning brush dimensions

Internal bore diameter	Brush length
1.2 mm	20 cm (8 in)
2.4 mm	41 cm (16 in)
3.2 mm	41 cm (16 in)

System accessories: non-disposable components

Instrument trays

The instrument tray holds MR8 attachments, MR8 motors, and/or other MR8 system equipment to be sterilized and is placed inside a rigid sterilization container or wrapped for steam sterilization. This tray is available in a 1/2 DIN CA800 (Figures 29-1 - 29-2) and a 3/4 DIN CA850 (Figures 30-1 - 30-2) size.

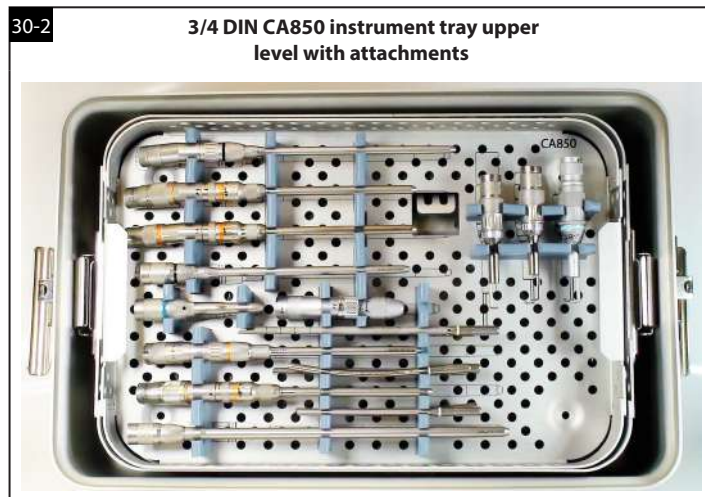
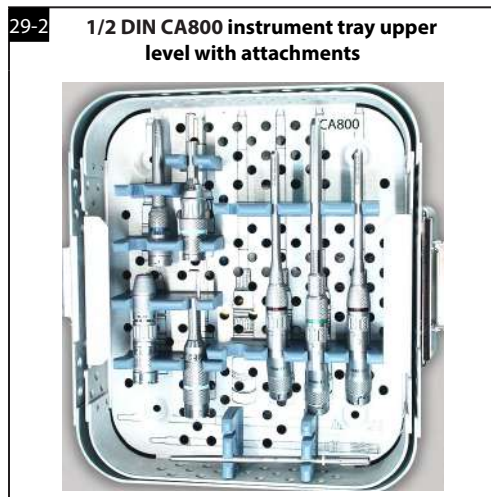
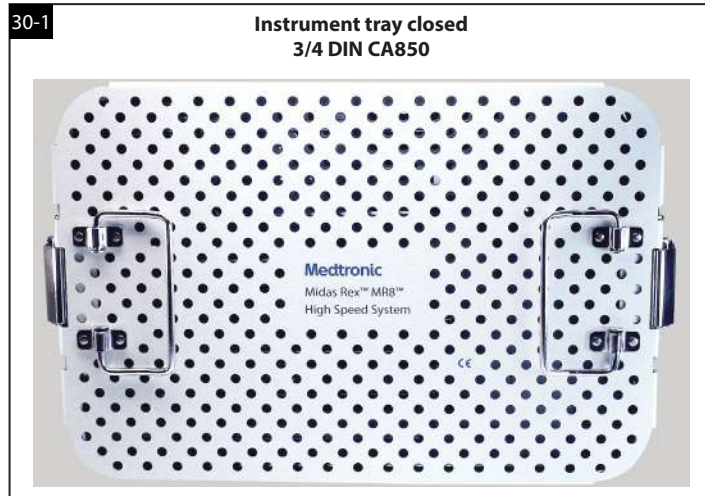

Rigid sterilization containers (sterilization cases)

The rigid sterilization containers are sterilization containment devices designed to hold the MR8 system equipment for sterilization, storage, transportation, and aseptic presentation of its contents. These containers are available in 1/2 DIN (Figure 31-1) and 3/4 DIN (Figure 31-2) sizes.

The system consists of a base with carrying handles and lid that is secured to the base by means of a latching mechanism. The instrument tray holds MR8 attachments, MR8 motors, and/or other MR8 system equipment to be sterilized and is placed inside the rigid sterilization container. A filter system is incorporated in the sterilization container to provide for air evacuation and sterilant penetration during the sterilization cycle and to act as a barrier to microorganisms during storage, handling, and transport.



MR8 system reprocessing instructions

Cleaning is the removal of organic soil. Effective cleaning:

- Minimizes the organic soil transfer from one patient to another.
- Prevents accumulation of residual soil throughout the device's useful life.
- Allows for successful follow-up sterilization. Adequate reprocessing is contingent upon the thoroughness of cleaning.

Cleaning is the initial step. Sterilization occurs later in reprocessing and is intended to kill microorganisms to reduce the likelihood of transmission and possibilities of infection. To ensure acceptable reprocessing, there should be no delay between the cleaning, inspection, and sterilization.

Blood-borne pathogens - Universal precautions for handling this device after use should be observed by all hospital personnel according to OSHA standard 29 CFR 1910.1030, occupational exposure to blood-borne pathogens.

Warnings and cautions	<ul style="list-style-type: none"> • Do not soak/submerge devices. • Do not use ultrasonic cleaners to clean devices. • Do not use chlorine-based or corrosive cleaning agents such as bleach, lye, acetone, sodium hypochlorite/bleach, sodium hydroxide, formic acid, or solutions containing glutaraldehyde. • Allow an adequate cooling period after steam sterilization.
Limitations on reprocessing	<p>Note: Attachments and telescoping tubes may be disposed of at the end of their useful life according to local and national regulations. Due to safety and environmental concerns, Medtronic requests the return of electric high speed motors for proper disposal at the end of the product useful life.</p> <p>End of useful life is normally determined by wear and damage due to use.</p> <p>See the "Maintenance, inspection, and testing" section in this document to determine if the device is at its end of useful life.</p>
Point of use	<p>Reprocessing begins at the point of use.</p> <p>Do not allow blood, debris, or bodily fluids to dry on the device. Remove excess soil using cold running tap water 10 - 22°C (50 - 72°F). Tap water is defined as potable water with hardness value between 0.7 mmol/l to 2.0 mmol/l.</p>
Containment and transportation	<p>Caution: Devices should be cleaned within 30 minutes of use to limit fixation of contaminants.</p> <p>Do not place soiled instruments into the instrument case. Transport used devices in a separate container.</p> <p>If the device cannot be reprocessed immediately, keep the device moist during transport.</p> <p>It is recommended that devices are reprocessed as soon as is practical following use.</p> <p>To prolong the life of the device, reprocess immediately after use.</p>

The Midas Rex MR8 electric high-speed drill system

<p>Preparation for cleaning: automated</p>	<p>MR8 electric, MR8 electric plus, and MR8 electric touch motors:</p> <ul style="list-style-type: none"> • Ensure that the attachment, tube, and dissecting tool have been removed from the motor prior to cleaning. • If cleaning the MR8 electric touch motor, remove the finger control lever from the MR8 electric touch motor, if attached. • With collet and cable connector ends pointed down, manually rinse the motor and cable under cold running tap water (10 - 22°C / 50 - 72°F) to remove any visible soil. • Use a nylon brush to aid in cleaning. • Give particular attention to crevices and other areas that present a challenge to cleaning. • For finger control lever, actuate all moving parts (telescoping finger rest and motor safe mode switch) through their full range of motion while thoroughly rinsing under cold running water. • Orient devices following recommendations of the washer/disinfector manufacturer. • For finger control lever, place in the washer with the telescoping finger rest in the fully extended position. • Clean per recommended washer cycle per Table 6 or Table 7. • After cleaning, visually examine all parts of the device for cleanliness. If visible soil remains, repeat cleaning. <p>MR8 attachments and tubes:</p> <ul style="list-style-type: none"> • Ensure that the attachment, tube, and dissecting tool have been removed from the motor prior to cleaning. • Manually rinse attachments/tubes under cold running tap water (10 - 22°C / 50 - 72°F) to remove any visible soil. • Use a nylon brush to aid in cleaning • Give particular attention to crevices and other areas that present a challenge to cleaning. • Attachments with moving parts should be actuated through their full range of motion under cold running tap water. • While rinsing under cold running tap water, use an appropriately sized (refer to Table 5) nylon lumen brush internally to aid in cleaning attachments. • Variable exposure attachments (AVAXX, AVAXXDK, AVSXX) must be placed in the washer with their tube in the fully extended position. • Orient devices following recommendations of the washer/disinfector manufacturer. • Clean per recommended washer cycle per Table 6 or Table 7. • After cleaning, visually examine all parts of the device for cleanliness. If visible soil remains, repeat cleaning. <p>Instrument tray:</p> <ul style="list-style-type: none"> • To clean the instrument tray after use, thoroughly rinse the instrument tray under cold running tap water to remove any visible soil. • Use a soft-bristled brush or clean cloth to aid soil removal around brackets and handles. • Give particular attention to crevices and other areas that present a challenge to cleaning. • Carefully inspect trays, handles, instrument brackets, and cavities to ensure all visible soil is removed. • Clean per recommended washer cycle per Table 6 or Table 7. • After cleaning per the recommended washer cycle below, visually examine the instrument tray for cleanliness. If visible soil remains, repeat cleaning. <p>Rigid sterilization container:</p> <ul style="list-style-type: none"> • To clean the sterilization container after use, discard the single use filters and thoroughly rinse the sterilization container under cold running tap water to remove any visible soil. • Use a soft-bristled brush or clean cloth to aid soil removal around brackets, filter retention plates, and handles. • Gently flush the gasket region of the sterilization container if soil is visible. • Give particular attention to crevices and other areas that present a challenge to cleaning. • Carefully inspect containers, handles, gaskets, filter retention plates, instrument brackets, and cavities to ensure all visible soil is removed. • Remove the filter retention plates from the lid and base by turning the lever on the retention plate clockwise. Do not remove the gasket for the cleaning procedure. • Clean per recommended washer cycle per Table 6 or Table 7. • After cleaning per the recommended washer cycle below, visually examine the sterilization container for cleanliness. If visible soil remains, repeat cleaning.
---	--

Cleaning: automated

Warnings:

- Use the instrument tray and the rigid sterilization container for sterilizing the re-usable devices only.
- Do not use the instrument tray and sterilization container for cleaning or disinfection of the re-usable devices.
- Do not use alkaline cleaning for the instrument tray or the rigid sterilization container.

Cautions:

- Do not use ultrasonic cleaner.

Table 6: Neutral Wash Cycle Parameters

MR8 motors, attachments and tubes, and instrument tray - neutral

Phase	Recirculation/soak (minutes)	Water temperature	Detergent type
Pre-wash	2 minutes (02:00)	Cold tap water 10 - 16°C (50 - 61°F)	Not applicable
Enzyme wash	2 minutes (02:00)	Hot tap water 43 - 55°C (109 - 131°F)	Neutral pH enzymatic cleaner like Steris Prolystica® 2x concentrate enzymatic cleaner, 1.0mL/L (1/8 oz/gallon)
Wash 1	2 minutes (02:00)	66°C (151°F) (setpoint)	Neutral pH detergent like Steris Prolystica 2x concentrate neutral detergent, 1.0mL/L (1/8 oz/ gallon)
Rinse 1	15 seconds (00:15)	43 - 60°C (109 - 140°F)	Not applicable
Thermal rinse	1 minute (01:00)	90°C (194°F) (setpoint)	Not applicable
Purified water rinse	10 seconds (00:10)	66°C (151°F) (setpoint)	Not applicable

If visible soil remains, repeat cleaning.

Table 7: Alkaline Wash Cycle Parameters

MR8 motors, attachments and tubes – alkaline detergent (working solution pH ≤ 10.5)*

Note: Do not use alkaline cleaning for the instrument tray or the rigid sterilization container.

Phase	Recirculation/soak (minutes)	Water temperature	Detergent type
Pre-wash	2 minutes (02:00)	Cold tap water 10 - 16°C (50 - 61°F)	Not applicable
Wash	5 minutes (05:00)	43°C (109°F) (set point)	Alkaline detergent like Dr. Weigert neodisher® MediClean forte, 2mL/L (1/4oz/gal)
Rinse	1 minute (01:00)	Hot tap water 43 - 60°C (109 - 140°F)	Not applicable
Thermal rinse	1 minute (01:00)	90°C (194°F) (setpoint)	Not applicable
Purified water rinse	1 minute, 30 seconds (01:30)	66°C (151°F) (setpoint)	Not applicable

If visible soil remains, repeat cleaning.

*Alkaline detergent manufacturers provide alkaline detergents concentrated. The alkaline detergents must be diluted per the detergent manufacturer's instructions for cleaning medical devices. Medtronic has verified alkaline detergent compatibility for working solutions up to 10.5 pH.

After cleaning, lubricate attachments using an aerosol spray lubricant (such as Pana Spray) and perform the following steps to lubricate attachments:

1. Holding the can approximately 10-15 cm (3-6 in.) away from the attachment, spray all movable components with three quick squirts.
2. Actuate movable components to ensure proper lubrication.
3. Remove excess lubricant with a clean cloth.

The Midas Rex MR8 electric high-speed drill system

<p>Cleaning: manual</p>	<p>MR8 electric, MR8 electric plus, and MR8 electric touch motors:</p> <ul style="list-style-type: none"> • Ensure that the attachment, tube, and dissecting tool have been removed from the motor prior to cleaning. • If cleaning the MR8 electric touch motor, remove the finger lever from the MR8 electric touch motor, if attached. Set aside for cleaning and follow the motor finger control lever instructions listed below. • With the collet end and cable connector ends pointed down, thoroughly rinse the motor and cable under cold running tap water (10 - 22°C / 50 - 72°F) to remove any visible soil. • Use a nylon brush to aid in cleaning. • Give particular attention to crevices and other areas that present a challenge to cleaning. • Prepare with tap water a neutral enzymatic cleaner, like Steris Prolystica 2x concentrate enzymatic cleaner, following the manufacturer's recommendations of 1.0 mL/L (1/8 oz/gallon) at a temperature of 23°C (73°F) or use an equivalent neutral pH cleaner following that manufacturer's recommendations. • Wipe all external surfaces of the motor, cable, and cable connector with a cloth dampened with the prepared cleaner. • Brush motor case, collet, and cable connector with a nylon brush dampened with the prepared cleaner. • Rinse the device thoroughly under warm running tap water (23 - 43°C / 73 - 109°F), collet end and cable connector pointed down. • Following the warm tap water rinse, the device should be thoroughly rinsed in room temperature 25°C (77°F) purified water (deionized, reverse osmosis, or equivalent) for a minimum of 30 seconds with collet end and cable connector pointed down. • Dry the entire device with lint-free towel. • Verify that devices are visually clean after manual cleaning. If visible soil remains, repeat cleaning. <p>MR8 electric touch motor finger control lever:</p> <ul style="list-style-type: none"> • Ensure that the attachment, tube, and dissecting tool have been removed from the motor prior to cleaning. • Prepare with tap water a neutral enzymatic cleaner, like Steris Prolystica 2x concentrate enzymatic cleaner, following the manufacturer's recommendations of 1.0mL/L (1/8 oz/gallon) at a temperature of 23°C (73°F) or use an equivalent neutral pH cleaner following that manufacturer's recommendations. • Brush all parts of the lever with a nylon brush dampened with the prepared cleaner. • Actuate all moving parts (telescoping finger rest and motor safe mode switch) while rinsing under warm running tap water (23 - 43°C / 73 - 109°F). • Rinse thoroughly under warm running tap water. • Following the warm tap water rinse, the device should be thoroughly rinsed in room temperature (25°C / 77°F) purified water (deionized, reverse osmosis, or equivalent) for a minimum of 30 seconds with telescoping finger rest fully extended. • Dry with a lint free towel. • Verify that the device is visually clean after manual cleaning. If visible soil remains, repeat cleaning. <p>MR8 attachments and tubes:</p> <ul style="list-style-type: none"> • Ensure that the attachment, tube, and dissecting tool have been removed from the motor prior to cleaning. • Thoroughly rinse the attachments/tubes under cold running tap water (10 - 22°C / 50 - 72°F) to remove any visible soil. • Use a nylon brush to aid in cleaning. • Give particular attention to crevices and other areas that present a challenge to cleaning. • Actuate all moving parts through their full range of motion while rinsing under cold running tap water. • Prepare with tap water a neutral enzymatic cleaner, like Steris Prolystica 2x concentrate enzymatic cleaner, following the manufacturer's recommendations of 1.0 mL/L (1/8 oz/gallon) at a temperature of 23°C (73°F) or use an equivalent neutral pH cleaner following that manufacturer's recommendations. • Wipe all attachments and telescoping tubes with a cloth dampened with the prepared cleaner. • Use a nylon brush dampened with the prepared cleaner to clean the external surfaces and internal connecting surfaces of the attachment/tube base. <p>Note: While cleaning angled and curved telescoping tubes, it may be necessary to push the brush through both ends.</p> <ul style="list-style-type: none"> • Straight attachments, footed attachments, and telescoping straight tubes have special cleaning brushes sized to the attachment's or telescoping tube's internal diameter (refer to Table 5). Push the brush wet with the prepared cleaner through the attachment or telescoping tube from rear to front to loosen and remove debris trapped inside. • Other attachments and tubes may be mechanically agitated in the prepared cleaner solution but not soaked. • For angled type attachments, perforator driver attachment, or Jacobs chuck attachment, only place one half (e.g. tube/tool side) of the attachment into the cleaner at a time. Do not immerse the entire attachment. Gently agitate the attachment in the cleaner and actuate any moveable parts. Then place the other half (e.g. base side) of the attachment into the cleaner and repeat (Figures 32-1 – 32-3). • Ensure that the tube lumen on the angled attachment, curved and angled telescoping tube, metal cutter attachment, or J-latch attachment is cleaned with the appropriate sized brush (refer to Table 5). • Actuate any moveable parts through their full range of motion to allow cleaner to thoroughly clean attachment (for example, the dial on variable exposure attachment and the sleeve on perforator attachment). • Under warm running tap water (23 - 43°C / 73 - 109°F), actuate any moveable parts through their full range of motion to allow water to thoroughly rinse the attachment. • Rinse the attachment thoroughly with warm running tap water. Flush both ends to remove cleaner. • Following the warm tap water rinse, the device should be thoroughly rinsed in room temperature 25°C (77°F) purified water (deionized, reverse osmosis, or equivalent) for a minimum of 30 seconds. • Verify that devices are visually clean after manual cleaning. If visible soil remains, repeat cleaning. • Thoroughly dry attachments. An air gun may be used to blow moisture out from rear to front of attachment.
--------------------------------	--

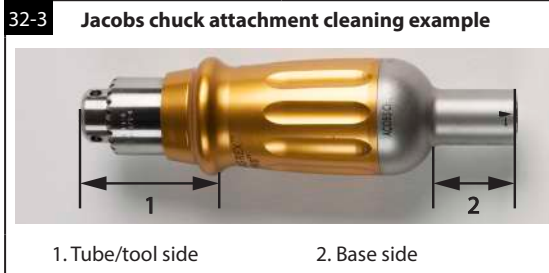
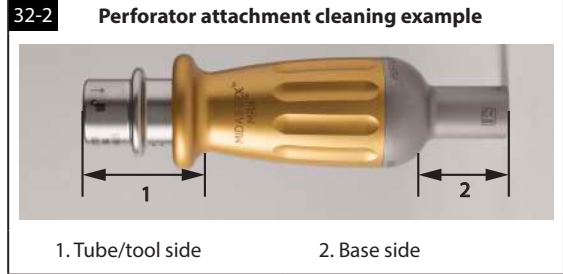
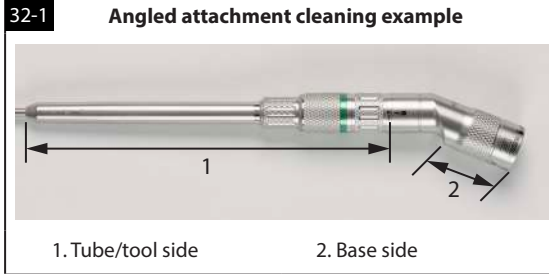

Instrument tray and rigid sterilization container

1. Manually clean the rigid sterilization container and instrument tray only when a washer-disinfector is not available.
 - a. Thoroughly rinse the rigid sterilization container and instrument tray under cold running tap water (10 - 22°C / 50 - 72°F) to remove any visible soil.
 - b. Use a soft-bristled brush or clean cloth to aid soil removal around brackets, handles, and filter retention plates (only on the rigid sterilization container).
 - c. If soil is visible, gently flush the gasket region of the rigid sterilization container.
 - d. Give particular attention to crevices and other areas that present a challenge to cleaning.
 - e. Carefully inspect the rigid sterilization container and instrument tray, including the handles, gaskets, filter retention plates, and cavities, to ensure all visible soil is removed.
2. Prepare neutral enzymatic cleaner Steris Prolystica 2x Concentrate.
 - a. Prepare the enzymatic cleaner following the manufacturer's recommendations of 1.0ml/L (1/8 oz/gallon) at a temperature of 23°C (73°F) or use an equivalent neutral pH cleaner following that manufacturer's recommendations.
 - b. Immerse the rigid sterilization container and instrument tray in the prepared enzymatic cleaner, actuate the tray and allow it to soak for a minimum of 10 minutes.
3. Thoroughly clean the rigid sterilization container and instrument tray.
 - a. Use a soft-bristled brush for the outer portion of the rigid sterilization container and instrument tray.
 - b. Pay particular attention to crevices, filter retention plates (only on the rigid sterilization container), latches, and other hard-to-clean areas to remove all visible soil.
4. After soaking, thoroughly rinse the rigid sterilization container and instrument tray under warm (23 - 43°C / 73 - 109°F) running tap water for a minimum of 1 minute to remove all residual cleaner.
 - a. Rinse the rigid sterilization container and instrument tray.
 - b. Use a syringe to aid in rinsing.
5. Following the warm tap water rinse, thoroughly rinse the rigid sterilization container and instrument tray in room temperature 25°C (77°F) purified water (deionized, reverse osmosis, or equivalent) water for a minimum of 30 seconds.

Note: After cleaning, visually examine all parts of the rigid sterilization container and instrument tray for cleanliness. If visible soil remains, repeat cleaning.
6. Dry the instrument tray and rigid sterilization container with a clean, lint-free towel.

After cleaning, lubricate attachments using an aerosol spray lubricant (such as Pana Spray) and perform the following steps to lubricate attachments:

1. Holding the can approximately 10-15 cm (3-6 in.) away from the attachment, spray all movable components with three quick squirts.
2. Actuate movable components to ensure proper lubrication.
3. Remove excess lubricant with a clean cloth.

Disinfection

No particular requirements.

Drying

If necessary, dry the devices with a clean, lint-free towel. Refer to the motor, attachment/tube, instrument tray, and sterilization container cleaning sections on specific drying instructions.

Maintenance, inspection, and testing

Do not reprocess for surgical use a device that has obvious damage or corrosion. Return to Medtronic for service. Visually inspect the reprocessed devices following cleaning. Inspection should be performed with adequate lighting. Magnification is not required. A device that shows or exhibits the properties listed below is at the end of its useful life. Attachments and telescoping tubes may be disposed of at the end of their useful life according to local and national regulations. Due to safety and environmental concerns, Medtronic requests the return of electric high-speed motors for proper disposal at the end of the product's useful life.

- Obvious damage or corrosion
- Pitting, cracks, fractures, or bending
- Illegible laser etchings, engravings, and other markings
- Discoloration, corrosion, stains or rust.
- Mechanisms that are rough or stuck. These are indications of bad O-rings, or damaged internal components for example, variable exposure collars, tool lock collar, and sleeves.

Packaging

Warnings:

- Do not load more than one MR8 motor inside the instrument tray per sterilization cycle.
- Do not wrap the rigid sterilization container.
- Use the instrument tray and the rigid sterilization container for sterilization only. The MR8 system devices must be cleaned separate from the trays.

There are two options available for packaging:

1. Devices may be sterilized using a wrapped instrument tray. The instrument tray should be wrapped with two layers of 1-ply polypropylene wrap using a sequential envelope technique. For use in the USA, an FDA-cleared wrap should be used.
2. Devices can also be sterilized by placing them inside an instrument tray and then placing the instrument tray inside an appropriately sized rigid sterilization container.

Instrument tray:

1. Inspect the following components before each sterilization cycle. Make sure the instrument tray does not have cracks or tears and that the silicone brackets (Figure 33) are not damaged.



2. Arrange the cleaned devices in the instrument tray's silicone brackets. The instrument tray includes printed outlines as a guide for the devices that fit within the tray.
3. Variable exposure attachments (AVAXX, AVAXXDK, AVSXX) must be placed in the instrument tray with their tube in the fully extended position (Figure 34-1).
4. As applicable, ensure the finger lever is removed from the body of the motor. To remove, unlock the finger lever by pressing forward and then slide the finger lever completely off the motor.
5. Place the motor and finger lever (when applicable) inside the instrument tray as shown in Figure 34-2. If applicable, finger lever must be fully extended during the cleaning process to ensure proper sterilization.
6. Close the instrument tray with the lid.

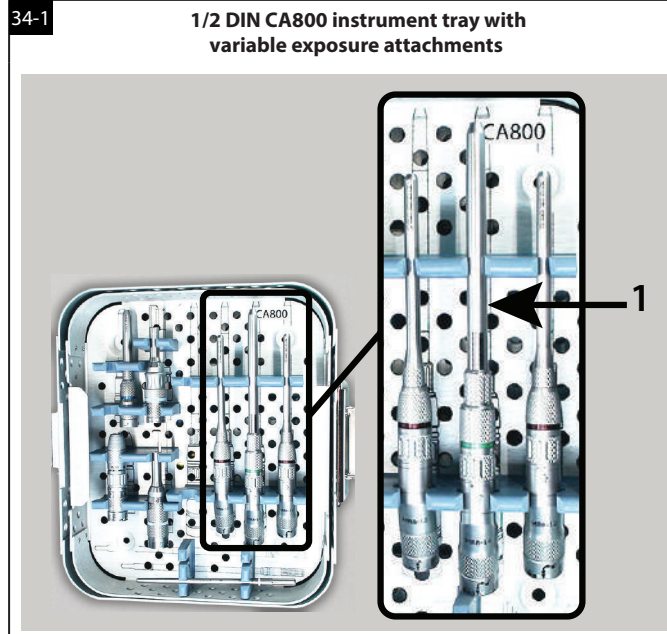

1. Variable exposure attachment in the fully extended position



Placement of the motor in the 1/2 DIN CA800 instrument tray lower level

Option 1: Wrap the instrument tray for sterilization:

- The user facility is responsible for using only accessories (such as sterilization wraps, chemical indicators, and biological indicators) that are cleared and labeled for the validated sterilization parameters specified in this Instructions for Use by the Food and Drug Administration for medical facilities in the U.S.A. and its territories, or conform to EN ISO 11607 for medical facilities outside of the U.S.A. and its territories.
- The instrument tray should be wrapped with two layers of 1-ply polypropylene wrap using a sequential envelope technique. For use in the USA, an FDA-cleared wrap should be used.

Option 2: Place the instrument tray into the rigid sterilization container:

1. Use one filter (Case Medical SCF01) for the rigid sterilization container's lid and use one filter (Case Medical SCF01) for the 1/2 DIN size rigid sterilization container's base. If using the 3/4 DIN size rigid sterilization container, use two filters (Case Medical SCF01) in the container's base.
 - a. Place the filter over the perforations in the lid and place a filter retention plate over the filter.
 - b. Secure the filter retention plate by pushing downwards at the center and rotating the handles until you hear them click (Figure 35).
2. Place a rack around the filter plates (Figure 36).
3. Place the instrument tray with the lid on into the rigid sterilization container (Figure 37).

Note: Use only the 1/2 DIN CA800 instrument tray with the 1/2 DIN rigid sterilization container. Use only the 3/4 DIN CA850 instrument tray with the 3/4 DIN rigid sterilization container.
4. Close the rigid sterilization container and apply labels and seals.
 - a. On both sides of the rigid sterilization container, position the top of the latch over the ridge in the lid and push the bottom section of the latch in toward the rigid sterilization container (Figure 38-1). You will feel a solid click.
 - b. Place the appropriate metal ID tags in the label holders located on either side of the rigid sterilization container latches.

Note: Use only the approved tamper-evident seals (Case Medical SCS01B). Using a nonapproved tamper-evident seal could damage the locking clip.
5. Place the container flat on the shelf of the sterilizer cart.

35 Rigid sterilization container filter placement



36 1/2 DIN sterilization container with rack



37 1/2 DIN CA800 tray inside of the rigid container



3/4 DIN CA850 tray inside of the rigid container





Sterilization

Warnings:

- Do not attempt to run the MR8 motors immediately after autoclaving. Allow an adequate cooling period after steam sterilization.
- Do not sterilize and supply for surgical use any device that is not visibly clean and free of particulates. If particulates are present, repeat reprocessing, starting with the Preparation for Cleaning step.
- Use the instrument tray and the rigid sterilization container for sterilization only. The MR8 system devices must be cleaned separate from the trays.
- Devices cannot be sterilized to an adequate Sterility Assurance Level (SAL) without prior cleaning and decontamination.

Cautions:

- Do not expose these devices to sterilization temperatures greater than 137°C (279°F). Exposure to temperatures greater than 137°C (279°F) may impact the performance of the device and also the efficacy of the sterilization cycle.
- Because of the variability in cleaning efficiencies and sterilizer operating parameters, all given parameters (temperature, time, etcetera) should be validated by persons who have training and expertise in sterilization processes. Deviation from the recommended sterilization processes is at the risk of the user facility.

Notes:

- The instructions provided have been validated by the manufacturer as being capable of preparing the product for reuse. It remains the responsibility of the processor to ensure that the reprocessing as actually performed, using equipment, materials, and personnel in the reprocessing facility, achieves the desired result. This normally requires validation and routine monitoring of the process.
- Load the parts into the sterilizer by following the sterilizer manufacturer's recommended loading procedures and load configurations.
- These sterilization instructions have been validated to a sterility assurance level of 10⁻⁶.
- The recommended sterilization parameters are only valid with CE-marked equipment that is properly maintained and calibrated.
- Steam for sterilization should be generated from water that has been treated to remove total dissolved solids, filtered to remove contaminants and water droplets, and supplied via piping without deadlegs or other stagnant zones where contamination might collect. Steam saturation should be greater than 97%.

Cycle	Temperature	Exposure time	Minimum dry time*
In any geography - sterilization prevacuum (dynamic-air-removal) steam cycle parameters for medical facilities			
Prevacuum	132°C (270°F)	4 minutes (04:00)	25 minutes (25:00)
Prevacuum	135°C (275°F)	3 minutes (03:00)	25 minutes (25:00)
Outside the U.S.A. - sterilization prevacuum (dynamic-air-removal) steam cycle parameters for medical facilities			
Prevacuum	134°C (273°F)	18 minutes (18:00)	25 minutes (25:00)
*Minimum dry times were validated using sterilizers having vacuum drying capabilities. Drying cycles using ambient atmospheric pressures may require more time.			

Storage

Make sure that the container is dry before storage, and stored in cool, dry conditions at ambient room temperature. Store sterile devices in such a way that the sterile package is not compromised.

Use

- When you are ready to use the devices, follow these steps.
1. Before you open the container, make sure that:
 - a. You have selected the correct rigid sterilization container.
 - b. The tamper-evident seals are intact.
 2. Unlatch the container.
 3. Use the ring on top of the lid to remove the lid. Using the ring avoids contaminating the container's contents.
 4. Remove the tray of devices and place it in the sterile field.

Return policy for devices exposed to TSE (transmissible spongiform encephalopathies)

Reusable devices that have been used on patients with suspected Creutzfeldt-Jakob Disease (CJD) or other TSEs should be quarantined and not reused until a diagnosis is confirmed or excluded. The Neurosurgery Group will not authorize or accept the return of MPSS products that directly contacted a patient or are contaminated with a patient's body fluids that is suspected or confirmed with TSE or CJD diagnosis. Furthermore, MPSS recommends that all MPSS product used on a patient confirmed with or suspected of a TSE/CJD diagnosis be incinerated. If TSE/CJD is excluded as a diagnosis, the quarantined reusable equipment may be returned for use after appropriate cleaning, decontamination and sterilization. Hospital personnel should contact their infection control personnel for current procedures and policy for reusable equipment processing. Contact your sales representative for temporary equipment while original equipment is quarantined or for replacement of product incinerated under this policy.

Planned maintenance

Planned maintenance information is provided as a guide to assist the customer in getting the greatest ownership value from their MR8 system. This scheduled program helps to maintain the device's performance, safety, and reliability. Maintenance for the MR8 system is in addition to the required routine cleaning after each use.

The frequency of maintenance depends on how often the system is used and the conditions which the system is subjected to, such as during cleaning and sterilization. The demands on MR8 systems can vary greatly from facility to facility. The time between scheduled maintenance is determined by tool usage per motor per year and per month per motor. Adhere to the scheduled maintenance intervals in Table 8.

Maintenance level	Number of tools used per motor per year	Number of uses per month per motor	Number of uses per month per attachment**	Time interval
A	150-200	12-16*	19-23	3 months
B	100-149	8-11	15-18	4 months
C	50-99	4-7	12-15	5 months
D	<50	<4	≤11	6 months

*A motor with more than 16 uses per month should be returned for Medtronic maintenance at a 6-month interval.
 **Usage per month for most attachments. Some attachments may require more frequent checks.

Notes:

- If any damage, wear, rust or corrosion is observed with the product or if action is required beyond cleaning, do not use the product and return to Medtronic for service.
- The planned maintenance steps have been designed for a facility's biomedical department or equivalent to perform.
- The console, motor, cables, tool rack, and rigid sterilization containers have a limited warranty period of 1 year from the date of purchase. The attachments and telescoping tubes have a limited warranty period of 90 days from the date of purchase. After the warranty period, any costs incurred for repairing or refurbishing the system becomes the responsibility of the customer. This limited warranty does not include the cost associated with any of the factory-level service requirements identified in the planned maintenance schedule. Extended maintenance agreements are available.
- Failure to follow recommended service and planned maintenance schedules for attachments or motors may prevent the tool from being secured properly. Identifying and following the scheduled maintenance intervals for the MR8 system will assist in reducing the potential for unanticipated down time as a result of wear.

For scheduled maintenance intervals 1, 2, 3, 5, 6, 7, 9, 10, and 11

Follow the detailed instructions for servicing the MR8 system in accordance with the 12 maintenance intervals.

Motor:

1. Visually inspect the motor cable to verify that it does not have any damage to the insulation or to the connector and that there is no debris evident. Do not use the product if damage is found and return to Medtronic for service.
2. Turn the rotational collet of the motor as shown in Figure 39-1 using motor wrench provided by Medtronic to the position shown in Figure 39-2.
3. Plug in the foot control and the motor into the IPC.
4. If the display shows any errors, then the motor is not properly connected or the connectors of the motor are dirty, or the motor or console may need servicing.
5. Press the Reverse button on the foot control several times and verify that the console display toggles between << REVERSE and FORWARD >>. Leave the console in the << REVERSE mode. Press the foot pedal to start the motor in reverse and listen for 3 beeps when the motor starts in reverse.
6. Run motor for 5 minutes at 75,000 rpm. Verify that the motor case does not become uncomfortably hot to the touch.
7. Verify that when the foot pedal is released the motor stops and does not continue to run. If the motor continues to run when the foot pedal is released, do not use and return system to MPSS for service.
8. Using the motor wrench, turn the rotational collet such that it aligns with stationary collet as shown in Figure 39-3.



The Midas Rex MR8 electric high-speed drill system

Attachments: straight, angled, footed, perforator, Jacobs chuck, metal cutting, J-latch, and telescoping

Note: Telescoping tubes are multi-use disposables and do not receive scheduled maintenance. Discard if excessive heat or vibration is present.

1. Visually inspect the etching and color ring to ensure it remains legible and the color is distinguishable.
2. Visually inspect the attachment tube and base for any signs of debris or damage.
3. Visually and physically inspect (pull and twist by hand) the attachment for any loose or loosening components. If any components are loose, do not use.
4. Straight and angled: Visually inspect the attachment tip for any signs of wear. The tip should remain round with no evidence of deformation.
5. Footed: Visually inspect the foot of the attachment. The foot should not be bent and the proximal dimple should be smooth and showing no signs of damage.
6. Perforator and Jacobs chuck: Visually inspect the perforator and Jacobs chuck collet for any signs of wear or deformation. Rotate the collet of the attachment. It should rotate easily.
7. Heat Check:
Caution: Feel the motor case, the attachment base, knuckle (angled area for angled attachment only), and the attachment tip (straight and angled attachments only) periodically and cautiously to ensure they are not uncomfortably hot to the touch.
 - a. Attach and lock the attachment onto the motor. Ensure that there is a tactile click when the attachment is locked onto the motor.
Note: Ensure that the secondary lock is engaged on the angled attachments.
 - b. Connect the motor to a console with the FCU attached.
 - c. Turn the console on.
 - d. Run the motor and attachment at 75,000 rpm for 3 minutes (03:00).
 - e. Allow the motor to cool and then repeat steps 1 to 7 for each attachment in the system.
8. Exceptions:
 - a. Run J-latch attachment at default speed for 3 minutes (03:00).
 - b. Perforators and Jacobs chuck at default speed for 5 minutes (05:00)

For scheduled maintenance intervals 4, 8, 12

Motor and attachments: straight, footed, perforator, Jacobs chuck, telescoping, angled, and metal cutting

- At these maintenance intervals, it is important that the units be returned to Medtronic for factory level inspection and service.
Note: The costs associated with any of the factory level service requirements are not included in the limited warranty. Extended maintenance agreements are available.

Storage

Store devices in a clean, dry area with other sterile devices.

Disposal

Due to safety and environmental concerns, Medtronic requests the return of electric high speed motors for proper disposal at the end of the product life cycles.

Troubleshooting

If MR8 system components require servicing or refurbishing, return components to Medtronic for quality assured service by factory-trained personnel who will utilize genuine Medtronic MR8 system parts as required. All MR8 system components returned for servicing or refurbishing should be properly cleaned and sterilized prior to shipping.

Problem	Possible cause	Recommendations
MR8 motor		
Motor is too hot to touch/ hold	Inadequate cool down period following sterilization	Motor must be allowed to cool down following steam sterilization.
	Attachment transferring heat to the motor.	Switch attachments to determine whether the heat is being generated by the motor or the attachment.
	Heavy side loading during dissection.	Discontinue use and rest the motor by using it intermittently or wrap the motor with a moist sterile towel.
Motor does not run	Cables not properly connected	Ensure motor and foot control cables are properly connected.
	Speed setting is too low	Ensure that a speed greater than 3,000 rpm is selected. Check the IPC for error status.
	Attachment not properly installed and locked onto the motor	Remove and reinstall the attachment and dissecting tool to ensure proper installation.
	Internal failure of motor and/or console.	Change motor or console to isolate the problem.
	Foot control not properly functioning	Check for obstruction under the foot pedal.
	Cables damaged	Check cable for cracks, splits, or bent connector pins.
Attachment does not seat properly on motor	Damaged tactile ring on motor collet	Contact Medtronic Customer Service to return the motor for service.

Problem	Possible cause	Recommendations
MR8 attachments or telescoping tubes		
Attachment or telescoping tube has uncomfortable temperature to touch or hold.	Heat from worn attachment or tube bearings.	Do not use. Try another attachment or tube. Contact Medtronic Customer Service. Telescoping tubes are multi-use disposable. If problem is resolved with a new telescoping tube, discard the overheated tube.
	Attachment or tube is unclean due to improper cleaning procedures.	Check that appropriate cleaning procedures are being followed.
	Heavy side loading during dissection.	Discontinue use and rest the attachment by using intermittently, try another identical attachment or wrap the attachment interface with a moist sterile towel. If attachment continues to overheat, contact Medtronic Customer Service.
	Inadequate irrigation.	Ensure adequate irrigation to surgical site.
Color band on attachments or telescoping tubes fade or become discolored.	Incorrect cleaning or sterilization method.	Use nomenclature markings on the attachment to match with a corresponding dissecting tool or contact Medtronic Customer Service. Telescoping tubes are multi-use disposable.
	Use of chlorine based or corrosive cleaning agents.	
	Aging.	
Attachment or telescoping tube displays rust.	Incorrect cleaning or sterilization method.	Do not use. Contact Medtronic Customer Service. Dispose of telescoping tube. Telescoping tubes are multi-use disposable.
	Use of chlorine-based or corrosive cleaning agents.	
	Aging.	
Attachment or telescoping tube is bent, loose, damaged, or missing a component.	Attachment mishandled, failed due to extended use or excessive force applied during use.	Do not use. Contact Medtronic Customer Service. Dispose of telescoping tube. Telescoping tubes are multi-use disposable.
Attachment will not properly seat on motor.	Motor collet flats are not in proper alignment.	Using the Medtronic wrench, rotate the collet flat closest to the motor case until its arrow marker is aligned with the arrow marker on the other flat.
Attachment has excess lubrication.	Over lubrication during cleaning process.	Visually inspect and wipe excess lubrication.
Difficulty removing tool from attachment.	Aging of attachment.	Contact Medtronic Customer Service.
	Improper cleaning.	
	Use of reprocessed tools.	
	Use of unauthorized re-furbisher.	
	Attachment tool lock left in locked position.	Rotate the locking mechanism on tube side of attachment to the unlocked position.
	Incorrect cleaning or sterilization of the motor collet.	Check that appropriate cleaning procedures are being followed.
Footed attachment has a component missing from leg or foot area.	Attachment damaged by dissecting tool drilling out part or all of leg or foot area. Attachment dropped or damaged during use.	Do not use. Contact Medtronic Customer Service.
Perforator running too slow.	Speed set incorrectly.	Increase speed at IPC.
Footed attachment will not lock	Tool not seated properly	Remove and reinstall the dissecting tool to ensure that it is properly seated. An audible click, heard and perceptible by touch, confirms that the tool is fully seated.
MR8 dissecting tools		
Dissecting tool flails.	Device other than a MR8 dissecting tool used.	Do not use. Replace with a MR8 dissecting tool.
	Worn attachment or tube bearings.	Do not use. Try another attachment or tube to isolate location of problem. If flail is produced by a specific attachment, contact Medtronic Customer Service. Dispose of telescoping tube. Telescoping tubes are multi-use disposable.
	Attachment or tube and tool combination improper.	Do not use. Check for the correct nomenclature and color code on the dissecting tool packaging to the same nomenclature and color band on the attachment or tube.

Medtronic Midas Rex MR8 electric high speed systems limited warranty*

(U.S. customers only)

- A. This limited warranty provides the following assurance to the purchaser of a Medtronic Midas Rex MR8 electric high speed system. This limited warranty is extended only to the buyer purchasing the MR8 system directly from Medtronic or from its affiliate or its authorized distributor or representative. The Midas Rex MR8 electric high speed system (hereinafter all items listed below are collectively referred to as product) includes, as may be applicable, the motor, foot control, instrument trays and rigid sterilization containers (hereafter referred to as system components), straight and angled motor attachments (hereinafter referred to as "attachments"), telescoping tubes (hereinafter referred to as semi-reusable components), and dissecting tools and other accessories not listed above and jointly referred to as other components, unless specifically noted.
- a. Should a system component fail to function to Medtronic's published specifications during the term of this limited warranty (one year from the date of sale of a new system component or 90 days from the date of sale of a refurbished or used system component), Medtronic will either repair or replace the motor component or any portion thereof.
 - b. Should an attachment fail to function to Medtronic's published specifications during the term of this limited warranty (90 days from the date of sale of a new attachment), Medtronic will either repair or replace the attachment or any portion thereof.
 - c. Should a semi-reusable component fail to function to Medtronic's published specifications during the term of this limited warranty (30 days from the date of sale of a new semi-reusable component), Medtronic will replace the semi-reusable component or any portion thereof.
 - d. Should a single use component fail to function to Medtronic's published specifications prior to its "use by" date Medtronic will replace the single use component.
 - e. Should other components fail to function to Medtronic's published specifications during the term of this limited warranty (30 days from the date of sale of a new other components), Medtronic will replace or repair the other components or any portion thereof.
- B. To qualify for this limited warranty, the following conditions must be met:
- a. The product must be used on or before its "use by" or "use before" date, if applicable.
 - b. The product must be used in accordance with its labeling and may not be altered or subjected to misuse, abuse, accident or improper handling.
 - c. Medtronic must be notified in writing within thirty (30) days following discovery of any defect or performance issue.
 - d. The product must be returned to Medtronic within thirty (30) days of Medtronic receiving notice as provided for in (3) above.
 - e. Upon examination of the product by Medtronic, Medtronic shall have determined that: (i) the product was not repaired or altered by anyone other than Medtronic or its authorized representative, (ii) the product was not operated under conditions other than normal use, and (iii) the prescribed periodic maintenance and services, if applicable, have been performed on the product
- C. This limited warranty is limited to its express terms. This limited warranty is in lieu of all other warranties, expressed or implied whether statutory or otherwise, including any implied warranty of merchantability or fitness for a particular purpose. In no event shall Medtronic be liable for any consequential, incidental, prospective, or other similar damage resulting from a defect, failure, or malfunction of the product, whether a claim for such damage is based upon the warranty, contract, negligence, or otherwise.
- D. The exclusions and limitations set out above are not intended to, and should not be construed so as to, contravene mandatory provisions of applicable law. Users may benefit from statutory warranty rights under legislation governing the sale of consumer goods. If any part or term of this limited warranty is held by any court of competent jurisdiction to be illegal, unenforceable, or in conflict with applicable law, the validity of the remaining portion of the limited warranty shall not be affected, and all rights and obligations shall be construed and enforced as if this limited warranty did not contain the particular part or term held to be invalid.

*This limited warranty is provided by Medtronic Neurosurgery Group, 4620 North Beach Street, Fort Worth, Texas 76137-4116. It applies only in the United States. Areas outside the United States should contact their local Medtronic representative for terms of the warranty.

After the warranty period, any costs incurred for repair/refurbishing become the responsibility of the customer. This limited warranty does not include the cost associated with any of the factory level service requirements identified in the preventive maintenance schedule. Extended maintenance agreements are available.

Symbols

The following symbols can appear on this device and related packaging.

	Compliant with European Council Directive MDD 93/42/EEC		RF Transmitter (Interference May Occur)		Output
	Authorized Representative in the European Community		Manufacturer		Accessory
	Compliance Mark EMC		Date of Manufacture		Adapter
	Conforms to ANSI/AAMI ES60601-1, Certified to CAN/CSA-C22.2 No.60601-1, IEC/EN 60601-1		Use By Date		Attachment
	UL Mark UL classified with respect to electric shock, fire, and mechanical hazards only in accordance with UL 60601-1 2FF7. UL classified for Canada with respect to electric shock, fire, mechanical and other hazards only in accordance with CAN/CUSA C22.2 UL 601-1. Medical Equipment Certified for Canada 2FF7.		Serial Number		Brush
R Only	Caution: Federal law (USA) restricts this device to sale by or on the order of a physician.		Catalog Number		Dissecting Tool
	Consult Instructions for Use		Lot Number		Electrical High Speed Motor Connector
	Follow Instructions for Use		Package Contents		Instrument Tray
	Caution		Quantity		Motor
	Do not oil.		Oscillate		Refurbished
	Do Not Dispose Of This Product In The Unsorted Municipal Waste Stream. Dispose Of This Product According to Local Regulations. See Recycling.Medtronic.com for Instructions On Proper Disposal Of This Product.		Use With		Multi-Use Disposable Attachment
	If the single use symbol is on the device label then this device is designed for single patient use only. Do not reuse, reprocess, or resterilize this product. Reuse, reprocessing, or resterilization may compromise the structural integrity of the device and/or create a risk of contamination of the device, which could result in patient injury, illness, or death.		AC Power		Part Number
	Non-Sterile		Start/Stop		USA Only
	Sterilized using Irradiation		Finger-Operated Control		Do not use if package is open or damaged
	Temperature Limitation		Motor		Package Quantity
TUBE	Tube Control		Top Foot Control Unit Button / Motor Button		Double-Locking
			Foot Pedal Connector		Diameter
			Left Foot Control Unit Button / Mode Button		Unlock
			Right foot control unit button		Lock
					Contains DEHP (di-2-ethyl hexyl phthalate)
				TOOL	Tool control

RxOnly 
0086

Medtronic

175038EN B
2019-01

May be covered by U.S. Patents:
Medtronic.com/patents

©2019 Medtronic, Inc.
Made in USA. Printed in USA.



Medtronic Powered Surgical Solutions
4620 North Beach Street
Fort Worth, Texas 76137 USA
+1 800 433 7080

 Medtronic B.V.
Earl Bakkenstraat 10
6422 PJ Heerlen
The Netherlands
+31 45 566 8000

Medtronic Australian Sponsor:
Medtronic Australasia Pty Ltd
2 Alma Road
Macquarie Park, NSW 2113 Australia

Medtronic of Canada Ltd
99 Hereford Street
Brampton, Ontario L6Y 0R3
Canada
+1 905 460 3800

Europe/Middle East/Africa
Medtronic International Trading Sàrl
Route du Molliau 31
Case Postale 84
CH- 1131 Tolochenaz
Switzerland
+41 21 802 7000

medtronic.com
manuals.medtronic.com



Instructions for Use
175039EN B

The Midas Rex™ MR8™ Pneumatic High-Speed Drill System

MR8 Pneumatic and MR8 Pneumatic Touch Motors

Customer service

Contact your Medtronic Neurosurgery sales representative or call:

Medtronic Neurosurgery Service Group

(800) 335-9557 or (817) 788-6440

RS.DFWrepairs@medtronic.com

Outside the U.S.A., contact your Medtronic regional distributor or Medtronic Neurosurgery sales representative.

- EN** To obtain a copy of this manual in your local language contact your local Medtronic representative or go to **manuals.medtronic.com**.
- BG** За да получите екземпляр от това ръководство на Вашия език, можете да се свържете с местния представител на Medtronic или да посетите **manuals.medtronic.com**.
- CS** Máte-li zájem o kopii této příručky ve svém jazyce, kontaktujte místního zástupce společnosti Medtronic nebo navštivte webové stránky **manuals.medtronic.com**.
- DA** Du kan få en kopi af denne vejledning på dit sprog ved at kontakte den lokale Medtronic-repræsentant eller gå til **manuals.medtronic.com**.
- DE** Eine Kopie dieses Handbuchs in der jeweiligen Landessprache kann vom örtlichen Medtronic-Vertreter angefordert oder unter **manuals.medtronic.com** bezogen werden.
- EL** Για να λάβετε αντίγραφο του παρόντος εγχειριδίου στην τοπική σας γλώσσα, επικοινωνήστε με τον τοπικό αντιπρόσωπο της Medtronic ή επισκεφθείτε την ιστοσελίδα **manuals.medtronic.com**.
- ES** Para obtener una copia de este manual en su idioma local, póngase en contacto con su representante local de Medtronic o visite **manuals.medtronic.com**.
- ET** Võtke ühendust oma ettevõtte Medtronic esindajaga või külastage veebisaiti **manuals.medtronic.com**, et hankida juhendist koopia kohalikus keeles.
- FI** Jos haluat tämän käyttöoppaan omalla kielelläsi, ota yhteyttä paikalliseen Medtronicin edustajaan tai siirry osoitteeseen **manuals.medtronic.com**.
- FR** Pour obtenir un exemplaire de ce manuel dans votre langue, veuillez contacter votre représentant Medtronic local ou visiter la page **manuals.medtronic.com**.
- HR** Da biste dobili kopiju ovog priručnika na svom jeziku, obratite se lokalnom zastupniku tvrtke Medtronic ili posjetite web-mjesto **manuals.medtronic.com**.
- HU** Ha szeretne egy saját nyelvű példányt a jelen kézikönyvből, vegye fel a kapcsolatot a Medtronic helyi képviselőjével, vagy látogasson el a **manuals.medtronic.com** weboldalra.
- IT** Per ottenere una copia del presente manuale nella lingua locale, contattare il rappresentante Medtronic di zona o visitare la pagina **manuals.medtronic.com**.
- LT** Norėdami gauti šio vadovo kopiją vietos kalba, susisiekitė su vietos „Medtronic“ atstovais arba apsilankykite adresu **manuals.medtronic.com**.
- LV** Lai saņemtu šīs rokasgrāmatas eksemplāru vietējā valodā, sazinieties ar savu vietējo Medtronic pārstāvi vai apmeklējiet vietni **manuals.medtronic.com**.
- MK** За да добиете копија од овој прирачник на вашиот локален јазик, контактирајте со вашиот локален претставник на Medtronic или појдете на **manuals.medtronic.com**.
- NL** Neem contact op met uw vertegenwoordiger van Medtronic of ga naar **manuals.medtronic.com** voor een exemplaar van deze handleiding in uw taal.
- NO** Du kan få et eksemplar av denne håndboken på ditt språk ved å kontakte din lokale Medtronic-representant eller gå til **manuals.medtronic.com**.
- PL** Aby uzyskać egzemplarz niniejszego podręcznika w wybranym języku, należy się skontaktować z lokalnym przedstawicielem firmy Medtronic lub odwiedzić stronę **manuals.medtronic.com**.
- PT-BR** Para obter uma cópia deste manual em seu idioma local, entre em contato com o representante local da Medtronic ou acesse **manuals.medtronic.com**.
- PT-PT** Para obter uma cópia deste manual no seu idioma local, contacte o seu representante local Medtronic ou visite **manuals.medtronic.com**.
- RO** Pentru a obține o copie a acestui manual în limba locală, contactați reprezentantul local Medtronic sau accesați **manuals.medtronic.com**.
- RU** Для получения экземпляра этого руководства на вашем языке обратитесь к местному представителю Medtronic или посетите сайт **manuals.medtronic.com**.
- SK** Ak chcete získať kópiu tejto príručky vo vašom miestnom jazyku, kontaktujte miestneho zástupcu spoločnosti Medtronic alebo navštívte stránku **manuals.medtronic.com**.
- SL** Če želite izvod tega priročnika v svojem jeziku, se obrnite na lokalnega predstavnika za Medtronic ali pa ga poiščite na spletnem mestu **manuals.medtronic.com**.
- SR** Da biste dobili kopiju ovog priručnika za korisnike na svom jeziku, kontaktirajte lokalno predstavništvo kompanije Medtronic ili posetite lokaciju **manuals.medtronic.com**.
- SV** För att erhålla en kopia av denna handbok på ditt språk kontaktar du din lokala representant för Medtronic eller går till **manuals.medtronic.com**.
- TR** Bu kılavuzun kendi dilinizde bir kopyasını almak için, bölgenizdeki Medtronic temsilcinize başvurun veya **manuals.medtronic.com** adresine gidin.
- UK** Щоб отримати копію цього посібника вашою місцевою мовою, зв'яжіться зі своїм місцевим представником Medtronic або відвідайте веб-сайт **manuals.medtronic.com**.

Contents

Glossary	1
General information	1
Indications for use	1
MR8 system description	1
MR8 pneumatic motors	1
MR8 attachments	1
MR8 surgical dissecting tools	1
Contraindications	1
Special notices	1
Warnings	1
System	1
System hoses	2
Tools and disposable components	2
Pneumatic control unit	3
Cautions	3
MR8 pneumatic high-speed system components	4
MR8 pneumatic motors	4
Pneumatic control unit	5
Regulator	5
Regulator hose	5
MR8 pneumatic motors	5
MR8 pneumatic touch motors	5
MR8 pneumatic connections and adapters	6
Operating room set up	7
System set up	8
Install the oiler cartridge	8
Connect the motor	9
Activate the motor	9
MR8 surgical dissecting tools	10
Assembly	10
Tool nomenclature	10
MR8 attachments	13
Straight attachments	14
Angled attachments	15
Variable exposure straight and angled attachments	16
Angled double lock (DK) attachments	17
Fixed footed attachments	18
Rotating footed attachments	19
Metal cutting attachments	20
Telescoping attachments and tubes	21
Perforator driver attachments	22
Jacobs chuck attachments	23
J-latch attachments	24
Disassembling the MR8 pneumatic system	24
Depressurize the system	24
Disconnect hoses	24
Discard the lubricant/diffuser cartridge	24
System accessories: disposable components	25
Cleaning brushes	25
System accessories: non-disposable components	25
Instrument tray	25
Rigid sterilization container (sterilization case)	25
MR8 system reprocessing instructions	26
Warnings and cautions	26
Limitations on reprocessing	26
Point of use	26
Containment and transportation	26
Preparation for cleaning: automated	26
Cleaning: automated	27

Cleaning: manual	28
Disinfection	29
Drying.....	29
Maintenance, inspection, and testing	29
Packaging.....	30
Sterilization.....	32
Storage.....	32
Use	32
Return policy for devices exposed to TSE (transmissible spongiform encephalopathies)	32
Planned maintenance.....	33
For scheduled maintenance intervals 1, 2, 3, 5, 6, 7, 9, 10, and 11	33
For scheduled maintenance intervals 4, 12	34
For scheduled maintenance interval 8.....	34
Storage	35
Disposal.....	35
Troubleshooting	35
MR8 motor	35
MR8 attachments or telescoping tubes	35
MR8 dissecting tools	36
Medtronic Midas Rex MR8 pneumatic high speed systems limited warranty*	36
Symbols.....	37

Glossary

The following words and acronyms may be used in this guide.

DK	Double locking
PCU	Pneumatic Control Unit
MR8	Midas Rex, 8th Generation

General information

Read and understand this manual before use of the MR8 system. The MR8 system is designed for use by medical professionals familiar with powered surgical instrumentation. The surgeon is responsible for learning the proper techniques in the use of this system, as inappropriate use may potentially be harmful. It is strongly recommended that the surgeon and dedicated operating room personnel are knowledgeable with the use of this equipment by being trained in Medtronic Midas Rex Hands-On Workshops or by one of the local authorized representatives.

Indications for use

The Medtronic MR8 drill system is indicated for the incision/cutting, removal, drilling, and sawing of soft and hard tissue, bone, and biomaterials in Neurosurgical (Cranial and Craniofacial including Craniotomy); Ear, Nose and Throat (ENT), Maxillofacial, Orthopedic, Arthroscopic, Spinal, Sternotomy, and general surgical procedures.

Additionally, the MR8 drill system is indicated for the incision/cutting, removal, drilling, and sawing of soft and hard tissue, bone, and biomaterials during open and minimally invasive spine procedures, which may incorporate application of various surgical techniques during the following lumbar spinal procedures:

- Lumbar Microdiscectomy
- Lumbar Stenosis Decompression
- Posterior Lumbar Interbody Fusion (PLIF)
- Transforaminal Lumbar Interbody Fusion (TLIF)
- Anterior Lumbar Interbody Fusion (ALIF)
- Direct Lateral Interbody Fusion (DLIF)

MR8 system description

MR8 pneumatic motors

Pneumatic motors provide power to operate interchangeable, disposable surgical dissecting tools. These motors are designed to interface with a series of attachments and surgical dissecting tools utilizing a standard quick-disconnect locking mechanism. Motors operate in the same manner whether controlled by a finger mechanism or PCU.

MR8 attachments

Attachments are designed to align the surgical tools with the motor to provide support and stability during various surgical procedures. Attachment options include regular (straight, and angled), variable exposure (straight and angled), footed (craniotomes), and telescoping attachments and tubes. There are a variety of specialty attachments, such as the perforator, Jacobs chuck, j-latch, and metal cutting that are also available. This allows flexibility with the length and style of attachment for surgeries.

MR8 surgical dissecting tools

Surgical dissecting tools are designed and intended to resect, drill, or saw soft and hard tissue, bone, biomaterials, and metals during various surgical procedures. The surgical dissecting tools vary in length and the distal tips of the tools vary in shape and style. The tip designs include the following universal shapes: acorn, match head, ball or round, cylinder, oval, and tapered or side-cutting. Specialized tools such as metal cutters, twist drills, hole-makers, hole saws, and reverse tapered tools are also available.

Contraindications

None.

Special notices

The words warning, caution and note have special meanings in this manual, and should be carefully reviewed:

Warning: A warning indicates that the personal safety of the patient or physician may be involved. Disregarding this information could result in injury to the patient or user.

Caution: A caution indicates that there is a risk of damaging equipment.

Note: A note is intended to provide additional information, which may be useful, but is not essential to complete the procedure.

Warnings

System

- W1 The MR8 system operator must be familiar with this **Instructions for Use**, its precautions, procedures and safety issues.
- W2 The MR8 system and its associated equipment should be used only by qualified medical professionals who are thoroughly trained and experienced in performing surgery with Medtronic surgery systems.
- W3 Always inspect the components before and after use for any damage. If damage is observed, do not use damaged component until it is repaired by Medtronic or replaced.
- W4 Use adequate irrigation during dissection to prevent thermal necrosis.
- W5 Do not use an overheated device, as it may cause thermal injury to the patient or operator.
- W6 Heavy side loads and/or long operating periods may cause the device to overheat.
 - W6a Never place an overheated motor on the patient or draping during the surgery.
 - W6b Discontinue use and rest the motor by using it intermittently, or wrap the motor/attachment interface with a moist sterile towel.
 - W6c If the motor is passed off, the receiver should grasp the motor by the proximal end close to the motor hose.
- W7 Do not use excessive force to pry or push bone with the attachment or dissecting tool during surgery.
- W8 Use only dissecting tools specifically designed for use with this drill system. Match the nomenclature and color code on the MR8 dissecting tool packaging to the same nomenclature and color band on the MR8 attachment.
- W9 Do not use the MR8 system without proper cleaning and sterilization.
- W10 Sterilize and dry the reusable device before storing. Decrease the likelihood of cross-contamination with timely sterilization. After each procedure, properly clean and sterilize all reusable system components.
- W11 All service must be performed by Medtronic qualified personnel only.

The Midas Rex MR8 pneumatic high-speed drill system

- W12 Employ visualization, including the use of imaging techniques (for example, fluoroscopy, image guided surgery) when using rotating powered accessories. Discontinue the powered application if visualization to the surgical site is lost.
- W13 Do not attempt to remove a dissecting tool or attachment while the motor is running, or when the motor or attachment is in an overheated state to prevent laceration of the user and/or cross contamination through a compromised glove.
- W14 Do not immerse the system components, except when recommended by the cleaning instructions in this Instructions for Use.
- W15 The MR8 motors should only be operated when the attachment is in the fully locked position.
- W16 Do not modify any components of the system; performance could be diminished.
- W17 Do not use the MR8 system if the motor continues to run after releasing the foot pedal or finger lever.
- W18 Do not place the motor, attachment, or dissecting tool on the patient or in an unsecured location during surgery.
- W19 Do not use an attachment and dissecting tool combination that results in tool flail or excessive vibration.
- W20 Do not attempt to run the MR8 motors immediately after autoclaving. Allow an adequate cooling period after steam sterilization.
- W21 Verify functionality prior to reuse:
 - W21a Conduct a visual inspection of the hose for cracks, tears, or corrosion.
 - W21b Check attachments for proper appearance. Install the attachment and dissecting tool, then briefly the run motor.
 - W21c Check motor for overheating.
 - W21d Check attachment for overheating.
 - W21e Check dissecting tool for flail.
 - W21f Check motor for leaking lubricant.
- W22 Do not place MR8 motor in the proximity of a magnetic field, such as magnetic drape or Magnetic Resonance Imaging (MRI) equipment to avoid inadvertent motor activation.
- W23 Do not use metal-cutting attachment or tools to cut/resect bone.
- W24 For metal transection, observe the following safety guidelines:
 - W24a Wear eye protection.
 - W24b Irrigate well to cool the cutting surfaces.
 - W24c Protect the wound site from metal debris.
 - W24d Use a clamp or grasping device to control loose fragments during transection of any metal component.
- W25 Do not use any parts other than Medtronic system components, as damage or substandard performance could result.
- W26 When using MR8 variable exposure attachments, surgeons should become familiar with the performance of dissecting tools before use and should explore the effect of various levels of tool exposure on tool stability. If the tool exhibits excessive chatter, vibration, or movement, decrease the tool exposure.
- W27 Motors and attachments may fail due to extended use resulting in component(s) detaching and falling from the motor or attachment and may cause patient injury.
- W28 When using the MR8 non-DK variable exposure attachments, ensure that the attachment is still in the locked position after each adjustment of the tool exposure. Attempting to increase the tool exposure too far may result in the attachment accidentally being unlocked.
- W29 Remove MR8 footed attachments cautiously and slowly, as per instructions to avoid injury to the operator.
- W30 Excessive side loading could cause non-DK angled attachments to unlock accidentally from motor.
- W31 Place MR8 pneumatic finger controlled motor in Safe mode ("0") while not in use.
- W32 When not operating the motor, eliminate accidental foot control activation.
- W33 Do not use the MR8 system in the presence of flammable anesthetics to avoid potential ignition or explosion of gases.
- W34 Do not operate the MR8 system without eye protection.
- W35 Failure to properly secure the lubricant/diffuser or oil cartridge may cause injury to operator and/or operating room staff.
- W36 Do not use the pneumatic control unit to operate systems other than the Midas Rex devices.
- W37 You must ensure the adapter is fully threaded onto the regulator hose and that the adapter is fully threaded/connected to the corresponding wall outlet before operating the pneumatic system.
- W38 Do not attempt to use a motor that is leaking lubricant. MR8 motors which fail due to extended use and/or lubricant seal failure may allow foreign matter to migrate or emit from the tool collet end of the motor. Non-sterile fluid may leak into the surgical site. As a result, measures may be required to protect the patient from infection, per the physician's discretion.
- W39 Do not load more than one MR8 motor inside the instrument tray per sterilization cycle.
- W40 Do not wrap the rigid sterilization container.
- W41 The MR8 system operator should take appropriate measures in ensuring that sensitive anatomy is protected during drilling and use of the MR8 system.
- W42 Use the MR8 instrument tray and the rigid sterilization container for sterilizing the re-usable MR8 devices only.
- W43 Do not use the instrument tray and rigid sterilization container for cleaning or disinfection of the re-usable devices.
- W44 Do not use alkaline cleaning for the instrument tray or the rigid sterilization container.
- W45 Do not sterilize and supply for surgical use any device that is not visibly clean and free of particulates. If particulates are present, repeat reprocessing, starting with the **Preparation for Cleaning** step.
- W46 Use the instrument tray and the rigid sterilization container for sterilization only. The MR8 system devices must be cleaned separate from the trays.
- W47 Devices cannot be sterilized to an adequate Sterility Assurance Level (SAL) without prior cleaning and decontamination.

System hoses

- W48 Do not pinch, kink, obstruct, cut, tear, or step on the motor exhaust hose. This may cause the hose to burst, potentially injuring the patient or user.

Tools and disposable components

- W49 Tool flutes are sharp and may perforate surgical gloves. Tool stems may be grasped with a hemostat to aid in installation and removal. Use methods at the operative site to control bleeding that do not compromise patient safety during surgery.
- W50 Keep the cutting area of the tool away from fingers and loose clothing to prevent laceration of the user and cross-contamination through a compromised glove.
- W51 A tool's size and geometry may create excessive vibration at certain speeds. Increase or decrease the speed of the motor to prevent vibration. Change to a new tool to prevent unintended tissue damage.
- W52 Excessive noise from the tool when drilling close to the cochlea or ossicular chain may cause patient hearing damage.

- W53 Consult the cranial perforator manufacturer device labeling for the recommended speed specifications.
- W54 Tools with "L" identification are longer tools intended for light bone dissection. The increased tool head/stem configuration may affect dissection stability.
- W55 Dissecting tools are for **single-use only**. Do not attempt to sterilize them. The dissecting tools are packed sterile and not intended for repeat use. To prevent contamination, use only once.
- W56 Excessive pressure applied to a tool may cause tool fracture. Should a tool fracture in use, extreme care must be exercised to ensure that all the fragments of the tool are removed from the patient. Unremoved tool fragments may cause tissue damage to the patient.
- W57 Do not sterilize disposable devices. They are sterilized at the factory and are not intended for repeat use. To prevent contamination, use only once.
- W58 Do not use an accessory if its packaging is damaged or opened outside the sterile field. Sterility may be compromised if packaging is opened or damaged.
- W59 Do not use dull tools. Use of dull tools can reduce cutting effectiveness and can cause the motor temperature to increase.
- W60 Fluted tools are designed to be used in forward mode. Diamond tools may be used in forward or reverse modes.
- W61 Exposure of tool packaging to ambient light for extended periods of time may cause damage to packaging.

Pneumatic control unit

- W62 Do not carry pneumatic control unit by the N2 DISS pressure hose.
- W63 Do not disassemble equipment before gas pressure is released from the pneumatic control unit and associated hoses.

Cautions

- C1 When using a non-DK angled attachment, hold the motor assembly by the attachment so that the attachment does not inadvertently loosen from the motor.
- C2 Do not use a twist drill dissecting tool at an operating pressure over 80 psi (5.5 bar).
- C3 Use of a washer-disinfector for cleaning may cause a pre-mature degradation in performance.
- C4 Remove devices from instrument tray before placing into washer-disinfector and allow devices to drain. Orient devices in the washer-disinfector by following manufacturer recommendations.
- C5 Do not use low-temperature hydrogen peroxide gas plasma sterilization due to the lumen internal diameter and length restrictions.
- C6 Do not use low-temperature liquid peracetic acid sterilization due to immersion procedure.
- C7 Remove and discard accessories following local regulations for disposal of contaminated materials.
- C8 Do not use an MR8 motor without a lubricant/diffuser or oiler cartridge installed.
- C9 Do not use chlorine-based or corrosive cleaning agents such as bleach, lye, acetone, sodium hypochlorite or bleach, sodium hydroxide, formic acid, or solutions containing glutaraldehyde.
- C10 Do not use a lubricant/diffuser or oiler cartridge for more than one hour of drill time.
- C11 Do not reuse or attempt to refill a lubricant/diffuser or oiler cartridge. It is a single-use product.
- C12 Do not use a lubricant/diffuser or oiler cartridge if it appears to be damaged or if the inner foil seal is punctured.
- C13 Devices should be cleaned within 30 minutes (30:00) of use to limit fixation of contaminants.
- C14 Do not use ultrasonic cleaner. Review the washer-disinfector cautions before using this cleaning method.
- C15 Do not expose these devices to sterilization temperatures greater than 137°C (279°F). Exposure to temperatures greater than 137°C (279°F) may impact the performance of the device and also the efficacy of the sterilization cycle.
- C16 Because of the variability in cleaning efficiencies and sterilizer operating parameters, all given parameters (temperature, time, etcetera) should be validated by persons who have training and expertise in sterilization processes. Deviation from the recommended sterilization processes is at the risk of the user facility.

The Midas Rex MR8 pneumatic high-speed drill system

MR8 pneumatic high-speed system components

The MR8 pneumatic drill system is made of various system elements that work together as a system in order to resect, drill, or saw soft and hard tissue, bone, and biomaterials, and metals during various surgical procedures. The MR8 pneumatically powered, high-speed drill system consists of a choice of various pneumatic motors (pneumatic exhaust hose and the motor) equipped with a foot or finger controller, PCU, surgical dissecting tools, attachments to drive various surgical tools, and system accessories.

MR8 pneumatic motors

The MR8 system consists of pneumatic motors (Figures 1 - 2) which are high-speed, high-torque motors used to dissect bone and biomaterials. The MR8 system operates in a range from 80 to 120 psi. These motors are equipped with a foot or finger controller and various types of interchangeable attachments and dissecting tools. Each pneumatic motor has an integral exhaust hose. The exhaust hose connects the pneumatic motor to the pneumatic foot control and exhausts gas from the motor through a lubricant diffuser. Each MR8 motor has a lubricant/diffuser and oiler cartridge housing at the end of the exhaust hose. A regulator hose connects the foot controller to the gas supply source.

The MR8 pneumatic motors provide the power to operate disposable surgical dissecting tools, intended for use in various surgical procedures. These motors are designed to interface with a series of attachments and surgical dissecting tools utilizing a standard quick-connect and quick-disconnect locking and unlocking mechanism.

The MR8 pneumatic motors can be controlled either by using the foot pedal or through the finger control mechanism. The finger-controlled pneumatic motors operate in the same manner as the foot-controlled pneumatic motors. Pressing the finger control increases the speed and letting go of the finger control reduces the speed to a stop.

The MR8 pneumatic motors are reusable devices which are supplied non-sterile and require cleaning and sterilization prior to each surgical use.

Each MR8 motor has a lubricant/diffuser housing at the end of the motor hose.



Pneumatic control unit

The pneumatic control unit (Figure 3) provides variable speed motor control through a foot pedal. It also allows the user to switch between finger and foot control of the motor (if applicable).

Regulator

The regulator (Figure 4) controls the delivery pressure of compressed gas to the pneumatic control unit. The pressure gauges monitor cylinder pressure (right gauge) and delivery pressure (left gauge).

Note: Outlet pressure gauge accurate to +/- 12 psi.

Regulator hose

Connects from the gas source to the pneumatic control unit to deliver compressed gas.



MR8 pneumatic motor

Technical specifications

Table 1. MR8 pneumatic motor technical specifications

MR8 pneumatic motor (PM800)	
Size	Weight
Length: 9.49 cm (3.74 in) x Diameter: 2.08 cm (0.82 in)	123.34 grams

MR8 pneumatic touch motor

Notes:

- Conduct a system check by pressing the finger control to briefly run the motor and confirm proper function prior to any procedure.
- The MR8 pneumatic control unit is provided with a supply pressure gauge. The control unit has a handle for ease of re-positioning unit while on the floor or for carrying the unit. A hole is provided in the base of the control unit to hang on a wall hook. Port cover is attached to prevent debris ingress when a port is not in use.

The MR8 pneumatic touch motor functions exactly as the pneumatic motor that is controlled using the PCU but offers the operator an option to control the motor with a finger control mechanism. The MR8 pneumatic touch motor also offers the user an option to control the motor with the foot via a PCU.

Technical specifications

Table 2. MR8 pneumatic touch motor technical specifications

MR8 pneumatic touch motor (PM810)	
Size	Weight
Length: 11.07 cm (4.36 in) x Diameter: 2.08 cm (0.82 in)	147.24 grams

The Midas Rex MR8 pneumatic high-speed drill system

MR8 pneumatic connections and adapters

Warning: The adapter must be fully threaded onto the regulator hose and that the adapter is fully threaded or connected to the corresponding wall outlet before operating the pneumatic system.

N2 DISS to surgical tool air male SIS adapter gas source (Australia/New Zealand only)

The N2 DISS to surgical tool air male SIS adapter gas source (Figure 5) allows for the regulator hose to connect to AUS-SIS wall fittings for surgical tool air. The functioning of the N2 DISS to surgical tool air male SIS adapter gas source is intended for use in Australia and New Zealand only.

N2 DISS to male Schrader adapter

The N2 DISS to male Schrader adapter (Figure 6) allows for the regulator hose to be attached to a female Schrader in-house gas connection.

N2 DISS to male Schrader adapter (UK)

The N2 DISS to male Schrader adapter (Figure 7) allows for the pneumatic control unit's N2 DISS pressure hose connection to be attached to a female Schrader (UK) in-house gas connection.

N2 DISS to air DISS adapter

The N2 DISS to air DISS adapter (Figure 8) allows for the regulator hose to be attached to an Air DISS in- house gas connection.

N2 DISS to female Schrader adapter

The N2 DISS to female Schrader adapter (Figure 9) allows for the pneumatic control unit's N2 DISS pressure hose connection to be attached to a male Schrader in-house gas connection.

N2 DISS to surgical tool air male SIS adapter

The N2 DISS to surgical tool air male SIS adapter (Figure 10) allows for the pneumatic control unit's N2 DISS pressure hose connection to be attached to an AUS-SIS surgical tool air in-house gas connection.

N2 DISS to WF4 adapter

The N2 DISS to WF4 adapter (Figure 11) allows for the regulator hose to be attached to a Midas Rex safety valve regulator.



12

Pneumatic adapter diagram

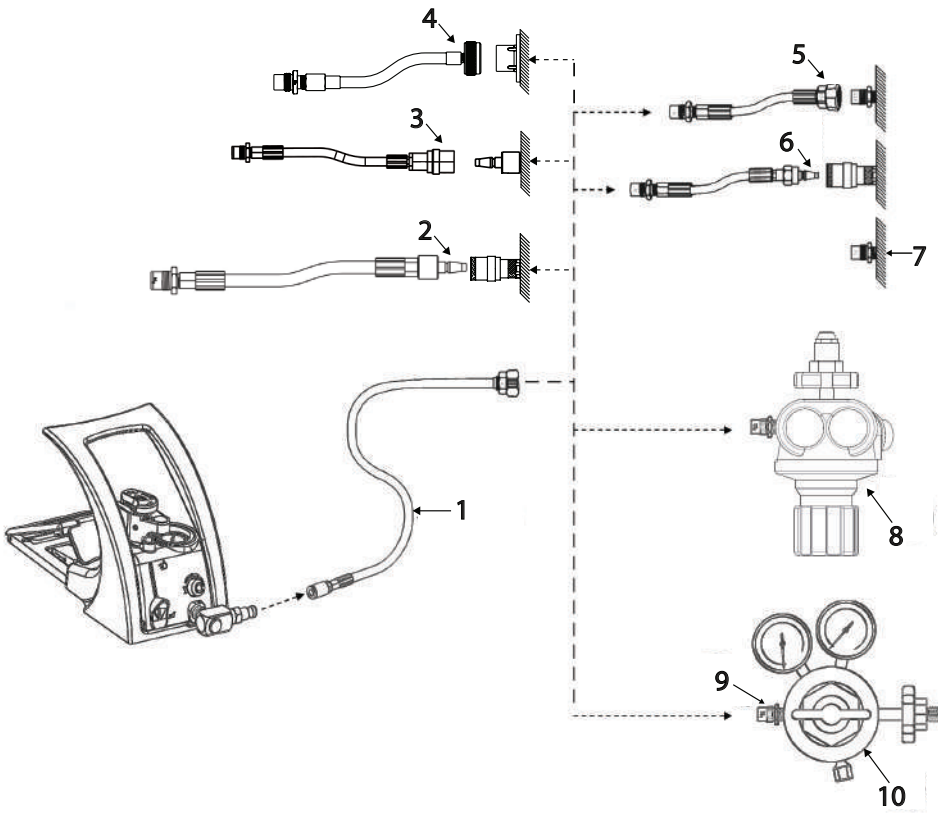

- 1. Regulator hose (N2 DISS)
- 2. N2 DISS to male Schrader adapter - UK gas source
- 3. N2 DISS to female Schrader adapter gas source
- 4. N2 DISS to surgical tool air male SIS adapter gas source (Australia/New Zealand only)
- 5. N2 DISS to air DISS adapter gas source
- 6. N2 DISS to male Schrader adapter gas source
- 7. Gas source (N2 DISS)
- 8. Regulator
- 9. DISS/WF4 adapter
- 10. Regulator

Operating (dynamic) pressure may be checked diagnostically at the MR8 pneumatic control unit while the motor is running. Operating pressure will decrease slightly from the non-running (static) pressure setting when the motor is activated. Adjust operating pressure as needed at the compressed gas source until supply pressure gauge on MR8 pneumatic control unit reads within a range of 80 – 120 psi (5.5 – 8.3 bar), as required.

To ensure optimal motor performance, set nominal operating pressure to 100 psi (6.9 bar). If the surgeon requests additional power during a procedure, compressed gas source may be turned up to an operating pressure of 120 psi (8.3 bar). To decrease pressure, turn down the in-house compressed gas source or loosen the pressure handle on the regulator. Push down on the pressure relief at the pneumatic control unit to exhaust excess pressure.

Operating room set up

Power source requirements.

Table 3. MR8 pneumatic motors required operating pressure

Required operating (dynamic) pressure	Nominal operating (dynamic) pressure	Approximate flow rate required	Gas type
80-120 psi	100 psi	12 cubic feet/minute	Nitrogen or dry-filtered compressed air
5.5-8.3 bar	6.9 bar	340 liters/minute	

Caution: Do not run the motor at an operating pressure above or below the required operating pressure range. Operating pressure below 80 psi (5.5 bar) may not provide proper lubrication to the motor. Operating pressure above 120 psi (8.3 bar) may damage or reduce the life of the motor.

System set up

Warnings:

- Failure to properly secure the lubricant diffuser or oiler cartridge may cause injury to operator or operating room staff.
- Do not attempt to remove the lubricant diffuser or oiler cartridge while the system is pressurized.

Cautions:

- Do not use the MR8 pneumatic motor without a lubricant diffuser or oiler cartridge installed.
- Do not use a lubricant diffuser or oiler cartridge for more than one hour of drill time.
- Do not reuse a lubricant diffuser or oiler cartridge. It is a single-use product.
- Do not attempt to refill a used lubricant diffuser or oiler cartridge.
- Do not use a lubricant diffuser or oiler cartridge if it appears to be damaged or if the inner foil seal is punctured.

Note: Each MR8 motor has a lubricant diffuser and oiler cartridge housing at the end of the exhaust hose.

Install the oiler cartridge within the non-sterile field

1. Set the non-running (static) pressure to 80 – 120 psi (5.5 – 8.3 bar) at the gas source. Operating (dynamic) pressure may be adjusted later.
2. Hold the oiler cartridge perpendicular to the housing (Figure 13-1) and press the cartridge's circular fitting onto the housing's circular receptacle (Figure 13-2), breaking the foil seal.
3. Rotate the cartridge down until it clicks into place and is secured onto the oiler stem end of the motor hose.
4. Verify that the lock symbol on the cartridge is lined up with the notch on the housing (Figure 13-3).

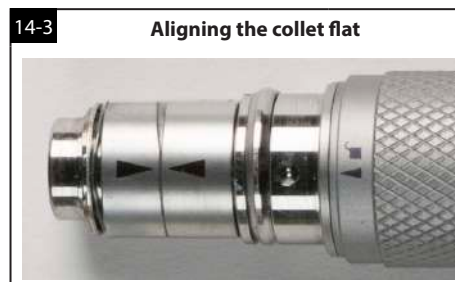
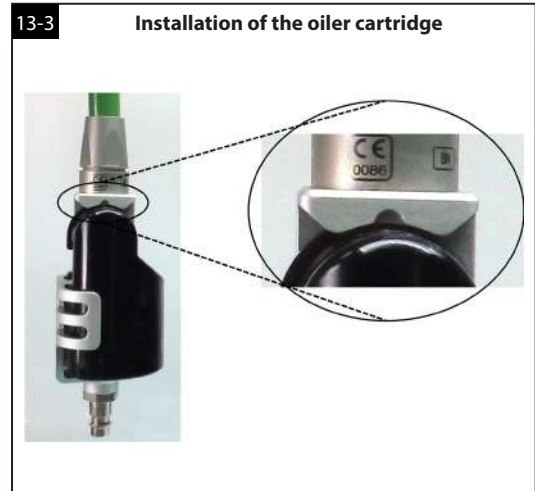

Connect the motor

Connect the motor hose to the motor port on the top of the pneumatic control unit, by swinging the port cover to the side and pressing the end of the hose into the port (Figure 14-1).

Warnings:

- Do not pinch, kink, obstruct, cut, tear, or step on the motor/exhaust hose. This may cause the hose to burst, potentially injuring the patient or user.
- To avoid injury to the patient or user, do not use the pneumatic control unit to operate systems other than the MR8, Legend, and Triton systems.
- Prior to installation of a MR8 attachment and dissecting tool, ensure that the arrows on the motor collet flats are aligned (Figure 14-3). If the arrows are not aligned, use the motor wrench to turn the collet flat closest to the motor case until its arrow is aligned with the arrow on the other collet flat.
- To avoid injury when using the MR8 touch motor, ensure the motor safe mode switch is in the "O" position before installing the attachment and tool.

Notes:

- If using the MR8 touch motor, slide the control slide on the pneumatic control unit to the "On" position (Figure 14-2). This will automatically depress and lock the foot pedal. The control will not lock into the "On" position unless the motor hose is connected into the motor port. When the motor hose is removed from the motor port, the foot pedal will return to normal position.

Activate the motor

Notes:

- To decrease pressure, turn down the in-house compressed gas source or loosen the pressure handle on the regulator. Push down on the pressure relief at the pneumatic control unit to exhaust excess pressure in the hoses. Then readjust pressure as needed.
 - In order to activate the MR8 pneumatic touch motor, the motor safe mode switch on the finger control switch must be in the "On" position and the control slide on the foot control must be in the "Off" position. The control slide will not lock in the position unless a motor is connected to the motor port.
1. Activate the motor by pressing on the PCU pedal (Figure 15) or by pressing on the finger control lever (MR8 pneumatic touch motor only).
 2. Adjust operating pressure as needed at the compressed gas source until supply pressure gauge on pneumatic control unit reads within a range of 80–120 psi (5.5–8.3 bar) as required. Operating pressure (with motor running) will decrease slightly from the non-running (static) pressure setting when the motor is activated.

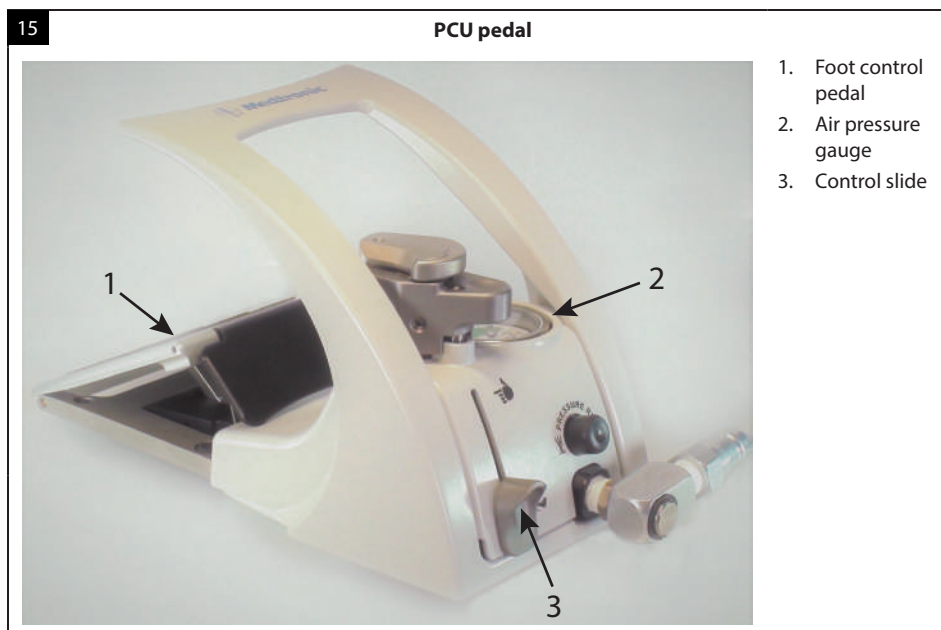

MR8 surgical dissecting tools

The MR8 surgical dissecting tools (Figure 14) are designed and intended to resect, drill, or saw soft and hard tissue, bone, biomaterials, and metals during various surgical procedures. Angled, metal cutting and telescoping attachments feature a tool lock mechanism that secures tool in the attachment. For other attachments, the tool is locked in the motor collet at the same time as the attachment is locked on the motor.

All MR8 surgical dissecting tools are similarly constructed in that they have a dissecting tip (head) of various shapes and are provided in various lengths and geometries for different surgical needs. The head designs of the surgical dissecting tools include the following universal shapes: match head, ball or round, oval, hole maker, hole saw, cylinder, acorn, tapered or side cutting, twist drill, metal cutter, and reverse tapered. Tool heads may be fluted or diamond coated.

Assembly

Refer to the applicable attachment assembly instructions in this Instructions for Use for details on the assembly of an attachment to a motor.

Tool nomenclature

Part numbers for MR8 surgical dissecting tools follow a nomenclature, which is described in the diagram below (Figure 17). Standard tool part numbers consist of the associated attachment length, the tool family identifier, and the tool head diameter. Part numbers may also include a variety of prefixes to identify specific attachment types, as well as a variety of suffixes to provide additional information about the dissecting tool.

Note: The surgical tools are designed and labeled for single-use only. The tools are supplied Gamma sterilized, in sealed packaging.

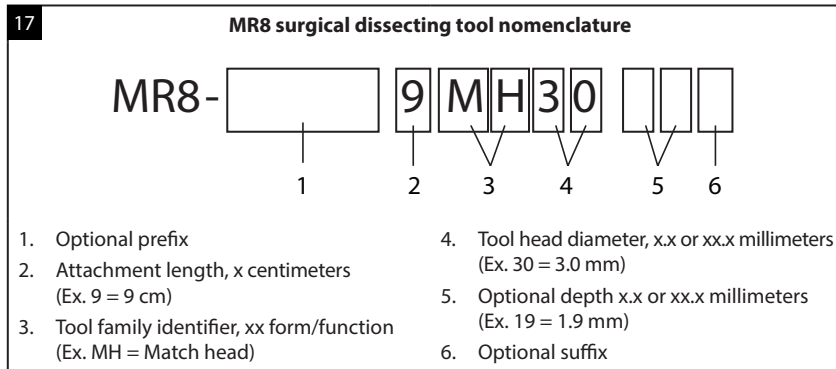

Tool number prefixes

Note: A single part number will use only one prefix.

Prefix	Tool attachments
F	Footed attachments
T	Telescoping tube







Tool family identifier (form/function)

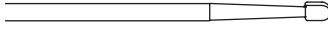
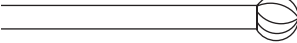

AC	Acorn
BA	Ball
CY	Cylinder
HM	Hole maker
HS	Hole saw
MC	Metal cutter
MH	Match head
OV	Oval
RT	Reverse taper
TA	Tapered or side cutter
TD	Twist drill

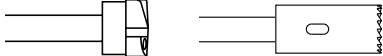

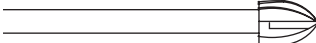
Tool number suffixes

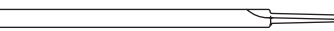
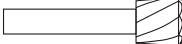
Note: More than one suffix may be combined in a single part number.

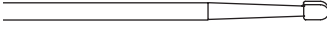
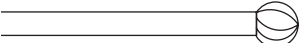
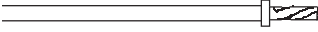
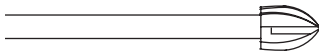
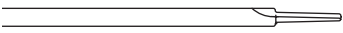
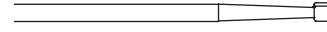
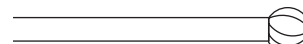
Suffix	Tool head cutting modifiers
B	Ball
BR	Barrel
C	Carbide
CS	Cornerstone
D	Diamond
DC	Diamond coarse
DF	Diamond fine
DX	Diamond extra coarse
DXF	Diamond extra fine
F	Fine
M	Match flute (on telescoping tools)
S	Spiral flutes
T	3-Flute or symmeTRI
X	Extra
XF	Extra fine
Tool length modifiers	
L	Long

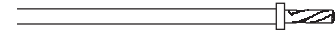
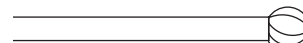
Surgical application	Commonly used attachments	Commonly used dissecting tools
Spine	MR8 9, MR8 14, and MR8 15	<p>Match head </p> <p>Elongated spherical design allows controlled, delicate dissection. For entry hole, nerve decompression, osteophyte removal, sinus dissection, etcetera.</p>
		<p>Ball </p> <p>Helical cutting flutes dissect bone or cement effectively from a wide variety of approach angles. For debridement, decortication, sinus dissection, etcetera.</p>
		<p>Oval </p> <p>Helical cutting flutes and curved design blend acorn and ball styles to vary dissection efficiency with approach angle. For decortication, laminotomy, entry hole, nerve decompression, osteophyte removal, etcetera.</p>
		<p>Hole maker and hole saw </p> <p>Matched sets of hole makers and hole saws are efficient and effective for interbody fusion.</p>
		<p>Cylinder </p> <p>Effective bone sculpting and planing. For graft shaping, debridement, corpectomy, decortication, interbody fusion, fusion takedown, etcetera.</p>
Spine	MR8 telescoping	<p>Acorn </p> <p>Curved design varies dissection efficiency with varied approach angles. For entry hole, laminotomy, bone shaping, debridement, corpectomy, decortication, fusion takedown, etcetera.</p>
		<p>Match head </p> <p>Elongated spherical design allows controlled, delicate dissection. For entry hole, nerve decompression, osteophyte removal, sinus dissection, etcetera.</p>
Spine	MR8 footed, MR8 straight	<p>Tapered </p> <p>Slender design for precise dissection with minimal bone loss. For transection, osteotomy, graft harvesting, bone shaping, entry hole, suture hole, midface advancement, etcetera.</p>
		<p>Reverse tapered </p> <p>Semi-trapezoidal shape with helical cutting flutes and a smooth cutting tip designed for efficient bone sculpting and planing. For graft shaping, debridement, and decortication.</p>

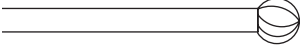
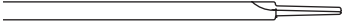
Surgical application	Commonly used attachments	Commonly used dissecting tools
Neurosurgical–cranial	MR8 7, MR8 9, MR8 10, MR8 14, and MR8 15	<p>Match head  Elongated spherical design allows controlled, delicate dissection. For entry hole, nerve decompression, osteophyte removal, sinus dissection, etcetera.</p> <p>Ball  Helical cutting flutes dissect bone or cement effectively from a wide variety of approach angles. For debridement, decortication, sinus dissection, etcetera.</p> <p>Twist drill  Helical design with stop produces a hole with a precise depth. Ideal for plating.</p> <p>Acorn  Curved design varies dissection efficiency with varied approach angles. For entry hole, laminotomy, bone shaping, debridement, corpectomy, decortication, fusion takedown, etcetera.</p> <p>Tapered  Slender design for precise dissection with minimal bone loss. For transection, osteotomy, graft harvesting, bone shaping, entry hole, suture hole, midface advancement, etcetera.</p>
General surgery and plastic surgery (craniofacial/ maxillofacial/ sternotomy)	MR8 7, MR8 9, MR8 10, and MR8 14	<p>Match head  Elongated spherical design allows controlled, delicate dissection. For entry hole, nerve decompression, osteophyte removal, sinus dissection, etcetera.</p> <p>Ball  Helical cutting flutes dissect bone or cement effectively from a wide variety of approach angles. For debridement, decortication, sinus dissection, etcetera.</p> <p>Tapered  Slender design for precise dissection with minimal bone loss. For transection, osteotomy, graft harvesting, bone shaping, entry hole, suture hole, midface advancement, etcetera.</p> <p>Twist drill  Helical design with stop produces a hole with a precise depth. Ideal for plating.</p>
Ear, nose, and throat (otology, neurotology)	MR8 7, MR8 10	<p>Ball  Helical cutting flutes dissect bone or cement effectively from a wide variety of approach angles. For debridement, decortication, sinus dissection, etcetera.</p>

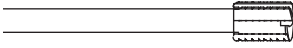
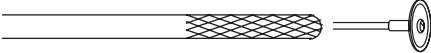
Surgical application	Commonly used attachments	Commonly used dissecting tools
Orthopaedics	MR8 9, MR8 14, MR8 21, MR8 26, MR8 footed, and MR8 telescoping	<p>Ball  Helical cutting flutes dissect bone or cement effectively from a wide variety of approach angles. For debridement, decortication, sinus dissection, etcetera.</p> <p>Tapered  Slender design for precise dissection with minimal bone loss. For transection, osteotomy, graft harvesting, bone shaping, entry hole, suture hole, midface advancement, etcetera.</p> <p>Acorn  Curved design varies dissection efficiency with varied approach angles. For entry hole, laminotomy, bone shaping, debridement, corpectomy, decortication, fusion takedown, etcetera.</p> <p>Cylinder  Effective bone sculpting and planing. For graft shaping, debridement, corpectomy, decortication, interbody fusion, fusion takedown, etcetera.</p>
Biometals/bioceramics/ biomaterials	MR8 MC9, MR8 MC14	<p>Metal cutter  Cutting flutes or diamond wheel design remove metals, ceramics and other biomaterials effectively from a variety of approach angles. For cutting rods, pins, plates, implants, screws, etcetera.</p>

MR8 attachments

Note: To assemble DK attachments, follow the instructions for the respective attachment. To disassemble DK attachments, push the attachment distally before rotating. The attachments provide support and stability to the rotating surgical tools during use in various surgical procedures. The attachments are reusable devices, supplied non-sterile, and require cleaning and sterilization prior to each surgical use. Attachments feature a tool lock mechanism that secures and aligns the tool to the attachment. Arrow icons (Figure 18-1) are etched onto attachments and motors to guide the user to lock (Figure 18-2) or unlock (Figure 18-3) the attachment from the motor.

MR8 attachments are available in various designs, lengths, and diameters to facilitate a variety of surgical procedures. The attachments family includes a variety of MR8 standard attachments, fixed and rotating footed (craniotomes), telescoping, and specialty attachments (metal cutters, Jacobs chuck, J-latch, and perforator attachments). MR8 standard attachments consist of straight and angled configurations, which are offered either as fixed or variable exposure. The availability of the Medtronic attachments allows the surgeon flexibility to choose the appropriate length and style for each type of surgical procedure, including minimal access surgeries. They are marked and color-coded to correspond with their associated dissecting tools. Angled and straight attachments with the same length, marking, and color band share the same dissecting tool. Telescoping tubes with the same length, marking, and color band also share the same dissecting tool.



The Midas Rex MR8 pneumatic high-speed drill system

Straight attachments

Warnings:

- The MR8 motors do not run at all, if not locked.
- Use only dissecting tools specifically designed for use with this drill system. Match the nomenclature and color code on the MR8 dissecting tool packaging to the same nomenclature and color band on the MR8 attachment.

Note: An attachment will not seat on the motor if the arrows on the collet flats are not in proper alignment.

Assembly:

1. Slide a straight attachment over the motor collet aligning the triangular arrows on the attachment and the motor case (Figure 19-1). An audible click, heard and perceptible by touch, confirms that the attachment is fully seated.
2. Insert the tool into the attachment with a slight rotational motion (Figure 19-2). An audible click, heard and perceptible by touch, confirms that the tool is fully seated.
3. Rotate the attachment in the direction indicated by arrow on the attachment until the attachment alignment mark is directly in line with the locked symbol (Figure 19-3).
Note: When a click is heard the attachment is fully seated and the collet brake fully released.
4. Gently pull on the tool to ensure that it is locked into the motor.
Note: Tool should rotate freely. If not, unlock the attachment, re-seat the tool, and re-lock the attachment.

Disassembly

1. Hold the motor in palm of hand. Rotate the attachment to the unlocked position. In this position, the arrows in the attachment and motor will line up as in Figure 19-2.
2. Pull the dissecting tool from the attachment and discard the tool.
3. Use thumb and index finger to lift the attachment off of the motor.

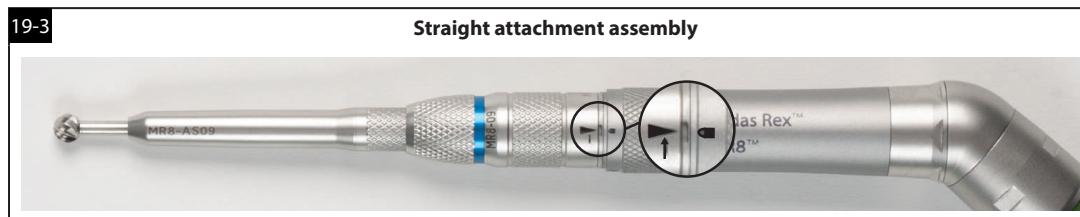
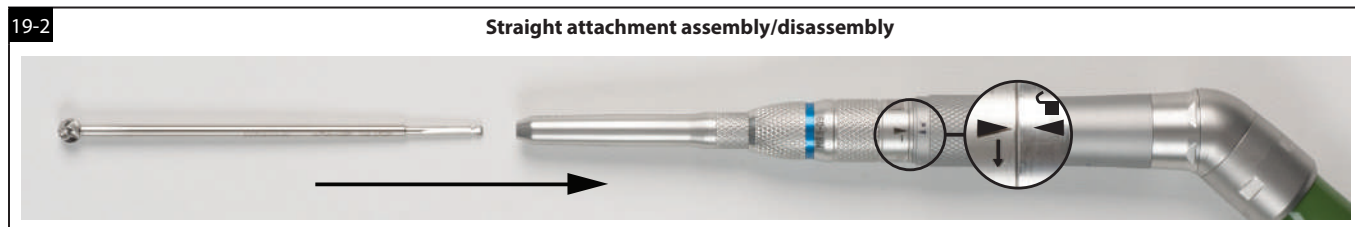
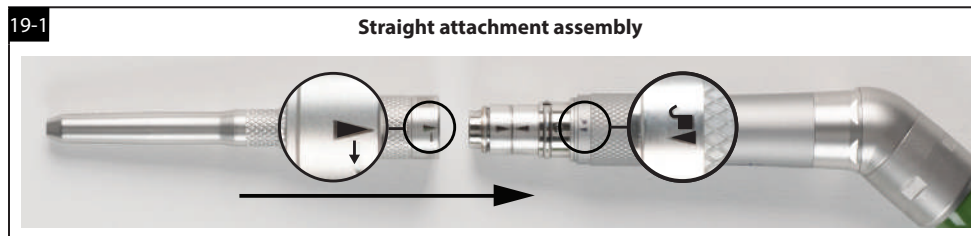

Angled attachments

Warnings:

- The MR8 motors do not run at all, if not locked.
- Use only dissecting tools specifically designed for use with this drill system. Match the nomenclature and color code on the MR8 dissecting tool packaging to the same nomenclature and color band on the MR8 attachment.

Notes:

- An attachment will not seat on the motor if the arrows on the collet flats are not in proper alignment.
- To assemble DK attachments, follow the instructions for the respective attachment. To disassemble DK attachments, pull the attachment distally before rotating.
- A dissecting tool may be installed and locked in the attachment before the angled attachment is installed onto the motor.
- Angled and straight attachments with the same length, marking, and color band share the same dissecting tools.

Assembly

1. With the tool lock in the unlocked position, insert a tool into the angled attachment with a slight rotational motion (Figure 20-1). An audible click, heard and perceptible by touch, confirms that the tool is fully seated.
2. Rotate the tool lock/unlock sleeve in the direction indicated by arrow until the tool lock alignment mark is directly in line with the locked symbol (Figure 20-2).
3. Gently pull on the tool to ensure that it is locked into the motor.
Note: Tool should rotate freely. If not, unlock the attachment, re-seat the tool, and re-lock the attachment.
4. Slide the angled attachment over the motor collet aligning the triangular arrows on the attachment and the motor case. An audible click, heard and perceptible by touch, confirms that the attachment is fully seated.
5. Rotate the attachment in the direction indicated by the arrow until attachment alignment mark is directly in line with the locked symbol.
Note: When a click is heard the attachment is fully seated and the collet brake fully released.
6. Verify that both the attachment to motor alignment mark and the tool lock alignment mark are directly in line with the locked symbols (Figure 20-3).

Disassembly

1. Rotate the tool lock to the unlocked position to remove the tool from the attachment.
2. Rotate the attachment to the unlocked position and lift attachment off of the motor.

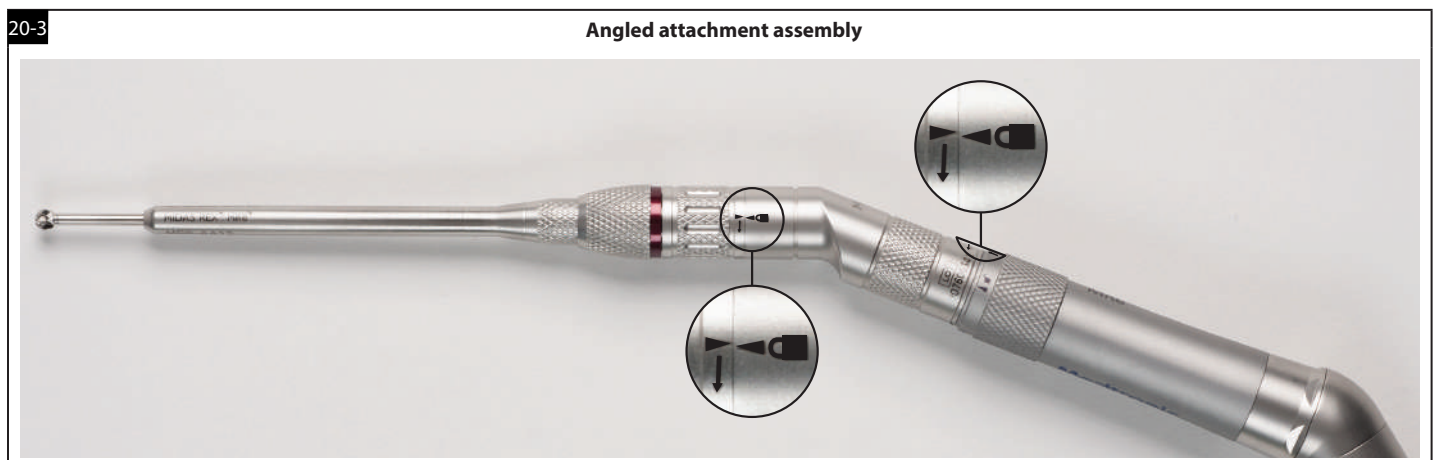
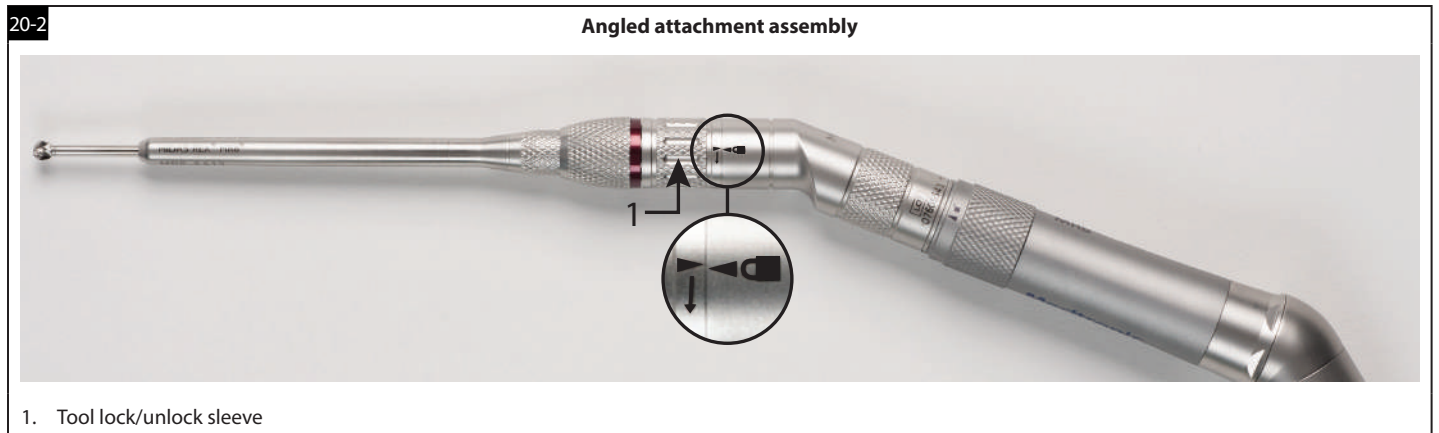
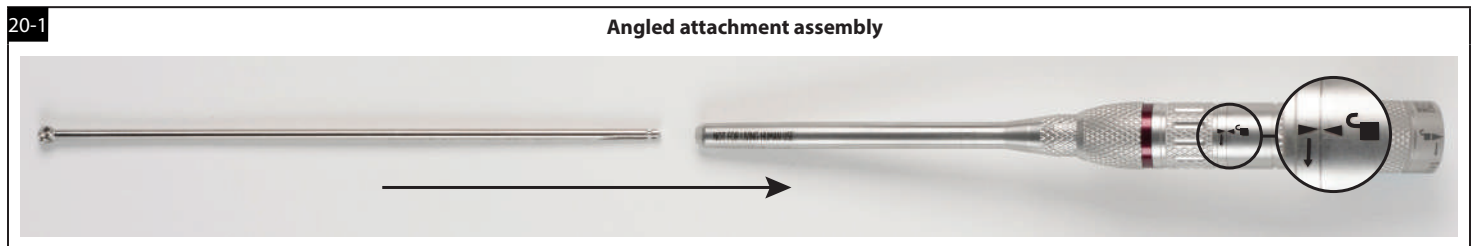

The Midas Rex MR8 pneumatic high-speed drill system

Variable exposure straight and angled attachments

The variable exposure attachments allow the user to vary the exposure of the tool by adjusting the attachment tube. Match the color band on the attachment to the color code on the dissecting tool packaging.

Warning: Surgeons should familiarize themselves with the performance of dissecting tools before use and should explore the effect of various levels of tool exposure on dissection stability. If the tool exhibits excessive chatter, vibration, or movement, decrease the tool exposure.

Notes:

- For fixed and variable straight attachments, the tool is locked in the motor collet. On fixed and variable angled attachments, the tool is locked in the attachment collet.
- There is a rotatable dial on the MR8 variable exposure attachment, not included on the fixed attachment.
- Dissecting tool size and geometry may contribute to excessive vibration at certain speeds. Increase or decrease speed by adjusting the foot or finger control, or by changing the console speed setting. If necessary, use a different dissecting tool.
- Do not use the variable exposure attachment if the tube adjustment dial spins freely or fails to click into place with each adjustment, as the exposure may change without warning.
- Do not use the end of the tube as a depth gauge or depth stop.
- Make sure that the tool and attachment are still locked after making any adjustments to the tool exposure on variable exposure attachments. If the attachment is unlocked, the system will not function. If the tool is unlocked, it can cause reduced speed and overheating.

Assembly:

1. Assemble the variable exposure straight attachment using the **Straight attachments Assembly** instructions and the variable exposure angled attachments using the **Angled attachments Assembly** instructions.
2. After assembly, use the tube adjustment ring to adjust the exposure of the dissecting tool (Figure 21). With the tool pointing away from you, turn the ring to the right to increase the length of the tube, thereby decreasing the exposure of the tool. Turn the ring to the left to decrease the length of the tube, thereby increasing the exposure of the tool.

Disassembly:

Remove the variable exposure straight attachment using the **Straight attachments Disassembly** instructions and the variable exposure angled attachments using the **Angled attachments Disassembly** instructions.

21

Variable exposure attachment assembly



Angled double lock (DK) attachment

Notes:

- Angled attachments with the same length, marking, and color band share the same dissecting tools.
- You can insert and lock a tool in the attachment before the angled attachment is installed on the motor.

Assembly:

1. Assemble the attachment onto the motor using the **Angled attachments Assembly** instructions.
2. Insert the tool into the attachment with a slight rotational motion. An audible click, perceptible by touch, confirms that the tool is fully seated (Figure 22-1).
3. Rotate the tool lock in direction indicated by arrow until the tool lock alignment mark is directly in line with the locked symbol (Figure 22-2).

Note: Pull on the tool to ensure that it is secured in the attachment.

4. The tool should rotate freely. If not, unlock the attachment, re-seat the tool, and re-lock the attachment.
5. Verify that both the attachment to motor and the tool-lock alignment mark is directly in line with the corresponding locked symbol.



Disassembly:

1. To remove the attachment, hold the motor in the palm of your hand, and push the attachment distally while turning the attachment to the unlocked position (Figure 22-3).
2. Release and remove the attachment.

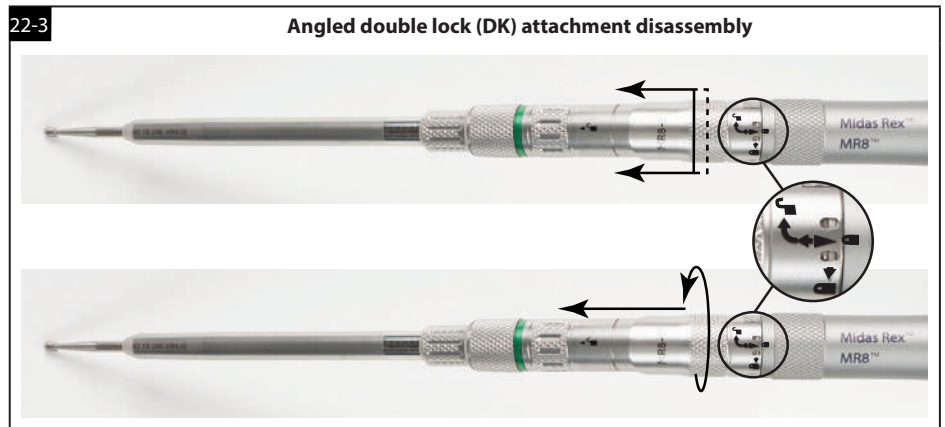

The Midas Rex MR8 pneumatic high-speed drill system

Fixed footed attachments

Warning: Use only dissecting tools specifically designed for use with this drill system. Match the nomenclature and color code on the MR8 dissecting tool packaging to the same nomenclature and color band on the MR8 attachment.

Notes:

- Ensure proper installation of tool in footed attachment. Failure to follow instructions may result in the tool tip contacting the foot of the attachment causing damage to the attachment and/or harm to patient.
- To avoid injury from the dissecting tool, use thumb and index finger to cautiously and slowly lift the attachment off of the motor and away from the dissecting tool.

Assembly

1. Insert a dissecting tool into the motor collet with a slight rotational motion (Figure 23-1). An audible click, heard and perceptible by touch, confirms that the tool is fully seated.
2. Slide the fixed footed attachment over the dissecting tool onto the motor aligning triangular arrows on the attachment and the motor case (Figure 23-2).
3. Pull the fixed footed attachment towards the motor and rotate the attachment to the locked position on the motor case (Figure 23-3).
4. Check to ensure a gap exists between the tip of the tool and the foot of the attachment as shown in Figure 23-4. This will prevent damage to the attachment and/or injury to patient.

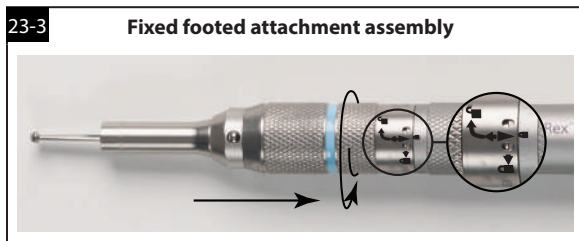
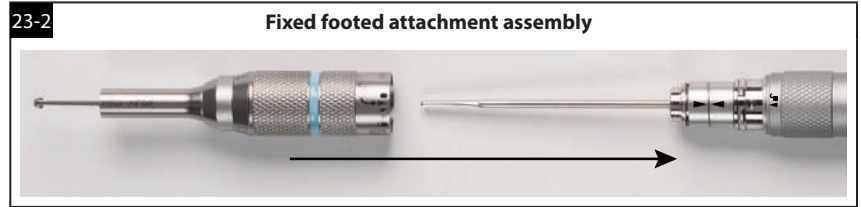

Disassembly

1. To remove the fixed footed attachment, hold the motor in the palm of your hand. Push the fixed footed attachment distally while rotating the attachment to the unlocked position on the motor case and then release the sleeve (Figure 23-5).
2. To avoid injury from the dissecting tool, use thumb and index finger to cautiously and slowly lift the attachment off of the motor and away from the dissecting tool (Figure 23-6).
3. Pull the dissecting tool out of the motor collet and discard the tool (Figure 23-7).

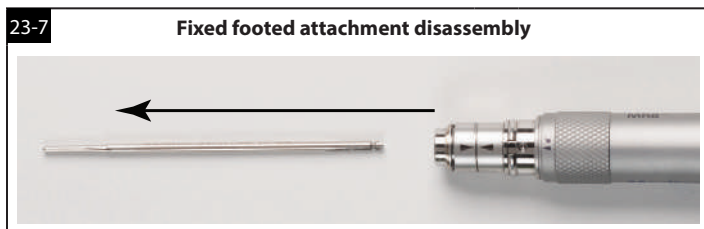
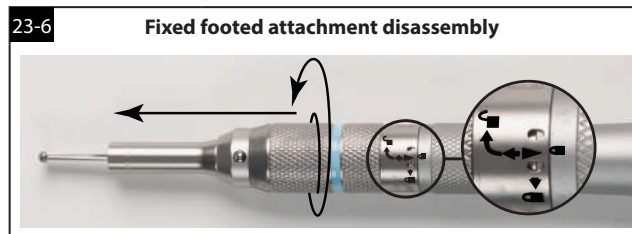
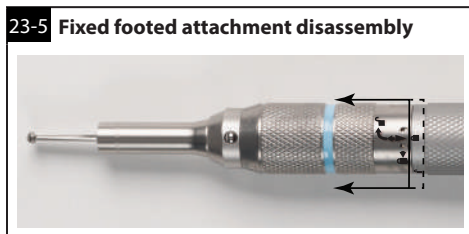

Rotating footed attachments

Notes:

- Rotating and fixed footed attachments with the same length, marking and color band share the same dissecting tools.
- The footed end of the attachment has 360° of unrestricted rotation.
- Ensure proper installation of tool in footed attachment. Failure to follow instructions may result in the tool tip contacting the foot of the attachment causing damage to the attachment and/or harm to patient.
- To avoid injury from the dissecting tool, use thumb and index finger to cautiously and slowly lift the attachment off of the motor and away from the dissecting tool.

Assembly:

1. Insert a dissecting tool into the motor collet with a slight rotational motion (Figure 24-1). An audible click, heard and perceptible by touch, confirms that the tool is fully seated.
2. Slide the rotating footed attachment over the dissecting tool onto the motor aligning triangular arrows on the attachment and the motor case (Figure 24-2).
3. Pull the rotating footed attachment towards the motor and rotate the attachment to the locked position on the motor case (Figure 24-3).
4. Check to ensure a gap exists between the tip of the tool and the foot of the attachment as shown in Figure 24-4. This will prevent damage to the attachment and/or injury to patient.

Disassembly:

1. Hold the motor in palm of hand. Rotate the attachment to the unlocked position. In this position, the arrows in the attachment and motor will line up.
2. Use thumb and index finger to lift the attachment off of the motor.
3. Remove the dissecting tool from the motor collet and discard the tool.

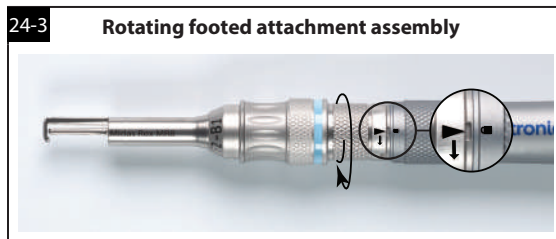
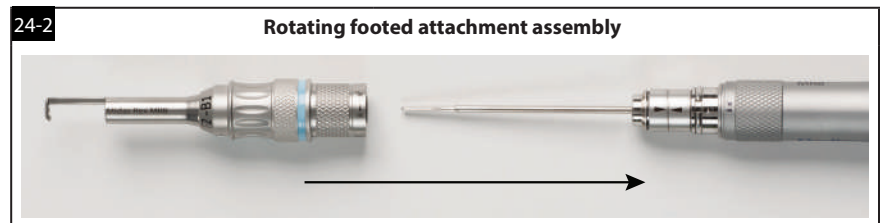

The Midas Rex MR8 pneumatic high-speed drill system

Metal cutting attachments

Warnings:

- Do not use metal cutting dissecting tools on bone.
- For metal transection, observe the following safety guidelines:
 - a. Wear eye protection.
 - b. Irrigate well to cool the cutting surfaces.
 - c. Protect the wound site from metal debris.
 - d. Use a clamp or grasping device to control loose fragments during transection of any metal component.
- Use only dissecting tools specifically designed for use with this drill system. Match the nomenclature and color code on the MR8 dissecting tool packaging to the same nomenclature and color band on the MR8 attachment.

Notes:

- The metal cutting attachments use the tungsten carbide or diamond wheel dissecting tools.
- A dissecting tool may be installed and locked in the attachment before the metal cutting attachment is installed on the motor.
- The Legend system metal cutter dissecting tool can be used with the MR8-ASMC9 attachment. Match the color code on the metal cutter Legend dissecting tool packaging to the same color band on the MR8 attachment.

All metal cutting dissecting tools have an "MC" attachment prefix in their nomenclature (for example MR8-9MC30). Metal cutting dissecting tools should not be installed into other attachments.

The MR8 metal cutting attachments come in a double locking (DK) configuration.

Assembly:

1. Slide the metal cutting attachment over the motor collet aligning triangular marks on the attachment and the motor case. An audible click, heard and perceptible by touch, confirms that the attachment is fully seated.
2. Rotate the attachment to the locked position on the motor case.
3. To insert the tool, make sure that the tool locking ring is in the unlocked position, and insert the dissecting tool into the top of the tube (Figure 25).
4. Rotate the dissecting tool until it drops into position and is fully seated (Figure 25).
5. Rotate the tool locking ring to the locked position. Gently pull on the shaft of the dissecting tool to verify proper installation.

Disassembly:

1. Rotate the tool locking ring to the unlocked position. Pull the dissecting tool from the attachment.
2. Discard the tool.
3. Push the attachment distally, then rotate the attachment to the unlocked position on the motor case and lift the attachment off the motor.

25

Metal cutting attachment



Telescoping attachments and tubes

Telescoping attachments provide support to the rotating dissecting tool. Telescoping tubes are disposable following multiple uses and should be discarded when heat or excessive vibration is noticed or insertion of tools becomes difficult. Telescoping attachment MR8-AT10ADK is provided in a double locking (DK) configuration. The straight telescoping attachment (MR8-AT10) is available in both a DK and non-DK configuration.

Warnings: Use only dissecting tools specifically designed for use with this drill system. Match the nomenclature and color code on the MR8 dissecting tool packaging to the same nomenclature and color band on the MR8 attachment.

Notes:

- To assemble DK attachments, follow the instructions for the respective attachment. To disassemble DK attachments, push the attachment distally before rotating.
- The Legend system 12 cm, 14 cm, 15 cm, and 18 cm telescoping tubes and dissecting tools can be used with the MR8 system. Match the color code on the telescoping Legend dissecting tool packaging to the same color band on the MR8 telescoping tube.

Assembly

1. Slide the attachment over the motor collet aligning the triangular markers. A tactile click confirms the attachment is fully seated.

Note: A dissecting tool and telescoping tube may be installed and locked in the attachment before the telescoping attachment is installed on the motor.
2. Rotate the attachment to the locked position.
3. Rotate the tube locking ring toward the unlocked icon (Figure 26-1).
4. Insert the base of the telescoping tube into the attachment (Figure 26-2).
5. To lock the tube in place, rotate the tube locking ring towards the locked icon. Verify that the tube is secure by gently pulling on the tube. Do not over tighten the tube locking ring.
6. To insert the tool, make sure that the tool locking ring is in the unlocked position, and insert the dissecting tool into the top of the tube (Figure 26-3). A tactile click confirms that the tool is fully seated.
7. Rotate the tool locking ring to the locked position. Gently pull on the shaft of the dissecting tool to verify proper installation (Figure 26-4).
8. If the tube position needs to be changed, rotate the tube locking ring toward the unlocked icon and reposition the tube. Then, rotate the tube locking ring toward the locked icon.

Disassembly

1. To remove the attachment, rotate the tool locking ring and the tube locking ring to the unlocked position, and pull the telescoping tube and tool out of the attachment.
2. Rotate the attachment to the unlocked position and lift the attachment off the motor.

Note: Telescoping tubes should be discarded when heat or excessive vibration is noticed, or when insertion of the tool becomes difficult.

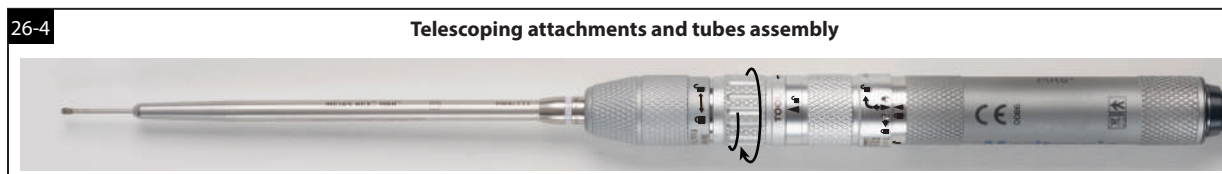
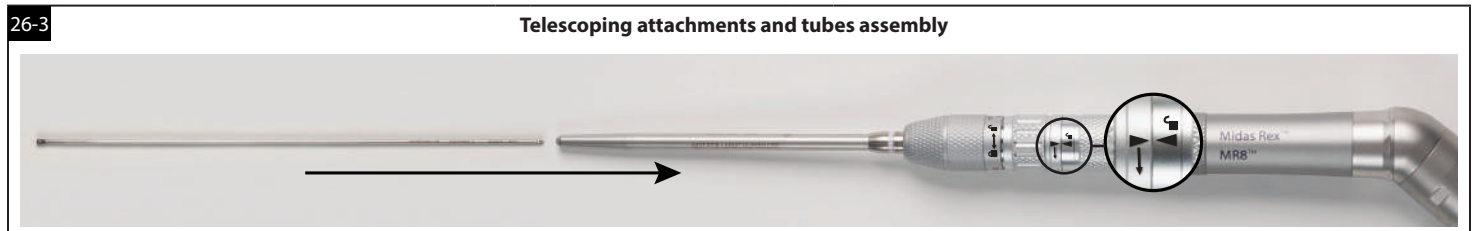
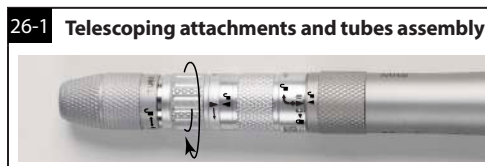

The Midas Rex MR8 pneumatic high-speed drill system

Perforator driver attachment

The perforator attachment has a Hudson chuck to drive any device with a Hudson shank (for example: the cranial perforator device).

Warning: Consult the cranial perforator device labeling for the recommended speed specifications.

Note: A cranial perforator device may be installed in the attachment before the attachment is installed on the motor.

Assembly

1. Slide the perforator driver over the motor collet, aligning the triangular markers (Figure 27-1). A tactile click confirms the attachment is fully seated.
2. Rotate the attachment to the locked position (Figure 27-2).
3. To install a cranial perforator device with a Hudson shank, pull back on the collar of the attachment (Figure 27-3).
4. Insert the device into the attachment with a slight rotational motion and release the collar.
5. The speeds achievable by the MR8-AD03 attachments are provided in Table 4.

Disassembly

1. Pull back proximally on the collar of the perforator attachment and then remove the cranial perforator device.
2. Rotate the perforator attachment to the unlocked position and lift the attachment off of the motor.

Gas pressure (dynamic)	MR8-AD03
80 psi	850 rpm
100 psi	1050 rpm
120 psi	1140 rpm

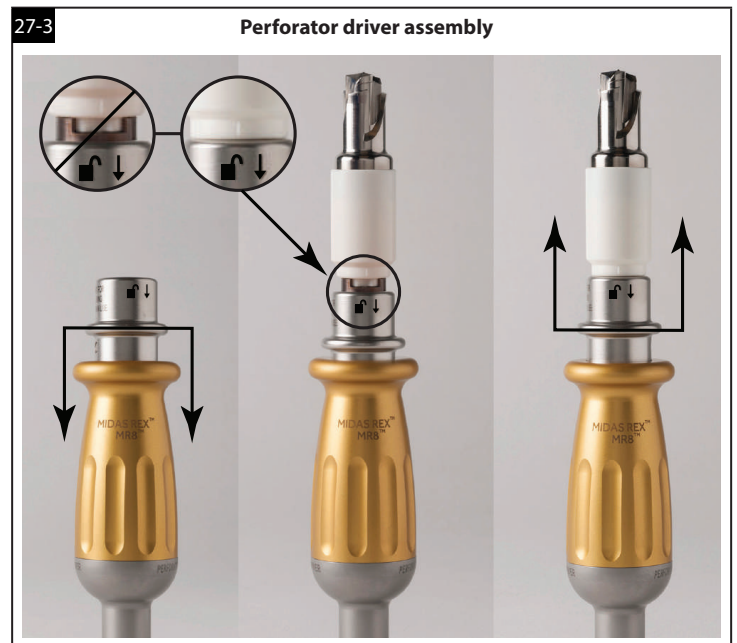

Jacobs chuck attachment

The Jacobs chuck attachment is a non-cannulated, 5/32" chuck with key for drilling.

Note: A drill bit may be installed in the attachment before the Jacobs chuck attachment is installed on the motor.

Assembly

1. Slide the attachment over the motor collet aligning the triangular markers (Figure 28-1). A tactile click confirms that the attachment is fully seated.
2. Rotate the attachment to the locked position (Figure 28-2).
3. To install a drill bit, rotate the Jacobs chuck key counterclockwise to open the jaw as shown in Figure 28-3.
4. Insert the drill bit and rotate the Jacobs key clockwise to tighten the jaws until the drill bit is secure.

Disassembly

To open the jaws, turn the Jacobs chuck key counterclockwise. Remove and discard the drill bit. Rotate the Jacobs chuck attachment to the unlocked position and lift the attachment off of the motor.

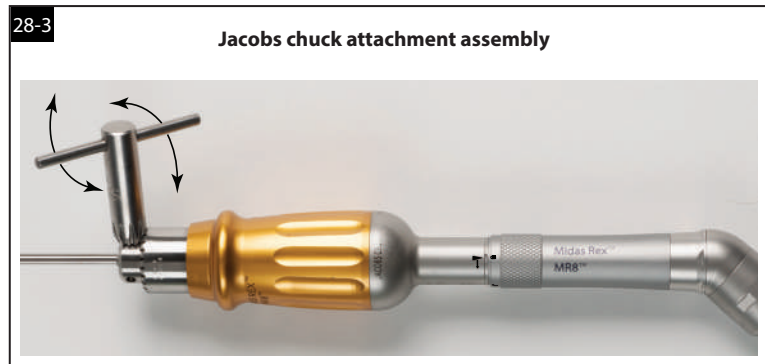

The Midas Rex MR8 pneumatic high-speed drill system

J-latch attachment

This attachment is designed for use with industry standard J-latch dissecting tools. Refer to the dissecting tool's labeling for information on specific operating requirements and limitations.

Assembly:

1. Assemble and secure the attachment onto the motor using the **Straight attachments Assembly** instructions (Figure 29-1).
2. Insert the tool into the attachment with a slight rotational motion. An audible click, perceptible by touch, confirms that the tool is fully seated (Figure 29-2).
3. Turn the tool lock sleeve in the direction shown on the attachment to lock the tool (Figure 29-3). Gently pull on the tool to ensure that it is locked into the motor.

Disassembly:

1. Turn the tool lock sleeve in the direction shown on the attachment to unlock the tool.
2. Remove the dissecting tool from the attachment and discard it.
3. Rotate the attachment on motor to the unlocked position.
4. Lift the attachment off of the motor.

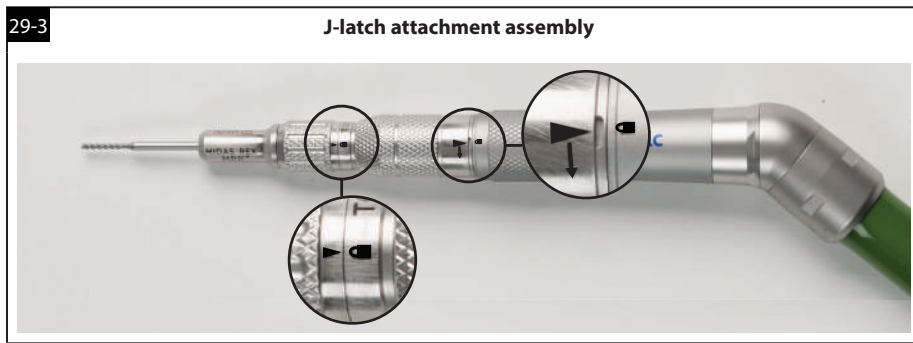
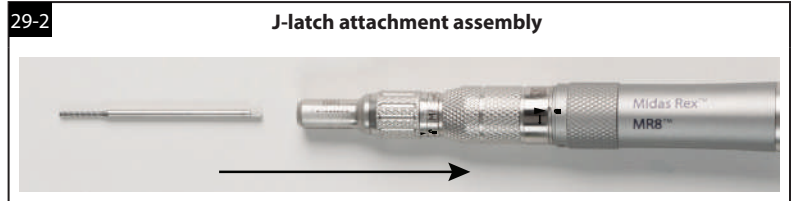
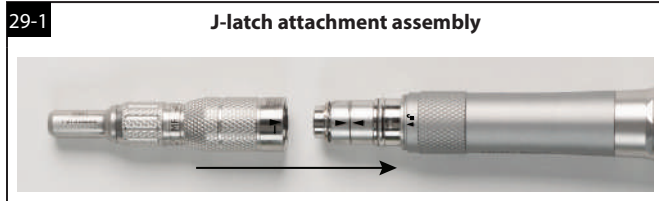

Disassembling the MR8 pneumatic system

Depressurize the system

Warning: Do not disassemble equipment before the gas is released from control unit.

1. Turn off the compressed gas at the source.
2. Press the pressure relief button on the pneumatic control unit, to release remaining gas.

Disconnect hoses

Release the motor hose from the control unit, by holding the hose firmly and pressing the motor port connection button (Figure 30).

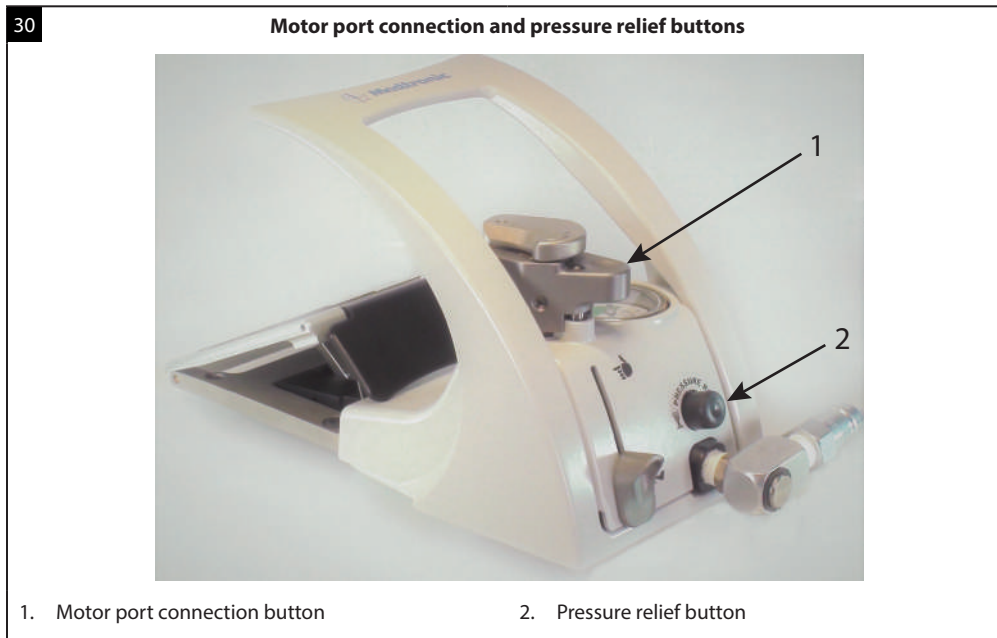

Discard the lubricant/diffuser cartridge

Caution: Do not re-use a lubricant/diffuser cartridge. It is a single-use product.

Remove the lubricant/diffuser cartridge from the housing and discard it.

System accessories: disposable components

Cleaning brushes

Clean debris from lumen of attachments and telescoping tubes with the appropriate cleaning brushes.

The disposable cleaning brushes are sized for MR8 attachments and telescoping tubes, but they will not pass through the angled, metal cutting, perforator, or Jacobs chuck attachments, because they are not cannulated.

Internal bore diameter	Brush length
1.2 mm	20 cm (8 in)
2.4 mm	41 cm (16 in)
3.2 mm	41 cm (16 in)

System accessories: non-disposable components

Instrument tray

The CA850 instrument tray holds MR8 attachments and/or other MR8 system equipment (Figures 31 and 32) to be sterilized and is placed inside a rigid sterilization container or wrapped for steam sterilization.

Note: The instrument tray can also hold one of the following motors: MR8 pneumatic motor (PM800) and the MR8 pneumatic touch motor (PM810).

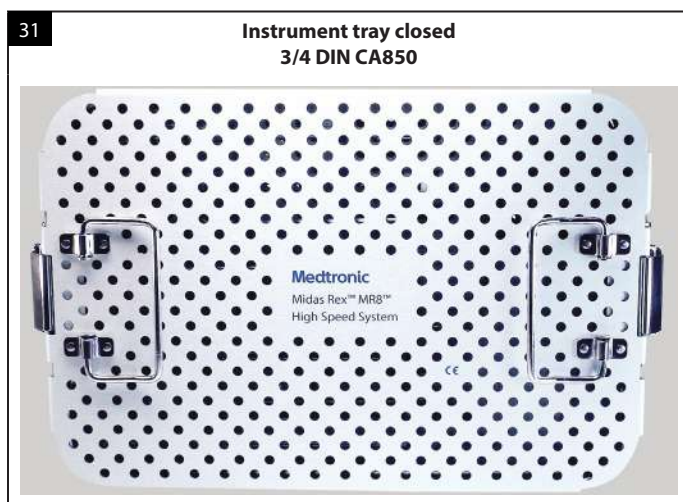

Rigid sterilization container (sterilization case)

The rigid sterilization container is a sterilization containment device designed to hold MR8 system equipment for sterilization, storage, transportation, and aseptic presentation of its contents (Figure 33). This container is available in a 3/4 DIN size.

The system consists of a base with carrying handles and lid that is secured to the base by means of a latching mechanism. The instrument tray holds MR8 attachments and/or other MR8 system equipment to be sterilized and is placed inside the rigid sterilization container as shown in Figure 34. A filter system is incorporated in the sterilization container to provide for air evacuation and sterilant penetration during the sterilization cycle and to act as a barrier to microorganisms during storage, handling, and transport.

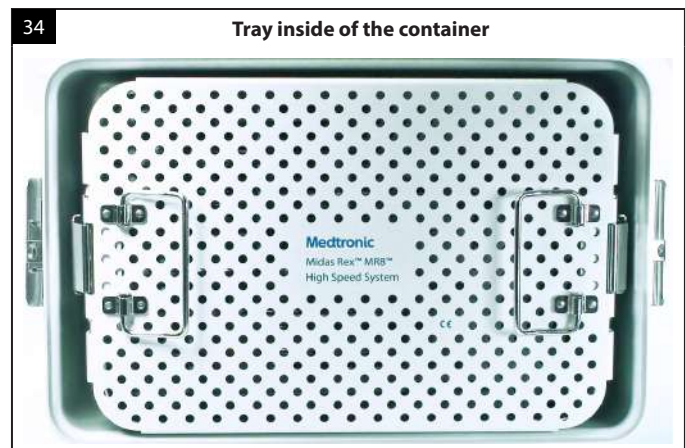

The Midas Rex MR8 pneumatic high-speed drill system

MR8 system reprocessing instructions

Cleaning is the removal of organic soil. Effective cleaning:

- Minimizes the organic soil transfer from one patient to another.
- Prevents accumulation of residual soil throughout the device's useful life.
- Allows for successful follow-up sterilization. Adequate reprocessing is contingent upon the thoroughness of cleaning.

Cleaning is the initial step. Sterilization occurs later in reprocessing and is intended to kill microorganisms to reduce the likelihood of transmission and possibilities of infection. To ensure acceptable reprocessing, there should be no delay between the cleaning, inspection, and sterilization.

Blood-borne pathogens - Universal precautions for handling this device after use should be observed by all hospital personnel according to OSHA standard 29 CFR 1910.1030, occupational exposure to blood-borne pathogens.

Warnings and cautions	<ul style="list-style-type: none"> • Do not soak/submerge devices. • Do not use ultrasonic cleaners to clean devices. • Do not use chlorine-based or corrosive cleaning agents such as bleach, lye, acetone, sodium hypochlorite/bleach, sodium hydroxide, formic acid, or solutions containing glutaraldehyde. • Allow an adequate cooling period after steam sterilization.
Limitations on reprocessing	<p>Note: Attachments and telescoping tubes may be disposed of at the end of their useful life according to local and national regulations. Due to safety and environmental concerns, Medtronic requests the return of pneumatic high speed motors for proper disposal at the end of the product useful life.</p> <p>End of useful life is normally determined by wear and damage due to use.</p> <p>See the "Maintenance, inspection, and testing" section in this document to determine if the device is at its end of useful life.</p>
Point of use	<p>Reprocessing begins at the point of use.</p> <p>Do not allow blood, debris or bodily fluids to dry on the device. Remove excess soil using running, cold tap water 10 - 22°C (50 - 72°F). Tap water is defined as potable water with hardness value between 0.7 mmol/l to 2.0 mmol/l.</p>
Containment and transportation	<p>Caution: Devices should be cleaned within 30 minutes (30:00) of use to limit fixation of contaminants.</p> <p>Do not place soiled instruments into the instrument case. Transport used devices in a separate container.</p> <p>If the device cannot be reprocessed immediately, keep the device moist during transport.</p> <p>It is recommended that devices are reprocessed as soon as is practical following use.</p> <p>To prolong the life of the device, reprocess immediately after use.</p>
Preparation for cleaning: automated	<p>MR8 pneumatic motor and MR8 pneumatic touch motor:</p> <ul style="list-style-type: none"> • Ensure that the attachment, tube, dissecting tool, and lubricant/diffuser have been removed from the motor prior to cleaning. • With the collet end and oiler housing pointed down, manually rinse the motor and hose under cold running tap water (10 - 22°C / 50 - 72°F) to remove any visible soil. • Use a nylon brush to aid in cleaning. • Give particular attention to crevices and other areas that present a challenge to cleaning. • For finger control lever, actuate all moving parts (motor safe mode switch) through full range of motion while thoroughly rinsing under cold running water. • Orient devices following recommendations of the washer/disinfector manufacturer. • For finger control lever, it shall be placed in the washer with the telescoping finger rest in the fully extended position. • Clean per recommended washer cycle per Table 6 or Table 7. • After cleaning, visually examine all parts of the device for cleanliness. If visible soil remains, repeat cleaning. <p>MR8 attachments and tubes:</p> <ul style="list-style-type: none"> • Ensure that the attachment, tube, dissecting tool, and lubricant/diffuser have been removed from the motor prior to cleaning. • Manually rinse attachments/tubes under cold running tap water (10 - 22°C / 50 - 72°F) to remove any visible soil. • Use a nylon brush to aid in cleaning. • Give particular attention to crevices and other areas that present a challenge to cleaning. • Attachments with moving parts should be actuated through their full range of motion under cold running tap water. • While rinsing under cold running tap water, use an appropriately sized nylon lumen brush (refer to Table 5) internally to aid in cleaning attachments. • Variable exposure attachments (AVAXX, AVAXXDK, AVSXX) must be placed in the washer with their tube in the fully extended position. • Orient devices following recommendations of the washer/disinfector manufacturer. • Clean per recommended washer cycle per Table 6 or Table 7. • After cleaning, visually examine all parts of the device for cleanliness. If visible soil remains, repeat cleaning.

Cleaning: automated

Warnings:

- Use the instrument tray and the rigid sterilization container for sterilizing the re-usable devices only.
- Do not use the instrument tray and rigid sterilization container for cleaning or disinfection of the re-usable devices.
- Do not use alkaline cleaning for the instrument tray or the rigid sterilization container.

Cautions:

- Do not use ultrasonic cleaner.

Table 6: Neutral Wash Cycle Parameters			
MR8 motors, attachments and tubes, and instrument tray - neutral			
Phase	Recirculation/soak (minutes)	Water temperature	Cleaner type
Pre-wash	2 minutes (02:00)	Cold tap water 10 - 16°C (50 - 61°F)	Not applicable
Enzyme wash	2 minutes (02:00)	Hot tap water 43 - 55°C (109 - 131°F)	Neutral pH enzymatic cleaner like Steris Prolystica® 2x concentrate enzymatic cleaner, 1.0mL/L (1/8 oz/gallon)
Wash 1	2 minutes (02:00)	66°C (151°F) (setpoint)	Neutral pH cleaner like Steris Prolystica 2x concentrate neutral cleaner, 1.0mL/L (1/8 oz/ gallon)
Rinse 1	15 seconds (00:15)	43 - 60°C (109 - 140°F)	Not applicable
Thermal rinse	1 minute (01:00)	90°C (194°F) (setpoint)	Not applicable
Purified water rinse	10 seconds (00:10)	66°C (151°F) (setpoint)	Not applicable

If visible soil remains, repeat cleaning.



Table 7: Alkaline Wash Cycle Parameters			
MR8 motors, attachments and tubes – alkaline cleaner (working solution pH ≤ 10.5)*			
Note: Do not use alkaline cleaning for the instrument tray or the rigid sterilization container.			
Phase	Recirculation/soak (minutes)	Water temperature	Cleaner type
Pre-wash	2 minutes (02:00)	Cold tap water 10 - 16°C (50 - 61°F)	Not applicable
Wash	5 minutes (05:00)	43°C (109°F) (set point)	Alkaline cleaner like Dr. Weigert neodisher® MediClean forte, 2mL/L (1/4oz/gal)
Rinse	1 minute (01:00)	Hot tap water 43 - 60°C (109 - 140°F)	Not applicable
Thermal rinse	1 minute (01:00)	90°C (194°F) (setpoint)	Not applicable
Purified water rinse	1 minute, 30 seconds (01:30)	66°C (151°F) (setpoint)	Not applicable

If visible soil remains, repeat cleaning.

*Alkaline cleaner manufacturers provide alkaline cleaners concentrated. The alkaline cleaners must be diluted per the cleaner manufacturer’s instructions for cleaning medical devices. Medtronic has verified alkaline cleaner compatibility for working solutions up to 10.5 pH.

After cleaning, lubricate attachments using an aerosol spray lubricant (such as Pana Spray) and perform the following steps to lubricate attachments:

1. Holding the can approximately 10-15 cm (3-6 in.) away from the attachment, spray all movable components with three quick squirts.
2. Actuate movable components to ensure proper lubrication.
3. Remove excess lubricant with a clean cloth.

<p>Cleaning: manual</p>	<p>MR8 pneumatic and MR8 pneumatic touch motors:</p> <ul style="list-style-type: none"> • Ensure that the attachment, tube, dissecting tool, and lubricant/diffuser have been removed from the motor prior to cleaning. • If cleaning the MR8 pneumatic touch motor, make sure to brush under the finger lever. • With the collet end and oiler housing pointed down, thoroughly rinse the motor and hose under cold running tap water (10 - 22°C / 50 - 72°F) to remove any visible soil. • Use a nylon brush to aid in cleaning. • Give particular attention to crevices and other areas that present a challenge to cleaning. • Prepare with tap water, a neutral enzymatic cleaner like Steris Prolystica 2x concentrate enzymatic cleaner following the manufacturer's recommendations of 1.0 mL/L (1/8 oz/gallon) at a temperature of 23°C (73°F), or use an equivalent neutral pH cleaner following that manufacturer's recommendations. • Wipe all external surfaces of the motor, hose, and oiler housing, and wipe the inner surface of oiler housing with a cloth dampened with the prepared cleaner. • Brush motor case, collet, and oiler housing with a nylon brush dampened with the prepared cleaner. For the Pneumatic Touch motor, be sure to brush under the finger control lever. • For finger control lever, actuate all moving parts (telescoping finger rest and motor safe mode switch) through their full range of motion while rinsing under warm running tap water (23 - 43°C / 73 - 109°F). • Following the warm tap water rinse, the device should be thoroughly rinsed in room temperature 25°C (77°F) purified water (deionized, reverse osmosis, or equivalent) for a minimum of 30 seconds with collet end and oiler housing pointed down. • Dry the entire device with lint-free towel. • Verify that devices are visually clean after manual cleaning. If visible soil remains, repeat cleaning. <p>MR8 attachments and tubes:</p> <ul style="list-style-type: none"> • Ensure that the attachment, tube, dissecting tool, and lubricant/diffuser have been removed from the motor prior to cleaning. • Thoroughly rinse the attachments/tubes under cold running tap water (10 - 22°C / 50 - 72°F) to remove any visible soil. • Use a nylon brush to aid in cleaning. • Give particular attention to crevices and other areas that present a challenge to cleaning. • Actuate all moving parts through their full range of motion while rinsing under cold running tap water. • Prepare with tap water, a neutral enzymatic cleaner like Steris Prolystica 2x concentrate enzymatic cleaner following the manufacturer's recommendations of 1.0 mL/L (1/8 oz/gallon) at a temperature of 23°C (73°F), or use an equivalent neutral pH cleaner following that manufacturer's recommendations. • Wipe all attachments and telescoping tubes with a cloth, dampened with the prepared cleaner. • Use a nylon brush dampened with the prepared cleaner to clean the external surfaces and internal connecting surfaces of the attachment/tube base. <p>Note: While cleaning angled and curved telescoping tubes, it may be necessary to push the brush through both ends.</p> <ul style="list-style-type: none"> • Straight attachments, footed attachments, and telescoping straight tubes have special cleaning brushes sized to the attachment's or telescoping tube's internal diameter (refer to Table 5). Push the brush wet with the prepared cleaner through the attachment or telescoping tube from rear to front to loosen and remove debris trapped inside. • Other attachments and tubes may be mechanically agitated in the prepared cleaner solution, but not soaked. • For angled type attachments, perforator driver attachment, or Jacobs chuck attachment, only place one half (e.g., tube/tool side) of the attachment into the cleaner at a time (Figures 35-1 – 35-3). Do not immerse the entire attachment. Gently agitate the attachment in the cleaner and actuate any moveable parts. Then, place the other half (e.g., base side) of the attachment into the cleaner and repeat (Figures 35-1 – 35-3). • Ensure that the tube lumen on the angled attachment, curved and angled telescoping tube, metal cutter attachment, or J-latch attachment is cleaned with the appropriate sized brush (refer to Table 5). • Actuate any moveable parts through their full range of motion to allow cleaner to thoroughly clean attachment (for example, the dial on variable exposure attachment and the sleeve on perforator attachment). • Under warm running tap water (23 - 43°C / 73 - 109°F), move any moveable parts through their full range of motion to allow water to thoroughly rinse the attachment. • Rinse the attachment thoroughly with warm running tap water. Flush both ends to remove cleaner. • Following the warm tap water rinse, the device should be thoroughly rinsed in room temperature 25°C (77°F) purified water (deionized, reverse osmosis, or equivalent) for a minimum of 30 seconds. • Verify that devices are visually clean after manual cleaning. If visible soil remains, repeat cleaning. • Thoroughly dry attachments. An air gun may be used to blow moisture out from rear to front of attachment. <div data-bbox="305 1528 857 1806"> <p>35-1 Angled attachment cleaning example</p>  <p>1. Tube/tool side 2. Base side</p> </div> <div data-bbox="873 1528 1425 1806"> <p>35-2 Perforator attachment cleaning example</p>  <p>1. Tube/tool side 2. Base side</p> </div>
--------------------------------	---

35-3 Jacobs chuck attachment cleaning example



1. Tube/tool side 2. Base side

Pneumatic control unit

1. Dampen a cloth with a neutral enzymatic detergent, pH 6.0-8.0, or a phenol based disinfectant, mixed according to manufacturer's instructions.
2. Wipe the foot pedal with the damp cloth until visually clean.
3. Dry the unit with a clean, non-abrasive cloth.

Instrument tray and rigid sterilization container

1. Manually clean the rigid sterilization container and instrument tray only when a washer-disinfector is not available.
 - a. Thoroughly rinse the rigid sterilization container and instrument tray under cold running tap water (10 - 22°C / 50 - 72°F) to remove any visible soil.
 - b. Use a soft-bristled brush or clean cloth to aid soil removal around brackets, handles, and filter retention plates (only on the rigid sterilization container).
 - c. If soil is visible, gently flush the gasket region of the rigid sterilization container.
 - d. Give particular attention to crevices and other areas that present a challenge to cleaning.
 - e. Carefully inspect the rigid sterilization container and instrument tray, including the handles, gaskets, filter retention plates, and cavities, to ensure all visible soil is removed.
2. Prepare neutral enzymatic cleaner Steris Prolystica 2x Concentrate.
 - a. Prepare the enzymatic cleaner following the manufacturer's recommendations of 1.0ml/L (1/8 oz/gallon) at a temperature of 23°C (73°F) or use an equivalent neutral pH cleaner following that manufacturer's recommendations.
 - b. Immerse the rigid sterilization container and instrument tray in the prepared enzymatic cleaner, actuate the tray and allow it to soak for a minimum of 10 minutes.
3. Thoroughly clean the rigid sterilization container and instrument tray.
 - a. Use a soft-bristled brush for the outer portion of the rigid sterilization container and instrument tray.
 - b. Pay particular attention to crevices, filter retention plates (only on the rigid sterilization container), latches, and other hard-to-clean areas to remove all visible soil.
4. After soaking, thoroughly rinse the rigid sterilization container and instrument tray under warm (23 - 43°C / 73 - 109°F) running tap water for a minimum of 1 minute to remove all residual cleaner.
 - a. Rinse the rigid sterilization container and instrument tray.
 - b. Use a syringe to aid in rinsing.
5. Following the warm tap water rinse, thoroughly rinse the rigid sterilization container and instrument tray in room temperature 25°C (77°F) purified water (deionized, reverse osmosis, or equivalent) water for a minimum of 30 seconds.

Note: After cleaning, visually examine all parts of the rigid sterilization container and instrument tray for cleanliness. If visible soil remains, repeat cleaning.
6. Dry the instrument tray and rigid sterilization container with a clean, lint-free towel.

After cleaning, lubricate attachments using an aerosol spray lubricant (such as Pana Spray) and perform the following steps to lubricate attachments:

1. Holding the can approximately 10-15 cm (3-6 in.) away from the attachment, spray all movable components with three quick squirts.
2. Actuate movable components to ensure proper lubrication.
3. Remove excess lubricant with a clean cloth.

Disinfection

No particular requirements.

Drying

If necessary, dry the devices with a clean, lint-free towel. Refer to the motor, attachment/tube, instrument tray, and sterilization container cleaning sections on specific drying instructions.

Maintenance, inspection, and testing

Do not reprocess for surgical use a device that has obvious damage or corrosion. Return to Medtronic for service. Visually inspect the reprocessed devices following cleaning. Inspection should be performed with adequate lighting. Magnification is not required. A device that shows or exhibits the properties listed below is at the end of its useful life. Attachments and telescoping tubes may be disposed of at the end of their useful life according to local and national regulations. Due to safety and environmental concerns, Medtronic requests the return of pneumatic high-speed motors for proper disposal at the end of the product's useful life.

- Obvious damage or corrosion
- Pitting, cracks, fractures, or bending
- Illegible laser etchings, engravings, and other markings
- Discoloration, corrosion, stains or rust.
- Mechanisms that are rough or stuck. These are indications of bad O-rings, or damaged internal components for example, variable exposure collars, tool lock collar, and sleeves.

Packaging

Warnings:

- Do not load more than one MR8 motor inside the instrument tray per sterilization cycle.
- Do not wrap the rigid sterilization container.
- Use the instrument tray and the rigid sterilization container for sterilization only, not for cleaning or disinfection.

There are two options available for packaging:

1. Devices may be sterilized using a wrapped instrument tray. The instrument tray should be wrapped with two layers of 1-ply polypropylene wrap using a sequential envelope technique. For use in the USA, an FDA-cleared wrap should be used.
2. Devices can also be sterilized by placing them inside the 3/4 DIN CA850 instrument tray and then placing the 3/4 DIN CA850 instrument tray inside the 3/4 DIN rigid sterilization container.

Instrument tray:

1. Inspect the following components before each sterilization cycle. Make sure the instrument tray does not have cracks or tears, and that the silicone brackets (Figure 36) are not damaged.

36 Silicone brackets



2. Arrange the cleaned devices in the instrument tray's silicone brackets. The instrument tray includes printed outlines as a guide for the devices that fit within the tray.
3. Variable exposure attachments (AVAXX, AVAXXDK, AVSXX) must be placed in the instrument tray with their tube in the fully extended position (Figure 37).
4. Place the motor inside the instrument tray as shown in Figure 38.
5. Close the instrument tray with the lid.

37 3/4 DIN CA850 instrument tray with variable exposure attachments

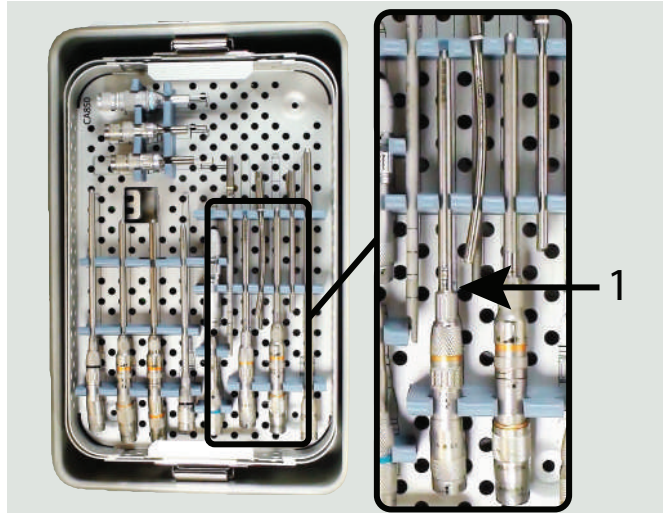

1. Variable exposure attachment in the fully extended position

38 Placement of the motor in the 3/4 DIN CA850 instrument tray



Option 1: Wrap the instrument tray for sterilization:

- The user facility is responsible for using only accessories (such as sterilization wraps, chemical indicators, and biological indicators) that are cleared and labeled for the validated sterilization parameters specified in this Instructions for Use by the Food and Drug Administration for medical facilities in the U.S.A. and its territories, or conform to EN ISO 11607 for medical facilities outside of the U.S.A. and its territories.
- The 3/4 DIN CA850 instrument tray should be wrapped with two layers of 1-ply polypropylene wrap using a sequential envelope technique. For use in the USA, an FDA-cleared wrap should be used.

Option 2: Place the instrument tray into the rigid sterilization container:

1. Use one filter (Case Medical SCF01) for the rigid sterilization container's lid and use two filters (Case Medical SCF01) for the 3/4 DIN size rigid sterilization container's base.
 - a. Place the filter over the perforations in the lid and place a filter retention plate over the filter.
 - b. Secure the filter retention plate by pushing downwards at the center and rotating the handles until you hear them click (Figure 39).
2. Place a rack around the filter plates (Figure 40).
3. Place the instrument tray with the lid on into the rigid sterilization container (Figure 41).

Note: Use only the 3/4 DIN CA850 instrument tray with the 3/4 DIN rigid sterilization container.
4. Close the rigid sterilization container and apply labels and seals.
 - a. On both sides of the rigid sterilization container, position the top of the latch over the ridge in the lid and push the bottom section of the latch in toward the rigid sterilization container (Figure 42). You will feel a solid click.
 - b. Place the appropriate metal ID tags in the label holders located on either side of the rigid sterilization container latches (Figure 43).

Note: Use only the approved tamper-evident seals (Case Medical SCS01B). Using a nonapproved tamper-evident seal could damage the locking clip.
5. Place the container flat on the shelf of the sterilizer cart.

39 Rigid sterilization container filter placement



40 3/4 DIN sterilization container with rack



41 Instrument tray inside the rigid sterilization container



42 3/4 DIN closed container



43 Tamper-evident seal on the 3/4 DIN container



The Midas Rex MR8 pneumatic high-speed drill system

<p>Sterilization</p>	<p>Warnings:</p> <ul style="list-style-type: none"> Do not attempt to run the MR8 motors immediately after autoclaving. Allow an adequate cooling period after steam sterilization. Do not sterilize and supply for surgical use any device that is not visibly clean and free of particulates. If particulates are present, repeat reprocessing, starting with the Preparation for Cleaning step. Use the instrument tray and the rigid sterilization container for sterilization only. The MR8 system devices must be cleaned separate from the trays. Devices cannot be sterilized to an adequate Sterility Assurance Level (SAL) without prior cleaning and decontamination. <p>Cautions:</p> <ul style="list-style-type: none"> Do not expose these devices to sterilization temperatures greater than 137°C (279°F). Exposure to temperatures greater than 137°C (279°F) may impact the performance of the device and also the efficacy of the sterilization cycle. Because of the variability in cleaning efficiencies and sterilizer operating parameters, all given parameters (temperature, time, etcetera) should be validated by persons who have training and expertise in sterilization processes. Deviation from the recommended sterilization processes is at the risk of the user facility. <p>Notes:</p> <ul style="list-style-type: none"> The instructions provided have been validated by the manufacturer as being capable of preparing the product for reuse. It remains the responsibility of the processor to ensure that the reprocessing as actually performed, using equipment, materials, and personnel in the reprocessing facility, achieves the desired result. This normally requires validation and routine monitoring of the process. Load the parts into the sterilizer by following the sterilizer manufacturer's recommended loading procedures and load configurations. These sterilization instructions have been validated to a sterility assurance level of 10⁻⁶. The recommended sterilization parameters are only valid with CE-marked equipment that is properly maintained and calibrated. Steam for sterilization should be generated from water that has been treated to remove total dissolved solids, filtered to remove contaminants and water droplets, and supplied via piping without deadlegs or other stagnant zones where contamination might collect. Steam saturation should be greater than 97%. <table border="1" data-bbox="305 743 1490 1031"> <thead> <tr> <th>Cycle</th> <th>Temperature</th> <th>Exposure time</th> <th>Minimum dry time*</th> </tr> </thead> <tbody> <tr> <td colspan="4">In any geography - sterilization prevacuum (dynamic-air-removal) steam cycle parameters for medical facilities</td> </tr> <tr> <td>Prevacuum</td> <td>132°C (270°F)</td> <td>4 minutes (04:00)</td> <td>25 minutes (25:00)</td> </tr> <tr> <td>Prevacuum</td> <td>135°C (275°F)</td> <td>3 minutes (03:00)</td> <td>25 minutes (25:00)</td> </tr> <tr> <td colspan="4">Outside the U.S.A. - sterilization prevacuum (dynamic-air-removal) steam cycle parameters for medical facilities</td> </tr> <tr> <td>Prevacuum</td> <td>134°C (273°F)</td> <td>18 minutes (18:00)</td> <td>25 minutes (25:00)</td> </tr> <tr> <td colspan="4">*Minimum dry times were validated using sterilizers having vacuum drying capabilities. Drying cycles using ambient atmospheric pressures may require more time.</td> </tr> </tbody> </table>	Cycle	Temperature	Exposure time	Minimum dry time*	In any geography - sterilization prevacuum (dynamic-air-removal) steam cycle parameters for medical facilities				Prevacuum	132°C (270°F)	4 minutes (04:00)	25 minutes (25:00)	Prevacuum	135°C (275°F)	3 minutes (03:00)	25 minutes (25:00)	Outside the U.S.A. - sterilization prevacuum (dynamic-air-removal) steam cycle parameters for medical facilities				Prevacuum	134°C (273°F)	18 minutes (18:00)	25 minutes (25:00)	*Minimum dry times were validated using sterilizers having vacuum drying capabilities. Drying cycles using ambient atmospheric pressures may require more time.			
Cycle	Temperature	Exposure time	Minimum dry time*																										
In any geography - sterilization prevacuum (dynamic-air-removal) steam cycle parameters for medical facilities																													
Prevacuum	132°C (270°F)	4 minutes (04:00)	25 minutes (25:00)																										
Prevacuum	135°C (275°F)	3 minutes (03:00)	25 minutes (25:00)																										
Outside the U.S.A. - sterilization prevacuum (dynamic-air-removal) steam cycle parameters for medical facilities																													
Prevacuum	134°C (273°F)	18 minutes (18:00)	25 minutes (25:00)																										
*Minimum dry times were validated using sterilizers having vacuum drying capabilities. Drying cycles using ambient atmospheric pressures may require more time.																													
<p>Storage</p>	<p>Make sure that the container is dry before storage, and stored in cool, dry conditions at ambient room temperature. Store sterile devices in such a way that the sterile package is not compromised.</p>																												
<p>Use</p>	<p>When you are ready to use the devices, follow these steps.</p> <ol style="list-style-type: none"> Before you open the container, make sure that: <ol style="list-style-type: none"> You have selected the correct rigid sterilization container. The tamper-evident seals are intact. Unlatch the container. Use the ring on top of the lid to remove the lid. Using the ring avoids contaminating the container's contents. Remove the tray of devices and place it in the sterile field. 																												

Return policy for devices exposed to TSE (transmissible spongiform encephalopathies)

Reusable devices that have been used on patients with suspected Creutzfeldt-Jakob Disease (CJD) or other TSEs should be quarantined and not reused until a diagnosis is confirmed or excluded. The Neurosurgery Group will not authorize or accept the return of Medtronic products that directly contacted a patient or are contaminated with a patient's body fluids that is suspected or confirmed with TSE or CJD diagnosis. Furthermore, Medtronic recommends that all Medtronic product used on a patient confirmed with or suspected of a TSE/CJD diagnosis be incinerated. If TSE/CJD is excluded as a diagnosis, the quarantined reusable equipment may be returned for use after appropriate cleaning, decontamination and sterilization. Hospital personnel should contact their infection control personnel for current procedures and policy for reusable equipment processing. Contact your sales representative for temporary equipment while original equipment is quarantined or for replacement of product incinerated under this policy.

Planned maintenance

Planned maintenance information is provided as a guide to assist the customer in getting the greatest ownership value from their MR8 system. This scheduled program helps to maintain the device's performance, safety, and reliability. Maintenance for the MR8 system is in addition to the required routine cleaning after each use.

The frequency of maintenance depends on how often the system is used and the conditions which the system is subjected to, such as during cleaning and sterilization. The demands on MR8 systems can vary greatly from facility to facility. The time between scheduled maintenance is determined by tool usage per motor per year and per month per motor. Adhere to the scheduled maintenance intervals in Table 8.

Warning: Failure to follow recommended service and planned maintenance schedules for attachments or motors may prevent the tool from being secured properly. Identifying and following the scheduled maintenance intervals for the MR8 system will assist in reducing the potential for unanticipated down time as a result of wear.

Table 8: scheduled maintenance intervals

Maintenance level	Number of tools used per motor per year	Number of uses per month per motor	Number of uses per month per attachment**	Time interval
A	150–200	12–16*	19–23	3 months
B	100–149	8–11	15–18	4 months
C	50–99	4–7	12–15	5 months
D	<50	<4	≤11	6 months

*A motor with more than 16 uses per month should be returned for Medtronic maintenance at a 6-month interval.
 **Usage per month for most attachments. Some attachments may require more frequent checks.

Notes:

- If any damage, wear, rust or corrosion is observed with the product or if action is required beyond cleaning, **do not** use the product and return to Medtronic for service.
- The planned maintenance steps have been designed for a facility's biomedical department or equivalent to perform.
- The MR8 system has a limited warranty for a period of 1 year from the date of purchase for motors, hoses, pneumatic control unit, regulator hose, regulator, adapters, and instrument trays and rigid sterilization containers. The attachments and telescoping tubes have a limited warranty for a period of 90 days from the date of purchase. After the warranty period, any costs incurred for repair/refurbishing become the responsibility of the customer. This limited warranty does not include the cost associated with any of the factory level service requirements identified in the Preventive Maintenance Schedule. Extended Maintenance Agreements are available.

For scheduled maintenance intervals 1, 2, 3, 5, 6, 7, 9, 10, and 11

Follow the detailed instructions for servicing the MR8 system in accordance with the 12 maintenance intervals.

Motor

- Visually inspect the exhaust (green) hose and ensure that it does not have any nicks, cracks, holes, tears, or other visible signs of wear.
- Wipe the external surface of the exhaust (green) hose with a cloth. Perform the heat and seal check below (Step 5) and then inspect the hose. If an oily film remains on the hose, **do not** use and return the motor to Medtronic for service.
- Visually inspect the air fitting and ensure that it does not exhibit any signs of damage.
- Visually inspect the serial number and ensure that it remains legible.
- Heat and seal check:
 - Attach and lock a straight or footed attachment onto the motor. Check to ensure that there is a tactile feel and an audible click when the attachment is locked on the motor.
 - Connect the motor to a pneumatic control unit attached to a compressed gas source.
 - Run the motor for 5 minutes (05:00) at the maximum pressure setting available between 80psi – 120psi.
 - Feel the motor case and the attachment base and ensure they are not uncomfortably hot to the touch.
 - Remove the attachment and visually inspect the tool collet area, and the finger control valve area (if applicable) for any signs of oil.
- MR8 touch only: Run the motor for a short duration and then release the finger control lever. If the motor continues to run after the finger control lever is released, **do not** use and return the motor to Medtronic for service.

Attachments: straight, angled, footed, perforator, Jacobs chuck, metal cutting, J-latch, and telescoping

Note: Telescoping tubes are multi-use disposables and **do not** receive scheduled maintenance. Discard if excessive heat or vibration is present.

- Visually inspect the etching and color ring to ensure it remains legible and the color is distinguishable.
- Visually inspect the attachment tube and base for any signs of debris or damage.
- Visually and physically inspect (pull and twist by hand) the attachment for any loose or loosening components. If any components are loose, do not use.
- Straight and angled: Visually inspect the attachment tip for any signs of wear. The tip should remain round with no evidence of deformation.
- Footed: Visually inspect the foot of the attachment. The foot should not be bent and the proximal dimple should be smooth and showing no signs of damage.
- Perforator and Jacobs chuck: Visually inspect the perforator and Jacobs chuck collet for any signs of wear or deformation. Rotate the collet of the attachment. It should rotate easily.
- Heat Check:

Caution: Feel the motor case, the attachment base, knuckle (angled area for angled attachment only), and the attachment tip (straight and angled attachments only) periodically and cautiously to ensure they are not uncomfortably hot to the touch.

 - Attach and lock the attachment onto the motor. Ensure that there is a tactile click when the attachment is locked onto the motor.

Note: Ensure that the secondary lock is engaged on the angled attachments.
 - Connect the motor to a pneumatic control unit attached to a compressed gas source.
 - Run the motor and attachment at the maximum pressure setting available between 80psi – 120psi for 3 minutes (03:00).
 - Allow the motor to cool and then repeat steps 1 to 7 for each attachment in the system.
- Exceptions:
 - Run J-latch attachment at 80psi for 3 minutes (03:00).
 - Perforators and Jacobs chuck at the maximum pressure setting available between 80psi – 120psi for 5 minutes (05:00)

The Midas Rex MR8 pneumatic high-speed drill system

Pneumatic control unit, regulator, and regulator hose

1. Visually inspect the air fittings and regulator hose for any signs of blockage, damage, or wear.
2. Static gage check:
Note: This is a static functional test only. The pressure gages should be placed on your facility's routine calibration schedule and be assessed for accuracy during its regular calibration date.
 - a. Connect the pneumatic control unit/regulator to a compressed gas source.
 - b. Pressurize the pneumatic control unit/regulator.
 - c. Confirm that the gage is functional.
3. Pneumatic control unit:
 - a. Pressure relief button check:
 - i. Connect the pneumatic control unit to a compressed gas source.
 - ii. Pressurize the pneumatic control unit.
 - iii. Turn off the compressed gas source.
 - iv. Press the pressure relief button.
 - v. Confirm that the compressed gas has been released and the gage on the pneumatic control unit drops to zero.
 - b. Finger/foot control switch functionality check:
 - i. Connect a motor to the pneumatic control unit.
 - ii. Place the switch in "On" the position.
 - iii. Confirm the foot pedal is depressed.
 - iv. Remove the motor from the pneumatic control unit.
 - v. Place the switch in the "On" position.
 - vi. Confirm the foot pedal is released.
 - c. Visually inspect the motor port cover for any signs of wear or damage.
 - d. Visually inspect the foot control pedal for any build-up of debris or indication of damage. Ensure the pedal moves freely.
 - e. Pedal check:
 - i. Attach the motor to the pneumatic control unit.
 - ii. Connect the pneumatic control unit to a compressed gas source.
 - iii. Depress the foot pedal and run the motor for a short duration.
 - iv. Release the foot pedal and observe the motor.
 - v. If the motor continues to run after the foot pedal control lever is released, **do not** use and return the foot control to Medtronic for service.
 - vi. Visually inspect the motor port cover for damage.

For scheduled maintenance intervals 4, 12

Motor and attachments: straight, footed, perforator, Jacobs chuck, telescoping, angled, and metal cutting

At these maintenance intervals, it is important that the units be returned to Medtronic for factory level inspection and service.

Note: The costs associated with any of the factory level service requirements are not included in the limited warranty. Extended maintenance agreements are available.

Pneumatic control unit, regulator, and regulator hose

1. Visually inspect the air fittings and regulator hose for any signs of blockage, damage, or wear.
2. Static gage check:
Note: This is a static functional test only. The pressure gages should be placed on your facilities routine calibration schedule and be assessed for accuracy during its regular calibration date.
 - a. Connect the pneumatic control unit/regulator to a compressed gas source.
 - b. Pressurize the pneumatic control unit/regulator.
 - c. Confirm that the gage is functional.
3. Pneumatic control unit:
 - a. Pressure relief button check:
 - i. Connect the pneumatic control unit to a compressed gas source.
 - ii. Pressurize the pneumatic control unit.
 - iii. Turn off the compressed gas source.
 - iv. Press the pressure relief button.
 - v. Confirm that the compressed gas has been released and the gage on the pneumatic control unit drops to zero.
 - b. Finger/foot control switch functionality check:
 - i. Connect a motor to the pneumatic control unit.
 - ii. Place the switch in "On" the position.
 - iii. Confirm the foot pedal is depressed.
 - iv. Remove the motor from the pneumatic control unit.
 - v. Place the switch in the "On" position.
 - vi. Confirm the foot pedal is released.
 - c. Visually inspect the motor port cover for any signs of wear or damage.
 - d. Visually inspect the foot control pedal for any build-up of debris or indication of damage. Ensure the pedal moves freely.
 - e. Pedal check:
 - i. Attach the motor to the pneumatic control unit.
 - ii. Connect the pneumatic control unit to a compressed gas source.
 - iii. Depress the foot pedal and run the motor for a short duration.
 - iv. Release the foot pedal and observe the motor.
 - v. If the motor continues to run after the foot pedal control lever is released, **do not** use and return the foot control to Medtronic for service.
 - vi. Visually inspect the motor port cover for damage.

For scheduled maintenance interval 8

Motor and attachments: straight, footed, perforator, Jacobs chuck, telescoping, angled, and metal cutting, foot control, and regulator

At this maintenance interval, it is important that the units be returned to Medtronic for factory level inspection and service.

Note: The costs associated with any of the factory level service requirements are not included in the limited warranty. Extended maintenance agreements are available.

Storage

Store devices in a clean, dry area with other sterile devices.

Disposal

Due to safety and environmental concerns, Medtronic requests the return of pneumatic high speed motors for proper disposal at the end of the product life cycles.

Troubleshooting

If MR8 system components require servicing or refurbishing, return components to Medtronic for quality assured service by factory-trained personnel who will utilize genuine Medtronic MR8 system parts as required. All MR8 system components returned for servicing or refurbishing should be properly cleaned and sterilized prior to shipping.

Problem	Possible cause	Recommendations
MR8 motor		
Motor not running or low on power	Hoses not properly connected	Make sure all connections are secure. Ensure supply pressure is within 80-120 psi.
	Operating pressure inadequate	Check gas supply pressure guage. Increase pressure according to compressed gas requirements, if necessary.
	Attachment not properly installed and locked onto the motor	Remove and re-install attachment and tool to ensure proper installation and locking of attachment onto motor.
	Foot pedal on pneumatic control unit not functioning properly	Check for obstructions under the foot pedal. If foot pedal continues to fail, return the pneumatic control unit to Medtronic for service.
Motor continues to run	Motor stalls	Manually spin the dissecting tool, then activate the motor. If the motor continues to stall, return it to Medtronic for service.
	Pneumatic control unit is not functioning properly	Depressurize the system and return the pneumatic control unit to Medtronic for service.
	Finger control is not functioning properly	Return motor to Medtronic for service.
System makes an abnormal noise	Pneumatic control unit is locked in the finger control position	Move the finger control lever to the foot control position.
	Inadequate lubrication	Check for proper installation of the lubricant/diffuser cartridge. If the problem persists, replace the cartridge. If replacing the cartridge doesn't fix the problem, return the motor to Medtronic for service.
	Motor's exhaust hose is damaged or internal pressure hose is detached	Depressurize the system and return the motor to Medtronic for service.
	Worn bearings	Switch attachments to determine whether the bearings are failing in the motor or in the attachment. Return the failing component to Medtronic for service.
	Attachment not properly installed and locked onto the motor	Remove and reinstall attachment and tool to ensure proper installation and locking of the attachment onto the motor.
Motor is too hot to touch/hold	Safety relief valve has been activated by high air pressure	Ensure that air operating/dynamic air pressure is no higher than 120 psi.
	Inadequate cool down period following sterilization	Motor must be allowed to cool down following steam sterilization.
	Inadequate lubrication	Check for proper installation of the lubricant/diffuser cartridge.
	Attachment transferring heat to the motor	Switch attachments to determine whether the heat is being generated by the motor or the attachment. Return the failing component to Medtronic for service.
	Heavy side loading during dissection	Discontinue use and rest the motor by using it intermittently or wrap the motor with a moist sterile towel. If overheating continues, return the motor to Medtronic for service.
Attachment does not seat properly on motor	Inadequate irrigation	Ensure adequate irrigation to surgical site during bone dissection.
	Damaged tactile ring on motor collet	Contact Medtronic Customer Service to return the motor for service.
MR8 attachments or telescoping tubes		
Attachment will not properly seat on the motor	Motor collet flats are not aligned	Use the Medtronic motor wrench to rotate the flat closest to the motor case until its marker is aligned with the marker on the flat farthest away from the motor case.
Tool is difficult to remove from the attachment	Aging of attachment	Return to Medtronic for service or purchase new equipment.
	Improper cleaning	
	Use of reprocessed tools	
	Use of an unauthorized refurbisher	
16-MF Contra-Angle attachment is overheating	The Contra-Angle attachment operates by a set of internal gears to engage the drive shaft. It is normal for some heat to be generated approximately 2 cm from the distal end of the attachment and at the right of the angle head.	Verify pressure setting of 80 psi (5.5 bar). If heat continues or is excessive, return the equipment to Medtronic for service or purchase new equipment.
Perforator is running too slow	Pressure set incorrectly	Check the pressure setting at the foot control.
Footed attachment will not lock	Tool not seated properly	Remove and reinstall the dissecting tool to ensure that it is properly seated. An audible click, heard and perceptible by touch, confirms that the tool is fully seated.

The Midas Rex MR8 pneumatic high-speed drill system

Problem	Possible cause	Recommendations
MR8 dissecting tools		
Dissecting tool fails	A non-MR8 dissecting tool is being used	Replace with an MR8 dissecting tool.
	Worn attachment or tube bearings	Try another attachment or tube to isolate the location of the problem. If the attachment is failing, return it to Medtronic. If the tube is failing, dispose of it and use a new tube.
	Attachment/tube and tool are not compatible	Match color code on the dissecting tool packaging to the color code on the attachment/tube.
	Motor is damaged	Return motor to Medtronic for service.
	Dissecting tool's size and geometry may contribute to failing at certain speeds	Adjust the speed by changing the pressure setting or foot/finger control. Do not use if failing persists. Change dissecting tools.
Dissecting tool vibrates excessively	Dissecting tool's size and geometry may create excessive vibration at certain speeds	Adjust the speed by changing the pressure setting or foot/finger control. Change dissecting tools.
Dissecting tool will not seat properly in the motor or attachment collet	Debris in collet of attachment or motor	Clean the attachment or motor thoroughly according to the instructions in this manual. If cleaning does not correct the problem, return the attachment or motor to Medtronic for service.
	A non-MR8 dissecting tool is being used	Replace with an MR8 dissecting tool.
Smoke is generated by the attachment or motor	Attachment is not in the locked position	Make sure the attachment is in the locked position.

Medtronic Midas Rex MR8 pneumatic high speed systems limited warranty*

(U.S. customers only)



- A. This limited warranty provides the following assurance to the purchaser of a Medtronic Midas Rex MR8 pneumatic high speed system. This limited warranty is extended only to the buyer purchasing the MR8 system directly from Medtronic or from its affiliate or its authorized distributor or representative. The Midas Rex MR8 pneumatic high speed system (hereinafter all items listed below are collectively referred to as product) includes, as may be applicable, the motor, foot control, instrument trays and rigid sterilization containers (hereafter referred to as system components), straight and angled motor attachments (hereinafter referred to as "attachments"), telescoping tubes (hereinafter referred to as semi-reusable components), and dissecting tools and other accessories not listed above and jointly referred to as other components, unless specifically noted.
 - a. Should a system component fail to function to Medtronic's published specifications during the term of this limited warranty (one year from the date of sale of a new system component or 90 days from the date of sale of a refurbished or used system component), Medtronic will either repair or replace the motor component or any portion thereof.
 - b. Should an attachment fail to function to Medtronic's published specifications during the term of this limited warranty (90 days from the date of sale of a new attachment), Medtronic will either repair or replace the attachment or any portion thereof.
 - c. Should a semi-reusable component fail to function to Medtronic's published specifications during the term of this limited warranty (30 days from the date of sale of a new semi-reusable component), Medtronic will replace the semi-reusable component or any portion thereof.
 - d. Should a single use component fail to function to Medtronic's published specifications prior to its "use by" date Medtronic will replace the single use component.
 - e. Should other components fail to function to Medtronic's published specifications during the term of this limited warranty (30 days from the date of sale of a new other components), Medtronic will replace or repair the other components or any portion thereof.
- B. To qualify for this limited warranty, the following conditions must be met:
 - a. The product must be used on or before its "use by" or "use before" date, if applicable.
 - b. The product must be used in accordance with its labeling and may not be altered or subjected to misuse, abuse, accident or improper handling.
 - c. Medtronic must be notified in writing within thirty (30) days following discovery of any defect or performance issue.
 - d. The product must be returned to Medtronic within thirty (30) days of Medtronic receiving notice as provided for in (3) above.
 - e. Upon examination of the product by Medtronic, Medtronic shall have determined that: (i) the product was not repaired or altered by anyone other than Medtronic or its authorized representative, (ii) the product was not operated under conditions other than normal use, and (iii) the prescribed periodic maintenance and services, if applicable, have been performed on the product
- C. This limited warranty is limited to its express terms. This limited warranty is in lieu of all other warranties, expressed or implied whether statutory or otherwise, including any implied warranty of merchantability or fitness for a particular purpose. In no event shall Medtronic be liable for any consequential, incidental, prospective, or other similar damage resulting from a defect, failure, or malfunction of the product, whether a claim for such damage is based upon the warranty, contract, negligence, or otherwise.
- D. The exclusions and limitations set out above are not intended to, and should not be construed so as to, contravene mandatory provisions of applicable law. Users may benefit from statutory warranty rights under legislation governing the sale of consumer goods. If any part or term of this limited warranty is held by any court of competent jurisdiction to be illegal, unenforceable, or in conflict with applicable law, the validity of the remaining portion of the limited warranty shall not be affected, and all rights and obligations shall be construed and enforced as if this limited warranty did not contain the particular part or term held to be invalid.

*This limited warranty is provided by Medtronic Neurosurgery Group, 4620 North Beach Street, Fort Worth, Texas 76137-4116. It applies only in the United States. Areas outside the United States should contact their local Medtronic representative for terms of the warranty.

After the warranty period, any costs incurred for repair/refurbishing become the responsibility of the customer. This limited warranty does not include the cost associated with any of the factory level service requirements identified in the preventive maintenance schedule. Extended maintenance agreements are available.

Symbols

The following symbols can appear on this device and related packaging.

	Compliant with European Council Directive MDD 93/42/EEC		Serial Number		USA Only
	Authorized Representative in the European Community		Catalog Number		Do not use if package is open or damaged
	Caution: Federal law (USA) restricts this device to sale by or on the order of a physician.		Lot Number		Package Quantity
	Consult Instructions for Use		Package Contents		Double-Locking
	Follow Instructions for Use		Quantity		Diameter
	Caution		Use With		Unlock
	Do not oil.		Finger-Operated Control		Lock
	Do Not Dispose Of This Product In The Unsorted Municipal Waste Stream. Dispose Of This Product According to Local Regulations. See Recycling.Medtronic.com for Instructions On Proper Disposal Of This Product.		Foot-Operated Control		Contains DEHP (di-2-ethyl hexyl phthalate)
	If the single use symbol is on the device label then this device is designed for single patient use only. Do not reuse, reprocess, or resterilize this product. Reuse, reprocessing, or resterilization may compromise the structural integrity of the device and/or create a risk of contamination of the device, which could result in patient injury, illness, or death.		Accessory	TOOL	Tool control
	Non-Sterile		Adapter		Air Pressure Relief
	Sterilized using Irradiation		Attachment		Regulator
	Temperature Limitation		Brush		Lubricant/Diffuser
TUBE	Tube Control		Dissecting Tool		Control Unit
	Manufacturer		Instrument Tray		
	Date of Manufacture		Motor		
	Use By Date		Refurbished		
			Multi-Use Disposable Attachment		
			Part Number		

RxOnly 
0086

Medtronic

175039EN B

2019-02

May be covered by U.S. Patents:
Medtronic.com/patents

©2019 Medtronic, Inc.

Made in USA. Printed in USA.



Medtronic Powered Surgical Solutions
4620 North Beach Street
Fort Worth, Texas 76137 USA
+1 800 433 7080

 Medtronic B.V.

Earl Bakkenstraat 10
6422 PJ Heerlen
The Netherlands
+31 45 566 8000

Medtronic Australian Sponsor:

Medtronic Australasia Pty Ltd
2 Alma Road
Macquarie Park, NSW 2113 Australia

Medtronic of Canada Ltd

99 Hereford Street
Brampton, Ontario L6Y 0R3
Canada
+1 905 460 3800

Europe/Middle East/Africa

Medtronic International Trading Sàrl
Route du Molliiau 31
Case Postale 84
CH- 1131 Tolochenaz
Switzerland
+41 21 802 7000

medtronic.com
manuals.medtronic.com