

*microfluidic*  
**ChipShop**

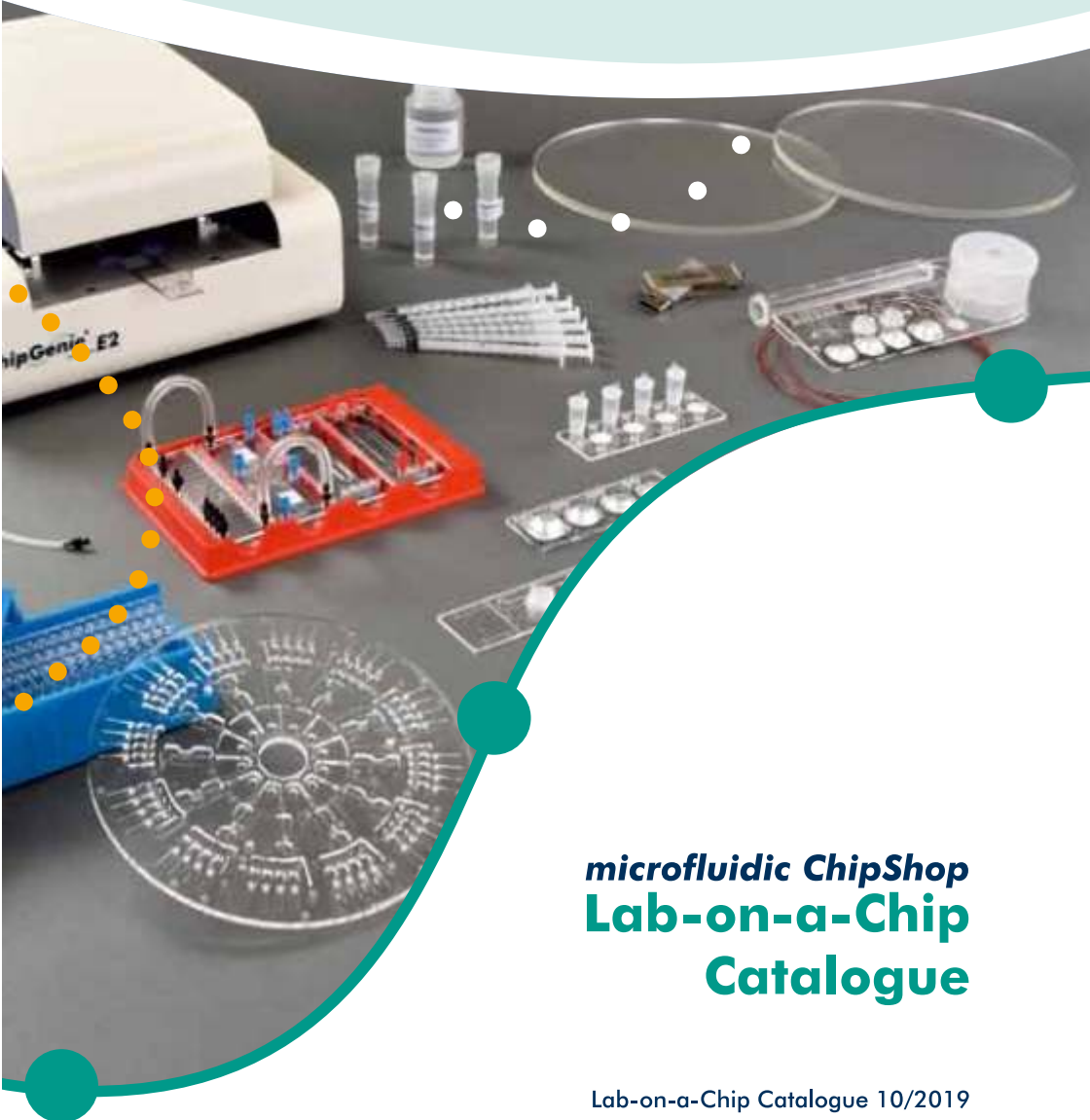

*microfluidic ChipShop*  
**Lab-on-a-Chip  
Catalogue**

Lab-on-a-Chip Catalogue 10/2019



## microfluidic ChipShop

The lab on the chip – miniaturized solutions as easier and faster analytical tools for the life sciences, diagnostics, analytical sciences, and chemistry are at the heart of microfluidic ChipShop’s business.

The company, started in 2002 as a spin-off from the Fraunhofer Institute for Applied Optics and Precision Engineering and the Application Center for Microtechnology Jena, has become a world leader in this rapidly growing technology field. Specialists from microfluidics, precision engineering, polymer microtechnology, medical technology, chemistry, biology, and diagnostics form a multi-disciplinary team to develop and manufacture “lab-on-a-chip” systems mainly in polymers. Using industrial manufacturing techniques allows a seamless transition from development stage through small batch production to mass fabrication, an important role in comprehensive support for our customers.

### Precision manufacturing on the micrometer scale

A unique feature in microfluidic ChipShop’s services is to offer miniaturized components and systems both as self-developed standard products as well as customized solutions from prototype to volume production. microfluidic ChipShop covers the entire value and technology chain, starting from the design of the microstructures, followed by mold-insert fabrication, polymer replication using precision injection molding, hot embossing, or casting, mechanical processing steps up to the biochemical functionalization of surfaces and reagent storage on the chip, and finally, industrial quality control. In addition, microfluidic ChipShop supports customers in the miniaturization of their biological and diagnostic tasks, e.g. in the transfer of biological assays on the chip, the development of PCR protocols for chip-based applications, or the selection of suitable materials for the immobilization of biomolecules. For these means, the company has its own application department.

Furthermore, the development of complete systems including instrument, chip, and associated application protocols is carried out by microfluidic ChipShop examples include systems for the polymerase chain reaction in a continuous flow or chip-based capillary electrophoresis. To implement these highly complex projects, microfluidic ChipShop maintains a worldwide network of research and development collaborations.

In order to fulfill our customers’ needs and to deal with all regulatory issues associated with the development and fabrication of diagnostic and medical devices, microfluidic ChipShop has been certified according to DIN EN ISO 9001 and DIN ISO 13485 since 2003.



## Miniaturized solutions for diagnostics, analytical sciences, and life sciences

Miniaturization has already transformed the world of electronics and became a driver for many markets. Now it's a driving force for an innovation in the life sciences, diagnostics, analytical sciences, and chemistry, which is labeled "lab-on-a-chip." The use of micro- and nano-technologies allows the development of fast, portable, and easy-to-use systems with a high level of functional integration for applications such as point-of-care diagnostics, forensics, the analysis of biomolecules, environmental or food analysis, and drug development. The core of such "lab-on-a-chip" systems are polymer substrates in standard laboratory formats such as microscopy slides or microtiter plates, equipped with tiny structures for the transport and handling of samples. All the functionalities of a chemical or biochemical laboratory, such as the mixing of liquids, aliquoting, the amplification of biomolecules, the synthesis of novel materials, the hybridization of DNA molecules, or the detection of specific substances by optical or electrochemical methods, can be integrated on a single chip. Furthermore, components such as filtration or separation membranes, valves, biochemical sensors, electrodes, and magnetic beads can be integrated into a microstructured polymer substrate.

The integration of biochemical functions on a single chip makes numerous time-consuming and potentially error-prone individual steps redundant, such as multiple pipetting or sample transfer from one device to another.

### Standardization: Established formats – Innovation in the core

Lab-on-a-chip technology as a novel technology offers a wide range of advantages for the different applications and at the same time throws up some challenges. On the one hand, restrictions on using novel tools need to be overcome, while on the other hand the introduction of new technologies needs to be affordable. In order to meet these challenges, *microfluidic ChipShop* drives standardization efforts forcefully:

In chip formats, *microfluidic ChipShop* makes use of existing laboratory standards like the microscopy slide or the microtiter plate, allowing the use of standard laboratory equipment like microscopes, pipettes, or laboratory automation. Directly integrated fluidic interfaces enable an easy chip-to-world coupling and a seamless transfer of liquids from the standard lab to the microworld.

The second major advantage of the strict implementation of the standardization concept is cost. During the development process, an investment in an injection-molding tool is a significant hurdle, especially for small- and medium-scale production. To overcome this obstacle, *microfluidic ChipShop* has various injection-molding tools that can be used on existing platforms – ranging from microscopy slides, microtiter plates, to the CD format – for the integration of custom-specific designs. This approach not only minimizes costs, but it also speeds up the development process, since the time from design release to the first chips in our customers' hands can be reduced significantly.

## **microfluidic ChipShop – Our infrastructure**

In May 2011, *microfluidic ChipShop* moved into its new corporate headquarter, which was extended with a second building in 2015. On a space of approx. 4.700 sqm (approx. 52.000 sqft) the purpose-built facility, located in one of Jena's new industry parks conveniently close to the autobahn, contains all the required infrastructures for your one-stop-shopping in microfluidic development and production. The buildings are organized in four main areas: The first wing contains the precision mechanic workshops. In this area, the design and generation of molding tools, mold inserts and precision machined polymer or metal components takes place. Design data generated by our CAD/CAM team is transformed into parts and tools by our precision and ultraprecision milling and turning machines. These machines as well as equipment for electro-discharge machining (EDM) are placed in a climate-controlled environment with a temperature control of  $\pm 0.5^{\circ}\text{C}$ , partly with especially vibration-isolated foundations.





For the manufacturing of polymer parts using injection molding and hot embossing, a temperature controlled clean space of approx. 400 sqm (4.300 sqft) is provided. The injection molding machines are housed in clean-room hoods in order to reduce the particle load. From this area, the parts are transported into a class 7 cleanroom area of 500 sqm (5.400 sqft) for back-end processing. In this area, processes like surface functionalization, integration of wet and dry reagents, spotting, assembly and packaging takes place. Optical measurement stations including a confocal white-light interferometer and high-precision stereo microscopes are complemented by functional fluidics testing stations for an industrial quality control of our manufactured goods.

The third division contains our biological and biochemical laboratories. In these labs, our team of biologists and chemists develops protocols for on-chip assays, reagent storage solutions or surface modifications for our customers. For this purpose, equipment like spotting tools, PCR machines, lyophilizers or electrophoresis stations is available. These labs also house our microfluidics instrumentation labs, where not only our own instruments, the ChipGenie series, are developed, but also validation experiments for the microfluidic characterization of components and systems are carried out.

The fourth area houses the system development and manufacturing group.

In well-equipped laboratories, our mechanical and electrical engineers develop customer-specific instrumentation for all areas of microfluidics-enabled products which, again, can be validated using our application laboratories. This has been a very rapidly growing business field for the company and allows *microfluidic ChipShop* to offer all aspects of a microfluidic system development from the very first design concepts to an overall manufacturing of instruments and consumables.

Training facilities for up to 200 people and office space for guest scientists and development partners complement our infrastructure offerings.





## The *Lab-on-a-Chip Catalogue* – Shortcut to the world of microfluidics

Offering catalogue devices and development platforms, fulfilling common laboratory standards in their dimensions and interfaces, *microfluidic ChipShop* allows users a quick, low-cost, and low-risk entry into the innovative field of microfluidics. The chips offered within *microfluidic ChipShop's Lab-on-a-Chip Catalogue* cover a range of applications from simple liquid handling, electrophoresis, extraction, or mixing up to sample preparation and complete analytical tasks.

Please enjoy our *Lab-on-a-Chip Catalogue* as your roadmap to microfluidics. We will be more than happy to assist you with our design and fabrication services as well as to discuss your special requirements in the microfluidic world.

Yours,

Dr. Claudia Gärtner  
CEO



# Contents



1 *microfluidic ChipShop's* Lab-on-a-Chip Catalogue 10



2 Materials in microfluidics 11



3 Microfluidic chips – Polymers 21

3.1 Introduction to microfluidic chips 22

3.2 Straight channel chips – Microscope slide format 24

3.3 Straight channel chips – Microtiter-plate format 33

3.4 Cross-shaped channel chips 36

3.5 H-shaped channel chips 43

3.6 Chamber chips 44

3.7 Waste chamber chips 58

3.8 Cuvette chips 60

3.9 Splitter chips 62

3.10 Micro mixer 64

3.11 Titer plates in microscopy slide format 70

3.12 Droplet generator chips and integrated droplet generation solutions 72











3.13 Meander and continuous-flow PCR chips 81

3.14 Sample preparation chips 82

3.15 Cell culture chips 87







3.16 Weir-filter chip 96

# Contents

	3.17 Particle & cell sorting chips	96
	3.18 Gradient chip	99
	3.19 Pillar chip	100
	3.20 Field-flow fractionation chips	101
	3.21 Turning valve chip	102
	3.22 Blister test chips	103
	4 Microfluidic devices for customization and sensor integration	109
	4.1 Open chip platforms for self-assembly	110
	4.2 Self-sealing and releasable chips – slide format	112
	4.3 Sensor integration chips	113
	5 Microfluidic chips – Integrated chips	123
	6 Microfluidic chips – Glass	133
	7 Silicone chips	139
	8 Accessories	145
	9 Polymer substrates and foils	183
	10 ChipGenie® editions – Instruments and applications	189
	11 Special instruments	201
	12 Pumps and pressure controllers	211
	13 Microfluidic kits	237



# Contents

	14 Application development: Assay & reagent implementation	253
	15 Application notes	257
	16 Fabrication services	277
	17 Finally – Some examples	291
	18 One for all – A universal diagnostic platform	301
	18.1 One for all – A partnership with Stratos Product Development for the Bill & Melinda Gates foundation	302
	18.2 In continuation – The ChipGenie® edition Dx series – The universal diagnostic platform	303
	19 Literature	307
	20 Order form	313



# 1 *microfluidic ChipShop's* Lab-on-a-Chip Catalogue



Our mission at *microfluidic ChipShop* is to shrink the biological and chemical laboratory and to bring lab-on-a-chip systems into daily laboratory life.

This catalogue is part of our service to make our mission happen: From off-the-shelf microfluidic chips to complete lab-on-a-chip systems, our products serve a wide range of customer needs.

Whether you need a single chip or thousands, in the following pages you will find the essential components for an easy route into the world of microfluidic handling and manipulation. Be it for the first steps with lab-on-a-chip systems or the evaluation of new designs and functions: you do not need to make up your own design, you avoid tooling costs, and we ensure fast delivery to your doorstep.

Of course, our expertise at *microfluidic ChipShop* extends well beyond the products listed in this catalogue: Whether you seek a competent microfluidic-chip manufacturer, whether you want to translate specific functions into microfluidic designs, whether you need to adopt biological or biochemical assays to a miniaturized format or develop them from scratch for a microfluidic consumable or whether you want to develop entire lab-on-a-chip systems, we are here to help you with our full range of production and development services.

## 2 Materials in microfluidics

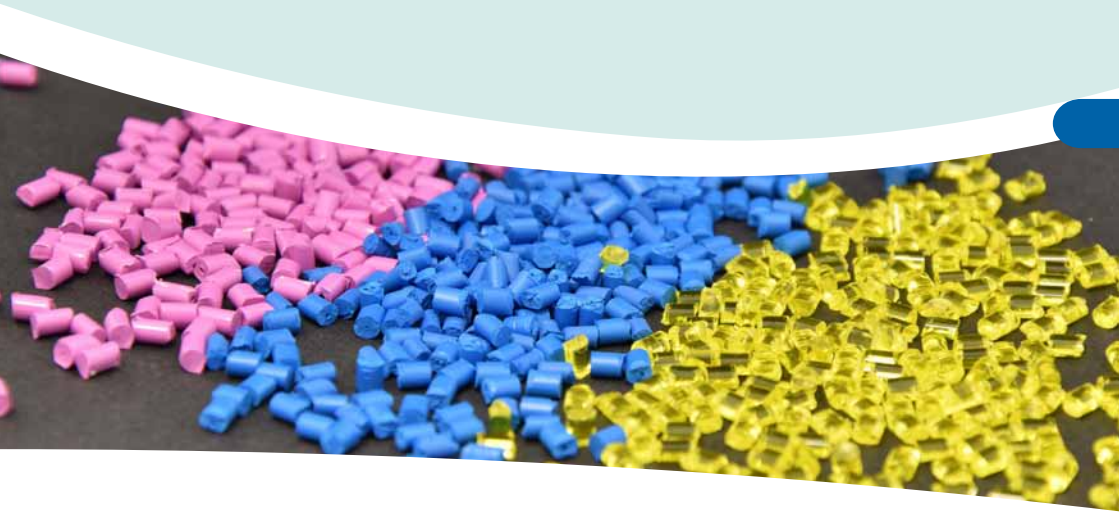

### Materials in microfluidics

Material matters – and a large choice of different materials is at hand ranging from a wide variety of polymers, to glass, silicon, ceramics or metals. All materials have their pros and cons, looking e.g. at cost or geometrical freedom polymers are dominating. This chapter gives guidance through the material choice. Off-the-shelf devices are at hand in polymers and in glass, custom-designs can be offered in all kind of materials and material combinations.





### 2.1 Materials in microfluidics

In microfluidics, a wide variety of materials is in use. Historically, microfluidics and the use as lab-on-a-chip for applications in life sciences or analytical sciences started with technologies being available from semiconductor industries. Consequently, since these technologies were available and allowed for microstructuring, they were used for the first microfluidic devices. Materials that were applicable to be structured by technologies used in semiconductor industries were glass and silicon. First microfluidic devices, besides ink jet printer heads for non-life science microfluidics, were made from glass and silicon, reaching back to the 1970ies with Stephen Terry's gas chromatograph integrated on a silicon wafer, functional but rather expensive.

These semiconductor manufacturing technologies have been available at many engineering institutes, thus these disciplines pioneered in microfluidics due to the availability of elaborate and usually expensive technologies.

Another manufacturing technology arose by simply taking the microstructured silicon devices made by the semiconductor technologies and replicating the structures into a soft polymer in a process called casting (often also referred to as "soft lithography"), just by pouring the liquid polymer onto the silicone matrix, hardening it and removing the soft polymer replicate. This process can be repeated many times, and besides one-time investment in the silicon master, it is from an equipment point of view an extremely low-cost technology. Material used for this process is a special kind of silicone, usually PDMS (Polydimethylsiloxane).

Later on, a merger of conventional fabrication technologies for e.g. standard life science plastic lab ware, namely injection molding, with microtechnology took place. The challenge that had to be overcome to make this technology available for microfluidics was in a first instance the generation of the microstructured master in metals that withstands, depending on the feature sizes, several thousands to several hundred thousand replication cycles. After the replication, assembling technologies needed to be developed. The adoption of industrial replication technologies in combination with the wide variety of commercially available polymers enables a most cost efficient fabrication together with the widest design freedom and is the reason for the current progress made in the commercialization of microfluidic devices.

### 2.2 Materials and underlying technologies

Each material has different characteristics and the technology choice for the micro-structuring has to be made accordingly. An overview on the different technologies being applied is given in Table 1.

**Table 1:** Technologies for microstructuring of different materials

Material	Technology	Comment
Metal	<ul style="list-style-type: none"><li>• Precision mechanical machining</li><li>• Laser machining</li><li>• Electro discharge machining</li></ul>	
Silicon	<ul style="list-style-type: none"><li>• Wet chemical etching</li><li>• Dry etching (DRIE)</li></ul>	
Glass	<ul style="list-style-type: none"><li>• Wet chemical etching</li><li>• Direct laser structuring</li><li>• Powder or sandblasting</li><li>• Photostructuring</li></ul>	
Elastomers	<ul style="list-style-type: none"><li>• Casting</li></ul>	
Thermoplastic polymers	<ul style="list-style-type: none"><li>• Injection molding</li><li>• Thermoforming</li><li>• Hot embossing</li><li>• Laser machining</li><li>• Precision mechanical machining</li></ul>	Injection molding as replicative technology allows for the most cost-efficient fabrication of microstructured devices. Thermoforming is mainly used for generating blister packs.



The fabrication of a lab-on-a-chip system requires more than just the microstructured part. Usually at least a cover lid needs to be placed on the microstructures, requiring special assembly technologies.

For glass and silicon, established processes are at hand, easily exceeding 100°C temperature, even for “cold” processes. The elastomer silicone can be easily mounted onto itself or glass and silicon, but the joint can be released. For thermoplastic polymers, several technologies are at hand allowing to join parts without harming microstructures and working without elevated temperatures, preserving embedded reagents or deposited biomolecules.

### 2.3 Glass versus polymers

The comparison of two main materials in microfluidics, namely glass and polymers, shows their specific strengths and weaknesses.

Glass and the standard thermoplastic polymers being in use in microfluidics are highly optically transparent.

Table 2 summarizes pros and cons of glass versus polymers.

**Table 2:** Characteristics of glass and polymers

Optics	Standard thermoplasts	Glass
Transparency	• Good	• Good
Autofluorescence	• Low (right polymer choice important)	• Low
Application in UV region	• In near UV special polymers available	• Quartz glass needs to be chosen
Surface roughness	<ul style="list-style-type: none"> <li>• Depending on mold insert quality.</li> <li>• Can be optically smooth.</li> <li>• Rough surface after direct mechanical machining</li> </ul>	• Smooth for wet etched devices, rough surface after powderblasting or laser machining. Afterward chemical polishing possible.
Thermal stability	<ul style="list-style-type: none"> <li>• Depending on the polymer choice. Standard polymers used for PCR application withstand 100°C and slightly higher temperatures.</li> </ul>	• Usually transfers to liquid phase around 600°C for many glasses
Stability against organic solvents	• Limited	• High
Stability against standard solvents in life sciences (acetone, alcohol)	• Polymers available	• High
Stability against acidic solutions	• High	• High
Stability against basic solutions	• High	• Medium
Unspecific binding of biological components	• Polymers with low unspecific binding available. Surface functionalization to avoid this problem available	• High. Surface functionalization to avoid this problem available
<b>Part design</b>		
Design freedom	• High	• Low
Combination of different structural depths in one device	• Easy	• Difficult and more than one depth directly increases the price
Direct integration of fluidic interfaces	• Easy – directly in the injection molded part	• Difficult, usually an afterwards assembling process of a non-glass-component
Direct integration of e.g. reservoirs	• Easy – directly in the injection molded part	• Limited. Large structures cannot be integrated as glass part due to cost issues.



Additional functionalities	Standard thermoplasts	Glass
Integration of liquid and dry reagents in the chip	<ul style="list-style-type: none"> <li>• Easy</li> </ul>	<ul style="list-style-type: none"> <li>• Limited to impossible. For bioreagents like enzymes with limited thermal stability impossible.</li> </ul>
Integration of hybrid components like filters	<ul style="list-style-type: none"> <li>• Easy</li> </ul>	<ul style="list-style-type: none"> <li>• Limited to impossible</li> </ul>
Integration of valves on chip	<ul style="list-style-type: none"> <li>• Easy</li> </ul>	<ul style="list-style-type: none"> <li>• Limited to passive and elastomeric membrane valves</li> </ul>
Fabrication		
Material cost	<ul style="list-style-type: none"> <li>• Low to medium, 2 – 20 € / kg</li> </ul>	<ul style="list-style-type: none"> <li>• High</li> </ul>
Highest price impact	<ul style="list-style-type: none"> <li>• Replication (microstructuring) has a negligible impact!</li> <li>• Assembly</li> </ul>	<ul style="list-style-type: none"> <li>• Footprint of the device. E.g. already the material price for a microfluidic chip in the format of a microscopy slide is a few € (depending on material choice).</li> <li>• Microstructuring</li> <li>• Assembly</li> </ul>

Possessing different characteristics and financial benefits, polymers will always be used when glass is not required, since they are the cheaper devices. Glass is of interest if elevated temperatures are necessary, much above 100°C, what is usually not the case in life sciences, and if specific organic solvents should be used.

If bioreagents should be stored on-chip, complex fluids, hybrid components like membranes are necessary, valves should be part of the device etc. polymers will be the material of choice.

Furthermore, interfaces, reservoirs and different structural depths do not impact the price of the device in polymers, but partly are impossible to be implemented in a glass device or massively increase cost.

### 2.4 Polymers in microfluidics

Polymers used in microfluidic are mainly transparent thermoplastic polymers. Most popular are PMMA (Polymethylmetacrylate), COC (Cyclo-olefin-copolymer, tradename “Topas”), COP (Cyclo-olefin-polymer, tradenames “Zeonor” and “Zeonex”), PC (Polycarbonate) and PS (Polystyrene). Topas and Zeonor have outstanding optical characteristics, very low water uptake and extremely low permeability for water vapour. Furthermore, they withstand polar organic solvents like acetone and isopropanol frequently used in life sciences.

**Table 3:** Standard polymers used at *microfluidic ChipShop* – PMMA

Material	Grades	Description
PMMA – Polymethylmetacrylate	mcs-PMMA-08 <ul style="list-style-type: none"> <li>• T<sub>g</sub>: 110°C</li> <li>• Refractive index: 1.49</li> </ul> mcs-foil-013 <ul style="list-style-type: none"> <li>• 175 μm thickness</li> <li>• T<sub>g</sub>: 113°C</li> <li>• Refractive index: 1.48</li> </ul>	<b>PMMA</b> is a transparent thermoplastic, often used as a light-weight or shatter-resistant alternative to glass. It is sometimes called acrylic glass or Plexiglass. Chemically, it is the synthetic polymer of methyl methacrylate. PMMA is an acrylate polymer with an ester-group. This can be used to modify the surface chemically.
Chemical Resistance:		
Can be used with:		Not to be used with:
<ul style="list-style-type: none"> <li>• Aqueous solutions including diluted acids and bases</li> <li>• Aldehydes</li> <li>• Amines</li> <li>• Oils and Fats</li> </ul>		<ul style="list-style-type: none"> <li>• Concentrated acids and bases</li> <li>• Alcohols</li> <li>• Esters</li> <li>• Ketones</li> <li>• Aromatics</li> <li>• halogenated hydrocarbons</li> </ul>

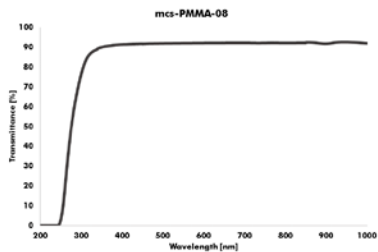

Fig. 1: Transmission spectrum of 1.5 mm thick microscopy slide of mcs-PMMA-08

Table 4: Standard polymers used at microfluidic ChipShop – PC

Material	Grades	Description
PC – Polycarbonate	mcs-PC-13 <ul style="list-style-type: none"> <li>• T<sub>g</sub>: 145°C</li> <li>• Refractive index: 1.58</li> </ul> mcs-foil-042 <ul style="list-style-type: none"> <li>• 175 μm thickness</li> <li>• T<sub>g</sub>: 145°C</li> <li>• Refractive index: 1.58</li> </ul>	<b>PC</b> is thermoplastic polymer. Compared to other materials used in microfluidics like Zeonor or Topas it is less hydrophobic and therefore, the channels show a better filling behaviour. It can be used for higher temperature applications like e.g. PCR. The drawback of this material is the relatively high intrinsic fluorescence in particular of the available foil material, compared e.g. to Topas, Zeonor or PMMA.
Chemical Resistance:		
Can be used with:		Not to be used with:
<ul style="list-style-type: none"> <li>• Diluted acids</li> <li>• Oils, fats</li> <li>• Alcohols</li> </ul>		<ul style="list-style-type: none"> <li>• Bases</li> <li>• Esters</li> <li>• Ketones, Aldehydes</li> <li>• Amines</li> <li>• Aromatics</li> </ul>

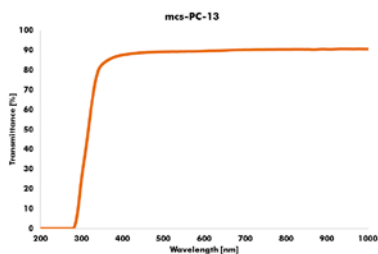

Fig. 2: Transmission spectrum of 1.0 mm thick microscopy slide of mcs-PC-13



## 2 Materials

**Table 5:** Standard polymers used at *microfluidic ChipShop* – PS

Material	Grades	Description
mcs-PS-17	mcs-PS-17 • T <sub>g</sub> : 100°C • Refractive index: 1.57 mcs-foil-095 • 125 μm thickness • T <sub>g</sub> : 100°C	<b>PS</b> is a thermoplastic polymer. Polystyrene (PS) is an aromatic polymer made from the monomer styrene. Polystyrene can be rigid or foamed. General purpose polystyrene is clear, hard and brittle. It is a very inexpensive resin per unit weight. It is a rather poor barrier to oxygen and water vapor and has relatively low melting point. PS is one of the standard material conventionally used in the life sciences also due to its relatively low price. E.g. microtiter plates are usually made from PS.
Chemical Resistance:		
Can be used with:		Not to be used with:
<ul style="list-style-type: none"> <li>• Bases</li> <li>• Butyl alcohol, ethylene glycol</li> <li>• Isopropanol (at room temperature)</li> <li>• Organic acids like citric acids, formic acids, tartaric acids</li> <li>• Diluted inorganic acids at lower temperatures (except hydrofluoric acids)</li> <li>• Mineral oil</li> <li>• Hydrogen oxide</li> </ul>		<ul style="list-style-type: none"> <li>• Ketones</li> <li>• Esters</li> <li>• Ethers</li> <li>• Halogenated organic reagents</li> <li>• Hydrocarbons (mineral oil works)</li> </ul>

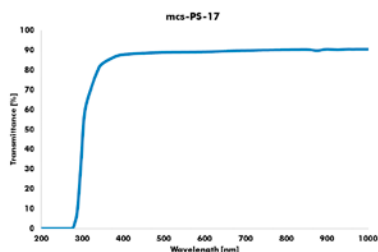

Fig. 3: Transmission spectrum of 1.0 mm thick microscopy slide of mcs-PS-17

**Table 6:** Standard polymers used at *microfluidic ChipShop* – Topas (COC)

Material	Grades	Description
Topas (COC)	mcs-COC-13 • T <sub>g</sub> : 142°C • Refractive index: 1.53 mcs-foil-011 • 140 μm thickness • T <sub>g</sub> : 78°C • Refractive index: 1.53 mcs-foil-081 • 175 μm thickness • T <sub>g</sub> : 142°C • Refractive index: 1.53	<b>Topas</b> is thermoplastic polymer. It is cyclo-olefin copolymer (COC). It is completely nonpolar and amorphous. It has a very low permeability for water vapour and a low capacity for the absorption of water. Please be aware that mcs-foil-011 is not suitable for high temperature applications as it features a T <sub>g</sub> of around 75°C, instead mcs-foil-081 should be chosen for those kinds of applications.
Chemical Resistance:		
Can be used with:		Not to be used with:
<ul style="list-style-type: none"> <li>• Aqueous solutions including acids and bases</li> <li>• Polar solvents</li> <li>• Can be used with mcs-oil-04</li> <li>• Silicone oil</li> </ul>		<ul style="list-style-type: none"> <li>• Nonpolar solvents</li> <li>• Mineral oils (hydrocarbons)</li> <li>• Fats</li> <li>• Halogenated hydrocarbons</li> </ul>



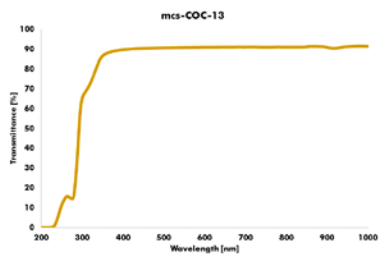

Fig. 4: Transmission spectrum of 1.0 mm thick microscopy slide of mcs-COC-13

**Table 7:** Standard polymers used at *microfluidic ChipShop* – Zeonor (COP)

Material	Grades	Description
Zeonor (COP)	mcs-COP-02 <ul style="list-style-type: none"> <li>• T<sub>g</sub>: 136°C</li> <li>• Refractive index: 1.53</li> </ul> mcs-foil-005 <ul style="list-style-type: none"> <li>• 188 μm thickness</li> <li>• T<sub>g</sub>: 134°C</li> <li>• Refractive index: 1.53</li> </ul>	<b>Zeonor</b> is a thermoplastic polymer. Zeonor is a cyclo-olefin polymer (COP). It is completely nonpolar and amorphous. It has a very low permeability for water vapour and a low capacity for the absorption of water.
Chemical Resistance:		
Can be used with:		Not to be used with:
<ul style="list-style-type: none"> <li>• Aqueous solutions including acids and bases</li> <li>• Polar solvents</li> <li>• Can be used with mcs-oil-04</li> <li>• Silicone oil</li> </ul>		<ul style="list-style-type: none"> <li>• Nonpolar solvents</li> <li>• Mineral oils (hydrocarbons)</li> <li>• Fats</li> <li>• Halogenated hydrocarbons</li> </ul>

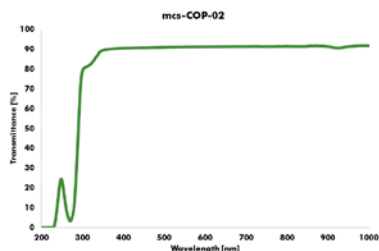

Fig. 5: Transmission spectrum of 1.0 mm thick microscopy slide of mcs-COP-02



**Table 8:** Standard polymers used at microfluidic ChipShop – Zeonex (COP)

Material	Grades	Description
Zeonex (COP)	mcs-COP-04 <ul style="list-style-type: none"> <li>• Tg: 134°C</li> <li>• Refractive index: 1.53</li> </ul> mcs-foil-005 <ul style="list-style-type: none"> <li>• 188 <math>\mu\text{m}</math> thickness</li> <li>• Tg: 134°C</li> <li>• Refractive index: 1.53</li> </ul>	<b>Zeonex</b> is thermoplastic polymer. Zeonex is a cyclo-olefin polymer (COP). It is completely nonpolar and amorphous. It has a very low permeability for water vapour and a low capacity for the absorption of water.

Chemical Resistance:

Can be used with:

- Aqueous solutions including acids and bases
- Polar solvents
- Can be used with mcs-oil-04
- Silicone oil

Not to be used with:

- Nonpolar solvents
- Mineral oils (hydrocarbons)
- Fats
- Halogenated hydrocarbons

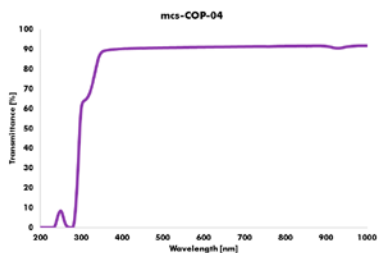
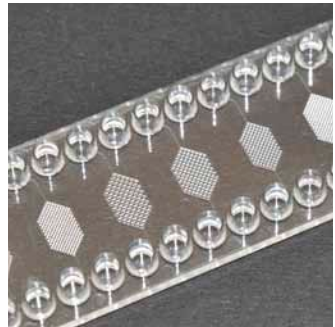
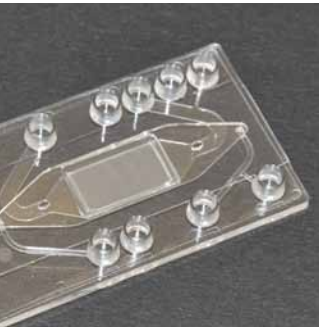
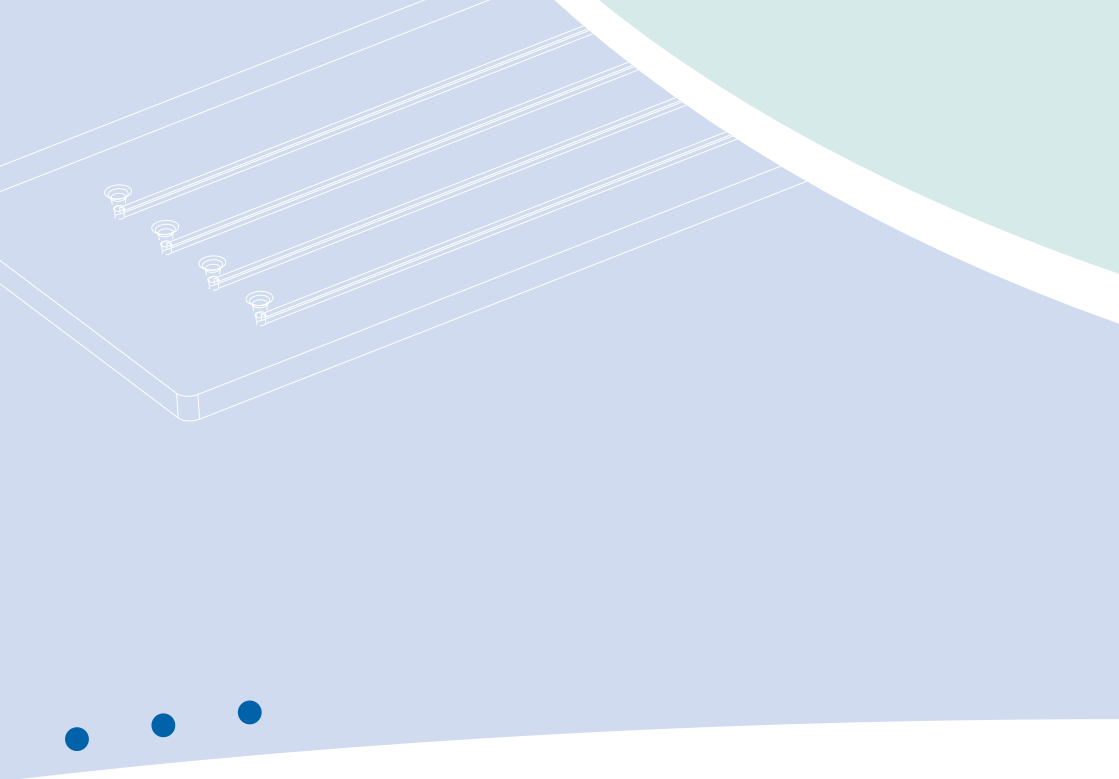

Fig. 6: Transmission spectrum of 1.0 mm thick microscopy slide of mcs-COP-04

Literature:

- [1] Khanarian, G., Optical properties of cyclic olefin copolymers, *Optical Eng.* 40 (6), 1024-1029, 2001.
- [2] Becker, H., Locascio, L.E., Polymer microfluidic devices, *Talanta* 56, 267–287, 2002.
- [3] Soper, S.A., Henry, A.C., Vaidya, B., Galloway, M., Wabuyele, M., McCarley, R.L., Surface modification of polymer-based microfluidic devices, *Anal Chim Acta* 470, 87–99, 2002.
- [4] Alvaro, M., Fleischman, A.J., Roy, S., Characterization of Polydimethylsiloxane (PDMS) Properties for Biomedical Micro/Nanosystems, *Biomed. Microdev.* 7 (4), 281-293, 2005.
- [5] Piruska, A., Nikcevic, I., Lee, S.H., Ahn, C., Heineman, W.R., Limbach, P.A., Seliskar, C.J., The autofluorescence of plastic materials and chips measured under laser irradiation, *Lab Chip* 5(12), 1348–1354, 2005.
- [6] Fredrickson, C.K., Xia, Z., Das, C., Ferguson, R., Tavares, F.T., Fan, Z.H., Effects of fabrication process parameters on the properties of cyclic olefin copolymer microfluidic devices, *J Microelectromech Syst* 15(5), 1060–1068, 2006.
- [7] Shadpour, H., Musyimi, H., Chen, J.F., Soper, S.A., Physicochemical properties of various polymer substrates and their effects on microchip electrophoresis performance. *J Chromatogr A* 1111(2), 238–251, 2006.
- [8] Stachowiak, T.B., Mair, D.A., Holden, T.G., Lee, L.J., Svec, F., Fréchet, J.M., Hydrophilic surface modification of cyclic olefin copolymer microfluidic chips using sequential photografting, *J Sep Sci.*, 30(7):1088-93, 2007.
- [9] Becker, H.; Gärtner, C. *Polymer Microfabrication Technologies for Microfluidic Systems*, *Anal. Bioanal. Chem.*, 390, 89–111, 2008.
- [10] Li, S. et al., Review of production of microfluidic devices: material, manufacturing and metrology, *Proc. SPIE* 6993, MEMS, MOEMS, and Micromachining III, 69930F-69930F-12, 2008. DOI: 10.1117/12.781942.
- [11] Berthier, E.; Young, E.W. K.; Beebe, D. Engineers Are from PDMS-Land, Biologists Are from Polystyrenia, *Lab Chip*, 12, 1224–1237, 2012.
- [12] van Midwoud, P.M., Janse, A., Merema, M.T., Groothuis, G.M., Verpoorte, E., Comparison of biocompatibility and adsorption properties of different plastics for advanced microfluidic cell and tissue culture models, *Anal Chem.*, 84(9), 3938-3944, 2012.
- [13] Ren, K., Zhou, J., Wu, H., *Materials for Microfluidic Chip Fabrication*, *Acc. Chem. Res.*, 46 (11), 2396–2406, 2013.
- [14] Lei, K.F., *Materials and Fabrication Techniques for Nano- and Microfluidic Devices*, in: *Microfluidics in Detection Science: Lab-on-a-chip Technologies*, Royal Society of Chemistry, London, 1-28, 2014.





## 3 Microfluidic chips – Polymers

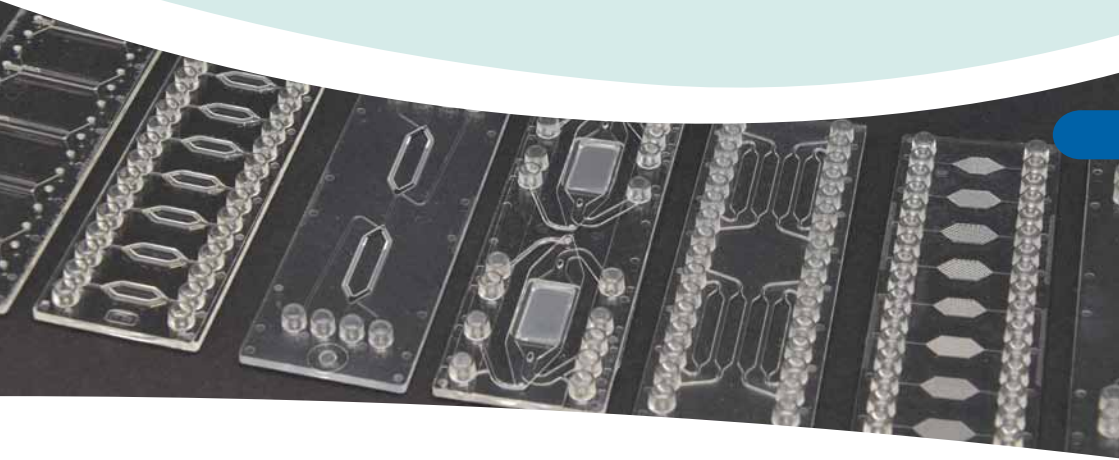

### Microfluidic chips – Polymers

Ready-to-go microfluidic chips – this chapter summarizes various kinds of standard chips such as simple straight channels, cross-shaped channel chips for electrophoresis, extractors, micro-mixers, droplet generators, and nanotiter plates.

Taking our standardization principles into account, all these chips have the format of a microscopy slide or a microtiter plate. The spacing between the fluidic interfaces either corresponds with the spacing of a 96 or 384 well plate, namely 4.5 mm or 9 mm respective distance from center to center of the wells. All polymer chips have the fluidic interconnects on the top and the microfluidic structure on the bottom side. The micro structures are sealed with a cover lid of identical material. The thickness of the respective cover lid is indicated in the product.

#### 3.1 Introduction to microfluidic chips

Microfluidic chips can vary greatly in their design and complexity. However, a few design features most chips have in common: the injection molded chip body with a microfluidic channel/chamber network, a cover lid and fluidic interfaces. The following two pages will guide you through the world of basic chip design and will help you to choose a chip layout tailored to your experimental requirements.

#### Microfluidic chip components

The most important components of a microfluidic chip are illustrated below. Beside basic functionalities chips can for example furthermore feature blisters for liquid storage, valves for steering liquids within the chip or integrated sampling areas.

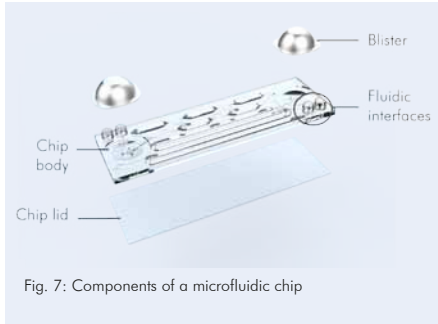

Fig. 7: Components of a microfluidic chip

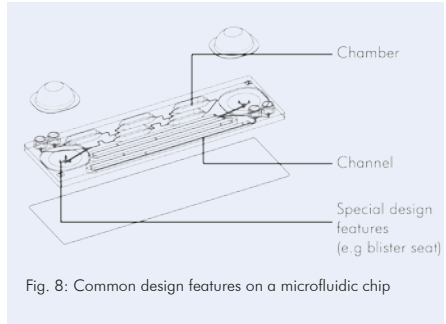

Fig. 8: Common design features on a microfluidic chip

#### Chip interfaces

In order to connect the microfluidic chip to tubing or to introduce liquid e.g. via pipetting each chip contains fluidic interfaces. The four standard interfaces, featured on *microfluidic ChipShop* chips are outlined in the following.

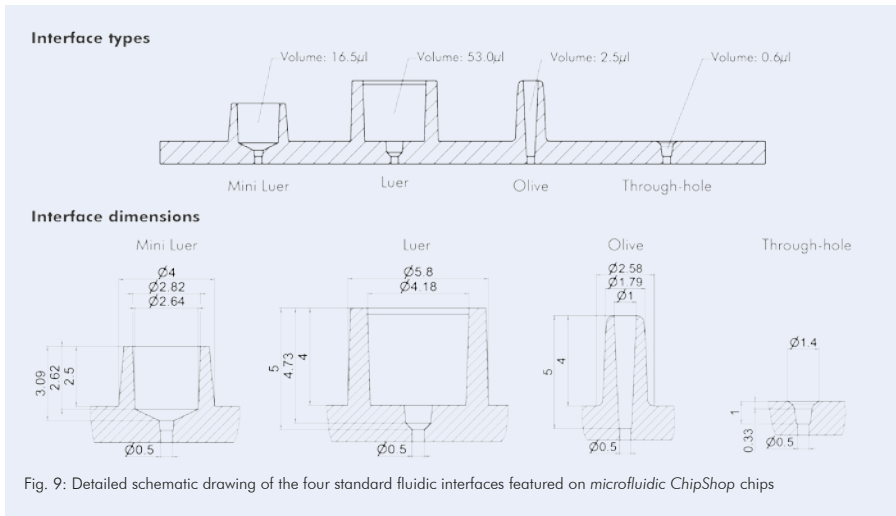

Fig. 9: Detailed schematic drawing of the four standard fluidic interfaces featured on *microfluidic ChipShop* chips



### Chip formats

Most of our off-the-shelf microfluidic chips come in microscope slide format (75.5 mm x 25.5 mm x 1.5 mm). However, other standard chip formats such as double slide format (75.5 mm x 50mm x 1.5 mm) and microtiter plate format (85.48 mm x 127.76 mm) are available. When developing a customer-specific chip design, tailored custom-formats can be introduced. Please refer to Chapter 16 to learn more about our fabrication services.

For the standard microscope slide format, the microfluidic interfaces can be either positioned at the short or long side of the chip.

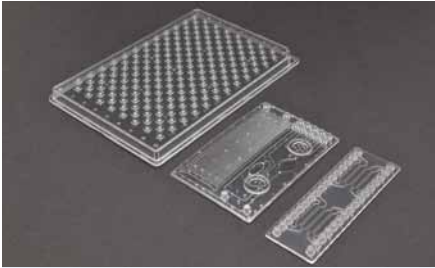

Fig. 10: Standard chip formats - microtiter plate, double slide and microscope slide formats

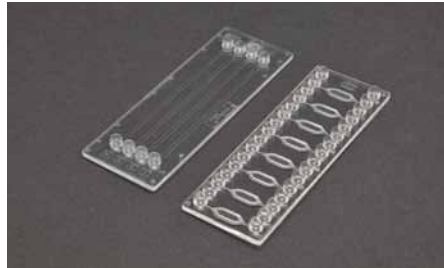

Fig. 11: Interface positioning on a slide format chip. Interfaces at the short side with lengthwise channel orientation (left) and interfaces at the long side with crosswise chamber orientation (right)

### The right accessories

A microfluidic experiment requires in most cases a lot more than just the microfluidic chip. *microfluidic ChipShop* offers a variety of connectors and tubing that have been particularly designed to be used with most of our off-the-shelf standard chips. Please refer to Chapter 8 to find exactly the accessories you need for your experiment.



Fig. 12: A Luer connector mounted on a Luer interface with attached tubing



Fig. 13: Liquid storage, chip positioning and connection - accessories serve many purposes

### Surface modification

Thermoplastic materials are natively hydrophobic with water contact angles  $>80^\circ$ . However, most of our off-the-shelf chips can also be purchased as hydrophilized versions, which have undergone a physical hydrophilization process.

### Chip handling

We recommend to wear gloves at all times, when handling microfluidic chips. This precaution will ensure prolonged chip tentability by preventing unwanted contamination or stains.

#### 3.2 Straight channel chips – Microscope slide format

On the format of a microscope slide (75.5 mm x 25.5 mm x 1.5 mm), microfluidic channels in various widths and depths are available. The channel distance from center to center is 4.5 mm according to the spacing of a 384 microtiter plate. The fluidic chips are available with simple through-holes fitting to normal pipette tips, and Mini Luer interfaces that can be used with the respective counterpart. Alternatively, standard Luer interfaces are convenient, as are olives integrated on the chip to be directly connected with silicone tubing, for example. Channels can be orientated crosswise or lengthwise on the chip.

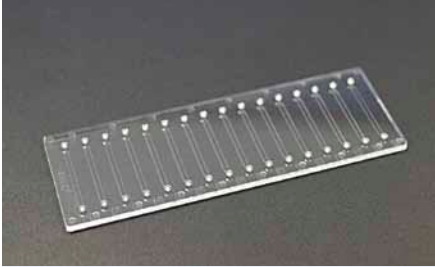

Fig. 14: Microfluidic chip – 16-channel through-hole chip family with crosswise channels

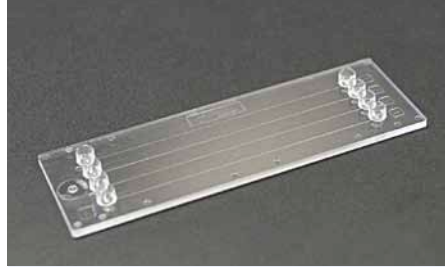

Fig. 15: Microfluidic chip – 4-channel Mini Luer chip family with lengthwise channels

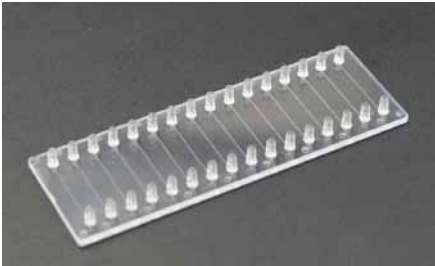

Fig. 16: Microfluidic chip – 16-channel Olives chip family

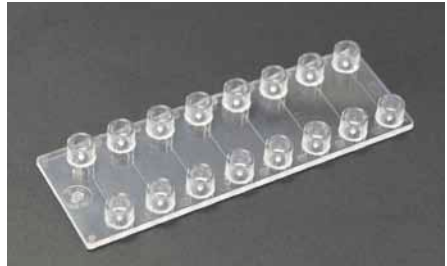

Fig. 17: Microfluidic chip – 8-channel Luer chip family

#### 3.2.1 Straight channel chips – Channel orientation: lengthwise

##### 3.2.1.1 Straight channel chips – Channel orientation: lengthwise Fluidic interface: Through-holes

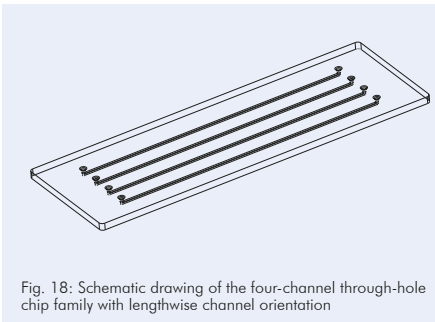

Fig. 18: Schematic drawing of the four-channel through-hole chip family with lengthwise channel orientation

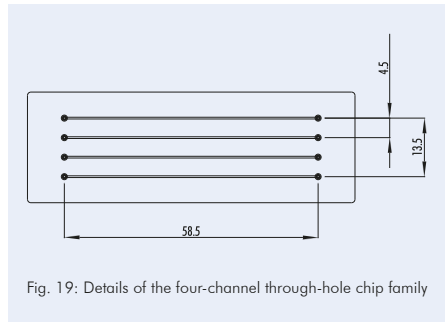

Fig. 19: Details of the four-channel through-hole chip family





Product Code	Fluidic	Number of Channels	Channel			Cover Lid Thickness [μm]	Material	Price [€/chip]		
			Width [μm]	Depth [μm]	Length [mm]			1+	10+	30+
10000036	143	4	20	20	58.5	175	PMMA	42.50	31.20	23.50
10000037	143	4	20	20	58.5	140	Topas	42.50	31.20	23.50
10000191	145	4	50	50	58.5	175	PMMA	42.50	31.20	23.50
10000192	145	4	50	50	58.5	140	Topas	42.50	31.20	23.50
10000193	144	4	100	100	58.5	175	PMMA	42.50	31.20	23.50
10000194	144	4	100	100	58.5	140	Topas	42.50	31.20	23.50
10000185	156	4	200	200	58.5	175	PMMA	36.20	24.30	18.10
10000186	156	4	200	200	58.5	140	Topas	36.20	24.30	18.10
10000189	180	4	800	20	58.5	175	PMMA	36.20	24.30	18.10
10000190	180	4	800	20	58.5	140	Topas	36.20	24.30	18.10
10000187	138	4	1,000	200	58.5	175	PMMA	36.20	24.30	18.10
10000188	138	4	1,000	200	58.5	140	Topas	36.20	24.30	18.10

3.2.1.2 Straight channel chips – Channel orientation: lengthwise – Fluidic interface: Olives

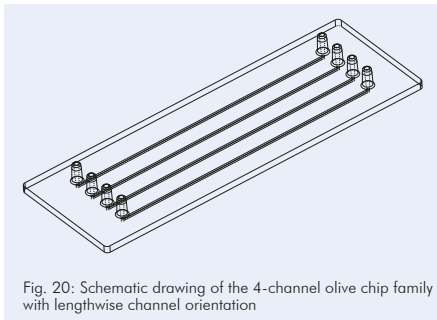

Fig. 20: Schematic drawing of the 4-channel olive chip family with lengthwise channel orientation

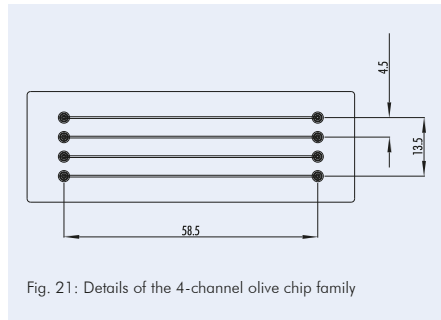

Fig. 21: Details of the 4-channel olive chip family

Product Code	Fluidic	Number of Channels	Channel			Cover Lid Thickness [μm]	Material	Price [€/chip]		
			Width [μm]	Depth [μm]	Length [mm]			1+	10+	30+
10000207	143	4	20	20	58.5	175	PMMA	42.50	31.20	23.50
10000208	143	4	20	20	58.5	140	Topas	42.50	31.20	23.50
10000209	145	4	50	50	58.5	175	PMMA	42.50	31.20	23.50
10000210	145	4	50	50	58.5	140	Topas	42.50	31.20	23.50
10000211	144	4	100	100	58.5	175	PMMA	42.50	31.20	23.50
10000212	144	4	100	100	58.5	140	Topas	42.50	31.20	23.50
10000213	156	4	200	200	58.5	175	PMMA	36.20	24.30	18.10
10000214	156	4	200	200	58.5	140	Topas	36.20	24.30	18.10
10000215	180	4	800	20	58.5	175	PMMA	36.20	24.30	18.10
10000216	180	4	800	20	58.5	140	Topas	36.20	24.30	18.10
10000217	138	4	1,000	200	58.5	175	PMMA	36.20	24.30	18.10
10000218	138	4	1,000	200	58.5	140	Topas	36.20	24.30	18.10

#### 3.2.1.3 Straight channel chips – Channel orientation: lengthwise Fluidic interface: Mini Luer

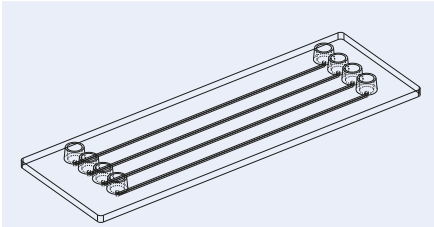

Fig. 22: Schematic drawing of the four-channel Mini Luer chip family

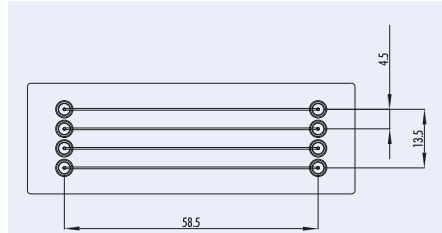

Fig. 23: Details of the four-channel Mini Luer chip family

Product Code	Fluidic	Number of Channels	Channel			Cover Lid Thickness [μm]	Material	Price [€/chip]		
			Width [μm]	Depth [μm]	Length [mm]			1+	10+	30+
10000038	143	4	20	20	58.5	175	PMMA	42.50	31.20	23.50
10000039	143	4	20	20	58.5	140	Topas	42.50	31.20	23.50
10000086	145	4	50	50	58.5	175	PMMA	42.50	31.20	23.50
10000087	145	4	50	50	58.5	140	Topas	42.50	31.20	23.50
10000088	144	4	100	100	58.5	175	PMMA	42.50	31.20	23.50
10000089	144	4	100	100	58.5	140	Topas	42.50	31.20	23.50
10000090	156	4	200	200	58.5	175	PMMA	36.20	24.30	18.10
10000091	156	4	200	200	58.5	140	Topas	36.20	24.30	18.10
10000108	180	4	800	20	58.5	175	PMMA	36.20	24.30	18.10
10000109	180	4	800	20	58.5	140	Topas	36.20	24.30	18.10
10000106	138	4	1,000	200	58.5	175	PMMA	36.20	24.30	18.10
10000107	138	4	1,000	200	58.5	140	Topas	36.20	24.30	18.10

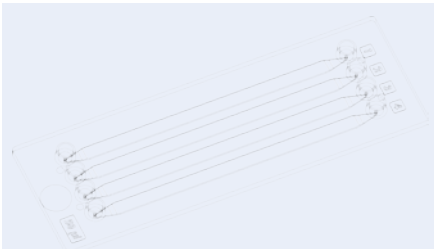

Fig. 24: Schematic drawing of the four-channel Mini Luer chip Fluidic 560

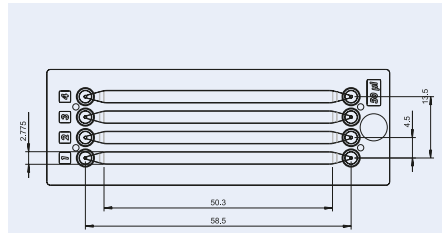

Fig. 25: Channel chip Fluidic 560 with a total channel volume of 50 μl



Product Code for Fluidic 560	Number of Channels	Channel				Lid Thickness [ $\mu\text{m}$ ]	Material	Surface Treatment	Price [€/chip]		
		Volume [ $\mu\text{l}$ ]	Width [ $\mu\text{m}$ ]	Depth [ $\mu\text{m}$ ]	Length [mm]				1+	10+	100+
10000571	4	50	2,775	350	58.5	140	Topas	-	36.20	24.30	16.10
10000572	4	50	2,775	350	58.5	175	PC	-	36.20	24.30	16.10
10000830	4	50	2,775	350	58.5	188	Zeonor	-	36.20	24.30	16.10
10000831	4	50	2,775	350	58.5	125	PS	-	36.20	24.30	16.10
10000574	4	50	2,775	350	58.5	140	Topas	hydrophilized	39.20	26.30	17.80
10000575	4	50	2,775	350	58.5	175	PC	hydrophilized	39.20	26.30	17.80
10000576	4	50	2,775	350	58.5	188	Zeonor	hydrophilized	39.20	26.30	17.80
10000940	4	50	2,775	350	58.5	125	PS	hydrophilized	39.20	26.30	17.80

### 3.2.1.4 Straight channel chips – Channel orientation: lengthwise – Fluidic interface: Luer

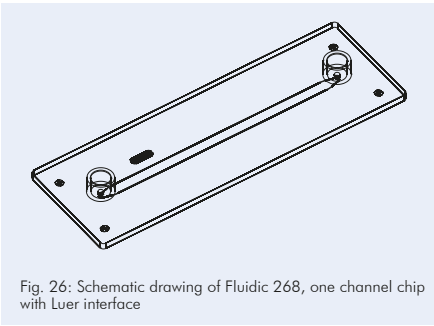

Fig. 26: Schematic drawing of Fluidic 268, one channel chip with Luer interface

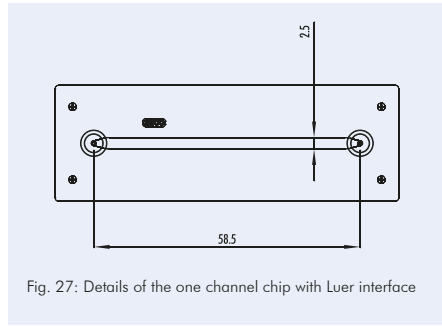

Fig. 27: Details of the one channel chip with Luer interface

Product Code for Fluidic 268	Number of Channels	Channel			Lid Thickness [ $\mu\text{m}$ ]	Material	Surface treatment	Price [€/chip]		
		Width [ $\mu\text{m}$ ]	Depth [ $\mu\text{m}$ ]	Length [mm]				1+	10+	100+
10000246	1	2,500	150	58.5	175	PMMA	-	36.20	24.30	18.10
10000247	1	2,500	150	58.5	188	Zeonor	-	36.20	24.30	18.10
10001134	1	2,500	150	58.5	140	Topas	-	36.20	24.30	18.10
10000249	1	2,500	150	58.5	175	PMMA	hydrophilized	46.20	29.30	19.98
10000248	1	2,500	150	58.5	188	Zeonor	hydrophilized	46.20	29.30	19.98
10001135	1	2,500	150	58.5	140	Topas	hydrophilized	46.20	29.30	19.98



#### 3.2.2 Straight channel chips – Channel orientation: crosswise

##### 3.2.2.1 Straight channel chips – Channel orientation: crosswise

##### Fluidic interface: Through-holes

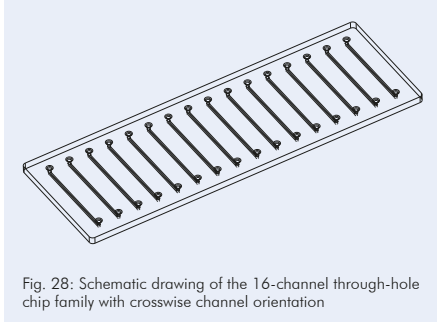

Fig. 28: Schematic drawing of the 16-channel through-hole chip family with crosswise channel orientation

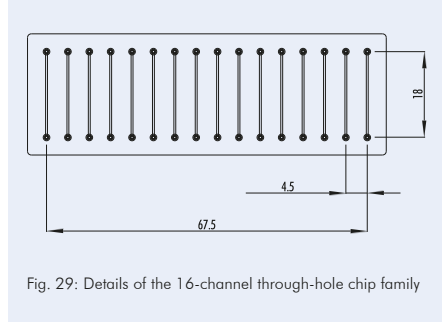

Fig. 29: Details of the 16-channel through-hole chip family

Product Code	Fluidic	Number of Channels	Channel			Cover Lid Thickness [ $\mu\text{m}$ ]	Material	Price [€/chip]		
			Width [ $\mu\text{m}$ ]	Depth [ $\mu\text{m}$ ]	Length [mm]			1+	10+	30+
10000195	142	16	200	100	18.0	175	PMMA	36.20	24.30	18.10
10000196	142	16	200	100	18.0	140	Topas	36.20	24.30	18.10
10000197	152	16	1,000	200	18.0	175	PMMA	36.20	24.30	18.10
10000198	152	16	1,000	200	18.0	140	Topas	36.20	24.30	18.10

##### 3.2.2.2 Straight channel chips – Channel orientation: crosswise – Fluidic interface: Olives

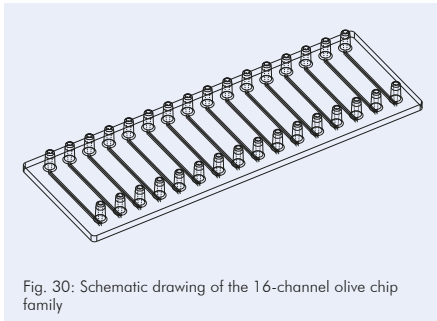

Fig. 30: Schematic drawing of the 16-channel olive chip family

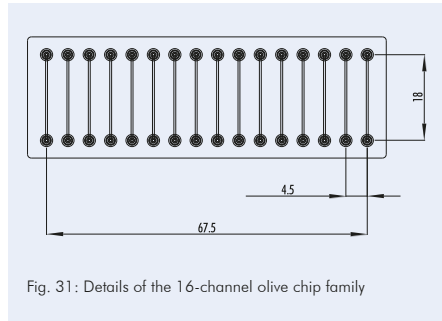

Fig. 31: Details of the 16-channel olive chip family

Product Code	Fluidic	Number of Channels	Channel			Cover Lid Thickness [ $\mu\text{m}$ ]	Material	Price [€/chip]		
			Width [ $\mu\text{m}$ ]	Depth [ $\mu\text{m}$ ]	Length [mm]			1+	10+	30+
10000275	142	16	200	100	18.0	175	PMMA	36.20	24.30	18.10
10000276	142	16	200	100	18.0	140	Topas	36.20	24.30	18.10
10000277	152	16	1,000	200	18.0	175	PMMA	36.20	24.30	18.10
10000278	152	16	1,000	200	18.0	140	Topas	36.20	24.30	18.10



3.2.2.3 Straight channel chips – Channel orientation: crosswise – Fluidic interface: Mini Luer

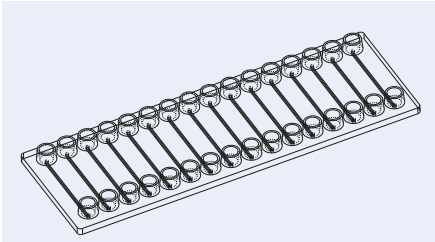

Fig. 32: Schematic drawing of the 16-channel Mini Luer chip famil32

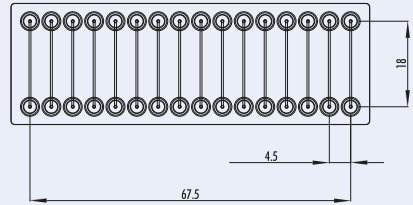

Fig. 33: Details of the 16-channel Mini Luer chip family

Product Code	Fluidic	Number of Channels	Width [μm]	Channel Depth [μm]	Length [mm]	Cover Lid Thickness [μm]	Material	Price [€/chip]		
								1+	10+	30+
10000065	142	16	200	100	18.0	175	PMMA	36.20	24.30	18.10
10000066	142	16	200	100	18.0	140	Topas	36.20	24.30	18.10
10000067	152	16	1,000	200	18.0	175	PMMA	36.20	24.30	18.10
10000068	152	16	1,000	200	18.0	140	Topas	36.20	24.30	18.10

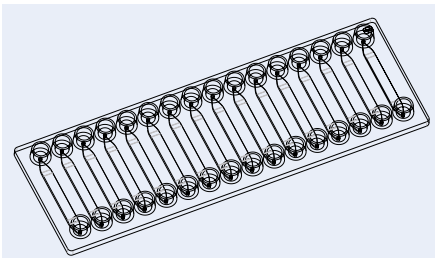

Fig. 34: Schematic drawing of 16-channel chip Fluidic 561 with Mini Luer interfaces

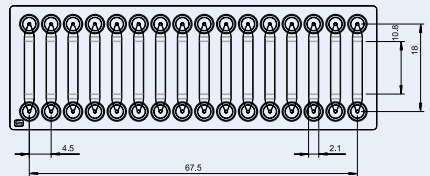

Fig. 35: Channel chip Fluidic 561 with a total channel volume of 10 μl and a channel depth of 350 μm

Product Code for Fluidic 561	Number of Channels	Channel Volume [μl]	Channel Width [μm]	Channel Depth [μm]	Length [mm]	Lid Thickness [μm]	Material	Surface Treatment	Price [€/chip]		
									1+	10+	100+
10000535	16	10	2,100	350	18.0	140	Topas	-	36.20	24.30	16.10
10000536	16	10	2,100	350	18.0	175	PC	-	36.20	24.30	16.10
10000537	16	10	2,100	350	18.0	188	Zeonor	-	36.20	24.30	16.10
10000538	16	10	2,100	350	18.0	140	Topas	hydrophilized	39.20	26.30	17.80
10000539	16	10	2,100	350	18.0	175	PC	hydrophilized	39.20	26.30	17.80
10000540	16	10	2,100	350	18.0	188	Zeonor	hydrophilized	39.20	26.30	17.80



### 3 Microfluidic chips – Polymers

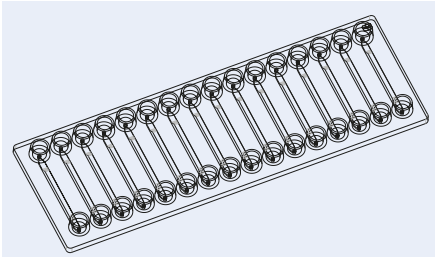

Fig. 36: Schematic drawing of 16-channel chip Fluidic 558 with Mini Luer interfaces

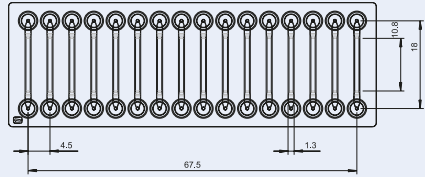

Fig. 37: Channel chip Fluidic 558 with a total channel volume of 10  $\mu\text{l}$  and a channel depth of 700  $\mu\text{m}$

Product Code for Fluidic 558	Number of Channels	Channel				Lid Thickness [ $\mu\text{m}$ ]	Material	Surface Treatment	Price [€/chip]		
		Volume [ $\mu\text{l}$ ]	Width [ $\mu\text{m}$ ]	Depth [ $\mu\text{m}$ ]	Length [mm]				1+	10+	100+
10000541	16	10	1,300	700	18.0	140	Topas	-	36.20	24.30	16.10
10000542	16	10	1,300	700	18.0	175	PC	-	36.20	24.30	16.10
10000543	16	10	1,300	700	18.0	188	Zeonor	-	36.20	24.30	16.10
10000544	16	10	1,300	700	18.0	140	Topas	hydrophilized	39.20	26.30	17.80
10000545	16	10	1,300	700	18.0	175	PC	hydrophilized	39.20	26.30	17.80
10000546	16	10	1,300	700	18.0	188	Zeonor	hydrophilized	39.20	26.30	17.80

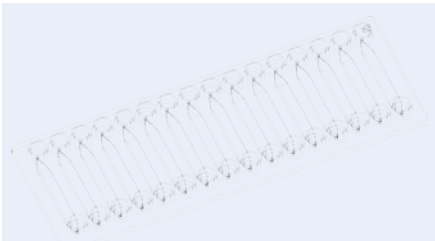

Fig. 38: Schematic drawing of 16-channel chip Fluidic 556 with Mini Luer interfaces

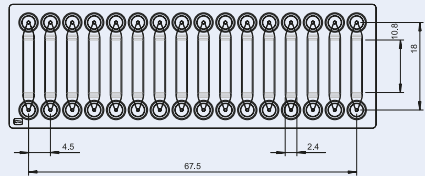

Fig. 39: Channel chip Fluidic 556 with a total channel volume of 20  $\mu\text{l}$  and a channel depth of 700  $\mu\text{m}$

Product Code for Fluidic 556	Number of Channels	Channel				Lid Thickness [ $\mu\text{m}$ ]	Material	Surface Treatment	Price [€/chip]		
		Volume [ $\mu\text{l}$ ]	Width [ $\mu\text{m}$ ]	Depth [ $\mu\text{m}$ ]	Length [mm]				1+	10+	100+
10000565	16	20	2,400	700	18.0	140	Topas	-	36.20	24.30	16.10
10000566	16	20	2,400	700	18.0	175	PC	-	36.20	24.30	16.10
10000567	16	20	2,400	700	18.0	188	Zeonor	-	36.20	24.30	16.10
10000568	16	20	2,400	700	18.0	140	Topas	hydrophilized	39.20	26.30	17.80
10000569	16	20	2,400	700	18.0	175	PC	hydrophilized	39.20	26.30	17.80
10000570	16	20	2,400	700	18.0	188	Zeonor	hydrophilized	39.20	26.30	17.80



### 3.2.2.4 Straight channel chips – Channel orientation: crosswise – Fluidic interface: Luer

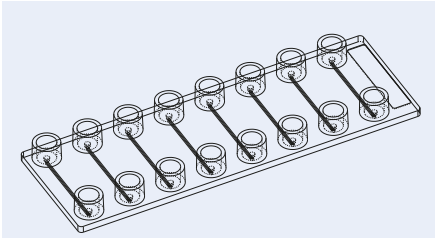

Fig. 40: Schematic drawing of the eight-channel Luer chip family with crosswise channel orientation

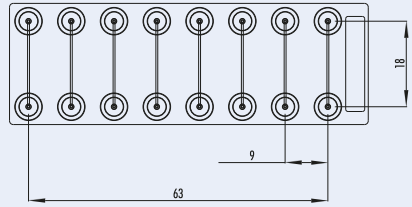

Fig. 41: Details of the eight-channel Luer chip family

Product Code	Fluidic	Number of Channels	Width [μm]	Channel Depth [μm]	Length [mm]	Cover Lid Thickness [μm]	Material	Price [€/chip]		
								1+	10+	30+
10000058	157	8	100	100	18.0	175	PMMA	42.50	31.20	23.50
10000059	157	8	100	100	18.0	140	Topas	42.50	31.20	23.50
10000060	431	8	2,910	100	18.0	175	PMMA	42.50	31.20	23.50
10000061	431	8	2,910	100	18.0	188	Zeonor	42.50	31.20	23.50

### 3.2.3 Straight channel chips – Various channel depths in one chip

These straight channel chips feature a variety of channels within one chip with the same channel dimensions besides the channel depth. The varying channel depth and the resulting different channel volumes allow for direct comparison of the channel depth influence on the assay and the measurement. These chips are the perfect tools to help choosing the right channel dimensions in the design process of integrated microfluidic devices.

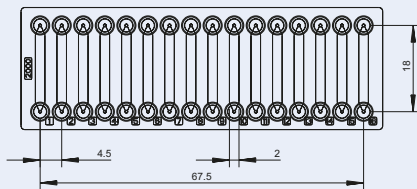

Fig. 42: Schematic drawing of channel chip Fluidic 625 with Mini Luer interfaces



Fig. 43: Schematic cross-section of reaction chamber chip Fluidic 625. The chip contains 8 channels with 80 μm depth and 8 channels of 60 μm depth

Product Code for Fluidic 625	Chamber Volume [μl]		Lid Thickness [μm]	Material	Surface Treatment	Price [€/chip]		
	Depth [μm]	Volume [μl]				1+	10+	100+
10000767	8 x 2.5	8 x 60	140	Topas	-	36.20	24.30	16.10
	8 x 1.9	8 x 80						
10000768	8 x 2.5	8 x 60	140	Topas	hydrophilized	39.20	26.30	17.80
	8 x 1.9	8 x 80						



### 3 Microfluidic chips – Polymers

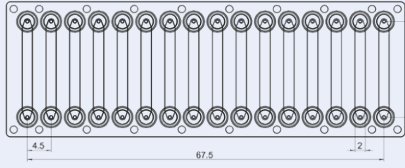

Fig. 44: Schematic drawing of channel chip Fluidic 620 with Mini Luer interface

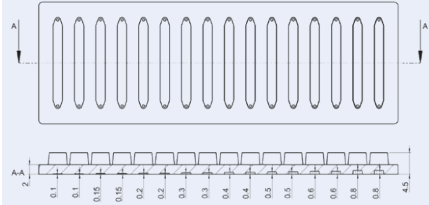

Fig. 45: Schematic drawing of channel chip Fluidic 620 with varying channel depth

Product Code for Fluidic 620	Number of Channels	Volume [ $\mu$ l]	Channel Depth [ $\mu$ m]	Length [mm]	Lid Thickness [ $\mu$ m]	Material	Surface Treatment	Price [€/chip]		
								1+	10+	100+
10000583	16	3.6 – 28.8	100 - 800	18.0	175	PMMA	-	36.20	24.30	16.10
10000584	16	3.6 – 28.8	100 - 800	18.0	140	Topas	-	36.20	24.30	16.10
10000585	16	3.6 – 28.8	100 - 800	18.0	125	PS	-	36.20	24.30	16.10
10000586	16	3.6 – 28.8	100 - 800	18.0	175	PMMA	hydrophilized	39.20	26.30	17.80
10000587	16	3.6 – 28.8	100 - 800	18.0	140	Topas	hydrophilized	39.20	26.30	17.80
10000588	16	3.6 – 28.8	100 - 800	18.0	125	PS	hydrophilized	39.20	26.30	17.80





### 3.3 Straight channel chips – Microtiter-plate format

The SBS titer-plate format (85.48 mm x 127.76 mm) is a worldwide standard used by almost all pieces of equipment in the laboratory. A family of microfluidic microtiter plates having the spacing of the fluidic access holes of the laboratory standard and being compatible with the respective readers allows for a wide variety of different assays, including cell-based assays, hybridization assays, or small volume chemical synthesis. The channels can easily be filled via pipetting in the through-hole interfaces.

The plates are available in various polymer materials like PC, PS, PMMA, or COP (Zeonor), either in its native state or hydrophilically primed for self-filling of the microchannels with aqueous solutions. It is possible to include surface functionalization in the channels like the spotting of DNA probes, poly-L-lysine or collagen coating, etc.

To easily integrate a microfluidic development into existing lab environments, we have developed a microfluidic platform with the outer dimensions of a standard microtiter plate.

#### 3.3.1 Straight channel chips – Microtiter-plate format – 64 channel plates

The plate is equipped with four labeled sets of 16 microchannels each, with the dimensions 2 mm width, 150  $\mu\text{m}$  height, and 18 mm length. Fluidic access is easily provided by conical openings of 2.5 mm diameter at either channel end.

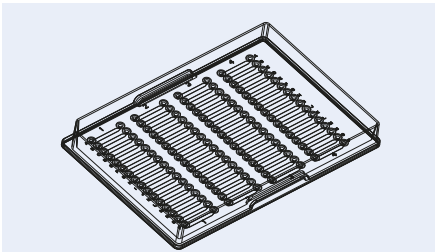

Fig. 46: Schematic drawing of the microfluidic titer plate

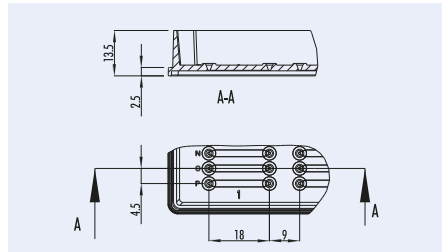

Fig. 47: Details of the microfluidic titer plate

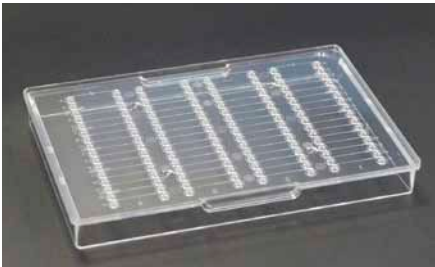

Fig. 48: Microfluidic titer plate

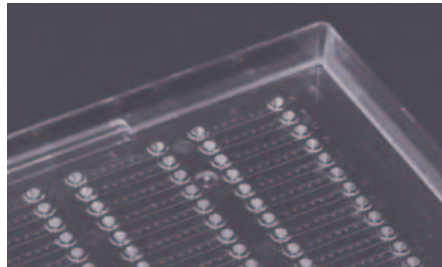

Fig. 49: Microfluidic titer plate with spotted probes



Product Code for Fluidic 102	Channel Dimensions			Material	Surface Treatment	Price [€/chip]		
	Width [mm]	Depth [mm]	Length [mm]			1+	10+	30+
10000352	2	0.15	18	PMMA	-	79.00	59.00	29.00
10000353	2	0.15	18	PC	-	79.00	59.00	29.00
10000335	2	0.15	18	PS	-	79.00	59.00	29.00
10000320	2	0.15	18	Zeonor	-	79.00	59.00	29.00
10000646	2	0.15	18	PMMA	hydrophilized	98.00	78.00	38.00
10000647	2	0.15	18	PC	hydrophilized	98.00	78.00	38.00
10000364	2	0.15	18	PS	hydrophilized	98.00	78.00	38.00
10000649	2	0.15	18	Zeonor	hydrophilized	98.00	78.00	38.00

#### 3.3.2 Straight channel chips – Microtiter-plate format – 96 channel plates

These microfluidic microtiter plate devices are designed to have the fluidic access holes at the positions of a 384 well plate having a 4.5 mm spacing. Read out positions comply with the positions of 96 well plate readers.

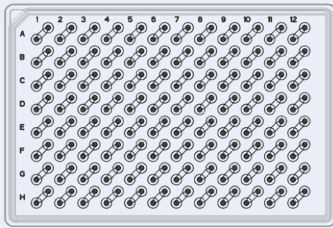

Fig. 50: Schematic drawing of the microfluidic microtiter plate top view – Fluidic 600 – 150  $\mu\text{m}$  channel depth

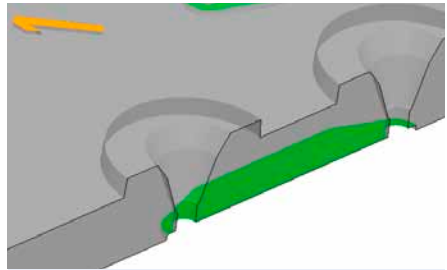

Fig. 51: Detail of the microfluidic microtiter plate with 1.9  $\mu\text{l}$  channel volume – Fluidic 600 – 150  $\mu\text{m}$  channel depth

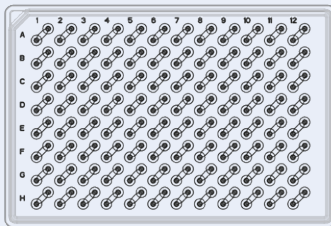

Fig. 52: Schematic drawing of the microfluidic microtiter plate top view – Fluidic 627 – 600  $\mu\text{m}$  channel depth

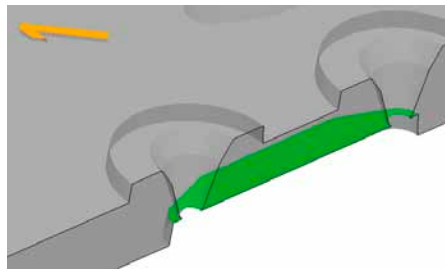

Fig. 53: Detail of the microfluidic microtiter plate with 7.6  $\mu\text{l}$  channel volume – Fluidic 627 – 600  $\mu\text{m}$  channel depth



Product Code for Fluidic 600	Channel Dimensions				Material	Surface Treatment	Price [€/chip]		
	Volume [ $\mu$ l]	Width [mm]	Depth [mm]	Length [mm]			1+	10+	30+
10000650	1.9	2	0.15	6.364	PMMA	-	79.00	59.00	29.00
10000651	1.9	2	0.15	6.364	Topas	-	79.00	59.00	29.00
10000652	1.9	2	0.15	6.364	PC	-	79.00	59.00	29.00
10000653	1.9	2	0.15	6.364	PS	-	79.00	59.00	29.00
10000654	1.9	2	0.15	6.364	PMMA	hydrophilized	98.00	78.00	38.00
10000655	1.9	2	0.15	6.364	Topas	hydrophilized	98.00	78.00	38.00
10000656	1.9	2	0.15	6.364	PC	hydrophilized	98.00	78.00	38.00
10000657	1.9	2	0.15	6.364	PS	hydrophilized	98.00	78.00	38.00

Product Code for Fluidic 627	Channel Dimensions				Material	Surface Treatment	Price [€/chip]		
	Volume [ $\mu$ l]	Width [mm]	Depth [mm]	Length [mm]			1+	10+	30+
10000658	7.6	2	0.6	6.364	PMMA	-	79.00	59.00	29.00
10000616	7.6	2	0.6	6.364	Topas	-	79.00	59.00	29.00
10000660	7.6	2	0.6	6.364	PC	-	79.00	59.00	29.00
10000661	7.6	2	0.6	6.364	PS	-	79.00	59.00	29.00
10000662	7.6	2	0.6	6.364	PMMA	hydrophilized	98.00	78.00	38.00
10000720	7.6	2	0.6	6.364	Topas	hydrophilized	98.00	78.00	38.00
10000664	7.6	2	0.6	6.364	PC	hydrophilized	98.00	78.00	38.00
10000665	7.6	2	0.6	6.364	PS	hydrophilized	98.00	78.00	38.00

#### 3.4 Cross-shaped channel chips

A variety of chips with crossing channels either with T or double-T junctions is offered in this chapter. Different outer formats ranging from the microscopy slide format, 25.5 mm x 75.5 mm, to extended size platforms with 95.5 mm x 16 mm x 1.5 mm or 141 mm x 16 mm x 1.5 mm respectively are possible. The maximum available standard channel length is 120 mm. As fluidic interfaces, simple through-holes for the filling with pipettes or female Luer adapters are available. One of the most common applications of this chip category is the use in capillary electrophoresis.

#### 3.4.1 Cross-shaped channel chips – Extended size platform I

##### 3.4.1.1 Cross-shaped channel chips – Extended size platform I Fluidic interface: Through-holes

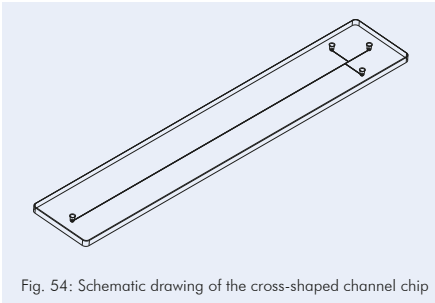

Fig. 54: Schematic drawing of the cross-shaped channel chip

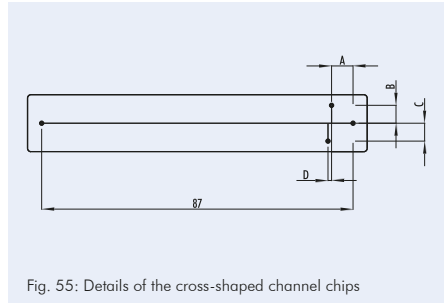

Fig. 55: Details of the cross-shaped channel chips

Product Code	Fluidic	Channel			Hole Diameter [mm]	Geometry				Lid Thickness [μm]	Material	Price [€/chip]			
		Width [μm]	Depth [μm]	Length [mm]		A [mm]	B [mm]	C [mm]	D [mm]			1+	10+	100+	1000+
10000168	82	50	50	87.0	1.0	6.0	5.0	5.0	0	175	PMMA	42.35	31.19	25.18	9.98
10000169	82	50	50	87.0	1.0	6.0	5.0	5.0	0	140	Topas	42.35	31.19	25.18	9.98
10000170	201	50	50	87.0	1.0	6.0	5.0	5.0	0.1	175	PMMA	42.35	31.19	25.18	9.98
10000171	201	50	50	87.0	1.0	6.0	5.0	5.0	0.1	140	Topas	42.35	31.19	25.18	9.98
10000172	106	75	75	87.0	1.0	6.0	5.0	5.0	0	175	PMMA	42.35	31.19	25.18	9.98
10000173	106	75	75	87.0	1.0	6.0	5.0	5.0	0	140	Topas	42.35	31.19	25.18	9.98
10000017	166	100	100	87.0	1.0	6.0	5.0	5.0	0	175	PMMA	42.35	31.19	25.18	9.98
10000167	166	100	100	87.0	1.0	6.0	5.0	5.0	0	140	Topas	42.35	31.19	25.18	9.98



### 3.4.1.2 Cross-shaped channel chips – Extended size platform I

Fluidic interface: Luer

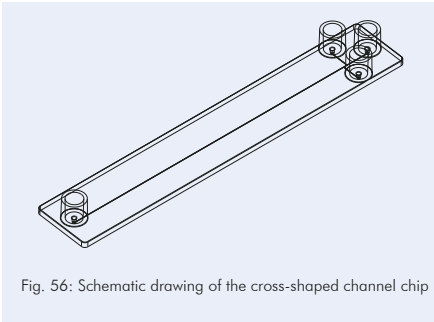

Fig. 56: Schematic drawing of the cross-shaped channel chip

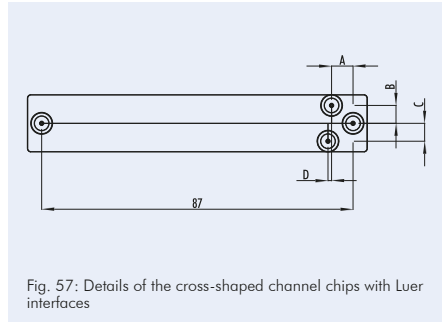

Fig. 57: Details of the cross-shaped channel chips with Luer interfaces



Fig. 58: Cross-shaped channel chip with Luer interfaces



Fig. 59: Cross-shaped channel chip with female Luer interface and a syringe as male counterpart

Product Code	Fluidic	Channel			Hole-Diameter [mm]	Geometry				Lid Thickness [μm]	Material	Price [€/chip]			
		Width [μm]	Depth [μm]	Length [mm]		A [mm]	B [mm]	C [mm]	D [mm]			1+	10+	100+	1000+
10000322	82	50	50	87.0	1.0	6.0	5.0	5.0	0	175	PMMA	42.35	31.19	25.18	9.98
10000272	82	50	50	87.0	1.0	6.0	5.0	5.0	0	140	Topas	42.35	31.19	25.18	9.98
10000290	82	50	50	87.0	1.0	6.0	5.0	5.0	0	100	Zeonor	42.35	31.19	25.18	9.98
10000273	201	50	50	87.0	1.0	6.0	5.0	5.0	0.1	175	PMMA	42.35	31.19	25.18	9.98
10000259	201	50	50	87.0	1.0	6.0	5.0	5.0	0.1	140	Topas	42.35	31.19	25.18	9.98
10000263	201	50	50	87.0	1.0	6.0	5.0	5.0	0.1	100	Zeonor	42.35	31.19	25.18	9.98
10000316	106	75	75	87.0	1.0	6.0	5.0	5.0	0	175	PMMA	42.35	31.19	25.18	9.98
10000317	106	75	75	87.0	1.0	6.0	5.0	5.0	0	140	Topas	42.35	31.19	25.18	9.98
10000318	106	75	75	87.0	1.0	6.0	5.0	5.0	0	100	Zeonor	42.35	31.19	25.18	9.98
10000329	202	75	75	87.0	1.0	6.0	5.0	5.0	0.1	175	PMMA	42.35	31.19	25.18	9.98
10000330	202	75	75	87.0	1.0	6.0	5.0	5.0	0.1	140	Topas	42.35	31.19	25.18	9.98
10000264	202	75	75	87.0	1.0	6.0	5.0	5.0	0.1	100	Zeonor	42.35	31.19	25.18	9.98
10000267	166	100	100	87.0	1.0	6.0	5.0	5.0	0	175	PMMA	42.35	31.19	25.18	9.98
10000258	166	100	100	87.0	1.0	6.0	5.0	5.0	0	140	Topas	42.35	31.19	25.18	9.98
10000237	166	100	100	87.0	1.0	6.0	5.0	5.0	0	100	Zeonor	42.35	31.19	25.18	9.98



Product Code	Fluidic	Channel			Hole-Diameter [mm]	Geometry				Lid Thickness [μm]	Material	Price [€/chip]			
		Width [μm]	Depth [μm]	Length [mm]		A [mm]	B [mm]	C [mm]	D [mm]			1+	10+	100+	1000+
10000232	394	200	200	87.0	1.0	6.0	5.0	5.0	0	175	PMMA	42.35	31.19	25.18	9.98
10000016	394	200	200	87.0	1.0	6.0	5.0	5.0	0	140	Topas	42.35	31.19	25.18	9.98
10000233	394	200	200	87.0	1.0	6.0	5.0	5.0	0	100	Zeonor	42.35	31.19	25.18	9.98
10000234	395	400	200	87.0	1.0	6.0	5.0	5.0	0	175	PMMA	42.35	31.19	25.18	9.98
10000235	395	400	200	87.0	1.0	6.0	5.0	5.0	0	140	Topas	42.35	31.19	25.18	9.98
10000236	395	400	200	87.0	1.0	6.0	5.0	5.0	0	100	Zeonor	42.35	31.19	25.18	9.98

#### 3.4.1.3 Cross-shaped channel chips – Extended size platform I

##### Fluidic interface: Thread for LabSmith interfaces

This cross shaped channel chip design includes integrated threads in all fluidic interface in order to allow to screw in the respective LabSmith one piece fittings (product code:10000418). These fittings allow for high pressure connections.

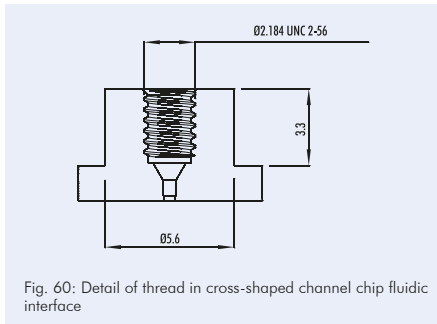

Fig. 60: Detail of thread in cross-shaped channel chip fluidic interface

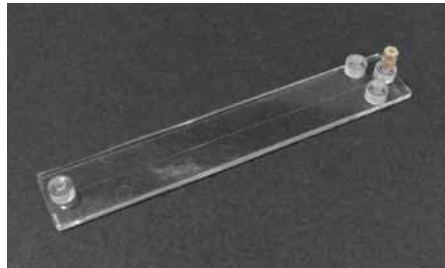

Fig. 61: Cross-shaped channel chips with embedded threads to connect with LabSmith's one piece fittings

Product Code	Fluidic	Description	Material	Price [€]	
				1+	10+
10000178	106	Cross-shaped channel chip with threads in the fluidic interface to connect with LabSmith one piece fitting (10000418)	PMMA	62.40	43.60



### 3.4.2 Cross-shaped channel chips – Extended size platform I with electrodes

#### 3.4.2.1 Cross-shaped channel chips – Extended size platform I with electrodes (contact mode)

##### Fluidic interface: Through-holes

This variation of the cross-shaped channel chips includes electrodes that can be used for the detection of charged molecules, for example. The material of the electrodes is 10 nm titanium and 100–150 nm gold. The electrodes are placed on the cover lid and assembled towards the channel, resulting in a direct contact of the electrode material with the liquid to be analyzed.

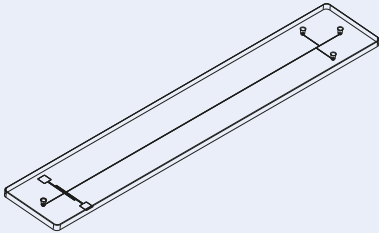

Fig. 62: Schematic drawing of the cross-shaped channel chip with electrodes

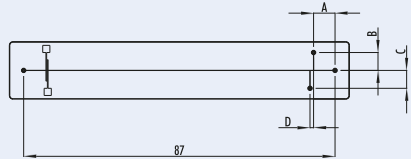

Fig. 63: Detail of cross-shaped channel chip with electrodes

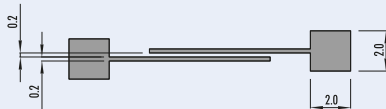

Fig. 64: Details of the electrodes



Fig. 65: Cross-shaped channel chips with through holes and electrodes

Product Code	Fluidic	Channel			Hole Diameter [mm]	Geometry					Lid Thickness [ $\mu\text{m}$ ]	Material	Price [€/chip]	
		Width [ $\mu\text{m}$ ]	Depth [ $\mu\text{m}$ ]	Length [mm]		A	B	C	D	E			1+	10+
10000294	82	50	50	87.8	1.0	6.0	5.0	5.0	0	0.2	175	PMMA	155.00	145.00
10000308	201	50	50	87.8	1.0	6.0	5.0	5.0	0.1	0.2	175	PMMA	155.00	145.00

#### 3.4.2.2 Cross-shaped channel chips – Extended size platform I with electrodes (non-contact mode) – Fluidic interface: Luer

This variation of the cross-shaped channel chips includes electrodes that can be used for the detection of charged molecules, for example. The material of the electrodes is 10 nm titanium and 100–150 nm gold. The electrodes are placed on the cover lid and assembled towards the atmosphere, resulting in electrode and the liquid to be analyzed having no contact. The use of these chips with this electrode arrangement requires a special instrumentation set-up. This detection technology is called C<sup>4</sup>D (capacitively coupled contactless conductivity detection). Chapter 10.2 highlights the respective instrument that allows for an easy use of these chips for several kinds of applications.

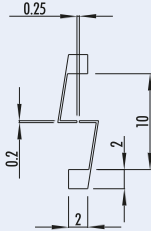

Fig. 66: Details of the electrodes



Fig. 67: Cross-shaped channel chip with electrodes for contactless conductivity detection

Product Code	Fluidic	Channel			Hole Diameter [mm]	Geometry				Lid Thickness [μm]	Material	Price [€/chip]		
		Width [μm]	Depth [μm]	Length [mm]		A	B	C	D			1+	10+	100+
10000028	82	50	50	87.0	1.0	6.0	5.0	5.0	0	60	PMMA	125.00	85.00	32.50
10000027	201	50	50	87.0	1.0	6.0	5.0	5.0	0.1	60	PMMA	125.00	85.00	32.50
10000337	166	100	100	87.0	1.0	6.0	5.0	5.0	0	60	PMMA	125.00	85.00	32.50
10000338	166	100	100	87.0	1.0	6.0	5.0	5.0	0	50	Zeonor	125.00	85.00	32.50
10000464	394	200	200	87.0	1.0	6.0	5.0	5.0	0	60	PMMA	125.00	85.00	32.50
10000398	394	200	200	87.0	1.0	6.0	5.0	5.0	0	50	Zeonor	125.00	85.00	32.50
10000397	395	400	200	87.0	1.0	6.0	5.0	5.0	0	60	PMMA	125.00	85.00	32.50
10000396	395	400	200	87.0	1.0	6.0	5.0	5.0	0	50	Zeonor	125.00	85.00	32.50





### 3.4.3 Cross-shaped channel chips – Extended size platform II

#### 3.4.3.1 Cross-shaped channel chips – Extended size platform II

##### Fluidic interface: Through-holes

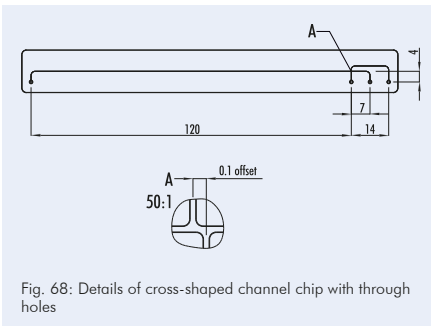

Fig. 68: Details of cross-shaped channel chip with through holes

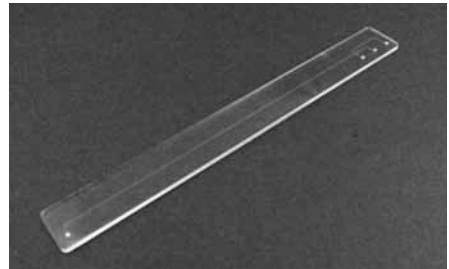

Fig. 69: Cross-shaped channel chip with through-holes

Product Code for Fluidic 189	Channel		Cover Lid Thickness [ $\mu\text{m}$ ]	Material	Price [€/chip]		
	Width [ $\mu\text{m}$ ]	Depth [ $\mu\text{m}$ ]			1+	10+	100+
10000350	50	50	175	PMMA	68.60	44.60	28.40
10000351	50	50	140	Topas	68.60	44.60	28.40

#### 3.4.3.2 Cross-shaped channel chips – Extended size platform II

##### Fluidic interface: Luer

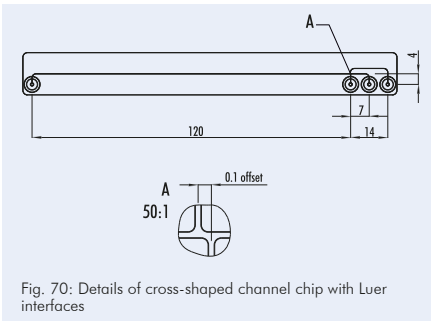

Fig. 70: Details of cross-shaped channel chip with Luer interfaces



Fig. 71: Cross-shaped channel chip with Luer interfaces

Product Code for Fluidic 189	Channel		Cover Lid Thickness [ $\mu\text{m}$ ]	Material	Price [€/chip]		
	Width [ $\mu\text{m}$ ]	Depth [ $\mu\text{m}$ ]			1+	10+	100+
10000348	50	50	175	PMMA	68.60	44.60	28.40
10000349	50	50	140	Topas	68.60	44.60	28.40



#### 3.4.4 Cross-shaped channel chips – Microscopy slide format

These chips offer two separate channel structures with crossing channels on each device. One of those with, one without a channel offset. The microfluidic chips of this family feature Mini Luer interfaces.

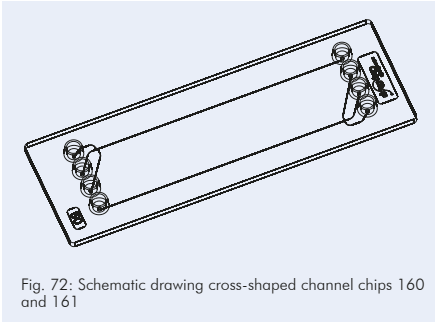

Fig. 72: Schematic drawing cross-shaped channel chips 160 and 161

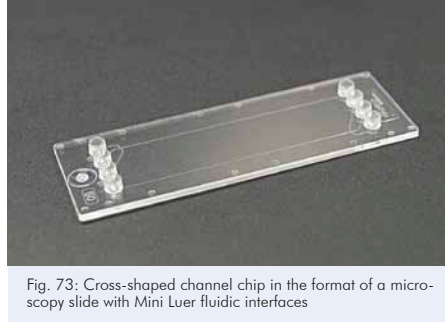

Fig. 73: Cross-shaped channel chip in the format of a microscopy slide with Mini Luer fluidic interfaces

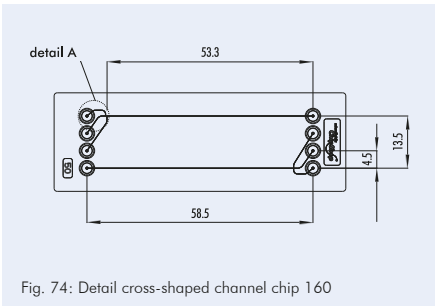

Fig. 74: Detail cross-shaped channel chip 160

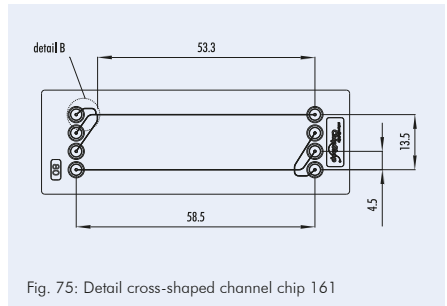

Fig. 75: Detail cross-shaped channel chip 161

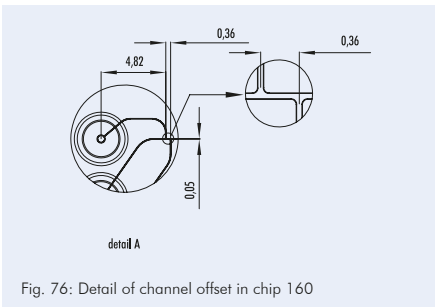

Fig. 76: Detail of channel offset in chip 160

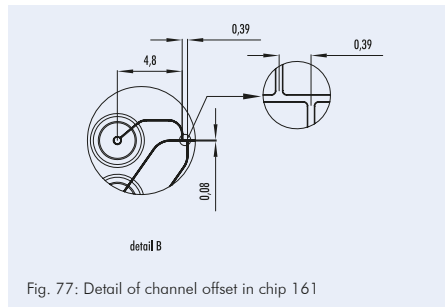

Fig. 77: Detail of channel offset in chip 161

Product Code	Fluidic	Channel		Cover Lid Thickness [μm]	Material	Price [€/chip]		
		Width [μm]	Depth [μm]			1+	10+	30+
10000325	160	50	50	175	PMMA	42.50	31.20	23.50
10000326	160	50	50	140	Topas	42.50	31.20	23.50
10000303	161	80	80	175	PMMA	42.50	31.20	23.50
10000327	161	80	80	140	Topas	42.50	31.20	23.50



### 3.5 H-shaped channel chips

The H-shaped channel chip family is placed on the format of a microscopy slide (75.5 mm x 25.5 mm x 1.5 mm). As fluidic interfaces, Mini Luer adapters are integrated on the chip. These chips can for example be used as extractors or to establish concentration gradients.

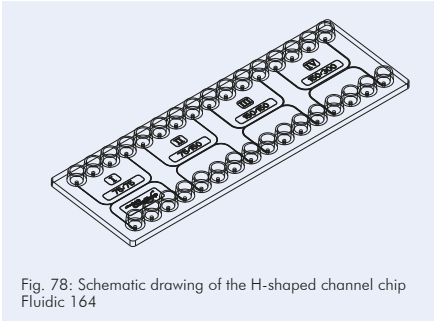

Fig. 78: Schematic drawing of the H-shaped channel chip Fluidic 164

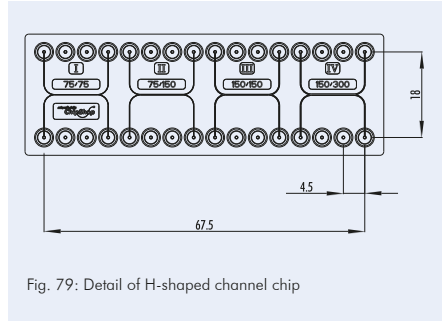

Fig. 79: Detail of H-shaped channel chip

Product Code for Fluidic 164	Channel Dimensions				All Depth [ $\mu\text{m}$ ]	Lid Thick- ness [ $\mu\text{m}$ ]	Mate- rial	Price [€/chip]		
	I Width inlet & outlet [ $\mu\text{m}$ ]	II Width inlet & outlet / middle [ $\mu\text{m}$ ]	III Width inlet & outlet / middle [ $\mu\text{m}$ ]	IV Width inlet & outlet / middle [ $\mu\text{m}$ ]				1+	10+	30+
10000265	75/75	75/150	150/150	150/300	75	175	PMMA	42.50	31.20	23.50
10000266	75/75	75/150	150/150	150/300	75	140	Topas	42.50	31.20	23.50



#### 3.6 Chamber chips

Chamber chips all come in the format of a microscopy slide (75.5 mm x 25.5 mm x 1.5 mm) and are equipped with Mini Luer interfaces. Their key microfluidic elements are reaction chambers of various volumes. Chamber chips are the perfect tool to facilitate reactions, such as amplification of a targeted DNA during qPCR, or to extract target molecules out of a given sample in preparative quantities. These chips can, for example, be used as nucleic acid extraction devices via magnetic beads simply via applying beads and sample and by using an external magnet to hold the beads in place. These procedures can be done completely manually with a pipette – besides the magnet no additional equipment is necessary – or semi-automated with normal peristaltic pumps found in most life science labs.

**Preloaded chips:** If you are interested in chips preloaded with dried reagents for nucleic acid extraction and the respective buffer solutions, please do not hesitate to contact us.

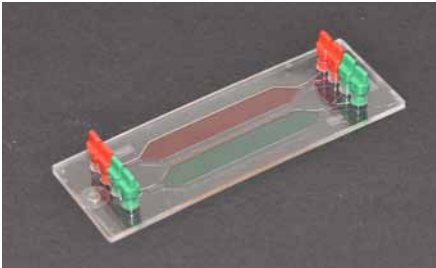

Fig. 80: Rhombic chamber chip filled

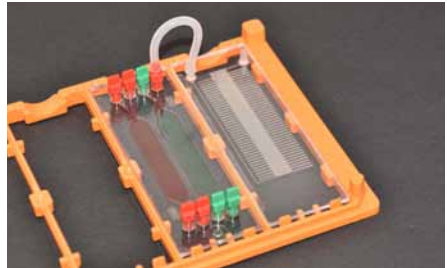

Fig. 81: Rhombic chamber chip in handling frame connected to PCR chip

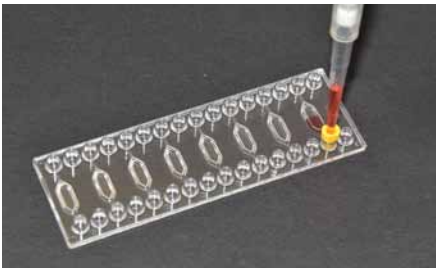

Fig. 82: A reaction chamber chip is being filled with the aid of a Mini Luer to pipette adapter

##### 3.6.1 Chamber chips – Chamber orientation: lengthwise

###### 3.6.1.1 Chamber chips – Chamber orientation: lengthwise - Rhombic chamber chips

As the name suggests this chip family features one or more rhombic chambers on each chip. Those chambers all possess both two inlets and two outlets. Furthermore, this chip family is tailored to be used with our on-chip sample preparation instrument ChipGenie® edition P. For further information please refer to Chapter 10.3, page 195.

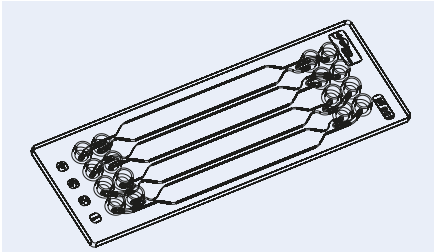

Fig. 83: Schematic drawing of the rhombic chamber chip Fluidic 221

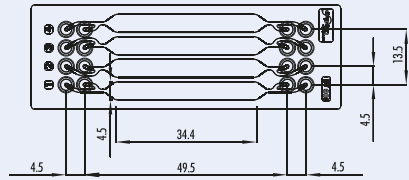

Fig. 84: Rhombic chamber chip – 100  $\mu$ l chamber volume

Product Code for Fluidic 221	Chamber		Lid Thickness [ $\mu$ m]	Material	Surface Treatment	Price [€/chip]		
	Volume [ $\mu$ l]	Depth [ $\mu$ m]				1+	10+	100+
10000046	100	600	175	PMMA*	-	36.20	24.30	16.10
10000050	100	600	140	Topas*	-	36.20	24.30	16.10
10000047	100	600	188	Zeonor	-	36.20	24.30	16.10
10000414	100	600	175	PMMA*	hydrophilized	39.20	26.30	17.80
10000405	100	600	140	Topas*	hydrophilized	39.20	26.30	17.80
10000293	100	600	188	Zeonor	hydrophilized	39.20	26.30	17.80

\* not suitable for PCR applications

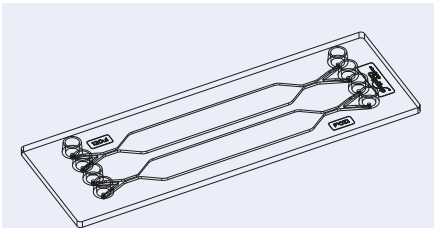

Fig. 85: Schematic drawing of the rhombic chamber chip Fluidic 172

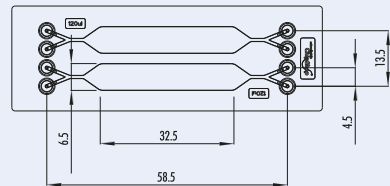

Fig. 86: Rhombic chamber chip – 120  $\mu$ l chamber volume

Product Code for Fluidic 172	Chamber		Lid Thickness [ $\mu$ m]	Material	Surface Treatment	Price [€/chip]		
	Volume [ $\mu$ l]	Depth [ $\mu$ m]				1+	10+	100+
10000110	120	500	175	PMMA*	-	36.20	24.30	16.10
10000111	120	500	140	Topas*	-	36.20	24.30	16.10
10000112	120	500	175	PC	-	36.20	24.30	16.10
10000113	120	500	188	Zeonor	-	36.20	24.30	16.10
10000803	120	500	125	PS*	-	36.20	24.30	16.10
10000243	120	500	175	PMMA*	hydrophilized	39.20	26.30	17.80
10000244	120	500	140	Topas*	hydrophilized	39.20	26.30	17.80
10000363	120	500	175	PC	hydrophilized	39.20	26.30	17.80
10000292	120	500	188	Zeonor	hydrophilized	39.20	26.30	17.80
10000804	120	500	125	PS*	hydrophilized	39.20	26.30	17.80

\* not suitable for PCR applications



### 3 Microfluidic chips – Polymers

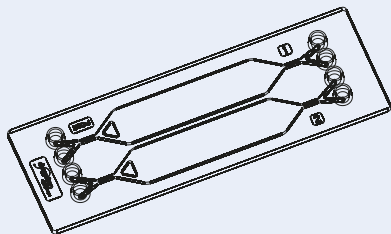

Fig. 87: Schematic drawing of the rhombic chamber chip Fluidic 194

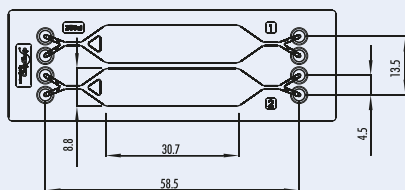

Fig. 88: Rhombic chamber chip – 250  $\mu\text{l}$  chamber volume

Product Code for Fluidic 194	Chamber		Lid Thickness [ $\mu\text{m}$ ]	Material	Surface Treatment	Price [€/chip]		
	Volume [ $\mu\text{l}$ ]	Depth [ $\mu\text{m}$ ]				1+	10+	100+
1000048	250	800	175	PMMA*	-	36.20	24.30	16.10
1000051	250	800	140	Topas*	-	36.20	24.30	16.10
1000049	250	800	188	Zeonor	-	36.20	24.30	16.10
1000309	250	800	175	PMMA*	hydrophilized	39.20	26.30	17.80
1000365	250	800	140	Topas*	hydrophilized	39.20	26.30	17.80
1000340	250	800	188	Zeonor	hydrophilized	39.20	26.30	17.80

\* not suitable for PCR applications

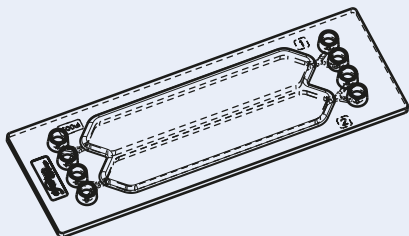

Fig. 89: Schematic drawing of rhombic chamber chip Fluidic 844

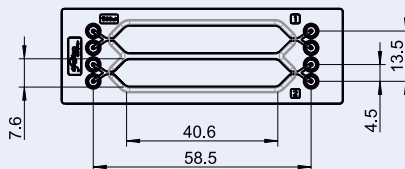

Fig. 90: Rhombic chamber chip Fluidic 844 – 500  $\mu\text{l}$  chamber volume

Product Code for Fluidic 844	Chamber		Lid Thickness [ $\mu\text{m}$ ]	Material	Surface Treatment	Price [€/chip]		
	Volume [ $\mu\text{l}$ ]	Depth [ $\mu\text{m}$ ]				1+	10+	100+
1000996	500	1,500	175	PMMA*	-	36.20	24.30	16.10
1000997	500	1,500	140	Topas*	-	36.20	24.30	16.10
1000998	500	1,500	188	Zeonor	-	36.20	24.30	16.10
1000999	500	1,500	125	PS*	-	36.20	24.30	16.10
10001000	500	1,500	175	PMMA*	hydrophilized	39.20	26.30	17.80
10001001	500	1,500	140	Topas*	hydrophilized	39.20	26.30	17.80
10001002	500	1,500	188	Zeonor	hydrophilized	39.20	26.30	17.80
10001003	500	1,500	125	PS*	hydrophilized	39.20	26.30	17.80

\* not suitable for PCR applications

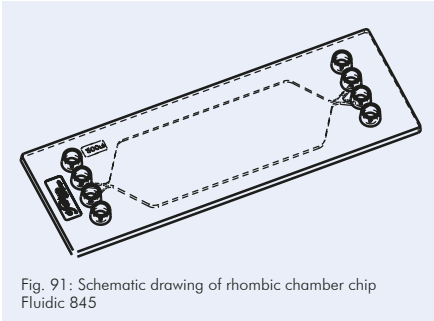

Fig. 91: Schematic drawing of rhombic chamber chip Fluidic 845

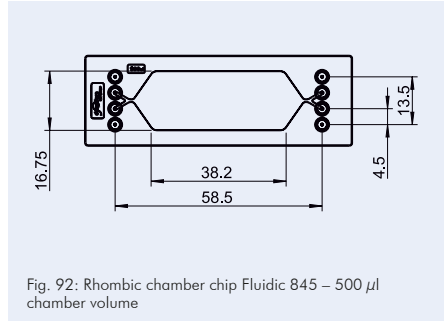

Fig. 92: Rhombic chamber chip Fluidic 845 – 500  $\mu$ l chamber volume

Product Code for Fluidic 845	Chamber		Lid Thickness [ $\mu$ m]	Material	Surface Treatment	Price [€/chip]		
	Volume [ $\mu$ l]	Depth [ $\mu$ m]				1+	10+	100+
10001004	500	700	175	PMMA*	-	36.20	24.30	16.10
10001005	500	700	140	Topas*	-	36.20	24.30	16.10
10001006	500	700	188	Zeonor	-	36.20	24.30	16.10
10001007	500	700	125	PS*	-	36.20	24.30	16.10
10001012	500	700	175	PMMA*	hydrophilized	39.20	26.30	17.80
10001013	500	700	140	Topas*	hydrophilized	39.20	26.30	17.80
10001014	500	700	188	Zeonor	hydrophilized	39.20	26.30	17.80
10001015	500	700	125	PS*	hydrophilized	39.20	26.30	17.80

\* not suitable for PCR applications

### 3.6.2 Chamber chips – Chamber orientation: crosswise

#### 3.6.2.1 Chamber chips – Chamber orientation: crosswise - Rhombic chamber chips

Like their counterpart with lengthwise chamber orientation, these chips offer rhombic chambers with two inlets and two outlets and are therefore versatile tools for various experimental procedures, such as sample preparation. Please note, chips with crosswise rhombic chamber orientation are not suitable for use with the on-chip sample preparation instrument ChipGenie® edition P.

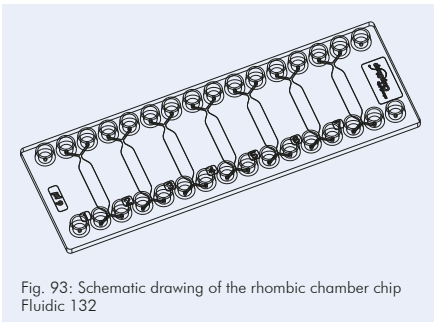

Fig. 93: Schematic drawing of the rhombic chamber chip Fluidic 132

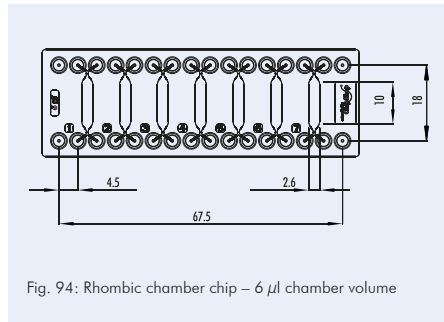

Fig. 94: Rhombic chamber chip – 6  $\mu$ l chamber volume



### 3 Microfluidic chips – Polymers

Product Code for Fluidic 132	Chamber		Lid Thickness [ $\mu\text{m}$ ]	Material	Surface Treatment	Price [€/chip]		
	Volume [ $\mu\text{l}$ ]	Depth [ $\mu\text{m}$ ]				1+	10+	100+
10000114	6	200	175	PMMA*	-	36.20	24.30	16.10
10000034	6	200	140	Topas*	-	36.20	24.30	16.10
10000115	6	200	188	Zeonor	-	36.20	24.30	16.10
10000310	6	200	175	PMMA*	hydrophilized	39.20	26.30	17.80
10000035	6	200	140	Topas*	hydrophilized	39.20	26.30	17.80
10000279	6	200	188	Zeonor	hydrophilized	39.20	26.30	17.80

\* not suitable for PCR applications

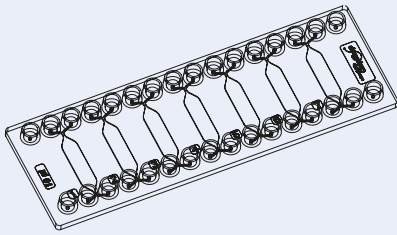

Fig. 95: Schematic drawing of the rhombic chamber chip Fluidic 439

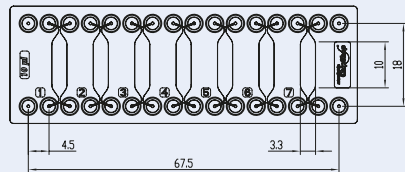

Fig. 96: Rhombic chamber chip – chamber volume 10  $\mu\text{l}$

Product Code for Fluidic 439	Chamber		Lid Thickness [ $\mu\text{m}$ ]	Material	Surface Treatment	Price [€/chip]		
	Volume [ $\mu\text{l}$ ]	Depth [ $\mu\text{m}$ ]				1+	10+	100+
10000530	10	250	175	PMMA*	-	36.20	24.30	16.10
10000399	10	250	140	Topas*	-	36.20	24.30	16.10
10000531	10	250	188	Zeonor	-	36.20	24.30	16.10
10000532	10	250	175	PMMA*	hydrophilized	39.20	26.30	17.80
10000533	10	250	140	Topas*	hydrophilized	39.20	26.30	17.80
10000534	10	250	188	Zeonor	hydrophilized	39.20	26.30	17.80

\* not suitable for PCR applications

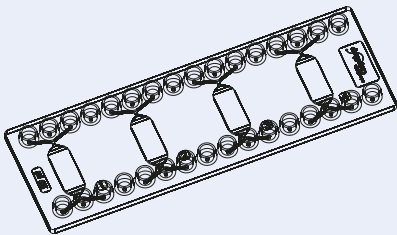

Fig. 97: Schematic drawing of the rhombic chamber chip Fluidic 131

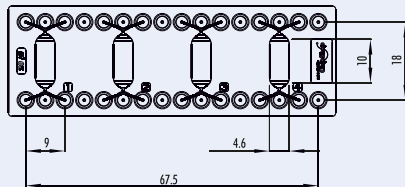

Fig. 98: Rhombic chamber chip – 20  $\mu\text{l}$  chamber volume





Product Code for Fluidic 131	Chamber		Lid Thickness [ $\mu\text{m}$ ]	Material	Surface Treatment	Price [€/chip]		
	Volume [ $\mu\text{l}$ ]	Depth [ $\mu\text{m}$ ]				1+	10+	100+
10000392	20	400	175	PMMA*	-	36.20	24.30	16.10
10000298	20	400	140	Topas*	-	36.20	24.30	16.10
10000245	20	400	188	Zeonor	-	36.20	24.30	16.10
10000434	20	400	175	PMMA*	hydrophilized	39.20	26.30	17.80
10000435	20	400	140	Topas*	hydrophilized	39.20	26.30	17.80
10000436	20	400	188	Zeonor	hydrophilized	39.20	26.30	17.80

\* not suitable for PCR applications

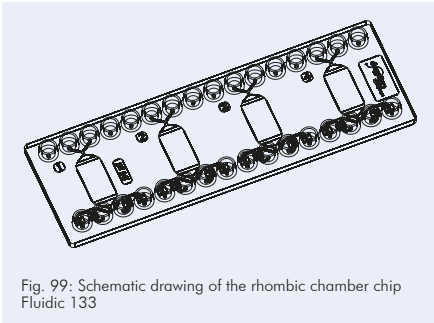

Fig. 99: Schematic drawing of the rhombic chamber chip Fluidic 133

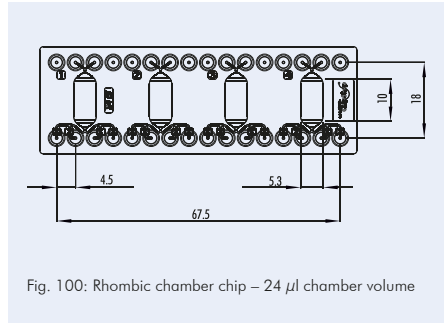

Fig. 100: Rhombic chamber chip – 24  $\mu\text{l}$  chamber volume

Product Code for Fluidic 133	Chamber		Lid Thickness [ $\mu\text{m}$ ]	Material	Surface Treatment	Price [€/chip]		
	Volume [ $\mu\text{l}$ ]	Depth [ $\mu\text{m}$ ]				1+	10+	100+
10000355	24	400	175	PMMA*	-	36.20	24.30	16.10
10000260	24	400	140	Topas*	-	36.20	24.30	16.10
10000354	24	400	188	Zeonor	-	36.20	24.30	16.10
10000529	24	400	175	PMMA*	hydrophilized	39.20	26.30	17.80
10000261	24	400	140	Topas*	hydrophilized	39.20	26.30	17.80
10000204	24	400	188	Zeonor	hydrophilized	39.20	26.30	17.80

\* not suitable for PCR applications



#### 3.6.2.2 Chamber chips – Chamber orientation: crosswise - Reaction chamber chips

Reaction chamber chip belong to the simplest, however most versatile, microfluidic devices. From basic reaction chamber to cell culture tool - many experimental setups can be facilitated with this chip family. *microfluidic ChipShop* offer a wide variety of reaction chamber chips with volumes ranging from as little as 2.5  $\mu\text{l}$  to as large as 50  $\mu\text{l}$ .

Some fluidic designs, namely Fluidic 843; 750; 585; 584; 842, are particularly suited to be used for heat-cycle applications, such as PCR experiments, during which small air bubbles can form within the chambers of a microfluidic chip. For undisturbed fluorescent readouts, those microfluidic chips all feature *microfluidic ChipShop*'s unique bubble-trapping-rim-design, specifically developed to keep the detection area of each chamber air bubble-free.

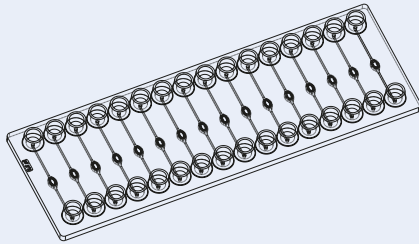

Fig. 101: Schematic drawing of reaction chamber chip Fluidic 843 – chamber volume 2.5  $\mu\text{l}$

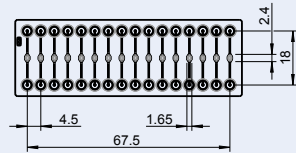

Fig. 102: Reaction chamber chip Fluidic 843 – chamber volume 2.5  $\mu\text{l}$

Product Code for Fluidic 843	Chamber		Lid Thickness [ $\mu\text{m}$ ]	Material	Surface Treatment	Price [€/chip]		
	Volume [ $\mu\text{l}$ ]	Depth [ $\mu\text{m}$ ]				1+	10+	100+
10001264	2.5	500	140	Topas*	-	36.20	24.30	16.10
10001008	2.5	500	175	Topas	-	39.80	26.70	16.90
10001009	2.5	500	175	PC	-	36.20	24.30	16.10
10001010	2.5	500	188	Zeonor	-	36.20	24.30	16.10
10001269	2.5	500	140	Topas*	hydrophilized	39.20	26.30	17.80
10001011	2.5	500	175	Topas	hydrophilized	42.80	28.70	18.60
10001016	2.5	500	175	PC	hydrophilized	39.20	26.30	17.80
10001017	2.5	500	188	Zeonor	hydrophilized	39.20	26.30	17.80

\* not suitable for PCR applications

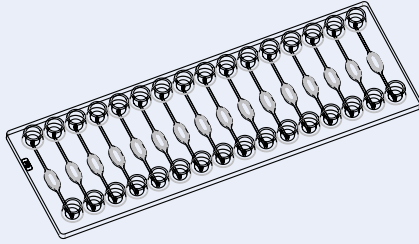

Fig. 103: Schematic drawing of reaction chamber chip Fluidic 750 – chamber volume 5  $\mu\text{l}$

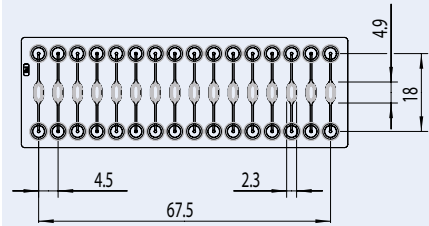

Fig. 104: Reaction chamber chip Fluidic 750 – chamber volume 5  $\mu\text{l}$

Product Code for Fluidic 750	Chamber		Lid Thickness [ $\mu\text{m}$ ]	Material	Surface Treatment	Price [€/chip]		
	Volume [ $\mu\text{l}$ ]	Depth [ $\mu\text{m}$ ]				1+	10+	100+
10001037	5	500	140	Topas*	-	36.20	24.30	16.10
10001292	5	500	175	Topas	-	39.80	26.70	16.90
10001038	5	500	175	PC	-	36.20	24.30	16.10
10001039	5	500	188	Zeonor	-	36.20	24.30	16.10
10001040	5	500	140	Topas*	hydrophilized	39.20	26.30	17.80
10001293	5	500	175	Topas	hydrophilized	42.80	28.70	18.60
10001041	5	500	175	PC	hydrophilized	39.20	26.30	17.80
10001042	5	500	188	Zeonor	hydrophilized	39.20	26.30	17.80

\* not suitable for PCR applications

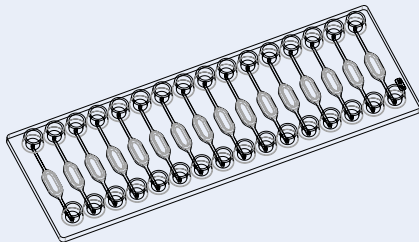

Fig. 105: Schematic drawing of reaction chamber chip Fluidic 585 – chamber volume 10  $\mu\text{l}$

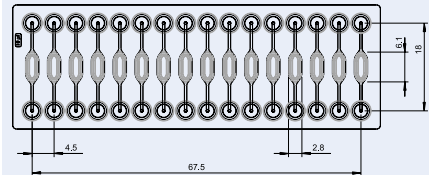

Fig. 106: Reaction chamber chip Fluidic 585 – chamber volume 10  $\mu\text{l}$

Product Code for Fluidic 585	Chamber		Lid Thickness [ $\mu\text{m}$ ]	Material	Surface Treatment	Price [€/chip]		
	Volume [ $\mu\text{l}$ ]	Depth [ $\mu\text{m}$ ]				1+	10+	100+
10001268	10	500	140	Topas*	-	36.20	24.30	16.10
10000524	10	500	175	Topas	-	39.80	26.70	16.90
10000525	10	500	175	PC	-	36.20	24.30	16.10
10000447	10	500	188	Zeonor	-	36.20	24.30	16.10
10001267	10	500	140	Topas*	hydrophilized	39.20	26.30	17.80
10000526	10	500	175	Topas	hydrophilized	42.80	28.70	18.60
10000527	10	500	175	PC	hydrophilized	39.20	26.30	17.80
10000528	10	500	188	Zeonor	hydrophilized	39.20	26.30	17.80

\* not suitable for PCR applications



### 3 Microfluidic chips – Polymers

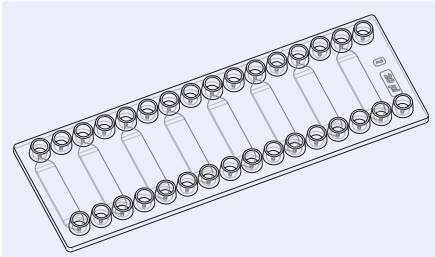

Fig. 107: Schematic drawing of reaction chamber chip Fluidic 559 – chamber volume 20 µl

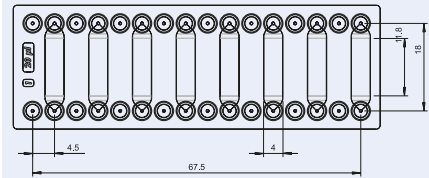

Fig. 108: Reaction chamber chip Fluidic 559 – chamber volume 20 µl

Product Code for Fluidic 559	Chamber		Lid Thickness [µm]	Material	Surface Treatment	Price [€/chip]		
	Volume [µl]	Depth [µm]				1+	10+	100+
10000560	20	350	140	Topas*	-	36.20	24.30	16.10
10001137	20	350	175	PC	-	36.20	24.30	16.10
10000561	20	350	188	Zeonor	-	36.20	24.30	16.10
10000562	20	350	140	Topas*	hydrophilized	39.20	26.30	17.80
10000563	20	350	175	PC	hydrophilized	39.20	26.30	17.80
10000564	20	350	188	Zeonor	hydrophilized	39.20	26.30	17.80

\* not suitable for PCR applications

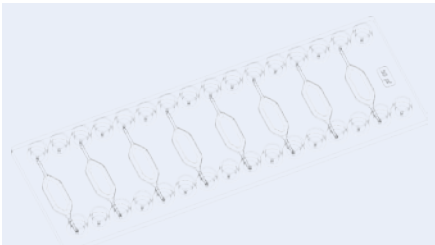

Fig. 109: Schematic drawing of the reaction chamber chip Fluidic 584 with 500 µm chamber depth

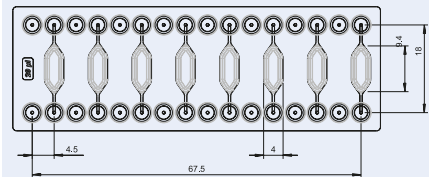

Fig. 110: Reaction chamber chip Fluidic 584 – chamber volume 20 µl

Product Code for Fluidic 584	Chamber		Lid Thickness [µm]	Material	Surface Treatment	Price [€/chip]		
	Volume [µl]	Depth [µm]				1+	10+	100+
10000554	20	500	140	Topas*	-	36.20	24.30	16.10
10001296	20	500	175	Topas	-	39.80	26.70	16.90
10000555	20	500	175	PC	-	36.20	24.30	16.10
10000556	20	500	188	Zeonor	-	36.20	24.30	16.10
10000557	20	500	140	Topas*	hydrophilized	39.20	26.30	17.80
10001297	20	500	175	Topas	hydrophilized	42.80	28.70	18.60
10000558	20	500	175	PC	hydrophilized	39.20	26.30	17.80
10000559	20	500	188	Zeonor	hydrophilized	39.20	26.30	17.80

\* not suitable for PCR applications

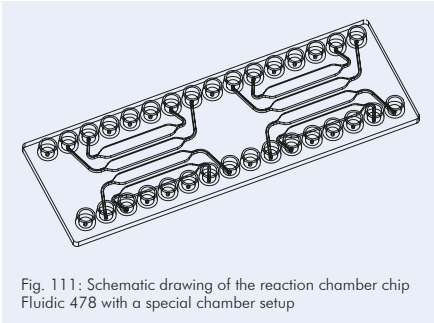

Fig. 111: Schematic drawing of the reaction chamber chip Fluidic 478 with a special chamber setup

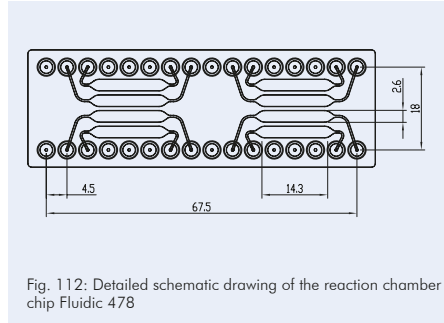

Fig. 112: Detailed schematic drawing of the reaction chamber chip Fluidic 478

Product Code for Fluidic 478	Chamber		Lid Thickness [μm]	Material	Surface Treatment	Price [€/chip]		
	Volume [μl]	Depth [μm]				1+	10+	100+
10000547	20	500	175	PMMA*	-	36.20	24.30	16.10
10000300	20	500	140	Topas*	-	36.20	24.30	16.10
10000311	20	500	188	Zeonor	-	36.20	24.30	16.10
10000548	20	500	175	PMMA*	hydrophilized	39.20	26.30	17.80
10000549	20	500	140	Topas*	hydrophilized	39.20	26.30	17.80
10000550	20	500	188	Zeonor	hydrophilized	39.20	26.30	17.80

\* not suitable for PCR applications

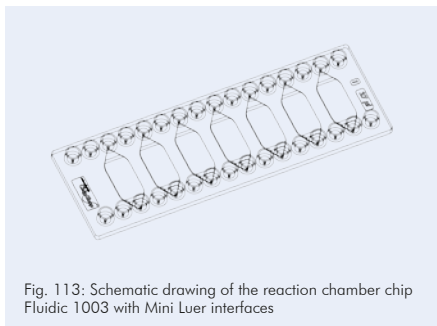

Fig. 113: Schematic drawing of the reaction chamber chip Fluidic 1003 with Mini Luer interfaces

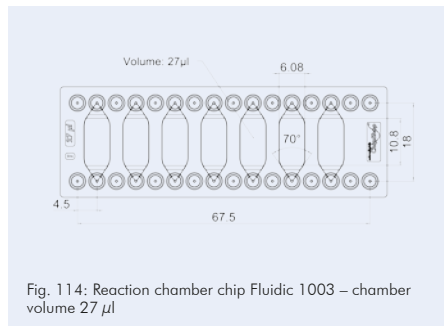

Fig. 114: Reaction chamber chip Fluidic 1003 – chamber volume 27 μl

Product Code for Fluidic 1003	Chamber		Lid Thickness [μm]	Material	Surface Treatment	Price [€/chip]		
	Volume [μl]	Depth [μm]				1+	10+	100+
10001320	27	350	140	Topas*	-	36.20	24.30	16.10
10001322	27	350	175	PC	-	36.20	24.30	16.10
10001324	27	350	188	Zeonor	-	36.20	24.30	16.10
10001326	27	350	125	PS*	-	36.20	24.30	16.10
10001321	27	350	140	Topas*	hydrophilized	39.20	26.30	17.80
10001323	27	350	175	PC	hydrophilized	39.20	26.30	17.80
10001325	27	350	188	Zeonor	hydrophilized	39.20	26.30	17.80
10001327	27	350	125	PS*	hydrophilized	39.20	26.30	17.80

\* not suitable for PCR applications



### 3 Microfluidic chips – Polymers

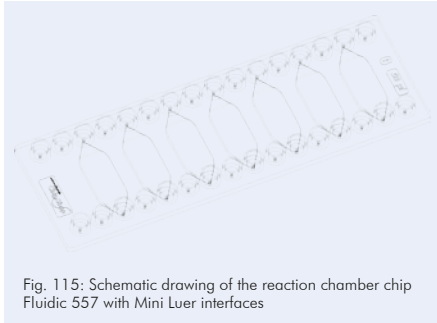

Fig. 115: Schematic drawing of the reaction chamber chip Fluidic 557 with Mini Luer interfaces

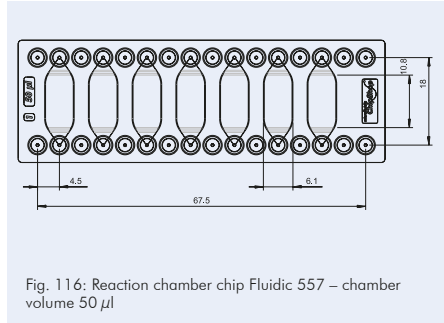

Fig. 116: Reaction chamber chip Fluidic 557 – chamber volume 50 µl

Product Code for Fluidic 557	Chamber		Lid Thickness [µm]	Material	Surface Treatment	Price [€/chip]		
	Volume [µl]	Depth [µm]				1+	10+	100+
10000577	50	700	140	Topas*	-	36.20	24.30	16.10
10000578	50	700	175	PC	-	36.20	24.30	16.10
10000579	50	700	188	Zeonor	-	36.20	24.30	16.10
10000825	50	700	125	PS*	-	36.20	24.30	16.10
10000580	50	700	140	Topas*	hydrophilized	39.20	26.30	17.80
10000581	50	700	175	PC	hydrophilized	39.20	26.30	17.80
10000582	50	700	188	Zeonor	hydrophilized	39.20	26.30	17.80
10000826	50	700	125	PS*	hydrophilized	39.20	26.30	17.80

\* not suitable for PCR applications

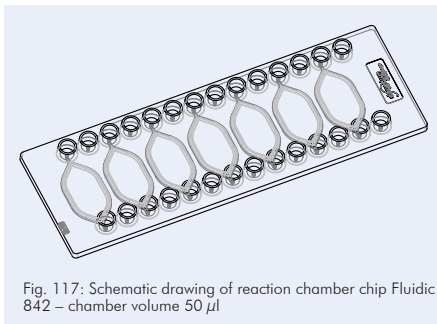

Fig. 117: Schematic drawing of reaction chamber chip Fluidic 842 – chamber volume 50 µl

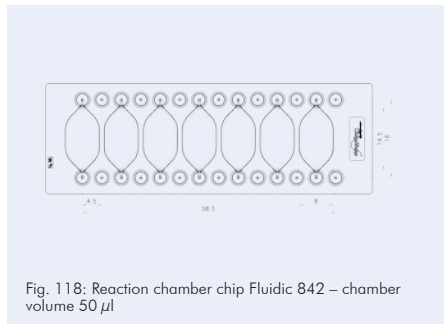

Fig. 118: Reaction chamber chip Fluidic 842 – chamber volume 50 µl

Product Code for Fluidic 842	Chamber		Lid Thickness [µm]	Material	Surface Treatment	Price [€/chip]		
	Volume [µl]	Depth [µm]				1+	10+	100+
10001031	50	500	140	Topas*	-	36.20	24.30	16.10
10001298	50	500	175	Topas	-	39.80	26.70	16.90
10001032	50	500	175	PC	-	36.20	24.30	16.10
10001033	50	500	188	Zeonor	-	36.20	24.30	16.10
10001034	50	500	140	Topas*	hydrophilized	39.20	26.30	17.80
10001299	50	500	175	Topas	hydrophilized	42.80	28.70	18.60
10001035	50	500	175	PC	hydrophilized	39.20	26.30	17.80
10001036	50	500	188	Zeonor	hydrophilized	39.20	26.30	17.80

\* not suitable for PCR applications



### 3.6.3 Reaction chamber chips – Various chamber volumes

#### 3.6.3.1 Chamber chips – Various chamber volumes - Rhombic chamber chips

The rhombic chamber chip with chambers featuring various volumes on one chip is the perfect tool to help choosing the right chamber geometry in the design process of integrated microfluidic devices.

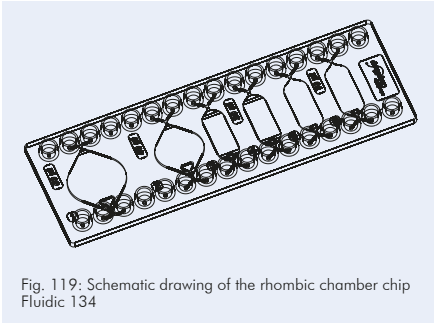

Fig. 119: Schematic drawing of the rhombic chamber chip Fluidic 134

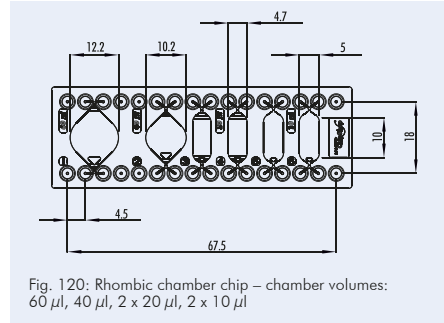

Fig. 120: Rhombic chamber chip – chamber volumes: 60  $\mu\text{l}$ , 40  $\mu\text{l}$ , 2 x 20  $\mu\text{l}$ , 2 x 10  $\mu\text{l}$

Product Code for Fluidic 134	Chamber		Lid Thickness [ $\mu\text{m}$ ]	Material	Surface Treatment	Price [€/chip]		
	Volume [ $\mu\text{l}$ ]	Depth [ $\mu\text{m}$ ]				1+	10+	100+
10000269	10/10	200/200	175	PMMA*	-	36.20	24.30	16.10
	20/20	400/400						
	40/60	540/540						
10000299	10/10	200/200	140	Topas*	-	36.20	24.30	16.10
	20/20	400/400						
	40/60	540/540						
10000121	10/10	200/200	188	Zeonor	-	36.20	24.30	16.10
	20/20	400/400						
	40/60	540/540						
10000386	10/10	200/200	175	PMMA*	hydrophilized	39.20	26.30	17.80
10000432	10/10	200/200	140	Topas*	hydrophilized	39.20	26.30	17.80
	20/20	400/400						
	40/60	540/540						
10000122	10/10	200/200	188	Zeonor	hydrophilized	39.20	26.30	17.80
	20/20	400/400						
	40/60	540/540						

\* not suitable for PCR applications



#### 3.6.3.2 Chamber chips – Various chamber volumes - Reaction chamber chips

The reaction chamber chips with an arrangement of chambers having the same dimensions besides the cavity depth and different volumes allow for the direct comparison of the channel depth influence on the assay and the measurement. These chips assist in the choice of the right channel dimensions in the design process of integrated microfluidic devices. For a particularly convenient handling, these chips are also available with pipetting interfaces.

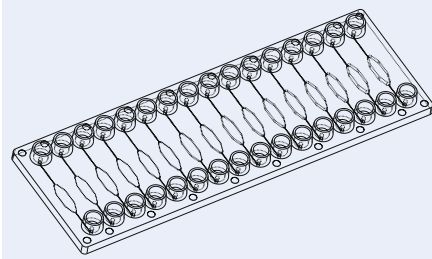

Fig. 121: Schematic drawing of the reaction chamber chip Fluidic 621 with Mini Luer interfaces

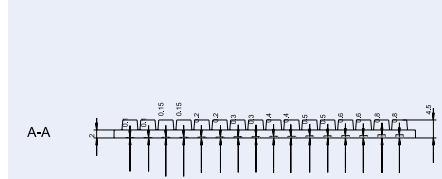

Fig. 122: Schematic drawing of reaction chamber chip – Fluidic 621

Product Code for Fluidic 621	Chamber		Lid Thickness [μm]	Material	Surface Treatment	Price [€/chip]		
	Volume [μl]	Depth [μm]				1+	10+	100+
10000589	1.2 – 10.2	100 - 800	175	PMMA*	-	36.20	24.30	16.10
10000590	1.2 – 10.2	100 - 800	140	Topas*	-	36.20	24.30	16.10
10000591	1.2 – 10.2	100 - 800	125	PS*	-	36.20	24.30	16.10
10000592	1.2 – 10.2	100 - 800	175	PMMA*	hydrophilized	39.20	26.30	17.80
10000594	1.2 – 10.2	100 - 800	140	Topas*	hydrophilized	39.20	26.30	17.80
10000593	1.2 – 10.2	100 - 800	125	PS*	hydrophilized	39.20	26.30	17.80

\* not suitable for PCR applications

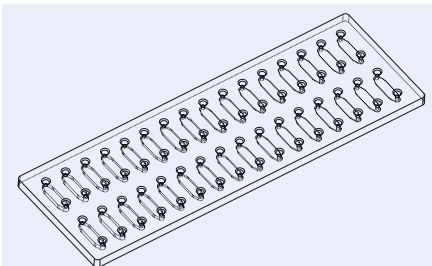

Fig. 123: Schematic drawing of the reaction chamber chip Fluidic 622 with pipetting interfaces

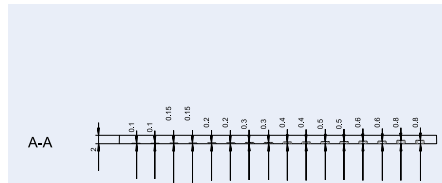

Fig. 124: Schematic drawing of reaction chamber chip – Fluidic 622





Product Code for Fluidic 622	Chamber		Lid Thickness [ $\mu\text{m}$ ]	Material	Surface Treatment	Price [€/chip]		
	Volume [ $\mu\text{l}$ ]	Depth [ $\mu\text{m}$ ]				1+	10+	100+
10000595	1.2 – 10.2	100 - 800	175	PMMA*	-	36.20	24.30	16.10
10000596	1.2 – 10.2	100 - 800	140	Topas*	-	36.20	24.30	16.10
10000597	1.2 – 10.2	100 - 800	125	PS*	-	36.20	24.30	16.10
10000598	1.2 – 10.2	100 - 800	175	PMMA*	hydrophilized	39.20	26.30	17.80
10000599	1.2 – 10.2	100 - 800	140	Topas*	hydrophilized	39.20	26.30	17.80
10000600	1.2 – 10.2	100 - 800	125	PS*	hydrophilized	39.20	26.30	17.80

\* not suitable for PCR applications

### 3.6.3.3 Chamber chips – Various chamber volumes - Interconnected chambers

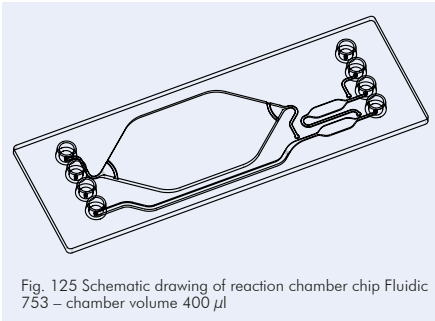

Fig. 125 Schematic drawing of reaction chamber chip Fluidic 753 – chamber volume 400  $\mu\text{l}$

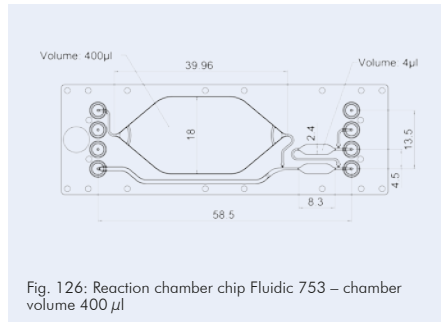

Fig. 126: Reaction chamber chip Fluidic 753 – chamber volume 400  $\mu\text{l}$

Product Code for Fluidic 753	Chamber		Lid Thickness [ $\mu\text{m}$ ]	Material	Surface Treatment	Price [€/chip]		
	Volume 1 [ $\mu\text{l}$ ]	Volume 2 & 3 [ $\mu\text{l}$ ]				1+	10+	100+
10001265	400	4.1	140	Topas*	-	36.20	24.30	16.10
10001044	400	4.1	175	PC	-	36.20	24.30	16.10
10001045	400	4.1	188	Zeonor	-	36.20	24.30	16.10
10001266	400	4.1	140	Topas*	hydrophilized	39.20	26.30	17.80
10001047	400	4.1	175	PC	hydrophilized	39.20	26.30	17.80
10001048	400	4.1	188	Zeonor	hydrophilized	39.20	26.30	17.80

\* not suitable for PCR applications



#### 3.7 Waste chamber chips

##### 3.7.1 Waste chamber chips – Single channel

This device is equipped with a single broad channel and an additional chamber, which can be used for instance for on-chip waste storage. As fluidic interfaces, female Luer connectors are attached.

For the colored chips, the structured part is dyed and the cover lid is transparent.

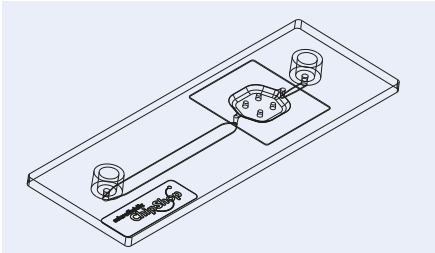

Fig. 127: Schematic drawing of a straight channel chip with additional large chamber

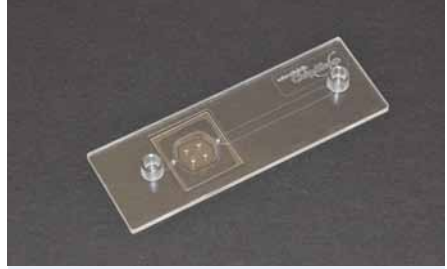

Fig. 128: Straight channel chip – transparent



Fig. 129: Straight channel chip – transparent with spotted probes



Fig. 130: Straight channel chip – black

Product Code for Fluidic 95	Channel			Volume chamber [ $\mu$ l]	Material	Price [€/chip]		
	Width [ $\mu$ m]	Depth [ $\mu$ m]	Length [mm]			1+	10+	30+
10000220	3,000	200	36.0	75	PMMA	44.50	31.20	23.50
10000221	3,000	200	36.0	75	Topas	44.50	31.20	23.50
10000222	3,000	200	36.0	75	Topas, black	44.50	31.20	23.50
10000223	3,000	200	36.0	75	PC	44.50	31.20	23.50
10000224	3,000	200	36.0	75	PC, black	44.50	31.20	23.50
10000225	3,000	200	36.0	75	Zeonor	44.50	31.20	23.50
10000226	3,000	200	36.0	75	Zeonor, black	44.50	31.20	23.50



### 3.7.2 Waste chamber chips – Double channel

This chip features two individual channels, each of them connected to a large reservoir for convenient fluid waste management. Four Mini Luer interfaces for each of these channels allow not only to apply the sample, but furthermore to flow different reagent solutions in the channels and chambers using connected pumps. The large waste reservoirs, facilitating a liquid uptake of roughly 500  $\mu\text{l}$  each, enable to run assays without a need for additional waste management. A water-tight but air permeable membrane ensures that no contamination will take place through the waste reservoirs.

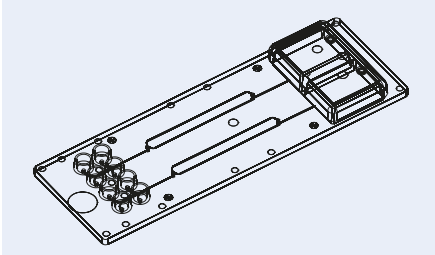

Fig. 131: Schematic drawing of a straight channel chip with waste chamber 272

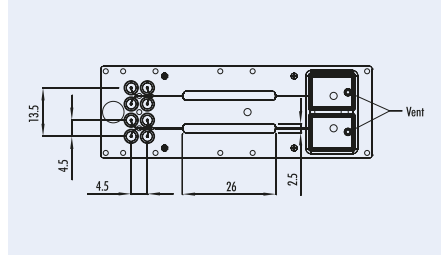

Fig. 132: Details straight channel chip with waste chamber 272

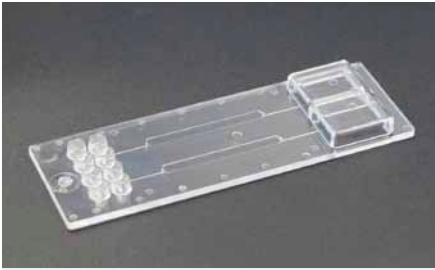

Fig. 133: Straight channel chip 272

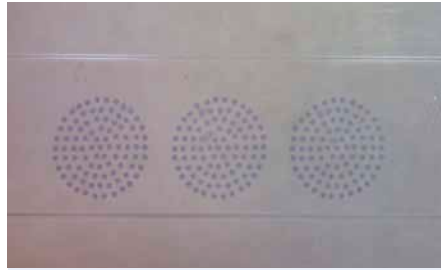

Fig. 134: Spotted probes (diameter 80  $\mu\text{m}$ ) in straight channel chip 272

Product Code for Fluidic 272	Width [ $\mu\text{m}$ ]	Channel Depth [ $\mu\text{m}$ ]	Length [mm]	Lid Thickness [ $\mu\text{m}$ ]	Material	Surface treatment	Price [€/chip]		
							1+	10+	100+
10000328	2,500	200	26.0	175	PMMA	-	44.50	31.20	23.50
10000297	2,500	200	26.0	140	Topas	-	44.50	31.20	23.50
10000268	2,500	200	26.0	188	Zeonor	-	44.50	31.20	23.50
10000644	2,500	200	26.0	188	Zeonor black	-	44.50	31.20	23.50
10000645	2,500	200	26.0	188	Zeonor white	-	44.50	31.20	23.50
10000341	2,500	200	26.0	175	PMMA	hydrophilized	55.50	36.20	25.60
10000342	2,500	200	26.0	140	Topas	hydrophilized	55.50	36.20	25.60
10000343	2,500	200	26.0	188	Zeonor	hydrophilized	55.50	36.20	25.60



### 3.8 Cuvette chips

This chapter summarizes a variety of microfluidic chips for optical measurements. Several of these chips feature different chamber depths within the measurement window, allowing to enlarge the dynamic range of the analytical process.

Chips for self-filling are included as well as with larger reservoirs enabling easy sample introduction combined with defined sample volume.

#### 3.8.1 Straight channel cuvette chip

Chip with eight parallel, identical measurement cavities with three depths within each individual channel.

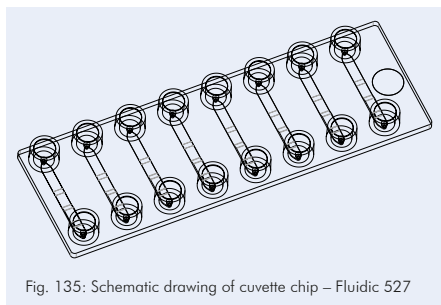

Fig. 135: Schematic drawing of cuvette chip – Fluidic 527

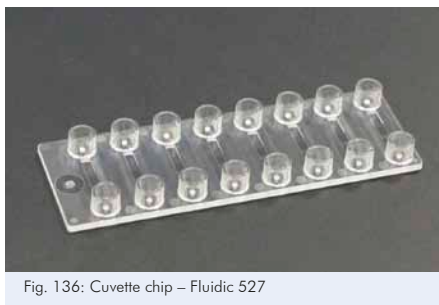

Fig. 136: Cuvette chip – Fluidic 527

Product Code for Fluidic 527	Description	Channel Volume [ $\mu$ l]	Channel Depth [ $\mu$ m]			Lid Thickness [ $\mu$ m]	Surface Treatment	Material	Price [€/chip]		
			Sec. 1	Sec. 2	Sec. 3				1+	10+	100+
10000437	Cuvette chip	6.5	50	100	500	140	-	Topas	36.20	24.30	16.10
10000438	Cuvette chip	6.5	50	100	500	140	hydrophilized	Topas	39.20	26.30	17.80

#### 3.8.2 Cuvette tank chip

Cuvette tank chips possess a larger sample uptake interface and measurement cavities with two chamber depths. Fluidic 576 furthermore features an incubation meander before the measurement chambers.

To avoid liquid flow after filling the measurement chamber until equilibrium between inlet and outlet filling height is ensured, the chips can be equipped with a venting membrane allowing to dissipate air, but remaining liquid tight.

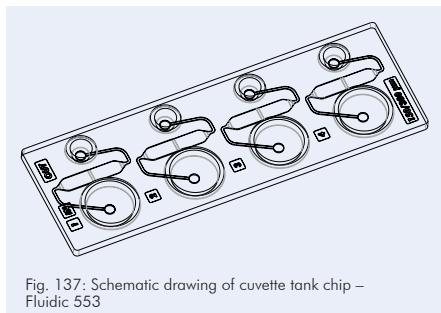

Fig. 137: Schematic drawing of cuvette tank chip – Fluidic 553

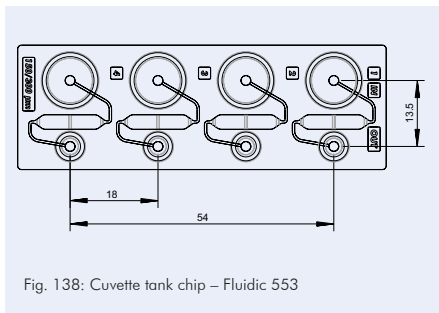

Fig. 138: Cuvette tank chip – Fluidic 553



Product Code for Fluidic 553	Description	Chamber-volume [ $\mu$ l]	Chamber depth [ $\mu$ m]		Lid Thickness [ $\mu$ m]	Surface treatment	Venting Membrane	Material	Price [€/chip]		
			Sec. 1	Sec. 2					1+	10+	100+
10000816	Cuvette tank chip	6.75	150	300	140	-	-	Topas	36.20	24.30	16.10
10000817	Cuvette tank chip	6.75	150	300	140	-	Yes	Topas	46.20	31.20	20.10
10000818	Cuvette tank chip	6.75	150	300	140	Hydrophilized	-	Topas	39.20	26.30	17.80
10000819	Cuvette tank chip	6.75	150	300	140	Hydrophilized	Yes	Topas	49.20	33.20	21.90

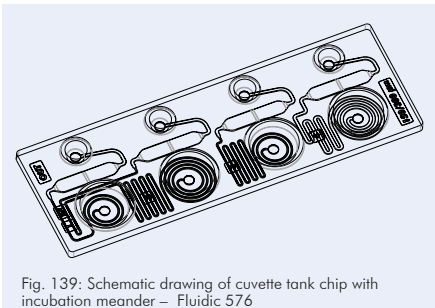

Fig. 139: Schematic drawing of cuvette tank chip with incubation meander – Fluidic 576

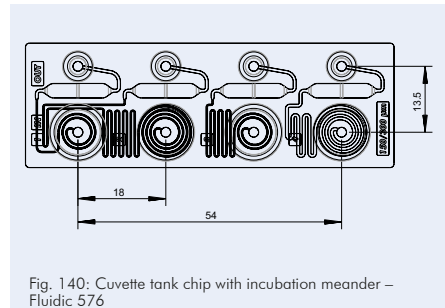

Fig. 140: Cuvette tank chip with incubation meander – Fluidic 576

Product Code for Fluidic 576	Description	Chamber-volume [ $\mu$ l]	Chamber depth [ $\mu$ m]		Lid Thickness [ $\mu$ m]	Surface treatment	Venting Membrane	Material	Price [€/chip]		
			Sec. 1	Sec. 2					1+	10+	100+
10000820	Cuvette tank chip with incubation meander	6.75	150	300	140	-	-	Topas	36.20	24.30	16.10
10000821	Cuvette tank chip with incubation meander	6.75	150	300	140	-	Yes	Topas	46.20	31.20	20.10
10000822	Cuvette tank chip with incubation meander	6.75	150	300	140	hydrophilized	-	Topas	39.20	26.30	17.80
10000823	Cuvette tank chip with incubation meander	6.75	150	300	140	hydrophilized	Yes	Topas	49.20	33.20	21.90

#### 3.9 Splitter chips

In many experimental setups splitting of contents from one microfluidic input channel is required. Splitter chips are specifically designed to evenly divide one microfluidic stream for downstream applications.

##### 3.9.1. Splitter chips - Dead-end air reservoir

This family of chips allows to perform e.g. parallel batch PCR reactions from a single input. The input is thereby split into 8 or 10 separate reaction chambers. The reaction chamber is followed by a chamber with an enclosed air volume, which buffers the volume expansion/contraction during thermocycling. As this air volume is enclosed, no reagent loss due to evaporation occurs. The loading pressure is designed for 250mBar.

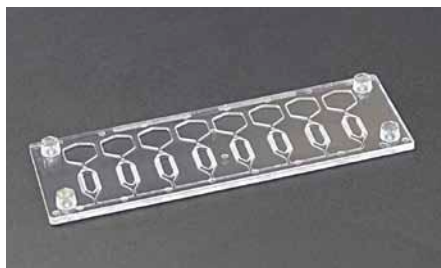

Fig. 141: Dead-end reservoir splitter chip Fluidic 675 with 8 chambers of 20  $\mu\text{l}$  volume

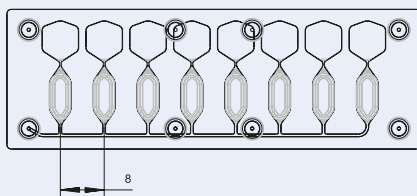

Fig. 142: Schematic drawing of Fluidic 675 with Mini Luer interface

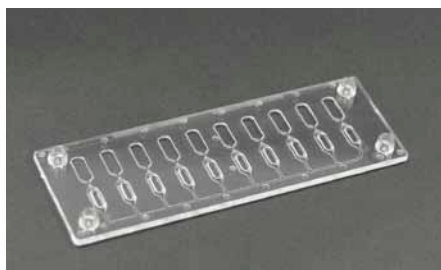

Fig. 143: Dead-end reservoir splitter chip Fluidic 683 with 10 reaction chambers of 10  $\mu\text{l}$  volume

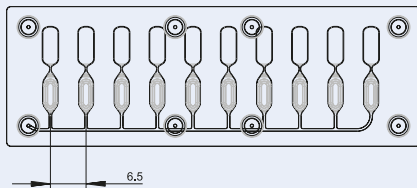

Fig. 144: Schematic drawing of Fluidic 683 with Mini Luer interface

Product Code	Fluidic	Chamber		Lid Thickness $[\mu\text{m}]$	Material	Surface Treatment	Price [€/chip]		
		Volume $[\mu\text{l}]$	Depth $[\mu\text{m}]$				1+	10+	100+
10000783	675	20	500	175	Topas	-	36.20	24.30	16.10
10000784	675	20	500	175	Topas	hydrophilized	39.20	26.30	17.80
10000786	683	10	500	175	Topas	-	36.20	24.30	16.10
10000785	683	10	500	175	Topas	hydrophilized	39.20	26.30	17.80



### 3.9.2 Splitter chips - Flow through splitter chips

This subfamily of splitter chips is particularly suited for applications in which one microfluidic stream needs to be divided into several, for downstream applications. The input of one inlet with Mini Luer interface is divided into four or eight (Fluidic 532) or even ten (Fluidic 487) streams, sampled via respective outlets with Mini Luer interfaces. Both Fluidic 532 and Fluidic 487 come with performance enhancing capillary stops, whereby Fluidic 487 furthermore offers small chambers for on-chip analysis or detection.

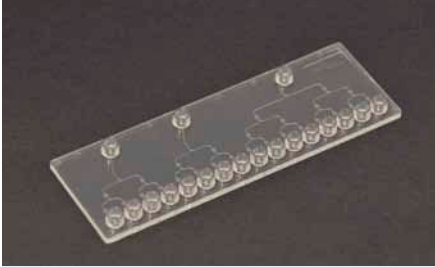

Fig. 145: Splitter chip Fluidic 532 with Mini Luer interfaces

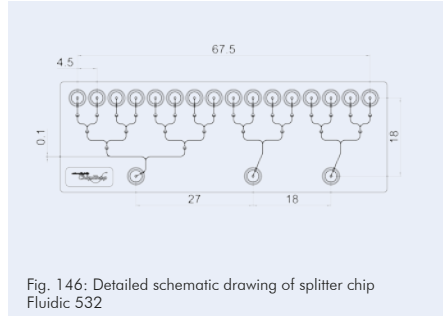

Fig. 146: Detailed schematic drawing of splitter chip Fluidic 532

Product Code for Fluidic 532	Description	Lid Thickness [ $\mu\text{m}$ ]	Material	Price [€/chip]		
				1+	10+	100+
10001328	Splitter chip	140	Topas	36.20	24.30	16.10

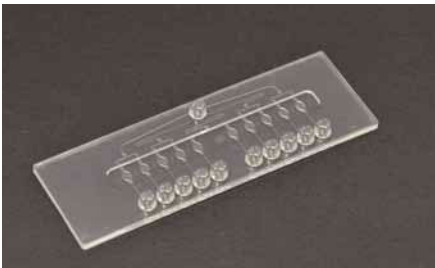

Fig. 147: Splitter chip Fluidic 487 with Mini Luer interfaces and  $0.5 \mu\text{l}$  chambers for on-chip analysis

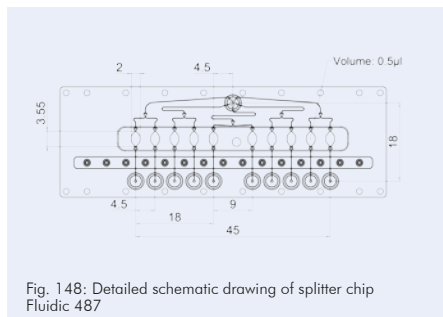

Fig. 148: Detailed schematic drawing of splitter chip Fluidic 487

Product Code for Fluidic 487	Description	Lid Thickness [ $\mu\text{m}$ ]	Material	Price [€/chip]		
				1+	10+	100+
10001329	Splitter chip	140	Topas	36.20	24.30	16.10



#### 3.10 Micro mixer

Microfluidic micro mixers apply different mixing principles. This chapter includes mixers applying passive and active mixing principles. Passive mixing elements with elongated channels to enforce diffusion mixing or the so-called “herringbone” mixing structures are available. Active mixers with integrated stir bars give the option to generate mixtures with a wider range of mixing ratios, e.g. coping with 1:10 mixing ratios what is not feasible with the passively working devices.

#### 3.10.1 Passive mixers

##### 3.10.1.1 Passive mixer – Diffusion mixer

Passive mixers mix liquids by diffusion. As flows in microchannels are normally laminar, the task of these mixers lies in the improvement of the diffusion condition, e.g. by allowing a long co-flow of the liquids (3.10.1.1, 3.10.1.3) or by adding structures to increase lateral velocity (3.10.1.2, 3.10.1.4). As there are multiple mixing structures on each chip, these can be daisy-chained to improve the mixing result.

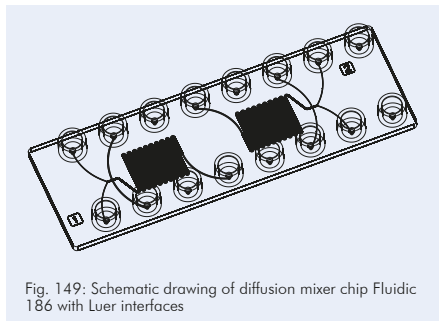

Fig. 149: Schematic drawing of diffusion mixer chip Fluidic 186 with Luer interfaces

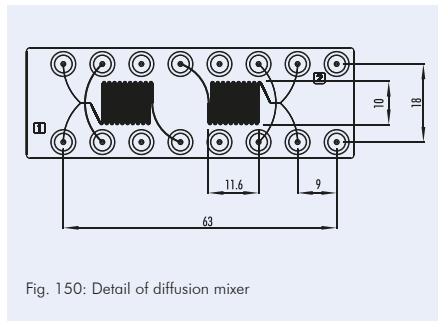

Fig. 150: Detail of diffusion mixer

Product Code for Fluidic 186	Lid Thickness [μm]	Channel Depth [μm]	Channel Width [μm]	Material	Price [€/chip]		
					1+	10+	100+
10000018	175	100	inlets 100 / 200 mixer 200 outlet 200	PC	42.20	31.50	19.30
10000075	188	100	intets 100 / 200 mixer 200 outlet 200	Zeonor	42.20	31.50	19.30

##### 3.10.1.2 Passive mixer – Herringbone mixer

This mixer is based on the principle as described in: A.D. Stroock et al., Chaotic Mixer for Microchannels, Science, 295, 647-651, 2002.



Fig. 151: Herringbone mixer chip Fluidic 187 with Luer interfaces

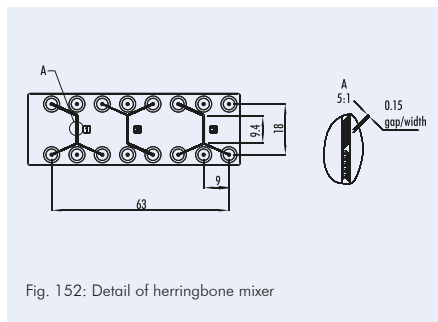

Fig. 152: Detail of herringbone mixer





Product Code for Fluidic 187	Lid Thickness [μm]	Channel Depth [μm]	Channel Width [μm]	Material	Price [€/chip]		
					1+	10+	100+
10000019	175	200	inlet 300 mixer 600 outlet 600	PC	42.20	31.50	19.30
10000076	188	200	inlet 300 mixer 600 outlet 600	Zeonor	42.20	31.50	19.30

### 3.10.1.3 Passive mixer – Phase guide mixer

This mixer is based on the principle as described in: S. Hakenberg et al., A phaseguided passive batch microfluidic mixing chamber for isothermal amplification, Lab Chip, 12, 4576-4580, 2012.

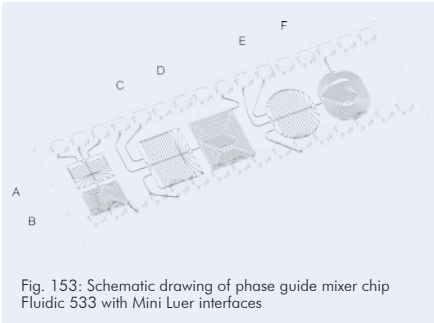

Fig. 153: Schematic drawing of phase guide mixer chip Fluidic 533 with Mini Luer interfaces

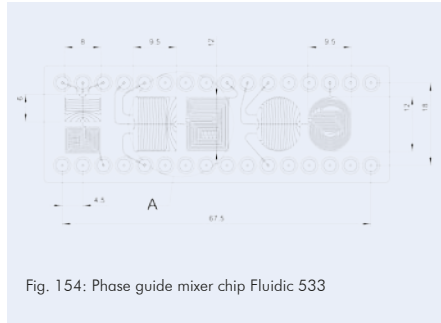

Fig. 154: Phase guide mixer chip Fluidic 533

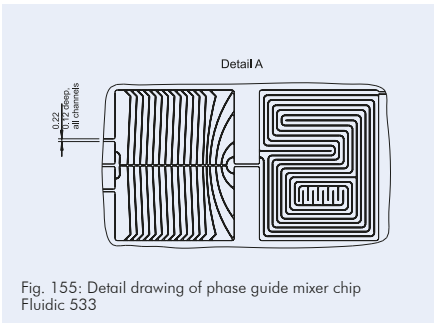

Fig. 155: Detail drawing of phase guide mixer chip Fluidic 533



Fig. 156: Phase guide mixer chip Fluidic 533

Product Code for Fluidic 533	Description	Chamber volumes	Lid Thickness [μm]	Surface Treatment	Material	Price [€/chip]		
						1+	10+	100+
10000552	Phase guide mixer chip	A & B: 5.6 μl C & D: 13.2 μl E & F: 11.1 μl	140	-	Topas	42.20	31.50	19.30
10000553	Phase guide mixer chip	A & B: 5.6 μl C & D: 13.2 μl E & F: 11.1 μl	140	hydrophilized	Topas	46.20	34.70	21.40



#### 3.10.1.4 Passive mixer – Micro vortex mixer

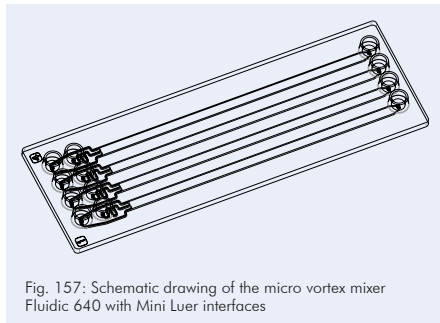

Fig. 157: Schematic drawing of the micro vortex mixer Fluidic 640 with Mini Luer interfaces

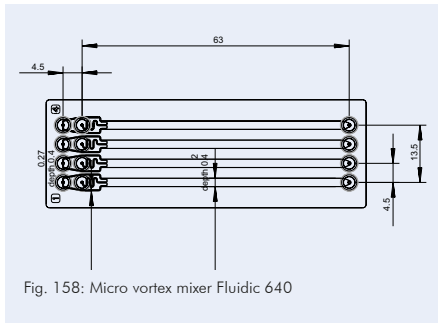

Fig. 158: Micro vortex mixer Fluidic 640

Product Code for Fluidic 640	Description	Lid Thickness [ $\mu\text{m}$ ]	Material	Surface Treatment	Price [€/chip]		
					1+	10+	100+
10000771	Micro vortex mixer	175	PMMA	-	42.20	31.50	19.30
10000772	Micro vortex mixer	140	Topas	-	42.20	31.50	19.30
10000773	Micro vortex mixer	175	PC	-	42.20	31.50	19.30
10000774	Micro vortex mixer	175	PMMA	hydrophilized	46.20	34.70	21.40
10000775	Micro vortex mixer	140	Topas	hydrophilized	46.20	34.70	21.40
10000776	Micro vortex mixer	175	PC	hydrophilized	46.20	34.70	21.40

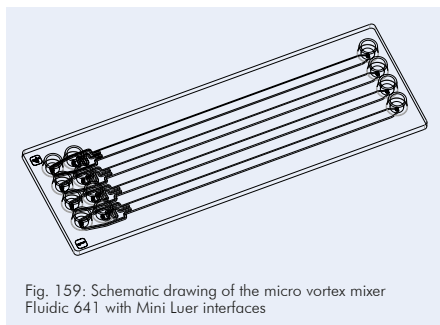

Fig. 159: Schematic drawing of the micro vortex mixer Fluidic 641 with Mini Luer interfaces

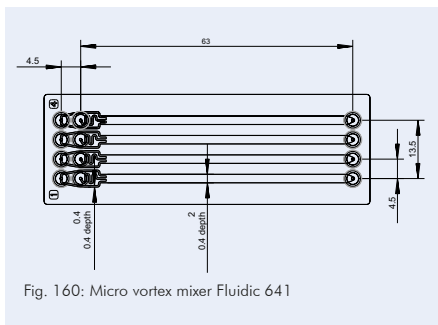

Fig. 160: Micro vortex mixer Fluidic 641

Product Code for Fluidic 641	Description	Lid Thickness [ $\mu\text{m}$ ]	Material	Surface Treatment	Price [€/chip]		
					1+	10+	100+
10000777	Micro vortex mixer	175	PMMA	-	42.20	31.50	19.30
10000778	Micro vortex mixer	140	Topas	-	42.20	31.50	19.30
10000779	Micro vortex mixer	175	PC	-	42.20	31.50	19.30
10000780	Micro vortex mixer	175	PMMA	hydrophilized	46.20	34.70	21.40
10000781	Micro vortex mixer	140	Topas	hydrophilized	46.20	34.70	21.40
10000782	Micro vortex mixer	175	PC	hydrophilized	46.20	34.70	21.40

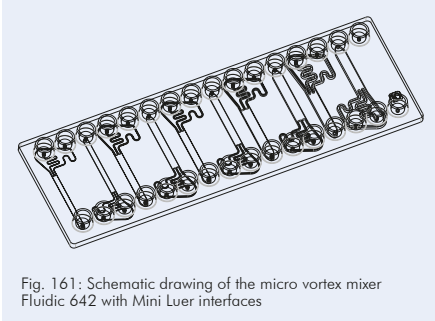

Fig. 161: Schematic drawing of the micro vortex mixer Fluidic 642 with Mini Luer interfaces

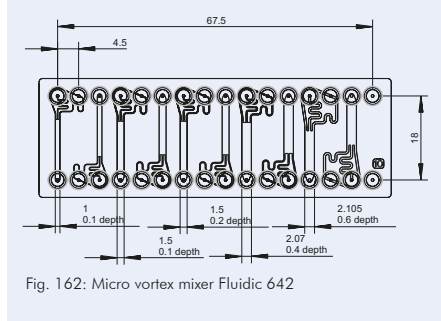

Fig. 162: Micro vortex mixer Fluidic 642

Product Code for Fluidic 642	Description	Lid Thickness [μm]	Material	Surface Treatment	Price [€/chip]		
					1+	10+	100+
10001204	Micro vortex mixer	175	PMMA	-	42.20	31.50	19.30
10000824	Micro vortex mixer	140	Topas	-	42.20	31.50	19.30
10001206	Micro vortex mixer	175	PC	-	42.20	31.50	19.30
10001205	Micro vortex mixer	175	PMMA	hydrophilized	46.20	34.70	21.40
10000961	Micro vortex mixer	140	Topas	hydrophilized	46.20	34.70	21.40
10001207	Micro vortex mixer	175	PC	hydrophilized	46.20	34.70	21.40

### 3.10.1.5 Passive mixer – Pearl chain mixer

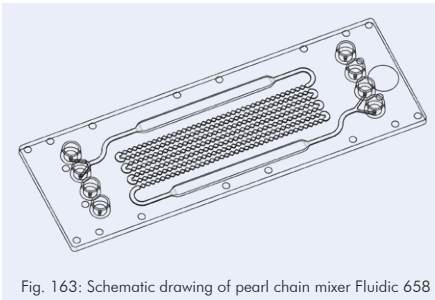

Fig. 163: Schematic drawing of pearl chain mixer Fluidic 658

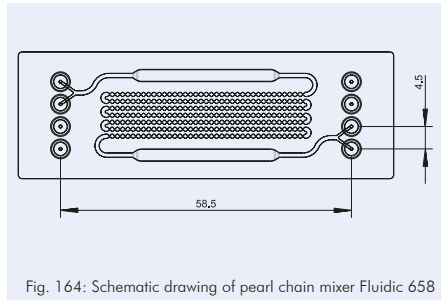

Fig. 164: Schematic drawing of pearl chain mixer Fluidic 658



Fig. 165: Pearl chain mixer Fluidic 658 with Mini Luer interfaces

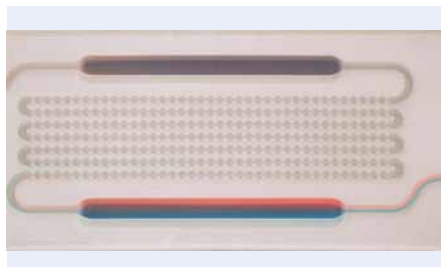

Fig. 166: Mixing of two colored liquids with the pearl chain mixer



### 3 Microfluidic chips – Polymers

Product Code for Fluidic 658	Description	Lid Thickness [ $\mu\text{m}$ ]	Material	Price [€/chip]		
				1+	10+	100+
10000759	Pearl-chain mixer	125	Topas	42.20	34.30	26.10
10000760	Pearl-chain mixer	175	PC	42.20	34.30	26.10

#### 3.10.2 Active mixer

##### 3.10.2.1 Active mixer - Stir bar actuated mixer

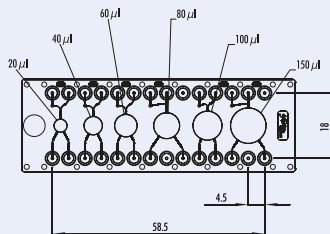

Fig. 167: Drawing of micro mixer chip with mixing chambers Fluidic 286 with Mini Luer interfaces



Fig. 168: Micro mixer with magnetic stir bars for active mixing

Product Code for Fluidic 286	Chamber volume						Chamber depth [mm]	Lid Thickness [ $\mu\text{m}$ ]	Material	Price [€/chip]	
	[ $\mu\text{l}$ ]	[ $\mu\text{l}$ ]	[ $\mu\text{l}$ ]	[ $\mu\text{l}$ ]	[ $\mu\text{l}$ ]	[ $\mu\text{l}$ ]				1+	10+
10000020	20	40	60	80	100	150	1.5	175	PMMA	82.50	63.50
10000077	20	40	60	80	100	150	1.5	188	Zeonor	82.50	63.50



### 3.10.2.2 Active mixer – Finger pump mixer

This mixer contains a variety of mixing units. On the one hand, mixing of up to three liquids is facilitated by the pearl-chain unit, on the other hand an integrated finger pump can be used to displace air and in this way move liquid forth and back in the channel system.

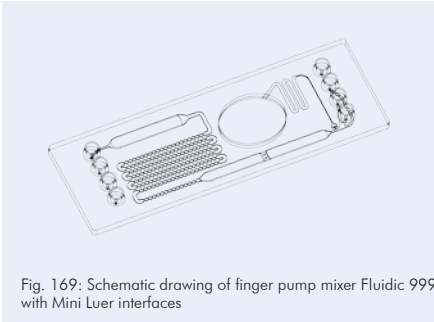

Fig. 169: Schematic drawing of finger pump mixer Fluidic 999 with Mini Luer interfaces

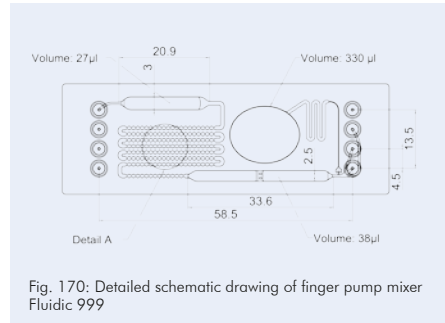

Fig. 170: Detailed schematic drawing of finger pump mixer Fluidic 999

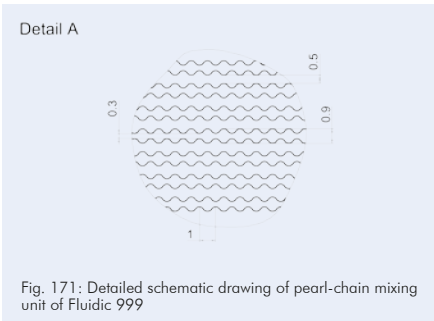

Fig. 171: Detailed schematic drawing of pearl-chain mixing unit of Fluidic 999

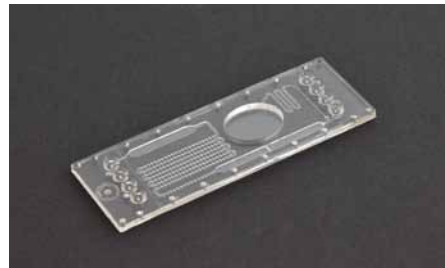

Fig. 172: Finger pump mixer Fluidic 999



Fig. 173: Finger pump mixer Fluidic 999 working principle. Further mixing can be managed by utilizing the pumping unit (arrow)

Product Code for Fluidic 999	Description	Lid Thickness [µm]	Material	Price [€/chip]		
				1+	10+	100+
10001330	Finger pump mixer	140	Topas	42.50	31.40	24.90
10001331	Finger pump mixer	188	Zeonor	42.50	31.40	24.90



#### 3.11 Titer plates in microscopy slide format

Our micro- or nanowell plates have the format of a microscopy slide (75.5 mm x 25.5 mm x 1.5 mm) and include cavities with different shapes and volumes.

##### 3.11.1 Nanotiter plate

On our nanowell plates, three well arrays with wells of different edge lengths are placed. The arrays have 14 x 14 (well spacing of 1,125  $\mu\text{m}$ ), 28 x 28 (well spacing of 562.5  $\mu\text{m}$ ), and 60 x 60 (well spacing of 281.25  $\mu\text{m}$ ) single wells.

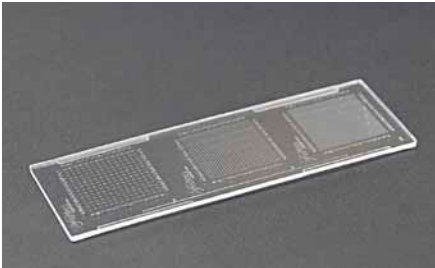

Fig. 174: Nanotiter plate Fluidic 18



Fig. 175: Nanotiter plate – well detail

Product Code for Fluidic 18	Well Depth [ $\mu\text{m}$ ]	Well Size [ $\mu\text{m}$ ] Structure			Well Spacing [ $\mu\text{m}$ ] Structure			Material	Price [€/chip]				
		1	2	3	1	2	3		1+	10+	50+	100+	500+
		Top Bot.	Top Bot.	Top Bot.	1	2	3						
10000199	20	124 96	224 196	424 396	281.25	562.5	1125	PMMA	40.00	30.00	9.00	7.00	5.20
10000200	20	124 96	224 196	424 396	281.25	562.5	1125	Topas	45.00	35.00	14.00	8.00	5.40
10000201	20	124 96	224 196	424 396	281.25	562.5	1125	PC	40.00	30.00	9.00	7.00	5.20
10000202	20	124 96	224 196	424 396	281.25	562.5	1125	Zeonor	45.00	35.00	14.00	8.00	5.40
10000203	20	124 96	224 196	424 396	281.25	562.5	1125	Zeonex	45.00	35.00	14.00	8.00	5.40

##### 3.11.2 18-well chip

The 18-well chip (119  $\mu\text{l}$ /well) features the spacing of a 96-well microtiter plate, namely 9 mm, and is available in different materials and in transparent and colored versions. It can be used with our adapter frame in microtiter-plate format that is made as a special adapter for microfluidic chips in microscopy slide format.

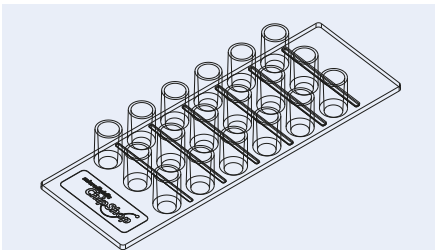

Fig. 176: Schematic drawing of the 18-well titer plate Fluidic 141

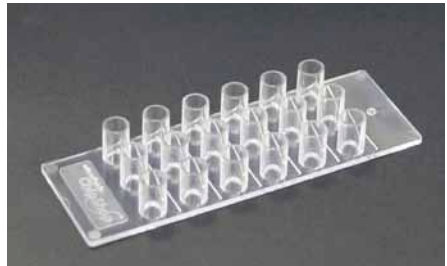

Fig. 177: 18-well chip Fluidic 141



Product Code for Fluidic 141	Well Volume [ $\mu$ l]	Material	Price [€/chip]		
			1+	10+	100+
10000883	119	Topas	20.00	15.00	5.40
10000907	119	Topas, black	20.00	15.00	5.40
10000885	119	PS	20.00	15.00	5.40
10000905	119	PS, white	20.00	15.00	5.40
10000906	119	PS, black	20.00	15.00	5.40
10000250	119	Zeonor	20.00	15.00	5.40
10000251	119	Zeonor, white	20.00	15.00	5.40
10000884	119	Zeonor, black	20.00	15.00	5.40

### 3.11.3 65-well chip

This 65-well chip (25.9  $\mu$ l/well) has the spacing of a 384 well plate, namely 4.5 mm. It can be used with the micro-titer plate sized adapter frames described in the accessories chapter. The chip can be used to carry out reactions or as a source plate for spotting experiments, e.g. with the instrumentTWO spotter shown in the instrument chapter.

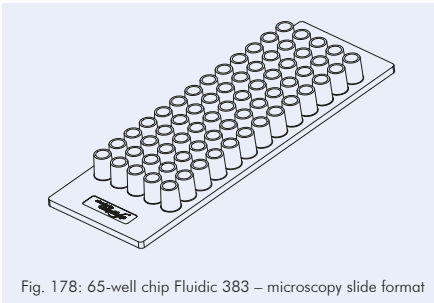

Fig. 178: 65-well chip Fluidic 383 – microscopy slide format

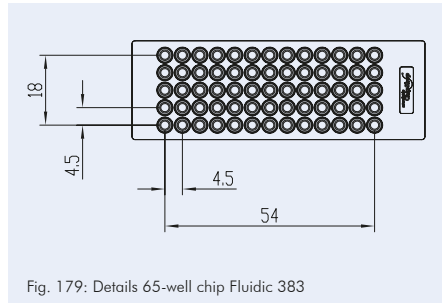

Fig. 179: Details 65-well chip Fluidic 383

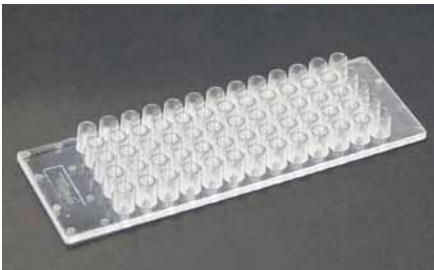

Fig. 180: 65-well chip Fluidic 383



Fig. 181: 65-well chip used as source plate in spotter

Product Code for Fluidic 383	Well Volume [ $\mu$ l]	Material	Price [€/chip]		
			1+	10+	100+
10000252	25	Zeonor	20.00	15.20	5.45
10000253	25	PP	20.00	15.20	5.45

#### 3.12 Droplet generator chips and integrated droplet generation solutions

A family of droplet generator chips in various designs allows for the generation of droplets in different sizes and frequencies. Integrated chips exceeding the droplet generation function e.g. by combining droplet generation with droplet storage for subsequent optical analysis allowing a wide variety of experiments.

All droplet generators possess microscopy slide format and can be operated in both pumping and suction modes.

Furthermore, our droplet generator chips either possess Mini Luer or Luer interfaces for a convenient connection of the chip with an appropriate pumping system. Below an overview of all available droplet generators and their key features is given.

**Material compatibility:** Please be aware of material compatibility when setting up your droplet generation experiment. When utilizing silicone-based oils we recommend the use of Topas chips, while mineral oils require chips made from PC.

Fluidic Design	Interface Type	Nozzle Sizes [μm]	Single-Cross	Double-Cross	Generator Units /Chip	Droplet Storage
162	Mini Luer	70	Yes	Yes	1	No
163	Mini Luer	140	Yes	Yes	1	No
285	Mini Luer	50; 70; 80; 100	Yes	No	5	No
440	Mini Luer	50; 60; 70; 80	Yes	No	8	No
488	Mini Luer	74	Yes	Yes	1	Yes
536	Luer	38	Yes	Yes	3	No
537	Luer	38	Yes	No	4	No
719	Mini Luer	82	Yes	Yes	1	Yes
912	Mini Luer	80	Yes	No	8	No
947	Mini Luer	10; 15; 20; 30	Yes	No	8	No
1032	Mini Luer	100	Yes	Yes	3	No

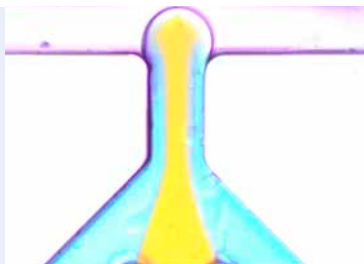

Fig. 182: Droplet Generator Fluidic 163 with two consecutive channel crossings

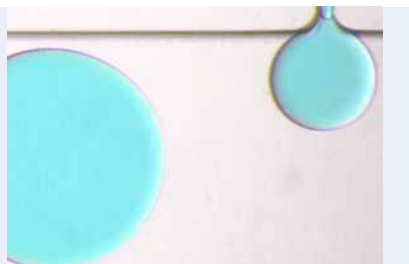

Fig. 183: Droplet generation using Fluidic 285 - largest nozzle of 100 μm with droplet collection in 1 mm channel





### 3.12.1 Droplet generator chips – One channel designs

Droplet generators Fluidic 162 and Fluidic 163 feature a double channel crossing in the droplet generation region and one droplet collection channel. Being similar in design and possessing several inlet and outlets with Mini Luer interfaces, the main differences between Fluidic 162 and Fluidic 163 are the channel widths.

Like most droplet generators with a double-cross geometry, they can also be used for single-cross experiments by simply not connecting respective channels but closing their interfaces with plugs.

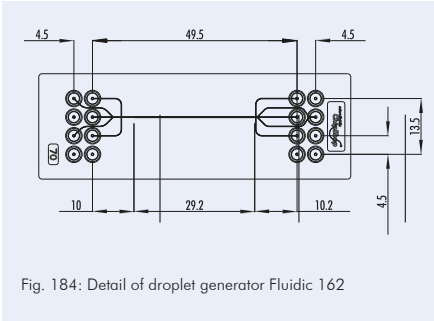

Fig. 184: Detail of droplet generator Fluidic 162

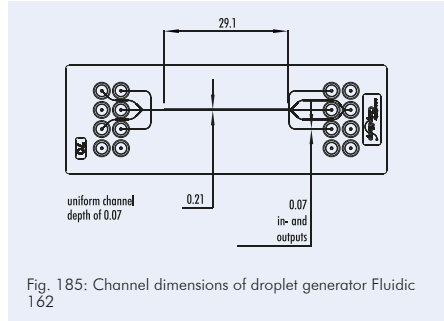

Fig. 185: Channel dimensions of droplet generator Fluidic 162

Product Code for Fluidic 162	Input Channel Width [μm]	Collection Channel Width [μm]	Channel Depth [μm]	Lid Thickness [μm]	Material	Price [€/chip]		
						1+	10+	100+
10000005	70	210	70	140	Topas	42.20	34.30	26.10
10000003	70	210	70	175	PC	42.20	34.30	26.10

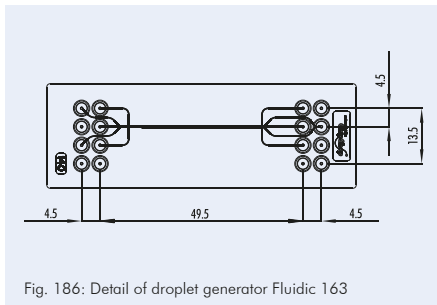

Fig. 186: Detail of droplet generator Fluidic 163

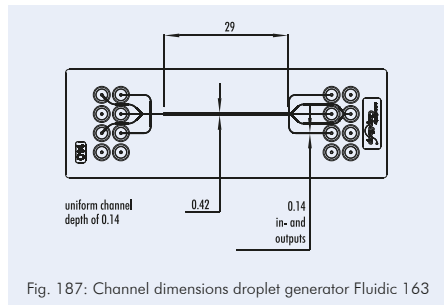

Fig. 187: Channel dimensions droplet generator Fluidic 163

Product Code for Fluidic 163	Input Channel Width [μm]	Collection Channel Width [μm]	Channel Depth [μm]	Lid Thickness [μm]	Material	Price [€/chip]		
						1+	10+	100+
10000006	140	420	140	140	Topas	42.20	34.30	26.10
10000004	140	420	140	175	PC	42.20	34.30	26.10

3.12.2 Droplet generator chips – Multi channel designs

3.12.2.1 Droplet generator chips – Multi channel designs – Single-cross geometry

Droplet generator chips of this type provide several functional droplet generator units of the same geometry on one chip.

Droplet generator chip Fluidic 537 with a single-cross geometry and Luer interfaces was specifically developed to be used in both pumping and suction mode. The chip contains four identical droplet generation units with a nozzle size of 38  $\mu\text{m}$ .

In contrast, Fluidic 912 features Mini Luer interfaces and eight identical droplet generation units with a channel dimension of 80  $\mu\text{m}$  at the droplet formation region.

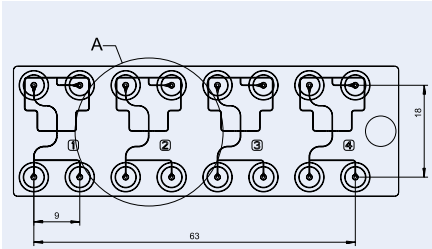

Fig. 188: Schematic drawing of droplet generator chip Fluidic 537 with Luer interfaces

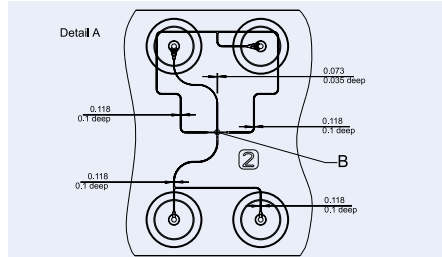

Fig. 189: Droplet generator chip Fluidic 537 – detail channel dimensions

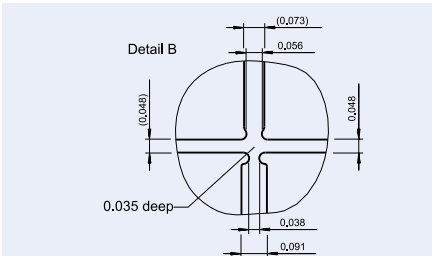

Fig. 190: Droplet generator chip Fluidic 537 – detail cross element

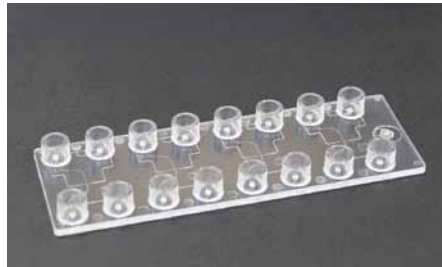

Fig. 191: Droplet generator chip Fluidic 537

Product Code for Fluidic 537	Lid Thickness [ $\mu\text{m}$ ]	Material	Price [€/chip]		
			1+	10+	100+
10000466	140	Topas	42.20	34.40	26.10
10000467	175	PC	42.20	34.40	26.10

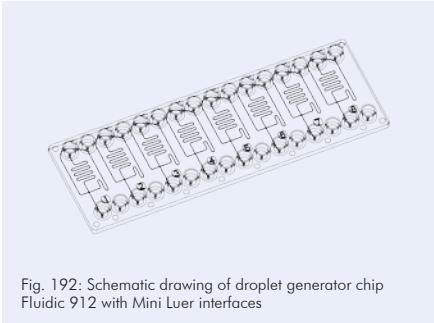

Fig. 192: Schematic drawing of droplet generator chip Fluidic 912 with Mini Luer interfaces

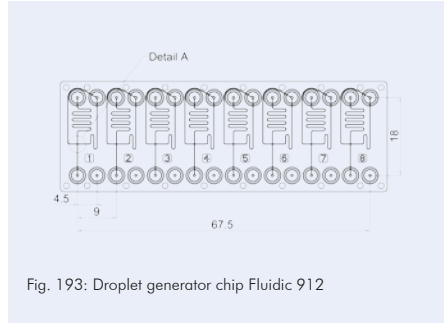

Fig. 193: Droplet generator chip Fluidic 912

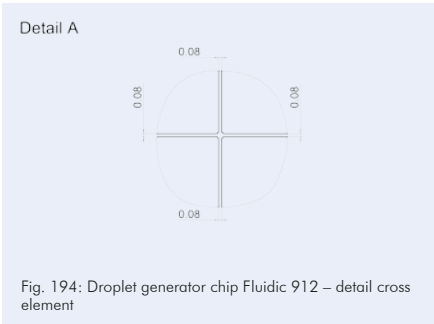

Fig. 194: Droplet generator chip Fluidic 912 – detail cross element

Product Code for Fluidic 912	Lid Thickness [μm]	Material	Price [€/chip]		
			1+	10+	100+
10001332	140	Topas	42.20	34.40	26.10
10001333	175	PC	42.20	34.40	26.10

### 3.12.2.2 Droplet generator chips – Multi channel designs – Double-cross geometry

Droplet generator chips with a double-cross geometry allow for the generation of double emulsions, such as the inclusion of droplets or cells deriving from the first channel intersection in a further droplet shell at the second channel intersection. We offer two distinct designs, Fluidic 536 and Fluidic 1032, that vary in channel/nozzle size.

Please note that, although very similar in general layout, Fluidic 536 possesses Luer interfaces while Fluidic 1032 is equipped with Mini Luer interfaces.

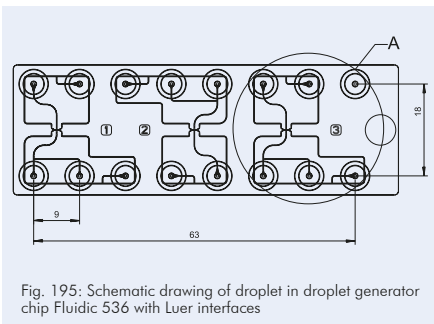

Fig. 195: Schematic drawing of droplet in droplet generator chip Fluidic 536 with Luer interfaces

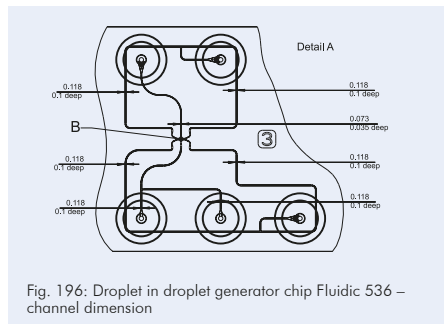

Fig. 196: Droplet in droplet generator chip Fluidic 536 – channel dimension

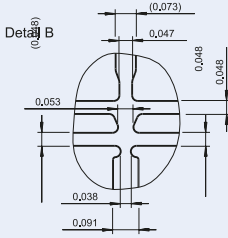

Fig. 197: Droplet in droplet generator chip Fluidic 536 – detail channel intersection element

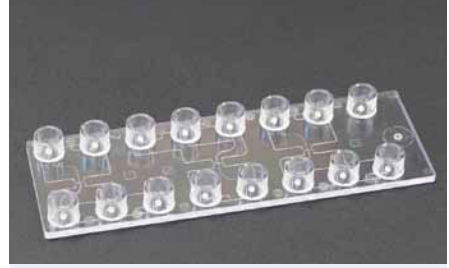

Fig. 198: Droplet generator chip Fluidic 536

Product Code for Fluidic 536	Lid Thickness [μm]	Material	Price [€/chip]		
			1+	10+	100+
10000433	140	Topas	42.20	34.40	26.10
10000509	175	PC	42.20	34.40	26.10

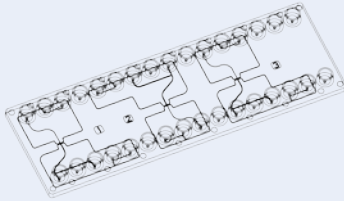

Fig. 199: Schematic drawing of droplet in droplet generator chip Fluidic 1032 with Mini Luer interfaces

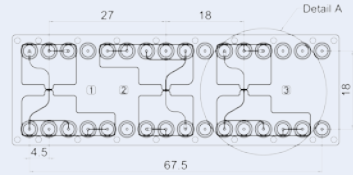

Fig. 200: Detailed schematic drawing droplet generator chip Fluidic 1032 – channel dimension

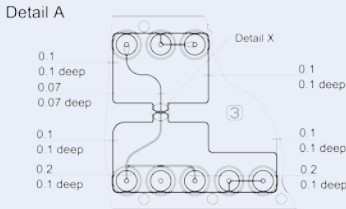

Fig. 201: Droplet in droplet generator chip Fluidic 1032 – channel dimension

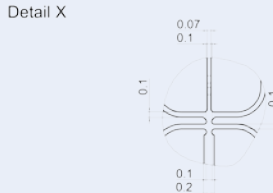

Fig. 202: Droplet in droplet generator chip Fluidic 1032 – detail channel intersection element

Product Code for Fluidic 1032	Lid Thickness [μm]	Material	Price [€/chip]		
			1+	10+	100+
10001334	140	Topas	42.20	34.40	26.10
10001335	175	PC	42.20	34.40	26.10



### 3.12.2.3 Droplet generator chips – Multi channel designs – Various design options

With this multichannel design several design options to generate droplets with different volumes are implemented. Main channel as well as entrance channel vary in diameter enabling a large set of experiments. Fluidic 285 features Mini Luer interfaces.

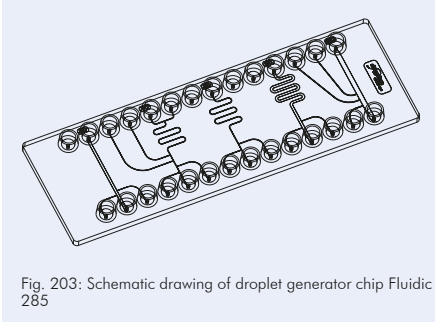

Fig. 203: Schematic drawing of droplet generator chip Fluidic 285

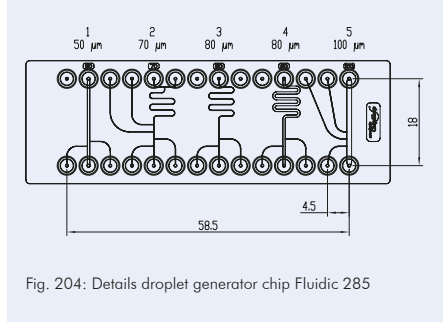

Fig. 204: Details droplet generator chip Fluidic 285

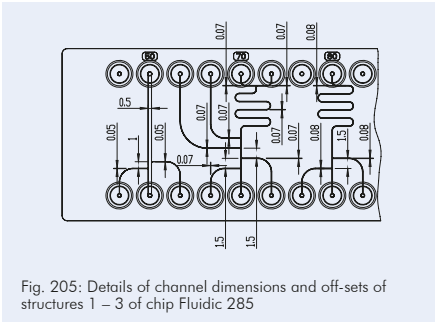

Fig. 205: Details of channel dimensions and off-sets of structures 1 – 3 of chip Fluidic 285

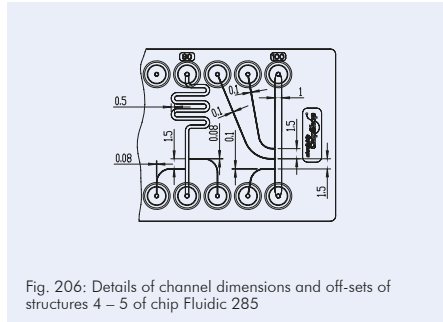

Fig. 206: Details of channel dimensions and off-sets of structures 4 – 5 of chip Fluidic 285

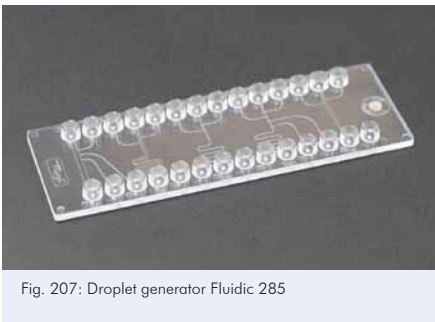

Fig. 207: Droplet generator Fluidic 285

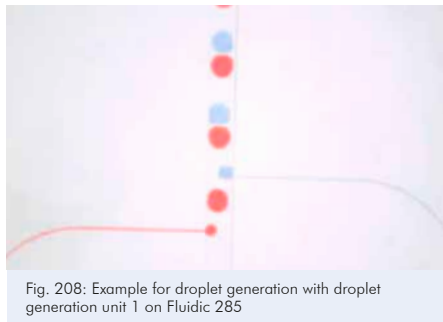

Fig. 208: Example for droplet generation with droplet generation unit 1 on Fluidic 285

Product Code for Fluidic 285	Lid Thickness [μm]	Material	Price [€/chip]		
			1+	10+	100+
10000175	140	Topas	42.20	34.30	26.10
10000176	175	PC	42.20	34.30	26.10

#### 3.12.2.4 Droplet generator chips – Multi channel design – Droplet size variation

These droplet generator designs combine size variations of one main design for the evaluation of generated droplet size under the desired conditions.

For this purpose, we offer two droplet generator chips with similar design to evaluate droplet sizes. Each chip features eight individual droplet generator units and Mini Luer interfaces. Fluidic 440 is designed to generate larger droplets with channel dimensions at the droplet formation region of 80  $\mu\text{m}$ , 70  $\mu\text{m}$ , 60  $\mu\text{m}$  and 50  $\mu\text{m}$  channel width and height. In contrast, Fluidic 947 generates smaller droplets with channel dimensions at the droplet formation region of 30  $\mu\text{m}$ , 20  $\mu\text{m}$ , 15  $\mu\text{m}$  and 10  $\mu\text{m}$  channel width and height. Each size version comes with two different outlet channel widths.

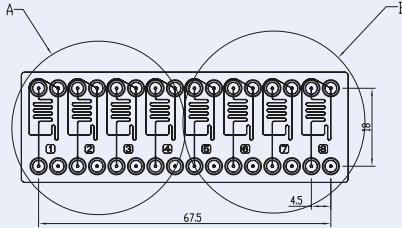
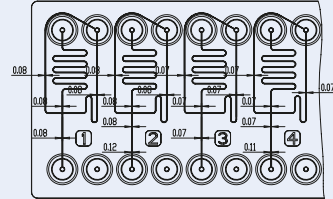
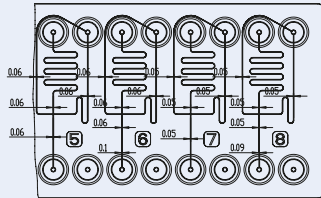

Fig. 209: Droplet generator Fluidic 440 – droplet size variation



Detail A

Fig. 210: Droplet generator – droplet size variation – details structures 1 - 4



Detail B

Fig. 211: Droplet generator – droplet size variation – details structures 5 - 8

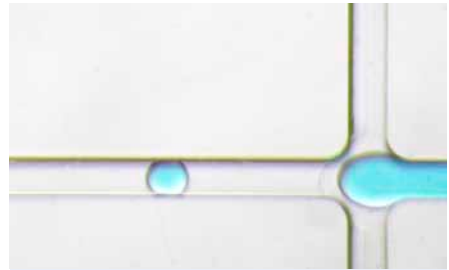

Fig. 212: Droplet generation at single channel crossing of Fluidic 440

Product Code for Fluidic 440	Lid Thickness [ $\mu\text{m}$ ]	Material	Price [€/chip]		
			1+	10+	100+
10000040	140	Topas	42.20	34.40	26.10
10000174	175	PC	42.20	34.40	26.10

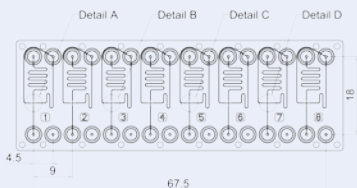

Fig. 213: Droplet generator Fluidic 947 – droplet size variation

Detail A

Detail Z



Detail Z

Fig. 214: Droplet generator Fluidic 947 – droplet size variation – details structures 1 and 2

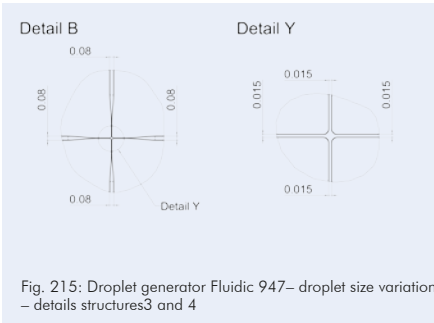

Fig. 215: Droplet generator Fluidic 947– droplet size variation – details structures 3 and 4

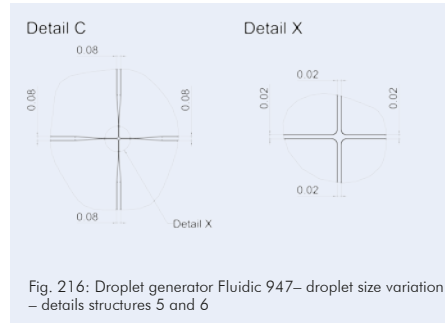

Fig. 216: Droplet generator Fluidic 947– droplet size variation – details structures 5 and 6

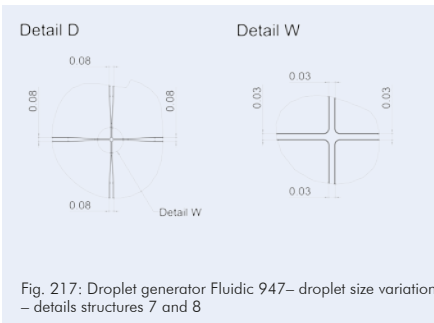

Fig. 217: Droplet generator Fluidic 947– droplet size variation – details structures 7 and 8



Fig. 218: Droplet generator – Similar chip layout for both Fluidic 440 and Fluidic 947

Product Code for Fluidic 947	Lid Thickness [μm]	Material	Price [€/chip]		
			1+	10+	100+
10001336	140	Topas	42.20	34.40	26.10
10001337	175	PC	42.20	34.40	26.10

### 3.12.3 Droplet generation and storage chips

These droplet generation chips combine the generation of the droplets with the storage and capture of single droplets for optical analysis.

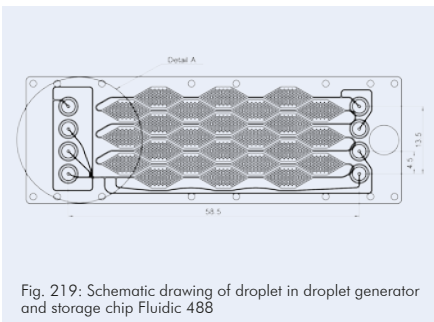

Fig. 219: Schematic drawing of droplet in droplet generator and storage chip Fluidic 488

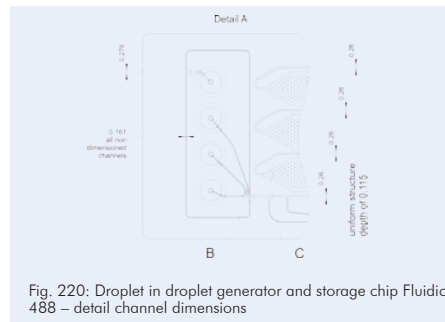
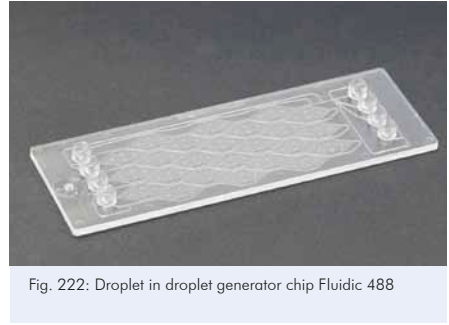
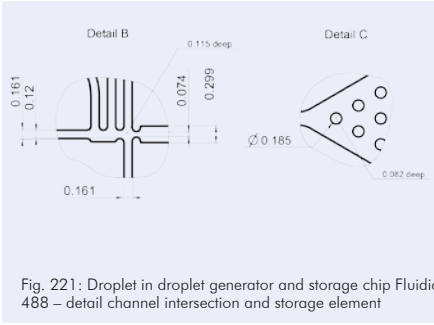
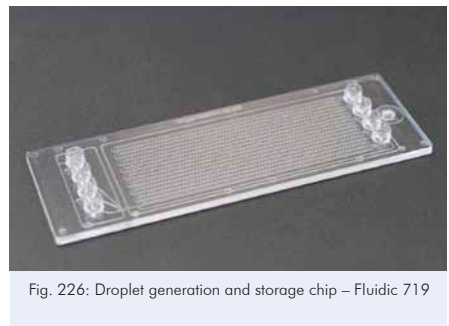
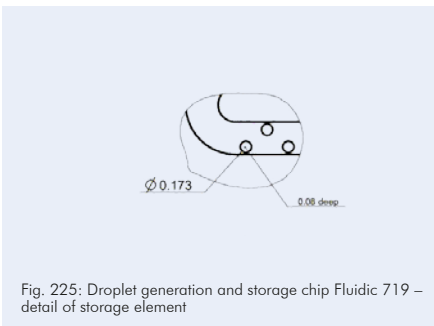
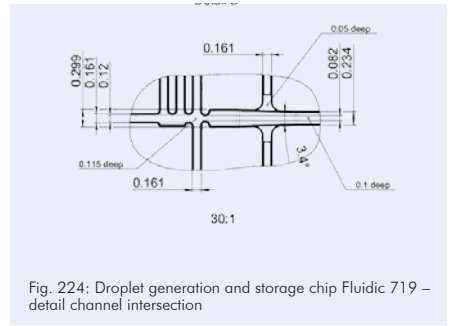
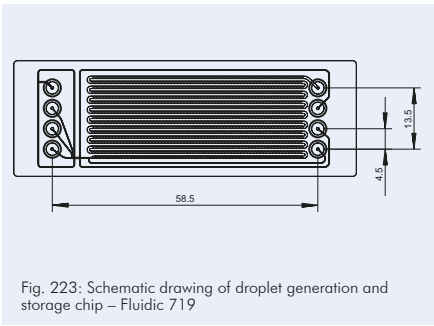

Fig. 220: Droplet in droplet generator and storage chip Fluidic 488 – detail channel dimensions



Product Code for Fluidic 488	Lid Thickness [ $\mu\text{m}$ ]	Material	Price [€/chip]		
			1+	10+	100+
10000510	140	Topas	42.20	34.40	26.10
10000511	175	PC	42.20	34.40	26.10



Product Code for Fluidic 719	Lid Thickness [ $\mu\text{m}$ ]	Material	Price [€/chip]		
			1+	10+	100+
10000751	140	Topas	42.20	34.40	26.10
10000752	175	PC	42.20	34.40	26.10





### 3.13 Meander and continuous-flow PCR chips

On the format of a microscopy slide (75.5 mm x 25.5 mm x 1.5 mm), long meandering channels are implemented. As interfaces, olives are used to directly connect tubing. If more than two interfaces are required, 28 interfaces are part of the platform.

For the basic principle of continuous-flow PCR please refer to Kopp M.U., et al., Chemical amplification: continuous-flow PCR on a chip, *Science*, Vol 288(5366), pp. 1046-8, 1998.

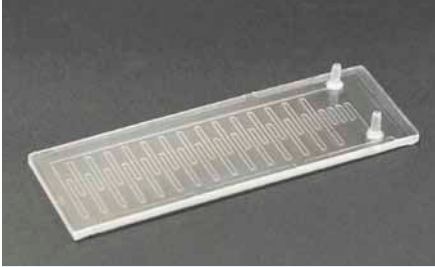

Fig. 227: 15-cycle chip Fluidic 47



Fig. 228: 41-cycle chip Fluidic 708

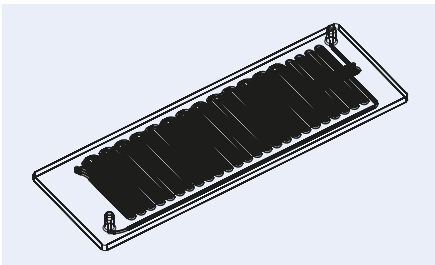

Fig. 229: Schematic drawing of 40 cycle continuous-flow PCR chip Fluidic 243

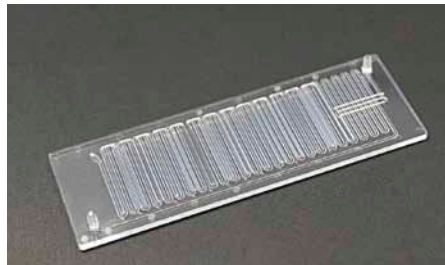

Fig. 230: 40 cycle continuous-flow PCR chip Fluidic 243

Product Code	Fluidic	Lid Thickness [μm]	Material	Comments Design Channel Dimensions Width / Depth / Length	Price [€/chip]			
					1+	10+	100+	1000+
10000008	47	175	PC	15 cycles (1 inlet, 1 outlet) 500 μm / 100 μm / 810 mm	42.50	32.50	25.50	12.00
10000007	65	175	PC	36 cycles (2 inlets, 3 outlets) 220 μm / 100 μm / 1,257 mm	42.50	32.50	25.50	12.00
10000753	708	125	Topas	41 cycles (1 inlet, 1 outlet) 200 μm / 100 μm / 1,879 mm	42.50	32.50	25.50	12.00
10000745	708	175	PC	41 cycles (1 inlet, 1 outlet) 200 μm / 100 μm / 1,879 mm	42.50	32.50	25.50	12.00
10000010	243	175	PC	40 cycles (1 inlet, 1 outlet) 600 μm / 300 μm / 1,637 mm	42.50	32.50	25.50	12.00
10000011	243	188	Zeonor	40 cycles (1 inlet, 1 outlet) 600 μm / 300 μm / 1,637 mm	42.50	32.50	25.50	12.00



#### 3.14 Sample preparation chips

Complex samples such as e.g. blood often require purification steps prior to further analysis. In this regard, one prominent procedure is sample preparation with the help of membranes, which can facilitate purification and filtration.

##### 3.14.1 Filtration chip

The filtration chip is based on the cross-flow membrane principle, i.e. two in- and outlet ports are located above and below a permeable membrane. In- and outlets offer interfaces with both Luer and Mini Luer. The filtration chip is provided with a standard membrane. However, upon request the platform can be equipped with customer-specific membranes. Please contact us for feasibility and pricing.

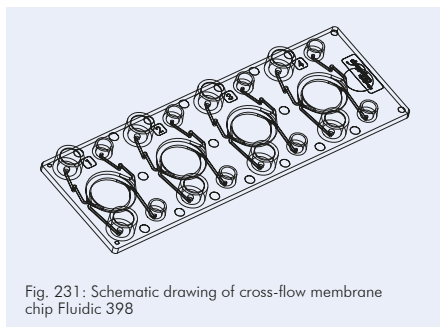

Fig. 231: Schematic drawing of cross-flow membrane chip Fluidic 398

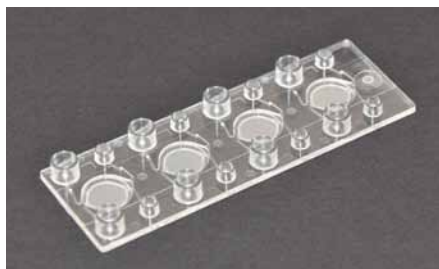

Fig. 232: Cross-flow membrane chip Fluidic 398

Product Code for Fluidic 398	Description	Pore size [μm]	Lid Thickness [μm]	Material	Price [€/chip]		
					1+	10+	100+
10000022	Filtration chip	0.4	140	Topas	79.50	63.50	42.50

##### 3.14.2 Plasma/serum generation chips

The plasma/serum generation chip family was specifically developed to generate plasma/serum from whole blood.

While this application is rather prominent, these chips can be used for various other filtering applications by exchanging the membrane material and using various pore sizes. A range of different membranes is available at *microfluidic ChipShop* and can be integrated on request. Please contact our team at [sales@microfluidic-ChipShop.com](mailto:sales@microfluidic-ChipShop.com) with your requirements.

For plasma generation chips with 10 mm diameter membranes, each membrane can generate roughly 12 – 15 μl plasma/serum out of 25 μl full blood. Each unit of these chips consists of a (Mini) Luer interface (1) for blood loading, a support channel with a cross-section of 300 μm × 100 μm (2) for the transfer of the blood on top of a separation membrane (3) that is fused into a chip-based chamber of 10 mm diameter, a plasma/serum collection channel (4) below the membrane, and a ventilation channel of 100 μm × 100 μm (5) also below the membrane. The vacuum is applied via the collection channel and a second interface (6) to the outer world. A third interface (7), which is closed during the sample loading, helps to smoothly release the slight vacuum if the membrane pores are blocked by the solid components of the blood such as erythrocytes, monocytes, platelets, or leucocytes. The chips are offered without (membrane chip 168) and with an additional venting line (membrane chip 200) to allow for an easier filling of the membrane chamber itself.

Due to a massively enlarged footprint of the membrane, the membrane chip Fluidic 535 allows for the generation of larger volumes of plasma/serum. Depending on the blood sample achievable serum/plasma volumes range from 20 μl to 35 μl. Fluidic 783 combines both a rhombic membrane and a round membrane each with a 5 μl chamber.

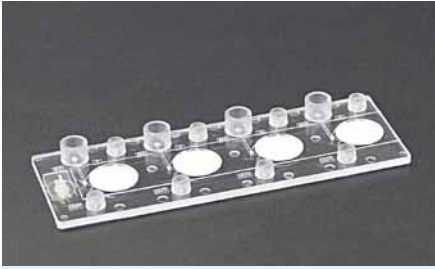

Fig. 233: Plasma/serum generation chip Fluidic 168 equipped with plasma generation membranes



Fig. 234: Close-up of one plasma/serum generation unit. The individual components are explained in the above text.

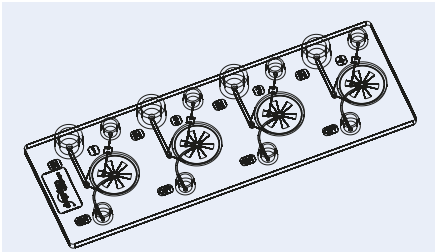

Fig. 235: Schematic drawing of membrane chip Fluidic 168

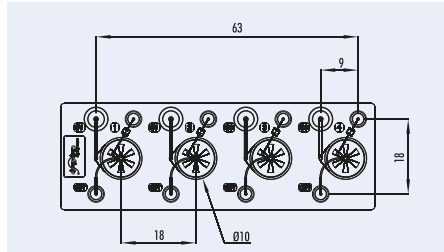

Fig. 236: Detail of membrane chip Fluidic 168

Product Code for Fluidic 168	Description	Membrane diameter [mm]	Surface Treatment	Material	Price [€/chip]		
					1+	10+	100+
10000242	Chip with 4 membranes	10	-	Topas	79.50	63.50	42.50
10000789	Chip with 4 membranes	10	hydrophilized	Topas	89.50	69.40	47.10

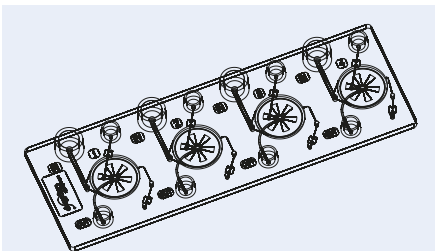

Fig. 237: Schematic drawing of membrane chip Fluidic 200

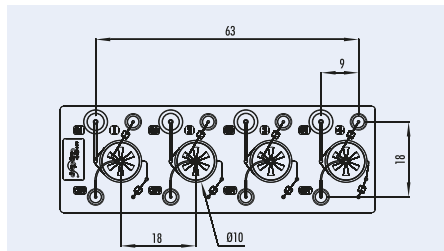

Fig. 238: Detail of membrane chip Fluidic 200

Product Code for Fluidic 200	Description	Membrane diameter [mm]	Surface Treatment	Material	Price [€/chip]		
					1+	10+	100+
10000021	Chip with 4 membranes	10	-	Topas	79.50	63.50	42.50
10000757	Chip with 4 membranes	10	-	PS	79.50	63.50	42.50
10000756	Chip with 4 membranes	10	hydrophilized	Topas	89.50	69.40	47.10
10000758	Chip with 4 membranes	10	hydrophilized	PS	89.50	69.40	47.10



### 3 Microfluidic chips – Polymers

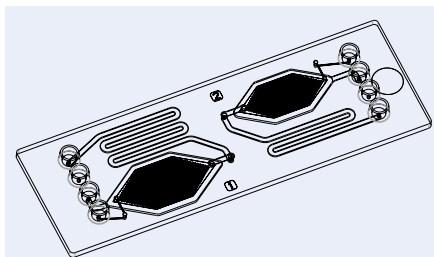

Fig. 239: Schematic drawing of membrane chip Fluidic 535 with Mini Luer interfaces



Fig. 240: Membrane chip Fluidic 535

Product Code for Fluidic 535	Description	Lid Thickness [ $\mu\text{m}$ ]	Material	Surface Treatment	Price [€/chip]		
					1+	10+	100+
10000439	Plasma generation chip with two membranes	140	Topas	-	79.50	63.50	42.50
10000440	Plasma generation chip with two membranes	125	PS	-	79.50	63.50	42.50
10000442	Plasma generation chip with two membranes	140	Topas	hydrophilized	89.50	69.40	47.10
10000441	Plasma generation chip with two membranes	125	PS	hydrophilized	89.50	69.40	47.10

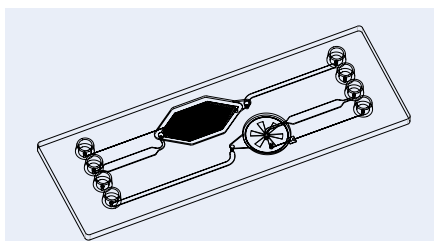

Fig. 241: Schematic drawing of membrane chip Fluidic 783 with Mini Luer interfaces

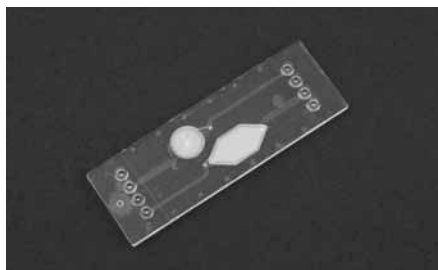

Fig. 242: Membrane chip Fluidic 783 with two separate plasma generation units - one round and one rhombic

Product Code for Fluidic 783	Description	Lid Thickness [ $\mu\text{m}$ ]	Material	Surface Treatment	Price [€/chip]		
					1+	10+	100+
10000981	Plasma generation chip with two membranes	140	Topas	-	79.50	63.50	42.50
10000982	Plasma generation chip with two membranes	125	PS	-	79.50	63.50	42.50
10000983	Plasma generation chip with two membranes	140	Topas	hydrophilized	89.50	69.40	47.10
10000984	Plasma generation chip with two membranes	125	PS	hydrophilized	89.50	69.40	47.10



### 3.14.3 Plasma/serum generation chip for on-chip analysis

This chip contains our classic plasma generation membrane with large footprint. However, somewhat special, Fluidic 973 has been tailored for on-chip analysis with a pre- and post-membrane chamber enabling i.e. optical readouts. The chip is filled via its Luer interface, while a venting membrane prevents generated plasma from exiting the chip. Please note that generated plasma is retained in this chip, hence it is not suitable for off-chip downstream experiments.

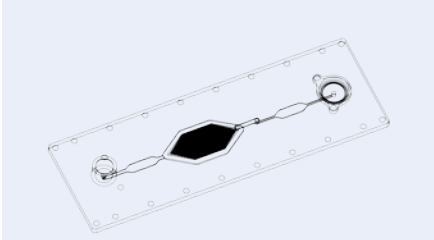

Fig. 243: Schematic drawing of on-chip analysis plasma generation chip Fluidic 973

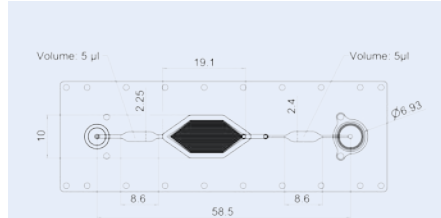

Fig. 244 Detailed schematic drawing of on-chip analysis plasma generation chip Fluidic 973

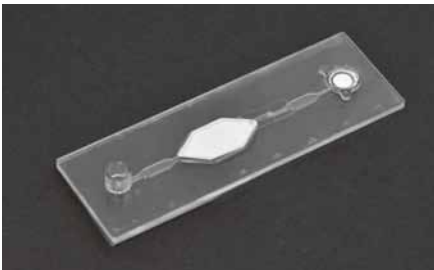

Fig. 245: On-chip analysis plasma generation chip Fluidic 973

Product Code for Fluidic 973	Description	Lid Thickness [ $\mu\text{m}$ ]	Material	Surface Treatment	Price [€/chip]		
					1+	10+	100+
10001338	On-chip analysis plasma generation chip	140	Topas	-	69.20	44.40	39.80



#### 3.14.4 Open membrane chip

The open chips have been designed to allow direct access to membrane areas and provide a permanent entry port for liquid supply, storage and exchange. In combination with *microfluidic ChipShop's* matching Interaction Tanks like Fluidic 234 and 235 for liquid supply and storage this chip allows for a wide variety of filtering and assay tasks.

Interaction tank Fluidic 235 is equipped with a cap that includes Mini Luer fluidic interfaces to be easily connected to pumps for permanent operation. For more information on our tanks please refer to the accessories chapter.

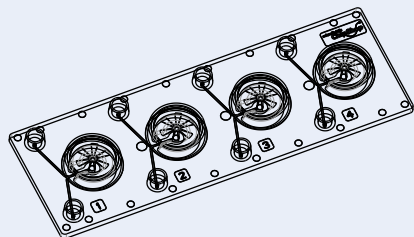

Fig. 246: Schematic drawing of transwell membrane chip Fluidic 219



Fig. 247: Transwell membrane chip Fluidic 219 with tank Fluidic 234 as fluid reservoir

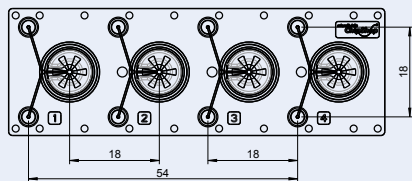

Fig. 248: Detail of transwell membrane chip Fluidic 219



Fig. 249: Transwell membrane chip Fluidic 219 with tank Fluidic 235 as fluid reservoir

Product Code for Fluidic 219	Description	Material	Surface Treatment	Price [€/chip]		
				1+	10+	100+
10001069	Open membrane chip Fluidic 219, 8 μm pore size membrane	Topas	-	79.50	63.50	42.50
10001070	Open membrane chip Fluidic 219, 8 μm pore size membrane	PS	-	79.50	63.50	42.50
10001071	Open membrane chip Fluidic 219, 8 μm pore size membrane	Topas	hydrophilized	89.50	69.40	47.10
10001072	Open membrane chip Fluidic 219, 8 μm pore size membrane	PS	hydrophilized	89.50	69.40	47.10



### 3.15 Cell culture chips

The introduction of microfluidic settings in cell culture experiments shall aid mimicking physiological conditions *in vitro*. The complexity of microfluidic cell cultures can thereby vary greatly. For simpler culture setting, in which cells reside within one culture chamber, many of our chamber chips, like Fluidic 584 or 585 are suitable options.

The chips presented in the following have been developed to meet more complex cell culture requirements. Our cross-flow membrane chips allow for the co-culture of various cell types within two separate culture compartments, divided by a permeable membrane.

With the interaction chip family cell-cell-interaction, of cells cultured in separate culture compartments, can be monitored.

**Surface treatment:** For adherend cell culture we recommend the use of hydrophilized chips to aid cell attachment to the culture surface. Furthermore, like any standard cell culture vessels, microfluidic chips can optionally be coated with extracellular matrix proteins to satisfy cell-specific attachment needs.

**On-chip sensing:** We are able to provide you with tailored integrated sensing options (e.g. oxygen sensing) for your microfluidic chip. Please contact us for further information.

#### 3.15.1 Cross-flow membrane chips

The cross-flow membrane chips have two in- and outlet ports above and below the membrane. Cell culture is just one potential application area of those versatile chips. The design also allows for experiments such as small molecule transfer measurements, on-chip dialysis and many more. Cross-flow membrane chips are available with different membranes, featuring distinct pore sizes. Upon request, the platforms can also be equipped with customer-specific membranes. Please contact us for feasibility and pricing.

Below an overview of critical culture vessel characteristics for our cross-flow membrane chips are given. These will help to set up defined experimental key criteria like cell seeding densities or alike.

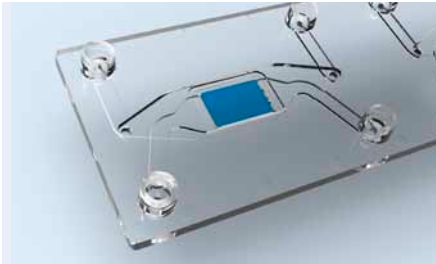

Fig. 250: Interaction area of a cross-flow membrane chip for cell culture applications

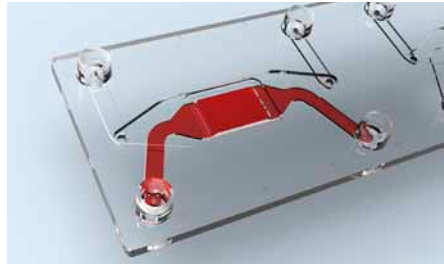

Fig. 251: Bottom chamber of cross-flow membrane chip Fluidic 480

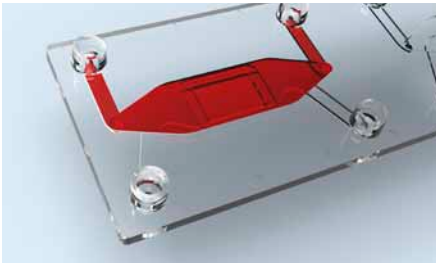

Fig. 252: Upper chamber of cross-flow membrane chip Fluidic 480

Fluidic Design	Interface Type	Available membrane pore sizes [ $\mu\text{m}$ ]	Interaction area [ $\text{mm}^2$ ]	Upper chamber			Bottom chamber		
				Volume [ $\mu\text{l}$ ]	Total Surface [ $\text{mm}^2$ ]	Ground Surface [ $\text{mm}^2$ ]	Volume [ $\mu\text{l}$ ]	Total Surface [ $\text{mm}^2$ ]	Ground Surface [ $\text{mm}^2$ ]
480	Mini Luer	0.2; 8	36.0	87.5	440.0	154.0	61.5	271.0	118.0
568	Mini Luer + Luer	8	40.6	105.8	605.0	151.0	64.0	281.0	120.0
653	Mini Luer	3; 8	71.5	145.0	595.0	223.5	101.8	419.0	185.0
694	Mini Luer	3; 8	71.5	137.8	573.5	220.0	79.5	340.7	140.0
747	Mini Luer	8	71.5	281.4	1138.0	456.0	101.8	419.0	185.0
846	Mini Luer	8	395.5	500.0	1795.5	803.0	402.8	1818.7	674.7

Our cell culture chips are proven tools for your successful microfluidic cell culture experiment. Please refer to the following publications for application examples:

1. Maurer M., et al., A three-dimensional immunocompetent intestine-on-chip model as in vitro platform for functional and microbial interaction studies, *Biomaterials*, doi: 10.1016/j.biomaterials.2019.119396, 2019
2. Pein H., et al., Endogenous metabolites of vitamin E limit inflammation by targeting 5-lipoxygenase, *Nat Commun.*,9(1):3834. doi: 10.1038/s41467-018-06158-5, 2018
3. Raasch M., et al., An integrative microfluidically supported in vitro model of an endothelial barrier combined with cortical spheroids simulates effects of neuroinflammation in neocortex development, *Biomicrofluidics*,10(4):044102. doi: 10.1063/1.4955184, 2016
4. Rennert K., et al., A microfluidically perfused three dimensional human liver model, *Biomaterials*, 119-131, doi: 10.1016/j.biomaterials.2015.08.043, 2015

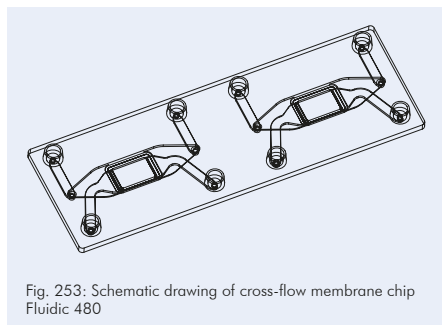

Fig. 253: Schematic drawing of cross-flow membrane chip Fluidic 480

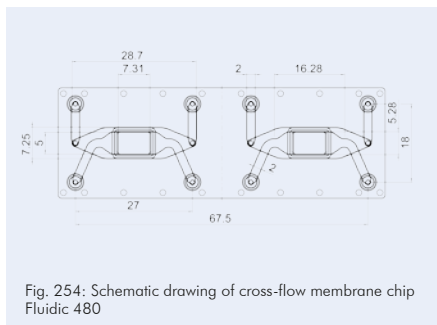

Fig. 254: Schematic drawing of cross-flow membrane chip Fluidic 480

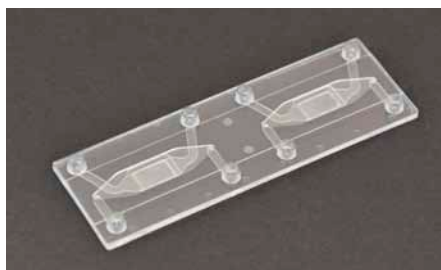

Fig. 255: Cross-flow membrane chip Fluidic 480





Product Code for Fluidic 480	Description	Pore size [μm]	Lid Thickness [μm]	Material	Surface Treatment	Price [€/chip]		
						1+	10+	100+
10000284	Cross-flow membrane chip	8	140	Topas	-	79.50	63.50	42.50
10000496	Cross-flow membrane chip	8	125	PS	-	79.50	63.50	42.50
10000737	Cross-flow membrane chip	0.2	140	Topas	-	79.50	63.50	42.50
10000738	Cross-flow membrane chip	0.2	125	PS	-	79.50	63.50	42.50
10000497	Cross-flow membrane chip	8	140	Topas	hydrophilized	89.50	69.40	47.10
10000498	Cross-flow membrane chip	8	125	PS	hydrophilized	89.50	69.40	47.10
10000739	Cross-flow membrane chip	0.2	140	Topas	hydrophilized	89.50	69.40	47.10
10000770	Cross-flow membrane chip	0.2	125	PS	hydrophilized	89.50	69.40	47.10

The cross-flow membrane chip Fluidic 568 with Luer and Mini Luer interfaces gives the option to connect a fluidic reservoir to the Luer interface.

For instance, the special Pipette-Chip-Bridge can be used to combine sample uptake with a standard pipette and sample release via Luer interfaces of the chip. The Pipette-Chip-Bridge can be found in the accessories chapter.

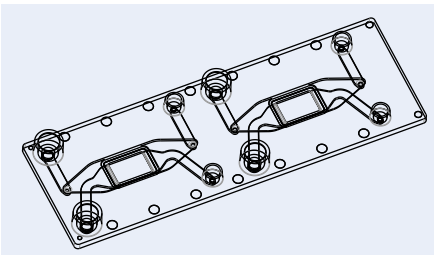

Fig. 256: Cross-flow membrane chip Fluidic 568

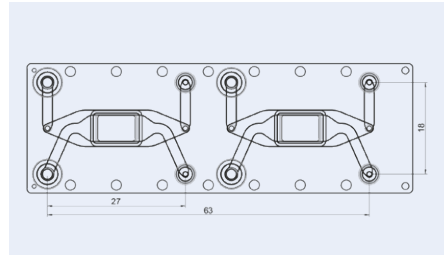

Fig. 257: Cross-flow membrane chip Fluidic 568

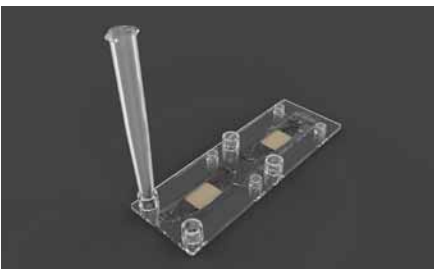

Fig. 258: Pipette-Chip-Bridge (Fluidic 569) mounted on Luer interface of the cross-flow membrane chip Fluidic 568

Product Code for Fluidic 568	Description	Pore size [μm]	Lid Thickness [μm]	Material	Surface Treatment	Price [€/chip]		
						1+	10+	100+
10001200	Cross-flow membrane chip	8	140	Topas	-	79.50	63.50	42.50
10001202	Cross-flow membrane chip	8	125	PS	-	79.50	63.50	42.50
10001201	Cross-flow membrane chip	8	140	Topas	hydrophilized	89.50	69.40	47.10
10001203	Cross-flow membrane chip	8	125	PS	hydrophilized	89.50	69.40	47.10

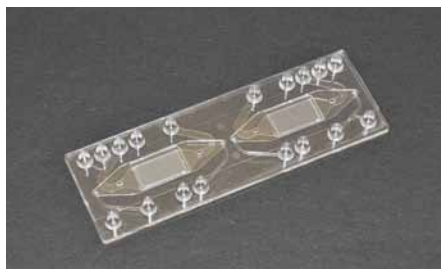

Fig. 259: Cross-Flow membrane chip Fluidic 653 with additional in- and outlet channels

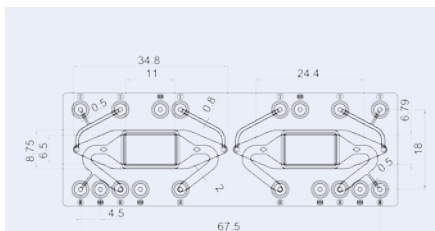

Fig. 260: Schematic drawing of Cross-Flow membrane chip Fluidic 653 with additional in- and outlet channels



Fig. 261: Cross-Flow membrane chip Fluidic 653 with integrated oxygen sensor spots

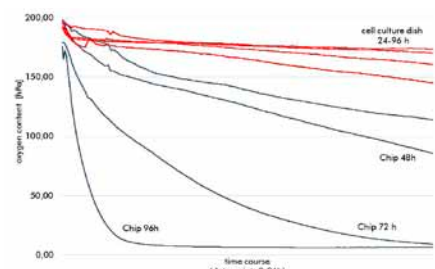

Fig. 262: Comparison of oxygen consumption in a cell culture dish vs microfluidic chip measured with integrated oxygen sensor spots. The curves show the oxygen concentration over 24 h intervals.

Product Code for Fluidic 653	Description	Pore size [µm]	Lid Thickness [µm]	Material	Surface Treatment	Price [€/chip]		
						1+	10+	100+
10000920	Cross-flow membrane chip	8	140	Topas	-	79.50	63.50	42.50
10000799	Cross-flow membrane chip	8	125	PS	-	79.50	63.50	42.50
10000921	Cross-flow membrane chip	3	140	Topas	-	79.50	63.50	42.50
10000790	Cross-flow membrane chip	3	125	PS	-	79.50	63.50	42.50
10001420	Cross-flow membrane chip, open top for membrane access	8	140	Topas	-	79.50	63.50	42.50
10001421	Cross-flow membrane chip, open top for membrane access	8	125	PS	-	79.50	63.50	42.50
10000922	Cross-flow membrane chip	8	140	Topas	hydrophilized	89.50	69.40	47.10
10000917	Cross-flow membrane chip	8	125	PS	hydrophilized	89.50	69.40	47.10
10000923	Cross-flow membrane chip	3	140	Topas	hydrophilized	89.50	69.40	47.10
10000918	Cross-flow membrane chip	3	125	PS	hydrophilized	89.50	69.40	47.10
10000924	Cross-flow membrane chip, open top for membrane access	8	140	Topas	hydrophilized	89.50	69.40	47.10
10000832	Cross-flow membrane chip, open top for membrane access	8	125	PS	hydrophilized	89.50	69.40	47.10

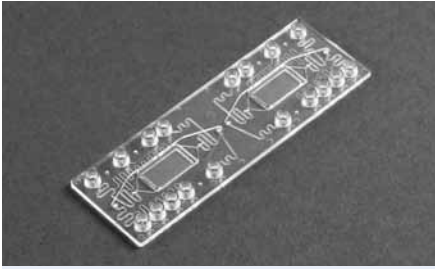

Fig. 263: Cross-Flow membrane chip Fluidic 694 with additional in- and outlet channels

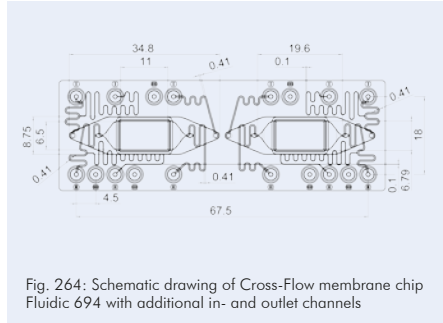

Fig. 264: Schematic drawing of Cross-Flow membrane chip Fluidic 694 with additional in- and outlet channels

Product Code for Fluidic 694	Description	Pore size [ $\mu\text{m}$ ]	Lid Thickness [ $\mu\text{m}$ ]	Material	Surface Treatment	Price [€/chip]		
						1+	10+	100+
10000910	Cross-flow membrane chip	8	188	Zeonor	-	79.50	63.50	42.50
10000911	Cross-flow membrane chip	8	125	PS	-	79.50	63.50	42.50
10000913	Cross-flow membrane chip	3	188	Zeonor	-	79.50	63.50	42.50
10000915	Cross-flow membrane chip	3	125	PS	-	79.50	63.50	42.50
10000908	Cross-flow membrane chip	8	188	Zeonor	hydrophilized	89.50	69.40	47.10
10000912	Cross-flow membrane chip	8	125	PS	hydrophilized	89.50	69.40	47.10
10000914	Cross-flow membrane chip	3	188	Zeonor	hydrophilized	89.50	69.40	47.10
10000916	Cross-flow membrane chip	3	125	PS	hydrophilized	89.50	69.40	47.10

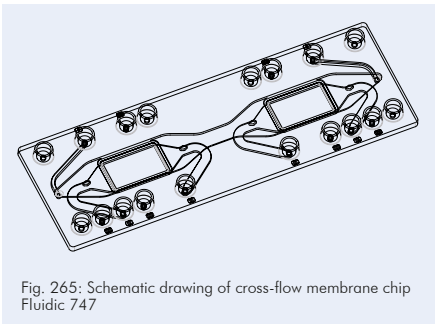

Fig. 265: Schematic drawing of cross-flow membrane chip Fluidic 747

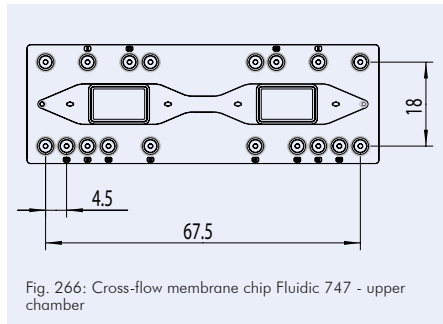

Fig. 266: Cross-flow membrane chip Fluidic 747 - upper chamber

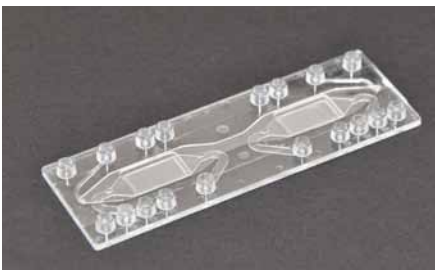

Fig. 267: Cross-flow membrane chip Fluidic 747



### 3 Microfluidic chips – Polymers

Product Code for Fluidic 747	Description	Pore size [ $\mu\text{m}$ ]	Lid Thickness [ $\mu\text{m}$ ]	Material	Surface Treatment	Price [€/chip]		
						1+	10+	100+
10001018	Cross-flow membrane chip	8	140	Topas	-	79.50	63.50	42.50
10001019	Cross-flow membrane chip	8	125	PS	-	79.50	63.50	42.50
10001020	Cross-flow membrane chip	8	140	Topas	hydrophilized	89.50	69.40	47.10
10001021	Cross-flow membrane chip	8	125	PS	hydrophilized	89.50	69.40	47.10

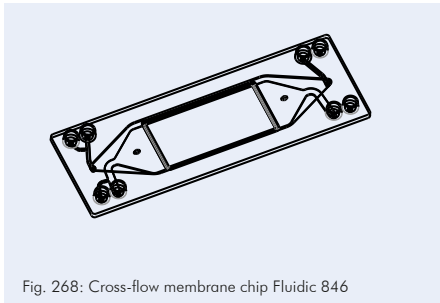

Fig. 268: Cross-flow membrane chip Fluidic 846

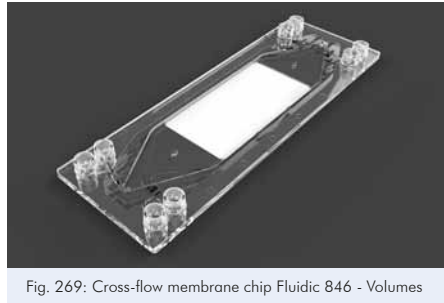

Fig. 269: Cross-flow membrane chip Fluidic 846 - Volumes

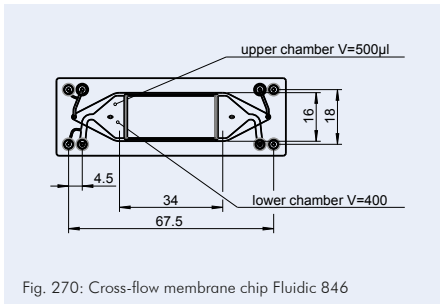

Fig. 270: Cross-flow membrane chip Fluidic 846

Product Code for Fluidic 846	Description	Pore size [ $\mu\text{m}$ ]	Lid Thickness [ $\mu\text{m}$ ]	Material	Surface Treatment	Price [€/chip]		
						1+	10+	100+
10001122	Cross-flow membrane chip	8	140	Topas	-	79.50	63.50	42.50
10001123	Cross-flow membrane chip	8	125	PS	-	79.50	63.50	42.50
10001121	Cross-flow membrane chip	8	140	Topas	hydrophilized	89.50	69.40	47.10
10001124	Cross-flow membrane chip	8	125	PS	hydrophilized	89.50	69.40	47.10



### 3.15.2 Chamber chip with pre-heating channel

While cells ought to be cultured at 37°C, cell culture medium storage temperatures are generally lower. This is why this cell culture chamber chip features an additional extended channel upstream of the cell culture area to ensure appropriate medium warm up prior to the cell culture. The chip features Mini Luer interfaces and is, like most of our cell culture chips, compatible with our Lab-on-a-Chip Cell Culture Incubator – LOC CCI 1.

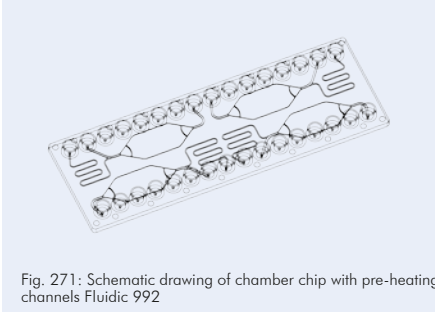

Fig. 271: Schematic drawing of chamber chip with pre-heating channels Fluidic 992

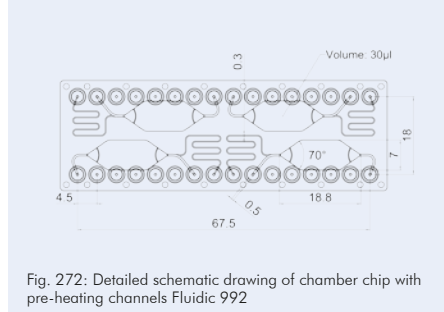

Fig. 272: Detailed schematic drawing of chamber chip with pre-heating channels Fluidic 992

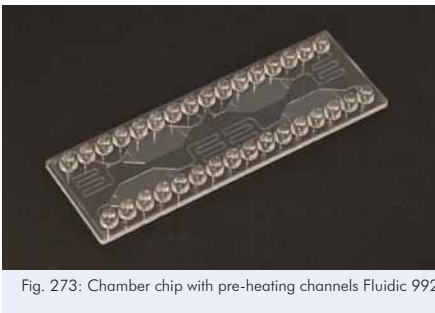

Fig. 273: Chamber chip with pre-heating channels Fluidic 992

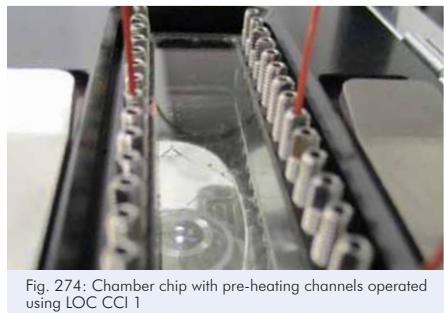

Fig. 274: Chamber chip with pre-heating channels operated using LOC CCI 1

Product Code for Fluidic 992	Chamber		Lid Thickness [µm]	Material	Surface Treatment	Price [€/chip]		
	Volume [µl]	Ground Surface [mm <sup>2</sup> ]				1+	10+	100+
10001339	30	100	140	Topas	-	36.20	24.30	16.10
10001341	30	100	125	PS	-	36.20	24.30	16.10
10001343	30	100	188	Zeonor	-	36.20	24.30	16.10
10001340	30	100	140	Topas	hydrophilized	39.20	26.30	17.80
10001342	30	100	125	PS	hydrophilized	39.20	26.30	17.80
10001344	30	100	188	Zeonor	hydrophilized	39.20	26.30	17.80



#### 3.15.3 Chamber interaction chips

The chamber interaction chips are a chip family allowing for the evaluation of the effect of migrating molecules from one compartment to another. Cell-cell-interaction can be nicely evaluated e.g. the metabolic response on different drug dosage. Various experimental settings can be implemented on these chips having different pathways and fluidic modules for molecules in the fluidic channel network.

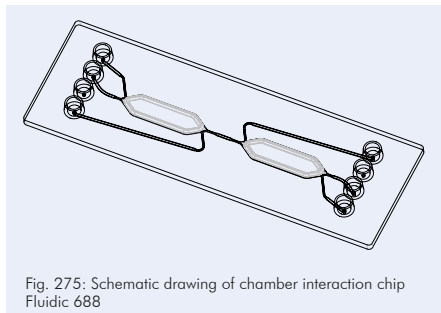

Fig. 275: Schematic drawing of chamber interaction chip Fluidic 688

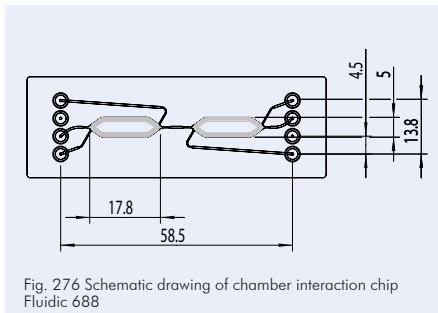

Fig. 276 Schematic drawing of chamber interaction chip Fluidic 688

Product Code for Fluidic 688	Chamber		Lid Thickness [ $\mu\text{m}$ ]	Material	Surface Treatment	Price [€/chip]		
	Volume [ $\mu\text{l}$ ]	Depth [ $\mu\text{m}$ ]				1+	10+	100+
10001055	37.8	400	140	Topas	-	36.20	24.30	16.10
10001056	37.8	400	125	PS	-	36.20	24.30	16.10
10001057	37.8	400	140	Topas	hydrophilized	39.20	26.30	17.80
10001058	37.8	400	125	PS	hydrophilized	39.20	26.30	17.80

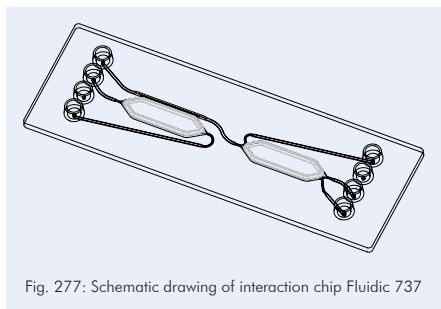

Fig. 277: Schematic drawing of interaction chip Fluidic 737

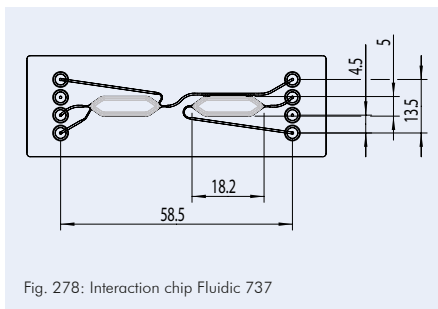

Fig. 278: Interaction chip Fluidic 737

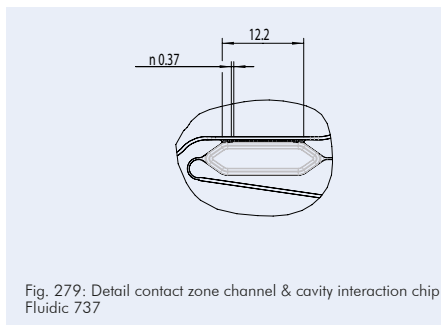

Fig. 279: Detail contact zone channel & cavity interaction chip Fluidic 737

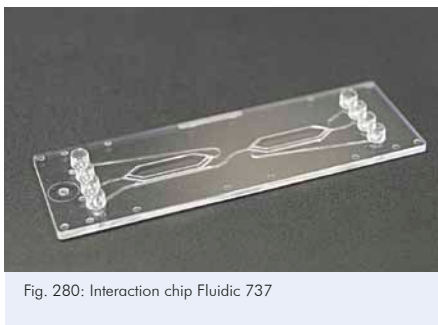

Fig. 280: Interaction chip Fluidic 737



Product Code for Fluidic 737	Chamber		Lid Thickness [μm]	Material	Surface Treatment	Price [€/chip]		
	Volume [μl]	Depth [μm]				1+	10+	100+
10001059	53.1	600	140	Topas	-	36.20	24.30	16.10
10001061	53.1	600	125	PS	-	36.20	24.30	16.10
10001284	53.1	600	188	Zeonor	-	36.20	24.30	16.10
10001060	53.1	600	140	Topas	hydrophilized	39.20	26.30	17.80
10001062	53.1	600	125	PS	hydrophilized	39.20	26.30	17.80
30001001	53.1	600	188	Zeonor	hydrophilized	39.20	26.30	17.80

### 3.15.4 Channel interaction chip

The channel interaction chip has been developed to study cells co-cultured in three adjacent channels, to each of which a microfluidic flow can be applied. The three channels are divided from each other by transmissive pillar barriers. On each channel interaction chip five independent co-culture units can be found, which differ in the width of the pillar barrier. One potential co-culture setting is the use of the two outer channels in perfusion mode, while the inner channel can be easily filled with a cell-containing gelatinous extracellular matrix, for static 3D culture conditions.

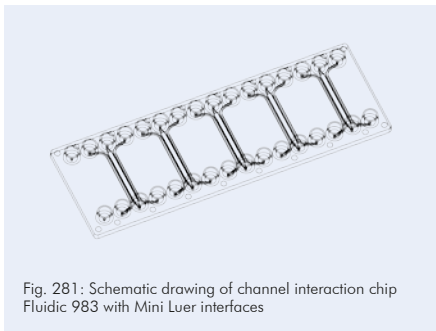

Fig. 281: Schematic drawing of channel interaction chip Fluidic 983 with Mini Luer interfaces

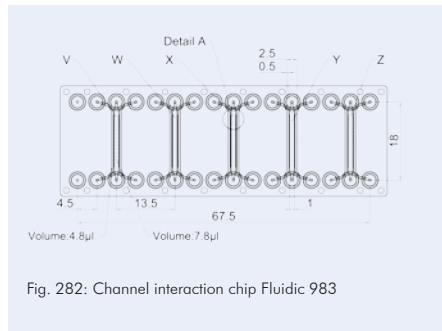

Fig. 282: Channel interaction chip Fluidic 983

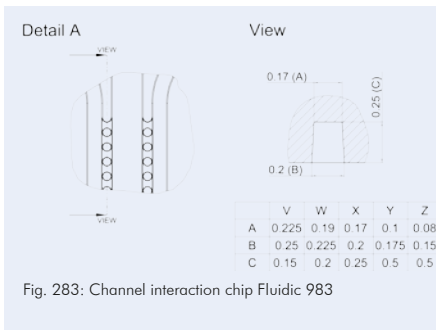

Fig. 283: Channel interaction chip Fluidic 983

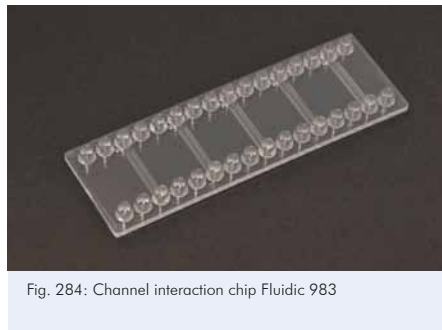

Fig. 284: Channel interaction chip Fluidic 983

Product Code for Fluidic 983	Description	Lid Thickness [ $\mu\text{m}$ ]	Material	Surface Treatment	Price [€/chip]		
					1+	10+	100+
10001345	Channel interaction chip	140	Topas	-	36.20	24.30	16.10
10001347	Channel interaction chip	125	PS	-	36.20	24.30	16.10
10001349	Channel interaction chip	188	Zeonor	-	36.20	24.30	16.10
10001346	Channel interaction chip	140	Topas	hydrophilized	39.20	26.30	17.80
10001348	Channel interaction chip	125	PS	hydrophilized	39.20	26.30	17.80
10001350	Channel interaction chip	188	Zeonor	hydrophilized	39.20	26.30	17.80

#### 3.16 Weir-filter chip

The chip contains four channels with weir structures for retaining particles (e.g. beads, cells etc.) of different sizes.

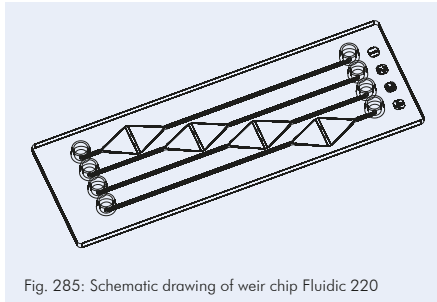

Fig. 285: Schematic drawing of weir chip Fluidic 220

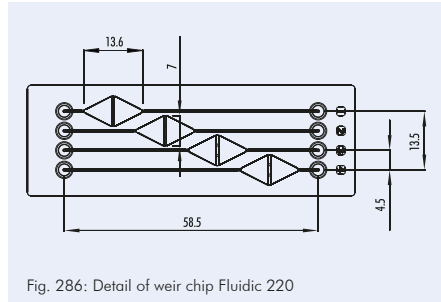

Fig. 286: Detail of weir chip Fluidic 220

Product Code for Fluidic 220	Slit width /height [mm] / [ $\mu\text{m}$ ]	Lid Thickness [ $\mu\text{m}$ ]	Channel Depth [ $\mu\text{m}$ ]	Channel Width [ $\mu\text{m}$ ]	Material	Surface Treatment	Price [€/chip]		
							1+	10+	100+
10000092	7 20 / 10 / 10 / 5	175	500	500	PC	-	42.20	34.30	26.10
10000093	7 20 / 10 / 10 / 5	188	500	500	Zeonor	-	42.20	34.30	26.10
10000499	7 20 / 10 / 10 / 5	140	500	500	Topas	-	42.20	34.30	26.10
10000502	7 20 / 10 / 10 / 5	175	500	500	PC	hydrophilized	45.20	36.30	27.80
10000501	7 20 / 10 / 10 / 5	188	500	500	Zeonor	hydrophilized	45.20	36.30	27.80
10000500	7 20 / 10 / 10 / 5	140	500	500	Topas	hydrophilized	45.20	36.30	27.80

#### 3.17 Particle & cell sorting chips

Particle and cell sorting chips enable to separate cells, analyze them and optionally sort and collect the relevant cells. This can be done with basic set-ups on a microscope stage or with complete instruments. All chips of tjos family possess Mini Luer interfaces.

All the chips shown in this chapter can be visualized on a standard microscope. Preferably fluids are introduced with syringe pumps showing extremely low pulsation.

##### 3.17.1 Particle sorting chips – Sheath flow

The particle sorting chips applying a sheath flow should be used with pulsation free syringe pumps. Velocity of the sheath flow should be significantly higher than the one of the sample stream and two streams entering through side-channels provide a sheath flow. The sorting can be done either by applying positive or negative pressure via the sampling channels at the end of the main channel. Five outlet channels with two junctions for sorting give the option to collect at two different locations target cells.



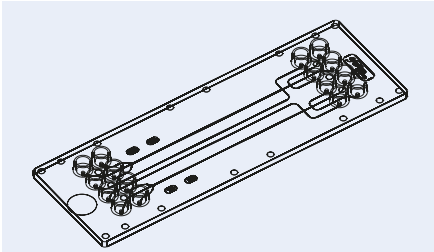

Fig. 287: Schematic drawing of cell sorting chip Fluidic 283

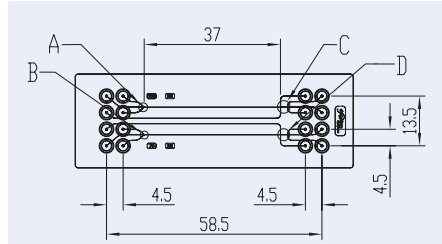

Fig. 288: Detail of cell sorting chip Fluidic 283

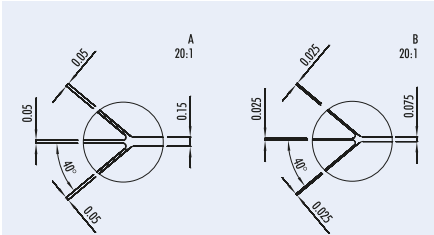

Fig. 289: Details of both entrance structures of cell sorting chip Fluidic 283

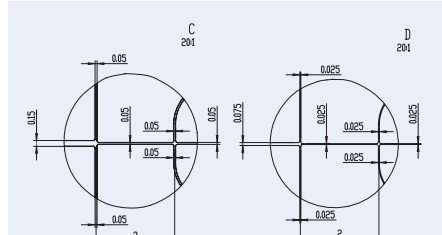

Fig. 290: Details of both outlet structures of cell sorting chip Fluidic 283

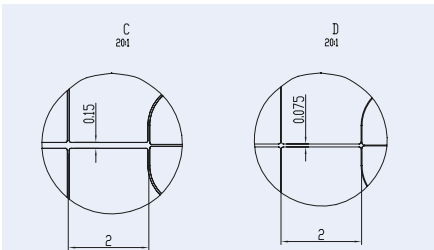

Fig. 291: Details of both outlet structures of cell sorting chip Fluidic 380 – only difference to chip Fluidic 283

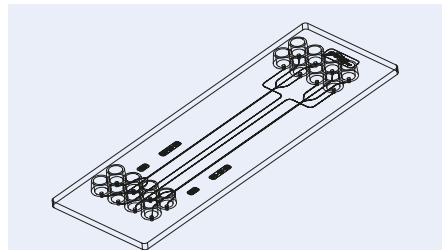

Fig. 292: Schematic drawing of cell sorting chip Fluidic 381

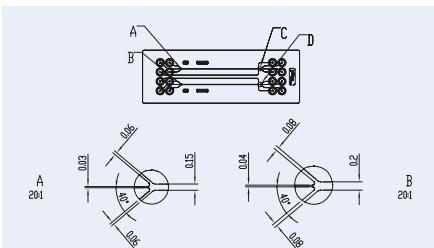

Fig. 293: Details of both inlet structures of cell sorting chip Fluidic 381

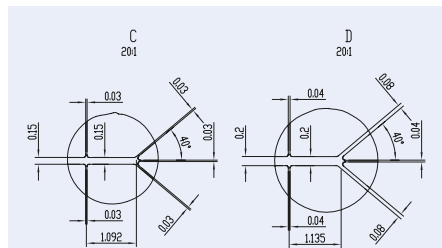

Fig. 294: Details of both outlet structures of cell sorting chip Fluidic 381 – only difference to chip Fluidic 283

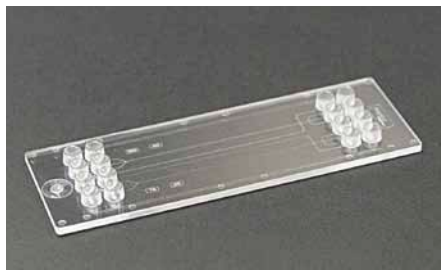

Fig. 295: Cell sorting chip Fluidic 283

Product Code	Fluidic	Channel Depth		Cover Lid Thickness [μm]	Material	Price [€/chip]		
		Structure 1 [μm]	Structure 2 [μm]			1+	10+	30+
10000123	283	50	25	175	PMMA	42.20	34.30	26.10
10000124	283	50	25	188	Zeonor	42.20	34.30	26.10
10000125	380	50	25	175	PMMA	42.20	34.30	26.10
10000126	380	50	25	188	Zeonor	42.20	34.30	26.10
10000127	381	30	30	175	PMMA	42.20	34.30	26.10
10000128	381	30	30	188	Zeonor	42.20	34.30	26.10

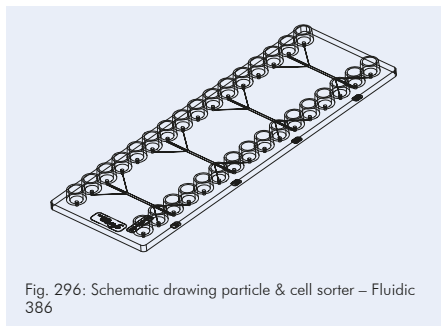

Fig. 296: Schematic drawing particle & cell sorter – Fluidic 386

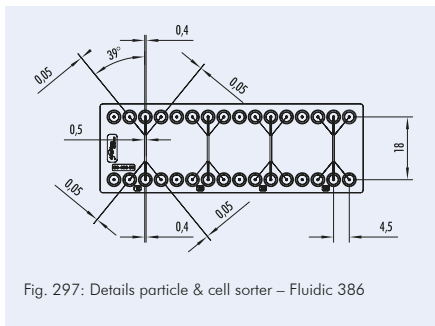

Fig. 297: Details particle & cell sorter – Fluidic 386

Product Code for Fluidic 386	Channel Depth				Lid Thickness [μm]	Material	Price [€/chip]		
	Structure 1 [μm]	Structure 2 [μm]	Structure 3 [μm]	Structure 4 [μm]			1+	10+	30+
10000157	10	20	30	50	175	PMMA	42.20	34.30	26.10
10000158	10	20	30	50	188	Zeonor	42.20	34.30	26.10

#### 3.17.2 Particle & cell sorting chips – Spiral sorter

Spirales can be used to separate particles according to their size due to the so-called Dean forces. Channel dimension, number of spirales and diameter of the curvature influence the sorting effect. The sample is introduced through a central inlet and fractions with particles of different size can be received at the different outlet ports.

The chip contains four sorting structures with the following parameters:



Structure	No. of turns	No. of outlets	Channel Width [ $\mu\text{m}$ ]	Channel Depth [ $\mu\text{m}$ ]
1	4	8	500	120
2	8	8	300	80
3	9	6	150	70
4	12	6	80	50

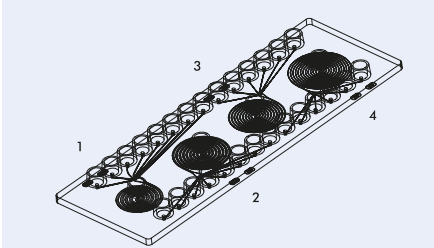

Fig. 298: Schematic drawing of the spirale sorter – Fluidic 382

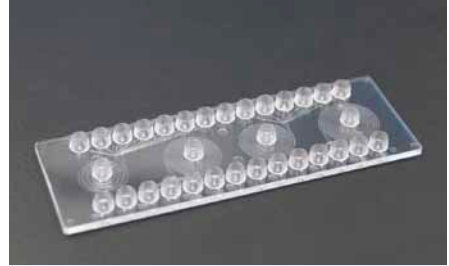

Fig. 299: Spiral sorter – Fluidic 382

Product Code for Fluidic 382	Lid Thickness [ $\mu\text{m}$ ]	Material	Price [€/chip]		
			1+	10+	100+
10000159	175	PMMA	42.20	34.30	26.10
10000160	188	Zeonor	42.20	34.30	26.10

### 3.18 Gradient chip

With the help of a branching channel network the gradient chips enable the generation of concentration gradients and their use for various kinds of experiments on chip.

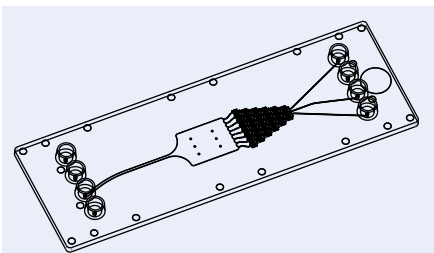

Fig. 300: Schematic drawing of gradient generator Fluidic 834 with Mini Luer Interfaces

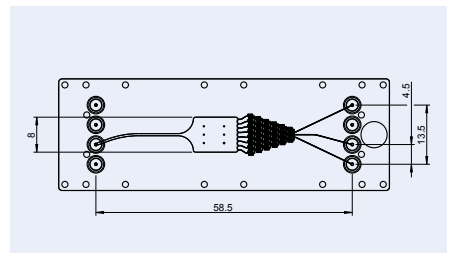

Fig. 301: Schematic drawing of gradient generator Fluidic 834

Product Code for Fluidic 834	Description	Lid Thickness [ $\mu\text{m}$ ]	Material	Surface Treatment	Price [€/chip]		
					1+	10+	100+
10001063	Gradient generator	140	Topas	-	36.20	24.30	16.10
10001064	Gradient generator	125	PS	-	36.20	24.30	16.10
10001065	Gradient generator	140	Topas	hydrophilized	39.20	26.30	17.80
10001066	Gradient generator	125	PS	hydrophilized	39.20	26.30	17.80



#### 3.19 Pillar chip

The integration of pillars serves various needs. Such structures can be used to maintain particles at a certain area, to allow for self-filling of devices via capillary forces, to increase surface area, to have a sieving effect, or to use these structures for surface functionalization with high surface area regions in a microfluidic device.

In these pillar chips the pillars have a demolding angle of  $10^\circ$ . The table indicates the smallest diameter.

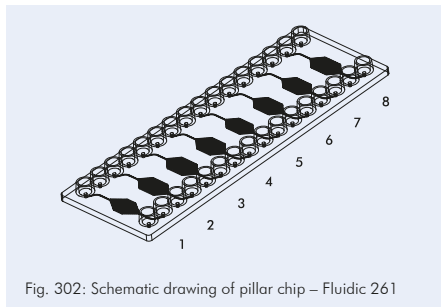

Fig. 302: Schematic drawing of pillar chip – Fluidic 261

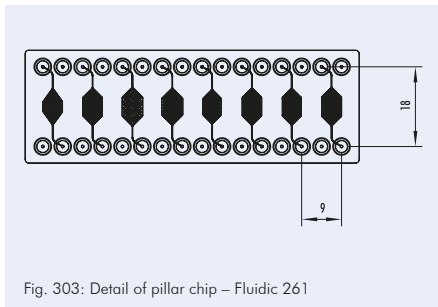

Fig. 303: Detail of pillar chip – Fluidic 261

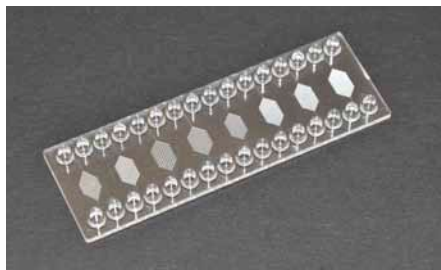

Fig. 304: Pillar chip – Fluidic 261

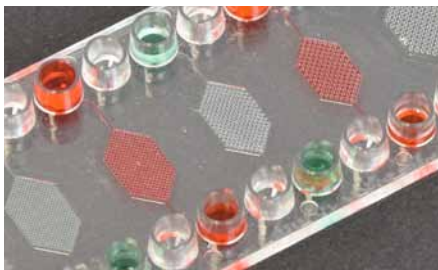

Fig. 305: Pillar chip filled – Fluidic 261

Product Code for Fluidic 261	Lid Thickness [ $\mu\text{m}$ ]	Pillar No./diameter [ $\mu\text{m}$ ]/distance [ $\mu\text{m}$ ]/depth	Material	Price [€/chip]		
				1+	10+	100+
10000100	175	1/100/350/150 2/150/400/150 3/200/500/200 4/250/600/200 5/300/700/250 6/350/800/250 7/150/500/300 8/150/500-700/300	PMMA	42.20	34.40	24.10
10000099	188	1/100/350/150 2/150/400/150 3/200/500/200 4/250/600/200 5/300/700/250 6/350/800/250 7/150/500/300 8/150/500-700/300	Zeonor	42.20	34.40	24.10



### 3.20 Field-flow fractionation chips

On the format of a microscopy slide (75.5 mm x 25.5 mm x 1.5 mm) with olives as fluidic interfaces, a field-flow fractionation structure is placed. The chips can be used for example for free-flow electrophoresis and free-flow magnetophoresis. The chips were developed within the BMBF-Project "Free-Flow-Chip", FKZ 01RI0643D.

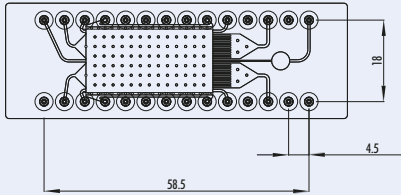

Fig. 306: Details of the field flow fractionation chip Fluidic 120

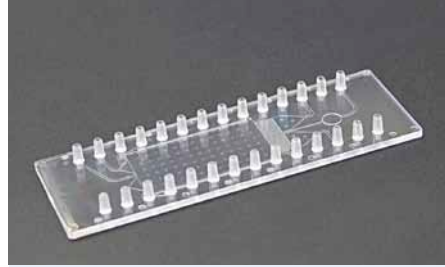

Fig. 307: Field flow fractionation chip Fluidic 120

Product Code for Fluidic 120	Lid Thickness [μm]	Material	Surface Treatment	Price [€/chip]		
				1+	10+	100+
10000333	175	PC	-	42.20	34.30	26.10
10000334	188	Zeonor	-	42.20	34.30	26.10
10000954	175	PC	hydrophilized	45.20	36.30	27.80
10000408	188	Zeonor	hydrophilized	45.20	36.30	27.80

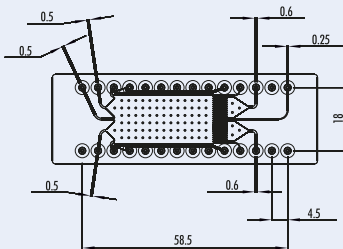

Fig. 308: Details of the field flow fractionation chip Fluidic 159



Fig. 309: Field flow fractionation chip Fluidic 159

Product Code for Fluidic 159	Lid Thickness [μm]	Material	Surface Treatment	Price [€/chip]		
				1+	10+	100+
10000270	175	PC	-	42.20	34.30	26.10
10000296	188	Zeonor	-	42.20	34.30	26.10
10000845	175	PC	hydrophilized	45.20	36.30	27.80
10000271	188	Zeonor	hydrophilized	45.20	36.30	27.80



#### 3.21 Turning valve chip

Turning valves, embedded on microfluidic chips, allow the targeted distribution of liquids and gases in channel networks, to actively open and close channels and to meter liquids. In instruments the valves are operated in an automated manner through turning the valve body in previously defined increments. For evaluation of metering on chip and in the valve body we offer a turning valve test chip. For this application, turning valves can be operated either manually with a little valve actuator, as shown below, or mechanically with *microfluidic ChipShop's* ChipGenie® edition TV. Please see page 197 chapter 10.5 for the ChipGenie® edition TV.

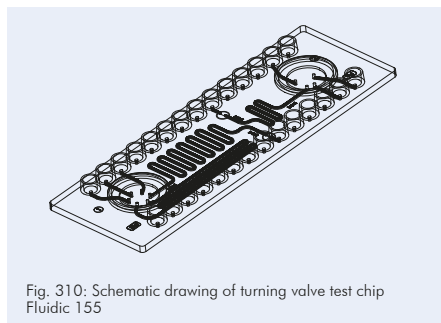

Fig. 310: Schematic drawing of turning valve test chip Fluidic 155

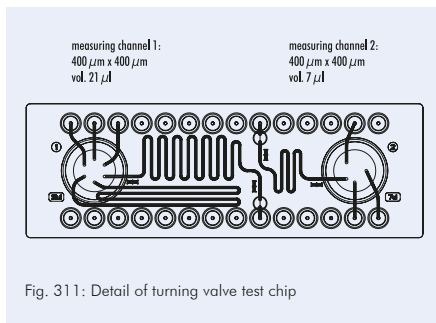

Fig. 311: Detail of turning valve test chip

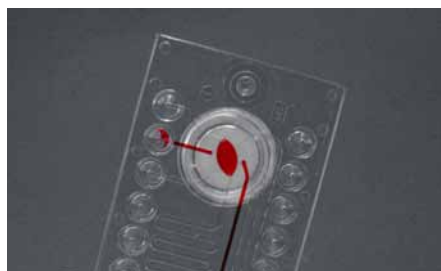

Fig. 312: Rotary valve with metering function



Fig. 313: Turning valve test chip with manual turning valve actuator

Product Code for Fluidic 155	Lid Thickness [μm]	Material	Price [€]	
			1+	10+
10000182	175	PC	128.50	79.60
10000183	188	Zeonor	128.50	79.60

Product Code	Description	Price [€]
10000742	Manual turning valve actuator	36.50



### 3.22 Blister test chips

The blister test chips are intended to evaluate liquid storage in blister pouches on chip. All blister test chips feature the unique *microfluidic ChipShop* blister seat for uniform blister emptying. Each chip comes with mounted blisters of defined size and defined filling volume (dyed water). Customer-specific blister filling is available. Please contact us via [inquiries@microfluidic-ChipShop.com](mailto:inquiries@microfluidic-ChipShop.com) for consultation and quotation.

Stand-alone standard blisters are filled with dyed water and are available in different volumes. Please see page 106 for the blister pouches and page 196 chapter 10.4 for the ChipGenie® edition BD.

#### 3.22.1 Blister test chip

Being equipped with two blisters that can be operated individually, the blister test chip 289 allows to evaluate the flow rate of the blister emptying procedure and to compare two different channel settings.

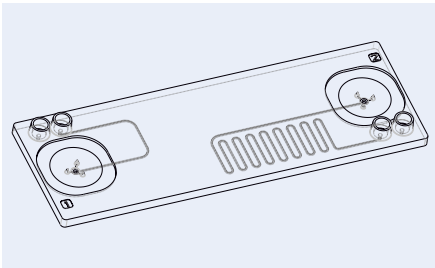

Fig. 314: Schematic drawing of blister test chip Fluidic 289. Blister position 1 being left and position 2 being right.

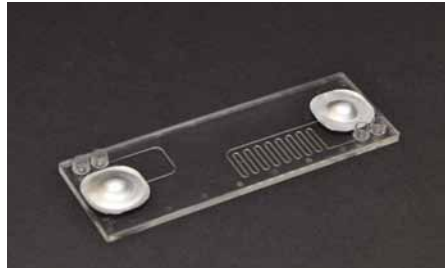

Fig. 315: Blister test chip Fluidic 289 with attached blister pouches

Product Code for Fluidic 289	Description	Blister details	Lid thickness [ $\mu\text{m}$ ]	Surface treatment	Material	Price [€/chip]		
						1+	10+	100+
10001305	Blister test chip	Blister position 1: 50 $\mu\text{l}$ ; cyan; $\text{H}_2\text{O}$  Blister position 2: 100 $\mu\text{l}$ ; magenta; $\text{H}_2\text{O}$	140	-	Topas	84.20	42.50	28.90
10001306	Blister test chip	Blister position 1: 50 $\mu\text{l}$ ; cyan; $\text{H}_2\text{O}$  Blister position 2: 100 $\mu\text{l}$ ; magenta; $\text{H}_2\text{O}$	140	hydrophilized	Topas	87.20	45.50	31.90

#### 3.22.2 Blister test chip – Emptying and volume evaluation

This blister test chip is equipped with two blisters followed by a straight channel or a channel with five cavities in line allowing for a measuring of 50  $\mu\text{l}$  each.

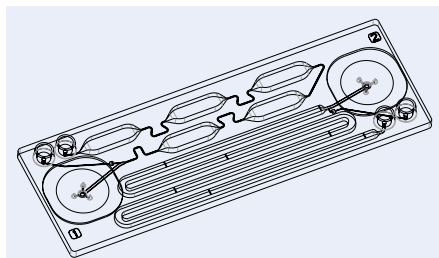

Fig. 316: Schematic drawing of blister test chip Fluidic 522. Blister position 1 being left and position 2 being right.



Fig. 317: Blister test chip Fluidic 522

Product Code for Fluidic 522	Description	Blister details	Lid thickness [ $\mu\text{m}$ ]	Surface treatment	Material	Price [€/chip]		
						1+	10+	100+
10001307	Blister test chip - Emptying and volume evaluation	Blister position 1: 250 $\mu\text{l}$ ; cyan; $\text{H}_2\text{O}$ Blister position 2: 250 $\mu\text{l}$ ; magenta; $\text{H}_2\text{O}$	140	-	Topas	84.20	42.50	28.90
10001308	Blister test chip - Emptying and volume evaluation	Blister position 1: 250 $\mu\text{l}$ ; cyan; $\text{H}_2\text{O}$ Blister position 2: 250 $\mu\text{l}$ ; magenta; $\text{H}_2\text{O}$	140	hydrophilized	Topas	87.20	45.50	31.90

#### 3.22.3 Blister test chip – Large volume blister

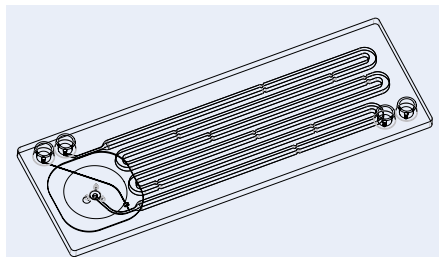

Fig. 318: Schematic drawing of blister test chip 761 – 500  $\mu\text{l}$  blister

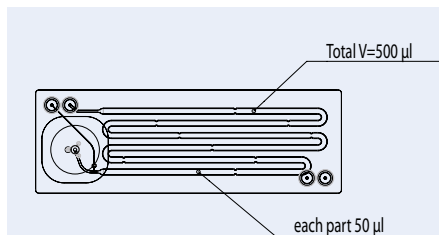

Fig. 319: Blister test chip fluidic 761 – 500  $\mu\text{l}$  blister

Product Code for Fluidic 761	Description	Blister details	Lid thickness [ $\mu\text{m}$ ]	Surface treatment	Material	Price [€/chip]		
						1+	10+	100+
10000979	Blister test chip - Large volume	Blister position 1: 500 $\mu\text{l}$ ; cyan; $\text{H}_2\text{O}$	140	-	Topas	64.80	34.60	22.15
10000980	Blister test chip - Large volume	Blister position 1: 500 $\mu\text{l}$ ; cyan; $\text{H}_2\text{O}$	140	hydrophilized	Topas	67.80	37.60	25.15





### 3.22.4 Blister test chip – Volume variation

This blister test chip is suitable for evaluating the emptying of a variety of blisters with volumes ranging from  $50\ \mu\text{l}$  to  $500\ \mu\text{l}$ . The chip design allows exact metering of  $5\ \mu\text{l}$  (for  $50\ \mu\text{l}$  blister),  $15\ \mu\text{l}$  (for  $150\ \mu\text{l}$  blister) and  $25\ \mu\text{l}$  (for  $250\ \mu\text{l}$  and  $500\ \mu\text{l}$  blisters) with the aid of downstream channel/chambers.

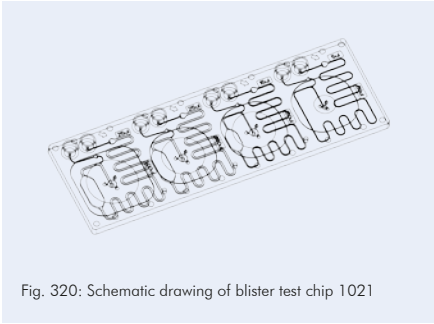

Fig. 320: Schematic drawing of blister test chip 1021

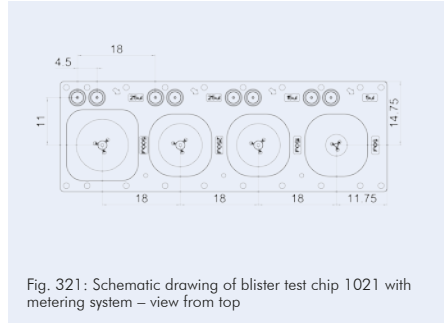

Fig. 321: Schematic drawing of blister test chip 1021 with metering system – view from top

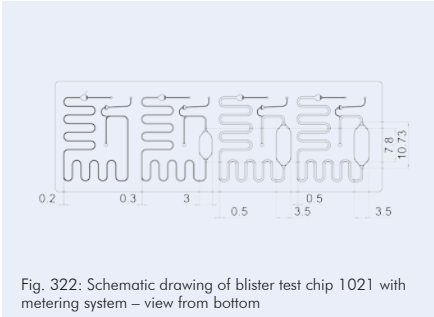

Fig. 322: Schematic drawing of blister test chip 1021 with metering system – view from bottom



Fig. 323: Blister test chip Fluidic 1021 – volume variation

Product Code for Fluidic 1021	Description	Blister details	Lid thickness [ $\mu\text{m}$ ]	Surface treatment	Material	Price [€/chip]		
						1+	10+	100+
10001309	Blister test chip - Volume variation	Blister position 1: $500\ \mu\text{l}$ ; magenta; $\text{H}_2\text{O}$  Blister position 2: $250\ \mu\text{l}$ ; cyan; $\text{H}_2\text{O}$  Blister position 3: $150\ \mu\text{l}$ ; magenta; $\text{H}_2\text{O}$  Blister position 4: $50\ \mu\text{l}$ ; cyan; $\text{H}_2\text{O}$	140	-	Topas	102.20	83.20	61.10
10001310	Blister test chip - Volume variation	Blister position 1: $500\ \mu\text{l}$ ; magenta; $\text{H}_2\text{O}$  Blister position 2: $250\ \mu\text{l}$ ; cyan; $\text{H}_2\text{O}$  Blister position 3: $150\ \mu\text{l}$ ; magenta; $\text{H}_2\text{O}$  Blister position 4: $50\ \mu\text{l}$ ; cyan; $\text{H}_2\text{O}$	140	hydrophilized	Topas	105.20	86.20	64.10



#### 3.22.5 Spare blisters

Blisters can be ordered as stand-alone parts being available with volumes ranging from 50 – 500  $\mu\text{l}$  off-the-shelf.

The blisters from 50 – 350  $\mu\text{l}$  volume can be operated with microfluidic devices like blister test chips Fluidic 289 and Fluidic 522, the 500  $\mu\text{l}$  blister requires Fluidic 761.

For convenience reasons, the blisters come with a ring of double sided adhesive tape to be mounted on the chips. Afterwards, the blisters can be removed for blister replacement.

All blisters can be ordered filled either with dye (cyan, magenta, yellow), water (clear) or user-specific liquids (to be provided to *microfluidic ChipShop*). Please inquire custom-fillings with *sales@microfluidic-ChipShop.com*.

Product code (color-dependent)				Description	Blister Volume [ $\mu\text{l}$ ]	Price [€/blister]		
Cyan	Magenta	Yellow	Clear			1+	10+	100+
10000678	10001145	10001146	10001147	Blister pouch	50	8.20	5.80	2.95
10000679	10001148	10001149	10001150	Blister pouch	100	8.20	5.80	2.95
10000680	10001151	10001152	10001153	Blister pouch	150	8.20	5.80	2.95
10000681	10001154	10001155	10001156	Blister pouch	200	8.20	5.80	2.95
10000682	10001157	10001158	10001159	Blister pouch	250	8.20	5.80	2.95
10000683	10001160	10001161	10001162	Blister pouch	350	8.20	5.80	2.95
10000684	10001163	10001164	10001165	Blister pouch	500	8.20	5.80	2.95



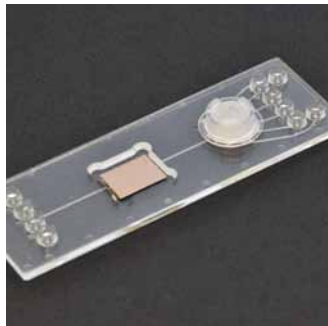
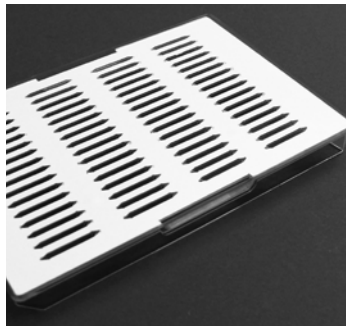
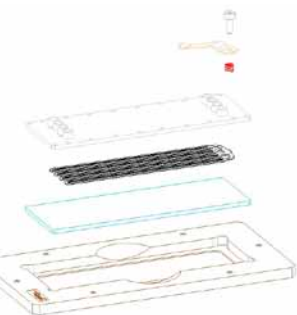

## 4 Microfluidic devices for customization and sensor integration

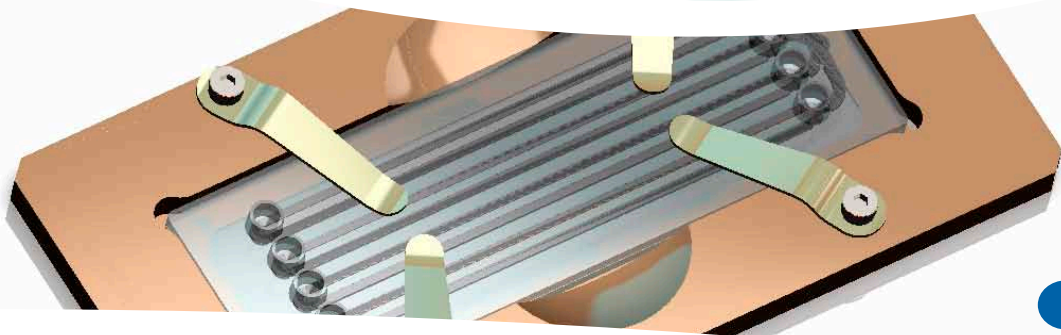

### Customize your chips – Tools for on-site assembly

For complex assay development, it becomes indispensable to tailor microfluidic devices to the precise assay specification. These chip modifications can involve not only the integration of further functionalities or the integration of special surface functions, but also the incorporation of appropriate sensor technology. This chapter highlights microfluidic tools and devices that are particularly suited for customization at the user's side.



### 4.1 Open chip platforms for self-assembly

For customized reagent and assay integration several chip types are at hand, having one or more integrated fluidic channels that remain open for manipulation at customer's side. A double-sided adhesive tape with approximately 140  $\mu\text{m}$  thickness is mounted on the delivered chip with open channels. That means after processing just the protective foil needs to be removed and either a thin foil of the same material or e.g. a glass slide can be mounted on top. Please note that channel depth of the devices (stated in product tables) consist of the initial channel depth of the molded part plus the thickness of the adhesive tape.

microfluidic ChipShop offers several standard formats for open chip platforms. However, in general most of our off-the-shelf catalogue chips can be provided without a bonded cover lid, for you to connect the chip with a specific bottom that reflects your requirements.

As – somewhat generic – design rules, you should take the following aspects under consideration:

- Minimum channel width that can be cut into the double-sided adhesive tape: 200  $\mu\text{m}$
- Minimum radius of curvature of the structures cut in one line in the tape: 500  $\mu\text{m}$
- Minimum distance between two adjacent cut-out structures: 1 mm
- The remaining tape film should have as much mechanical stability as possible for mounting onto the molded substrate. This means, the shorter the cut-out sections and the more widely spaced, the better.

Please contact our sales team at [sales@microfluidic-ChipShop.com](mailto:sales@microfluidic-ChipShop.com) for feasibility and pricing.

**Spotting applications:** Integration of protein or DNA arrays into chip modules for self-assembly can be nicely performed with the appropriate spotter (micro-dispensing) instrumentation. Please refer to chapter 11.5 to find out more about the spotter instrument TWO-200 from M2-Automation, which we highly recommend.



Fig. 324: Titer-plate sized microfluidic device for customization

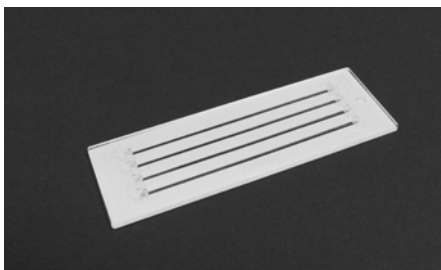

Fig. 325: Straight channel chip Fluidic 138 with double-sided adhesive tape

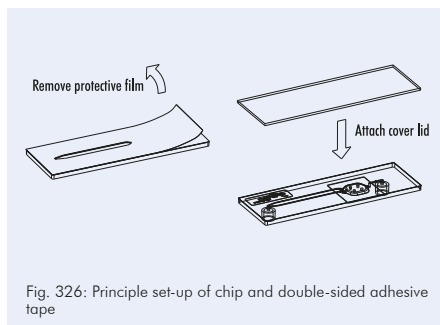

Fig. 326: Principle set-up of chip and double-sided adhesive tape

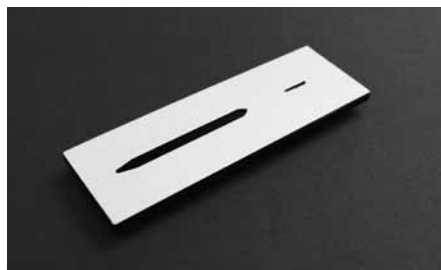
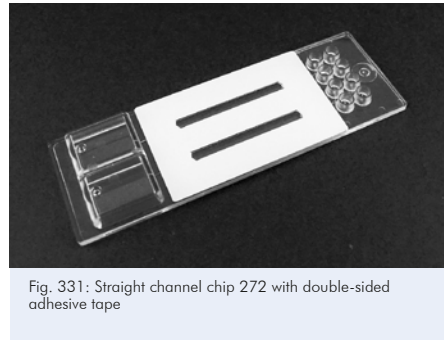
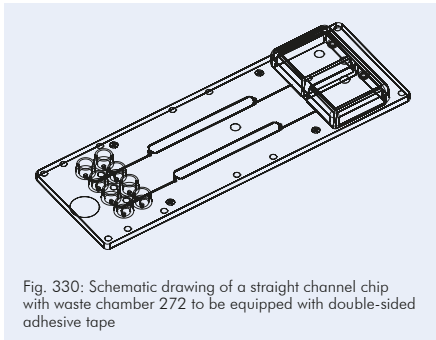
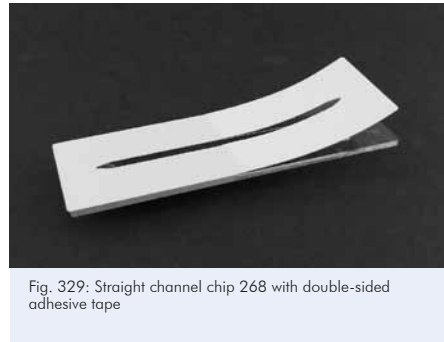
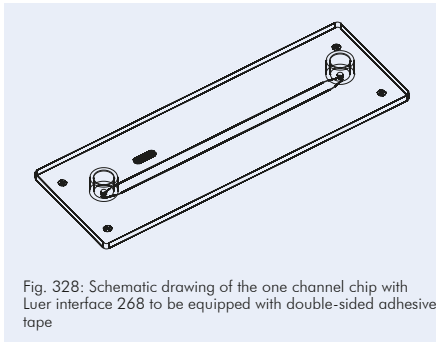

Fig. 327: Straight channel chip Fluidic 95 with double-sided adhesive tape and waste reservoir



Product Code	Description	Channel			Material	Price [€/chip]	
		Width [μm]	Depth [μm]	Length [mm]		1+	10+
10000313	4 channel chip Fl. 138	1,000	340	58.5	PMMA	48.50	36.50
10000307	4 channel chip Fl. 138	1,000	340	58.5	Topas	48.50	36.50
10000429	1 channel chip Fl. 95	3,000	340	36	PMMA	52.50	36.60
10000417	1 channel chip Fl. 95	3,000	340	36	Topas	52.50	36.60
10000430	1 channel chip Fl. 95	3,000	340	36	Topas, black	52.50	36.60



Product Code	Description	Channel			Material	Price [€/chip]	
		Width [μm]	Depth [μm]	Length [mm]		1+	10+
10000376	1 channel chip Fl. 268	2,500	290	26	PMMA	48.50	36.50
10000306	1 channel chip Fl. 268	2,500	290	26	Topas	48.50	36.50
10001136	1 channel chip Fl. 268	2,500	290	26	Zeonor		
10000346	2 channel chip with waste reservoir Fl. 272	2,500	340	58.5	PMMA	52.50	36.60
10000347	2 channel chip with waste reservoir Fl. 272	2,500	340	58.5	Topas	52.50	36.60



4.2 Self-sealing and releasable chips – slide format

For some tasks it is desired to mount a microfluidic device on a surface and remove it afterwards for further operations. This might be the case, if an array on a glass surface should be further processed or if specimens should be removed from the microfluidic device.

microfluidic ChipShop’s self-sealing and releasable chip address this task: With a soft component being part of the microfluidic device a liquid tight sealing on planar and clean surfaces can be achieved by a certain pressure. Removal of the microfluidic chip from the glass device can be done easily after completion of the fluidic operation. Next to the microfluidic chip a respective handling frame is at hand.

4.2.1 Self-sealing and releasable chips – slide format

The self-sealing and releasable chips can be mounted liquid tight on flat and clean surfaces by applying a homogenous pressure on the surface. For this task, respective handling frames are at hand to allow for a convenient operation of the chips.

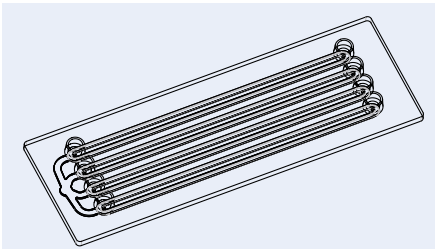

Fig. 332: Schematic drawing of Fluidic 745 – Self-sealing and releasable chip

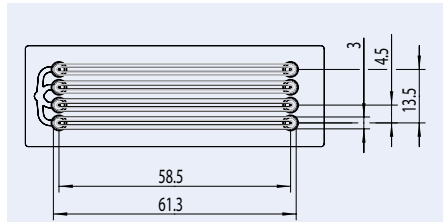

Fig. 333: Self-sealing and releasable chip Fluidic 745 – Self-sealing and releasable chip

Product Code for Fluidic 745	Channel Volume 1 [μl]	Width Depth [μm]		Lid Thickness [μm]	Material	Surface Treatment	Price [€/chip]	
							10+	100+
10001053	11.8	1.0	0.2	125	PS	-	27.30	19.10
10001054	11.8	1.0	0.2	125	PS	hydrophilized	34.30	21.40

4.2.2 Handling frame for self-sealing and releasable chips – for slide-format chips

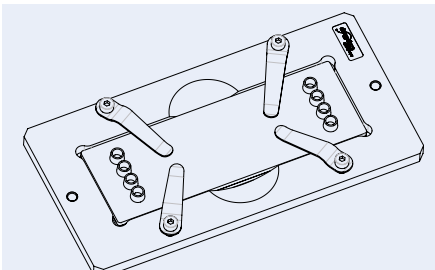

Fig. 334: Handling frame for self-sealing and releasable chips in slide-format

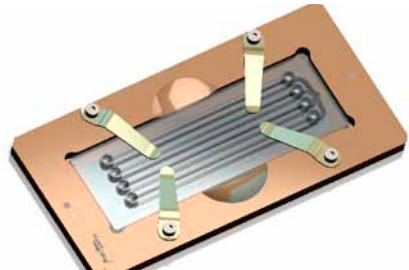

Fig. 335: Handling frame with chip – self-sealing and releasable chips

Product Code	Description	Price [€]
10001090	Handling-frame for self-sealing and releasable chips in slide-format	1+ 5+ 244.00 204.00





### 4.3 Sensor integration chips

Frequently, one wants to evaluate the combination of microfluidics and sensors, e.g. silicon photonic or electrochemical sensors. Chips of the sensor integration family were developed especially for this need and are available in a range of complexities.

One design feature all sensor integration chips have in common: an area for easy sensor installation, either as chamber or open area. In both cases the sensor of choice can be mounted via a double-sided adhesive tape gasket. At the same time the specific adhesive tape cut-out, with a height of  $140\ \mu\text{m}$ , is an integral part of the fluidic system. Adhesives with multiple cut-out shapes are possible and have to be ordered separately. On request adhesive tapes can also be customized. Examples of possible cut-outs are shown below.

Depending on chip design sensor integration chips furthermore feature turning valves, mixers, bubble traps and reaction or waste chambers. With this diverse range of sensor integration chips a variety of experimental setups is made possible.

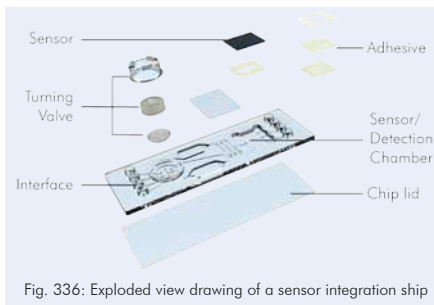

Fig. 336: Exploded view drawing of a sensor integration chip

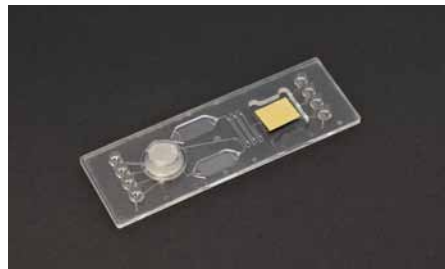

Fig. 337: Fully assembled sensor integration chip

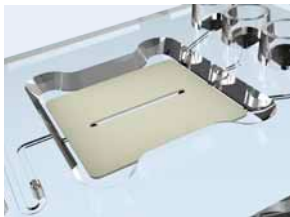

Fig. 338: Double-sided adhesive tape gasket – straight channel



Fig. 339: Double-sided adhesive tape gasket – rhombic chamber



Fig. 340: Double-sided adhesive tape gasket – curved channel



### 4.3.1 Sensor integration chips – Basic sensor platforms

The two basic sensor platforms are the simplest versions of sensor integration chips. These chips with Mini Luer interfaces possess a sensor integration area, either with an inbuilt, lowered rhombic chamber (basic sensor platform I - Fluidic 864) or with a flat sensor integration area surface (basic sensor platform II - Fluidic 1005). Therefore, for Fluidic 864 sensor mounting can be facilitated only with the compatible rhombic chamber cut-out adhesive tape, while in case of Fluidic 1005 two standard adhesive tape gaskets are available. Also, custom-designed adhesive tape gaskets are a feasible option for Fluidic 1005.

Apart from their sensor integration area, Fluidic 864 and Fluidic 1005 are very similar in design. However, Fluidic 1005 comes with two additional inlets and outlets, each.

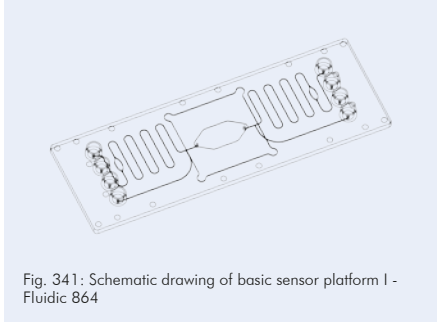

Fig. 341: Schematic drawing of basic sensor platform I - Fluidic 864

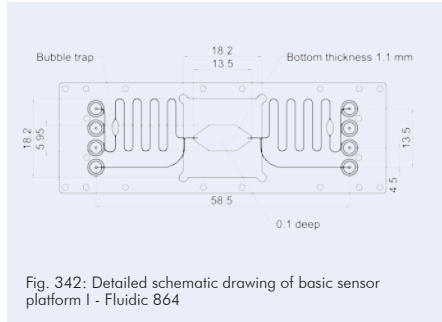

Fig. 342: Detailed schematic drawing of basic sensor platform I - Fluidic 864

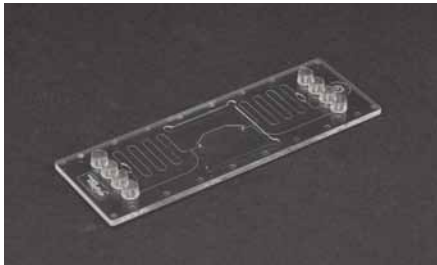

Fig. 343: Basic sensor platform I - Fluidic 864

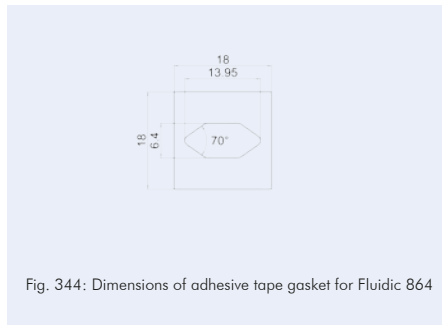

Fig. 344: Dimensions of adhesive tape gasket for Fluidic 864

Product Code for Fluidic 864	Description	Channel Width [μm]	Channel Depth [μm]	Lid Thickness [μm]	Material	Price [€/chip]*		
						1+	10+	100+
10001351	Basic sensor platform I	100	100	140	Topas	48.50	36.50	22.40
10001352	Basic sensor platform I	100	100	188	Zeonor	48.50	36.50	22.40

\* does not include adhesive tape gasket

Product Code	Description	Thickness [μm]	Price [€/tape]		
			1+	10+	100+
10001360	Adhesive tape gasket for Fl. 864 - rhombic chamber	140	3.35	2.10	1.65

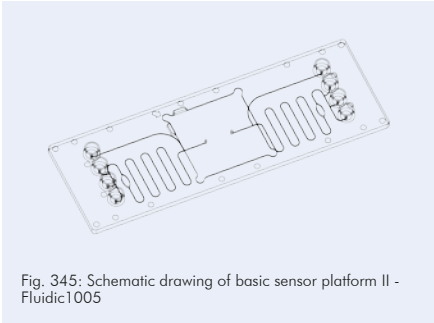

Fig. 345: Schematic drawing of basic sensor platform II - Fluidic1005

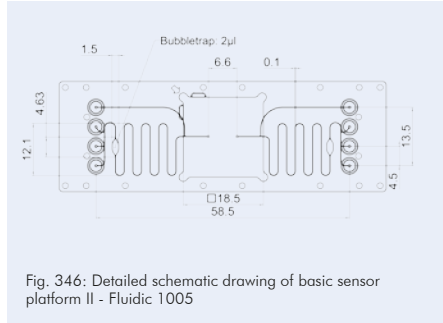

Fig. 346: Detailed schematic drawing of basic sensor platform II - Fluidic 1005

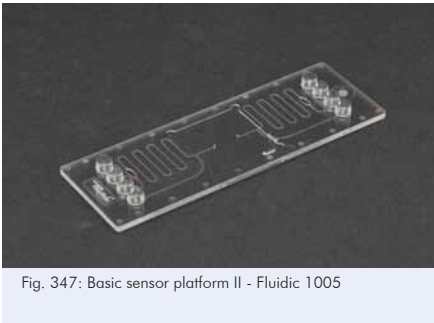

Fig. 347: Basic sensor platform II - Fluidic 1005

Product Code for Fluidic 1005	Description	Channel Width [µm]	Channel Depth [µm]	Lid Thickness [µm]	Material	Price [€/chip]*		
						1+	10+	100+
10001353	Basic sensor platform II	100	100	140	Topas	48.50	36.50	22.40
10001354	Basic sensor platform II	100	100	188	Zeonor	48.50	36.50	22.40

\* does not include adhesive tape gasket

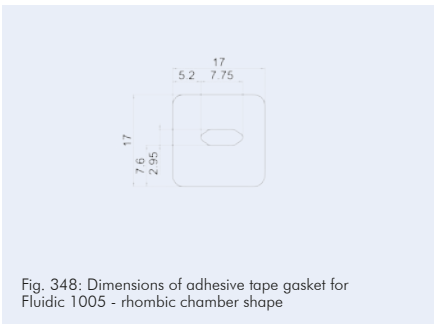

Fig. 348: Dimensions of adhesive tape gasket for Fluidic 1005 - rhombic chamber shape

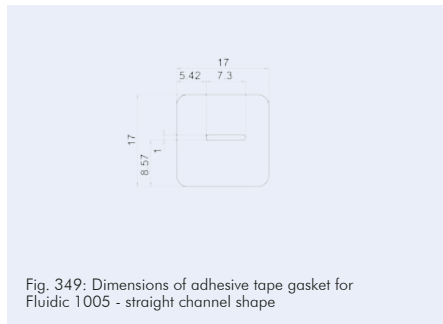

Fig. 349: Dimensions of adhesive tape gasket for Fluidic 1005 - straight channel shape

Product Code	Description	Thickness [µm]	Price [€/tape]		
			1+	10+	100+
10001361	Adhesive tape gasket for Fl. 1005 - rhombic chamber shape	140	3.35	2.10	1.65
10001362	Adhesive tape gasket for Fl. 1005 - straight channel shape	140	3.35	2.10	1.65



### 4.3.2 Sensor integration chips – Turning valve sensor platform

Being one of the simpler chips of the sensor integration chip family, this platform allows to mount a sensor with maximum dimensions of 11.5 mm x 10.5 mm in a prepared cavity with six switchable inlets and one outlet. The channels have a dimension of 400  $\mu\text{m}$  width and 150  $\mu\text{m}$  depth.

The valve can be operated with the manual turning valve actuator (see page 102) or the ChipGenie TV instrument Chapter 10.5.

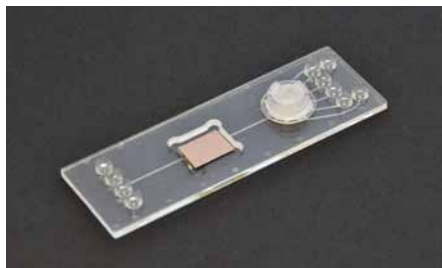

Fig. 350: Turning valve sensor platform Fluidic 673 with Mini Luer interfaces

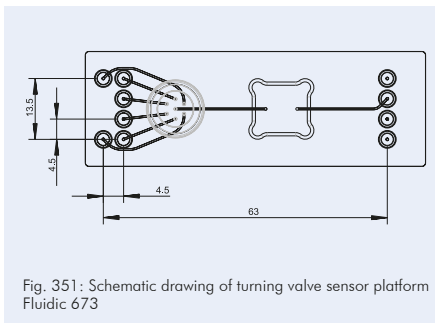

Fig. 351: Schematic drawing of turning valve sensor platform Fluidic 673

Product Code for Fluidic 673	Description	Material	Lid Thickness [ $\mu\text{m}$ ]	Price [€/chip]*		
				1+	10+	100+
10000794	Sensor platform Fluidic 673	PMMA	175	62.20	44.30	26.10
10000795	Sensor platform Fluidic 673	Topas	140	62.20	44.30	26.10
10000796	Sensor platform Fluidic 673	PC	175	62.20	44.30	26.10
10000797	Sensor platform Fluidic 673	Zeonor	188	62.20	44.30	26.10
10000798	Sensor platform Fluidic 673	PS	125	62.20	44.30	26.10

\* does not include adhesive tape gasket

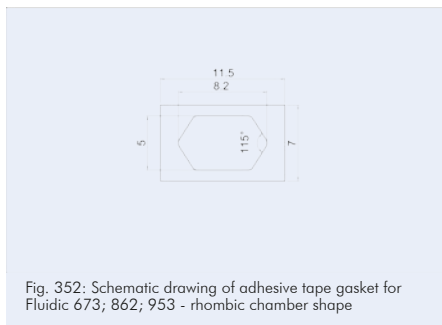

Fig. 352: Schematic drawing of adhesive tape gasket for Fluidic 673; 862; 953 - rhombic chamber shape

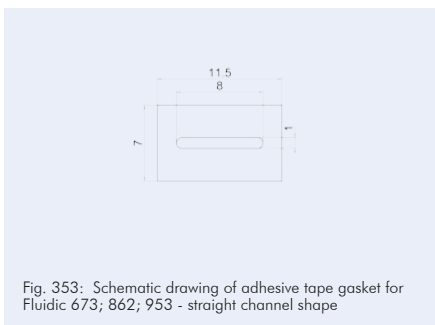

Fig. 353: Schematic drawing of adhesive tape gasket for Fluidic 673; 862; 953 - straight channel shape

Product Code	Description	Thickness [ $\mu\text{m}$ ]	Price [€/tape]		
			1+	10+	100+
10001363	Adhesive tape gasket for Fluidic 673; 862; 953 - rhombic chamber shape	140	3.35	2.10	1.65
10001364	Adhesive tape gasket for Fluidic 673; 862; 953 - straight channel shape	140	3.35	2.10	1.65



### 4.3.3 Sensor integration chips – Multifunctional sensor platforms

These complex sensor integration chips provide a variety of functionalities. Design features include: multiple inlets steerable via turning valve; reaction chambers and a three-dimensional serpentine mixer structure prior to the sensor integration area.

Multifunctional sensor platform I (Fluidic 862) includes Mini Luer interfaces on a microscope slide format and contains a single sensor integration area.

Multifunctional sensor platform II (Fluidic 953) comes with Luer interfaces on a double microscope slide format. This chip includes two sensor integration areas and a large (waste) chamber of 500  $\mu\text{l}$  volume.

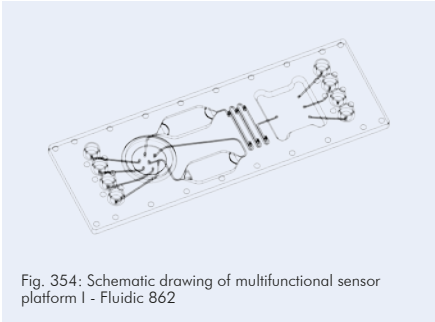

Fig. 354: Schematic drawing of multifunctional sensor platform I - Fluidic 862

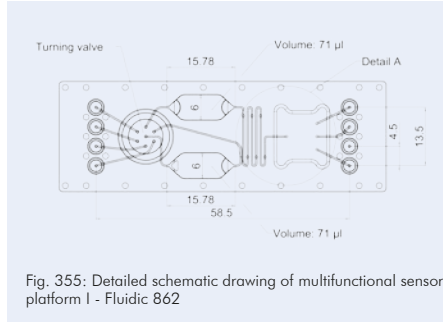

Fig. 355: Detailed schematic drawing of multifunctional sensor platform I - Fluidic 862

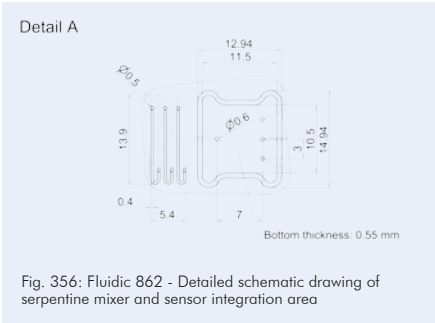

Fig. 356: Fluidic 862 - Detailed schematic drawing of serpentine mixer and sensor integration area

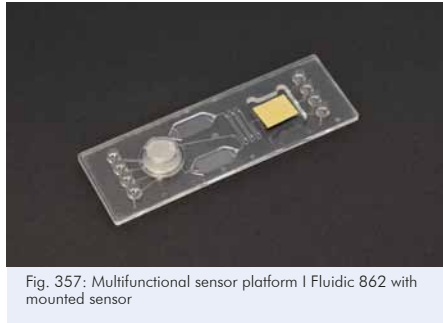

Fig. 357: Multifunctional sensor platform I Fluidic 862 with mounted sensor

Product Code for Fluidic 862	Description	Lid Thickness [ $\mu\text{m}$ ]	Material	Price [€/chip]*		
				1+	10+	100+
10001355	Multifunctional sensor platform I	140	Topas	62.20	44.30	26.10
10001356	Multifunctional sensor platform I	188	Zeonor	62.20	44.30	26.10

\* does not include adhesive tape gasket



## 4 Microfluidic devices for customization and sensor integration

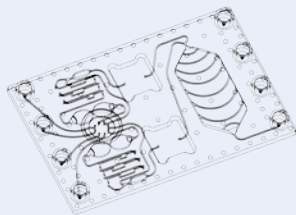

Fig. 358: Schematic drawing of multifunctional sensor platform II - Fluidic 953

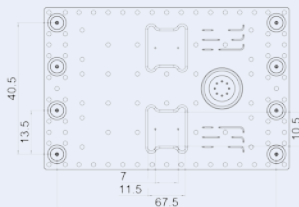

Fig. 359: Detailed schematic drawing of multifunctional sensor platform II - Fluidic 953

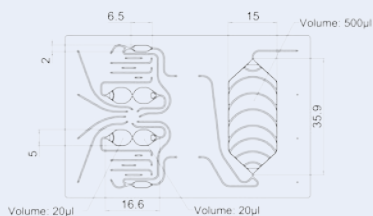

Fig. 360: Detailed schematic drawing of multifunctional sensor platform II - Fluidic 953

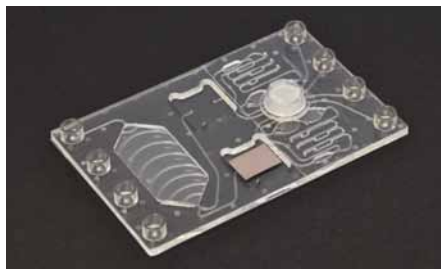

Fig. 361: Multifunctional sensor platform II Fluidic 953 with one mounted sensor

Product Code for Fluidic 953	Description	Lid Thickness [µm]	Material	Price [€/chip]*		
				1+	10+	100+
10001357	Multifunctional sensor platform II	140	Topas	79.50	63.50	42.50

\* does not include adhesive tape gasket

Product Code	Description	Thickness [µm]	Price [€/tape]		
			1+	10+	100+
10001363	Adhesive tape gasket for Fluidic 673; 862; 953 - rhombic chamber shape	140	3.35	2.10	1.65
10001364	Adhesive tape gasket for Fluidic 673; 862; 953 - straight channel shape	140	3.35	2.10	1.65



### 4.3.4 Sensor integration chips – Large sensor integration area platforms

Two available platforms with a larger sensor integration area are interfaced via Mini Luer ports. Liquid supply from a multitude of inlets is controlled with two turning valves, while one outlet is located on the platforms. The main difference between Large sensor integration area platform I (Fluidic 1004) and Large sensor integration area platform II (Fluidic 1012) is their channel positioning within the sensor area. Compatible standard adhesive tape gaskets for sensor mounting are available in straight channel (Fluidic 1004 and Fluidic 1012) and rhombic chamber (Fluidic 1004) shape.

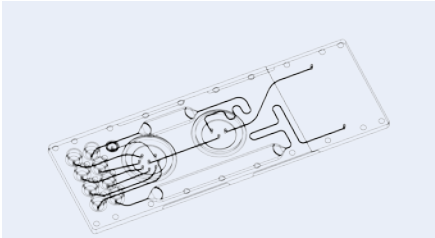

Fig. 362: Schematic drawing of large sensor integration area platform I - Fluidic 1004

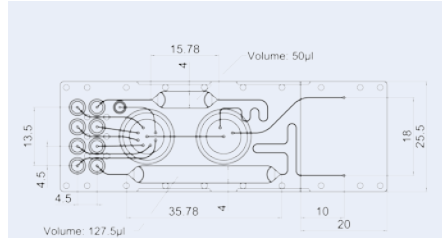

Fig. 363: Detailed schematic drawing of large sensor integration area platform I - Fluidic 1004

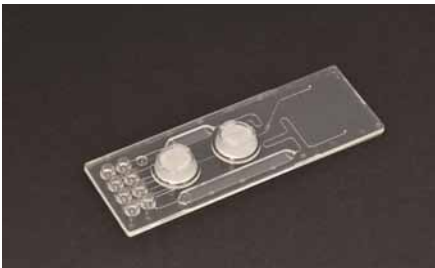

Fig. 364: Large sensor integration area platform I - Fluidic 1004

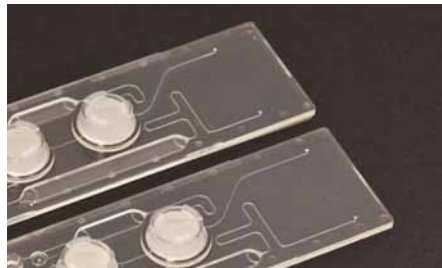

Fig. 365: Comparison of Large sensor integration area platform I - Fluidic 1004 (top) and Large sensor integration area platform II - Fluidic 1012 (bottom)

Product Code for Fluidic 1004	Description	Lid Thickness [µm]	Material	Price [€/chip]*		
				1+	10+	100+
10001358	Large sensor integration area platform I	140	Topas	79.50	63.50	42.50

\* does not include adhesive tape gasket



## 4 Microfluidic devices for customization and sensor integration

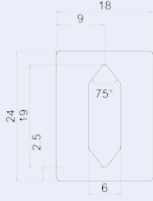

Fig. 366: Schematic drawing of adhesive tape gasket for Fluidic 1004 - straight rhombic shape

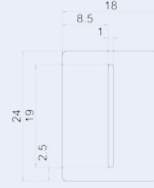

Fig. 367: Schematic drawing of adhesive tape gasket for Fluidic 1004 - straight channel shape

Product Code	Description	Thickness [ $\mu\text{m}$ ]	Price [€/tape]		
			1+	10+	100+
10001365	Adhesive tape gasket for Fluidic 1004 - rhombic chamber shape	140	3.35	2.10	1.65
10001366	Adhesive tape gasket for Fluidic 1004 - straight channel shape	140	3.35	2.10	1.65

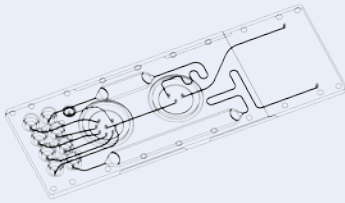

Fig. 368: Schematic drawing of large sensor integration area platform II - Fluidic 1012

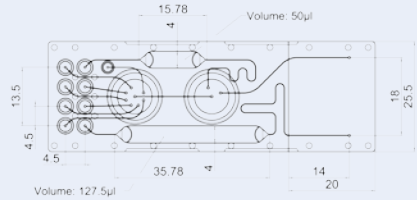

Fig. 369: Detailed schematic drawing of large sensor integration area platform II - Fluidic 1012



Fig. 370: Large sensor integration area platform II - Fluidic 1012

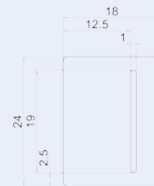

Fig. 371: Schematic drawing of adhesive tape gasket for Fluidic 1012 - straight channel shape

Product Code for Fluidic 1012	Description	Lid Thickness [ $\mu\text{m}$ ]	Material	Price [€/chip]*		
				1+	10+	100+
10001359	Large sensor integration area platform II	140	Topas	79.50	63.50	42.50

\* does not include adhesive tape gasket





Product Code	Description	Thickness [ $\mu\text{m}$ ]	Price [€/tape]		
			1+	10+	100+
10001367	Adhesive tape gasket for Fluidic 1012 - straight channel shape	140	3.35	2.10	1.65

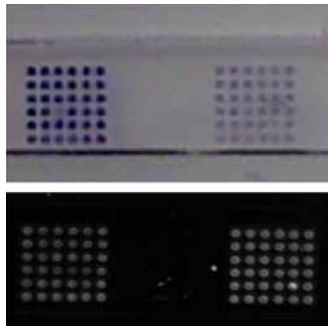
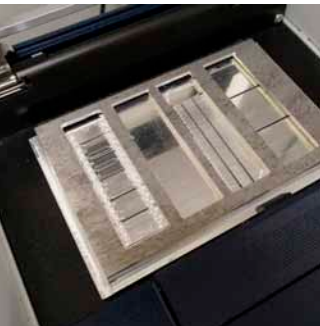

## 5 Microfluidic chips – Integrated chips

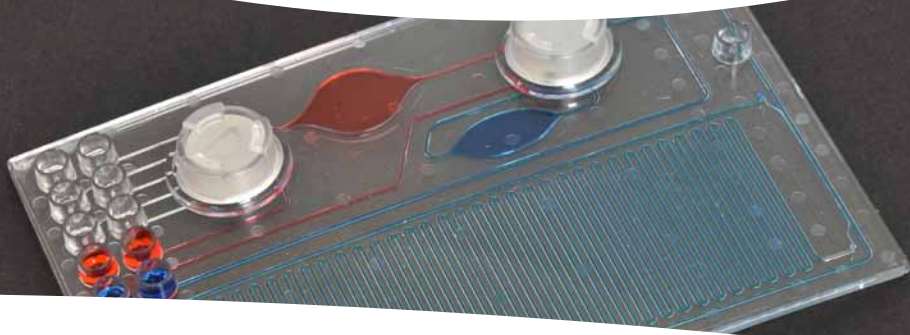

### Microfluidic chips – Integrated chips

This chapter summarizes various integrated chips combining different fluidic functions. Depending on the operator's choice, these chips can be used for a variety of applications ranging from immunoassays, molecular based assays to the detection of small molecules. On request the surface can be modified or for hybridization assays DNA or protein arrays can be integrated. For any custom modification of these devices, please contact us for feasibility and pricing.



### 5.1 Assay chip 1 – on board metering, mixing and reaction

This integrated chip allows for the development of biological assays on chip. The chip enables for on-chip metering, mixing and the detection of the reaction in a separate chamber.

For this purpose the chip is equipped with the following main elements:

- Metering cavity with 15  $\mu\text{l}$  volume
- Metering loop with 17  $\mu\text{l}$  volume
- Mixing chamber with 102  $\mu\text{l}$  volume
- Reaction & detection chamber with 20  $\mu\text{l}$  volume
- Two turning valves

The liquids are controlled with the help of two turning valves, overfilling of the detection chamber is prevented through a liquid tight membrane, the sample can be introduced through the female Luer interface and further reagents or air pressure can be supplied through the female Mini Luer interfaces. To operate this chip Luer and Mini Luer male fluid connectors, Luer and Mini Luer plugs as well as silicone and Teflon tubings are of use to allow for the connection of the chip with pumps. Direct filling of the chip with a pipette is possible, the use of pipette connectors is appreciated by several operators. The turning valves can be rotated with a special manual turning valve manipulator. All these accessories are combined in the **integrated chip support kit 1**.

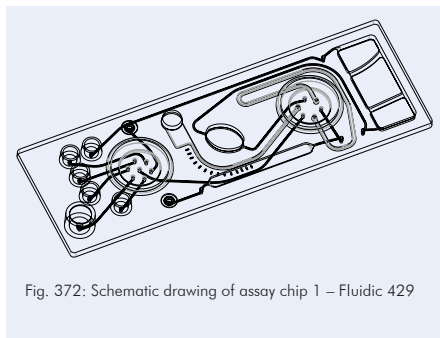

Fig. 372: Schematic drawing of assay chip 1 – Fluidic 429

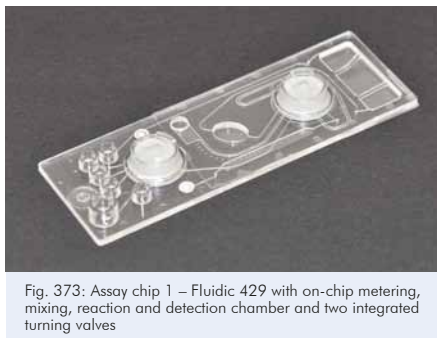

Fig. 373: Assay chip 1 – Fluidic 429 with on-chip metering, mixing, reaction and detection chamber and two integrated turning valves

Product Code for Fluidic 429	Description	Material	Lid Thickness [ $\mu\text{m}$ ]	Price [€/chip]		
				1+	10+	100+
10000373	Assay chip 1	Topas	140	84.85	43.90	27.56

Product Code	Kit Type	Product Description	Product Code	Price [€/kit]
10000301	Integrated chip support kit 1	<ul style="list-style-type: none"> <li>- Male Mini Luer fluid connectors, green, material: PP (10)</li> <li>- Male Mini Luer fluid connectors, opaque, material: TPE (10)</li> <li>- Male Mini Luer plugs, red, material: PP (10)</li> <li>- Male Mini Luer plugs, opaque, material: TPE (10)</li> <li>- Male Luer fluid connectors, green, material: PP (10)</li> <li>- Male Luer plugs, opaque, material: PP (10)</li> <li>- Mini Luer to pipette adapter, material: PP (10)</li> <li>- Silicone tube (ID: 0.5 mm, OD: 2.5 mm, 1 m) (2)</li> <li>- PTFE tube (ID: 0.5 mm, OD: 1 mm, 1 m) (5)</li> <li>- Manual turning valve actuator (1)</li> <li>- Handling frame with high skirt, yellow (1)</li> </ul>	10000029 10000116 10000053 10000054 10000081 10000230 10000057 10000033 10000032 10000742 10000042	197.14



## 5.2 Assay chip 2 – turning valve assisted fluid control with separate assay and reference cavities

### 5.2.1 Assay chip 2 – turning valve assisted fluid control with separate assay and reference cavities

This integrated chip allows for the development of hybridization assays on chip. Six 12  $\mu\text{l}$  cavities with 200  $\mu\text{m}$  depth can be used for spotting different kinds of arrays. Four of these chambers are operated in row, two further separately. The separate chambers allow e.g. for control or quantification reactions and have pre-cavities to store dry reagents.

Sample injection is foreseen through a female Luer interface, reagent supply or air pressure through the female Mini Luer interfaces.

The chip is equipped with the following main elements:

- 6 reaction & detection chambers with 12  $\mu\text{l}$  volume
- 2 pre-storage chambers with 12  $\mu\text{l}$  volume
- 2 turning valves

The liquids are controlled with the help of two turning valves, sample injection is foreseen through a female Luer interface, reagent supply or air pressure through the female Mini Luer interfaces.

To operate this chip Luer and Mini Luer male fluid connectors, Luer and Mini Luer plugs as well as silicone and Teflon tubings are of use to allow for the connection of the chip with pumps. Direct filling of the chip with a pipette is possible, the use of pipette connectors is appreciated by several operators. The turning valves can be rotated with a special manual turning valve manipulator. All these accessories are combined in the **integrated chip support kit 1** (see kit description on page 100).

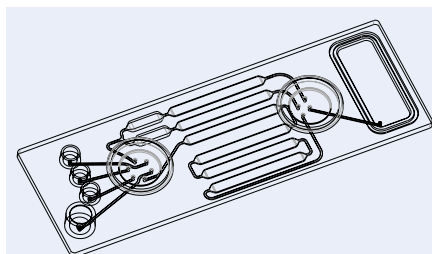

Fig. 374: Schematic drawing of assay chip 2 – Fluidic 292

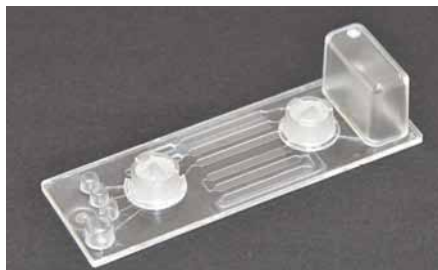

Fig. 375: Assay chip 2 – Fluidic 292 with hybridization chamber and integrated turning valve for fluid actuation

Product Code for Fluidic 292	Description	Material	Lid Thickness [ $\mu\text{m}$ ]	Price [€/chip]		
				1+	10+	100+
10000374	Assay chip 2	Topas	140	88.50	49.45	28.98
10000609	Assay chip 2	Topas, black	140	88.50	49.45	28.98



### 5.2.2 Assay chip 2 – turning valve assisted fluid control with separate assay and reference cavities including integrated arrays

The assay chip 2 as described in the previous chapter can be ordered with integrated arrays. *microfluidic ChipShop* will spot the desired molecules (e.g. DNA probes, antibodies, antigens etc.) on the polymer surface and will cover the chip with the thin cover foil. Reagents like antibodies or antigens and reference material have to be provided by the customer or will be charged separately. For the order of a special array a process set-up needs to be ordered in advance.

Product Code	Description	Price [€]
80000082	Process set-up custom array integration	Please inquire

Product Code for Fluidic 292	Description	Material	Lid Thickness [μm]	Price [€/chip]		
				1+	10+	100+
10000610	Assay chip 2 with custom array	Topas	140	197.50	98.45	59.98
10000611	Assay chip 2 with custom array	Topas, black	140	197.50	98.45	59.98

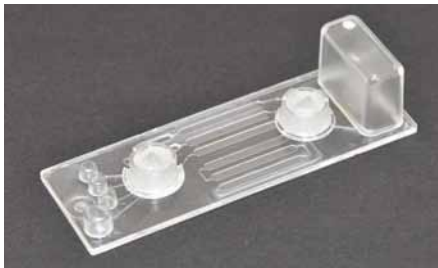
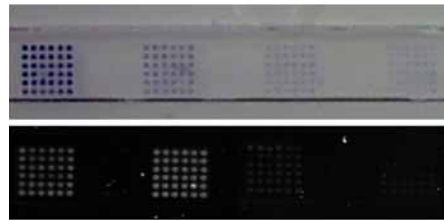

Fig. 376: Assay chip 2 – Fluidic 292 with embedded DNA array



Pos. control      F. tularensis      Y. pestis      Neg. control

Fig. 377: Array integrated on chip



### 5.3 Assay chip 3 – Assay development chip for magnetic bead based or hybridization assays

A 300  $\mu\text{m}$  deep central chamber with 30  $\mu\text{l}$  inner volume is the reaction cavity of this chip. To keep the components in the chamber either magnetic beads can be used which need to be operated by an external magnet or catcher molecules have to be immobilized on the surface of the cavity. Controlled by two turning valves liquids can be supplied and removed, air pressure can be applied and venting can be ensured.

Liquid supply and air pressure are foreseen through the female Mini Luer interfaces on chip. The chip is equipped with the following main elements:

- Cavity with 30  $\mu\text{l}$  volume
- 2 turning valves

To operate this chip Mini Luer male fluid connectors, Mini Luer plugs as well as silicone and Teflon tubings are of use to allow for the connection of the chip with pumps. Direct filling of the chip with a pipette is possible, the use of pipette connectors is appreciated by several operators. The turning valves can be rotated with a special manual turning valve manipulator. All these accessories are combined in the **integrated chip support kit 3**.

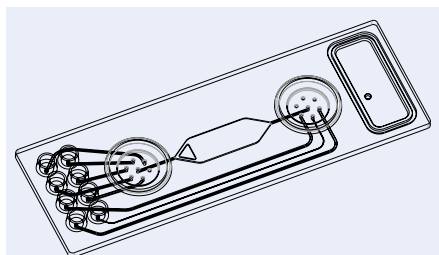

Fig. 378: Schematic drawing of assay chip 3 – Fluidic 490

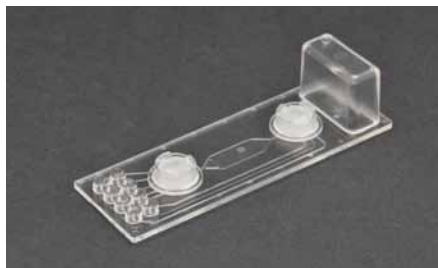

Fig. 379: Assay chip 3 – Fluidic 490 with central reaction chamber and integrated turning valve for fluid actuation

Product Code for Fluidic 490	Description	Material	Lid Thickness [ $\mu\text{m}$ ]	Price [€/chip]		
				1+	10+	100+
10000375	Assay chip 3	Topas	140	75.40	42.45	26.37

Product Code	Kit Type	Product Description	Product Code	Price [€/kit]
10000372	Integrated chip support kit 3	- Male Mini Luer fluid connectors, green, material: PP (10)	10000029	159.64
		- Male Mini Luer fluid connectors, opaque, material: TPE (10)	10000116	
		- Male Mini Luer plugs, red, material: PP (10)	10000053	
		- Male Mini Luer plugs, opaque, material: TPE (10)	10000054	
		- Mini Luer to pipette adapter, material: PP (10)	10000057	
		- Silicone tube (ID: 0.5 mm, OD: 2.5 mm, 1 m) (2)	10000033	
		- PTFE tube (ID: 0.5 mm, OD: 1 mm, 1 m) (5)	10000032	
		- Manual turning valve actuator (1)	10000742	
		- Handling frame with high skirt, yellow (1)	10000042	



### 5.4 Continuous-flow PCR chip with integrated sample preparation – Inline Chip

This integrated microfluidic chip combines the sample preparation, namely the extraction of DNA, and the later amplification of the DNA through continuous-flow-PCR. Reagents can be freely supplied through the various Mini Luer interfaces.

As accessories Mini Luer interfaces, Mini Luer plugs, silicone and PTFE tubes and the manual turning valve actuator are of use.

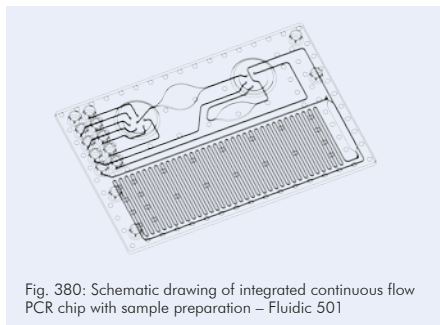

Fig. 380: Schematic drawing of integrated continuous flow PCR chip with sample preparation – Fluidic 501

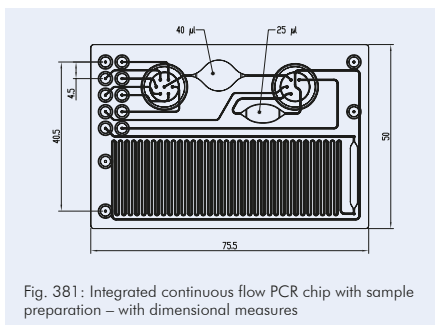

Fig. 381: Integrated continuous flow PCR chip with sample preparation – with dimensional measures

Product Code for Fluidic 501	Lid Thickness [μm]	Material	Comments Design, Channel Dimensions	Price [€/chip]		
				1+	10+	100+
10000358	175	PC	Integrated continuous flow chip, 35 cycles, PCR meander 200 μm deep & 400 μm wide, one 40 μl, one 25 μl cavity	132.98	64.60	39.76
10000357	125	Topas	Integrated continuous flow chip, 35 cycles, PCR meander 200 μm deep & 400 μm wide, one 40 μl, one 25 μl cavity	132.98	64.60	39.76
10000356	188	Zeonor	Integrated continuous flow chip, 35 cycles, PCR meander 200 μm deep & 400 μm wide, one 40 μl, one 25 μl cavity	132.98	64.60	39.76

Product Code	Kit Type	Product Description	Product Code	Price [€/kit]
10000371	Integrated chip support kit 4	- Male Mini Luer fluid connectors, green, material: PP (10)	10000029	144.64
		- Male Mini Luer fluid connectors, opaque, material: TPE (10)	10000116	
		- Male Mini Luer plugs, red, material: PP (10)	10000053	
		- Male Mini Luer plugs, opaque, material: TPE (10)	10000054	
		- Mini Luer to pipette adapter, material: PP (10)	10000057	
		- Silicone tube (ID: 0.5 mm, OD: 2.5 mm, 1 m) (2)	10000033	
		- PTFE tube (ID: 0.5 mm, OD: 1 mm, 1 m) (5)	10000032	
- Manual turning valve actuator (1)	10000742			





### 5.5 Immunofiltration System for Analytical Applications: IFSA 1 Immunoassay Chip - Microfilter-based enrichment and detection system for immunoassays

The IFSA chip family combines lab-on-a-chip technology with the advantages of microfilter-based assays, namely the enrichment of the sample through filtration and specific binding on the microfilter surface. Detection takes place directly on the microfilter surface as colorimetric or fluorescence detection depending on the chosen dye.

The IFSA 1 Immunoassay Chip can be equipped either with specific antibodies or antigens coated on the microfilter or with anti-haptene surface allowing for an afterwards specific functionalization of the IFSA 1 Immunoassay Chip by the user himself.

As a perfect merger of lab-on-a-chip and labautomation, the chip can be pre-equipped with dry or liquid reagents to be operated by a standard pipetting robot. Read-out can be done in standard 1536 well plate readers. For simple chip-specific operation, ChipGenie® edition I pipettor instrument can be used.

Chip-based microfilter technology is a collaborative work within the project IFSA together with the FZMB and Senova GmbH.

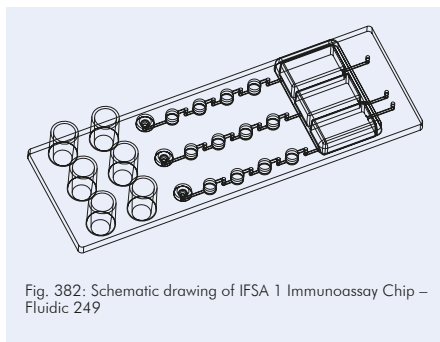

Fig. 382: Schematic drawing of IFSA 1 Immunoassay Chip – Fluidic 249

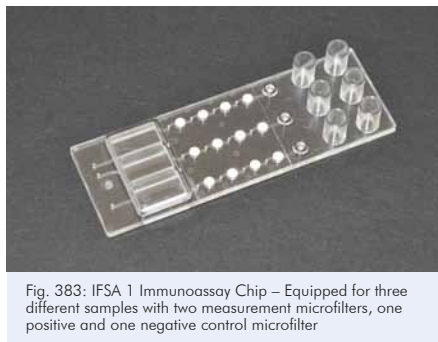

Fig. 383: IFSA 1 Immunoassay Chip – Equipped for three different samples with two measurement microfilters, one positive and one negative control microfilter



Fig. 384: Detail of stained microfilter area of IFSA 1 Immunoassay Chip

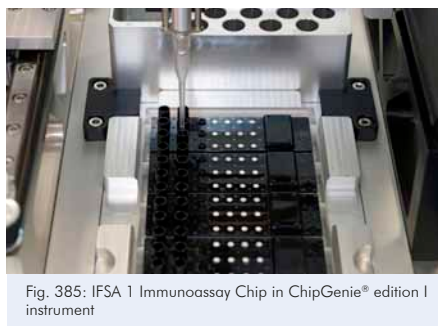

Fig. 385: IFSA 1 Immunoassay Chip in ChipGenie® edition I instrument



## 5 Microfluidic chips – Integrated chips

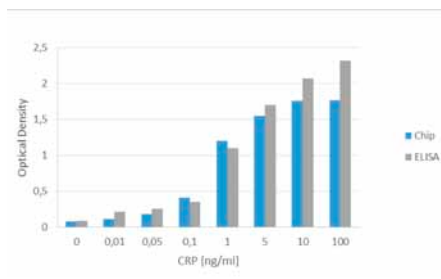

Fig. 386: Comparison of IFSA 1 Immunoassay Chip with standard ELISA for CRP detection (polyHRP / TMB) based on colorimetric read-out

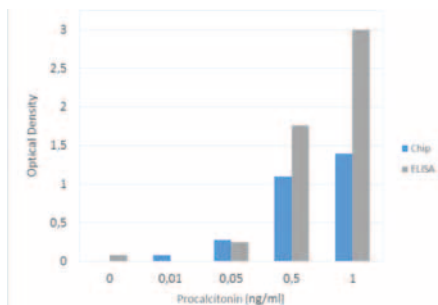

Fig. 387: Comparison of IFSA 1 Immunoassay Chip with standard ELISA for Procalcitonin detection (polyHRP / TMB) based on colorimetric read-out

Product Code	Description	Price [€]
10001208	Process set-up custom immunoassay on chip – pilot study – antibodies / antigens for immobilization will be charged separately or delivered by customer	22,980.00

Product Code	Short Product Description	Price [€]
10000805	ChipGenie® edition I instrument	14,240.00

Product Code	Embedded Microfilters	Functional Description	Chip Material	Price [€/chip]* 10+ 100+
10000314	- Negative control - Positive control (anti POD) - Anti hapten 1 - Anti hapten 2	IFSA 1 Immunoassay Chip pre-equipped with two generic micro-filters for custom immunoassay and positive and negative control Application note	Topas	64.70 29.45

\*For production quantities, please ask for a quote.

Product Code	Description	Detail	Price [€]
10001093	IFSA 1 Immunoassay Chip Reagent Kit 1 - V2	1. Wash buffer, 75 ml 2. Sample buffer, 50 ml 3. Conjugate (streptavidin-HRP), 30 ml 4. Substrate (TMB), 30 ml 5. Hapten 1-conjugation reagent: 0.2 mg 6. Hapten 2-conjugation reagent: 0.2 mg	262.00
10001215	IFSA 1 Immunoassay Chip Demonstration Reagent Kit 1	Reagent Kit for 20 chips comprising: 1. Wash buffer, 75 ml 2. Sample buffer, 20 ml 3. Conjugate (Streptavidin-HRP), 15 ml 4. Substrate (TMB), 15 ml 5. Anti-hCRP-hapten 1-conjugate, 50 µg 6. Anti-hPCR-hapten 2-conjugate, 50 µg 7. Anti-hCRP-biotin-conjugate, 50 µg 8. Anti-hPCT-biotin-conjugate, 50 µg 9. Human C-reactive protein, 50 µg 10. Human procalcitonin, 20 µg	540.00



### 5.6 Assay chip 4

Assay chip e.g. for cell-based assays that can be fluidically operated using hydrostatic pressure generated by attached liquid filled tanks.

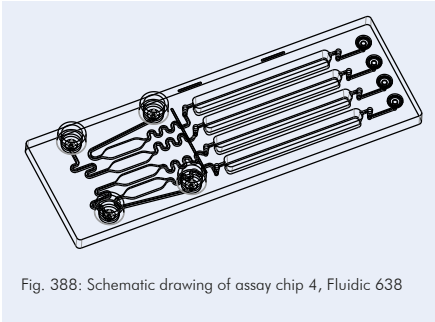

Fig. 388: Schematic drawing of assay chip 4, Fluidic 638

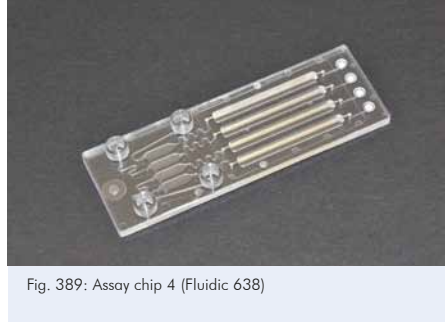
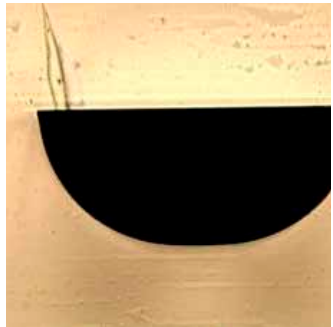
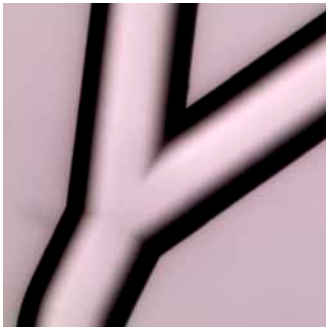
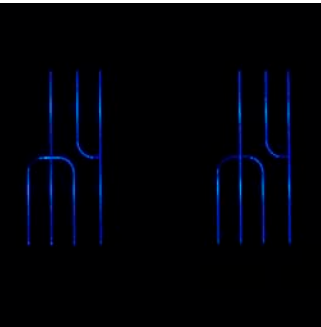
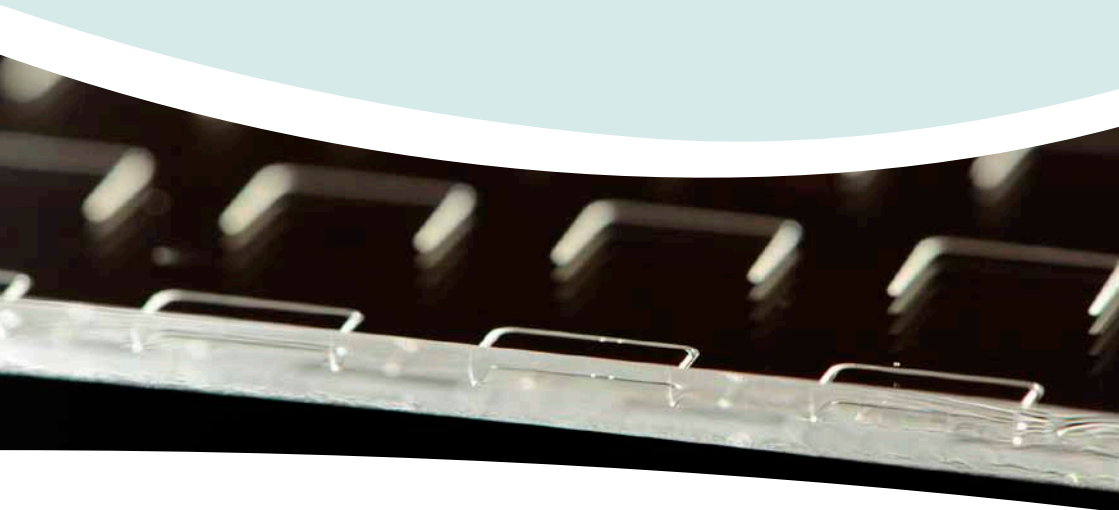

Fig. 389: Assay chip 4 (Fluidic 638)

Product Code for Fluidic 638	Chamber		Lid Thickness [ $\mu\text{m}$ ]	Material	Surface Treatment	Price [€/chip]		
	Volume [ $\mu\text{l}$ ]	Depth [ $\mu\text{m}$ ]				1+	10+	100+
10001211	10	500	140	Topas	-	36.20	24.30	16.10
10001212	10	500	125	PS	-	36.20	24.30	16.10
10001213	10	500	140	Topas	hydrophilized	39.20	26.30	17.80
10001214	10	500	125	PS	hydrophilized	39.20	26.30	17.80



## 6 Microfluidic chips – Glass



### Microfluidic chips – Glass

Glass is the material of choice if elevated temperatures or organic solvents come into play. This chapter shows standard chips in glass in the format of a microscopy slide with through holes as fluidic interface. Droplet generator chips or meander chips are off-the-shelf devices in glass. Custom-designs can be realized on demand.



## 6 Microfluidic chips – Glass

This chapter summarizes a variety of off-the-shelf glass devices. In order to facilitate the handling of these glass chips, respective accessories like handling frames are part of this section.

### 6.1 Standard microfluidic chips – glass

These glass chips have port interfaces - 96  $\mu\text{m}$  through holes on the chip with spacing of 4.5 mm between each other.

#### 6.1.1 Straight channel chips – glass

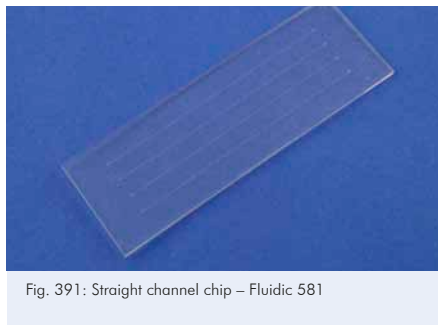
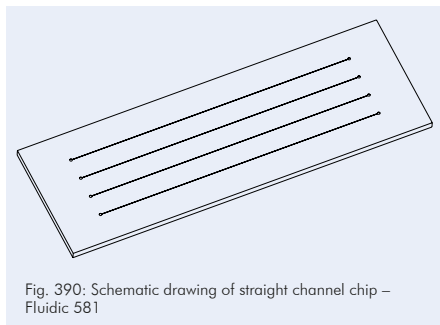

Product Code for Fluidic 581	Description	Channel Width [μm]	Depth [μm]	Length [mm]	Lid Thickness [μm]	Material	Price [€/chip]			
							1+	3+	5+	10+
10000448	Straight channel chip	50	50	58.5	150	Glass	143.70	109.75	99.78	89.70

#### 6.1.2 Chamber chips – glass

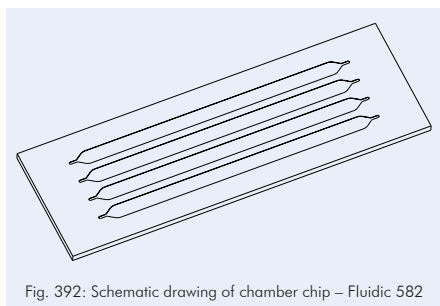

Product Code for Fluidic 582	Description	Channel Width [mm]	Depth [μm]	Length [mm]	Lid Thickness [μm]	Material	Price [€/chip]			
							1+	3+	5+	10+
10000449	Chamber chip	3	100	58.5	150	Glass	143.70	109.75	99.78	89.70



### 6.1.3 Droplet generator chips – glass

These off-the-shelf microfluidic devices are made for droplet generation on chip. Several microfluidic units embedded on one chip enable a parallel fabrication of droplets on chip.

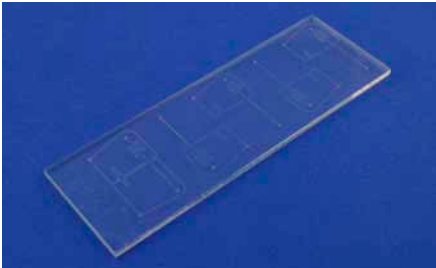

Fig. 394: Glass droplet generator chip Fluidic 441

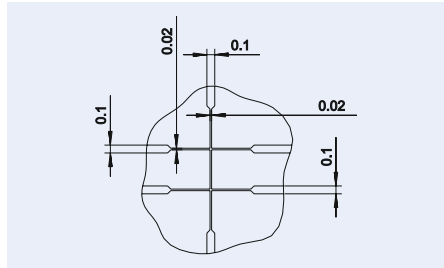

Fig. 395: Glass droplet generator chip Fluidic 441 – detail of cross element

Product Code for Fluidic 441	Description	Channel Depth [μm]	Material	Price [€/chip]			
				1+	3+	5+	10+
10000291	Droplet generator chip	20	Glass	143.70	109.75	99.78	89.70

### 6.1.4 Meander chips– glass

The meander chips can serve as reaction units as well as mixing device.

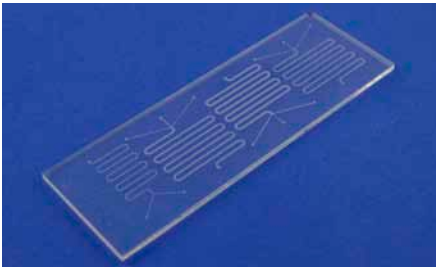

Fig. 396: Meander chip Fluidic 442

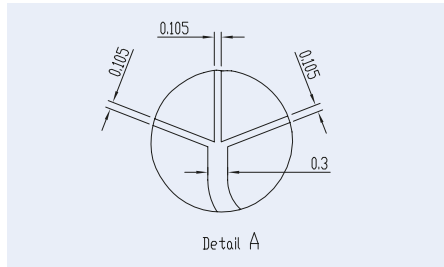

Fig. 397: Meander chip Fluidic 442 – channel details

Product Code for Fluidic 442	Description	Channel Depth [μm]	Material	Price [€/chip]			
				1+	3+	5+	10+
10000295	Meander chip	20	Glass	143.70	109.75	99.78	89.70



### 6.2 Accessories for standard glass chips

This chapter highlights some basic accessories making the direct use of *microfluidic ChipShop* glass chip series convenient.

#### 6.2.1 Handling platform

This handling platform allows for the insertion of *microfluidic ChipShop*'s standard glass chips in the format of a microscopy slide, namely 75.5 mm x 25.5 mm x 1.65 mm. The fluidic interconnection is easily achieved by the fluidic interfaces integrated in the platform. For a standard use the fluidic interfaces – through holes on the chip, fluid connectors in the handling platform, are placed at standard positions having the spacing of a 386 well plate, namely 4.5 mm. This allows for a “one-fits-all” handling platform. Please refer to chapter 11.1 Lab-on-a-Chip Handling Platform/Cell Culture Incubator – LOC HP/CCI 1 for more information.



Fig. 398: Layout LOC HP/CCI 1 – Handling frame for chips in the format of a microscope slide

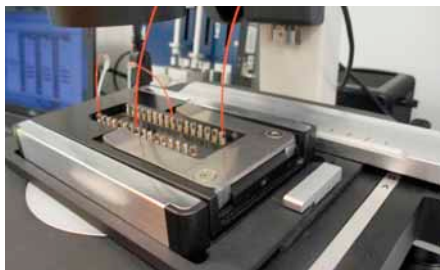

Fig. 399: LOC HP/CCI 1 is suitable for in-line imaging

Product Code	Description	Adapter plate			Price [€]
		2x4	2x8	2x16	
10000893	LOC HP/CCI – without heating elements – handling frame for glass chips (incl. one adapter plate of your choice)		1,370.00		1,370.00
10000699	LOC HP/CCI – with heating elements – handling frame for glass chips (incl. one adapter plate of your choice)		1,875.00		1,875.00
10001216	Additional adapter plate	390.00	390.00	390.00	390.00

#### 6.2.2 Stand alone interfaces: olive and female Mini Luer

*microfluidic ChipShop* developed stand alone interfaces to facilitate the application of tubing on through-holes interfaces. They come in olive and female Mini Luer interfaces. These stand alone interfaces can be easily glued on the chip. Please see page 8.1.11 Stand alone olive and chapter 8.1.12 Stand alone female Mini Luer for more information.





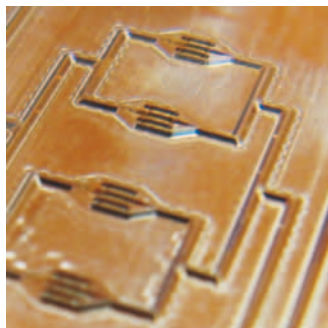
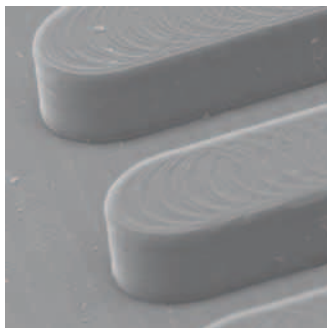
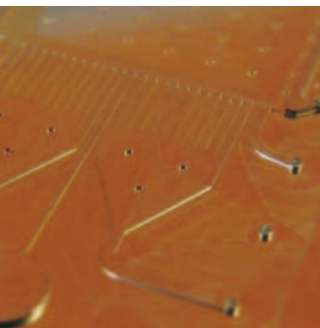

## 7 Silicone chips

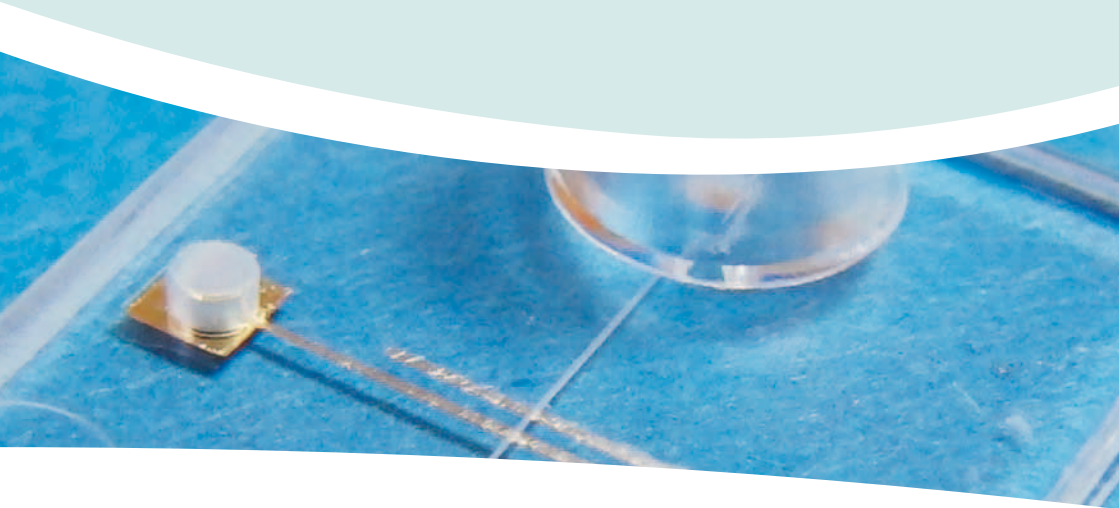

### Silicone chips

Our product range in silicone covers standard designs as well as tailor-made microfluidic devices.

The silicone parts can be delivered as silicone-only devices without a cover lid or bonded for example to glass, silicone, or polymers.

If you are interested in this service, please tell us your requirements and we will provide you with a quote.



### 7.1 Silicone chips and mold inserts

Within the silicone chip services portfolio a standard kit for easy fabrication of first silicone microfluidic chips is offered together with our partner GeSim within the brand name MicCell. Exceeding this service, *microfluidic ChipShop* offers for casting of PDMS custom-design silicon stampers.

#### 7.1.1 Silicone casting kit – MicCell

The MicCell system from our partner GeSim is a modular and versatile system to create individual PDMS microchannel setups and run own rapid prototyping experiments under the microscope. Its fluidic system is made of PDMS elastomer (silicone) – precast microchannel layers can be bought (called PDMS Channel Plates) or they can be self-made at user side with a special casting station. The system is easy to use, and if the entire periphery can be reused with new microfluidic channel designs. Items needed for the new microfluidic design are a new master and PDMS solution.

The modularity of the system allows to start with a small setup (also using existing syringe pumps) and grow bigger as required. Standard MicCells can be purchased in the sizes 22 mm x 22 mm and 25 mm x 75 mm; special designs (e. g. with microelectrodes) are available on request.

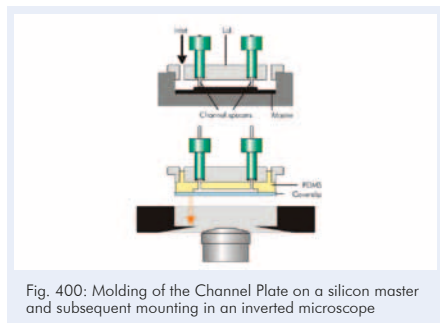

Fig. 400: Molding of the Channel Plate on a silicon master and subsequent mounting in an inverted microscope

##### 7.1.1.1 PDMS Channel Plate flow cells (precast, ready to use)

The Channel Plate (CP) is a precast silicone gel layer that comes with a polycarbonate body (lid) containing all necessary threaded holes so that it is ready to use. The channel is closed by a coverslip (that can be plain or equipped with a microarray, nanostructures, cultured cells, etc.). The use of the system is simple: Add tubes, insert the Channel Plate into the MicCell support, and place it in an inverted microscope. Plasma activation of the PDMS to seal the channel is usually not necessary. Different channel shapes are available; the S-shape, for instance, is an unbranched channel running from one corner to the other, for shear stress or other experiments. Other designs are available on request.

The polycarbonate (PC) body above the PDMS Channel Plate that contains all fluidic connections can be recycled.



Fig. 401: Channel Plate 22 mm x 22 mm with S-shaped single channel, precast, ready to use



Fig. 402: Channel Plate 22 mm x 22 mm with double-Y-branched channel, precast, ready to use



Fig. 403: MicCell support for 22x22 Channel Plates, to be placed in an inverted microscope via an adapter plate (not shown)

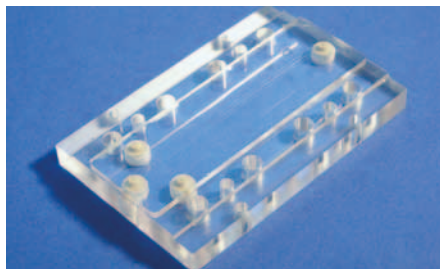

Fig. 404: Channel Plate 25x75 with crossed-shaped (T-junction) channel, different channel designs are available on request



Fig. 405: MicCell support for 25x75 Channel Plate

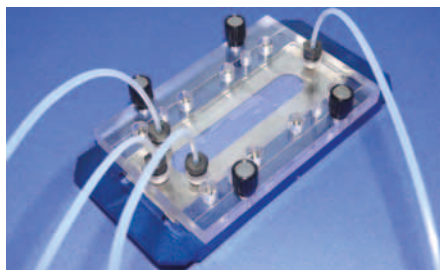

Fig. 406: Fully assembled MicCell with 25x75 Channel Plate, cross-shaped with 3 inlets and 1 outlet

Product Code	Description	Channel Design, Depth [ $\mu\text{m}$ ]	Price [€/chip]		
			1+	5+	10+
10000669	PDMS-CP/22x22/S-100	S-shape, 100 $\mu\text{m}$ deep	157.00	141.00	131.00
10000668	PDMS-CP/22x22/2Y-50	Double-Y-shape, 50 $\mu\text{m}$ deep	157.00	141.00	131.00
10000666	PDMS-CP/25x75/Cross-50	Cross shape, 50 $\mu\text{m}$ deep	273.00	246.00	225.00
10000667	MicCell support 22x22	to fix a PDMS-CP	819.00	733.00	682.00
10000663	MicCell support 25x75	to fix a PDMS-CP	819.00	733.00	682.00



### 7.1.1.2 Accessories for the PDMS Channel Plate

With these products individual flow cells can be cast. The casting station comes with an overview on the technology, detailed hands-on instructions, PC-bodies, channel spacers and one liter of Sylgard 184 two-component PDMS solution (base and curing agent); a microstructured master for molding must be ordered separately. You also need single-use glassware and syringes with needles to prepare and inject the PDMS mixture, a pump and desiccator for degassing, and an oven for curing. An initial set of mixing glasses, syringes and needles is included in the box.



Fig. 407: Polycarbonate (PC) body 22 mm x 22 mm

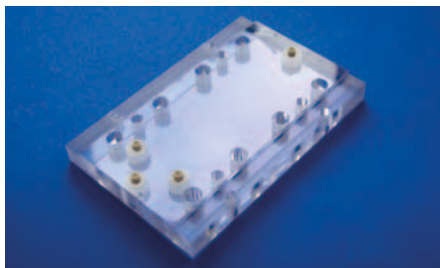

Fig. 408: Polycarbonate (PC) body 25 mm x 75 mm

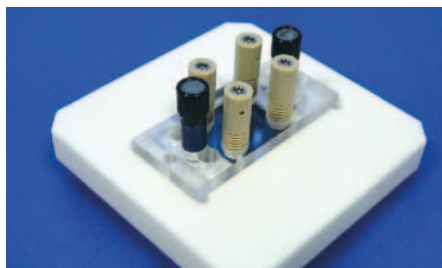

Fig. 409: Casting Station 22 mm x 22 mm. Top: assembled, including channel spacers (brown)

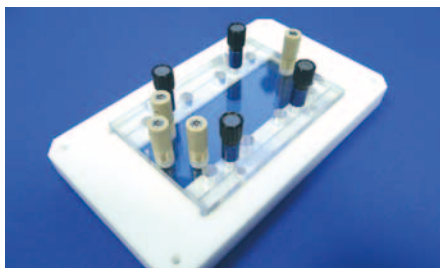

Fig. 410: Casting Station 25 mm x 75 mm



Fig. 411: Casting Station box



Product Code	Description	Design	Price [€]		
			1+	10+	20+
10000989	polycarbonate-body, 22 x 22 mm / 4	22 mm x 22 mm, 4 inlets 1/4-28 UNF	89.00	79.00	73.00
10000643	polycarbonate-body, 25 x 75 mm / 6	25 mm x 75 mm, 6 inlets 1/4-28 UNF	204.00	170.00	152.00
10001217	Casting station box 22 x 22 mm	casting station for 22 x 22 mm PDMS-CP, accessories*, technology description	2,173.00	1,942.00	1,873.00
10000642	Casting station box 25 x 75 mm	casting station for 25 x 75 mm PDMS-CP, accessories*, technology description	2,879.00	2,572.00	2,451.00
10001218	Custom specific silicon master structure	Channel design with depth 10-50 $\mu\text{m}$ , width > height	2,490.00		

\* Set of PDMS-CPs, channel spacers, mixing glasses, syringes, needles

## 7.2 Silicon master structures

For casting of silicone *microfluidic ChipShop* offers 4 inch (100 mm diameter) silicon wafer. The wafer can be ordered with 1 – 3 channel depth differing in pricing.

Following design rules need to be considered:

- Wafer size: 4 inch
- Wafer thickness: 700  $\mu\text{m}$
- Minimum feature size: 10  $\mu\text{m}$ , less upon request at extra cost
- Maximum structure depth: 50  $\mu\text{m}$
- Maximum aspect ratio: < 1

CAD files need to be delivered in the following format: dwg, dxf

Product Code	Description	Price [€/unit]		
		1+	3+	10+
10001219	One structure depth	2,490.00	2,290.00	1,980.00
10001220	Two structure depths	5,980.00	5,250.00	4,700.00
10001221	Three structure depths	10,450.00	9,550.00	8,750.00

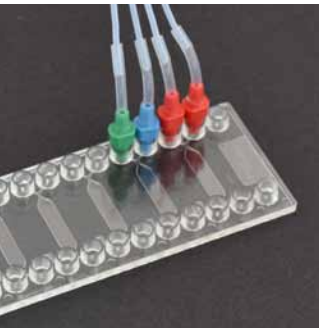
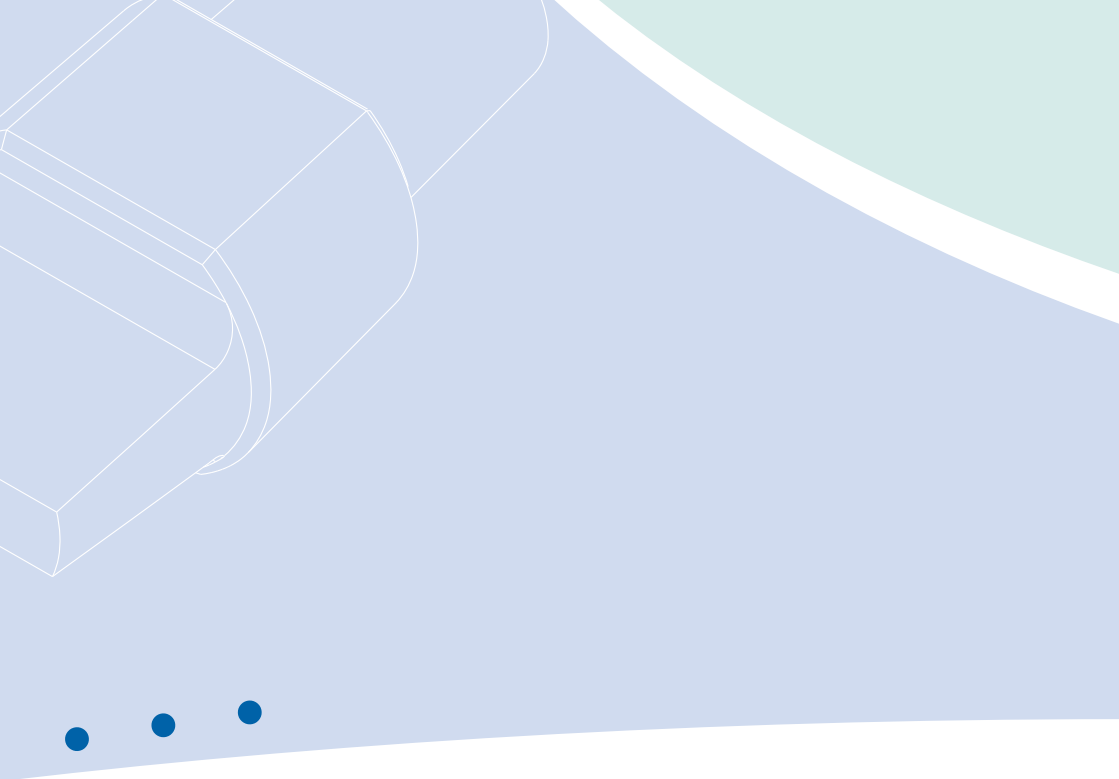



## 8 Accessories



### Accessories

With the help of our *Lab-on-a-Chip Catalogue*, it is our aim to ensure that you have all the necessary equipment for an easy and immediate start with our microfluidic products. This includes not only our wide variety of off-the-shelf microfluidic chips but also all accessories required to run microfluidic chips, such as fluidic interfaces, tubings, complete accessory kits, and special reagents.

If you have any additional wishes that might help you with your microfluidic work, please do not hesitate to contact us.



### 8.1 Fluidic interfaces

The use of lab-on-a-chip devices routinely requires interfaces between the chip and the macroscopic world. Our fluidic interfaces enable easy and well-proven chip-to-world interfacing.

**Material matters:** We offer the fluidic interfaces and plugs in different materials. Whereas PP is a harder material that is easy to use for interfacing with tubes, TPE as soft material allows for an easy closing of the interfaces without applying much pressure. Whilst too heavy forces applied by the user himself on the PP interfaces can damage the chip, the TPE interfaces will withstand such handling.

#### 8.1.1 Male Mini Luer fluid connectors

In order to cope with minimized footprints, a merger of the miniaturization with well-proven fluidic interfaces from the medical world has been realized, resulting in our Mini Luer connectors. These allow *microfluidic ChipShop's* Mini Luer fluidic platforms to connect with tubes or, integrated in an instrument, directly with the instrument.

The male Mini Luer fluid connectors are the means to connect female Mini Luer platforms with tubing to connect for example pumps, valves, or waste reservoirs. They are offered as single interfaces, twins, or as rows of four. Furthermore, they are available in different colors for an easy differentiation between different liquids going in and out of the chip.

Male Mini Luer connectors have a dead volume of approximately 8  $\mu\text{l}$ .

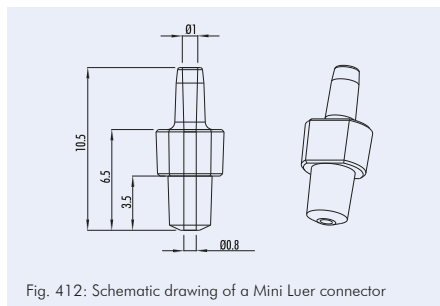

Fig. 412: Schematic drawing of a Mini Luer connector

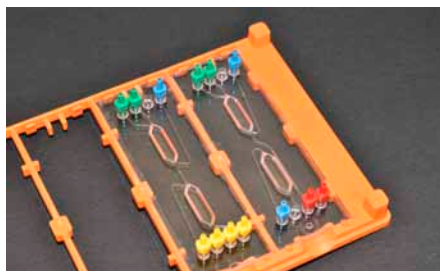

Fig. 413: Single, twin type Mini Luer connectors and row of four

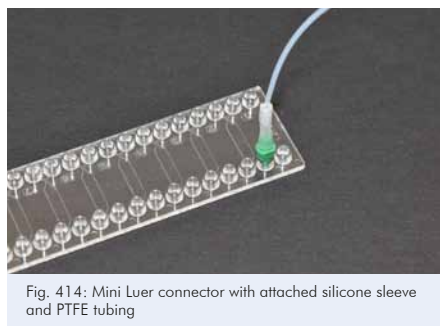

Fig. 414: Mini Luer connector with attached silicone sleeve and PTFE tubing

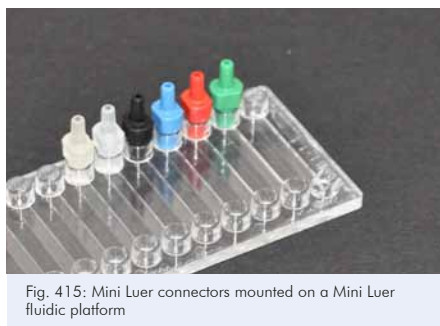

Fig. 415: Mini Luer connectors mounted on a Mini Luer fluidic platform



Product Code	Connector Type	Material	Color	Price [€/10 pieces]			
				1+	5+	10+	20+
1000094	Single	PP	Opaque	19.00	14.00	9.40	7.40
1000095	Single	PP	Yellow	19.00	14.00	9.40	7.40
1000064	Single	PP	Red	19.00	14.00	9.40	7.40
1000029	Single	PP	Green	19.00	14.00	9.40	7.40
1000096	Single	PP	Blue	19.00	14.00	9.40	7.40
1000097	Single	PP	Black	19.00	14.00	9.40	7.40
10000425	Twin	PP	Opaque	19.00	14.00	9.40	7.40
10000370	Twin	PP	Yellow	19.00	14.00	9.40	7.40
10000460	Twin	PP	Red	19.00	14.00	9.40	7.40
10000409	Twin	PP	Green	19.00	14.00	9.40	7.40
10000670	Twin	PP	Blue	19.00	14.00	9.40	7.40
10000671	Twin	PP	Black	19.00	14.00	9.40	7.40
10000321	Row of four	PP	Opaque	19.00	14.00	9.40	7.40
10000305	Row of four	PP	Yellow	19.00	14.00	9.40	7.40
10000416	Row of four	PP	Red	19.00	14.00	9.40	7.40
10000461	Row of four	PP	Green	19.00	14.00	9.40	7.40
10000551	Row of four	PP	Blue	19.00	14.00	9.40	7.40
10000672	Row of four	PP	Black	19.00	14.00	9.40	7.40
10000116	Single	TPE	Opaque	19.00	14.00	9.40	7.40
10000117	Twin	TPE	Opaque	19.00	14.00	9.40	7.40
10000118	Row of four	TPE	Opaque	19.00	14.00	9.40	7.40

### 8.1.2 Male Mini Luer plugs

The male Mini Luer plugs are the means to close the female Mini Luer interfaces on our fluidic platforms. As the Mini Luer fluid connectors, they are offered as single units, twins, or as rows of four. Furthermore, they are available in different colors for an easy differentiation between different input and output ports. They are offered in a hard polymer (PP) and a soft polymer (TPE).

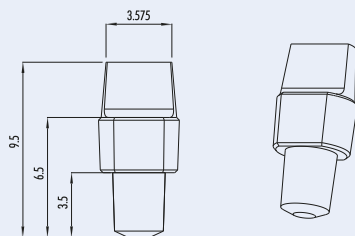

Fig. 416: Schematic drawing of a Mini Luer plug

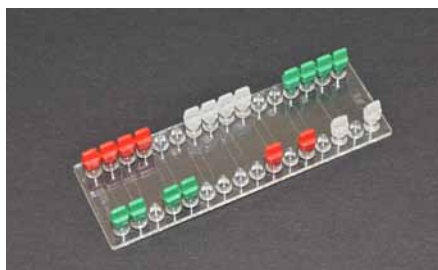

Fig. 417: Single, twin type Mini Luer plugs and row of four



Product Code	Plug Type	Material	Color	Price [€/10 pieces]			
				1+	5+	10+	20+
1000030	Single	PP	Opaque	19.00	14.00	9.40	7.40
1000053	Single	PP	Red	19.00	14.00	9.40	7.40
1000052	Single	PP	Green	19.00	14.00	9.40	7.40
10000179	Twin	PP	Opaque	19.00	14.00	9.40	7.40
10000180	Twin	PP	Red	19.00	14.00	9.40	7.40
10000181	Twin	PP	Green	19.00	14.00	9.40	7.40
10000345	Row of four	PP	Opaque	19.00	14.00	9.40	7.40
10000378	Row of four	PP	Red	19.00	14.00	9.40	7.40
10000055	Row of four	PP	Green	19.00	14.00	9.40	7.40
10000054	Single	TPE	Opaque	19.00	14.00	9.40	7.40
10000119	Twin	TPE	Opaque	19.00	14.00	9.40	7.40
10000056	Row of four	TPE	Opaque	19.00	14.00	9.40	7.40

### 8.1.3 Male Mini Luer plugs – Low volume displacement plugs

These special male Mini Luer plugs are designed to fit female Mini Luer interfaces. They seal the connecting hole, while at the same time liquid movement is avoided due to minimal air or liquid displacement.

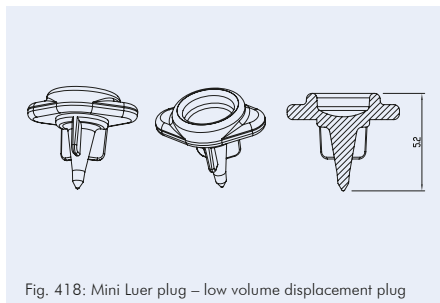

Fig. 418: Mini Luer plug – low volume displacement plug



Fig. 419: Mini Luer plug – low volume displacement plug

Product Code for Fluidic 438	Description	Plug Type	Material	Color	Price [€/10 pieces]			
					1+	5+	10+	20+
10000280	Male Mini Luer plugs – Low volume displacement	Single	PP	Red	19.00	14.00	9.40	7.40
10000205	Male Mini Luer plugs – Low volume displacement	Single	TPE	Opaque	19.00	14.00	9.40	7.40
10001291	Male Mini Luer plugs – Low volume displacement	Single	TPE	Green	19.00	14.00	9.40	7.40



### 8.1.4 One-wing male Mini Luer plugs – Low volume displacement plugs

The one-wing version of the male Mini Luer low volume displacement plugs has been realized for narrow features placed on the microfluidic device. The one-wing plugs can be placed nicely in dense arrays of female Mini Luer interfaces on chip, are easy to handle and close safely the matching counterpart on chip.

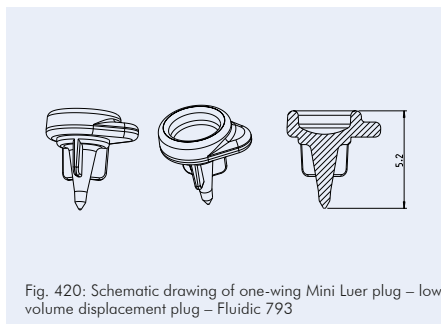

Fig. 420: Schematic drawing of one-wing Mini Luer plug – low volume displacement plug – Fluidic 793



Fig. 421: One-wing Mini Luer plug – low volume displacement plug – Fluidic 793

Product Code for Fluidic 793	Description	Plug Type	Material	Color	Price [€/10 pieces]			
					1+	5+	10+	20+
10001067	One-wing Mini Luer low volume displacement plug	Single	PP	Red	19.00	14.00	9.40	7.40
10001068	One-wing Mini Luer low volume displacement plug	Single	TPE	Opaque	19.00	14.00	9.40	7.40
10001105	One-wing Mini Luer low volume displacement plug	Single	TPE	Red	19.00	14.00	9.40	7.40

### 8.1.5 Mini Luer to pipette adapter

The Mini Luer to pipette adapters allow a flush sealing of a pipette tip to a chip equipped with a Mini Luer interfaces. This enables the realization of higher applied fluidic pressures, as well as a reduced contamination risk.

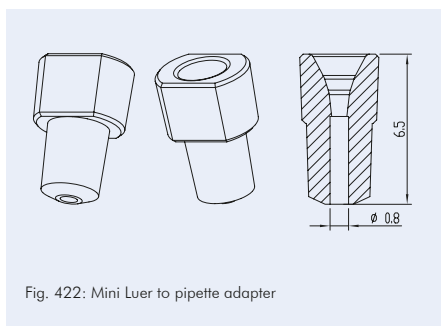

Fig. 422: Mini Luer to pipette adapter

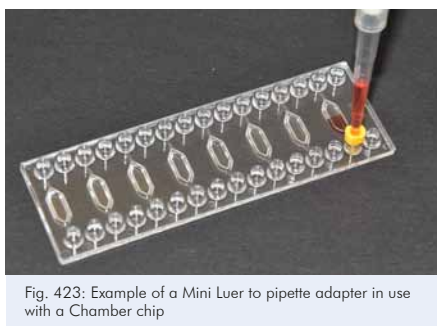

Fig. 423: Example of a Mini Luer to pipette adapter in use with a Chamber chip

Product Code	Description	Material	Price [€/10 pieces]	
			1+	10+
10000057	Mini Luer to pipette adapter	PP	19.00	9.40



### 8.1.6 Syringe adapter

The syringe adapter can be used to connect any standard laboratory syringe with male Luer interface to tubing. Each syringe adapter has a length of 55 mm, an tip inner diameter of 0.5 mm and an outer diameter of 1.7 mm. This product can be ordered as single item or in packs of 50 items.



Fig. 424: Syringe adapter connected to a 10 ml syringe



Fig. 425: Syringe adapter interconnecting a 1 ml syringe and silicone sleeve of microfluidic tubing

Product Code	Description	Material	Price [€]
10000614	Syringe adapter; 1 piece	PP	2.50
10000360	Syringe adapters; pack of 50 pieces	PP	76.00

### 8.1.7 Mini Luer to Luer adapter

The Mini Luer to Luer adapters allow the connection of devices with a standard male Luer connector (e.g. a syringe) to a chip with Mini Luer interfaces. Due to the size of the Luer connector, only every second Mini Luer port can be utilized with this adapter.

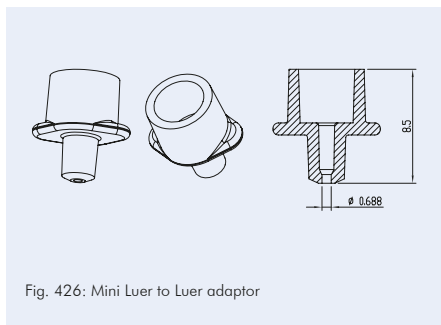

Fig. 426: Mini Luer to Luer adaptor



Fig. 427: Example of a Mini Luer to Luer adaptor in use with a straight channel chip

Product Code	Description	Material	Price [€/10 pieces]
10000063	Mini Luer to Luer adapter	PP	1+ 10+ 19.00 9.40



### 8.1.8 Female Luer lock compatible connectors

Our female Luer lock compatible connectors are tools for chip prototyping. These devices can be mounted on the microfluidic chips and are compatible with standard male Luer and Luer lock adapters as for example used for syringes. This enables also prototyped chips, usually chips with directly milled structures, or glass and silicon microfluidic devices to make use of standard fluidic interfaces. The diameter of the through hole is 1.3 mm.

The connectors are available with straight walls (product code 10000227) or a wide base for easier glueing (product code 10000013).

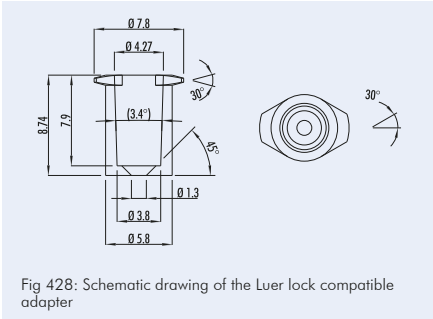

Fig 428: Schematic drawing of the Luer lock compatible adapter



Fig. 429: Female Luer lock connector with straight walls

Product Code	Material	Price [€/10 pieces]			
		1+	5+	10+	20+
10000227	PMMA	30.00	25.00	20.00	15.00
10000228	Topas	30.00	25.00	20.00	15.00
10000229	PC	30.00	25.00	20.00	15.00

The female Luer lock compatible connectors can be fixed on the microfluidic chip either by applying glue or using a double sided adhesive tape. Such adhesive rings can be ordered in connection with the fluidic interfaces.

Product Code	Description	Price [€/unit] – 1 unit = 10 adhesive rings	
		1+	10+
10000715	Adhesive ring Fluidic 697 - for female Luer lock compatible interface (Fluidic 302)	18.40	7.89

### 8.1.9 Female Luer connector – 90° angle for horizontal operation

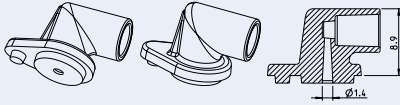

Fig. 430: Female Luer for horizontal syringe integration – schematic drawing of Fluidic 544



Fig. 431: Female Luer lock connector for horizontal syringe operation

Product Code	Description	Material	Price [€/10 pieces]			
			1+	5+	10+	20+
10001073	Female Luer connector - 90° angle for horizontal operation (Fluidic 544)	PMMA	30.00	25.00	20.00	15.00
10001074	Female Luer connector - 90° angle for horizontal operation (Fluidic 544)	Topas	30.00	25.00	20.00	15.00
10001075	Female Luer connector - 90° angle for horizontal operation (Fluidic 544)	PC	30.00	25.00	20.00	15.00

### 8.1.10 Female Luer lock compatible connectors with wide base

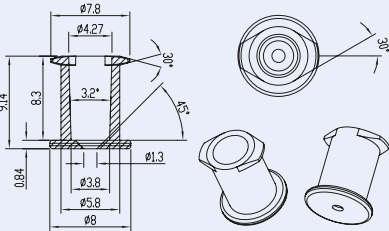

Fig. 432: Schematic drawing of female Luer lock compatible connectors with wide base



Fig. 433: Female Luer lock connector with wide base

Product Code	Material	Price [€/10 pieces]			
		1+	5+	10+	20+
10000013	PMMA	30.00	25.00	20.00	15.00
10000014	Topas	30.00	25.00	20.00	15.00
10000015	PC	30.00	25.00	20.00	15.00

The female Luer lock compatible connectors with wide base can be fixed on the microfluidic chip either by applying glue or using a double sided adhesive tape. Such adhesive rings can be ordered in connection with the fluidic interfaces.

Product Code	Description	Price [€/unit] – 1 unit = 10 adhesive rings	
		1+	10+
10000716	Adhesive ring Fluidic 698 - for female Luer lock compatible interface wide base (Fluidic 303)	18.40	7.89





### 8.1.11 Stand alone olive

Through-holes are the common interface for most glass chips and a few polymer chips. Given its plain structure, the interface might pose some issues when connecting tubes. *microfluidic ChipShop* developed stand alone olives to solve this. Stand alone olives serve as an adapter to the through-hole interface and can be easily glued on it.

Product Code	Description	Material	Price [€/10 pieces]			
			1+	5+	10+	20+
10000700	Stand-alone olive - fluidic interface to be glued on chip	PP	19.00	14.00	9.40	7.40

The stand-alone olive fluidic interfaces can be fixed on the microfluidic chip either by applying glue or using a double sided adhesive tape. Such adhesive rings can be ordered in connection with the fluidic interfaces.

Product Code	Description	Price [€/unit] – 1 unit = 10 adhesive rings	
		1+	10+
10000717	Adhesive ring Fluidic 699 - for stand alone chip connector - female Mini Luer interface (Fluidic design 631) and olive interface (Fluidic design 630)	18.40	7.89

### 8.1.12 Stand alone female Mini Luer

The solution for the through-hole interface is also available as female Mini Luer interface. This offers another ready-to-use adapter beside the stand alone olive.

Product Code	Description	Material	Price [€/10 pieces]			
			1+	5+	10+	20+
10000701	Stand-alone female Mini Luer - fluidic interface to be glued on chip	PP	19.00	14.00	9.40	7.40

The female Mini Luer interfaces can be fixed on the microfluidic chip either by applying glue or using a double sided adhesive tape. Such adhesive rings can be ordered in connection with the fluidic interfaces.

Product Code	Description	Price [€/unit] – 1 unit = 10 adhesive rings	
		1+	10+
10000717	Adhesive ring Fluidic 699 - for stand alone chip connector - female Mini Luer interface (Fluidic design 631) and olive interface (Fluidic design 630)	18.40	7.89

### 8.1.13 Male Luer plugs

The male Luer plugs enable closing of female Luer and Luer lock interfaces on our fluidic platforms. With the help of these plugs, liquid can be moved with the female Luer interface into the fluidic channels on chip, and the fluidic interface itself is safely closed in order to avoid a contamination risk.

A version with retaining strip allows to directly attach the Male Luer plug to a lab-on-a-chip device with a suitable counterpart for the pin at the end of the strip. This is a convenient method to ensure an easy handling of the overall device.



Fig. 434: Male Luer plug



Fig. 435: Male Luer plugs with retaining strip in black and opaque

Alternatively, a version of the Luer plug is available, which has a reduced plug length and thus displaces less volume in the Luer interface when applied. While the standard Luer plug displaces a volume of approx.  $55 \mu\text{l}$ , the reduced height Luer plug only displaces  $20 \mu\text{l}$ .

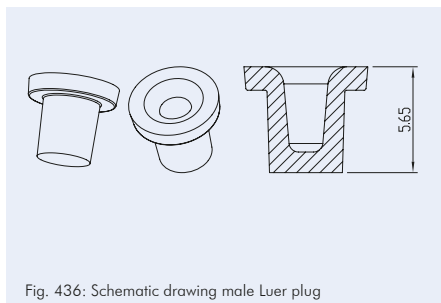

Fig. 436: Schematic drawing male Luer plug



Fig. 437: Male Luer plugs in black and opaque

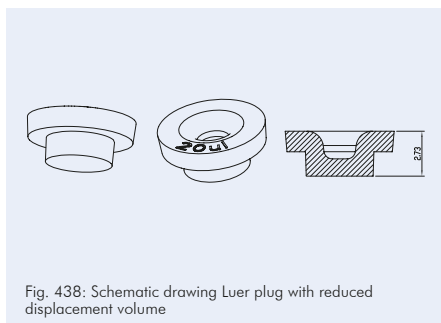

Fig. 438: Schematic drawing Luer plug with reduced displacement volume



Fig. 439: Luer plug with reduced displacement volume



Product Code	Description	Material	Price [€/10 pieces]	
			1+	10+
10000230	Male Luer plug, opaque	PP	19.00	9.40
10000231	Male Luer plug, black	PP	19.00	9.40
10000084	Male Luer plug with retaining strip, opaque	PP	25.00	14.40
10000083	Male Luer plug with retaining strip, black	PP	25.00	14.40
10000082	Male Luer plug with reduced displaced volume, opaque	PP	25.00	14.40

### 8.1.14 Male Luer fluid connectors

Male Luer fluid connectors are the tool used to couple female Luer interfaces on fluidic platforms to tubing deriving from pumps, valves or reservoirs.

An important feature of these connectors is the massively reduced dead volume compared to conventional interfaces. This also allows for smooth pumping from the liquid reservoir to the chip without huge pressure drops due to massively different channel diameters on and off chip.

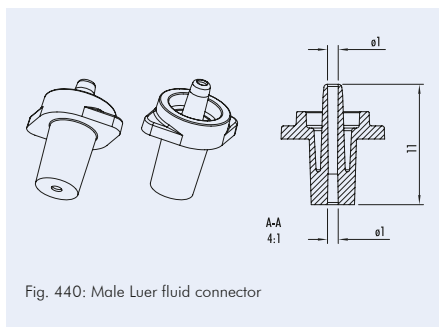

Fig. 440: Male Luer fluid connector

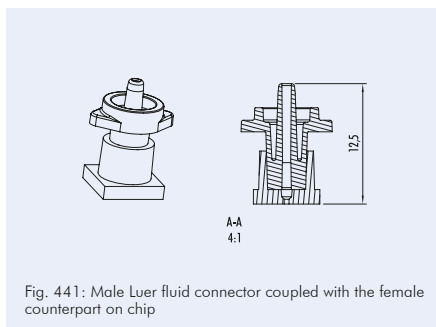

Fig. 441: Male Luer fluid connector coupled with the female counterpart on chip



Fig. 442: Male Luer fluid connector with olive interface



Fig. 443: Male Luer fluid connector with olive interface mounted on chip

Product Code	Description	Price [€/10 pieces]	
		1+	10+
10000080	Male Luer fluid connector, opaque	25.00	14.40
10000081	Male Luer fluid connector, green	25.00	14.40



### 8.1.15 NanoPort Assembly

Our NanoPort Assembly will readily connect 1/16" OD tubing with the included fittings. To connect 1/32" OD or 360  $\mu\text{m}$  OD, tubing sleeves for each size are included in each assembly.

Adhesive is not included in the N-333 NanoPort Assembly. Please be advised that the footprint of the NanoPort is 8.4 mm.



Fig. 444: NanoPorts Assembly family

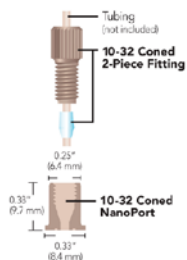

Fig. 445: N-333 NanoPort

Product Code	Comment	Price [€/piece]	
		1+	10+
10000972	N-333 NanoPort	37.00	32.10

### 8.1.16 LabSmith CapTite™ components for fluidic interfaces

CapTite components are designed for high-pressure and low dead volumes. They can be used on microfluidic chips containing simple holes as access ports such as the straight channel chips in chapter 3.2.1.1 (product codes 10000036 to 10000188) or cross-shaped channel chips in chapter 3.4.1.1 (product codes 10000168 to 10000167). They can be interfaced directly with LabSmith's hardware such as syringe pumps and valves (for hardware details see [www.labsmith.com](http://www.labsmith.com)). An example of a cross-shaped channel chip with three bonded port connectors and three chip reservoirs is shown below.

A choice of different components is available allowing for various connection options. This includes:

- **Bonded port connectors:** Bonds to port on chip for capillary-chip interface. Compatible with approx. 1 mm port size. Material: Ultem
- **Chip reservoir:** Threads into bonded port connector to provide 85  $\mu\text{l}$  fluid reservoir. Also connects to Luer tip syringe for low pressure connection.
- **Luer lock adapter:** Female fitting for connecting syringe to 360  $\mu\text{m}$  OD capillary. Material: PEEK.
- **One piece fitting:** For connecting 360  $\mu\text{m}$  OD capillary to CapTite components. Material: PEEK.
- **One piece plug:** For plugging unused CapTite ports. Material: PEEK.
- **Complete LabSmith connection kit:** The kit contains besides 15 **bonded port connectors**, 15 **one piece fittings**, 5 **one piece plugs**, 5 **chip reservoirs** and 2 **Luer lock adaptors** all accessories needed to mount the devices on a chip such as **epoxy adhesive** and a **wrench** for the CapTite connectors as well as **360  $\mu\text{m}$  OD capillary** to connect the chip to peripherals.
- **Cross-shaped channel chips** with integrated threads.



Fig. 446: Cross-shaped channel chip with three bonded port connectors and three chip reservoirs



Fig. 447: Bonded port connector



Fig. 448: Female Luer lock adapter



Fig. 449: One piece plug (left) and one piece fitting (right)

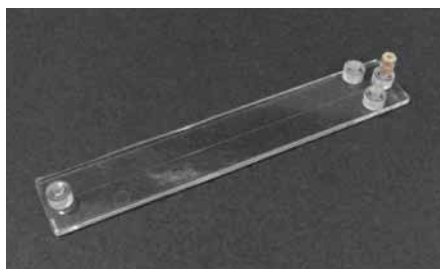

Fig. 450: Cross-shaped channel chips with embedded threads to connect with LabSmith's one piece fittings

Product Code	Description	Material	Price [€]	
			1+	10+
10000391	Bonded Port Connector	Ultem	8.50	7.95
10000909	Chip Reservoir	PEEK	9.90	9.00
10000315	Luer lock Adapter	PEEK	29.00	26.00
10000404	One piece fitting	PEEK	9.90	9.00
10000418	One piece plug	PEEK	7.50	6.90
10000698	Complete LabSmith connection kit. Contains 15 bonded port connectors, 15 one piece fittings, 5 one piece plugs, 5 chip reservoirs, 2 Luer-Lock adaptors, 1 m 360 $\mu$ m OD PEEK capillary, 12 ml epoxy adhesive, 1/8" hex wrench		470.00	425.00
10000178	Cross-shaped channel chip with threads in the fluidic interface to connect with LabSmith one piece fitting (10000404)	PMMA	62.40	43.60

### 8.2 Liquid storage

One issue that often occurs with microfluidics is the storage of liquid reagents on chip. This frequently conflicts with either dry-stored reagents on the chip, the available space, or the volume of the liquid. *microfluidic ChipShop* has developed several solutions to deal with this issue, including our so-called “tank” solution, as well as blister pouches.



Fig. 451: Tanks mounted on a microfluidic chip



Fig. 452: Blister pouches of different volumes integrated in a complex microfluidic chip

#### 8.2.1 Tanks

The “tank” solution allows the storage of liquids in separate tanks, which are simply plugged onto the chip. The openings can be sealed with a heat-sealing aluminum foil, which is piercable. Liquid actuation can also be done via tanks either by a mechanical piston or pneumatic pressure.

Tanks are provided either with an open top or can be closed with an attached cap. This cap can furthermore possess various features, such as a Mini Luer interface for pneumatic actuation or an integrated venting membrane. Below an overview of available tanks and their most important features is given.

Fluidic Design	Volume [μl]	Tank Format	Tank to Chip Interface Type	Cap	Design Feature
933	200	Single	Luer	Yes	-
934	200	Single	Luer	Yes	Mini Luer interface in cap
833	200	Single	Luer	Yes	Venting cap
926	200	Single	Mini Luer	Yes	-
387	500	Single	Luer	No	-
388	500	Double	Luer	No	-
389	500	Triple	Luer	No	-
823	500	Single	Luer	No	Large opening
824	500	Double	Luer	No	Large opening
825	500	Triple	Luer	No	Large opening
229	500	Single	Piercing interface	No	-
230	500	Double	Piercing interface	No	-
231	500	Triple	Piercing interface	No	-
639	500	Single	Luer	Yes	Mini Luer interf. in cap; venting membrane opt.
603	1000	Row of four	Luer	No	-
232	4500	Row of four	Luer	No	-
233	4500	Row of four	Luer	Yes	Mini Luer interface in cap
234	4500	Row of four	Large interaction	No	-
235	4500	Row of four	Large interaction	Yes	Mini Luer interface in cap



### 8.2.1.1 Tank 200 $\mu\text{l}$ with cap

This tank version with a volume of 200  $\mu\text{l}$  can be closed with a cap. With its embedded Luer interface, the tank can be easily mounted on chip.

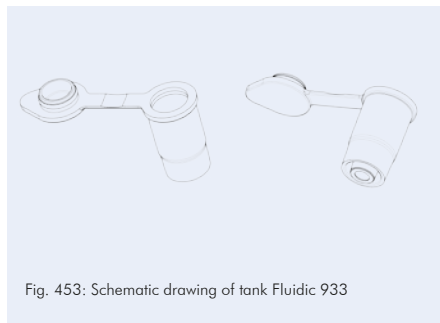

Fig. 453: Schematic drawing of tank Fluidic 933

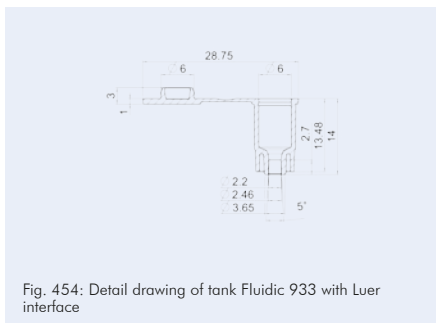

Fig. 454: Detail drawing of tank Fluidic 933 with Luer interface

Product Code for Fluidic 933	Description	Material	Price [€/10 pieces]		
			1+	10+	100+
10001094	200 $\mu\text{l}$ tank with cap	PP	25.00	10.20	5.40
10001095	200 $\mu\text{l}$ tank with cap	PP - black	25.00	10.20	5.40

### 8.2.1.2 Tank 200 $\mu\text{l}$ with Mini Luer interface cap

Being similar in design, this tank also holds a volume of 200  $\mu\text{l}$  and possesses a Luer interface, like tank Fluidic 933. Additionally, tank Fluidic 934 is equipped with a Mini Luer interface in its cap. This enables easy liquid or air pressure supply.

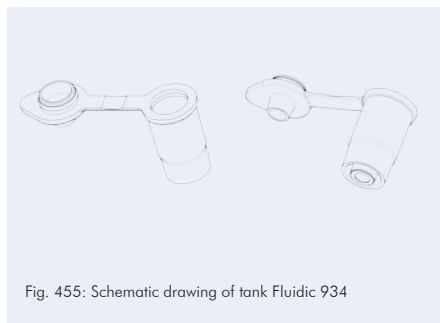

Fig. 455: Schematic drawing of tank Fluidic 934

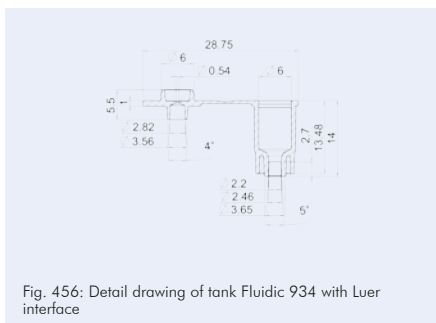

Fig. 456: Detail drawing of tank Fluidic 934 with Luer interface

Product Code for Fluidic 934	Description	Material	Price [€/10 pieces]		
			1+	10+	100+
10001096	200 $\mu\text{l}$ tank with Mini Luer cap	PP	25.00	10.20	5.40
10001097	200 $\mu\text{l}$ tank with Mini Luer cap	PP - black	25.00	10.20	5.40

### 8.2.1.3 Tank 200 $\mu\text{l}$ with cap with venting function

With its Luer interphase this 200  $\mu\text{l}$  tank can be easily mounted on chip. This tank for venting purposes is available in two different versions: one version possessing a venting hole in its lid, while the other one is equipped with an additional venting membrane.



Fig. 457: Schematic drawing of tank Fluidic 833

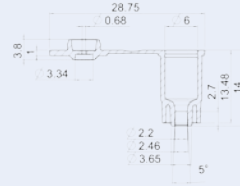

Fig. 458: Detail drawing of tank Fluidic 833 with cap for venting purposes

Product Code for Fluidic 833	Description	Material	Price [€/10 pieces]		
			1+	10+	100+
10000991	200 $\mu\text{l}$ tank with venting-cap – Fluidic 833	PP	25.00	10.20	5.40
10001076	200 $\mu\text{l}$ tank with vening cap incl. venting membrane – Fluidic 833	PP	40.00	25.20	9.40

### 8.2.1.4 Tank 200 $\mu\text{l}$ with Mini Luer interface

With its male Mini Luer interface, this tank can be mounted on many of our standard microfluidic chips that feature Mini Luer interfaces. The tank can hold up to 200  $\mu\text{l}$  and has two male Mini Luer interfaces for a stable mounting performance. However, please note, only one interface is serving liquid supply, while the other solely enhances mounting stability.

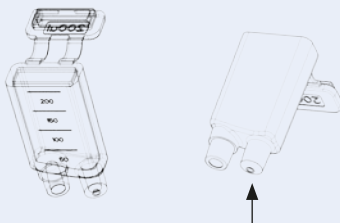

Fig. 459: Schematic drawing of 200  $\mu\text{l}$  tank Fluidic 926. The functional Mini Luer interface is marked with an arrow.

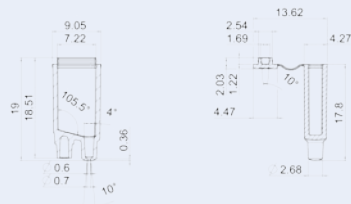

Fig. 460: Detail drawing of tank Fluidic 926 with Mini Luer interfaces for easy on-chip fitting



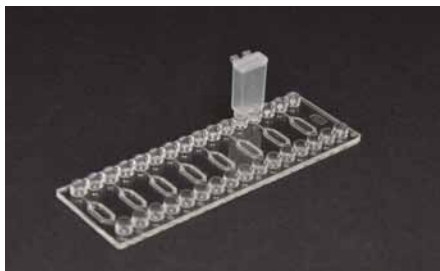

Fig. 461: The 200 µl tank Fluidic 926 can be easily mounted on chip with its Mini Luer interfaces



Fig. 462: Filled 200 µl Tank mounted on Mini Luer interface

Product Code for Fluidic 926	Description	Material	Price [€/10 pieces]		
10001315	200 µl tank with Mini Luer interface	PP	1+	10+	100+
			25.00	10.20	5.40

### 8.2.1.5 Tank 500 µl with Luer interface

This tank version with a tank volume of 500 µl has a male Luer interface to connect to any chip with a female Luer port. If the tank has sealed output, the chip has to have a piercing element to breach the sealing film. The 500 µl Luer tank is available in a single, double or triple tank version.

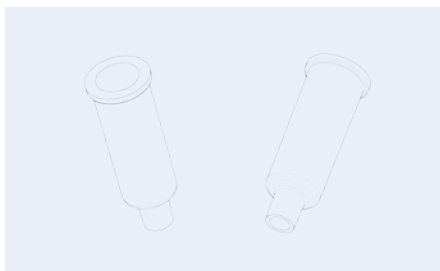

Fig. 463: 500 µl single tank Fluidic 387 with Luer interface

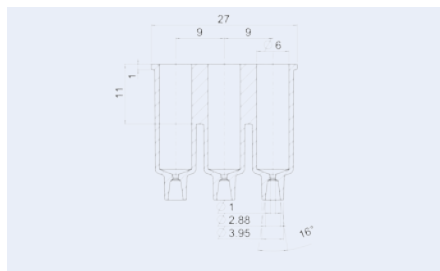

Fig. 464: 500 µl triple tank with Luer interface



Fig. 465: 500 µl triple tanks – opaque and black



Fig. 466: 500 µl single tank mounted on Luer interface



Product Code	Fluidic	Description	Material	Price [€/10 pieces]		
				1+	10+	100+
10000281	387	Single tank Luer interface	PP	25.00	10.20	5.40
10000282	388	Double tank Luer interface	PP	26.00	11.80	5.80
10000283	389	Triple tank Luer interface	PP	27.00	12.40	6.10
10000431	387	Single tank Luer interface - black	PP - black	25.50	10.70	5.90
10000612	388	Double tank Luer interface - black	PP - black	26.50	12.30	6.30
10000613	389	Triple tank Luer interface - black	PP - black	27.50	12.90	6.60

### 8.2.1.6 Tank 500 $\mu$ l with Luer interface – Large opening

This tank version with a tank volume of 500  $\mu$ l has a male Luer interface to connect to any chip with a female Luer port. If the tank has sealed output, the chip has to have a piercing element to breach the sealing film. The 500  $\mu$ l Luer tank is available in a single, double or triple tank version.

The large opening at the interface to the microfluidic chip allows a nice liquid supply and minimizes diameter changes in the liquid column in the tank.

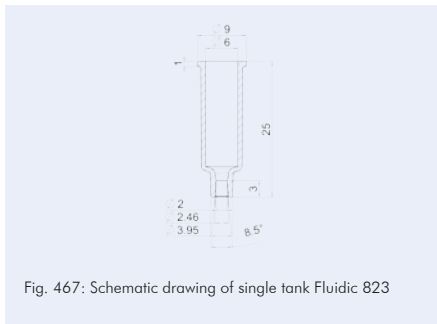

Fig. 467: Schematic drawing of single tank Fluidic 823

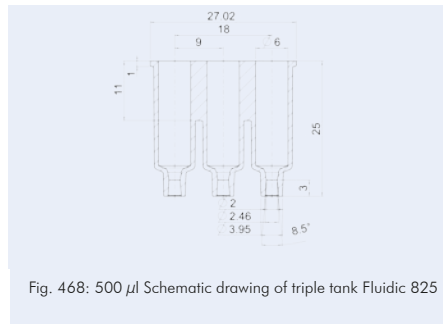

Fig. 468: 500  $\mu$ l Schematic drawing of triple tank Fluidic 825

Product Code	Description	Material	Price [€/10 pieces]		
			1+	10+	100+
10000960	Single tank Luer interface – large opening – Fluidic 823	PP	25.00	10.20	5.40
10000977	Double tank Luer interface – large opening – Fluidic 824	PP	26.00	11.80	5.80
10000978	Triple tank Luer interface – large opening – Fluidic 825	PP	27.00	12.40	6.10
10000993	Single tank Luer interface – large opening – Fluidic 823 - black	PP	25.50	10.70	5.90
10000994	Double tank Luer interface – large opening – Fluidic 824 - black	PP	26.50	12.30	6.30
10000995	Triple tank Luer interface – large opening – Fluidic 825 - black	PP	27.50	12.90	6.60



### 8.2.1.7 Tank 500 $\mu\text{l}$ with piercing interface

This tank version, which exists in single, double, and triple tank versions, has a volume of 500  $\mu\text{l}$  and is 25 mm high. The sealed tank is clipped onto a chip, which has to have a suitable piercing interface to pierce the sealing film.



Fig. 469: Single, double, and triple tank



Fig. 470: Filled tanks sealed with alumina foil

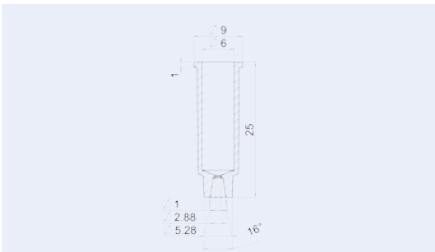

Fig. 471: Single tank Fluidic 229 with interface for piercing applications

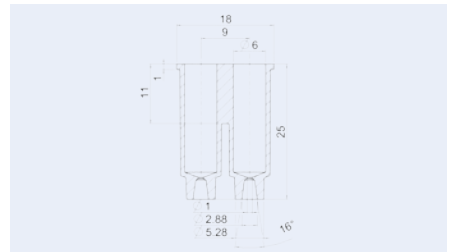

Fig. 472: Double tank Fluidic 230

Product Code	Fluidic	Description	Material	Price [€/10 pieces]		
				1+	10+	100+
10000102	229	Single tank piercing interface	PP	25.00	10.20	5.40
10000103	230	Double tank piercing interface	PP	26.00	11.80	5.80
10000104	231	Triple tank piercing interface	PP	27.00	12.40	6.10



### 8.2.1.8 Tank 500 $\mu\text{l}$ with cap with Mini Luer interface

This tank version with a volume of 500  $\mu\text{l}$  can be closed with a cap having a Mini Luer interface either for liquid or air pressure supply or for venting purposes. Furthermore, the cap can be equipped with a venting membrane in the Mini Luer interface allowing for a gas, but no liquid exchange. Possessing a male Luer interface, the tank can be easily mounted on chip.

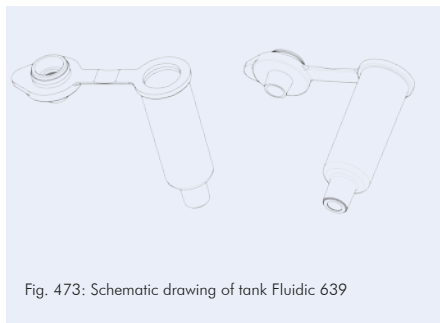

Fig. 473: Schematic drawing of tank Fluidic 639

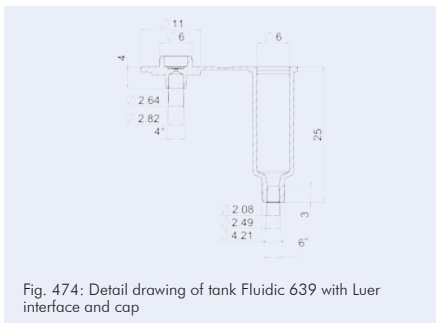

Fig. 474: Detail drawing of tank Fluidic 639 with Luer interface and cap

Product Code for Fluidic 639	Description	Material	Price [€/10 pieces]		
			1+	10+	100+
10000761	500 $\mu\text{l}$ tank with Mini Luer cap	PP	25.00	10.20	5.40
10000697	500 $\mu\text{l}$ tank with venting membrane in Mini Luer cap	PP	40.00	25.20	9.50

### 8.2.1.9 Tank 1 ml – Row of four with Luer interface

A larger tank version was created in order to allow for liquid storage up to 1 ml. This tank is offered as pure reservoir or with a cap allowing for a pneumatic actuation of the fluids. The fluidic interface is realized as male Luer connector.

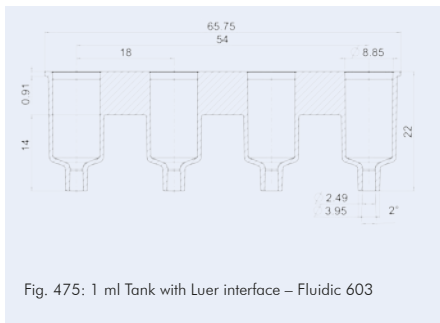

Fig. 475: 1 ml Tank with Luer interface – Fluidic 603

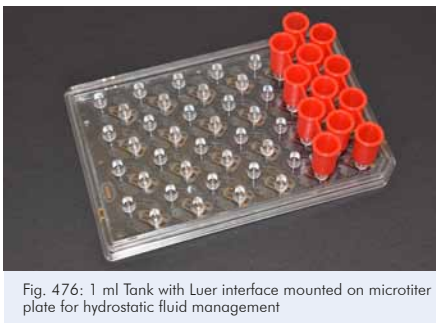

Fig. 476: 1 ml Tank with Luer interface mounted on microtiter plate for hydrostatic fluid management

Product Code for Fluidic 603	Description	Material	Price [€/10 pieces]		
			1+	10+	100+
10000754	Tank 1 ml – Row of four with Luer interface – green	PP	32.00	18.50	8.50
10000755	Tank 1 ml – Row of four with Luer interface – red	PP	32.00	18.50	8.50



### 8.2.1.10 Tank 4.5 ml - Row of four with Luer interface

A larger tank version was created in order to allow for liquid storage up to 4.5 ml. This tank is offered as pure reservoir or with a cap allowing for a pneumatic actuation of the fluids. The fluidic interface is realized as male Luer connector.

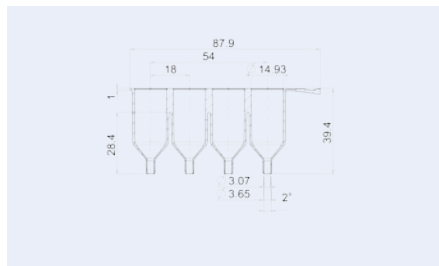

Fig. 477: Schematic drawing of row of four tanks Fluidic 232



Fig. 478: Liquid reservoir: 4.5 ml tank

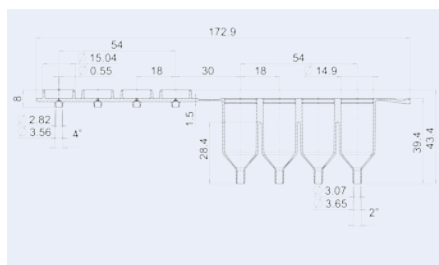

Fig. 479: Schematic drawing of tank Fluidic 233 with cap for pneumatic actuation



Fig. 480: Tank with cap for pneumatic actuation

Product Code	Fluidic	Description	Material	Price [€/10 pieces]		
				1+	10+	100+
10000078	232	Row of 4 tanks	PP	35.00	22.00	9.40
10000079	233	Row of 4 tanks with cap	PP	38.00	25.00	11.40



### 8.2.1.11 Interaction Tanks – 4.5 ml

The Interaction Tanks have been designed to allow for easy liquid access, storage and exchange in lab-on-a-chip devices. In particular if larger areas like membrane should be exposed to liquids, the Interaction Tanks can be either filled manually like Fluidic 234 or with pumps like Fluidic 235 allowing for various experimental settings. These tanks can e.g. be used with our open membrane chip Fluidic 219.

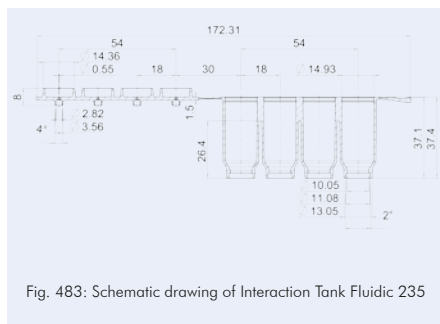
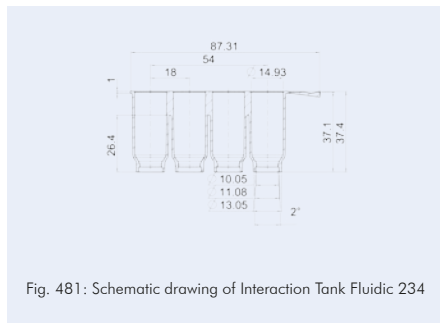

Product Code	Fluidic	Description	Material	Price [€/10 pieces]		
				1+	10+	100+
10000864	234	Interaction tank – row of four tanks – 4.5 ml volume	PP	35.00	22.00	9.40
10000904	235	Interaction tank – row of four tanks – 4.5 ml volume, with cap	PP	35.00	22.00	9.40



### 8.2.2 Blister pouches

Blister packs can be ordered as stand-alone parts being available with volumes ranging from 50 – 500  $\mu\text{l}$  off-the-shelf.

The blisters from 50 – 350  $\mu\text{l}$  volume can be operated with microfluidic devices like blister test chips Fluidic 289 and Fluidic 522, the 500  $\mu\text{l}$  blister requires Fluidic 761.

For convenience reasons, the blisters come with a ring of double sided adhesive tape to be mounted on the chips. Afterwards, the blisters can be removed for blister replacement.

All blisters can be ordered filled either with dye (cyan, magenta, yellow), water (clear) or user-specific liquids (to be provided to *microfluidic ChipShop*). Please inquire custom-fillings with [sales@microfluidic-ChipShop.com](mailto:sales@microfluidic-ChipShop.com).

Product code (color-dependent)				Description	Blister Volume [ $\mu\text{l}$ ]	Price [€/blister]		
Cyan	Magenta	Yellow	Clear			1+	10+	100+
10000678	10001145	10001146	10001147	Blister pouch	50	8.20	5.80	2.95
10000679	10001148	10001149	10001150	Blister pouch	100	8.20	5.80	2.95
10000680	10001151	10001152	10001153	Blister pouch	150	8.20	5.80	2.95
10000681	10001154	10001155	10001156	Blister pouch	200	8.20	5.80	2.95
10000682	10001157	10001158	10001159	Blister pouch	250	8.20	5.80	2.95
10000683	10001160	10001161	10001162	Blister pouch	350	8.20	5.80	2.95
10000684	10001163	10001164	10001165	Blister pouch	500-	8.20	5.80	2.95



Fig. 485: Blister test chip Fluidic 522



Fig. 486: Blister pouch with 150  $\mu\text{l}$  liquid volume



Fig. 487: DNA analysis chip with blister and integrated lateral flow strip



Fig. 488: Blister test chip Fluidic 1021 with a variety of aluminum foil pouches

### 8.2.3 Liquid handling & reservoir – Pipette-Chip-Bridge

The special Pipette-Chip-Bridge combines sample uptake with a standard pipette and the mounting of the Pipette-Chip-Bridge on the Luer interfaces of the chip and serving as reservoir. The total volume is 539  $\mu\text{l}$ .

All chips having a female Luer interface as fluidic interface on chip can be used with these devices.

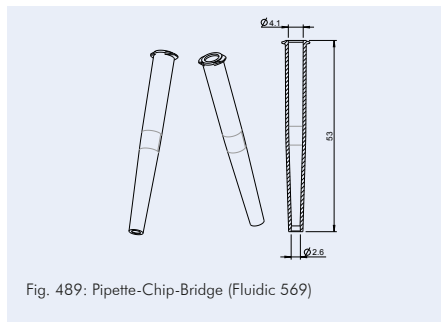

Fig. 489: Pipette-Chip-Bridge (Fluidic 569)



Fig. 490: Pipette-Chip-Bridge (Fluidic 569) mounted on Luer interface

Product Code	Description	Material	Price [€/10 pieces]		
			1+	10+	100+
10001078	Pipette-Chip-Bridge, Fluidic 569	PP	25.00	10.20	5.40

## 8.3 Sampling vessels

This rather large sampling vessel allows for dry and liquid sample take up and storage on chip which is, not only in microfluidics, a critical element.

### 8.3.1 Sampling vessels without septum

This sampling vessel has a total filling volume of 6.5 ml and can be mounted on chip via its male-Luer fluidic interface. It comes with a cap at the top which is sealed with embedded thread O-ring, ensuring a liquid tight sealing, as well as a little pressure cap at the bottom. After mounting on the chip, either liquid can be pipetted inside or a vessel, filled with buffer, can be used in which a swab is introduced after sample take up.

A sealing of these vessels at the bottom with piercable alumina foil is possible, allowing to prefill the vessels before mounting them on chip. Different kinds of alumina foil sealing are available, depending on whether short- or long-term storage of liquids is intended. When mounting these on chip, a specially designed, customized female fluidic interface with embedded piercing elements is needed, to burst the foil and release the liquid content.

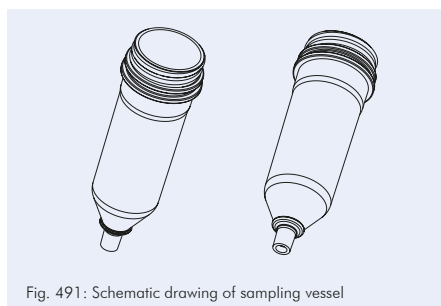

Fig. 491: Schematic drawing of sampling vessel

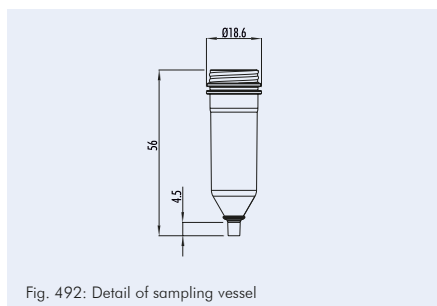

Fig. 492: Detail of sampling vessel





Fig. 493: Sampling vessel a total volume of 6.5 ml



Fig. 494: Sampling vessel prefilled with buffer and inserted swab

Product Code	Description	Material	Price [€/10 pieces]	
			1+	10+
10000219	Sampling vessel 6.5 ml	PP	72.60	48.40

### 8.3.2 Sampling vessels with integrated septum

These 6.5 ml sampling vessels, with a cap at the top with embedded thread O-ring, come with an integrated septum in the male-Luer fluidic interface to the chip. This rather thick and robust septum needs a specially designed, customized chip with an embedded needle inside the fluidic interface, to be able to pierce the septum and release the liquid content. As this septum is re-sealable, no liquid will pour out after removal of the sampling vessel from the chip. Additionally, the vessel comes with a little pressure cap at the bottom, to close the male-Luer interface and prevent from further contamination.



Fig. 495: Sampling vessel with pierceable septum



Fig. 496: Sampling vessel prefilled with buffer and inserted swab

Product Code	Description	Material	Price [€/10 pieces]	
			1+	10+
10000339	Sampling vessel 6.5 ml with septum	PP	92.60	58.40



### 8.4 Valving

On chip valving gives the possibility to direct and dose fluids freely according to the respective needs. Simple membrane valves embedded in the fluidic design allow for an on-off functionality whereas rotary valves enable to channel fluids in different pathways or to dose liquids in loops on a chip or directly in the valve itself. A large variety of *microfluidic ChipShop's* valving increases the possibilities to do this and can adapt to the user's experimental design.



Fig. 497: Fluidic chip with embedded rotary valve

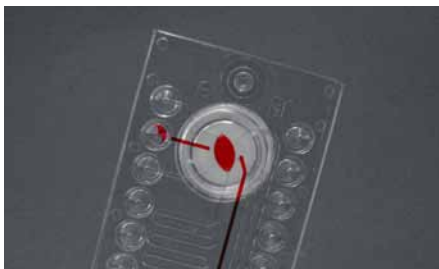

Fig. 498: Rotary valve with metering function

Product Code	Description	Lid Thickness [ $\mu\text{m}$ ]	Material	Price [€]/chip	
				1+	10+
10000182	Turning valve test chip	175	PC	128.50	79.60
10000183	Turning valve test chip	188	Zeonor	128.50	79.60



## 8.5 Tubing

### 8.5.1 Capillary PEEK tubing

The capillary PEEK tubing is intended to be used with the Upchurch Nanoports but is also suited for various other applications. We recommend to use PEEK tubing in combination with our LOC CCI 1. One package contains one red PEEK tube with a length of 1.524 m.



Fig. 499: Capillary PEEK tubing

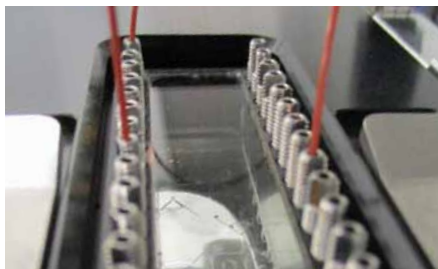

Fig. 500: Capillary PEEK tubing in use with the Lab-on-a-Chip Cell Culture Incubator – LOC CCI 1

Product Code	Description	Material	Quantity	Price [€]
40010468	Capillary PEEK tubing, red ID: 0.127 mm (0.005"), OD: 0.79375 mm (1/32")	PEEK	1.524 m	98.40

### 8.5.2 PTFE tubing

PTFE tubings are standard tubings to connect pumps with microfluidic chips in order to deliver to or to remove liquid from the chip. These tubings can be connected with the microfluidic chip with a silicone sleeve in which the PTFE tubing is introduced, and the silicone sleeve can be either mounted on the olive of a Mini Luer fluid connector or directly on olives integrated on chip.

Product Code	Description	Material	Quantity	Price [€]
10000032	Micro tubes, PTFE, ID: 0.5 mm, OD: 1.0 mm	PTFE	1 m	9.50

### 8.5.3 Silicone tubing

Silicone tubes are used to connect hard plastic tubes like PTFE tubings with pumps or the microfluidic chips and the respective interfaces. The silicone tubes in this catalogue can be mounted on the olives embedded on chips and on olives being part of the Mini Luer fluid connectors.

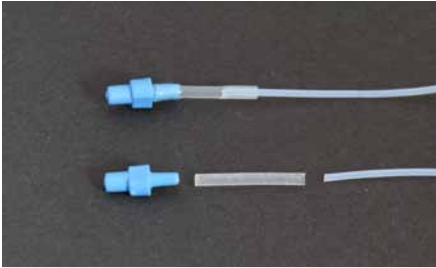

Fig. 501: Assembly of Mini Luer fluid connector, silicone sleeve (from product 10000031) and PTFE tubing



Fig. 502: PTFE tubing interconnected via silicone sleeve to the olive interface of a microfluidic device

Product Code	Description	Quantity	Price [€]
10000031	Silicone tube, ID: 0.76 mm, OD: 1.65 mm	1 m	9.50
10000033	Silicone tube, ID: 0.5 mm, OD: 2.5 mm	1 m	9.50



### 8.6 Microfluidic chip support kits – Microfluidic and chip-PCR support kits

The **microfluidic support kits** comprise different components necessary for running microfluidic systems. This includes tubes to bring the fluid into the chip, and silicone tubes to enable the interconnection between for example a *microfluidic ChipShop* fluidic platform chip and tubing, or between tubing and a syringe. Forceps can be used to stop a flow by clamping a silicone tube and syringes to fill chips manually.

These small kits allow you to directly start with your microfluidic experiments without losing time searching for suitable components.

For further microfluidic kits, please refer to Chapter 13.

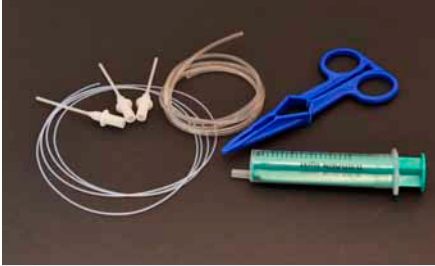

Fig. 503: Microfluidic support kit 1



Fig. 504: Chip-PCR support kit 1

Product Code	Kit Type	Product Description	Product Code	Price [€/kit]
10000025	Microfluidic support kit 1	<ul style="list-style-type: none"> <li>- Silicone tube (ID: 0.5 mm, OD: 2.5 mm, 1 m)</li> <li>- PTFE tube (ID: 0.5 mm, OD: 1 mm, 1 m)</li> <li>- Forceps (1)</li> <li>- Single-use syringes (10 ml, 3)</li> <li>- Syringe adapter (3)</li> </ul>	<ul style="list-style-type: none"> <li>10000033</li> <li>10000032</li> <li>10000641</li> <li>10000312</li> <li>10000614</li> </ul>	27.80
10000045	Microfluidic support kit 2	<ul style="list-style-type: none"> <li>- Silicone tube (ID: 0.5 mm, OD: 2.5 mm, 1m)</li> <li>- Silicone tube (ID: 0.76 mm, OD: 1.65 mm, 1m)</li> <li>- PTFE tube (ID: 0.5 mm, OD: 1 mm, 1m)</li> <li>- Forceps (1)</li> <li>- Single-use syringes (10 ml, 3)</li> <li>- Syringe adapter (3)</li> <li>- Male Mini Luer fluid connectors, red, material:PP (10)</li> <li>- Male Mini Luer fluid connectors, blue, material: PP (10)</li> <li>- Male Mini Luer fluid connectors, opaque, material: TPE (10)</li> <li>- Male Mini Luer plugs, green, material: PP (10)</li> <li>- Male Mini Luer plugs, opaque, material: TPE (10)</li> </ul>	<ul style="list-style-type: none"> <li>10000033</li> <li>10000031</li> <li>10000032</li> <li>10000312</li> <li>10000641</li> <li>10000614</li> <li>10000064</li> <li>10000096</li> <li>10000116</li> <li>10000052</li> <li>10000054</li> </ul>	96.50



### 8.7 Handling frames

To interface our microscopy-slide-sized microfluidic chips, we have developed stackable handling frames which comply with the SBS microtiter plate standard. They can therefore be handled with standard laboratory automation equipment and support the integration of microfluidic devices into your lab workflow. Four microscopy-slide-sized chips can be securely fixed in the frames.

#### 8.7.1 Handling frames for the spacing of a 1536 microtiter plate

These handling frames to be equipped with microfluidic devices allow to use all standard equipment being able to cope with the well spacing of a 1536 microtiter plate for pipetting and read out of the microfluidic chips. The frames are available in different colors for a safe differentiation of different applications.

Furthermore, they are available in two versions: One handling frame has the standard skirt of the microtiter plate, the second one has a reduced height, still complying with standard robots but allowing for a read out of the chips in plate readers or inverted optical microscopes with a reduced optical working distance.



Fig. 505: Handling frame with high skirt in yellow



Fig. 506: Handling frame with high skirt in red

Product Code	Description	Color	Price [€]		
			1+	5+	100+
1000042	Handling frame with high skirt	Yellow	22.00	15.00	12.40
1000043	Handling frame with high skirt	Orange	22.00	15.00	12.40
1000044	Handling frame with high skirt	Red	22.00	15.00	12.40

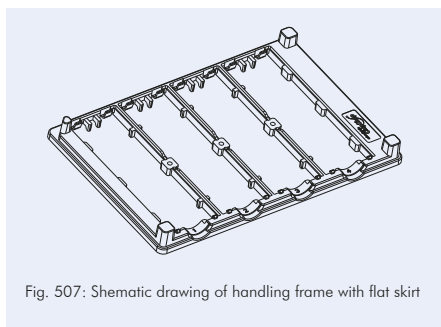

Fig. 507: Schematic drawing of handling frame with flat skirt



Fig. 508: Handling frame with flat skirt with different chip types - frames can be easily stacked

Product Code	Description	Color	Price [€]		
			1+	10+	100+
1000041	Handling frame with reduced skirt height	Orange	22.00	15.00	12.40



### 8.7.2 Handling frames for the spacing of a 384 microtiter plate

These handling frames place microfluidic devices in the format of a microscopy slide on the positions of the wells of a 384 well microtiter plate and enable the use of standard robots and readers for the 384 well microtiter plates.



Fig. 509: Handling frame for microscopy slide format chips to fit 384 well positions of a microtiterplate – fitting with 384 well plate readers

Product Code	Description	Price [€] 1+
10000302	Handling frame to comply with the spacing of 384 microtiter plates	128.50

### 8.7.3 Handling frames for the spacing of a 96 microtiter plate

These handling frames place microfluidic devices in the format of a microscopy slide on the positions of the wells of a 96 well microtiter plate and enable the use of standard robots and readers for the 96 well microtiter plates.



Fig. 510: Handling frame for microscopy slide format chips to fit 96 well positions of a microtiterplate – fitting with 96 well plate readers

Product Code	Description	Price [€] 1+
10000419	Handling frame to comply with the spacing of 96 microtiter plates	128.50



### 8.7.4 Handling frame for self-sealing and releasable chips – for slide-format chips

The handling frame for self-sealing and releasable chips allows for the insertion of a bottom plate e.g. a microscopy glass slide and a slide-format microfluidic chip. By closing the frame a constant pressure is ensured to connect the sealing gasket as the microfluidic chip liquid tight to the bottom plate.

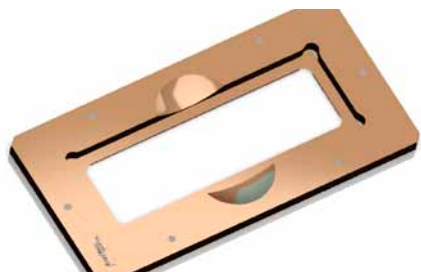

Fig. 511: Handling frame for self-sealing and releasable chips in slide-format

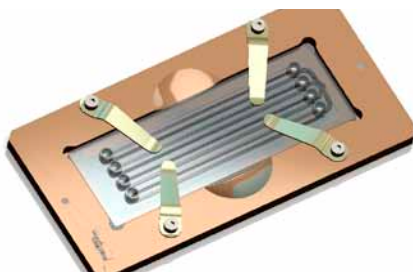

Fig. 512: Handling frame with chip – self-sealing and releasable chips

Product Code	Description	Price [€]	
		1+	5+
10001090	Handling-frame for self-sealing and releasable chips in slide-format	244.00	204.00





## 8.8 Chip lids

For some applications it is of interest to protect the chip against the environment, e.g. to avoid evaporation, changing environmental conditions or contaminations. Special chip lids are at hand to mount them loosely on chips and handling frames.

### 8.8.1 Chip lid – Microtiter plate format

To cover the handling frame in the microtiter plate format equipped with microfluidic chips, a cover lid for device sizes of a microtiter plate is available.

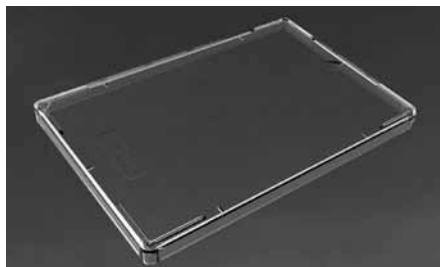

Fig. 513: Chip lid Fluidic 854 – For microtiter plate-sized devices

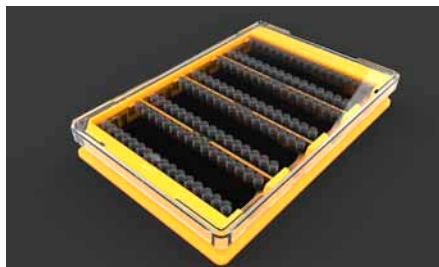

Fig. 514: Chip lid Fluidic 854 with handling frame and slide-sized microfluidic devices

Product Code	Description	Material	Price [€/ 10 pieces]	
			1+	10+
10000975	Chip lid Fluidic 854 – For microtiter plate-sized devices	Topas	32.10	19.95
10001087	Chip lid Fluidic 854 – For microtiter plate-sized devices	PS	32.10	19.95



### 8.9 Reagents

In order to enable a convenient use of our microfluidic systems, reagents are offered to fulfill special requirements. This includes for instance reagents usable with different polymer materials offered in the catalogue or being compatible with reactions carried out on chip.

#### 8.9.1 Oil

Special oils are used in microfluidic systems e.g. in droplet generator chips to generate and separate individual droplets, in PCR chips to avoid evaporation or the separation of sample plugs. The right choice of the oil is crucial since viscosity, material and reaction compatibility have to be taken into consideration. Our droplet generation oil does not contain a surfactant, those have to be added prior to the experiment.

Product Code	Description	Material compatibility	Application	Price [€/10 ml]
10000163	mcs-oil-02	PC	PCR compatible	28.50
10001079	mcs-oil-04	PC, PMMA, COC (Topas), COP (Zeonor)	PCR compatible	35.40
10000677	mcs-oil-10	PC, PMMA, COC (Topas), COP (Zeonor)	Droplet generation	22.40



### 8.10 Storage & transport: Boxes for microfluidic devices

Despite that most of the standard microfluidic modules come in standard formats like the microscopy slide or microtiter-plate format, standard storage solutions do not necessarily cope with the demand either in respect of clean handling or the special format of the microfluidic devices that have e.g. a different thickness than their “standard” counterpart or have integrated fluidic interfaces that also might interfere with conventional solutions.

*microfluidic ChipShop’s* chip storage solutions are specially adapted to the design features of microfluidic devices.

Various storage box types in multiple colors are available. All allow for an easy uptake of the chip by sliding the top cover.

#### 8.10.1 Storage & transport: Boxes for microfluidic devices – Chip size: Slide format

For chips in the format of a microscopy slide (25.5 mm x 75.5 mm), four storage box types are available. The smallest box, Fluidic 832, is made for chips with 1 – 2 mm thickness. 10 chips without fluidic interfaces and 5 with fluidic interfaces can be placed in the box.

Our medium sized box, Fluidic 839, can retain up to 20 chips (w/o interphase) with 1 – 2 mm thickness and 10 chips with fluidic interphases.

The two larger boxes allow for the storage of chips in a thickness range from 1 – 2 mm, the other option copes with thicker devices from 3 to 4 mm thickness.



Fig. 515: Small microfluidic chip storage boxes Fluidic 832 for slide-format chips. Available colors are depicted to the right



Fig. 516: Small microfluidic chip storage box Fluidic 832 for slide-format chips – opened with chips

Product Code for Fluidic 832	Description	Color	Material	Price [€/pieces]	
				1+	10+
1000990	Microfluidic device storage box - small	White	PP	17.10	11.90
10001186	Microfluidic device storage box - small	Emerald	PP	17.10	11.90
10001189	Microfluidic device storage box - small	Dark blue	PP	17.10	11.90
10001188	Microfluidic device storage box - small	Light blue	PP	17.10	11.90
10001185	Microfluidic device storage box - small	Apple green	PP	17.10	11.90
10001187	Microfluidic device storage box - small	Orange	PP	17.10	11.90
10001184	Microfluidic device storage box - small	Lilac	PP	17.10	11.90



## 8 Accessories

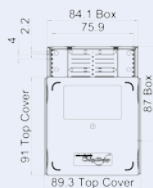

Fig. 517: Medium microfluidic chip storage box for devices with 1.0 – 2.0 mm thickness

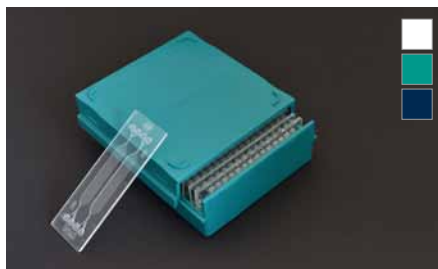
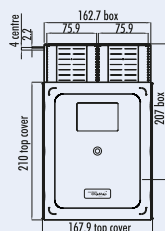

Fig. 518: Medium microfluidic chip storage box for slide-format chips. Available colors are depicted to the right

Product Code for Fluidic 839	Description	Color	Material	Price [€/pieces]	
				1+	10+
10001226	Microfluidic device storage box - medium	White	PP	18.10	12.50
10001175	Microfluidic device storage box - medium	Emerald	PP	18.10	12.50
10001176	Microfluidic device storage box - medium	Dark blue	PP	18.10	12.50



1:2

Fig. 519: Large microfluidic chip storage box Fluidic 889 for devices with 1.0 – 2.0 mm thickness



Fig. 520: Large microfluidic chip storage box for devices with 1.0 – 2.0 mm thickness. Available colors are depicted to the right

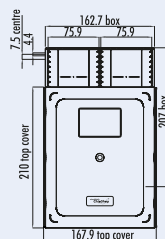

1:2

Fig. 521: Microfluidic chip storage box Fluidic 890 for devices with 3.0 – 4.0 mm thickness



Fig. 522: Comparison of Fluidic 890 and Fluidic 889 for microfluidic devices with different thicknesses. Available color for Fluidic 890 is depicted to the right.



Product Code	Description	Color	Material	Price [€/pieces]	
				1+	10+
10001199	Microfluidic chip storage box - large 1.00 - 2.00 mm thickness, Fluidic 889	Opaque	PP	19.10	12.90
10001198	Microfluidic chip storage box - large 1.00 - 2.00 mm thickness, Fluidic 889	Emerald	PP	19.10	12.90
10001197	Microfluidic chip storage box - large 1.00 - 2.00 mm thickness, Fluidic 889	Dark blue	PP	19.10	12.90
10000162	Microfluidic chip storage box - large 3.00 - 4.00 mm thickness, Fluidic 890	White	PP	19.10	12.90

### 8.10.2 Storage & transport: Boxes for microfluidic devices – Chip size: Extended size I platform format

For chips in *microfluidic ChipShop's* "extended size I platform format", namely 16 mm x 95 mm, 10 chip without fluidic interfaces and 5 with fluidic interfaces can be placed.

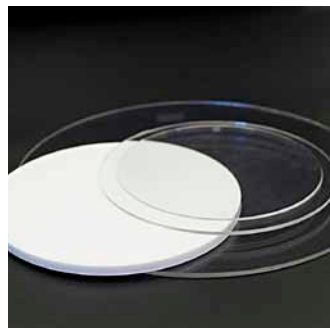
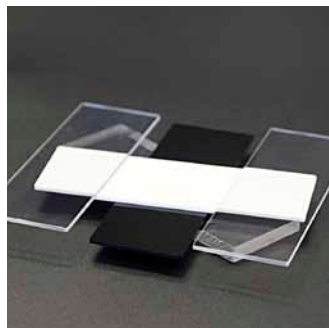
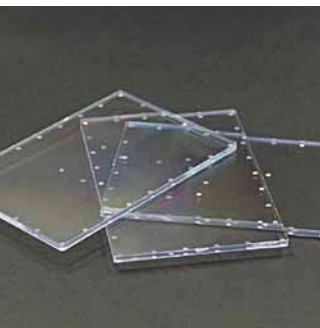
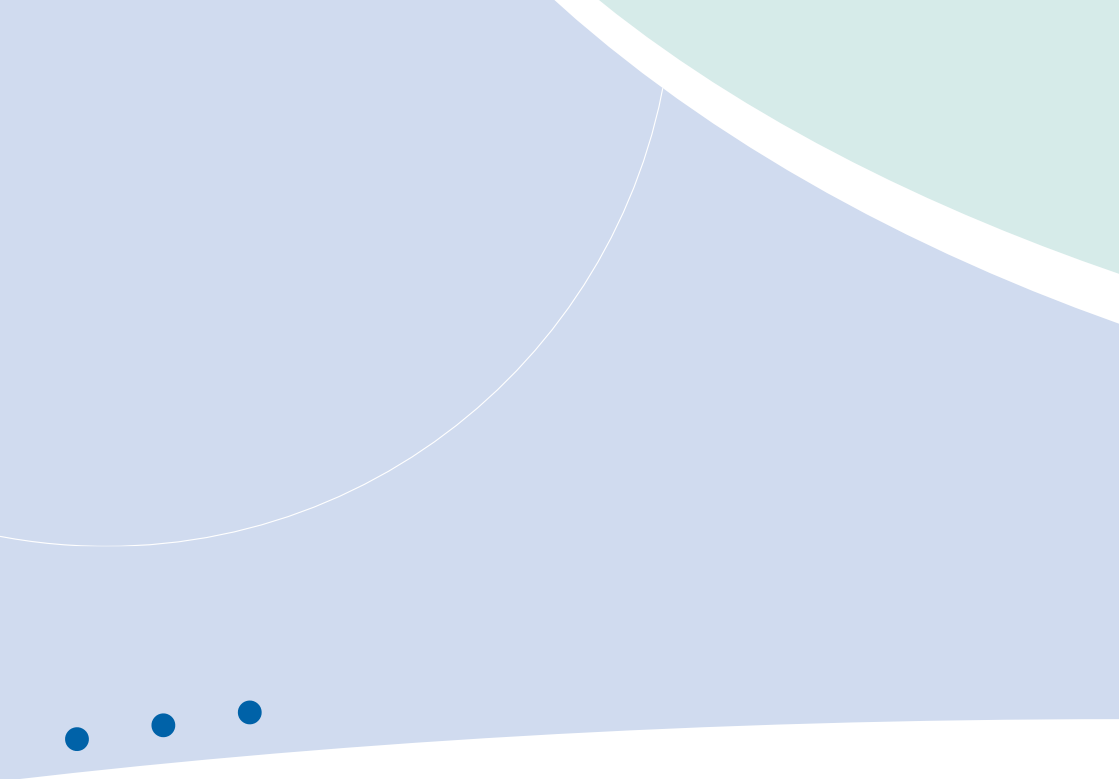

Fig. 523: Microfluidic chip storage box Fluidic 811 for for microfluidic chips sized 16 mm x 95 mm in various colors. Available colors are depicted to the right

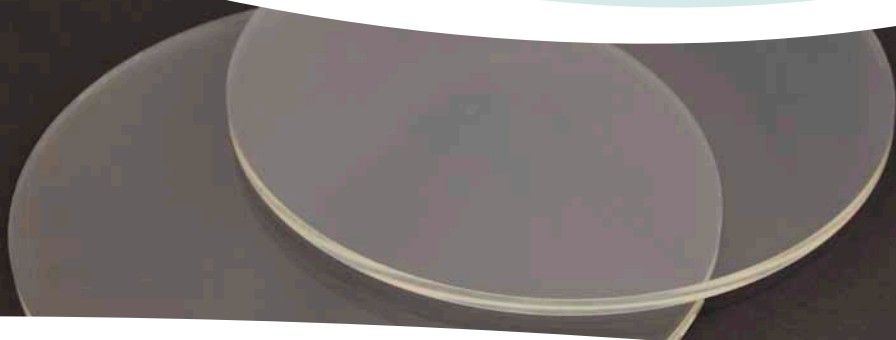

Fig. 524: Microfluidic chip storage box Fluidic 811 for microfluidic chips sized 16 mm x 95 mm – with compatible chips

Product Code for Fluidic 811	Description	Color	Material	Price [€/pieces]	
				1+	10+
10001108	Microfluidic device storage box - extended	White	PP	17.10	11.90
10001225	Microfluidic device storage box - extended	Emerald	PP	17.10	11.90
10001191	Microfluidic device storage box - extended	Dark blue	PP	17.10	11.90



## 9 Polymer substrates and foils



### Polymer substrates and foils

Some interesting materials that are useful in microfluidics, in particular a range of different polymers, are either not commercially available as plate materials or not of sufficient quality for the special requirements of microfabrication. If you are in need of plain substrate material, e.g. for hot embossing experiments or as unstructured platform for surface chemistry experiments, we can provide you with substrates in our standard formats like microscopy-slide, 1/4-microtiterplate (43 mm x 64 mm) or round substrates with various diameters. Wafers, to be used, for instance, as substrates for hot embossing, come in several units in one package. If surface quality matters, each wafer is separately packaged.

The dimensions of the substrates may differ in the range of 0.5 % depending on the material.

In case the material or color you require is not listed, we are happy to provide you with a customized quote for a substrate matching your material needs.

Besides the thicker polymer substrates in various formats, special foil materials in different thickness are available.



### 9.1 Wafer format – 100 mm diameter

Product Code	Material	Thickness [mm]	Comment	Price [€/per unit*]		
				1+	10+	50+
10000868	Zeonor	0.7	individually wrapped	75.00	62.00	36.00
10000241	PMMA	1.0	individually wrapped	75.00	62.00	36.00
10000257	Topas	1.0	individually wrapped	75.00	62.00	36.00
10000240	PC	1.0	individually wrapped	75.00	62.00	36.00
10000869	Zeonex	1.0	individually wrapped	75.00	62.00	36.00
10000383	Zeonor	1.0	individually wrapped	75.00	62.00	36.00
10000703	Topas	1.5	individually wrapped	75.00	62.00	36.00

\* 1 unit consists of 10 wafers

### 9.2 Wafer format – 115 mm diameter

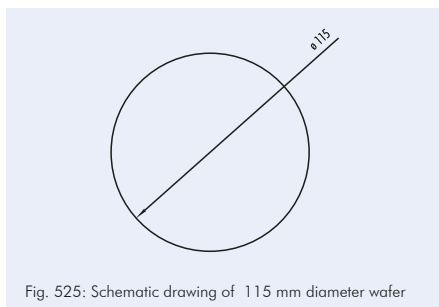

Fig. 525: Schematic drawing of 115 mm diameter wafer



Fig. 526: Polymer substrate – wafers

Product Code	Material	Thickness [mm]	Comment	Price [€/per unit*]		
				1+	10+	50+
10000149	Topas	2.0	individually wrapped	75.00	62.00	36.00
10000150	PC	2.0	individually wrapped	75.00	62.00	36.00
10000151	Zeonex	2.0	individually wrapped	75.00	62.00	36.00
10000152	Zeonor	2.0	individually wrapped	75.00	62.00	36.00
10000153	Topas	1.5	individually wrapped	75.00	62.00	36.00
10000154	PC	1.5	individually wrapped	75.00	62.00	36.00
10000155	Zeonex	1.5	individually wrapped	75.00	62.00	36.00
10000156	Zeonor	1.5	individually wrapped	75.00	62.00	36.00

\* 1 unit consists of 10 wafers





### 9.3 Wafer format – 180 mm diameter

Product Code	Material	Thickness [mm]	Comment	Price [€/per unit*]		
				1+	10+	50+
10000725	Topas	1	individually wrapped	120.00	98.00	55.00
10000726	Zeonor	1	individually wrapped	120.00	98.00	55.00
10000727	Topas	2	individually wrapped	120.00	98.00	55.00
10000728	Zeonor	2	individually wrapped	120.00	98.00	55.00
10000729	Topas	3	individually wrapped	130.00	106.00	59.00
10000730	Zeonor	3	individually wrapped	130.00	106.00	59.00
10000731	Topas	4	individually wrapped	130.00	106.00	59.00
10000732	Zeonor	4	individually wrapped	130.00	106.00	59.00
10000733	Topas	5	individually wrapped	140.00	114.00	63.00
10000734	Zeonor	5	individually wrapped	140.00	114.00	63.00
10000735	Topas	6	individually wrapped	140.00	114.00	63.00
10000736	Zeonor	6	individually wrapped	140.00	114.00	63.00

\* 1 unit consists of 10 wafers

### 9.4 Microtiter plate format (127.76 x 85.48 mm)

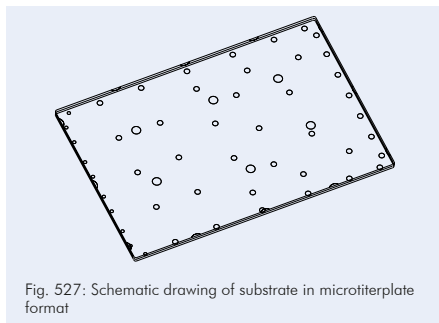

Fig. 527: Schematic drawing of substrate in microtiterplate format

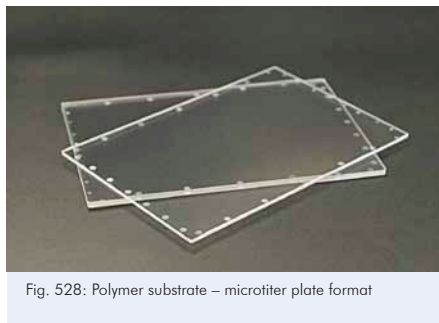

Fig. 528: Polymer substrate – microtiter plate format

Product Code	Material	Thickness [mm]	Comment	Price [€/per unit*]		
				1+	10+	50+
10000706	Topas	1.5	individually wrapped	75.00	62.00	36.00
10000707	Zeonor	1.5	individually wrapped	75.00	62.00	36.00
10000747	Topas	2	individually wrapped	75.00	62.00	36.00
10000748	Zeonor	2	individually wrapped	75.00	62.00	36.00
10000746	Topas	2.5	individually wrapped	75.00	62.00	36.00
10000708	Zeonor	2.5	individually wrapped	75.00	62.00	36.00
10000749	Topas	3	individually wrapped	75.00	62.00	36.00
10000750	Zeonor	3	individually wrapped	75.00	62.00	36.00

\* 1 unit consists of 10 substrates



### 9.5 Microscopy slide format (75.5 mm x 25.5 mm)

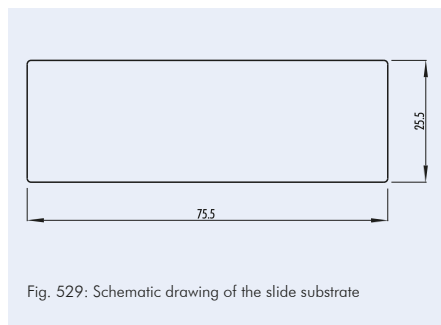

Fig. 529: Schematic drawing of the slide substrate

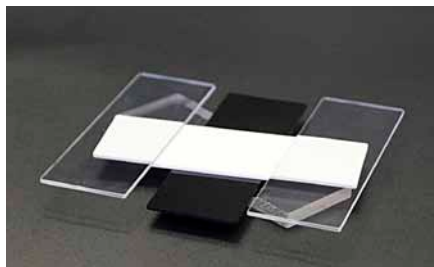

Fig. 530: Various polymeric substrates in the format of a microscopy slide

Product Code	Material	Thickness [mm]	Comment	Price [€/per unit*]		
				1+	10+	50+
1000000	PMMA	1.0	Individually wrapped	55.00	30.00	22.00
1000001	PMMA black	1.0	Individually wrapped	55.00	30.00	22.00
1000002	Topas	1.0	Individually wrapped	55.00	30.00	22.00
10000130	PC	1.0	Individually wrapped	55.00	30.00	22.00
10000131	Zeonex	1.0	Individually wrapped	55.00	30.00	22.00
10000132	Zeonor	1.0	Individually wrapped	55.00	30.00	22.00
10000133	Zeonor black	1.0	Individually wrapped	55.00	30.00	22.00
10000134	PMMA	1.5	Individually wrapped	55.00	30.00	22.00
10000135	Topas	1.5	Individually wrapped	55.00	30.00	22.00
10000136	PC	1.5	Individually wrapped	55.00	30.00	22.00
10000137	Zeonex	1.5	Individually wrapped	55.00	30.00	22.00
10000138	Zeonor	1.5	Individually wrapped	55.00	30.00	22.00
10000452	PMMA	2	Individually wrapped	55.00	30.00	22.00
10000443	Topas	2	Individually wrapped	55.00	30.00	22.00
10000454	PC	2	Individually wrapped	55.00	30.00	22.00
10000455	Zeonex	2	Individually wrapped	55.00	30.00	22.00
10000456	Zeonor	2	Individually wrapped	55.00	30.00	22.00
10000457	Topas	4	Individually wrapped	75.00	35.00	22.00
10000458	PC	4	Individually wrapped	75.00	35.00	22.00
10000141	Zeonex	4	Individually wrapped	75.00	35.00	22.00

\* 1 unit consists of 10 slides

### 9.6 Double slide format (75.5 mm x 50 mm)

Product Code	Material	Thickness [mm]	Comment	Price [€/per unit*]		
				1+	10+	50+
10000762	PMMA	2.0	Individually wrapped	76.00	44.50	24.90
10000763	Topas	2.0	Individually wrapped	76.00	44.50	24.90
10000764	PC	2.0	Individually wrapped	76.00	44.50	24.90
10000765	Zeonor	2.0	Individually wrapped	76.00	44.50	24.90

\* 1 unit consists of 10 slides



## 9.7 Foils

For special requirements thin foils in various materials are offered. This includes pure polymer foils as well as pressure sensitive adhesive tapes.

Our foils are offered in roll format with fixed dimensions. While we strive to have all foils listed below in stock, our foil range might change or increase slightly. For up-to-date stock information please refer to our webpage [www.microfluidic-ChipShop.com](http://www.microfluidic-ChipShop.com) or contact us via [sales@microfluidic-chipshop.com](mailto:sales@microfluidic-chipshop.com).

Product Code	Description	Material	Format			T <sub>g</sub> [°C]	Thickness [μm]	Protective Foil	Price [€]
			Width [mm]	Lenght [m]	Total Area [m <sup>2</sup> ]				
10001368	mcs-foil-005	Zeonor	24.5	10	0.245	136	188	one-sided	79.40
10001369	mcs-foil-005	Zeonor	30.0	10	0.3	136	188	one-sided	86.00
10001370	mcs-foil-005	Zeonor	450.0	10	4.5	136	188	one-sided	565.00
10001371	mcs-foil-015	Zeonor	24.5	10	0.245	136	100	one-sided	79.40
10001372	mcs-foil-015	Zeonor	30.0	10	0.3	136	100	one-sided	86.00
10001373	mcs-foil-015	Zeonor	85.0	10	0.85	136	100	one-sided	152.00
10001374	mcs-foil 049	Zeonor	24.5	10	0.245	136	40	one-sided	76.95
10001375	mcs-foil 049	Zeonor	640.0	10	6.4	136	40	one-sided	729.00
10001376	mcs-foil 051	Zeonor	24.5	10	0.245	136	50	one-sided	76.95
10001377	mcs-foil 029	Topas	600.0	10	6.0	78	240	none	493.00
10001378	mcs-foil 011	Topas	85.0	10	0.85	78	140	one-sided	116.30
10001379	mcs-foil 011	Topas	170.0	10	1.7	78	140	one-sided	157.60
10001380	mcs-foil 011	Topas	600.0	10	6.0	78	140	two-sided	493.00
10001381	mcs-foil 081	Topas	85.0	10	0.85	142	175	two-sided	116.30
10001382	mcs-foil 080	Topas	85.0	10	0.85	142	125	two-sided	116.30
10001383	mcs-foil 080	Topas	900.0	5	4.5	142	125	two-sided	376.00
10001384	mcs-foil 079	Topas	85.0	10	0.85	142	100	two-sided	116.30
10001385	mcs-foil 079	Topas	900.0	5	4.5	142	100	two-sided	376.00
10001386	mcs-foil 077	Topas	85.0	10	0.85	142	50	two-sided	116.30
10001387	mcs-foil 077	Topas	900.0	5	4.5	142	50	two-sided	376.00
10001388	mcs-foil 008	Double-sided adhesive tape	140.0	10	1.4	-	140	two-sided	150.30

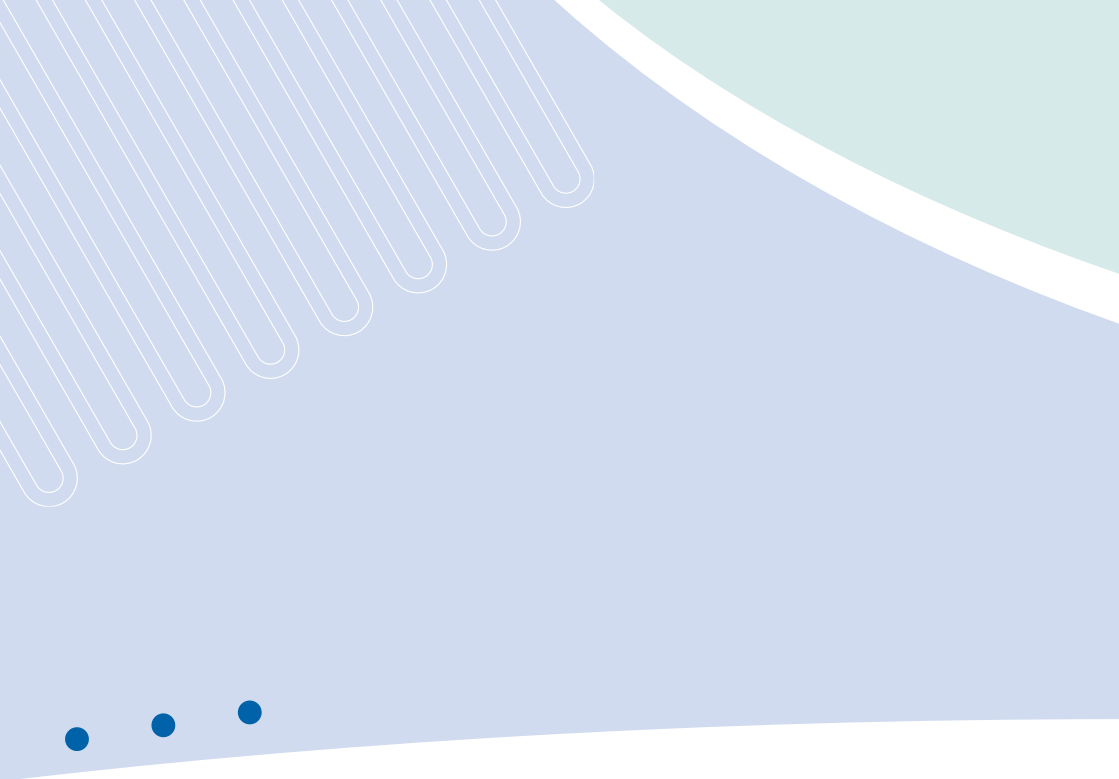

# 10 ChipGenie® editions – Instruments and applications



## 10 ChipGenie® editions – Instruments and applications

Using microfluidic systems in the daily laboratory life usually requires not only the chips but also the relevant instrumentation. Here, our ChipGenie® editions come into play.

ChipGenie® edition T, for instance, consists of both chips in a variety of formats and a matching temperature control unit to enable you to directly start your reactions/amplifications in a fraction of the time compared to conventional instruments.

ChipGenie® edition E2, an extremely compact electrophoresis system, allows the label-free detection of small ions thanks to its contactless conductivity detection scheme. Again, the instrument is complemented by a variety of chips ideally suited for the system.

ChipGenie® edition P is a compact versatile instrument for on-chip magnetic bead-handling and heating, e.g. for sample preparation like DNA extraction.

ChipGenie® edition I is a merger of lab-automation and microfluidics. The microfluidic actuation and reagent supply is covered by a pipetting unit.

Breadboard-systems for functional evaluation of special microfluidic elements are part of the ChipGenie® edition as well. ChipGenie® edition BD addresses the emptying of blisters, ChipGenie® edition TV allows for the control of turning valves.



### 10.1 ChipGenie® edition T – Heating and PCR systems

The ChipGenie® edition T summarizes the instrument family used for chip-based applications requiring heating like for instance PCR. Some of the instruments cover the temperature control only, others include the optical read-out allowing e.g. for real-time PCR.

#### 10.1.1 ChipGenie® edition TS and ChipGenie® edition TSO - On-Chip qPCR thermocycler

The ChipGenie® edition TS and ChipGenie® edition TSO instruments allow for the temperature control of microfluidic chips in microscope slide format. A fixed temperature as well temperature cycling can be done to enable e.g. a fast PCR on chip. The ChipGenie® edition TSO is additionally equipped with a fluorescence-based read-out unit to carry out the optical detection on *microfluidic ChipShop's* chamber chips following the spacing of a 384 well plate of 4.5 mm with fixed read-out positions.

Microfluidic chips that are particularly suited for use with this device include Fluidics 843; 750; 585; 584 and 842. Please refer to Chapter 3.6.2.2 for further information on suitable chips.

The instrument	<p>Compact lab device containing:</p> <ul style="list-style-type: none"> <li>• Thermocycling unit for one microscope slide format chip (heating/cooling rate 8°C/s)</li> <li>• Fluorescence detector for up to three pre-defined detection channels</li> </ul>
The microfluidic chip	<ul style="list-style-type: none"> <li>• Reaction chamber of the system</li> <li>• Available with various chamber volumes</li> </ul>
The software	<ul style="list-style-type: none"> <li>• User friendly program allowing: Experimental setup Data analysis</li> <li>• Connection established via USB port</li> </ul>



Fig. 531: ChipGenie® edition TS

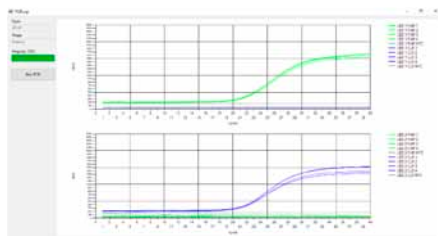

Fig. 532: qPCR readouts obtained and analyzed using ChipGenie® edition TSO and the included software

Product Code	Description	Price [€]
10000674	ChipGenie® edition TS: Heating & PCR-system for microfluidic chips in the format of a microscope slide without fluorescence read-out unit	4,258.00
10001106	ChipGenie® edition TSO: Heating & PCR-system for microfluidic chips in the format of a microscope slide with fluorescence read-out unit (two colors)	8,487.00



### 10.1.2 ChipGenie® edition TS-3Z - Multiple heater set-up & continuous-flow-PCR

The ChipGenie® edition TS-3Z and ChipGenie® edition TSO-3Z instruments are equipped with three temperature zones for the so-called continuous flow PCR. The temperature zones are kept at fixed temperature and the temperature cycling is achieved by moving the liquid in the chip over two or three temperature zones of the instrument resulting in ultrafast temperature cycles. The ChipGenie® edition TSO-3Z is equipped with a fluorescence-based read-out unit to carry out the optical detection.

*microfluidic ChipShop* offers an innovative system for PCR on the chip. Different from conventional PCR with heating-up and cooling-down cycles, in this chip-PCR system the complete reaction vessel is temperature controlled: The PCR solution flows through separated temperature zones, winding itself through the temperature profile. The time-determining step in PCR – the carrying out of the repeated heating and cooling cycles – is no longer necessary since the temperature in the heating zones remains constant and only the liquid undergoes the temperature cycling.

The PCR system comprises the PCR chip and the thermocycler (or better: thermal control unit, as no cycling in the conventional sense is involved) that has been specially developed for Lab-on-a-Chip applications. A pump moves the PCR solution through the chips. In comparison to conventional systems, this lab-on-a-chip PCR system allows for a significant reduction of the PCR reaction time: Without much optimization, a 15-cycle PCR can be completed in less than five minutes. For a choice of continuous flow PCR chips please refer to the respective chapter 3.13.

In order to allow you easy use of the PCR system we offer chip-PCR support kits (that include tubes and mineral oil for pumping the PCR solution) as well as pumps for the driving of the fluids.

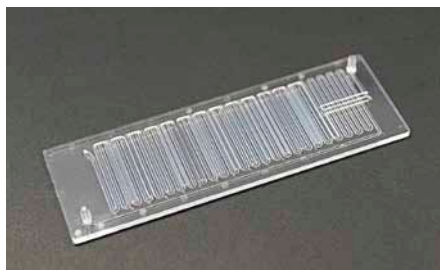

Fig. 533: 40 cycle continuous-flow PCR chip Fluidic 243



Fig. 534: 15-cycle continuous-flow PCR-chip

Product Code	Description	Price [€]
10000985	ChipGenie® edition TS-3Z: Heating & PCR-system for microfluidic chips in the format of a microscopy slide with three temperature zones	7,498.00
10001113	ChipGenie® edition TSO-3Z: Heating & PCR-system for microfluidic chips in the format of a microscopy slide with three temperature zone including fluorescence read-out unit (two colors)	10,953.00

## 10.2 ChipGenie® edition E2 - Capillary electrophoresis system with contactless conductivity detection

ChipGenie® edition E2 – a rugged and small lab device which is ideally suited for your microfluidic-based label free detection of cations and anions. The analyte separation is done via capillary electrophoresis, using the contactless capacitively coupled conductivity detection (C<sup>4</sup>D) scheme for sample identification.

The ChipGenie® edition E2 uses a powerful separation technique allowing the fast detection of small and large molecules, which can be organic or inorganic, simplified in handling and down to a detection limit of  $\leq 10 \mu\text{mol l}^{-1}$  making it a one-for-all analytical tool. Applications can be found in biological, environmental and chemical research and samples are as diverse as mineral water, fertilizers, blood serum, urine, or foodstuffs (e.g. wine or milk).

The instrument	<p>Compact lab device containing:</p> <ul style="list-style-type: none"> <li>High voltage power supply and platinum electrodes for ion separation</li> <li>High frequency electronics, based on C<sup>4</sup>D principle, for ion identification</li> </ul>
The microfluidic chip	<ul style="list-style-type: none"> <li>Reaction chamber of the system</li> <li>Carries a pair of detection electrodes at the outside</li> <li>Contains: Sample and buffer injection ports Sample injection, as well as sample separation channel</li> </ul>
The software	<ul style="list-style-type: none"> <li>Easy-to-use program allowing: System control Data read-out</li> <li>Connection established via USB port</li> </ul>



Fig. 535: ChipGenie® edition E2 capillary electrophoresis unit



Fig. 536: ChipGenie® edition E2 – starter kit 1

When starting an analysis using ChipGenie® edition E2, the preprogrammed high voltage sequence that can achieve values from 0.01 to 4 kV, is applied along the microchannel, leading to sample migration through the capillary. The charged analytes reach the detection zone at the end of the capillary and interact with the high frequency signal from the transmitter electrode. The interaction changes the amount of electrical current flowing through the chip, which is detected by the receiver electrode. The signal is converted via a trans-impedance amplifier into a voltage signal, depicted in the output electropherogram. The signal changes are owed to different relative permittivity of each analyte inside the sample mix.

The ChipGenie® edition E2 can be operated with a variety of microfluidic chips in the Cross-shaped channel design with Luer interface (see Fig. 538). They carry thin film detection electrodes (10 nm titanium, 100-150 nm gold), buffer and sample injection sites (reservoirs of  $\leq 70 \mu\text{l}$ ) and the separation channel. They are available in different materials whereby for most applications PMMA is the material of choice. To achieve maximum reliability of your analysis, the microfluidic chips are consumables and hence recommended to be replaced after each analysis.





Fig. 537: ChipGenie® edition E2 – starter kit 2



Fig. 538: Microfluidic chips for the ChipGenie® edition E2 series

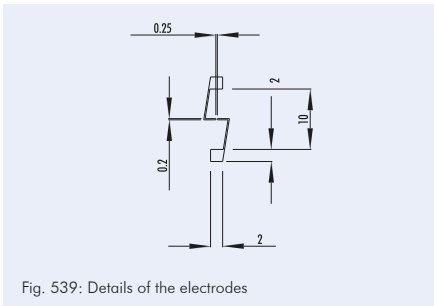

Fig. 539: Details of the electrodes

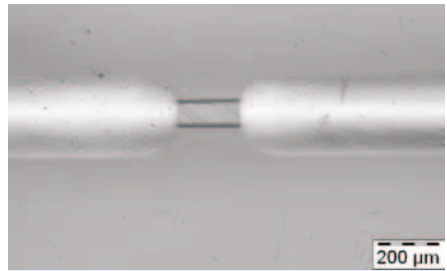

Fig. 540: Microscopy image of electrodes over microchannel

Product Code	Channel			Geometry				Lid Thickness [μm]	Material	Price [€/chip]		
	Width [μm]	Depth [μm]	Length [mm]	A	B	C	D			1+	10+	100+
10000028	50	50	87.0	6.0	5.0	5.0	0	60	PMMA	125.00	85.00	32.50
10000027	50	50	87.0	6.0	5.0	5.0	0.1	60	PMMA	125.00	85.00	32.50
10000337	100	100	87.0	6.0	5.0	5.0	0	60	PMMA	125.00	85.00	32.50
10000338	100	100	87.0	6.0	5.0	5.0	0	50	Zeonor	125.00	85.00	32.50

Product Code	Description	Dimensions [cm]	Price [€/instrument]
10001316	ChipGenie® edition E2 instrument	19 x 13 x 25.7	3,985.00



## 10 Instruments and applications

Product Code	Description	Detail	Product Code	Price [€]
10001317	ChipGenie® edition E2 starter kit 1	<ul style="list-style-type: none"> <li>- ChipGenie® edition E2 instrument</li> <li>- Cross-shaped channel chips (50 µm width/50 µm depth), T-junction, material: PMMA (2)</li> <li>- Cross-shaped channel chips (50 µm width/50 µm depth), double T-junction, material: PMMA (2)</li> <li>- Cross-shaped channel chips (100 µm width/100 µm depth), T-junction, material: PMMA (2)</li> <li>- Cross-shaped channel chips (100 µm width/100 µm depth), T-junction, material: Zeonor (2)</li> <li>- Single-use syringes, 1 ml (10)</li> <li>- 10 ml mcs buffer 03 (separation buffer)</li> <li>- ChipGenie® edition E starter kit 3 – standards: Cation standard solution, Li<sup>+</sup>, Na<sup>+</sup>, K<sup>+</sup> (1 ml) Anion standard solution, Cl<sup>-</sup>, NO<sub>3</sub><sup>-</sup>, SO<sub>4</sub><sup>2-</sup> (1 ml) Organic acid standard solution, tartaric acid, succinic acid, citric acid (1 ml)</li> </ul>	10001316 10000028 10000027 10000337 10000338 10000719 10000987 10000516	4,392.00
10000515	ChipGenie® edition E2 starter kit 2	<ul style="list-style-type: none"> <li>- Cross-shaped channel chips (50 µm width/50 µm depth), T-junction, material: PMMA (2)</li> <li>- Cross-shaped channel chips (50 µm width/50 µm depth), double T-junction, material: PMMA (2)</li> <li>- Cross-shaped channel chips (100 µm width/100 µm depth), T-junction, material: PMMA (2)</li> <li>- Cross-shaped channel chips (100 µm width/100 µm depth), T-junction, material: Zeonor (2)</li> <li>- Single-use syringes, 1 ml (10)</li> <li>- 10 ml mcs buffer 03 (separation buffer)</li> <li>- ChipGenie® edition E2 starter kit 3 – standards: Cation standard solution, Li<sup>+</sup>, Na<sup>+</sup>, K<sup>+</sup> (1 ml) Anion standard solution, Cl<sup>-</sup>; NO<sub>3</sub><sup>-</sup>, SO<sub>4</sub><sup>2-</sup> (1 ml) Organic acid standard solution, tartaric acid, succinic acid, citric acid (1 ml)</li> </ul>	10000028 10000027 10000337 10000338 10000719 10000987 10000516	790.00
10000516	ChipGenie® edition E2 kit 3 – stan- dards	<ul style="list-style-type: none"> <li>- Cation standard solution, Li<sup>+</sup>, Na<sup>+</sup>, K<sup>+</sup> (1 ml)</li> <li>- Anion standard solution, Cl<sup>-</sup>; NO<sub>3</sub><sup>-</sup>, SO<sub>4</sub><sup>2-</sup> (1 ml)</li> <li>- Organic acid standard solution, tartaric acid, succinic acid, citric acid (1 ml)</li> </ul>		78.20



### 10.3 On-chip sample-preparation system – ChipGenie® edition P

ChipGenie® edition P – a compact lab device which is ideally suited for your microfluidic bead-based on-chip sample preparation. Potential applications that can be implemented using ChipGenie® edition P are the purification of nucleic acids, cell lysis or hybridization experiments in combination with the continuous flow principle, making it a multi-purpose analytical tool.

The ChipGenie® edition P features a click-in holding frame, in order to operate standard microscopy slide format microfluidic chips. The instrument is equipped with a uniform linearly moving magnet (speed of 4 mm/s), as well as a heating element (adjustable between room temperature and 60°C) both controlled independently by switches. These sample preparation units are located below the chip, which serves as the reaction chamber of the system.

The bench top device comes with a 6V, 3,5A DC power supply and offers convenient handling features. This includes a LED signal that indicates the current operating status, as well as an LCD screen to display the set temperature and current temperature. The arrangement of the switches provides a comfortable handling for pipetting in manual use.

The instrument	<ul style="list-style-type: none"> <li>• Microscopy slide format chip holding frame</li> <li>• Adjustable heating element</li> <li>• Permanent magnetic mixer element</li> <li>• Temperature display</li> </ul>
The microfluidic chip	<ul style="list-style-type: none"> <li>• Reaction chamber of the system</li> <li>• Interface for liquid in- and output</li> <li>• Carrier of the magnetic beads</li> </ul>

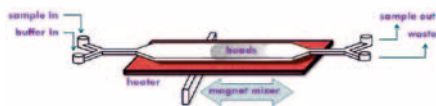

Fig. 541: Principle of a bead-based assay with the ChipGenie® edition P instrument



Fig. 542: ChipGenie® edition P instrument with inserted chip

When starting an analysis using ChipGenie® edition P, the microfluidic chip is inserted into the holding frame. The liquid supply is implemented via the chip interface enabling a manual (pipette) or semi-automatically (pump-system) operation. For routine sample preparations chapter 13 highlights our kits for an immediate start of your analysis. Those kits enable DNA extraction from whole blood or from bacterial suspensions. A suitable protocol, exhibiting a temperature profile and the bead-based mixing conditions may be established according to the one exemplarily shown in our applications notes in chapter 15.

The ChipGenie® edition P can be operated with a variety of microfluidic rhombic chamber chips with lengthwise chamber orientation (please refer to Chapter 3.6.1.1). They are available in different materials, such as COC, PC or PMMA. To achieve maximum reliability of your analysis, the chips are considered as disposals and hence recommended to be replaced after each analysis.

Product Code	Description	Dimensions [cm]	Price [€/instrument]
10000166	ChipGenie® edition P instrument	10 x 15 x 3.5	695.00



## 10.4 ChipGenie® edition BD

microfluidic ChipShop's blister driver ChipGenie® edition BD is the tailored instrument for evaluation of blister emptying behavior. Blisters offer a reliable long-term liquid storage option on-chip. The device has been specifically developed to be used with microfluidic ChipShop's microscope slide-format blister test chips Fluidic 289 and Fluidic 522. The instrument ensures both a convenient, user-friendly chip insertion and a precise positioning of the inserted blister chip. Blister emptying is facilitated by two independent, high-precision vertical blister drives, while an integrated camera gives immediate visual feedback.

The instrument	<ul style="list-style-type: none"> <li>• Two independent, high-precision vertical blister drives (driver speed 0.1 <math>\mu\text{m/s}</math> up to 200 <math>\mu\text{m/s}</math>; positioning accuracy <math>\pm 20 \mu\text{m}</math>)</li> <li>• Integrated camera for direct visual feedback</li> </ul>
The microfluidic chip	<ul style="list-style-type: none"> <li>• Microscope slide format with mounted blister pouches for liquid storage</li> <li>• Enables liquid metering and flow rate test</li> <li>• Customized blister filling service is available</li> </ul>
The software	<ul style="list-style-type: none"> <li>• User friendly program allowing system control</li> <li>• Connection established via USB port</li> </ul>



Fig. 543: Blisters of blister test chip being actuated by the ChipGenie® edition BD instrument



Fig. 544: The blister test chip Fluidic 522 can be operated with ChipGenie® edition BD

Product Code	Description	Dimensions [cm]	Price [€/instrument]
10000686	ChipGenie® edition BD – Blister Driver instrument	20 x 12 x 11	2.685,00



## 10.5 ChipGenie® edition TV

ChipGenie® edition TV enables a strict control of turning valves. The device rotates the valves and sets exactly the experimental time frame – when and how each valve should be positioned. Countless experimental set-ups can be generated by combining the wide variety of *microfluidic ChipShop*'s valves.

The instrument	<ul style="list-style-type: none"> <li>• Two independent, high-precision 360° turning valve drives (positioning accuracy: +/- 1°)</li> <li>• Integrated camera for direct visual feedback</li> <li>• Integrated peristaltic pump with selectable flow rates for liquid actuation</li> </ul>
The microfluidic chip	<ul style="list-style-type: none"> <li>• Enables various turning valve applications (e.g. metering loops, liquid routing)</li> <li>• Large variety of turning valve-containing microfluidic chips is available</li> </ul>
The software	<ul style="list-style-type: none"> <li>• User friendly program allowing system control</li> <li>• Connection established via USB port</li> </ul>

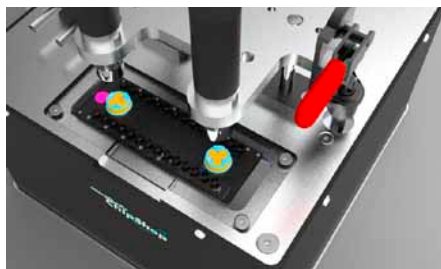

Fig. 545: Principle of valve turning with ChipGenie® edition TV (turning valves depicted in blue/yellow)

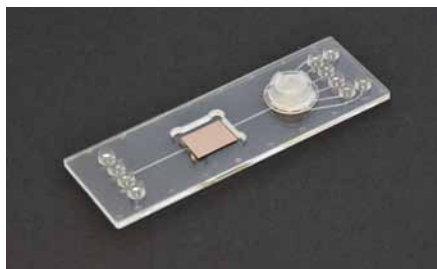

Fig. 546: Microfluidic chip containing a turning valve and an additional sensor integration area - Fluidic 673

Product Code	Description	Dimensions [cm]	Price [€/instrument]
10000787	ChipGenie® edition TV – Turning Valve instrument	17 x 18 x 16	3.350,00



### 10.6 ChipGenie® I instrument – Pipetting system

ChipGenie® I instrument offers pipetting of chips in the format of a microtiterplate with 1536 spacing. Microfluidic chips having the size of a microscopy slide can be fitted in respective microtiter plate sized handling frames to be handled with the pipettor.

The ChipGenie® I instrument is a merger of lab-on-a-chip and labautomation, liquid supply is managed by the pipettor, the liquid control on chip is ensured through the fluidic design.

As an example chips being used with the ChipGenie® I instrument the IFSA 1 Immunoassay Chip is shown below allowing for a microfilter-based sample enrichment prior to colorimetric detection.

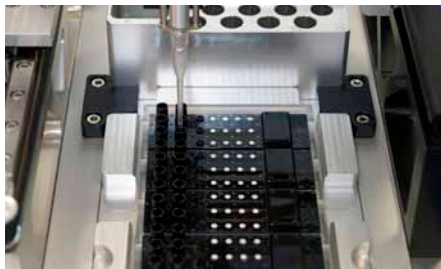

Fig. 547: Chips in microtiter sized handling frame placed in ChipGenie® edition I instrument

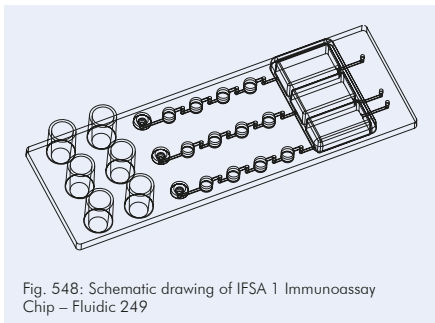
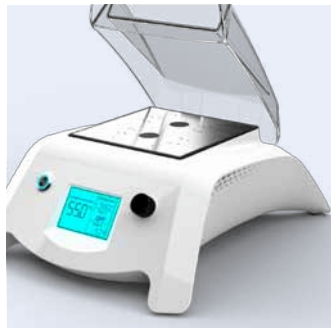

Fig. 548: Schematic drawing of IFSA 1 Immunoassay Chip – Fluidic 249

Product Code	Short product description	Price [€]
10000805	ChipGenie® edition I pipetting instrument	14,240.00







# 11 Special instruments



## Special instruments

This chapter compiles special instruments like incubators for cell-based assays, a dielectrophoresis unit and spotting instrumentation. Furthermore, instruments from our partner companies are featured in this chapter.



### 11.1. Handling platforms and incubators

#### 11.1.1 Lab-on-a-Chip Handling Platform / Cell Culture Incubator – LOC HP & LOC CCI

The Lab-on-a-Chip Handling Platform – LOC HP is a versatile device to enable quick and easy fluidic interface connection. The LOC HP is designed for three microfluidic interface configurations: two interface configurations with the fluidic interfaces at the shorter sides of the microfluidic chip and one at the longer sides, addressing openings with a 4.5 mm spacing exactly matching the spacing of a 384 well microtiter plate. With this, the LOC HP and the LOC CCI are compatible with many of our off-the-shelf microfluidic chips with Mini Luer and through-hole interfaces.

Through the fluidic interfaces, external pumps and valves can be connected via tubing with the microfluidic device without touching the device itself. The LOC HP can be upgraded to the Lab-on-a-Chip Cell Culture Incubator – LOC CCI 1 by the addition of a heating element.

The **Lab-on-a-Chip Cell Culture Incubator** – LOC CCI 1 enables to carry out cell-based assays in microfluidic chips placed in this incubator to be easily mounted on a microscope stage. Microfluidic chips can be directly placed in the frame that allows for the desired temperature on the chip due to integrated heating elements. The fluidic interfaces are directly integrated in the **Lab-on-a-Chip Cell Culture Incubator** – LOC CCI 1 to achieve an easy liquid supply and removal without interfering with the optical detection zone.

Various kinds of applications can be facilitated on chip with the help of the **Lab-on-a-Chip Cell Culture Incubator** – LOC CCI 1:

- Cell-based microscopy assays
- Long-term cell culture experiments ( e.g. co-cultures, cytotoxic/ pharmacological effect analysis, cell migration and many more)
- Live cell imaging

Features that the **Lab-on-a-Chip Cell Culture Incubator** – LOC CCI 1 offers:

- Standard microtiter plate format; fits with all inverted microscopes having a 96 well plate holder or frame.
- Integrated heating system for excellent cell culture conditions.
- For standard cell culture no additional gas incubation is necessary.
- Cell culture is comparable to standard CO<sub>2</sub>-incubator.
- Compatible with all standard microscope slide formats
- Microfluidic interface integrated allowing for liquid handling for long-time assays without additional handling steps.

The fluidic operation of the **Lab-on-a-Chip Cell Culture Incubator** – LOC CCI 1 is done best with connected pumps.

For glass microfluidic chips with slightly thicker chip thickness the LOCHP/CC1 series is at hand.



Fig. 549: Complete setup of the Lab-on-a-Chip Cell Culture Incubator – LOC CCI 1 with temperature control unit



Fig. 550: Lab-on-a-Chip Cell Culture Incubator – LOC CCI 1 with interchangeable adapter plates

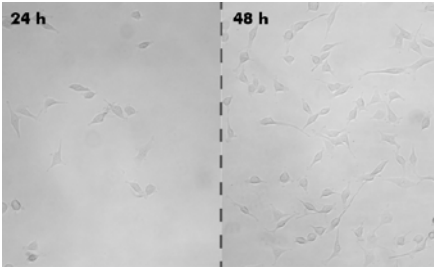

Fig. 551: HeLa Cells cultured and observed utilizing the Lab-on-a-Chip Cell Culture Incubator – LOC CCI 1.



Fig. 552: Lab-on-a-Chip Cell Culture Incubator – LOC CCI 1 placed on a microscopy stage

Product Code	Description	Price [€]		
		included adapter plate 2x4	2x8	2x16
10000287	LOC HP w/o heating elements (incl. 1 adapter plate of your choice)	1,370.00		
10000743	LOC CCI 1 with heating elements (incl. 1 adapter plate of your choice)	1,875.00		
10001216	Additional adapter plate	390.00	390.00	390.00

Product Code	Description	Price [€]		
		included adapter plate 2x4	2x8	2x16
10000893	LOC HP w/o heating elements – handling frame for glass chips (incl. one adapter plate of your choice)	1,370.00		
10000699	LOC CCI 1 with heating elements – handling frame for glass chips (incl. one adapter plate of your choice)	1,875.00		
10001216	Additional adapter plate	390.00	390.00	390.00

Product Code	Description	Detail	Product Code	Price [€]
10000286	LOC-CCI 1 starter kit 1	- Male Mini Luer plugs, red, material: PP (10)	10000053	638.32
		- Rhombic chamber chip, 120 $\mu$ l chamber volume, 500 $\mu$ m channel depth, hydrophilized, material: Topas (10)	10000244	
		- Rhombic chamber chip, 100 $\mu$ l chamber volume, 600 $\mu$ m channel depth, hydrophilized, material: Topas (10)	10000405	
		- Rhombic chamber chip, 250 $\mu$ l chamber volume, 800 $\mu$ m channel depth, hydrophilized, material: Topas (10)	10000365	
10000827	LOC-CCI 1 tool kit	- Mini Luer interfaces (16) - Screw ferrules (16) - Screw locks (8) - PEEK tube (1 m) - PTFE tube (1 m)		219.00



### 11.2 Dielectrophoresis system DEP

With this system, which comprises an 8-channel high frequency signal generator (DEP1) and a microfluidic chip (DFC1) with integrated electrodes, single suspension cells can be trapped (up to two at a time) in a laminar flow of a given aqueous solution without any physical contacts to solid objects.

An ensemble of eight microelectrodes (an electric field cage) produces a high-frequency electromagnetic field that acts on the cells and forces them with micrometer precision to a defined position in the microfluidic channel of the chip. The forces acting on the cells are sufficiently strong to maintain the position of the cell against the flow of the solution in the channel.

By adding a reagent of interest (ligands, antibodies, signal molecules etc.) to the solution, the cell can be exposed to the reagent with high temporal resolution while the cellular response to it can be monitored by optical microscopy. As tested under various experimental conditions, cell viability is maintained for hours, under optimal conditions even for up to days.

- Specifications DEP1: weight 360 g, size w x d x h = 18 cm x 9 cm x 5.5 cm
- The system comes with connecting cable for the electrical contacts.
- Fluid connection to the chip is realized by olive connectors with OD of 1.6 mm and ID 0.7 mm



Fig. 553: Dielectrophoresis system DEP consisting of high frequency signal generator DEP1, microfluidic chip DFC1 and connecting cable

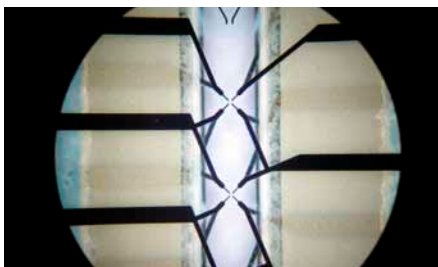

Fig. 554: Image of the field cage region of the chip DFC1

Product Code	Description	Price [€/instrument]
10000695	DEP1 High frequency signal generator for dielectrophoresis applications	3,850.00
10000696	DFC1 Dielectrophoresis chips. Set of 6 chips	1,875.00



### 11.3 DropBot – Digital microfluidic control system

**DropBot by Sci-Bots** is a portable, general-purpose Digital Microfluidic control system that can be used to manipulate discrete droplets using electrostatic forces on an insulated array of electrodes; a format also commonly referred to as **Electrowetting on a Dielectric (EWOD)**. This small and rugged instrument can be controlled via USB with easy-to-use software that supports graphical programming (i.e., users can simply click and drag drops using a real-time video overlay). Sequences of steps can be pre-programmed and run automatically, enabling fully automated operation.

#### Features:

- Integrated high-voltage source (up to 140 VRMS bipolar square waves at frequencies between 100 Hz–10 kHz)
- 120 independent channels connected to the chip via spring loaded pogo-pins
- Dynamic impedance sensing providing real-time measurement of drop position/velocity
- Extensible software supports easy integration/control of new sensors and actuators via plugins

#### Applications:

- Sample preparation
- Immunoassays
- Chemical synthesis
- Cell-based assays
- Adherent
- 3D cell culture

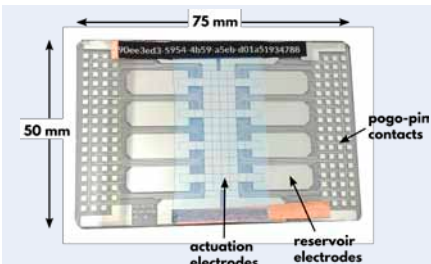

Fig. 555: Footprint and general layout of the electrowetting platform



Fig. 556: DropBot instrument for manipulation and read-out

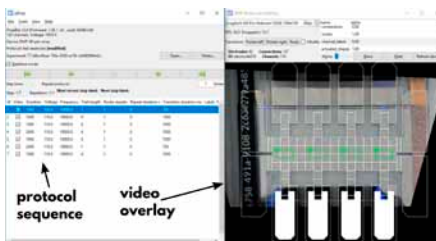

Fig. 557: MicroDrop – the Graphical User Interface



Product Code	Description	Price [€/instrument]
10001222	DropBot platform incl. $\mu$ Drop software	4,780.00

Product Code	Description	Price [€/piece]	
		1+	10+
10001133	Generic glass DMF Chip	89.50	84.50

### 11.4 Active Microfluidic Mixing with MXR from Redbud Labs

MXR by Redbud Labs – Make any chamber a mixing chamber: MXR adds active mixing to microfluidic systems. Using a combination of pumping and chaotic advection, MXR gently agitates volumes from 1–100  $\mu$ L. MXR is ideal for enhancing assays that are limited by mass transport, including:

- Hybridization and microarray incubation
- Mixing of liquids and resuspension of dried reagents
- Fluid exchange

MXR can be ordered pre-installed, or as a pop-in module. A simple peel-and-stick operation adds MXR to your chip.

MXR is powered by Redbud Posts – millions of flexible, magnetic micro-rods that act as tiny stirbars. To learn more about MXR and Redbud Post technology, visit [redbudlabs.com](http://redbudlabs.com).

#### 11.4.1 MXR Drivers – The Redbud STAGE

For temperature controlled assays, Redbud Stage enables simultaneous mixing and incubation of up to two MXR-enabled chips, with additional room to pre-heat reagents and set aside non-mixing control chambers. As your assay develops, Redbud Labs can design customized inserts to fully integrate the drive system with your instrumentation. A smaller MXR driver for applications where the heated stage is not necessary is available. Kindly contact us for more information.

#### 11.4.2 Customize any of microfluidic ChipShop's chips with MXR

Please contact us to learn how MXR can be customized to fit your application. MXR can be integrated into any of *microfluidic ChipShop's* wide variety of microfluidic solutions.

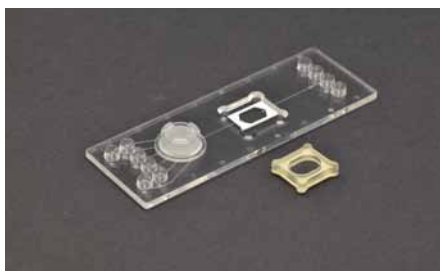

Fig. 558: Redbud Labs' MXR pillar-mixer integrated in microfluidic ChipShop's generic sensor platform (Fluidic 673)

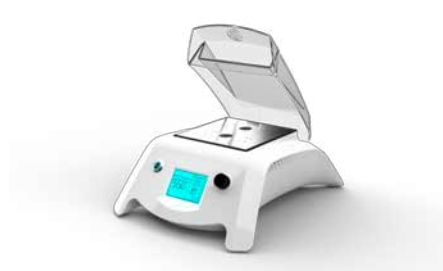

Fig. 559: Redbud Stage agitation and heating platform

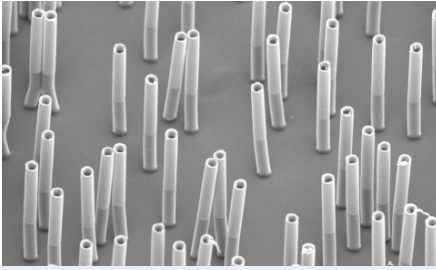

Fig. 560: MXR is powered by RedBud Posts

Product Code	Description	Price [€/instrument]
10001223	Redbud Stage	9,999.00
10001224	MXR for 10000794 (any microfluidic ChipShop's standard material) MXR customized for other microfluidic ChipShop chips	44.00 Contact us

### 11.5 Spotter Instrumentation

Based on long-term experiences, we recommend M2-Automation as partner for easy to use and robust micro-dispensing (spotting) solutions. In particular, we endorse the instrumentTWO-200 in order to start right away with your own spotting tasks.



Fig. 561: M2-Automation instrumentTWO-200 in action

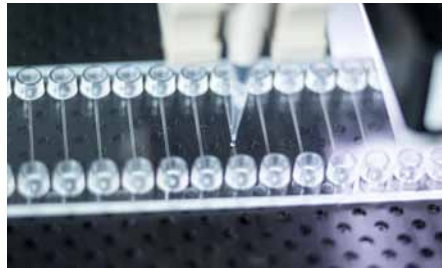

Fig. 562: instrumentTWO-200 spotting in microfluidic devices DNA-Array embedded in a microfluidic channel



Fig. 563: M2-Automation instrumentTWO-200



Fig. 564: instrument TWO-200 spotting in microfluidic devices DNA-Array embedded in a microfluidic channel

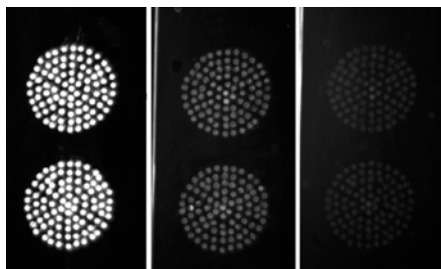

Fig. 565: Spotted fluorescent probes (spot diameter 80  $\mu\text{m}$ ) in channel of one channel Luer chip. Concentrations (left to right) 100  $\text{ng}/\mu\text{l}$ , 10  $\text{ng}/\mu\text{l}$ , 1  $\text{ng}/\mu\text{l}$



Fig. 566: instrumentTWO-200

M2-Automations Triple-Jet Technology combines in a single instrument three different micro-dispensers: the Piezo driven micro dispenser (PDMD, 20 pL+) for picolitre volume applications, the solenoid valve driven micro-dispenser (SDMD, 20 nL+) and the proprietary M2-microdispenser (M2MD, 10 nL+), both for nanoliter, microliter and low milliliter volume applications. By adjusting the dispensing parameters, the user can optimize droplet flight path, velocity and volume, ensuring accurate placement of features onto the substrate.

The spotter features an accurate ( $\pm 20 \mu\text{m}$  XY precision) motion system together with a unique positioning system of the substrate trays. An overhead digital camera is used for target teaching and visualization, detection, alignment, documentation and quality control.

The instrumentTWO-200 is supplemented by a powerful software package, providing an intuitive interface flexible to meet specific individual needs, for the creation of customized procedures or personalized array layouts. While the creation of experiments is simple and suited for most customer demands it is incorporating a high level of flexibility, allowing the user maximum control.

### Technical data:

- Capacity: 2MTP-sized positions
- Piezo driven micro-dispensing devices
- Volume range: 20 pL to 300 pL per single droplet
- CV of dispensed volumes: approx. 1%
- Volume range 10 nL to mL per single ejection
- Solenoid volume ranges 10+ nL, 30+ nL, 40+ nL, 10 - 50 nL, 20 - 200 nL
- Dispense modes: aspirate and dispense; resuspend samples; dispense out of large volume source vials
- Chemically inert and biologically compatible
- Maximum drive range: X = 200mm, Y = 200 mm, Z = 50 mm
- Single increment resolution: 10 $\mu\text{m}$
- Positioning accuracy in XY directions  $\pm 20 \mu\text{m}$
- Maximum speed: X = 0.3 m/s, Y = 0.3 m/s, Z = 0.1 m/s

Product Code	Description	Starting at Price per instrument [€]
10001260	instrumentTWO-200 spotter	40,000.00





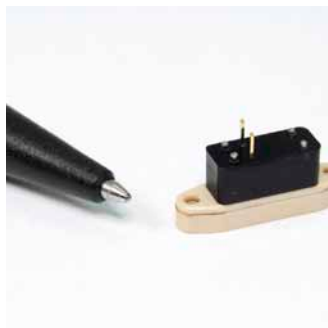

## 12 Pumps and pressure controllers

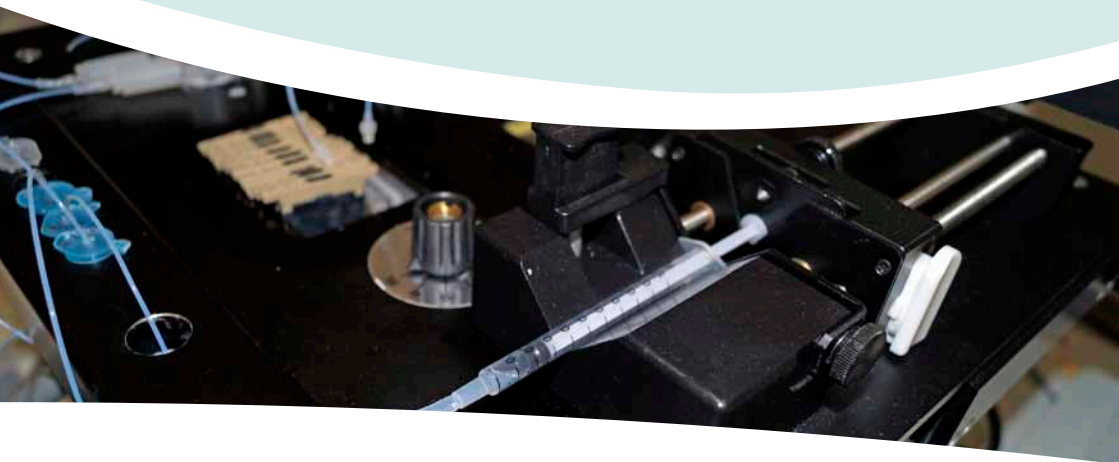

### Pumps and pressure controllers

For most microfluidic experiments, external systems to actively move liquids are needed. Depending on the application, different methods to actuate the fluids are available. In principle, one can differentiate between pumps and pressure controllers. Pumps such as syringe or peristaltic pumps shown in the following pages generate a constant flow rate while pressure generators generate a constant pressure by pressurizing a reservoir which is connected to the microfluidic device. We have selected a range of instruments to be able to offer the best solution for a given application.

### 12.1 MicCell Fluid Processor

The MicCell Fluid Processor system contains all macroscopic actuators that control liquid handling: syringe pump(s), macrovalves (either turn/selector valves or simple on/off valves), and/or the control electronics for hydrogel microvalve(s). It can be controlled by a graphics-oriented Windows software.

The picture shows the MicCell FP-1-1-standard Fluid Processor that contains a syringe pump with 3-way valve (left), a hydrogel valve control and a 2/2 macrovalve (middle) and a 4/1-selector valve (right). Other configurations are available.

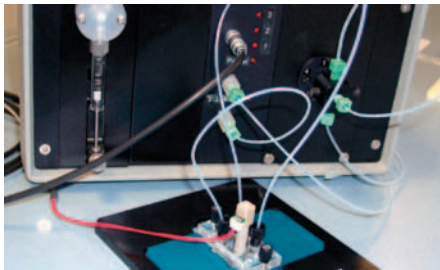

Fig. 567: MicCell FP-1-1-standard Fluid Processor.  
 Foreground: MicCell with hydrogel valve in its blue support and black adapter plate

Product Code	System Type	Product description	Price [€/instrument]
10001242	MicCell FP-1-1-standard	1x syringe pump, 1x 1/4-selector valve, 1x 2/2-macrovalve, 1x hydrogel valve control	5,565.00
10001243	MicCell FP-2-0	2x syringe pumps (no 1/4-selector valve, no 2/2-macrovalve, no hydrogel valve control)	5,565.00
10000382	MicCell FP-2-1	2x syringe pumps, 1x 1/4-selector valve (no 2/2-macrovalve, no hydrogel valve control)	7,402.00
10000617	MicCell FC1 Software	For the interactive control of 1-8 syringe pumps	1,018.00



## 12.2 Hydrogel micro valves

The GeSiM hydrogel valves are small silicon chambers filled with hydrogel particles of defined size that dramatically shrink upon heating to more than 34°C, therefore opening the normally closed microvalves. Different valve designs are available, the standard PV6 valve being vertically flown through by the liquid. By mounting it inside a standard UNF fitting, a microfluidic injector is obtained that controls an inlet channel of a branched (e.g. T/Y-shaped) MicCell fluid system. In an alternative design, the hydrogel valve is connected to a reservoir via a tube. The valve is controlled by an electronic module in the Fluid Processor.

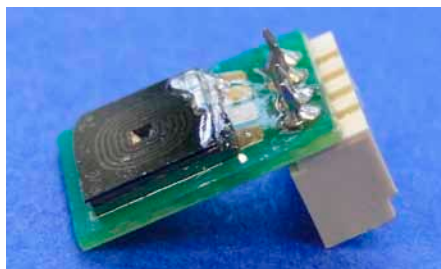

Fig. 568: PV6 hydrogel-containing silicon chip on a printed circuit board (top view)

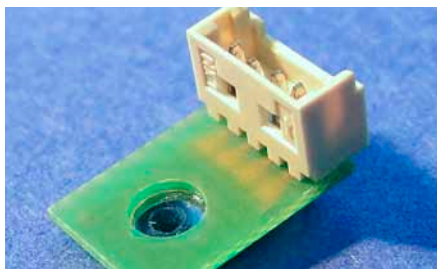

Fig. 569: PV6 hydrogel-containing silicon chip on a printed circuit board (bottom view)

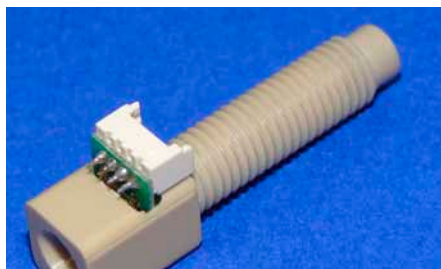

Fig. 570: PV6 injector, ready to use, in UNF 1/4-28 fitting

Product Code	Description	Features	Price [€/chip]		
			1+	5+	10+
07-461-0000-00	Hydrogel-Valve PV6, tube	Valve chip on PCB in PEEK fitting 1/4-28 UNF; inlet: Teflon tube OD=1.58 mm with Upchurch ferrule, electrical connector DC input 3.5 V/0.1 A	577.00	519.00	477.00
07-462-0000-00	Hydrogel-Valve PV6, injector	Valve chip on PCB in PEEK fitting 1/4-28 UNF; inlet: open funnel, electrical connector DC input 3.5 V/0.1 A	577.00	419.00	477.00



### 12.3 Cellix pump systems

Cellix offers precision microfluidic pumps for a wide range of applications. Key features and benefits of these microfluidic pumps include:

- Pulse free syringe pumps
- Single and multichannel control
- Multiple independent channel pumping
- Patented active flow control for accurate sample delivery
- Simple, easy-to-use control via iPad mini, iPod Touch, PC
- Ideal for microfluidics, shear stress, precision mixing and cell culture studies.

#### 12.3.1 ExiGo™ Microfluidic Syringe Pump with iPad mini control

ExiGo™ pump is a microfluidic syringe pump controlled by an iPad mini. Suitable for numerous microfluidic applications, precise multichannel mixing, electrophysiology, single cell analysis, analytical biochemistry and RNA/DNA analysis.

##### Features:

- Precise flow control with active feedback via plug-and-play flow sensor (optional add-on)
- Flow rate: 10 nL/min–2 0mL/min  $\pm$ 0.5%
- Standard syringes: 100  $\mu$ L–5 mL
- Wash mode or programmable perfusion mode (constant, ramp, step, sine) with reversible flow direction
- Rapid flow change (ms range)
- Excellent long-term flow stability
- iPad mini or PC (LabVIEW, Matlab, Python etc.) control which can control/program up to 4 pump modules independently
- Wi-Fi communication
- Use standard tubing for connection to any microfluidic biochip



Fig. 571: ExiGo™ Pump, controlled by iPad mini



Fig. 572: iPad mini App SmartFlo App on iPad mini for ExiGo™ /UniGo™ pumps



### 12.3.2 ExiGo™ Manifold

The ExiGo™ manifold is a specialised microfluidic channel selector designed to work with an ExiGo pump. The manifold allows the ExiGo pump to direct fluid to one of three microfluidic channels at a time. Accurate flow switching and low dead volume provide exceptional performance.

The ExiGo manifold can be programmed to automatically switch between fluidic channels using the SmartFlo PC software.

The ExiGo Manifold is an extremely useful tool for applications which require:

- Automatic refilling of the syringe
- Asynchronous injection of a reagent in multiple channels
- Continuous perfusion over long periods of time



Fig. 573: Manifold for refilling syringe or switching reservoirs: optional accessory for ExiGo™ pump



Fig. 574: ExiGo™ pump and attached manifold

### 12.3.2 UniGo™ Pump

UniGo™ microfluidic pump is a precision, microfluidic, single-channel pressure pump for a variety of microfluidic applications, where accurate and stable flow rate delivery is required. The pressure pump component is based on controlled air injection. The UniGo pump requires a plug-and-play flow sensor for active feedback and increased flow control. SmartFlo application executed on the iPad mini or LabVIEW based interface communicates with up to 4 UniGo microfluidic pumps racked together allowing simultaneous control and independent programming of each pump's flow profile.

Uniquely, the UniGo pressure pump may be docked together with the ExiGo microfluidic syringe pump combining the best features of both UniGo and ExiGo in one microfluidic set-up.

#### Features:

- Precise flow control with active feedback via plug-and-play flow sensor (compulsory add-on)
- Flow rate: 1  $\mu\text{L}/\text{min}$ –1 mL/min; unidirectional (push)
- Wash mode or programmable perfusion mode (constant, ramp, step, sine) with reversible flow direction
- iPad mini or PC (LabVIEW, Matlab, Python etc.) control which can control/program up to 4 pump modules independently
- Use standard tubing for connection to any microfluidic biochip
- Internal and/or external compressor options



Fig. 575: UniGo™ Pump

### 12.3.4 Kima™ Pump

Kima™ pump is a microfluidic recirculating pump controlled by an iPod Touch or PC. Suitable for continuous microbe and cell culture under shear flow mimicking physiological flow in the human vasculature. Applications include biofilm studies, cell culture in biochips with adherent cells (HUVECs), stem cells, HepG2 cells.

#### Features:

- Fits inside standard CO2 incubator maintaining temperature, humidity etc
- Recirculating long term perfusion pump
- Wash mode or pump mode
- Dead volume: <math><300\ \mu\text{L}</math>
- iPod Touch or PC control option which can control up to 4 pump modules independently
- Wi-Fi communication
- Includes tubing kit for Vena8 biochips or alternative tubing kits for other biochips available

NOTE: the Kima pump is not suitable for shear stressed based assays because the pump delivers liquid in pulses (not continuous flow).



Fig. 576: Kima pump, controlled by iPod Touch



Fig. 577: iPod Touch app for Kima pump showing perfusion

### 12.3.5 Mirus Evo Pro™ — PC Controlled via VenaFlux Assay Software

Mirus Evo Pro is a microfluidic syringe pump PC controlled via VenaFlux assay software. Suitable for microfluidic applications, single cell analysis and cell analysis under shear flow in biochips mimicking physiological flow in the human vasculature. Compatible with cell suspension samples and whole blood samples.

#### Features:

- Includes MultiFlow8 for precision flow splitting with equal flow rate in each channel
- MultiFlow8 contains 8 valves which can be switched on/off independently
- Higher throughput enabling 8 assays in parallel
- Patented flow damper to decrease syringe pump pulses
- Flow rate: 100 nL/min–10 mL/min  $\pm$  1% (syringes available: 50  $\mu\text{L}$ –5 mL)
- Dead volume:  $\sim$ 600  $\mu\text{L}$
- Flow direction reversible
- PC controlled via VenaFlux assay software



Fig. 578: Mirus Evo nanopump with MultiFlow8: controlled by PC software, VenaFlux assay (included)





Product Code	Description	Price [€/instrument]
10001245	ExiGo™ pump; 1 x LabVIEW for PC; 1 x tubing kit; power supply and cables.	3,591.00
10001088	ExiGo™ pump; 1 x iPad mini with SmartFlo App; 1 x flow sensor (7.0ul/min); 1 x manifold; 1 x tubing kit; power supply and cables	5,144.00
10001422	UniGo™ pump; 1 x external compressor; 1 x LabVIEW for PC; 1 x flow sensor (80.0ul/min); 1 x tubing kit; power supply and cables.	4,821.00
10001424	Manifold for ExiGo™ Pump	925.00
10000621	Kima™ pump; 1 x iPod Touch with iKima App; 1 x iPod Dock (controller); 1 x tubing kit; 1 x 100mL bottle with GL45 cap; power supply and cables; Velcro strips to secure iPod Dock to CO2 incubator.	2,695.00
10001246	Kima™ pump; 1 x tubing kit; 1 x 100mL bottle with GL45 cap; power supply and cables.	1,195.00
10001247	MIRUS-PUMP-EVO, 1x syringe pump; 1x MultiFlow8; 1x VenaFluxAssay Software; 1 x tubing kit; power supply and cables	9,595.00

## 12.4 FLUIGENT – Ultraprecise fluid control systems

FLUIGENT develops, manufactures, and commercializes innovative fluid handling solutions for a variety of rapidly growing applications where fluid control matters.

For exemplifying applications of FLUIGENT's flow-control technology, please review the following publications:

- Ryckelynck M, Baudrey S, Rick C, Marin A, Coldren F, Westhof E, Griffiths A; Using droplet-based microfluidics to improve the catalytic properties of RNA under multiple-turnover conditions, *RNA*, 2015, 21(3), 458-469.
- Hudson S, Sarangapani P, Pathak J, Migler K; A microfluidic capillary rheometer for characterization of protein solutions, *J Pharm Sci*, 2015, 104(2), 678-685.
- Kardash E, Reichman-Fried M, Maître JL, Boldajipour B, Papusheva E, Messerschmidt EM, Heisenberg CP, Raz E: A role for Rho GTPases and cell-cell adhesion in single-cell motility in vivo, *Nat Cell Biol*. 2010, 12(1), 47-53

### 12.4.1 LineUP™ series most advanced flow controller

Main characteristics of the LineUp™ flow controllers:

- Complete solution, start your experiments in minutes
- Spend more time on results: no cumbersome setups
- Increased repeatability

A complete solution with the highest flexibility and ease of use. Choose the number of flow control modules your experiment requires and you are ready to start. Need additional channels? Just add an additional Flow-EZ™ to your setup. Connect the Link to communicate with external devices and software to work on more advanced time based protocols in minutes.



Fig. 579: Fluigent's Flow-EZ™ flow controller

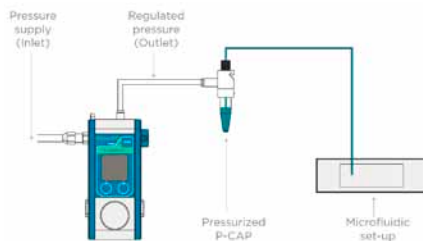

Fig. 580: Schematic set-up of Fluigent's Flow-EZ™ flow controller

- Output pressure stability: highly monodispersed droplet size - No oscillation
- System settling time: no transitory regime - Reagent savings - Stop-flows
- Pressuring gas: non-corrosive or explosive gas (pressurized air recommended, or N<sub>2</sub>, Ar, O<sub>2</sub>, ...)
- No contamination between the Flow™-EZ and the solutions and between the solutions
- Size: L 125 x W 55 x H 75 mm
- Weight: 625 g (1.4 lbs)
- Output connectors: Speedfit® 4mm OD tube connectors
- Wide range of volume can be controlled - No compromise between volume and stability
- Various pressure ranges available:

Positive pressure ranges: 0 to 25 mbar  
0 to 69 mbar  
0 to 345 mbar  
0 to 1000 mbar  
0 to 2000 mbar  
0 to 7000 mbar

Negative pressure ranges: 0 to -25 mbar  
0 to -69 mbar  
0 to -345 mbar  
0 to -800 mbar

Possibility to connect up to 16 Flow EZ™ modules on the same set-up.

Example of applications:

- Droplet generation and manipulation
- Organ-on-chip
- Beads manipulation
- Kinetics measurements
- Biological applications (blood / cells)
- Microfluidic flow control

Product reference	Product Name	Price [€]
11-0890-0000-00	Flow EZ™ module	contact us



### 12.4.2 MFCS™-series pressure-based flow controllers

The MFCS™-series is a compact microfluidic flow control system with the most recognized, compact 4 channels microfluidic controller. Designed to optimize bench space, the MFCS™-EZ is a convenient 4 channel microfluidic systems. Its proven technology with lab-on-a-chip, droplets, cell handling or particle manipulation applications and more, is cited in more than 800 papers.

Main characteristics of the MFCS™-series pressure-based flow controllers:

- Easy to install and use
- Easy to automate
- Fast and stable
- Field proven technology

The respective flow controller and the set-up of the overall system and connection to the microfluidic device are highlighted in the figures below.



Fig. 581: Fluigent's MFCS™-EZ pressure-based flow controller

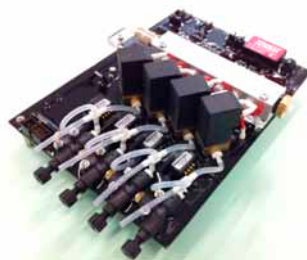

Fig. 582: OEM version of Fluigent's MFCS™-EZ pressure-based flow controller for pre-industrial or industrial applications

Pressure ranges	0 – 345 mbar	0 – 800 mbar	0 – 1000 mbar	0 – 2000 mbar	0 – 7000 mbar
Type of pressure available	Both push and pull	Pull only	Push only	Push only	Push only
Output pressure stability	Highly monodispersed droplet size - no oscillation				
Volumes	Wide range of volumes can be controlled. No compromise between volume and stability.				
Settling time	No transitory regime - Reagent savings -Stop flows				
Pressurizing gas	Non corrosive or explosive gas (pressurized air recommended, or N <sub>2</sub> , Ar, CO <sub>2</sub> )				
Size	16 x 23 x 6.5 cm <sup>3</sup> (6.3 x 9 x 2.5 inch <sup>3</sup> )				
Weight	2.0 kg (4.4 lbs)				
Output connectors	Female Luer lock				4 mm OD tube connectors
Flexibility	Any mix of pressure ranges is available, even on one MFCS™-EZ				

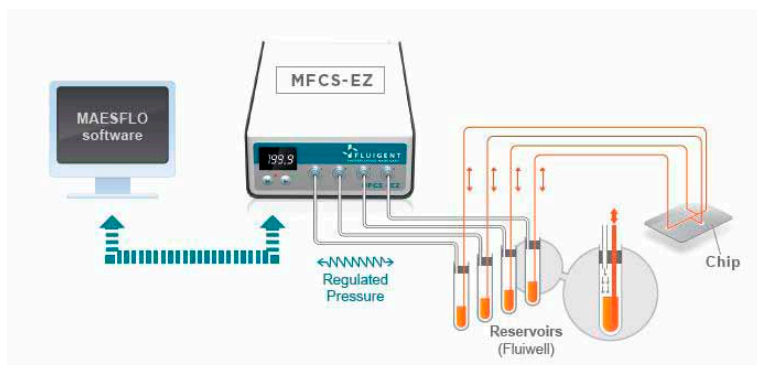

Fig. 583: Schematic set-up of Fluigent's MFC5™-EZ pressure-based flow controller with fluid reservoir and connection to the microfluidic device

Product Code	Description	Price [€]*
10001389	Fluigent MFC5™-EZ base - basic	
10001390	Fluigent MFC5™-EZ base - positive pressure source	please
10001391	Fluigent MFC5™-EZ base - negative pressure source	contact us
10001392	Fluigent MFC5™-EZ channel (various pressure ranges available)	

\*: including MAESFLO™ software

### 12.4.3 ESS™ fluid handling Platform

The ESS™ is a unique fluid handling platform enabling automated selections and injections of fluids thanks to three powerful bidirectional valves:

- 2-Switch™ valve for sorting
- M-Switch™ 10-way bidirectional valve for sequential injection
- L-SWITCH™ for recirculation

#### The elements of the fluid handling platform

##### New 2-SWITCH™ 2-way bidirectional valve



The new 2-Switch™ is a compact and easy to use 3-port/2-way microfluidic valve. Using standard connectors it can be integrated to any microfluidic setup. Its unique design allows to stack multiple 2-Switches™ together to save space on your benchtop.

The 2-Switch™ may be used as a manually-operated, stand-alone device or controlled by our software for long-term experiments. Its versatility makes it ideal for applications where fluid sorting, switching or periodic sampling is required such as fluid sorting and can be easily adapted into an on/off system.

- Rapid setup and ease of use
- Compact design to reduce the size of your setup
- Chemically and biologically compatible for sample integrity

New 2-Switch™ valve



### M-SWITCH™ 10-way bidirectional valve

A bidirectional 11-port / 10-way valve injecting and selecting up to 10 different liquids for sequential injections

- Chemical & biological compatibility (RPC-7)
- Low internal volume (11.6  $\mu$ L)
- Integrated fittings
- Software controlled – Full automation
- Possibility to connect up to 4 M-SWITCH™ on the same SWITCHBOARD
- No dead volume

M-Switch™ 10-way bidirectional valve



### L-SWITCH™ 6-Port/2-Position bidirectional valve

The L-Switch™ is a bidirectional 6-port/2 position valve for injection or switching different fluids. Its configuration makes it ideal for recirculation in cell culture.

- Easy to setup and use
- Chemically and biologically compatible (wetted materials: PEEK)
- For unidirectional recirculation for cell culture
- Repeatable injection of precise and small volume
- Low internal volume (660nL)
- Usable with or without a sample loop
- Automated and compact
- No dead volume
- Port-to-port switching: 100ms
- External fittings

L-SWITCH™ 6-Port/2-Position bidirectional valve

## Example applications using the fluid handling of ESS™

### Sequential injections

Up to 10 different reagents are selected and injected inside an on-chip reactor. The reagents are motioned and controlled by Fluigent (MFCS™-EZ + Flow Rate Platform) flow control devices, and injected into the chip when they are selected by the M-SWITCH™. All steps can be automated by the ESS™ Control software or MAT software.

- Cell analysis
- Cell lysis and DNA extraction
- PCR analysis
- Calibration curve

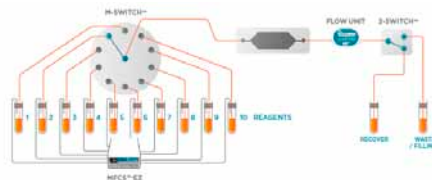



### Precise fluid injection

The sample is “loaded” into the sample loop connected to the L-SWITCH™ while the carrier buffer is injected directly into the chip. When the L-SWITCH™ is switched, the controlled volume included in the sample loop is “injected” into the chip with the carrier buffer. All steps can be automated by the ESS™ Control software. This kind of fluidic diagram can be very useful for cell culture.

- Cell culture
- Digital PCR
- Chromatography

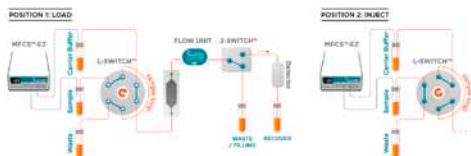

### Fluid switching

Reagents #2 and #3 are injected while Reagent #1 path is closed. At the downstream of the chip, a 2-SWITCH™ is used as a 2-way switch to easily sort the exiting flow and send the sample that you want to recover into a special reservoir, while the remaining fluid goes to the waste. All the 2-SWITCH™ can be automated so that the selection of reagents and the outlet sorting are fully synchronized.

- Chemical mixing reactions
- Stoichiometry study

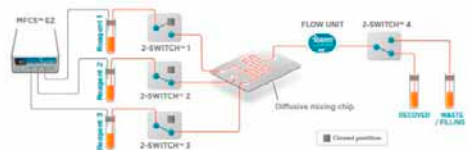

Product Code	Description	Price [€]
10000630	Fluigent 2-SWITCH™	
10000631	Fluigent M-SWITCH™	please
10000262	Fluigent L-SWITCH™	contact us
10000632	Fluigent Switchboard™	



### 12.4.4 FRP Flow-Rate Platform

The FRP Flow-Rate Platform enables to easily monitor\* and control\*\* the flow-rates in most microfluidic systems with superior precision and stability.

\*: available in stand-alone version for flow monitoring (can be installed on set-ups having no MFCS™ pressure controller)

\*\* : requires the Flow-Rate Control Module with a dongle in MAESFLO™ Software

Examples of applications:

- Droplet generation and manipulation
- Organ on chip
- Beads manipulation
- Kinetic measurements
- Biological applications (blood / cells)
- Microfluidic flow control

#### The elements of the FRP flow-rate platform



#### FLOW UNIT:

high-precision bidirectional flow sensor

5 models with different ranges for water, among which 3 models (S, M and L) with a dual calibration: water and hydrocarbon based liquids (comparable with oil, solvents, fuel, alcohol)

FLOW UNIT: high-precision bidirectional flow sensor



#### FLOWBOARD:

communication hub

A hub managing the communication between A-i-O software and up to 8 FLOW UNITS of any ranges and calibrations. Computer connection and power supply with a single USB plug

FLOWBOARD: communication hub

Performance characteristics of the different flow units					
FLOW UNIT	XS	S	M	L	XL
Calibrated media	Water	Water Isopropyl alcohol	Water Isopropyl alcohol	Water Isopropyl alcohol	Water
Range	0 - ±1.5 µl/min	0-±7 µl/min 0-±70 µl/min	0-±80 µl/min 0-±500 µl/min	0-±1 ml/min 0-±10 ml/min	0-±5 ml/min
Accuracy	10% m.v. between -1500 to -75 and 75 to 1500 nl/min	5% m.v. between -7 to -0.35 and 0.35 to 7 µl/min	5% m.v. between -80 to -2.4 and 2.4 to 80 µl/min	5% m.v. between -1 to -0.03 and 0.03 to 1 ml/min	5% m.v. between -5 to -0.2 and 0.2 to 5 ml/min
		20% m.v. between -70 to -1 and 1 to 70 µl/min	20% m.v. between -500 to -25 and 25 to 500 µl/min	20% m.v. between -10 to -0.5 and 0.5 to 10 ml/min	
	7.5 nl/min between -75 to 75 nl/min	17.5 nl/min between -0.35 to 0.35 µl/min	500 nl/min between -2.4 to 2.4 µl/min	1.5 µl/min between -30 to 30 ml/min	10 µl/min between -200 to 200 µl/min
Sensor inner diameter	25 µm	150 µm	480 µm	1.0 mm	1.8 mm
Wetted materials	PEEK and Quartz	PEEK and Quartz	PEEK and borosilicate glass	PEEK and borosilicate glass	PEEK and borosilicate glass

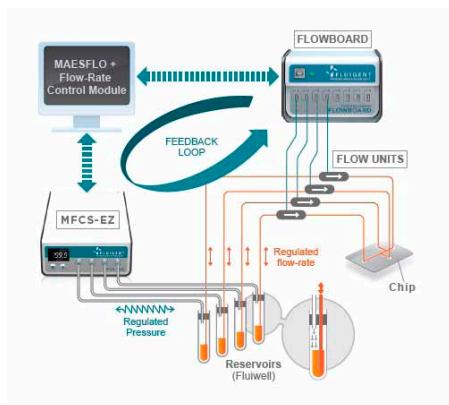

Fig. 584: Schematic set-up of flow-rate control or volume control using the FRP platform while keeping all the benefits of pressure actuation by MFC5™.

Product Code	Description	Price [€]
10000958	Fluigent flow unit	please contact us
10000385	Fluigent flowboard	
10000959	Fluigent flow-rate control module (regulation algorithm)	





## 12.5 Microdispenser and rotary valves by Advanced MicroFluidics

### 12.5.1 LSPone – Laboratory Sequential Microdispenser

Thanks to its zero dead volume valve, the LSPone is more accurate, easier to clean and reduces cross-contamination, compared to competing laboratory sequential pumps.

This microdispenser can replace a complex system with multiple pumps, valves, sampling loops and cumbersome cleaning systems, thus drastically simplifying your automation and making you gain precious time. With a single LSPone, you will obtain a high degree of flexibility and automation.

Compact, robust and self-cleaning fluidic automation is now achievable.

You can choose the perfect configuration for your setup by selecting the correct valve and syringe. Please note that all syringes and valve heads are interchangeable.

Customization possibilities include

- Wetted materials
- Fluidic fittings
- Fluid path diameter
- Number of ports



Fig. 585: LSPone laboratory sequential microdispenser

Product Code	Description	Price [€/instrument]
10001248	LSPone laboratory sequential microdispenser Includes: power cord, mini USB, syringe change tool, software	2 881.89

#### Syringes - Specifications

Product Code	Reference	Plunger material	Min. flow rate	Max. flow rate	Min. dosing volume	Price [€/piece]
10001393	S-25-P	PTFE	0.25 $\mu$ l/min	750 $\mu$ l/min	0.05 $\mu$ l	166.23
10001394	S-50-P	PTFE	0.5 $\mu$ l/min	1500 $\mu$ l/min	0.1 $\mu$ l	166.23
10001395	S-100-P	PTFE	1 $\mu$ l/min	3000 $\mu$ l/min	0.2 $\mu$ l	148.73
10001396	S-100-U	UHMW-PE	1 $\mu$ l/min	3000 $\mu$ l/min	0.2 $\mu$ l	148.73
10001397	S-250-P	PTFE	2.5 $\mu$ l/min	8000 $\mu$ l/min	0.5 $\mu$ l	148.73
10001398	S-500-P	PTFE	5 $\mu$ l/min	15000 $\mu$ l/min	1 $\mu$ l	148.73
10001399	S-500-U	UHMW-PE	5 $\mu$ l/min	15000 $\mu$ l/min	1 $\mu$ l	148.73
10001400	S-1000-P	PTFE	10 $\mu$ l/min	30000 $\mu$ l/min	2 $\mu$ l	148.73



### Valve - Specifications

Product Code	Reference	Configuration	Wetted materials	Internal volume*	Carry-over volume**	Fluid path diameter	Max. pressure	Price [€/piece]
10001401	V-D-2-6-050-C-P	Ultra-low carry-over volume	PCTFE, PTFE	5.2 $\mu$ l	1.5 $\mu$ l	0.5 mm	7 bars	231.85
10001402	V-D-1-6-050-C-P	Low carryover volume	PCTFE, PTFE	3.5 $\mu$ l	2.6 $\mu$ l	0.5 mm	7 bars	218.72
10001403	V-D-1-8-050-C-P	Low carryover volume	PCTFE, PTFE	3.5 $\mu$ l	2.6 $\mu$ l	0.5 mm	7 bars	223.10
10001404	V-D-1-8-100-C-U	Low carryover volume	PCTFE, UHMW-PE	18.1 $\mu$ l	11 $\mu$ l	1 mm	7 bars	332.46
10001405	V-D-1-10-050-C-U	Low carryover volume	PCTFE, UHMW-PE	4.5 $\mu$ l	2.8 $\mu$ l	0.5 mm	7 bars	341.21
10001406	V-D-1-10-100-C-U	Low carryover volume	PCTFE, UHMW-PE	18.1 $\mu$ l	11 $\mu$ l	1 mm	7 bars	341.21
10001407	V-D-1-12-050-C-U	Low carryover volume	PCTFE, UHMW-PE	4.5 $\mu$ l	2.8 $\mu$ l	12 mm	7 bars	349.96

\* volume inside the system, from entrance to exit

\*\*volume that will be flushed next time a liquid passes (cross-contamination)

### 12.5.2 RVM – Electric Rotary Valve

This OEM valve is a precise low-pressure electric rotary valve designed for automated microfluidic applications. Its small channels and accurate positioning system make it ideal for precise liquid handling. Showing an unrivalled small wetted volume and exceptional ease of use, this valve is the perfect match for liquid flow path management with the pumps that you decide to use. Please note that valve heads are interchangeable.

Customization possibilities include

- Wetted materials
- Fluidic fittings
- Fluid path diameter
- Motor
- Electrical interfaces
- Communication types
- Number of ports
- PCB

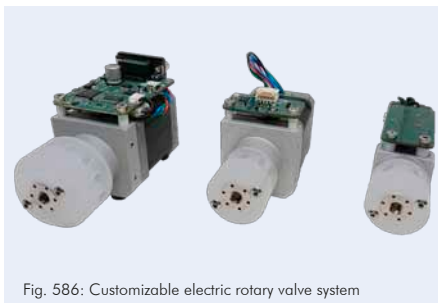

Fig. 586: Customizable electric rotary valve system



### Motor - Specifications

Product Code	Type	Power	Rotation time for 180°	Weight (total module)	Dimensions	Price [€/piece]
10001425	Low power motor	5-10 VDC, 0,5 A peak	1.5 s	250 g	29 x 38.3 x 11.8 mm	447.07
10001426	Fast motor	18-24 VDC, 2 A peak	400 ms	450 g	42.3 x 60 x 95.9 mm	396.33

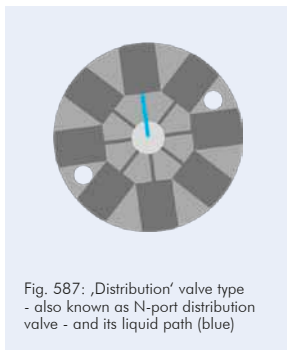

Fig. 587: 'Distribution' valve type - also known as N-port distribution valve - and its liquid path (blue)

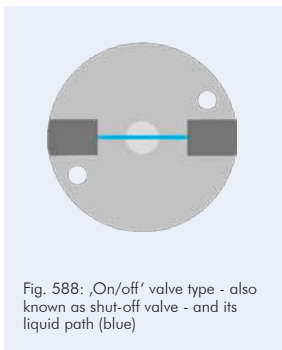

Fig. 588: 'On/off' valve type - also known as shut-off valve - and its liquid path (blue)

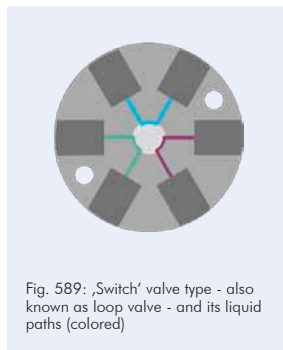

Fig. 589: 'Switch' valve type - also known as loop valve - and its liquid paths (colored)

### Valve - Specifications

Product Code	Reference	Configuration	Wetted materials	Internal volume*	Carry-over volumes**	Fluid path diameter	Max. pressure	Price [€/piece]
10001427	V-D-1-6-050-C-P	6 ports Distribution	PCTFE, PTFE	2.5 $\mu$ l	1.5 $\mu$ l	0.5 mm	0.5 mm	218.72
10001428	V-D-1-8-050-C-P	8 ports Distribution	PCTFE, PTFE	2.5 $\mu$ l	1.5 $\mu$ l	0.5 mm	0.5 mm	223.10
10001429	V-D-1-8-100-C-U	8 ports Distribution	PCTFE, UHMW-PE	13.8 $\mu$ l	6.7 $\mu$ l	1 mm	1 mm	332.46
10001430	V-D-1-10-050-C-U	10 ports Distribution	PCTFE, UHMW-PE	3.5 $\mu$ l	1.7 $\mu$ l	0.5 mm	0.5 mm	341.21
10001431	V-D-1-10-100-C-U	10 ports Distribution	PCTFE, UHMW-PE	13.8 $\mu$ l	6.7 $\mu$ l	1 mm	1 mm	341.21
10001432	V-D-1-12-050-C-U	12 ports Distribution	PCTFE, UHMW-PE	3.5 $\mu$ l	1.7 $\mu$ l	0.5 mm	0.5 mm	349.96
10001433	V-O-1-2-050-C-P	2 ports On/Off	PCTFE, PTFE	3.0 $\mu$ l	-	0.5 mm	7 bars	148.73
10001434	V-O-1-2-050-C-P	2 ports On/Off	PCTFE, PTFE	6.6 $\mu$ l	-	0.75 mm	7 bars	148.73
10001435	V-S-1-4-050-C-P	4 ports Switch	PCTFE, PTFE	2.8 $\mu$ l	0.8 $\mu$ l	0.5 mm	7 bars	153.11
10001436	V-S-1-6-050-C-P	6 ports Switch	PCTFE, PTFE	2.5 $\mu$ l	0.6 $\mu$ l	0.5 mm	7 bars	157.48
10001437	V-S-1-12-050-C-P	12 ports Switch	PCTFE, PTFE	2.3 $\mu$ l	0.5 $\mu$ l	0.5 mm	7 bars	400.00

\* volume inside the system, from entrance to exit

\*\*volume that will be flushed next time a liquid passes (cross-contamination)

### 12.6 Micropumps from Bartels Mikrotechnik

Micropumps transporting the finest amounts of gases or liquids can be considered the heart of microfluidics. In many sectors they have become indispensable. Dosing lubricants, feeding fuel cells with methanol or mixing starch into the steam of flat irons are only a few of the manifold tasks they fulfill. Many further fields of application for example are located in medical technologies and analytics. Extremely small in size and low in weight, with good particle tolerance and temperature resistance, Bartels micropumps are well prepared to be used in any of these sectors. As they are almost completely made of plastics, large quantities of these pumps can be produced at low cost and may well be used as disposables. These piezo-driven membrane pumps are available in starter kits to quickly enable the user to familiarize themselves with the technology. The kits contain three mp6 micropumps, a controller/controller board and suitable tubing.

Key features of micropump-series mp6:

- 30 x 15 x 3,8 mm
- 2 piezo actuators
- 2 g weight
- Self-priming

In case micropumps with increased resistance are required please do not hesitate to contact us and we are able to provide you with suitable solutions.



Fig. 590: mp6-go! set for pump evaluation



Fig. 591: mp6 basic set for pump evaluation

Product Code	Description	Price [€/instrument]
10000841	mp6-go! set, consisting of 3 mp6 pumps, controller and tubing	629.35
10000262	mp6-basic set, consisting of 3 mp6 pumps, controller board and tubing	249.00
10001119	mp6-pro set, consisting of 5 mp6 (PPSU), 5 mp6-OEM, 5 mp6-mol and 1 m mp-t ID1.3 mm	349.00
10000962	mp6-QuadEVA set, consisting of 4 mp6 (PPSU), 1 mp6-QuadEVA, 1 mini USB cable and 1 m mp-t ID1.3 mm	339.00
10001118	mp6-QuadOEM set, consisting of 4 mp6 (PPSU), 1 mp6-QuadOEM, 4 mp6-mol und 1 m mp-t ID1.3 mm	229.00
10000835	mp6-QuadKEY set, consisting of 4 mp6 (PPSU), 1 mp6-QuadKEY, 1 mini USB cable and 1 m mp-t ID1.3 mm	329.00



## 12.7 Pumps and Pressure Controllers by CorSolutions

### 12.7.1 PeriWave Fluid Delivery Pump by CorSolutions

The CorSolutions PeriWave is the only pulseless, peristaltic pump on the market. It offers high performance peristaltic-based fluid delivery with integrated flow sensors and closed-loop feedback technology. As the pump measures the actual flow rate and provides the information back to the motor, smooth pulse-less flow, as well as programmable wave functions are possible. The pump's high performance derives from the fact that fluid is measured, as compared to syringe and traditional peristaltic pumps where only a mechanical motion is controlled. The pump provides pulseless flow, with fast response times and high accuracy. The PeriWave pump may be operated in a positive or negative flow direction. Since the pump is peristaltic-based, fluid may be recycled back to the fluid source container. This feature is particularly useful and cost-effective when delivering expensive cell culture media such as with cell/body/organ-on-a-chip applications. Additionally, the waveform control allows for the unique capability of shear flow cell growth experiments. PC software and LabVIEW VI are included with the PeriWave. Three flow models are offered with the following aqueous flow rate calibration ranges: Micro from 1 to 80 microliters per minute, Milli from 30 to 1000 microliters per minute, and Milli+5 from 0.2 to 5.0 milliliters per minute.

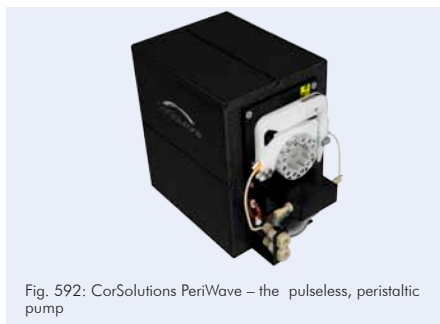

Fig. 592: CorSolutions PeriWave – the pulseless, peristaltic pump

### 12.7.2 PneuWave Fluid Delivery Pump by CorSolutions

The CorSolutions PneuWave pump is the only stand-alone, all-electric, pneumatic-based pump on the market, and can be operated with or without a computer. The PneuWave offers high performance with integrated flow and pressure sensors, allowing closed-loop feedback control. Additionally, the PneuWave has an integrated air compressor and a display screen for stand-alone operation. The user only needs to provide electricity and the fluid to be delivered! The pump records both flow and pressure information and allows users to input desired set-points or profiles as either flow rate or pressure parameters. The pump's high performance derives from the fact that fluid is measured, as compared to syringe and traditional pumps where only mechanical parameters are controlled, indirect of fluid performance. The pump provides pulseless flow with the fastest flow control performance available. The PneuWave comes in a 1 Bar or 4 Bar model. PC software and LabVIEW VI are included with the PneuWave. The PC software detects how many channels are connected and the flow regime for each, and automatically populates the user interface, allowing facile synchronization between multiple fluid channels. Three flow models are offered with the following aqueous flow rate calibration ranges: Micro from 1 to 80 microliters per minute, Milli from 30 to 1000 microliters per minute, and Milli+5 from 0.2 to 5.0 milliliters per minute.



Fig. 593: CorSolutions PneuWave pump with integrated flow and pressure sensors

### 12.7.3 PneuWave ECO Fluid Delivery Pump by CorSolutions

The CorSolutions PneuWave ECO pump is an economical alternative to the PneuWave. Although the performance remains the same, unlike the PneuWave, the ECO is PC control only and it requires an external compressed gas source. For constrained budgets, the ECO can also be purchased without flow control. In this case, the pump has only integrated pressure sensors (no flow sensors), and operates with only pressure closed-loop feedback. The PneuWave ECO comes in a 1 Bar or 4 Bar model, and includes both PC software and LabVIEW VI. Three flow models are offered with the following aqueous flow rate calibration ranges: Micro from 1 to 80 microliters per minute, Milli from 30 to 1000 microliters per minute, and Milli+5 from 0.2 to 5.0 milliliters per minute.

Product Code	PneuWave	PneuWave ECO With Flow Control	PneuWave ECO Without Flow Control
Stand-alone Operation	•		
PC Control	•	•	•
Does not Require External Compressor	•		
Flow Rate Mode	•	•	•
Pressure Mode	•	•	•
Fast Response	•	•	•
High Accuracy	•	•	•
High Precision	•	•	•



Fig. 594: PneuWave ECO Pump (left) and flow meter (right)



### 12.7.4 Flow Meters by CorSolutions

CorSolutions offers several styles of flow meters for measuring liquid flow rates. Three flow models are offered in each of these versions: Micro from 1 to 80 microliters per minute, Milli from 30 to 1000 microliters per minute, and Milli+5 from 0.2 to 5.0 milliliters per minute.

The **Standard Flow Meter** has a screen and interface buttons which displays the flow rate, and allows for stand-alone control. In addition, PC software and LabVIEW VI are included with the meter, allowing for computer control as well. The user is able to have the meter signal average for data smoothing if desired, and the user can select how frequently the flow rate value is recorded in the data file. The Standard Flow Meter comes with an aqueous calibration, and optional software for calibrating the meter for different liquid types is available.



Fig. 595: Flow Sensor Plus DSC

The **ECO Flow Meter** offers the same performance as the Standard model, but as it does not have a display screen and interface buttons, it can only be controlled through a computer. PC software and LabVIEW VI are included. The user is able to have the meter signal average for data smoothing if desired, and the user can select how frequently the flow rate value is recorded in the data file. The ECO Flow Meter comes with an aqueous calibration, and optional software for calibrating the meter for different liquid types is available.



Fig. 596: Flow meter



Fig. 597: 2-, 4-, 6-fold flow meter and sensor unit

The **Flow Meter Multi** offers a means of measuring flow rates of multiple fluid streams. The Multi consists of a single controller and a remote block containing two, three, four, five or six flow sensors. These sensors can be the same flow model, or alternatively, can be different flow models. Stand-alone or PC control is possible. PC software is included. When computer communication is established, the software detects the number of flow sensors present and the flow model of each, and automatically populates the display accordingly. The user is able to signal average for data smoothing if desired, and the user can select how frequently the flow rate values are recorded in the data file. Each flow sensor comes with an aqueous calibration, and optional software for calibrating the meter for different liquid types is available.

### 12.7.5 Microfluidic Connectors

The CorSolutions microfluidic connectors allow one to rapidly and easily establish a non-permanent, leak-tight connection to a microdevice. Connections are compatible with most substrate materials including plastics, glass, silicon and PDMS. This flexible, low dead volume approach can be used with a wide variety of tubing sizes and adapters.

### 12.7.6 Transparent Fittings by CorSolutions

Precision manufactured, transparent fittings allow for user observation of critical junctions. These fittings offer a window to notoriously problematic microfluidic connections, providing researchers a better understanding of their experiment. Fittings come in a variety of architectures, port styles, and inner diameters.

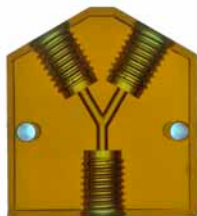

Fig. 598: CorSolutions microfluidic connectors – example of Y-1/4 28-1.0 design



Fig. 599: Magnetic fluid scope

Product Code	Description	Detail	Price [€/instrument]
10001030	Pump	CorSolutions PneuWave pump with integrated flow and pressure sensors	Please contact for pricing
10001249	Pump	CorSolutions PneuWave ECO Pump	Please contact for pricing
10001250	Pump	CorSolutions PeriWave Pump	Please contact for pricing
10001251	Flow meter	CorSolutions Flow meter – Standard	Please contact for pricing
10001252	Flow meter	CorSolutions Flow meter – ECO	Please contact for pricing
10001253	Flow meter	CorSolutions Flow meter – Multi with 2 channels	Please contact for pricing
10001254	Flow meter	CorSolutions Flow meter – Multi with 4 channels	Please contact for pricing
10001255	Flow meter	CorSolutions Flow meter – Multi with 6 channels	Please contact for pricing

Product Code	Part Number	Architectures	Port Styles	Inner diameter	Price [€/piece]
10001022	U-1/4-28-1.0	Union	1/4-28 Flat Bottom	1.0 mm	Please contact for pricing
10001023	U-1/4-28-1.6	Union	1/4-28 Flat Bottom	1.6 mm	Please contact for pricing
10001024	Y-1/4-28-1.0	“Y”	1/4-28 Flat Bottom	1.0 mm	Please contact for pricing
10001025	Y-1/4-28-1.6	“Y”	1/4-28 Flat Bottom	1.6 mm	Please contact for pricing
10001026	T-1/4-28-1.0	“Tee”	1/4-28 Flat Bottom	1.0 mm	Please contact for pricing
10001027	T-1/4-28-1.6	“Tee”	1/4-28 Flat Bottom	1.6 mm	Please contact for pricing
10001028	X-1/4-28-1.0	Cross	1/4-28 Flat Bottom	1.0 mm	Please contact for pricing
10001029	X-1/4-28-1.6	Cross	1/4-28 Flat Bottom	1.6 mm	Please contact for pricing





### 12.8 Valving – *memetis* shape memory miniature valves

*memetis* offers a new ultracompact SMA-miniature valve series. It has a very low power consumption and works at small voltages below 5 V. Together with the small size, the media separated valve is suited best for mobile applications in Life-Science applications. The wetted materials are fully biocompatible and its smooth, noiseless, yet fast switching performance is perfect for fluidic systems sensible to abrupt changes of fluid flow. Adding a flow-sensor the *memetis* miniature valve is capable of controlling the flow-rate.

*memetis* offers two versions of 2/2 way miniature valves for liquids and gases: a normally open (NO) and a normally closed (NC) version. A specifically designed control system ensures smooth and secure operation of the valves. Furthermore, *memetis* designs customer-specific valve-manifolds with an arbitrary number and combination of *memetis* NO/NC-valves with customer-specific interconnections and Luer interface.

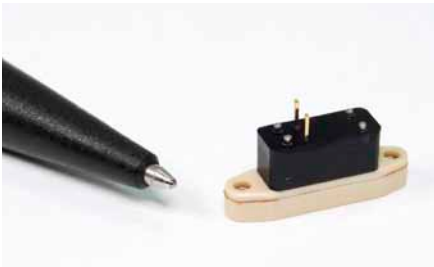

Fig. 600: *memetis* valve next to a pen for size comparison



Fig. 601: Ultracompact valve manifold (5mm pitch)



Fig. 602: *memetis* control system with valve manifold



Fig. 603: Control system and connected valve manifold



## 12 Pumps and pressure controllers

Product Code	Description	Detail	Price [€/instrument]
10001408	<i>memetis</i> SMA 2/2-way miniature seat valve (NC-normally closed) for liquids and gases	Functionality: Normally closed, media-separated, suitable for liquids and gases Dimensions: 20 x 5 x 9 mm <sup>3</sup> Nominal width: 0.75 mm (further variants upon request) Internal volume: < 4 µl Pressure range: 0-2 bar Housing material: PEEK (further materials upon request) Sealing material: PDMS (further materials upon request) Fluid temperature: 10 – 40 °C Ambient temperature: 0 – 40 °C Lifespan: > 10 <sup>6</sup> cycles Fluid connection: Flange Electrical connection: Pins (cable provided) Operating voltage: < 5 V, control Power consumption: ~ 0.25 W Switching Time: Opening < 100 ms; Closing < 200 ms Switching Frequency: Max. 2 Hz Kv value: > 0.004 m <sup>3</sup> /h Flow rates @ Δp 0,5 bar: ~ 2000 ml/min (air), ~30 ml/min (water)	150.00
10001409	<i>memetis</i> SMA 2/2-way miniature seat valve (NO-Normally open) for liquids and gases	Functionality: Normally open, media-separated, suitable for liquids and gases Dimensions: 20 x 5 x 9 mm <sup>3</sup> Nominal width: 0.75 mm Internal volume: < 4 µl Pressure range: 0-2 bar Housing material: PEEK (further materials upon request) Sealing material: PDMS (further materials upon request) Fluid temperature: 10 – 40 °C Ambient temperature: 0 – 40 °C Lifespan: > 10 <sup>6</sup> cycles Fluid connection: Flange Electrical connection: Pins (cable provided) Operating voltage: < 5 V, control Power consumption: ~ 0.25 W Switching Time: Closing < 100 ms; Opening < 200 ms Switching Frequency: Max. 2 Hz	135.00
10001410	<i>memetis</i> fluidic connector	Contains: 2 Luer connectors (male) PDMS Sealing Valve interface	40.00
10001411	<i>memetis</i> electrical control	Contains: Electrical control for manual operation of up to 4 valves Supply voltage = 5V USB-interface (on request) Push-/ Toggle-Buttons Display	120.00
10001412	<i>memetis</i> Test-Kit – Normally Closed (NC)	Contains: 2 <i>memetis</i> fluidic connectors 2 <i>memetis</i> SMA 2/2-way miniature seat valves (NC-normally closed) for liquids and gases 1 <i>memetis</i> electrical control	460.00
10001413	<i>memetis</i> Test-Kit – Normally Open (NO)	Contains: 2 <i>memetis</i> fluidic connectors 2 <i>memetis</i> SMA 2/2-way miniature seat valves (NO-normally closed) for liquids and gases 1 <i>memetis</i> electrical control	430.00
10001414	<i>memetis</i> Test-Kit – Normally Closed (NC)-Normally Open (NO)	Contains: 2 <i>memetis</i> fluidic connectors 1 <i>memetis</i> SMA 2/2-way miniature seat valve (NC-normally closed) for liquids and gases 1 <i>memetis</i> SMA 2/2-way miniature seat valve (NO-normally closed) for liquids and gases 1 <i>memetis</i> electrical control	445.00
10001415	<i>memetis</i> customer-specific valve manifolds	Combination of <i>memetis</i> NC/NO-valves with customer-specific interconnections and Luer interfaces. (valves included in offer)	Please inquire





## 13 Microfluidic kits



### Microfluidic kits

To run microfluidic experiments some basics like tubes, connectors, or reagents are necessary, or different options of tubes and fluidic interfaces might be of interest. In order to allow for a choice between the options, this chapter has several selections of kits comprising interfaces, chips with instrument, selection of chip types, handling frames or further accessories.



### 13.1 Microfluidic chip support kits – Microfluidic and chip-PCR support kits

The **microfluidic support kits** comprise different components necessary for running microfluidic systems. This includes tubes to bring the fluid into the chip, and silicone tubes to enable the interconnection between for example a *microfluidic ChipShop* fluidic platform chip and tubing, or between tubing and a syringe. Forceps can be used to stop a flow by clamping a silicone tube and syringes to fill chips manually.

These small kits allow you to directly start with your microfluidic experiments without losing time searching for suitable components.

Comparable to the **microfluidic support kits**, the **chip-PCR support kits** enable you to directly start with your continuous-flow PCR from the fluidic side. They include tubes and mineral oil to drive the PCR. Besides this and the PCR system consisting of chip and thermocycler, only your own biological reagents are needed to start the PCR.

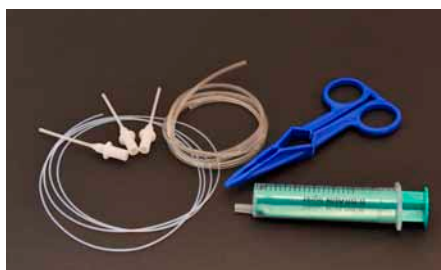

Fig. 604: Microfluidic support kit 1



Fig. 605: Microfluidic support kit 2

Product Code	Kit Type	Product Description	Price [€/kit]	
10000025	Microfluidic support kit 1	<ul style="list-style-type: none"> <li>- Silicone tube (ID: 0.5 mm, OD: 2.5 mm, 1m)</li> <li>- PTFE tube (ID: 0.5 mm, OD: 1 mm, 1m)</li> <li>- Forceps (1)</li> <li>- Single-use syringes (10 ml, 3)</li> <li>- Syringe adapter (3)</li> </ul>	<ul style="list-style-type: none"> <li>10000033</li> <li>10000032</li> <li>10000641</li> <li>10000312</li> <li>10000614</li> </ul>	27.80
10000045	Microfluidic support kit 2	<ul style="list-style-type: none"> <li>- Silicone tube (ID: 0.5 mm, OD: 2.5 mm, 1m)</li> <li>- Silicone tube (ID: 0.76 mm, OD: 1.65 mm, 1m)</li> <li>- PTFE tube (ID: 0.5 mm, OD: 1 mm, 1m)</li> <li>- Forceps (1)</li> <li>- Single-use syringes (10 ml, 3)</li> <li>- Syringe adapter (3)</li> <li>- Male Mini Luer fluid connectors, red, material: PP (10)</li> <li>- Male Mini Luer fluid connectors, blue, material: PP (10)</li> <li>- Male Mini Luer fluid connectors, opaque, material: TPE (10)</li> <li>- Male Mini Luer plugs, green, material: PP (10)</li> <li>- Male Mini Luer plugs, opaque, material: TPE (10)</li> </ul>	<ul style="list-style-type: none"> <li>10000033</li> <li>10000031</li> <li>10000032</li> <li>10000641</li> <li>10000312</li> <li>10000614</li> <li>10000064</li> <li>10000096</li> <li>10000116</li> <li>10000052</li> <li>10000054</li> </ul>	96.50
10000085	Microfluidic support kit 3	<ul style="list-style-type: none"> <li>- Microfluidic support kit 2 plus:</li> <li>- Female Luer Lock compatible connectors with wide base, material: PMMA (10)</li> <li>- Male Luer plugs, opaque, material: PP (10)</li> </ul>	<ul style="list-style-type: none"> <li>10000045</li> <li>10000013</li> <li>10000230</li> </ul>	146.20
10000238	PCR support kit 1	<ul style="list-style-type: none"> <li>- Silicone tube (ID: 0.5 mm, OD: 2.5 mm, 1m)</li> <li>- PTFE tube (ID: 0.5 mm, OD: 1 mm, 1m)</li> <li>- Forceps (1)</li> <li>- mcs-oil-04</li> <li>- mcs-foil 007 (3 sheets, 8 x 13,5 cm)</li> </ul>	<ul style="list-style-type: none"> <li>10000033</li> <li>10000032</li> <li>10000641</li> <li>10001079</li> <li>10000702</li> </ul>	32.90



### 13.2 Microfluidic starter kits

The microfluidic starter kits comprise several standard chips as well as necessary accessories for a quick start with microfluidics. With these kits, a first series of experiments allows to get familiar with the use of microfluidic devices.



Fig. 606: Microfluidic starter kit 1



Fig. 607: Microfluidic starter kit 2



Fig. 608: Microfluidic starter kit 3



Fig. 609: Microfluidic starter kit 4

Product Code	Kit Type	Product Description	Price [€/kit]
10000012	Microfluidic starter kit 1	- Microfluidic support kit 1	10000025
		- Handling frame with high skirt, yellow (1)	10000042
		- Male Mini Luer fluid connectors, red, material: PP (10)	10000064
		- Straight channel chip, 4 channels (200 $\mu\text{m}$ width/ 200 $\mu\text{m}$ depth), material: Topas (2)	10000091
		- Straight channel chip, 4 channels (100 $\mu\text{m}$ width/ 100 $\mu\text{m}$ depth), material: PMMA (2)	10000088
		- Straight channel chip, 16 channels (1000 $\mu\text{m}$ width/200 $\mu\text{m}$ depth), material: Topas (1)	10000068
		- H-shaped channel chip, material: Topas (2)	10000266
		- Droplet generator chip, material: PC (1)	10000004
		- Meander PCR-chip, 36 cycles, material: PC (1)	10000007
		- Meander PCR-Chip, 15 cycles, material: PC (1)	10000008
		- Rhombic chamber chip, 120 $\mu\text{l}$ chamber volume, material: Zeonor (1)	10000113
		10000098	Microfluidic starter kit 2
- Straight channel chip, 4 channels (200 $\mu\text{m}$ width/ 200 $\mu\text{m}$ depth), material: PMMA (2)	10000090		
- Straight channel chip, 4 channels (200 $\mu\text{m}$ width/ 200 $\mu\text{m}$ depth), material: Topas (2)	10000091		
- Straight channel chip, 16 channels (200 $\mu\text{m}$ width/ 100 $\mu\text{m}$ depth), material: PMMA (2)	10000065		
- Straight channel chip, 16 channels (200 $\mu\text{m}$ width/ 100 $\mu\text{m}$ depth), material: Topas (2)	10000066		
- Rhombic chamber chip, 120 $\mu\text{l}$ chamber volume, material: Zeonor (2)	10000113		



## 13 Microfluidic kits

Product Code	Kit Type	Product Description	Price [€/kit]
10000285	Microfluidic starter kit 3	- Microfluidic starter kit 1 - Bartels Micropump mp6-go! set	10000012 10000841 818.40
10000344	Microfluidic starter kit 4	- Microfluidic starter kit 2 - Bartels Micropump mp6-go! set	10000098 10000841 881.45

### 13.3 Microfluidic interface kits

Various microfluidic interfaces to be used with *microfluidic ChipShop's* microfluidic platforms are arranged as special kits, e.g. to be used with the female Mini Luer microfluidic platforms, or the female Luer microfluidic platforms.



Fig. 610: Microfluidic interface kit 1 – Mini Luer plugs and connectors



Fig. 611: Microfluidic interface kit 2 – Luer plugs and connectors

Product Code	Kit Type	Product Description	Price [€/kit]
10000023	Microfluidic interface kit 1	- Male Mini Luer fluid connectors, green, material: PP (20) - Male Mini Luer fluid connectors, blue, material: PP (20) - Male Mini Luer fluid connectors, opaque, material: TPE (20) - Male Mini Luer plugs, red, material: PP (20) - Male Mini Luer plugs, opaque, material: TPE (20)	10000029 10000096 10000116 10000053 10000054 110.50
10000024	Microfluidic interface kit 2	Microfluidic interface kit 2: - Male Luer fluid connectors, opaque, material: PP (20) - Male Luer fluid connectors, green, material: PP (20) - Male Luer plugs, opaque, material: PP (20) - Male Luer plugs, black, material: PP (20)	10000080 10000081 10000230 10000231 82.60





### 13.4 Integrated chip support kits

In order to operate the different integrated chips various fluidic interfaces are necessary or make the handling of the chip more convenient, e.g. Mini Luer or Luer fluid connectors or plugs. Further handling aids like manipulators for turning valves or handling frames are the respective accessories being of use for these devices.



Fig. 612: Integrated chip support kit 1



Fig. 613: Integrated chip support kit 2

Product Code	Kit Type	Product Description	Price [€/kit]
10000301	Integrated chip support 1	- Male Mini Luer fluid connectors, green, material: PP (10)	10000029
		- Male Mini Luer fluid connectors, opaque, material: TPE (10)	10000116
		- Male Mini Luer plugs, red, material: PP (10)	10000053
		- Male Mini Luer plugs, opaque, material: TPE (10)	10000054
		- Male Luer fluid connectors, green, material: PP (10)	10000081
		- Male Luer plugs, opaque, material: PP (10)	10000231
		- Mini Luer to pipette adapter, material: PP (10)	10000057
		- Silicone tube (ID: 0.5 mm, OD: 2.5 mm, 1 m) (2)	10000033
		- PTFE tube (ID: 0.5 mm, OD: 1 mm, 1 m) (5)	10000032
		- Manual turning valve actuator (1)	10000742
- Handling frame with high skirt, yellow (1)	10000042		
10000304	Integrated chip support 2	- Male Mini Luer fluid connectors, green, material: PP (10)	10000029
		- Male Mini Luer fluid connectors, opaque, material: TPE (10)	10000116
		- Male Mini Luer plugs, red, material: PP (10)	10000053
		- Male Mini Luer plugs, opaque, material: TPE (10)	10000054
		- Male Luer fluid connectors, green, material: PP (10)	10000081
		- Male Luer plugs, opaque, material: PP (10)	10000231
		- Mini Luer to pipette adapter, material: PP (10)	10000057
		- Silicone tube (ID: 0.5 mm, OD: 2.5 mm, 1 m) (2)	10000033
		- PTFE tube (ID: 0.5 mm, OD: 1 mm, 1 m) (5)	10000032
		- Handling frame with high skirt, yellow (1)	10000042
10000372	Integrated chip support 3	- Male Mini Luer fluid connectors, green, material: PP (10)	10000029
		- Male Mini Luer fluid connectors, opaque, material: TPE (10)	10000116
		- Male Mini Luer plugs, red, material: PP (10)	10000053
		- Male Mini Luer plugs, opaque, material: TPE (10)	10000054
		- Mini Luer to pipette adapter, material: PP (10)	10000057
		- Silicone tube (ID: 0.5 mm, OD: 2.5 mm, 1 m) (2)	10000033
		- PTFE tube (ID: 0.5 mm, OD: 1 mm, 1 m) (5)	10000032
		- Manual turning valve actuator (1)	10000742
		- Handling frame with high skirt, yellow (1)	10000042



Product Code	Kit Type	Product Description	Price [€/kit]
10000371	Integrated chip support 4	<ul style="list-style-type: none"> <li>- Male Mini Luer fluid connectors, green, material: PP (10) 10000029</li> <li>- Male Mini Luer fluid connectors, opaque, material: TPE (10) 10000116</li> <li>- Male Mini Luer plugs, red, material: PP (10) 10000053</li> <li>- Male Mini Luer plugs, opaque, material: TPE (10) 10000054</li> <li>- Mini Luer to pipette adapter, material: PP (10) 10000057</li> <li>- Silicone tube (ID: 0.5 mm, OD: 2.5 mm, 1 m) (2) 10000033</li> <li>- PTFE tube (ID: 0.5 mm, OD: 1 mm, 1 m) (5) 10000032</li> <li>- Manual turning valve actuator (1) 10000742</li> </ul>	144.64

### 13.5 Sample preparation starter kits

Sample preparation starter kit 1 – plasma generation comprise plasma generation chips with either 2 or 4 membranes, accessories and a user guide for a quick start in on-chip plasma generation out of whole blood. Depending on the blood sample, the included chips allow generation of plasma/serum in the range of 12 – 15  $\mu\text{l}$  (Chip with 4 membranes) and 20 – 35  $\mu\text{l}$  (Chip with 2 membranes).

Sample preparation starter kit 2 – enrichment comprise a cross-flow membrane chip with 4 membranes, accessories and a user guide for a quick start in on-chip enrichment of bacterial suspensions. Cell suspensions can be filled in tanks. For bigger volumes, accessories for the connection to pumps are included. Cells are filtered by a membrane with determined pore size. The membrane divides the chip in one upper and one lower compartment, which can be opened and closed separately. Once cells are enriched in the upper compartment, they can be exhausted by closing the outlet of the lower compartment and opening the outlet of the upper compartment.



Fig. 614: Sample preparation starter kit 1 – plasma generation



Fig. 615: Sample preparation starter kit 2 – enrichment

Product Code	Kit Type	Product Description	Price [€/kit]
10000507	Sample preparation starter kit 1 - Plasma generation	<ul style="list-style-type: none"> <li>- Male Mini Luer plugs - Low volume displacement, red, material: PP (40) 10000280</li> <li>- Mini Luer to pipette adapter, material: PP (40) 10000057</li> <li>- Handling frame with high skirt, yellow (1) 10000042</li> <li>- Plasma generation chips with 4 membranes, material: Topas (5) 10000021</li> <li>- Plasma generation chips with 2 membranes, material: Topas (5) 10000439</li> </ul>	678.30



Product Code	Kit Type	Product Description	Price [€/kit]	
10000508	Sample preparation starter kit 2 - Enrichment	- Row of 4 tanks with cap, material: PP (10)	10000079	631.70
		- Male Mini Luer plugs, green, material: PP (40)	10000052	
		- Mini Luer to pipette adapter, material PP (40)	10000057	
		- Handling frame with high skirt, yellow (1)	10000042	
		- Cross-flow membrane chip with 4 membranes, material: Topas (10)	10000022	
		- Silicone tube (ID: 0.5 mm, OD: 2.5 mm, 1 m) (1)	10000033	
		- Male Mini Luer fluid connector, green, material: PP (20)	10000029	
		- Male Luer fluid connector, green, material: PP (10)	10000081	

### 13.6 ChipGenie® edition P starter kits

The ChipGenie® edition P starter kits comprise several standard chips that can be used with the ChipGenie® edition P instrument as well as accessories that can be combined with the system.

Depending on users' preferences, the chips can be either operated manually with a pipette or with a pump that can be connected to the chip with the male Mini Luer fluid connectors.



Fig. 616: ChipGenie® edition P starter kit 1



Fig. 617: ChipGenie® edition P starter kit 2



Fig. 618: ChipGenie® edition P starter kit 3 – DNA extraction from whole blood



Fig. 619: ChipGenie® edition P starter kit 5 – DNA extraction from bacterial suspension



## 13 Microfluidic kits

Product Code	Kit Type	Product Description	Price [€/kit]
10001138	ChipGenie edition® P starter kit 1	<ul style="list-style-type: none"> <li>- ChipGenie edition® edition P instrument 10000166</li> <li>- Microfluidic support kit 1 10000025</li> <li>- Male Mini Luer fluid connectors, red, material: PP (10) 10000064</li> <li>- Male Mini Luer plugs, green, material: PP (10) 10000052</li> <li>- Rhombic chamber chip, 120 µl chamber volume, material: Zeonor (3) 10000113</li> <li>- Straight channel chip, 4 channels (1000 µm width/ 200 µm depth), material: Topas (3) 10000107</li> </ul>	759.00
10000274	ChipGenie edition® P starter kit 2	<ul style="list-style-type: none"> <li>- Microfluidic support kit 1 10000025</li> <li>- Male Mini Luer fluid connectors, red, material: PP (10) 10000064</li> <li>- Male Mini Luer plugs, green, material: PP (10) 10000052</li> <li>- Rhombic chamber chip, 120 µl chamber volume, material: Zeonor (3) 10000113</li> <li>- Rhombic chamber chip, 100 µl chamber volume, material: Zeonor (3) 10000047</li> <li>- Rhombic chamber chip, 250 µl chamber volume, material: Zeonor (3) 10000049</li> <li>- Straight channel chip, 4 channels (1000 µm width/ 200 µm depth), material: Topas (3) 10000107</li> </ul>	384.00
10000239	ChipGenie edition® P starter kit 3 – DNA extraction from whole blood	<ul style="list-style-type: none"> <li>- Male Mini Luer fluid connectors, green, material: PP (20) 10000029</li> <li>- Male Mini Luer plugs, green, material: PP (40) 10000052</li> <li>- Mini Luer to pipette adapter, material: PP (20) 10000057</li> <li>- Silicone tube (ID: 0.5 mm, OD: 2.5 mm, 1 m) (1) 10000033</li> <li>- Rhombic chamber chip, 120 µl chamber volume, material: Zeonor (10) 10000113</li> <li>- ChipGenie® edition P starter kit 6 - buffer set for whole blood 10001256</li> </ul>	561.43
10000512	ChipGenie edition® P starter kit 5 - DNA extraction from bacterial suspension	<ul style="list-style-type: none"> <li>- Male Mini Luer fluid connectors, green, material: PP (20) 10000029</li> <li>- Male Mini Luer plugs, green, material: PP (40) 10000052</li> <li>- Mini Luer to pipette adapter, material: PP (20) 10000057</li> <li>- Rhombic chamber chip, 120 µl chamber volume, material: Zeonor (10) 10000113</li> <li>- Silicone tube (ID: 0.5 mm, OD: 2.5 mm, 1 m) (1) 10000033</li> <li>- ChipGenie® edition P starter kit 7 - buffer set for bacterial suspension 10000420</li> </ul>	561.43

### 13.7 Molecular biological starter kits

*microfluidic ChipShop*'s microfluidic toolbox offers the complete set of chip modules and accessories to start directly with molecular biological experiments. Tubes, accessories for the interconnection and liquid handling are included. The molecular biological starter kits and the microfluidic accessories are designed for the combination with handling frames and chips of the molecular biological product families.

**PCR starter kit – continuous flow PCR** comprise chips with different number of PCR cycles and materials including accessories and application notes for a quick start in continuous flow PCR.

**PCR starter kit – oscillating PCR** comprise Boyle-Mariotte PCR chips and materials including accessories and application notes for a quick start in oscillation PCR.

**PCR starter kit – stationary PCR** comprise PCR reaction chamber chips of 10, 20 and 24 µl volume including PCR master mix and accessories for a quick start in on-chip stationary PCR.

**PCR starter kit – stationary qPCR** comprise qPCR reaction chamber chips of 10 and 20 µl volume including qPCR master mix and accessories for a quick start on stationary qPCR. Air bubble traps inside the chips enabling a clear imaging area for optical readout.



**DNA hybridization / microarray starter kit – custom specific spotting** comprise 10 chips of two catalogue designs, which can be spotted with up to 10 custom specific molecules, including washing- and blocking solutions and accessories for a quick start on DNA hybridization or microarray analysis. Customer can chose between biotin labeled substrates for colorimetric or fluorescence readout.

**DNA hybridization / microarray starter kit – spotting by customer** comprise 10 chips of different unsealed chip designs, already glued with structured adhesive tape, which leaves the structures open, in order to enable spotting by customer. The kit includes accessories for the interconnection and optical clear sealing foils for the chip devices.



Fig. 620: PCR starter kit 1 - continuous flow PCR



Fig. 621: PCR starter kit 2 - oscillation PCR

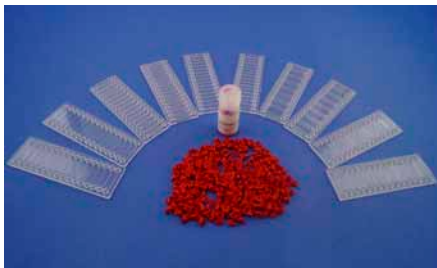

Fig. 622: PCR starter kit 3 - stationary PCR



Fig. 623: PCR starter kit 4 - stationary qPCR



Fig. 624: DNA hybridization / microarray starter kit - custom specific spotting



Fig. 625: DNA hybridization / microarray starter kit - spotting by customer



## 13 Microfluidic kits

Product Code	Kit Type	Product Description	Price [€/kit]
10000517	PCR starter kit - continuous flow PCR	<ul style="list-style-type: none"> <li>- Silicone tube (ID: 0.5 mm, OD: 2.5 mm, 1 m) 10000033</li> <li>- PTFE tube (ID: 0.5 mm, OD: 1 mm, 1 m) 10000032</li> <li>- Forceps (1) 10000641</li> <li>- mcs-oil 04 10001079</li> <li>- mcs-foil 007 10000702</li> <li>- mcs-on-chip PCR Master Mix 01, 10 reactions (0.25 ml) 10000938</li> <li>- continuous-flow PCR-chip, 15 cycles, material: PC (2) 10000008</li> <li>- continuous-flow PCR-chip, 36 cycles, material: PC (2) 10000007</li> <li>- continuous-flow PCR-chip, 41 cycles, material: PC (2) 10000745</li> <li>- continuous-flow PCR-chip, 40 cycles, material: PC (2) 10000010</li> <li>- continuous-flow PCR-chip, 40 cycles, material: Zeonor (2) 10000011</li> <li>- Manual</li> </ul>	343.28
10000518	PCR starter kit - oscillation PCR	<ul style="list-style-type: none"> <li>- Silicone tube (ID: 0.5 mm, OD: 2.5 mm, 1 m) 10000033</li> <li>- PTFE tube (ID: 0.5 mm, OD: 1 mm, 1 m) 10000032</li> <li>- Forceps (1) 10000641</li> <li>- mcs-on-chip PCR Master Mix 01, 10 reactions (0.25 ml) 10000938</li> <li>- Boyle-Mariotte PCR chip, material: PC (10) 10000639</li> <li>- Male Luer fluid connector, green, material: PP (10) 10000081</li> <li>- Manual</li> </ul>	345.40
10000519	PCR starter kit - stationary PCR	<ul style="list-style-type: none"> <li>- Male Mini Luer plugs - Low volume displacement, red, material: PP (20) 10000280</li> <li>- Rhombic chamber chip, 10 <math>\mu</math>l chamber volume, material: Zeonor (2) 10000537</li> <li>- Rhombic chamber chip, 10 <math>\mu</math>l chamber volume, material: Zeonor (2) 10000543</li> <li>- Rhombic chamber chip, 24 <math>\mu</math>l chamber volume, material: Zeonor (2) 10000354</li> <li>- Rhombic chamber chip, 20 <math>\mu</math>l chamber volume, material: Zeonor (2) 10000561</li> <li>- Rhombic chamber chip, 20 <math>\mu</math>l chamber volume, material: Zeonor (2) 10000567</li> <li>- mcs-on-chip PCR Master Mix 01, 120 reactions (2 ml) 10001257</li> <li>- Manual</li> </ul>	299.18
10000520	PCR starter kit - stationary qPCR	<ul style="list-style-type: none"> <li>- Male Mini Luer plugs - Low volume displacement, material: PP (20) 10000280</li> <li>- Rhombic chamber chip with bubble traps, 10 <math>\mu</math>l chamber volume, material: Zeonor (5) 10000447</li> <li>- Rhombic chamber chip with bubble traps, chamber volume: 20 <math>\mu</math>l, material: Zeonor (5) 10000556</li> <li>- mcs-on-chip qPCR Master Mix 02, 120 reactions (1.6 ml) 10001258</li> <li>- Manual</li> </ul>	427.84
10000521	DNA hybridization / microarray starter kit - customized spotting	<ul style="list-style-type: none"> <li>- Mini Luer to pipette adapter, material: PP (20) 10000057</li> <li>- Male Luer plugs, opaque, material: PP (20) 10000230</li> <li>- Male Mini Luer plugs - Low volume displacement, red, material: PP (40) 10000280</li> <li>- Handling frame with high skirt, yellow (1) 10000042</li> <li>- Up to 10 molecules customized spotting on 10 catalogue chips</li> <li>- Straight channel chip, 1 channel, material: Zeonor (5) 10000247</li> <li>- Straight channel chip with waste chamber, 2 channels, material: Topas (5) 10000297</li> <li>- Buffer set with washing and blocking solutions for 15 reactions of: <ul style="list-style-type: none"> <li>a. Biotin-labeled colorimetric readout, TMB 20-5102-0000-00</li> <li>b. biotin labeled fluorescence readout, Cy5/Fam 10001259</li> </ul> </li> <li>- Manual</li> </ul>	starting from 502.95



Product Code	Kit Type	Product Description	Price [€/kit]
10000522	DNA hybridization / microarray starter kit - spotting by customer	<ul style="list-style-type: none"> <li>- Mini Luer to pipette adapter, material: PP (20) 10000057</li> <li>- Handling frame with high skirt, yellow (1) 10000042</li> <li>- Optical foil, microscopy slide format, 10 pieces 10000307</li> <li>- 4 channel chip with double-sided adhesive tape, material: Topas (4) 10000306</li> <li>- 1 channel chip with double-sided adhesive tape, material: Topas (3) 10000347</li> <li>- 2 channel chip with waste reservoir and double-sided adhesive tape, material: Topas (3) 10000280</li> <li>- Male Mini Luer plugs - Low volume displacement, red, material: PP (50) 10000230</li> <li>- Male Luer plugs, opaque, material: PP, opaque (20) 10000230</li> <li>- Manual</li> </ul>	451,50

### 13.8 ChipGenie® edition E2 kits

The ChipGenie® edition E starter kits comprise instrument and standard chips as well as standards to carry out capillary electrophoresis with contactless conductivity detection on chip.



Fig. 626: ChipGenie® edition E2 – starter kit 1



Fig. 627: ChipGenie® edition E2 – starter kit 2

Product Code	Description	Detail	Product Code	Price [€]
10001317	ChipGenie® edition E2 starter kit 1	<ul style="list-style-type: none"> <li>- ChipGenie® edition E2 instrument 10001316</li> <li>- Cross-shaped channel chips (50 μm width/50 μm depth), T-junction, material: PMMA (2) 10000028</li> <li>- Cross-shaped channel chips (50 μm width/50 μm depth), double T-junction, material: PMMA (2) 10000027</li> <li>- Cross-shaped channel chips (100 μm width/100 μm depth), T-junction, material: PMMA (2) 10000337</li> <li>- Cross-shaped channel chips (100 μm width/100 μm depth), T-junction, material: Zeonor (2) 10000338</li> <li>- Single-use syringes, 1 ml (10) 10000719</li> <li>- 10 ml mcs buffer O3 (separation buffer) 10000987</li> <li>- ChipGenie® edition E starter kit 3 – standards: 10000516               <ul style="list-style-type: none"> <li>Cation standard solution, Li<sup>+</sup>, Na<sup>+</sup>, K<sup>+</sup> (1 ml)</li> <li>Anion standard solution, Cl<sup>-</sup>, NO<sub>3</sub><sup>-</sup>, SO<sub>4</sub><sup>2-</sup> (1 ml)</li> <li>Organic acid standard solution, tartaric acid, succinic acid, citric acid (1 ml)</li> </ul> </li> </ul>		4,392.00



Product Code	Description	Detail	Product Code	Price [€]
110000515	ChipGenie® edition E2 starter kit 2	<ul style="list-style-type: none"> <li>- Cross-shaped channel chips (50 μm width/50 μm depth), T-junction, material: PMMA (2)</li> <li>- Cross-shaped channel chips (50 μm width/50 μm depth), double T-junction, material: PMMA (2)</li> <li>- Cross-shaped channel chips (100 μm width/100 μm depth), T-junction, material: PMMA (2)</li> <li>- Cross-shaped channel chips (100 μm width/100 μm depth), T-junction, material: Zeonor (2)</li> <li>- Single-use syringes, 1 ml (10)</li> <li>- 10 ml mcs buffer O3 (separation buffer)</li> <li>- ChipGenie® edition E2 starter kit 3 – standards:               <ul style="list-style-type: none"> <li>Cation standard solution, Li<sup>+</sup>, Na<sup>+</sup>, K<sup>+</sup> (1 ml)</li> <li>Anion standard solution, Cl<sup>-</sup>, NO<sub>3</sub><sup>-</sup>, SO<sub>4</sub><sup>2-</sup> (1 ml)</li> <li>Organic acid standard solution, tartaric acid, succinic acid, citric acid (1 ml)</li> </ul> </li> </ul>	10000028 10000027 10000337 10000338 10000719 10000987 10000516	790.00
10000516	ChipGenie® edition E2 kit 3 – standards	<ul style="list-style-type: none"> <li>- Cation standard solution, Li<sup>+</sup>, Na<sup>+</sup>, K<sup>+</sup> (1 ml)</li> <li>- Anion standard solution, Cl<sup>-</sup>, NO<sub>3</sub><sup>-</sup>, SO<sub>4</sub><sup>2-</sup> (1 ml)</li> <li>- Organic acid standard solution, tartaric acid, succinic acid, citric acid (1 ml)</li> </ul>		78.20

### 13.9 Cell culture basic kits

*microfluidic ChipShop*'s microfluidic toolbox offers the complete set of chip modules and accessories to start directly with cell-based microfluidic experiments. Tubes, accessories for the interconnection and liquid handling are all included. The kits are laid out to gain first experience in simple (beginners kit) or complex (advanced kit) adherent cell culture.

**Cell culture kit - Beginners:** Chips with hydrophilized surfaces and accessories for an immediate start of simple adherent cell culture. The chips are suitable for applications like immunofluorescence microscopy, screening, apoptosis- and proliferation assays.

**Cell culture kit - Advanced:** Chips with hydrophilized surfaces and accessories for an immediate start of complex adherent cell cultures. Like for the beginners kit the application include immunofluorescence microscopy and screening. However, the more complex chip designs enable more sophisticated culture setups, including co-culture of various cell types.



Fig. 628: Cell culture kit - Beginners

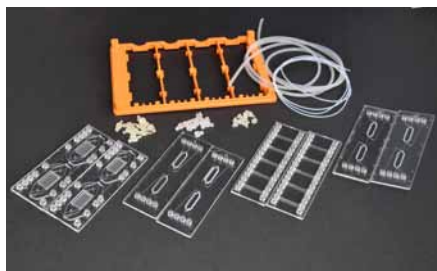

Fig. 629: Cell culture kit - Advanced





Product Code	Kit Type	Product Description	Product Code	Price [€/kit]			
10001418	Cell culture kit - Beginners	- Male Mini Luer plugs - Low volume displacement (2x)	10000205	438.84			
		- Male Mini Luer fluid connectors, single, opaque (2x)	10000116				
		- Mini Luer to pipette adapter, opaque, PP (2x)	10000063				
		- Silicone tube (ID.: 0.76 mm, OD: 1.65 mm), 1 m	10000031				
		- PTFE tube, 1 m (3x)	10000032				
		- Handling frame with reduced skirt height (1x)	10000041				
		- Reaction chamber chip Fluidic 842, Zeonor, hydroph. (2x)	10001036				
		- Reaction chamber chip Fluidic 584, Zeonor, hydroph. (2x)	10000559				
		- Cell culture chip w/ pre-heating channel Fluidic 992, Zeonor, hydrophilized (2x)	10001344				
		- Chamber interaction chip Fluidic 737, PS, hydrophilized (1x)	10001060				
		- Chamber interaction chip Fluidic 688, PS, hydrophilized (1x)	10001055				
		10001419	Cell culture kit - Advanced		- Male Mini Luer plugs - Low volume displacement (2x)	10000205	529.38
					- Male Mini Luer fluid connectors, single, opaque (2x)	10000116	
- Mini Luer to pipette adapter, opaque, PP (2x)	10000063						
- Silicone tube (ID.: 0.76 mm, OD: 1.65 mm), 1 m	10000031						
- PTFE tube, 1 m (3x)	10000032						
- Handling frame with reduced skirt height (1x)	10000041						
- Chamber interaction chip Fluidic 737, PS, hydrophilized (2x)	10001060						
- Chamber interaction chip Fluidic 688, PS, hydrophilized (2x)	10001055						
- Cross-flow membrane chip Fluidic 653, PS, hydrophilized (2x)	10000918						
- Channel interaction chip Fluidic 983, PS, hydrophilized (2x)	10001348						

### 13.10 Droplet generation kits

One of the fields in which microfluidics has generated innovative solutions is droplet-based microfluidics. Having the ability to generate a large number of droplets of very uniform size has led researchers to many new applications. By compartmentalizing a biological sample, e.g. droplet-based or so-called digital PCR became possible. Other applications comprise the generation of extremely well-defined emulsions, the synthesis of nanoparticles or the encapsulation of single cells. As the droplet volume can be very small, concentrations e.g. of cell metabolites quickly become very high and can be easily analyzed. Droplet motion in the microchannel induces streaming which allows for a rapid mixing of reagents contained in the droplets. As the droplet content is never in contact with the microchannel walls, no contamination or carryover from one droplet to another occurs.

A family of droplet generator chips in various designs allows for the generation of droplets in different sizes and frequencies. Integrated chips going beyond the droplet generation function, e.g. with combining droplet generation with droplet storage for an afterwards separate optical analysis, over a wide variety of experiments.

The chips can be operated in both pumping and suction modes. As fluidic interfaces female Mini Luer and female Luer adapters are integrated. The female Luer adapter, due to their large volume, not only allows to serve as fluidic interface, but also as liquid reservoir. Standard oils that neither harm standard biological reactions nor the microfluidic chip materials are available at *microfluidic ChipShop*.

*microfluidic ChipShop* offers different droplet generation kits for conducting the first step in this field.

**Material compatibility:** Please be aware of material compatibility when setting up your droplet generation experiment. When utilizing silicone-based oils we recommend the use of Topas chips, while mineral oils require chips made from PC.



## 13 Microfluidic kits



Fig. 630: Droplet generation kit - Mini Luer kit



Fig. 631: Droplet generation kit - Luer kit

Product Code	Kit Type	Product Description	Price [€/kit]
10001109	Droplet generation kit - Mini Luer kit Topas	- Fluidic 162 (2)	10000005
		- Fluidic 163 (2)	10000006
		- Fluidic 285 (1)	10000175
		- Transport & Storage Box Fluidic 832 (1)	10001188
		- Low Skirt Handling Frame (1)	10000041
		- Mini Luer Fluid Connectors Fluidic 331 (10)	10000096
		- Mini Luer Plugs Fluidic 334 (10)	10000052
		- Silicone Tubing	10000031
		- PTFE Tubing	10000032
		277.50	
10001416	Droplet generation kit - Mini Luer kit PC	- Fluidic 162 (2)	10000003
		- Fluidic 163 (2)	10000004
		- Fluidic 285 (1)	10000176
		- Transport & Storage Box Fluidic 832 (1)	10001188
		- Low Skirt Handling Frame (1)	10000041
		- Mini Luer Fluid Connectors Fluidic 331 (10)	10000096
		- Mini Luer Plugs Fluidic 334 (10)	10000052
		- Silicone Tubing	10000031
		- PTFE Tubing	10000032
		277.50	
10001110	Droplet generation kit - Luer kit Topas	- Fluidic 536 – Four Elements on one chip (2)	10000433
		- Fluidic 537 – Double emulsion (droplet in droplet) (2)	10000466
		- Transport & Storage Box Fluidic 832 (1)	10001188
		- Low Skirt Handling Frame (1)	10000041
		- Luer Fluid Connectors Fluidic 263 (10)	10000081
		- Luer Plugs Fluidic 270 (10)	10000230
		- Silicone Tubing	10000031
		- PTFE Tubing	10000032
248.50			
10001417	Droplet generation kit - Luer kit PC	- Fluidic 536 – Four Elements on one chip (2)	10000509
		- Fluidic 537 – Double emulsion (droplet in droplet) (2)	10000467
		- Transport & Storage Box Fluidic 832 (1)	10001188
		- Low Skirt Handling Frame (1)	10000041
		- Luer Fluid Connectors Fluidic 263 (10)	10000081
		- Luer Plugs Fluidic 270 (10)	10000230
		- Silicone Tubing	10000031
		- PTFE Tubing	10000032
248.50			



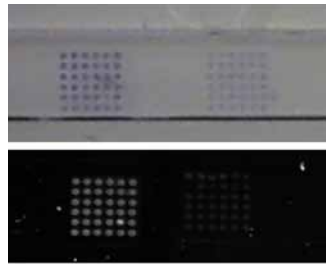
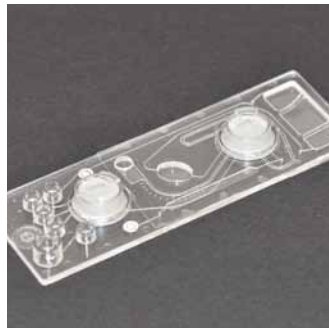

F.  
tularensis

Y.  
pestis

# 14 Application development: Assay & reagent implementation



## Application development: Assay & reagent implementation

The transfer of biological and chemical assays on chip as well as reagent implementation and surface modification are central elements for the development of lab-on-a-chip systems. We offer our customers these application related services in order to facilitate the overall product development. Our equipped laboratories can be commonly used for development and quality control purposes.



### 14 Application development: Assay & reagent implementation

Lab-on-a-chip systems target to make biological and diagnostic assays simpler, more sensitive, less error prone and to combine several assay steps conventionally done in different systems in one device.

To cope with the complex task to develop such systems, standard assay steps need to be adapted to the special requirements of the microfluidic surrounding as well as topics like surface functionalization or dry and liquid reagent storage have to be addressed.

Independent how different the custom specific assays themselves are, the underlying principle and general steps to transfer the assay on chip have similar requirements and are part of microfluidic ChipShop's daily business.

Facilitating assay and product development for our customers, microfluidic ChipShop offers the following special services including the validation of the respective processes together with the customer:

- Reagent implementation
  - Dry reagent storage
    - o Examples
      - PCR master mixes
      - PCR primers and probes
      - Cell lysis reagents
      - Beads for DNA extraction
      - Buffer
  - Liquid reagent storage
    - o Storage in blister packs
    - o Storage in tanks or syringes
- Spotting
  - DNA arrays
  - RNA arrays
  - Protein arrays
- Assay transfer on chip
- Transfer of instrument platforms to custom products together with the microfluidic device and the respective application.

To cope with these tasks, equipped biological and chemical laboratories and experienced application teams are at hand.



Fig. 632: Implementation of low-volume real-time PCR on chip – Chip on breadboard instrument

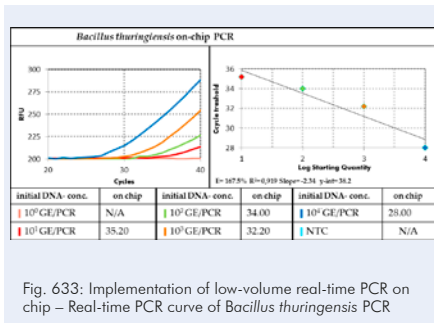

Fig. 633: Implementation of low-volume real-time PCR on chip – Real-time PCR curve of *Bacillus thuringiensis* PCR

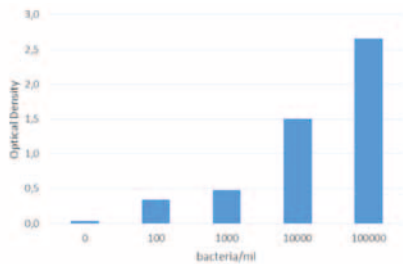

Fig. 634: Immunoassay on chip: results from colorimetric detection of *Francisella tularensis*

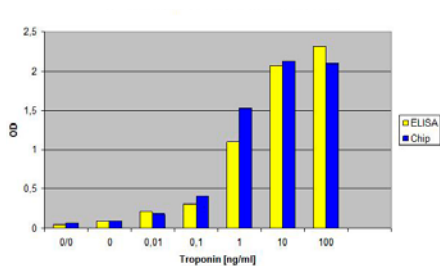
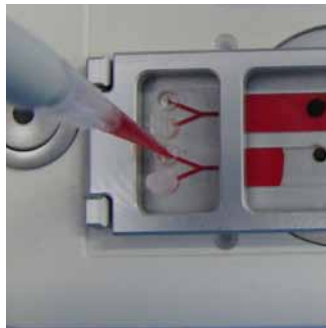
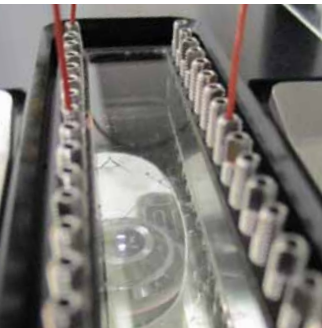

Fig. 635: Implementation of frit-based immunoassay on chip – Target: Troponin, comparison of standard ELISA plate versus assay on chip, colorimetric detection: poly HRP (pHRP)/TMB (blue dye)

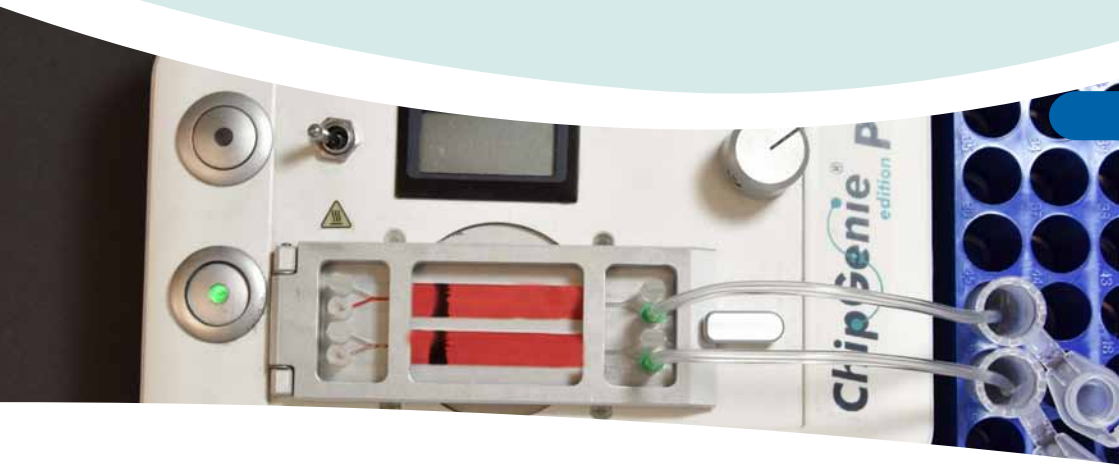

Fig. 636: Implementation of frit-based immunoassay on chip – Target: Troponin, colorimetric detection: poly HRP (pHRP)/TMB (blue dye)





# 15 Application notes



## Application notes

Handling procedures, protocols, and exemplary applications: This chapter gives advice to run specific experiments with lab-on-a-chip systems.



### 15.1 Chips interfaces and handling – first steps

This chapter describes first basic steps to start with microfluidic standard chips. It introduces the different fluidic interfaces on chip and their counterpart off chip, tubes to be used and the connection to pumps.

#### Fluidic interfaces on chip

Referring to standard equipment and nomenclature deriving from laboratory automation and routine laboratory use, a short glossary for the various microfluidic accessories being applied is convenient for a common use of microfluidics. This refers mainly to the fluidic interfaces using the Luer and Luer lock adapters in female and male version as plugs or fluid connectors commonly spread in medical technology, the shrunk versions thereof specially designed for microfluidics called Mini Luer fluid connectors and Mini Luer plugs, olives embedded on chip as well as simple through holes. Examples of these fluid connectors are shown in the figures below.

In all chapters explaining the use of the different interfaces, a choice of accessories being suited to carry out the experiments is summarized in order to start right away with the practical work.

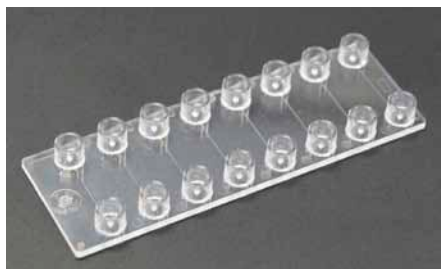

Fig. 637: Chip with female Luer fluidic interfaces

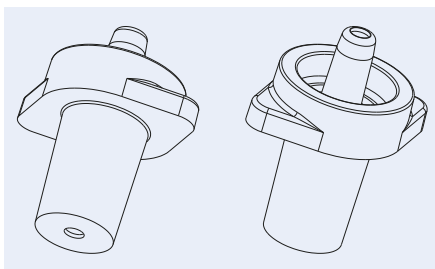

Fig. 638: Male Luer connector



Fig. 639: Cap to close female Luer interfaces



Fig. 640: Mini Luer plugs mounted on a Mini Luer fluidic platform

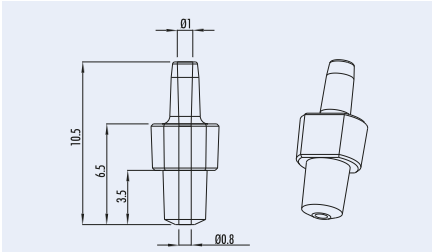

Fig. 641: Schematic drawing of a Mini Luer connector

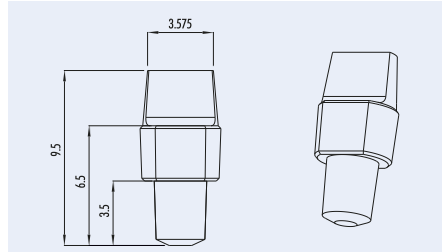

Fig. 642: Schematic drawing of a Mini Luer Plug

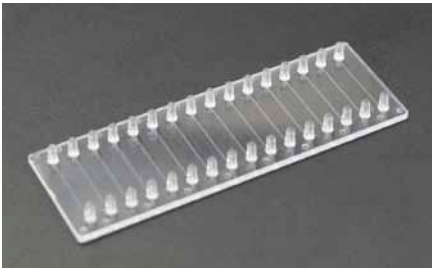

Fig. 643: Microfluidic platform with olives as fluidic interface

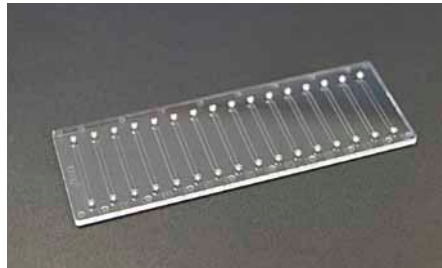

Fig. 644: Microfluidic platform with through holes as fluidic interface

### 15.1.1 How to work with Mini Luer interfaces

This chapter introduces how to work with Mini Luer interfaces and how to operate chips with such interfaces.

#### Hints to work with female Mini Luer interfaces on chip:

##### Option 1: Female Mini Luer interface as pipetting interface or reservoir

The most simple option how to use chips with female Mini Luer interface is to insert the liquid with a pipette or to use the female Mini Luer interfaces as reservoirs. For beginners it might be easier to use the specially designed Pipette to Mini Luer adapters (10000057)

##### **Required item:**

1. Microfluidic chip with Mini Luer interface
2. Conventional pipette
3. Optional Mini Luer to pipette adapters (10000057)

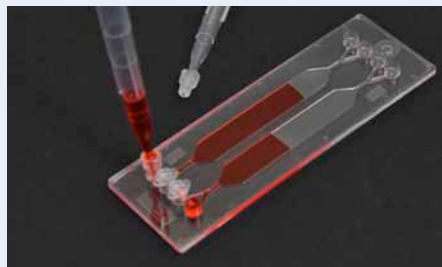

Fig. 645: Microfluidic chip with Mini Luer interfaces filled with a pipette and interfaces used as reservoir



### Hints to work with female Mini Luer interfaces on chip:

#### Option 2: Female Mini Luer interface combined with male Mini Luer counterpart

##### Required item:

1. Microfluidic chip with Mini Luer interface, e.g. micro mixer chip (10000020)
2. Handling frame, e.g. orange (10000043)
3. Male Mini Luer fluid connectors, e.g. the green version (10000029)
4. Male Mini Luer plugs, e.g. the red version (10000053)
5. Silicone tube, e.g. ID: 0.5 mm (10000033)
6. PTFE tube, e.g. ID: 0.5 mm (10000032)
7. Peristaltic pump
8. Tube for peristaltic pump
9. Eppendorf vessel



Fig. 646: Microfluidic chip with Mini Luer interfaces with Mini Luer fluid connectors and plugs

#### Step 1: Chip & handling frame

1. Insert the microfluidic chip in a handling frame for microfluidic chips in microscopy slide format



Fig. 647: Micromixer inserted in handling frame

#### Step 2: Mini Luer connector & silicone sleeve

2. Interface the Mini Luer fluid connector with a small piece of silicone tube



Fig. 648: Green Mini Luer fluid connector attached to silicone sleeve

#### Step 3: Silicone sleeve & PTFE tube

3. Interface the Mini Luer fluid connector with the mounted silicone sleeve with the PTFE tube



Fig. 649: Connection of Mini Luer fluid connector with mounted silicone sleeve with a PTFE tube



#### Step 4: Insert connector on chip

4. Insert the Mini Luer fluid connector connected with silicone sleeve and PTFE tubing with a twist on the female interface on chip

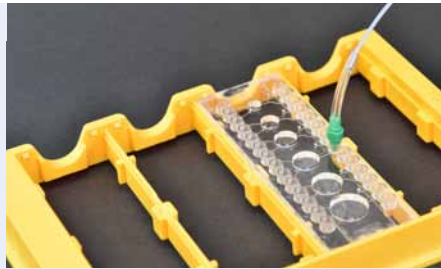

Fig. 650: Insertion of the Mini Luer with tubings in fluid entrance of the chip

#### Step 5: Insert connector on exit & connect to collection vessel

5. Insert a second Mini Luer fluid connector connected with silicone sleeve and PTFE tubing with a twist on the female interface on chip and place the end of the PTFE tube in an Eppendorf vessel for sample or waste collection

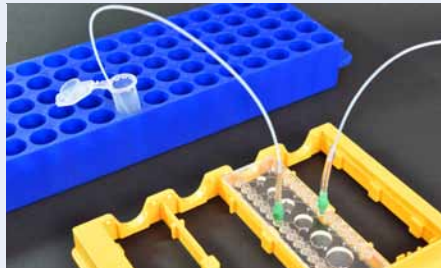

Fig. 651: Insertion of the Mini Luer with tubings in fluid exit of the chip and connection of tube with sampling vessel

#### Step 6: Close unused ports with plugs

6. Close all unused fluid entrance and fluid exit ports of the fluidic pathway used on chip with Mini Luer plugs.

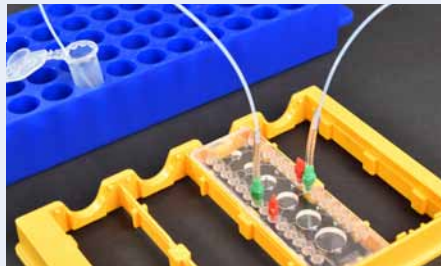

Fig. 652: Closed unused fluid ports on chip with red Mini Luer plugs

#### Step 7: Connect chip with pump

7. Connect the PTFE tube with the tube inserted in the pump



Fig. 653: Connection of the chip via the PTFE tube with the pump



### Step 8: Connect pump with reservoir and start pumping

8. Connect the end of the pump tube with a further PTFE tube, insert the PTFE tube in your reagent vessel and start pumping.

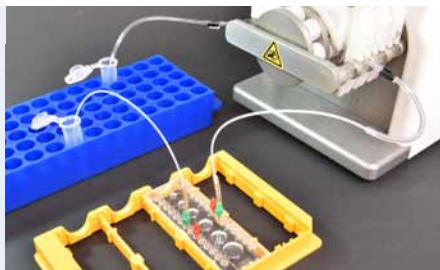

Fig. 654: Connection of pump via a PTFE tube with a liquid reservoir

### 15.1.2 How to work with Luer interfaces

This chapter summarizes the different options to work with Luer interfaces on chip and how to operate chips with such interfaces.

#### Hints to work with female Luer interfaces on chip:

##### Option 1: Female Luer interface as pipetting interface or reservoir

The most simple option how to use chips with female Luer interface is to insert the liquid with a standard syringe.

##### **Required item:**

1. Microfluidic chip with Luer interface
2. Standard syringe



Fig. 655: Microfluidic chip with Luer interfaces filled with a standard syringe

#### Hints to work with female Luer interfaces on chip:

##### Option 2: Female Luer interface as pipetting interface or reservoir

Another option how to use chips with female Luer interface is to insert the liquid with a pipette or to use the female Mini Luer interfaces as reservoirs.

##### **Required item:**

1. Microfluidic chip with Luer interface
2. Conventional pipette



Fig. 656: Microfluidic chip with Luer interfaces filled with a pipette and interfaces used as reservoir



## Hints to work with female Luer interfaces on chip:

### Option 3: Female Luer interface combined with male Luer counterpart

#### Required item:

1. Microfluidic chip with Luer interface, e.g. micro mixer chip (10000018)
2. Handling frame, e.g. orange (10000043)
3. Male Luer fluid connectors, e.g. the green version (10000081)
4. Male Luer plugs, e.g. the black version (10000231)
5. Silicone tube, e.g. ID: 0.5 mm (10000033)
6. PTFE tube, e.g. ID: 0.5 mm (10000032)
7. Peristaltic pump
8. Tube for peristaltic pump
9. Eppendorf vessel



Fig. 657: Required items for Luer interface demo

#### Step 1: Chip & handling frame

1. Insert the microfluidic chip in a handling frame for microfluidic chips in microscopy slide format

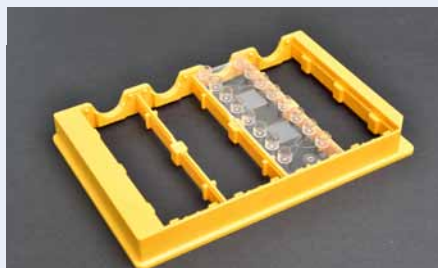

Fig. 658: Micromixer inserted in handling frame

#### Step 2: Luer connector & silicone sleeve

2. Interface the Luer fluid connector with a small piece of silicone tube



Fig. 659: Green Luer fluid connector attached to silicone sleeve

#### Step 3: Silicone sleeve & PTFE tube

3. Interface the Luer fluid connector with the mounted silicone sleeve with the PTFE tube



Fig. 660: Connection of Luer fluid connector with mounted silicone sleeve with a PTFE tube



### Step 4: Insert connector on chip

4. Insert the Luer fluid connector connected with silicone sleeve and PTFE tubing with a twist on the female interface on chip



Fig. 661: Insertion of the Luer with tubings in fluid entrance of the chip

### Step 5: Insert connector on exit & connect to collection vessel

5. Insert a second Luer fluid connector connected with silicone sleeve and PTFE tubing with a twist on the female interface on chip and place the end of the PTFE tube in an Eppendorf vessel for sample or waste collection



Fig. 662: Insertion of the Luer with tubings in fluid exit of the chip and connection of tube with sampling vessel

### Step 6: Close unused ports with plugs

6. Close all unused fluid entrance and fluid exit ports of the fluidic pathway used on chip with Luer plugs.



Fig. 663: Close unused fluid ports on chip with red Luer plugs

### Step 7: Connect chip with pump

7. Connect the PTFE tube with the tube inserted in the pump

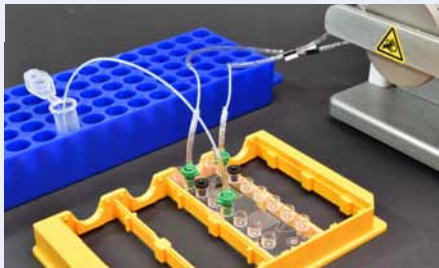

Fig. 664: Connection of the chip via the PTFE tube with the pump





### 15.1.3 How to work with olive interfaces

Olive interfaces are simple connectors to be manually connected with tubes like the best known example of our daily life, the hose pipes. Tubes can be directly connected to such chips. They are well suited for manual handling, but automated approaches moving the silicone sleeve over the olive are possible as well, even if difficult to realize. This chapter summarizes the different options to work with olive interfaces on chip and how to operate chips with such interfaces.

#### Hints to work with olive interfaces on chip:

##### Olive interfaces connected through silicones sleeves and PTFE tube to pump

###### Required item:

1. Microfluidic chip with olive interface, e.g. straight channel chip (10000275)
2. Handling frame, e.g. orange (10000043)
3. Silicone tube, e.g. ID: 0.5 mm (10000033)
4. PTFE tube, e.g. ID: 0.5 mm (10000032)
5. Peristaltic pump
6. Tube for peristaltic pump
7. Eppendorf vessel

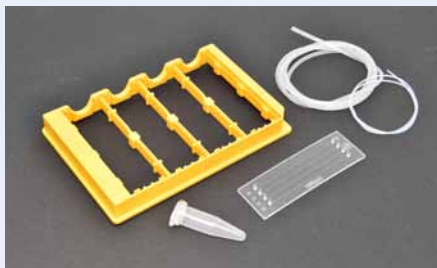

Fig. 665: Required items for olive interface demo

##### Step 1: Chip & handling frame

1. Insert the chip in a handling frame



Fig. 666: Microfluidic chip with olive interfaces inserted in a microfluidic chip handling frame



### Step 2: Connect PTFE tubes with silicone sleeves

2. Connect two times a short silicone tube with a longer PTFE tube



Fig. 667: Short pieces of silicone tubes connected with PTFE tube

### Step 3: Interface chip & tube

3. Interface the olives on chip through the silicone sleeves with the PTFE tube



Fig. 668: Chip with olive interfaces connected with tubes

### Step 4: Insert tube in pump tube

4. Insert the PTFE tube in the tube of the pump

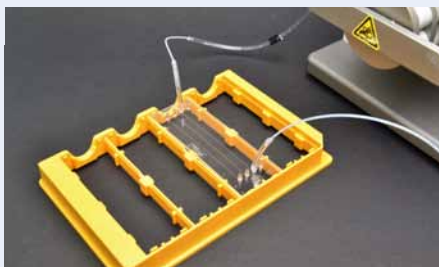

Fig. 669: Chip with olives connected via tubes to a peristaltic pump

### Step 5: Tube, pump & reservoir vessel

5. Connect the tube of the pump with a PTFE tube with the reservoir vessel

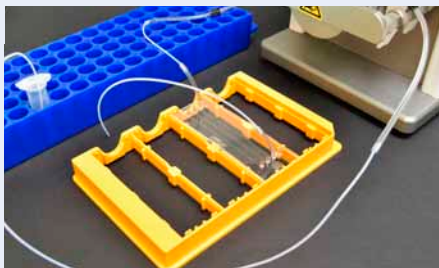

Fig. 670: Pump tube connected to reservoir vessel



#### Step 6: Connection collection vessel & start pumping

6. Connect the exit tube with a collection vessel and start pumping

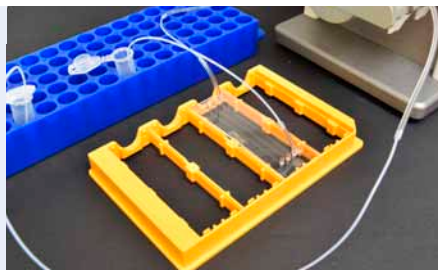

Fig. 671: Chip with olives connected via tubes to a pump addressing a reservoir vessel from the outlet

## 15.2 Droplet generator chip – options to use the chip

Droplet generator chips offer a lot of possibilities how to use them and to optimize the results. Besides the structure itself, the operation mode matters. Sample inlet and main stream channel might be varied, a hydrophobic surface coating may be applied, or simple variation of the flow velocity or the injection volume can be modified, resulting in different droplet patterns. The following description aims to give an idea how to start with such devices followed by a set of further experiments.

### Hints to work with droplet generator:

#### Droplet generator chip 0162

##### Required item:

1. Droplet generator chip, material PC (polycarbonate), (10000176)
2. Handling frame, e.g. orange (10000043)
3. Male Mini Luer fluid connectors, e.g. the green version (10000029)
4. Male Mini Luer fluid connectors, e.g. the opaque version (10000094)
5. Male Mini Luer plugs, e.g. the red version (10000053)
6. Silicone tube, e.g. ID: 0.5 mm (10000033)
7. PTFE tube, e.g. ID: 0.5 mm (10000032)
8. Oil, e.g. 10001079 and surfactant to add
9. Appropriate pump
10. Tube for pump
11. Eppendorf vessel
12. Microscope
13. Computer

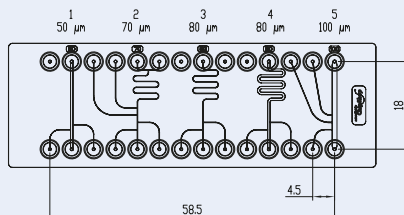

Fig. 672: Droplet generator Fluidic 285



### Step 1: Chip & handling frame

1. Required items as describe above



Fig. 673: Required items for droplet generation

### Step 2: Chip & handling frame

2. Insert the chip i a handling frame



Fig. 674: Droplet generator Fluidic 285 placed in handling frame

### Step 3: Interface chip

3. Interface the mini Luer connector with a silicon sleeve and connect it to the PTFE tube



Fig. 675: Mini Luer to fluid connector with silicon sleeve and PTFE tube

### Step 4: Interface chip & connect oil phase

4. Connect the ports for the oil phase via a green mini Luer connectors, a silicone sleeve and PTFE tube to the pump tube

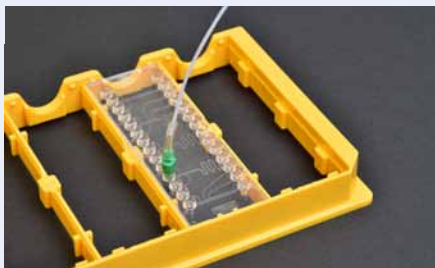

Fig. 676: Droplet generator with connected oil phase



#### Step 5 - 6: Interface chip & connect aqueous phase

5. Connect the port for the aqueous phase via a opaque mini Luer connects, a silicon sleeve and PTFE tube to the pump tube
6. Plug the unused entrance port of the chip with a red mini Luer plug

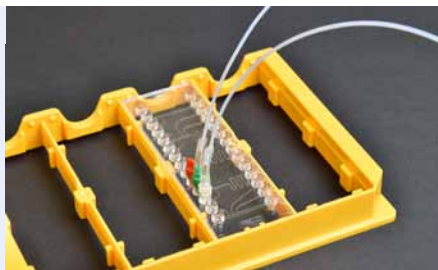

Fig. 677: Droplet generator with connected aqueous phase and closed redundant inlet

#### Step 7 - 9: Connect outlet & carry out experiment

7. Connect the exit port via a mini Luer connector, a silicone sleeve, and PTFE tube to the Eppendorf tube
8. Start pumping the oil and wait for a stable flow
9. Start pumping the aqueous phase and observe droplet generation. You have to vary the flow rate of the aqueous phase to generate droplets of the desired size



Fig. 678: Complete experimental setup with the exit port of the droplet generator connected to a collection vessel

#### Step 10: Visualisation

10. Visualize the experiment with a microscope and characterize the droplet size



Fig. 679: Droplets generated on chip



### 15.3 On-chip DNA isolation with ChipGenie® edition P using magnetic beads

This chapter describes a procedure using ChipGenie® edition P for the isolation of genomic DNA e.g. for downstream PCR out of a variety of samples such as blood or pathogen-containing liquids. To do so, magnetic beads that bind DNA from cells (blood or bacteria) are added to a sample mixture which is afterwards injected into a compatible microfluidic chip. After a washing procedure, the purified DNA is extracted from the beads inside the chip. Depending on the sample and application, the single steps described below vary slightly.

The instructions describe the basic steps which are necessary for the on-chip DNA isolation from full blood using the ChipGenie® edition P starter kit 3, to obtain PCR-competent genomic DNA in less than 30 min.

#### Required tools & ingredients:

1. ChipGenie® edition P instrument (10000166, 695.00 €)
2. ChipGenie® edition P starter kit 3 – DNA extraction – THREE STEP PROCEDURE (10001261, 561.43 €)
3. A waste reservoir (e.g. Eppendorf tube or falcon tube)

#### The application procedure includes:

1. The preparation of the chip
2. The on-chip sample lysis and DNA purification
3. The DNA elution

#### Chip preparation:

Take a suitable microfluidic chip, here the rhombic chamber chip (Fluidic172) and close the excess inlet and outlet ports using a mini-Luer plug. Optionally, equip the open inlet ports with a Luer-to-pipette adapter, to simplify the liquid handling using a conventional pipette.

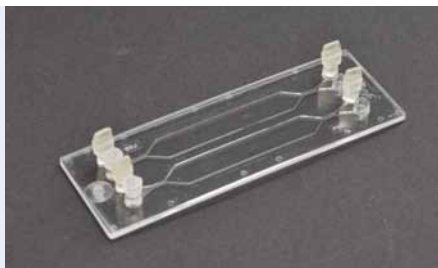

Fig. 680: Rhombic chamber chip equipped with mini-Luer connectors and mini-Luer-to-pipette adapters.

#### Instrument preparation:

Place the chip inside the instrument and close the holding frame. Insert mini-Luer-to-fluid connectors into the open outlet ports, which were beforehand equipped with a silicon sleeve and PTFE tubing.



Fig 681: Chip inserted into ChipGenie® edition P instrument and installed connectors with silicone sleeve and PTFE tubing.



#### Sample lysis and purification:

For lysis, mix the blood sample with the provided mcs lysis buffer and incubate the mixture at RT inside an Eppendorf tube. Add the provided magnetic beads and mcs wash buffer 2 to this mixture and inject it into one of the rhombic chambers using a pipette. Incubate the mixture with the switched on magnetic mixer to achieve binding of the DNA to the beads. Afterwards, empty the chamber by flushing it with air with the help of a pipette. Now, stepwise purification of the DNA attached to the magnetic beads is done, by subsequently injecting mcs wash buffers 1, 2 and then 3 into the rhombic chambers. Each of this purification steps is thereby carried out with the switched on magnetic mixer. At last, the chamber is emptied again by flushing it with air.



Fig. 682: ChipGenie® edition P instrument with a blood sample inside the rhombic chamber. The magnetic beads, migrating through the chambers, are visible as black bars.

#### DNA elution:

In the final step, mcs elution buffer is injected into the chamber leading to the extraction of the purified DNA from the magnetic beads. The efficiency of this is improved by switching on the magnetic mixer and adjusting a temperature of 50 °C, with the help of the heating element inside the ChipGenie edition P instrument. The mini-Luer connector is disconnected from the outlet ports and the eluate is aspirated with the help of a pipette.



Fig. 683: ChipGenie® edition P instrument with washing buffer inside the rhombic chamber.

## 15.4 Membrane chip

*microfluidic ChipShop* membrane chips can be equipped with various membranes to be used for simple filtration tasks, for the implementation of assays on the membrane, or for plasma generation.

### 15.4.1 On-chip plasma generation out of whole blood

The membrane chip enables you to generate blood plasma from 20-40  $\mu$ l of whole blood (stabilized or non-stabilized) within less than 2 minutes. The yield is roughly 50% of plasma. A special membrane inside the chip retains all blood cells. The pure plasma migrates through the filter.

#### Required tools & ingredients

1. Chip with 4 plasma generation membranes (10000021)
2. Mini Luer plugs (10000030)
3. Eppendorf vessel

#### The application procedure includes three steps:

1. Preparation of the chip
2. Sample loading
3. Filtration



### Preparation steps:

The ventilation ports of the membrane chip are closed with Mini Luer plugs and the chip is placed on a bench in the shown orientation.



Fig 684: Membrane chip Fl. 200 with Mini Luer plugs

### Sample loading:

Pipette the designated volume (between 20 and 40  $\mu\text{l}$ ) of whole blood into Luer-inlet-port of the membrane chip.

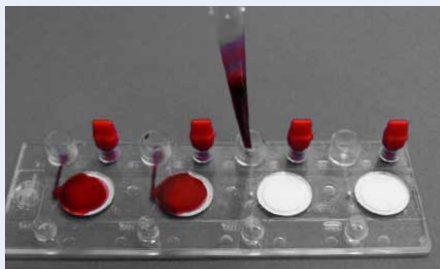

Fig 685: Insertion of blood in membrane chip

### Filtration:

Use a pipette (for yellow tips) with a set volume of 100  $\mu\text{l}$ . Press the pipette tip tightly into the sample outlet port and suck slowly for  $\sim 30$  sec. Formation of air bubbles during filtration is normal and has no effect on the generated plasma. Fill the filtrated plasma into a fresh Eppendorf tube.

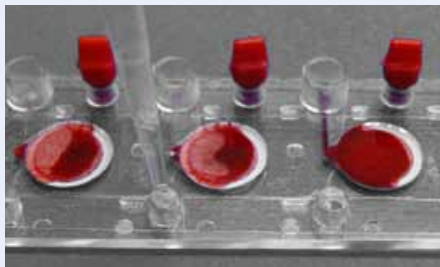

Fig 686: Plasma take up

### Results:

Based on your starting volume, between 10 and 20  $\mu\text{l}$  of blood plasma will be generated. It should be clear, light yellow and free of blood cells.



Fig 687: On-chip generated plasma





### 15.5 Cell culture with Lab-on-a-Chip Cell Culture Incubator LOC-CCI 1

An easy handling of cell cultures can be achieved with the help of the **Lab-on-a-Chip Cell Culture Incubator LOC-CCI 1** allowing for a short and long term CO<sub>2</sub>-independent cell culture.

The **Lab-on-a-Chip Cell Culture Incubator LOC-CCI 1** has to be equipped with a consumable microfluidic device, the cell culture itself has to be inserted with the help of a pipette, tubing has to be connected and everything is placed on the stage of a microscope. Heater and pumps have to be accommodated to the respective cell culture conditions. Either static media supply or continuous flow can be used for medium exchange or cell treatment. Cell based assays can be performed over a few hours up to several weeks according to the experimental needs.

**Preparation step:**

Insert cell culture on chip with pipetteInsert chip in Lab-on-a-Chip Cell Culture Incubator LOC-CCI 1

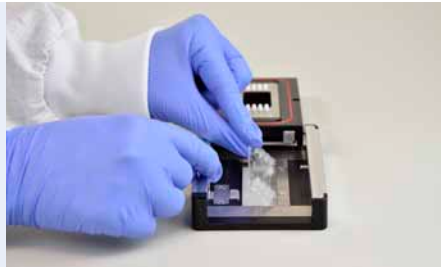

Fig 688: Rhombic chamber chip placed in Lab-on-a-Chip Cell Culture Incubator – LOC CCI 1

**Preparation step:**

Connect chip and Lab-on-a-Chip Cell Culture Incubator LOC-CCI 1 with external pumps



Fig 689: Lab-on-a-Chip Cell Culture Incubator – LOC CCI 1 with embedded chip and capillaries for the connection of pumps

**Preparation step:**

Place chip and Lab-on-a-Chip Cell Culture Incubator LOC-CCI 1 and define pump rate and heating conditions: Run experiments

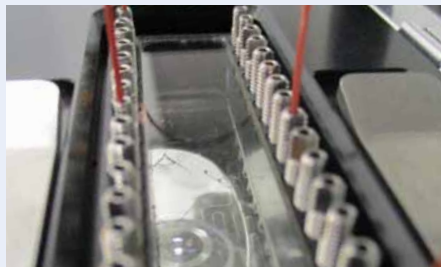

Fig 690: Lab-on-a-Chip Cell Culture Incubator – LOC CCI 1 during use on microscope stage

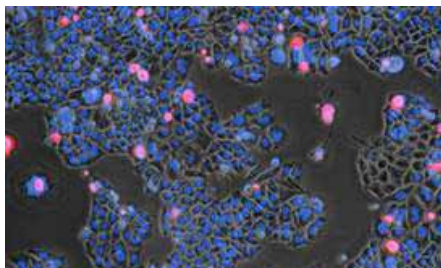

Fig 691 : Cell culture carried out in CO<sub>2</sub>-incubator

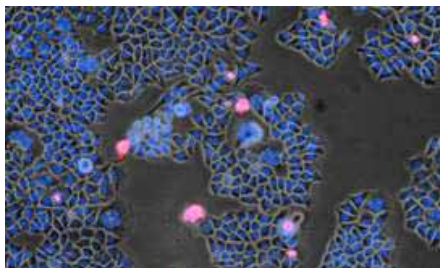

Fig 692: Cell culture done in Lab-on-a-Chip Cell Culture Incubator – LOC CCI 1

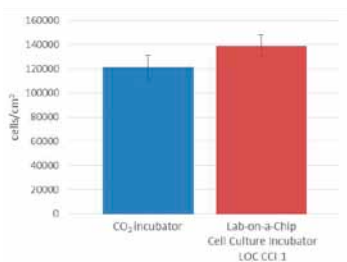

Fig 693: Comparison of cell culture done in CO<sub>2</sub>-incubator and Lab-on-a-Chip Cell Culture Incubator – LOC CCI 1

That CO<sub>2</sub>-independent cultivation of cells in the Lab-on-a-Chip Cell Culture Incubator – LOC CCI 1 leads to slightly increased proliferation in comparison to common CO<sub>2</sub>-incubator-based cell culture.

Product Code	Description	Price [€]		
		included adapter plate 2x4	2x8	2x16
10000743	LOC CCI 1 with heating elements (incl. 1 adapter plate of your choice)	1,875.00		
10001216	Additional adapter plate	390.00	390.00	390.00

Product Code	Description	Detail	Price [€]
10000286	LOC-CCI 1 starter kit 1	- Male Mini Luer plugs, red, material: PP (10)	10000053
		- Rhombic chamber chip, 120 µl chamber volume, 500 µm channel depth, hydrophilized, material: Topas (10)	10000244
		- Rhombic chamber chip, 100 µl chamber volume, 600 µm channel depth, hydrophilized, material: Topas (10)	10000405
		- Rhombic chamber chip, 250 µl chamber volume, 800 µm channel depth, hydrophilized, material: Topas (10)	10000365



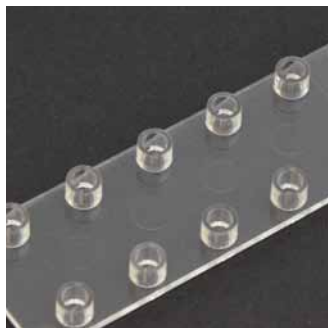
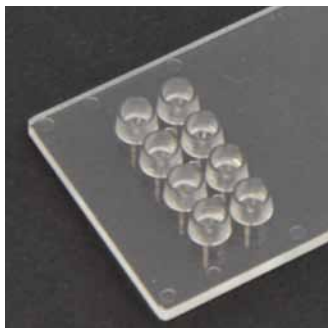
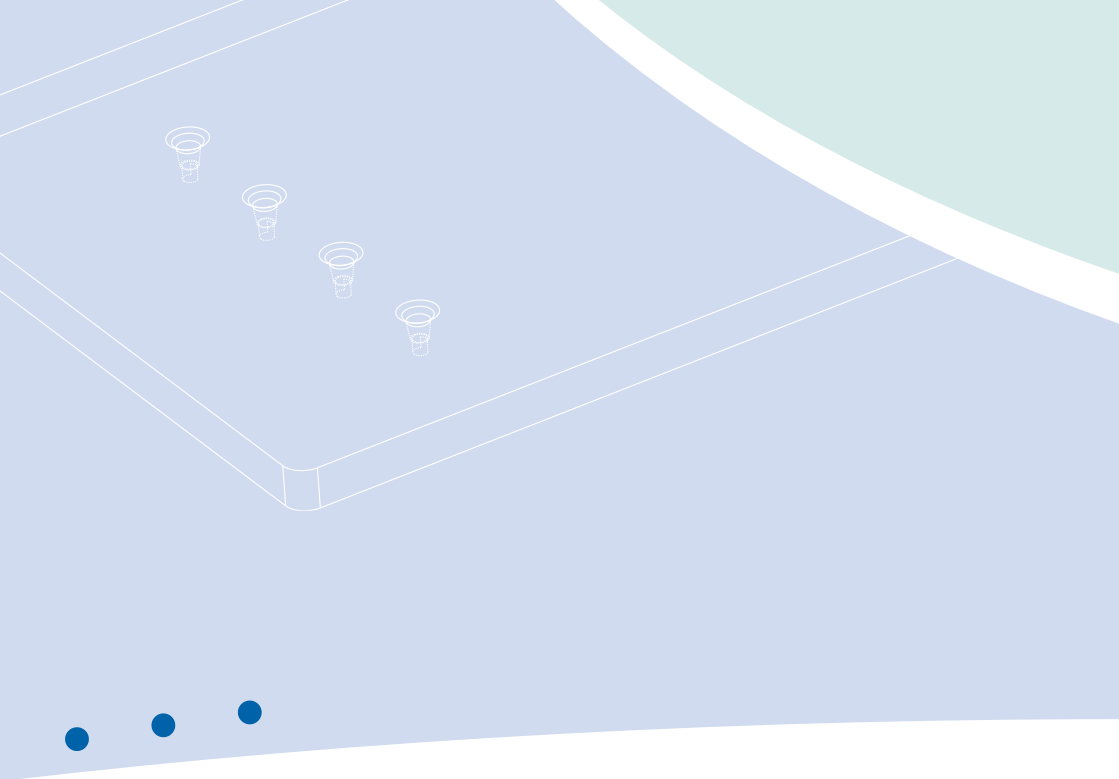

# 16 Fabrication services



## Fabrication services

The main part of our work is dedicated to the realization of custom-designed chips. We assist in the proper microfluidic design, the adoption of the design to fabrication needs, as well as the choice of the appropriate fabrication technology.

In order to assist you in your design work, chapter **16.1 General design guidelines for polymer-based microfluidic devices** helps you to judge the feasibility of design features of microfluidic chips.

In chapter **16.2 Backend processing** you will learn which further services we offer to enhance your customized microfluidic chip.

Chapter **16.3 Fluidic platforms for custom design** helps you in making the proper choice of, for example, proprietary microfluidic chip formats versus standard formats or of the appropriate fluidic interface, also considering cost and functional aspects.



### 16.1 General design guidelines for polymer-based microfluidic devices

The manufacturability of a device depends on the individual design and the interaction between its various design elements. In this respect, the following design guidelines for polymer-based microfluidic devices give the user a better understanding of possible limitations in the design of a specific structure. For the microfluidic design, two aspects besides the functionality have to be considered right at the start of the design process: It must firstly be checked whether the design can be realized by replicative technologies – allowing for low-cost mass-manufacturing – like injection molding, and secondly whether the back-end processes, in particular the assembly (usually the secure sealing of the fluid with a cover lid), can be ensured.

Besides the purely technical constraints, cost considerations can also have an influence on the chosen manufacturing route, as different methods for mold insert fabrication have different technical constraints (minimum feature size, maximum height, surface roughness, etc.) as well as different cost ranges.

#### a) Feature density

In order to allow for a good bond between a structured part and a cover foil, two adjacent channels or similar features should be separated by at least twice their width, but not less than  $200\ \mu\text{m}$ . Not more than 50% of the overall surface area should be covered with structural elements.

#### b) Distance to device edges

In order to allow for a good bond, features should have a minimum distance from the edge of the device of 2 mm. The larger the device and the feature size, the larger this distance should be.

#### c) Minimum feature depth

Structures should have a minimum depth of  $5\ \mu\text{m}$  for features  $< 100\ \mu\text{m}$ . For features between 100 and  $1000\ \mu\text{m}$ , the minimum depth is  $15\ \mu\text{m}$ .

#### d) Minimum residual thickness of the device

The minimum residual thickness of the device in structured areas is  $500\ \mu\text{m}$  for areas  $> 1\ \text{cm}^2$ . For smaller areas, a lower residual thickness might be possible, depending on the overall device layout.

#### e) Maximum feature width

There is no practical limit to the feature width, however in the case of features wider than 4 mm, support structures to prevent the cover lid from sagging might have to be included in the design.

#### f) Aspect ratio

For injection molded parts, the aspect ratio for microstructured elements should be less than 2.

#### g) Through-holes

The minimum diameter of through-holes realized by standard core pins is  $500\ \mu\text{m}$ . Smaller holes can be realized with additional means upon request.

#### h) Open areas

Open areas (see Fig. 694) are possible.

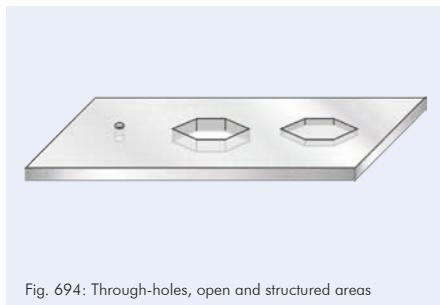

Fig. 694: Through-holes, open and structured areas



### 16.1.1 General design guidelines for mechanically machined mold inserts

For mold inserts fabricated using precision machining (for example in brass or stainless steel), the following design restraints are valid in addition to the ones given above:

#### a) Minimum feature size

The minimum feature size for sunk features (i.e. features where the mold insert material has to be removed; see Fig. 695) is  $50\ \mu\text{m}$ . For features in the range between  $50$  and  $100\ \mu\text{m}$ , the aspect ratio is limited to 1.5.

#### b) Minimum radius of curvature

At intersecting features (e.g. channel crossings), a radius of curvature of  $40\ \mu\text{m}$  occurs as standard. Smaller radii down to  $10\ \mu\text{m}$  are available upon request and depend on the aspect ratio of the respective structure

#### c) Feature heights

Different height steps as well as slopes of up to  $45^\circ$ – $90^\circ$  (depending on absolute feature size) are possible.

#### d) Surface roughness

Mechanical machining results in a surface roughness of the order of  $0.5$ – $1\ \mu\text{m}$  RMS. The features can be polished if protruding (e.g. channel floors in the polymer part which are ridges in the mold insert; see Fig. 603), to create an optical finish (roughness  $< 50\ \text{nm}$  RMS).

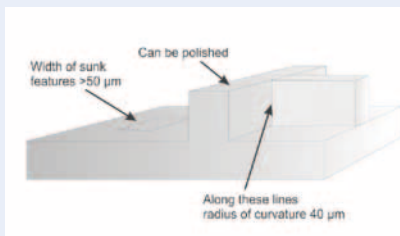

Fig. 695: Features of a milled mold insert

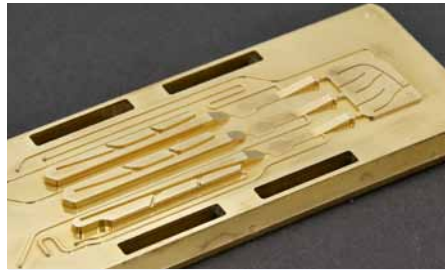

Fig. 696: Mold insert realized using ultraprecision mechanical machining

### 16.1.2 General design guidelines for mold inserts fabricated using lithography and electroplating

For mold inserts fabricated using lithography and electroplating (either e.g. from a silicone or glass master), the following design restraints are valid in addition to the ones given above:

#### a) Minimum feature size

The minimum feature size is  $10\ \mu\text{m}$ . For features in the range between  $10$  and  $100\ \mu\text{m}$ , the aspect ratio is limited to 1.5.

#### b) Maximum height

For lithography-based mold inserts, the maximum feature height is  $100\ \mu\text{m}$ .



### 16.2 Backend processing

At *microfluidic ChipShop* we offer a variety of services to further modify your microfluidic chip. Those include:

#### a) Surface modification

Thermoplastic materials are natively hydrophobic with water contact angles  $>80^\circ$ . Several technologies are available to render them more hydrophilic. We can offer both physical hydrophilization as well as chemical surface modification processes. Furthermore, also local surface modification processes are available however keep in mind that any process that requires masking will lead to increased production cost.

#### b) Reagent integration

To integrate reagents, we provide options for both liquid and dry reagent integration. For liquid reagent integration, please see our blister and tank options (chapter 8). Dry reagents can be integrated either as lyophilized reagents for which we offer protocol development or via spotting and air drying.



Fig. 697: Spotter technology available at *microfluidic ChipShop* for reagent integration

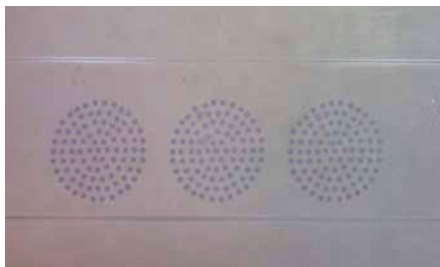

Fig. 698: Spotted probes (diameter  $80\ \mu\text{m}$ ) in straight channel chip 272

### 16.3 Fluidic platforms for custom design

The investment in an injection-molding tool is quite frequently between the choice of a chip in a unique outer format and an existing format. *microfluidic ChipShop's* unique "Design-your-Lab Concept" enables you to benefit from existing injection-molding tools for quite common microfluidic chip formats like the microscopy slide, the microtiter plate, or the CD, avoiding the costs of investing in your own injection-molding tool.

Within this chapter, our standard formats, including various kinds of fluidic interfaces, are summarized. The interfacing side of the device has a fixed geometry while the bottom part is free for your individual design. All platforms are available as blank slides with the respective interfaces. This allows a rapid prototyping of structures e.g. by direct mechanical machining of the microstructures into the slides. This method of prototyping yields devices which have an identical "look&feel" to a molded part including the fluidic interfaces and the chemical properties. The only difference to a molded part is the slightly increased surface roughness which gives the machined areas a matt appearance.





### 16.3.1 Microscopy slide format

The microscopy slide format (75.5 mm x 25.5 mm x 1.5 mm) is now an accepted standard in the lab-on-a-chip field and has several advantages: A handy format that makes manual manipulation easy, not too big and not too small, it fits perfectly onto any microscope, and handling frames can be used in order to place the microscopy slide inside and to work with existing laboratory equipment systems, for example for filling or read-out.

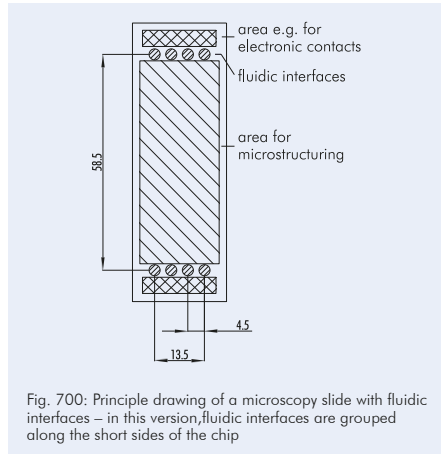
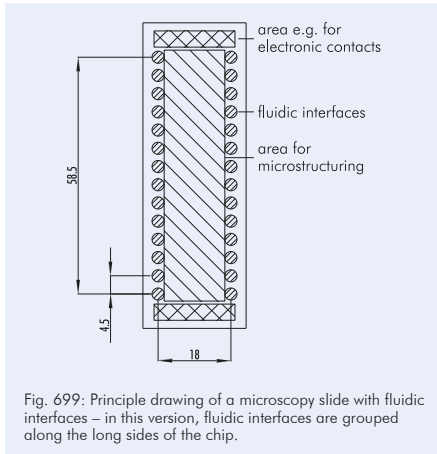

The chip-to-world interface frequently remains a challenge – and standard solutions and solutions optimized for microfluidic applications are directly at hand. This raises two questions that are promptly answered by *microfluidic ChipShop's* fluidic platforms:

#### I. The kind of fluidic interface:

*microfluidic ChipShop's* microscopy slide formats are available with:

- Simple through holes
- Olives as tube interfaces
- Female Luer connectors
- Female mini Luer connectors

#### II. The position of the fluidic interface:

- Grouped along the long side with 9 mm spacing, corresponding to the spacing of a 96-well plate
- Grouped along the long side with 4.5 mm spacing, corresponding to the spacing of a 384-well plate
- Grouped along the short side with 4.5 mm spacing, corresponding to the spacing of a 384-well plate

As highlighted above, the range of fluidic interfaces offered with the microscopy slide format includes simple through-holes, olives, and Luer and Mini Luer connectors. All connectors are spaced according to the well-spacing of a 384-well microtiter plate, e.g. with a center-center distance of 4.5 mm between connectors except for the standard Luer connectors working with the spacing of a 96-well plate of 9 mm in order to allow pipetting robots or other automated equipment to be used.

One of the microscopy slide chip families is characterized by 16 interfaces with 4.5 mm spacing along the long side, which allows two rows of eight reagents from a microwell plate to be pipetted and the use of a conventional eight-times multipipette.



### 16.3.1.1 Microscopy slide platforms – Fluidic interface: Through holes

The **through-hole platforms** are frequently used with O-rings or membranes integrated in an instrument in order to give a proper sealing via press fittings. They are also a good interface for pipettes. One additional advantage of this interface besides the ease of application is the potential storage of the chips after use, as the interfaces can be sealed with tape to prevent contamination or evaporation. A drawback of this kind of interface is the low pressure stability on the chip-side of the connection, which has to be countered with a suitable counterpart on the instrument side. Standard diameter for the through-holes is 0.8 mm (top) and 0.5 mm (bottom); other diameters are available upon request.

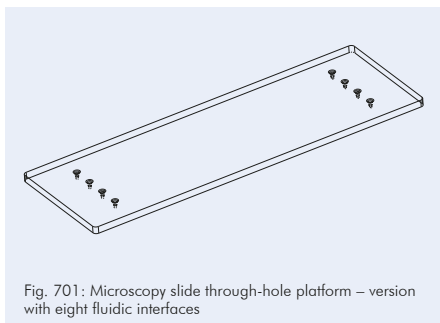

Fig. 701: Microscopy slide through-hole platform – version with eight fluidic interfaces

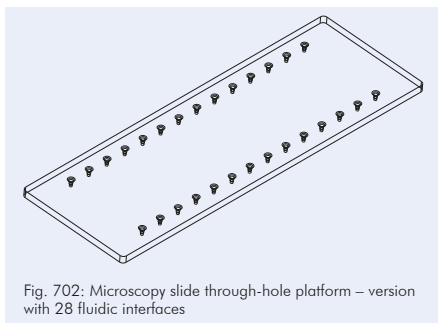

Fig. 702: Microscopy slide through-hole platform – version with 28 fluidic interfaces

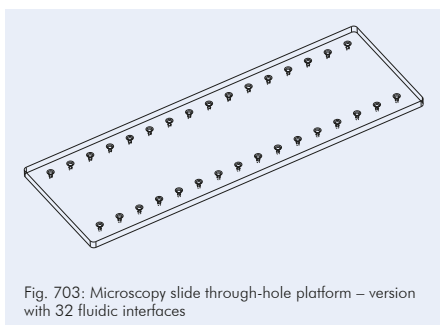

Fig. 703: Microscopy slide through-hole platform – version with 32 fluidic interfaces

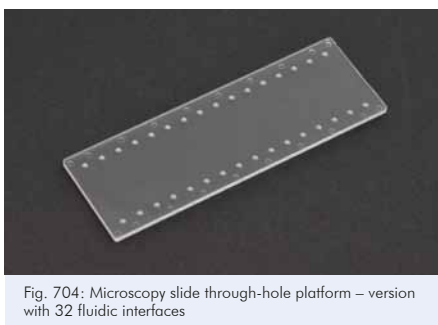

Fig. 704: Microscopy slide through-hole platform – version with 32 fluidic interfaces

Product Code	Description	Material	Price [€]	
			1+	10+
10000395	Microscopy slide platform 2 x 4 through-holes, pack of 10 slides	PMMA	55.00	30.00
10000483	Microscopy slide platform 2 x 4 through-holes, pack of 10 slides	PC	55.00	30.00
10000422	Microscopy slide platform 2 x 4 through-holes, pack of 10 slides	Topas	55.00	30.00
10000379	Microscopy slide platform 2 x 4 through-holes, pack of 10 slides	Zeonor	55.00	30.00
10000484	Microscopy slide platform 2 x 14 through-holes, pack of 10 slides	PMMA	55.00	30.00
10000485	Microscopy slide platform 2 x 14 through-holes, pack of 10 slides	PC	55.00	30.00
10000323	Microscopy slide platform 2 x 14 through-holes, pack of 10 slides	Topas	55.00	30.00
10000324	Microscopy slide platform 2 x 14 through-holes, pack of 10 slides	Zeonor	55.00	30.00
10000421	Microscopy slide platform 2 x 16 through-holes, pack of 10 slides	PMMA	55.00	30.00
10000486	Microscopy slide platform 2 x 16 through-holes, pack of 10 slides	PC	55.00	30.00
10000487	Microscopy slide platform 2 x 16 through-holes, pack of 10 slides	Topas	55.00	30.00
10000451	Microscopy slide platform 2 x 16 through-holes, pack of 10 slides	Zeonor	55.00	30.00



### 16.3.1.2 Microscopy slide platforms – Fluidic interface: Olives

Our **olive microfluidic platforms** enable a direct interface of tubing and microfluidic chips. For example, silicone tubes can be used to connect the olives with standard PE or PTFE tubing or PEEK capillaries. The silicone tubing easily slides over the tapered olives and guarantees a hermetic seal up to pressures of approximately 3 bar (42 psi). This connector is especially suited to non-automated experiments where syringes or other external pumps are to be connected to the chip. To minimize experimental variations due to the pressure-induced expansion of a longer silicone tube, short sections of silicone tubing can be used to connect stiff tubes (e.g. PTFE, PEEK, or PE tubing) with either the chip or the pump. This interface results in a dead volume of roughly  $2 \mu\text{l}$  due to the internal volume of the olives which is added to the dead volume of the tubing.

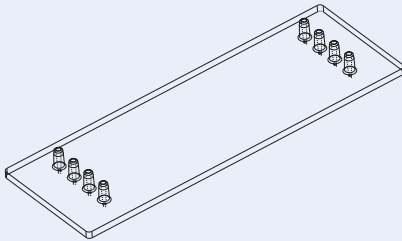

Fig. 705: Microscopy slide olive platform – version with eight fluidic interfaces

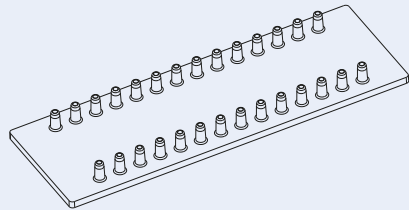

Fig. 706: Microscopy slide olive platform – version with 28 fluidic interfaces

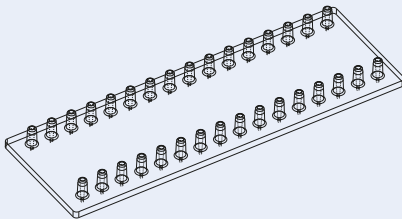

Fig. 707: Microscopy slide olive platform – version with 32 fluidic interfaces

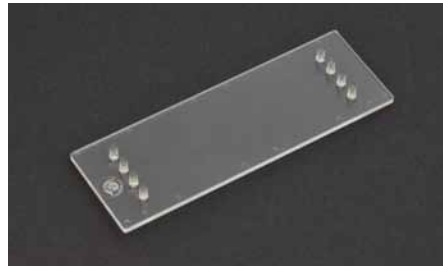

Fig. 708: Microscopy slide olive platform – version with eight fluidic interfaces

Product Code	Description	Material	Price [€]	
			1+	10+
10000478	Microscopy slide platform 2 x 4 olives, pack of 10 slides	PMMA	55.00	30.00
10000477	Microscopy slide platform 2 x 4 olives, pack of 10 slides	PC	55.00	30.00
10000476	Microscopy slide platform 2 x 4 olives, pack of 10 slides	Topas	55.00	30.00
10000475	Microscopy slide platform 2 x 4 olives, pack of 10 slides	Zeonor	55.00	30.00
10000474	Microscopy slide platform 2 x 14 olives, pack of 10 slides	PMMA	55.00	30.00
10000473	Microscopy slide platform 2 x 14 olives, pack of 10 slides	PC	55.00	30.00
10000472	Microscopy slide platform 2 x 14 olives, pack of 10 slides	Topas	55.00	30.00
10000471	Microscopy slide platform 2 x 14 olives, pack of 10 slides	Zeonor	55.00	30.00
10000470	Microscopy slide platform 2 x 16 olives, pack of 10 slides	PMMA	55.00	30.00
10000469	Microscopy slide platform 2 x 16 olives, pack of 10 slides	PC	55.00	30.00
10000468	Microscopy slide platform 2 x 16 olives, pack of 10 slides	Topas	55.00	30.00
10000465	Microscopy slide platform 2 x 16 olives, pack of 10 slides	Zeonor	55.00	30.00



### 16.3.1.3 Microscopy slide platforms – Fluidic interface: Luer

Our **Luer platforms** are equipped with standard Luer connectors known from the medical field and are especially suited for operations working with a male Luer counterpart, as is found in conventional syringes. This opens the way for manual operations and the direct transfer of samples taken with a syringe to the chip. Furthermore, they are perfectly suited as press-fittings to connect with an instrument. Luer microfluidic platforms are available with either Luer connectors on either side with a symmetrical arrangement and 9 mm spacing or five Luer connectors on either side with a spacing of 13.5 mm and an offset of 2.5 mm from the center. The Luer connectors ensure leak-tight connections up to pressures of several bar, enough for complex chips with comparatively high back-pressures.

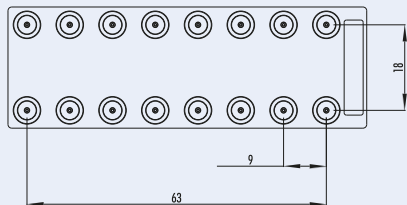

Fig. 709: Microscopy slide Luer platform – version 16 fluidic interfaces

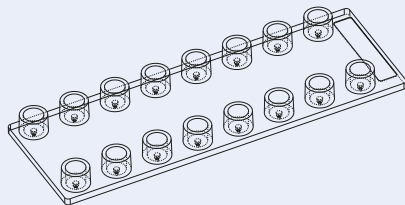

Fig. 710: Microscopy slide Luer platform – version 16 fluidic interfaces

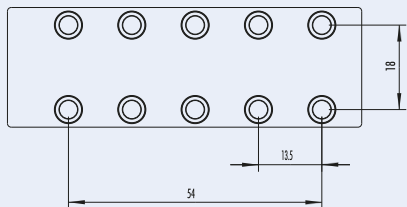

Fig. 711: Detail of the microscopy slide Luer platform with ten fluidic interfaces



Fig. 712: Example of microscopy slide Luer platform with ten Luer interfaces

Product Code	Description	Material	Price [€]	
			1+	10+
10000393	Microscopy slide platform 2 x 5 Luer connectors, pack of 10 slides	PMMA	55.00	30.00
10000479	Microscopy slide platform 2 x 5 Luer connectors, pack of 10 slides	PC	55.00	30.00
10000480	Microscopy slide platform 2 x 5 Luer connectors, pack of 10 slides	Topas	55.00	30.00
10000481	Microscopy slide platform 2 x 5 Luer connectors, pack of 10 slides	Zeonor	55.00	30.00
10000403	Microscopy slide platform 2 x 8 Luer connectors, pack of 10 slides	PMMA	55.00	30.00
10000482	Microscopy slide platform 2 x 8 Luer connectors, pack of 10 slides	PC	55.00	30.00
10000407	Microscopy slide platform 2 x 8 Luer connectors, pack of 10 slides	Topas	55.00	30.00
10000406	Microscopy slide platform 2 x 8 Luer connectors, pack of 10 slides	Zeonor	55.00	30.00



### 16.3.1.4 Microscopy slide platforms – Fluidic interface: Mini Luer

The Mini Luer microfluidic platforms combine the same advantages as their larger counterparts, with reduced dimensions (outer diameter 4 mm instead of 6 mm), thus allowing for more connectors on the chip. Up to 16 ports along the long side of a microscopy slide can thus be realized. Male Mini Luer plugs for closing the Mini Luer interface are available as well as adapter pins to connect silicone tubing to these chips, which increases the versatility of the various Mini Luer platforms.

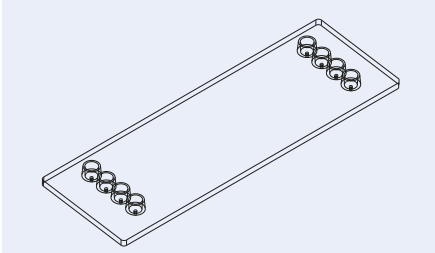

Fig. 713: Microscopy slide Mini Luer platform – version with eight fluidic interfaces

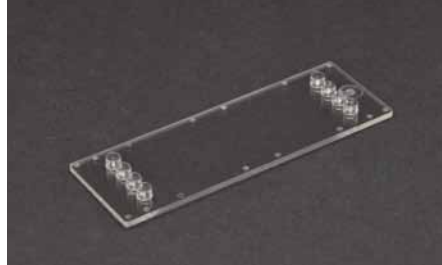

Fig. 714: Microscopy slide Mini Luer platform – version with eight fluidic interfaces

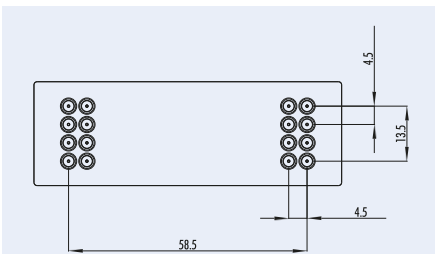

Fig. 715: Microscopy slide Mini Luer platform – version with 16 fluidic interfaces on the short edges

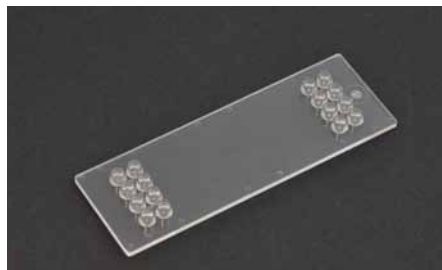

Fig. 716: Microscopy slide Mini Luer platform – version with 16 fluidic interfaces on the short edges

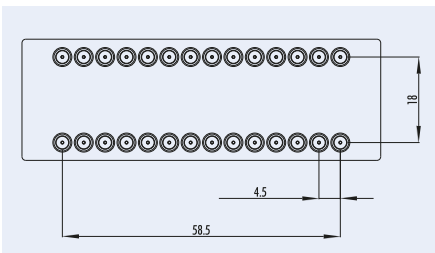

Fig. 717: Microscopy slide Mini Luer platform – version with 28 fluidic interfaces on the long edges



Fig. 718: Microscopy slide Mini Luer platform – version with 28 fluidic interfaces on the long edges

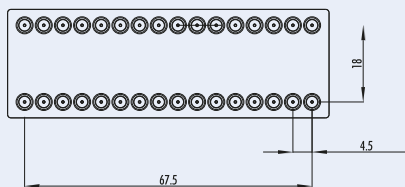

Fig. 719: Microscopy slide Mini Luer platform – version with 32 fluidic interfaces on the short edges

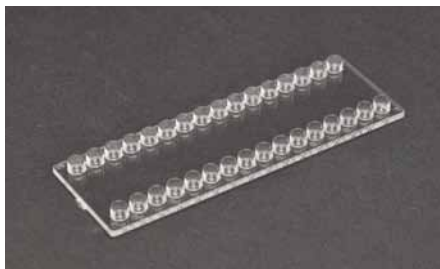

Fig. 720: Microscopy slide Mini Luer platform – version with 32 fluidic interfaces on the long edges

Product Code	Description	Material	Price [€]	
			1+	10+
10000394	Microscopy slide platform 2 x 4 Mini Luer, pack of 10 slides	PMMA	55.00	30.00
10000488	Microscopy slide platform 2 x 4 Mini Luer, pack of 10 slides	PC	55.00	30.00
10000489	Microscopy slide platform 2 x 4 Mini Luer, pack of 10 slides	Topas	55.00	30.00
10000450	Microscopy slide platform 2 x 4 Mini Luer, pack of 10 slides	Zeonor	55.00	30.00
10000424	Microscopy slide platform 2 x 8 Mini Luer, pack of 10 slides	PMMA	55.00	30.00
10000490	Microscopy slide platform 2 x 8 Mini Luer, pack of 10 slides	PC	55.00	30.00
10000491	Microscopy slide platform 2 x 8 Mini Luer, pack of 10 slides	Topas	55.00	30.00
10000492	Microscopy slide platform 2 x 8 Mini Luer, pack of 10 slides	Zeonor	55.00	30.00
10000426	Microscopy slide platform 2 x 14 Mini Luer, pack of 10 slides	PMMA	55.00	30.00
10000427	Microscopy slide platform 2 x 14 Mini Luer, pack of 10 slides	PC	55.00	30.00
10000493	Microscopy slide platform 2 x 14 Mini Luer, pack of 10 slides	Topas	55.00	30.00
10000428	Microscopy slide platform 2 x 14 Mini Luer, pack of 10 slides	Zeonor	55.00	30.00
10000494	Microscopy slide platform 2 x 16 Mini Luer, pack of 10 slides	PMMA	55.00	30.00
10000423	Microscopy slide platform 2 x 16 Mini Luer, pack of 10 slides	PC	55.00	30.00
10000387	Microscopy slide platform 2 x 16 Mini Luer, pack of 10 slides	Topas	55.00	30.00
10000495	Microscopy slide platform 2 x 16 Mini Luer, pack of 10 slides	Zeonor	55.00	30.00

### 16.3.2 Double slide format (75.5 mm x 50 mm x 2 mm)

The double slide format is an in-between solution of small microscopy slide and the microtiter plate. We offer two versions of this platform, either equipped with two double rows of 10 Mini Luer interfaces or two rows with six Luer interfaces each side in total. These designs allow for a large variety of fluidic interconnects in the development phase.

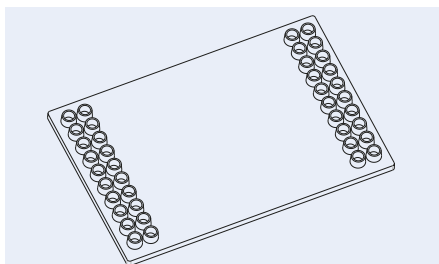

Fig. 721: Schematic drawing of double slide format - Fluidic 508

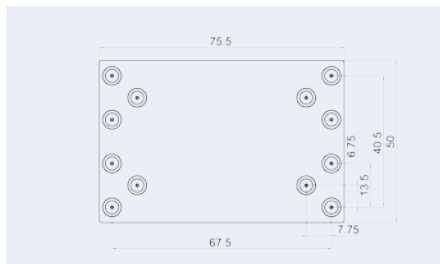

Fig. 722: Schematic drawing of double slide format - Fluidic 948 with 12 Luer interfaces



Product Code	Fluidic	Description	Material	Price [€]	
				1+	10+
10000503	508	Double slide platform 40 Mini Luer interfaces, pack of 10 substrates	PMMA	76.00	44.50
10000504	508	Double slide platform 40 Mini Luer interfaces, pack of 10 substrates	Topas	76.00	44.50
10000505	508	Double slide platform 40 Mini Luer interfaces, pack of 10 substrates	PC	76.00	44.50
10000506	508	Double slide platform 40 Mini Luer interfaces, pack of 10 substrates	Zeonor	76.00	44.50
10001311	948	Double slide platform 12 Luer interfaces, pack of 10 substrates	PMMA	76.00	44.50
10001312	948	Double slide platform 12 Luer interfaces, pack of 10 substrates	Topas	76.00	44.50
10001313	948	Double slide platform 12 Luer interfaces, pack of 10 substrates	PC	76.00	44.50
10001314	948	Double slide platform 12 Luer interfaces, pack of 10 substrates	Zeonor	76.00	44.50

### 16.3.3 Microtiter plate format

The combination of the microfluidic world with its advantages with the well-known world of laboratory automation is the merger of microfluidics with the SBS standard microtiter plate (85.48 mm x 127.76 mm). Directly available from *microfluidic ChipShop* are several injection-molding tools to allow for the fabrication of microfluidic networks on the microtiter plate, ensuring the outer rim of the SBS pattern also fits with existing automation set-ups. Taking laboratory automation into consideration during the design phase, namely by incorporating fluidic interfaces and optical detection areas according to the well spacing of the microtiter plates, allows the use of, for example, pipetting robots or conventional plate readers for optical detection.

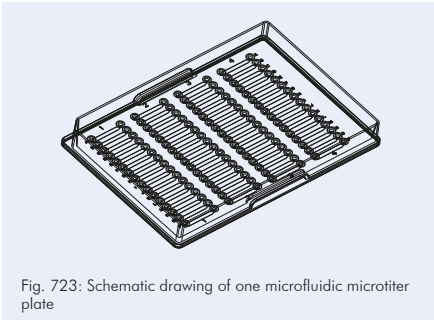

Fig. 723: Schematic drawing of one microfluidic microtiter plate

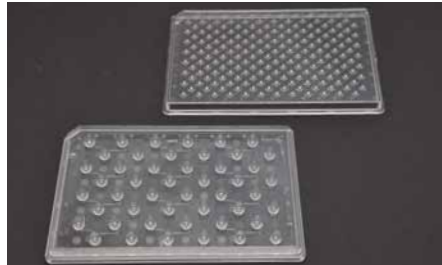

Fig. 724: Example of one of *microfluidic ChipShop*'s microfluidic microtiter plates

### 16.3.4 1/4 Microtiter-plate format

For those applications which do not require the full size of a microtiter plate, a variation with a footprint of one-quarter of the titerplate is also available. This is particularly relevant for instruments with tighter size restrictions.

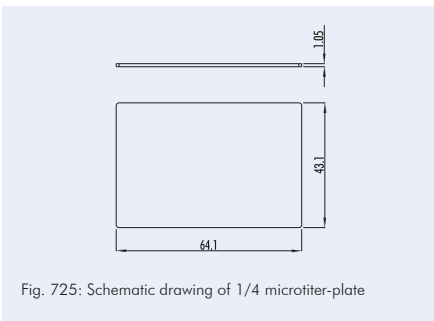

Fig. 725: Schematic drawing of 1/4 microtiter-plate

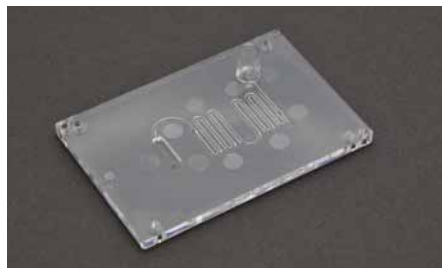

Fig. 726: Example for 1/4 microtiter-plate, realized within EU-FP7 project "CD-Medics", No. 216031. Design: IMM



### 16.3.5 Extended size I platform format

This platform is for those who require chips in a long and narrow format (95 mm x 16 mm). Microstructured examples in this chip format are our electrophoresis chips. The platform is available with through-holes as well as with Luer connectors.



Fig. 727: Schematic drawing of the extended size I platform with simple through-holes

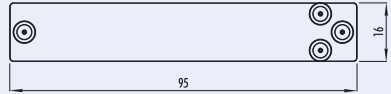

Fig. 728: Schematic drawing of the extended size I platform with Luer interfaces

### 16.3.6 CD-format

For applications making use of liquid transport by centrifugal forces, a CD-sized tool is available. Please note that for this format, the central hole with a diameter of 15 mm is required plus the CD clamping region with diameter of 25 mm centered around the hole which cannot be used for structuring. Only open-hole fluidic access is possible in this format.

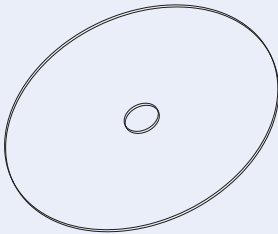

Fig. 729: Schematic drawing of the CD-platform

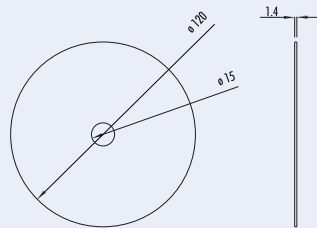

Fig. 730: CD-platform with measures

### 16.3.7 Pie-slice plate

A variation of the centrifugal platform is the pie-slice plate. This is a 60-degree sector of a circle and allows the modular assembly of different functions in different sectors of a disc. This format allows for higher fluidic volume applications than the CD format as it has a maximum thickness of 4 mm.

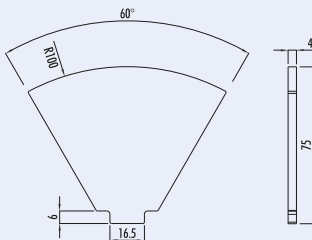

Fig. 731: Geometrical layout of the pie slice plate



Fig. 732: Examples of pie slice plate chips.  
The chips were developed within the BMBF-Project "ZentriLab", FKZ 16SV2350.





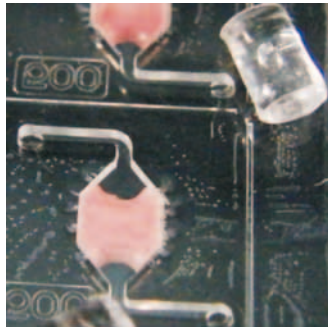
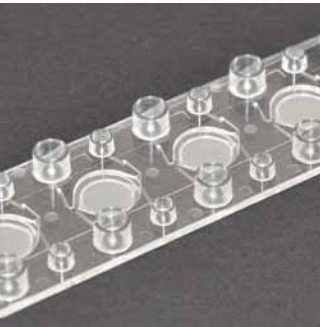

## 17 Finally – Some examples

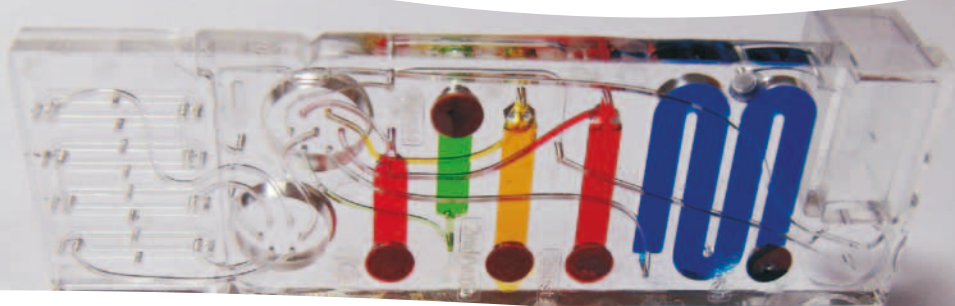

### Examples

Hopefully you were delighted by our *Lab-on-a-Chip Catalogue* and we were either able to serve you with standard microfluidic chips or we could provide you with a roadmap to your custom-made design. Finally, we would like to round up our *Lab-on-a-Chip Catalogue* with some examples of fluidic chips that might be an inspiration to you and also provide a good impression of our technological capabilities.



Fig. 733: Diagnostic platform with Luer connectors

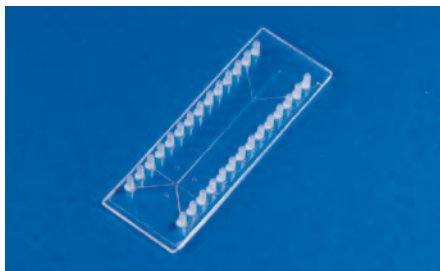

Fig. 734: Cell sorting chip

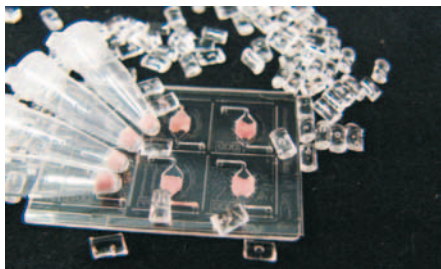

Fig. 735: PCR chip with integrated freeze-dried master mix

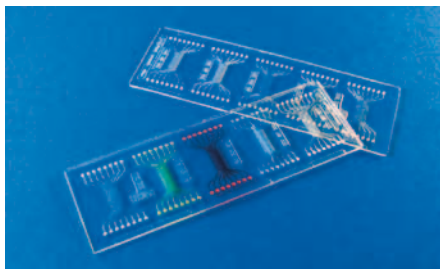

Fig. 736: Channel-array chip



Fig. 737: Hybrid chip consisting of polymer and filters for plasma generation



Fig. 738: Continuous-flow PCR chip, chip, realized within the BMBF-Project "ChipFlussPCR", FKZ 13N9556



Fig. 739: Hybrid chip for immunoassays with electrochemical detection, realized within the EU-FP6 project "SmartHEALTH", No. 016817

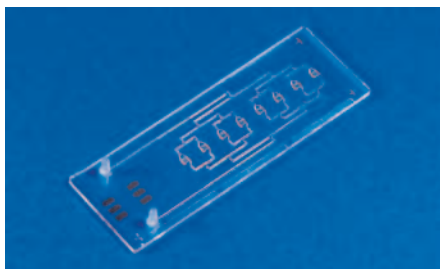

Fig. 740: Cell culture chips with integrated thin film electrodes, realized within the BMBF-Project "HepaChip", FKZ 01GG0728

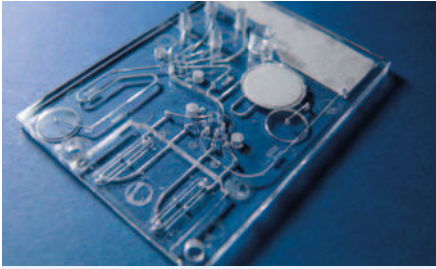

Fig. 741: Hybrid chip for immunoassays with plasma generation unit for electrochemical detection, realized within EU-FP6 project "SmartHEALTH", No. 016817

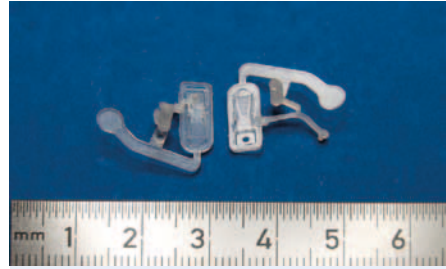

Fig. 742: Two component microinjection molding – Device for agglutination based assays, realized within the BMBF project FASAMOS, FKZ 02PC2001

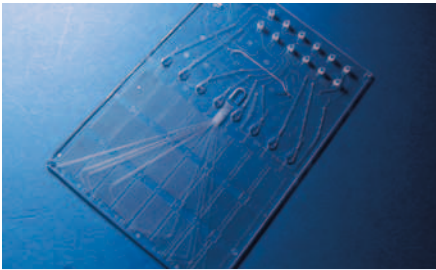

Fig. 743: Sample-in-result-out DNA-analysis chip, realized within the BMBF project ChipFlussPCR, FKZ 13N9556

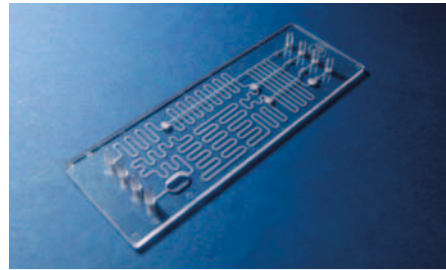

Fig. 744: Microfluidic chip for a complete SELEX-cycle, realized within the ETB project Artamis, FKZ 03139428

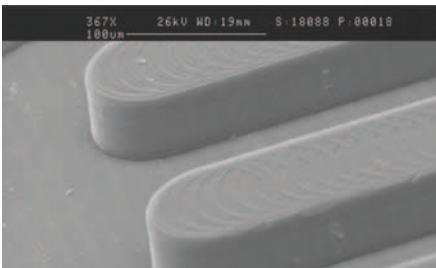

Fig. 745: Microchannel with nanostructured channel floor. The nanostructures have a  $1.2\ \mu\text{m}$  period and  $200\ \text{nm}$  height

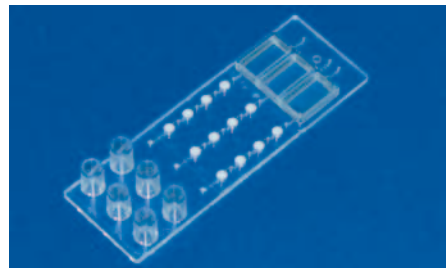

Fig. 746: Microfluidic chip for immunoassay applications with reagent reservoirs and antibody-coated frits for three assays, realized within the BMBF project IFSA, FKZ 16SV5417



Fig. 747: Sample-in-result-out DNA-analysis chip with hybridisation zone for optoelectronic read-out, realized within the project Pathold Chip, A-102-RT-GC



Fig. 748: Microfluidic chip coupled to conventional (top) and flex (bottom) PCBs, realized within the BMBF-project "Safels", FKZ 0315574C



Fig. 749: Filtration chip with liquid reservoir



Fig. 750: Fluidic chip with rotary valve



Fig. 751: Extended size electrophoresis chip for sequencing



Fig. 752: Immunoassay chip with plasma generation unit and blister pouches

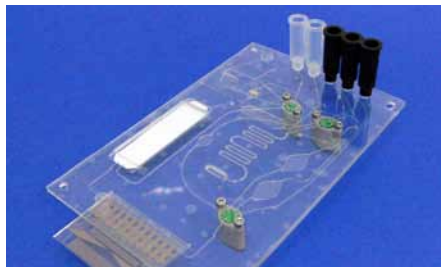

Fig. 753: HLA typing chip for the detection of coeliac disease, realized within the FP 7 project "CD-Medics", No. 216031



Fig. 754: Serology test chip for the detection of coeliac disease, realized within the FP 7 project "CD-Medics", No.216031



Fig. 755: Boyle-Mariotte PCR chip for ultrafast PCR, design: IMM, realized within the FP 7 project "CD-Medics", No. 216031



Fig. 756: Enzyme-assay development chip, realized within the FP 7 project Multisense Chip, No. 261810

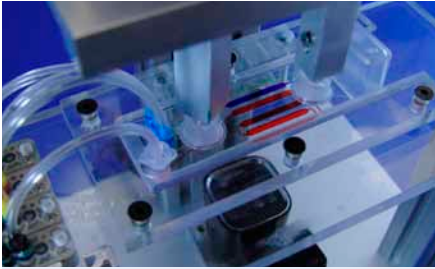

Fig. 757: Enzyme-assay development chip in bread board instrument, realized within FP 7 project Multisense Chip, No. 261810



Fig. 758: Microfluidic chip with lateral flow strip based detection and implemented blister for liquid storage

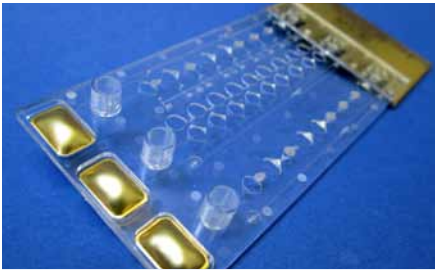

Fig. 759: PCR cartridge with TMR-sensor-based read-out , BMBF projekt MiniLab, No. 16SV4029

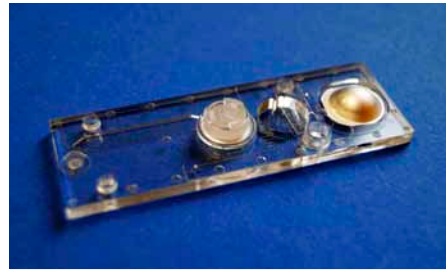

Fig. 760: Particle counting chip with integrated turning valve and staining solution, TAB project No. 2009 FE 0134

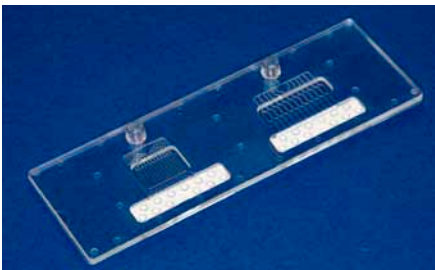

Fig. 761: Parallel PCR chip, FP 7 project Multisense Chip, No. 261810

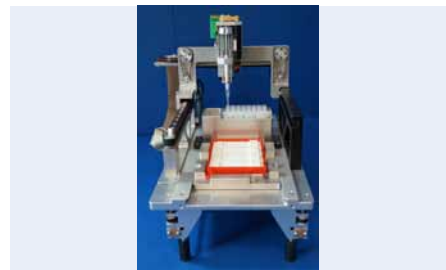

Fig. 762: Merger of standard liquid handling and lab-on-a-chip technology – LOC pipettor & xy-stage for optical read out, TAB project No. 2011 FE 9023



Fig. 763: Chip cuvette for frit-based immunoassays, realized within the BMBF project IFSA, FKZ 16SV5417



Fig. 764: Microfluidic chip realized for CARE-MAN - Health-CARE by biosensor Measurement and Networking, FP 6, NMP4-CT-2006-017333

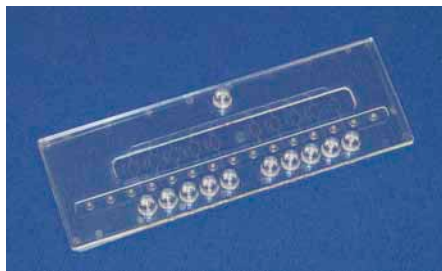

Fig. 765: One sample – 10 reactions: 0.5  $\mu$ l volume PCR chip, FP7 project Multisense Chip, No. 261810

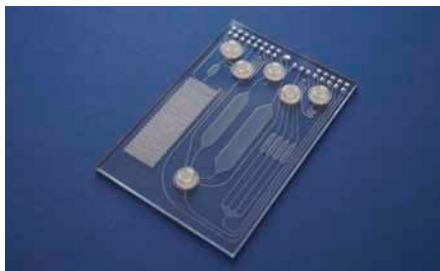

Fig. 766: Integrated microfluidic chip for continuous-flow PCR and parallel immunoassay, FP7 project Multisense Chip, No. 261810



Fig. 767: Breadboard system: Electrochemical immunoassay system for air sample analysis, FP7 project Multisense Chip, No. 261810

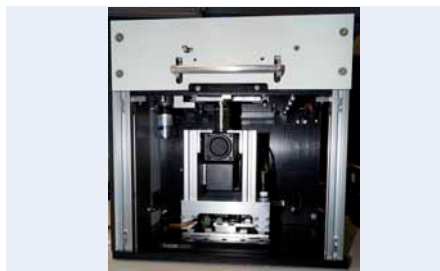

Fig. 768: Breadboard system: Lab-on-a-Chip instrument for optical read-out of immunoassays, TAB project LabChipLO

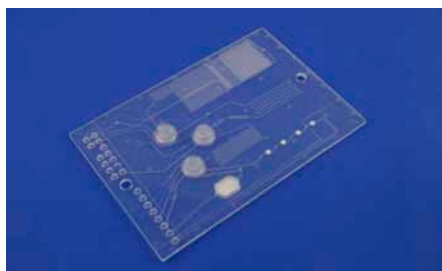

Fig. 769: Integrated microfluidic chip for the detection of bacterial pathogen on molecular and immunological level, FP7 project Multisense Chip, No. 261810

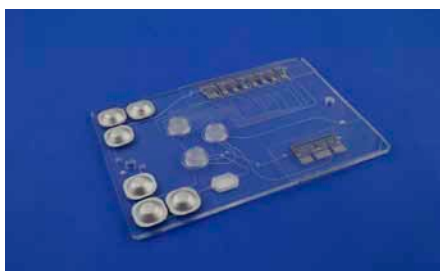

Fig. 770: Integrated microfluidic chip for the detection of bacterial pathogen on molecular and immunological level with integrated electrodes, FP7 project Multisense Chip, No. 261810



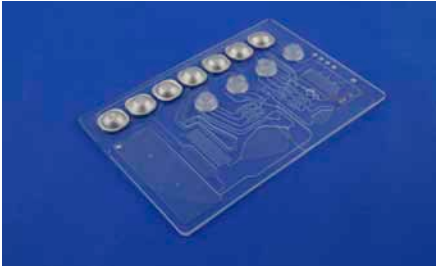

Fig. 771: Integrated microfluidic chip with complete sample preparation for miRNA analysis, BMBF project IMRA, FKZ 0316078A



Fig. 772: Selective cell counting chip for hematology, BMBF project MrCyte, FKZ 13N12018



Fig. 773: Miniaturized spectrometer module, ChipGenie Optic TAB project 2013 FE 9021

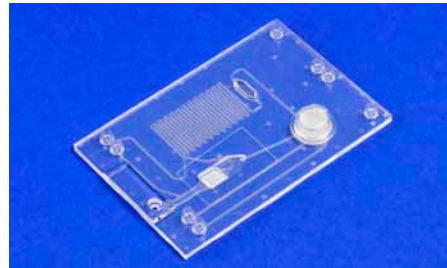

Fig. 774: Cartridge for CTC isolation and lysis. Realized within the EU-FP7 project „CanDo“, project number: 610472

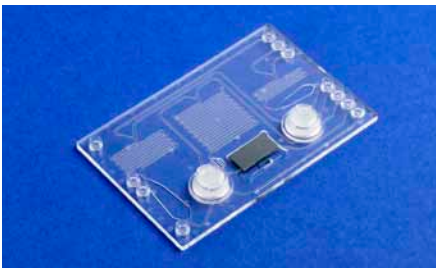

Fig. 775: Integrated cartridge for DNA amplification and subsequent detection using a silicone photonic sensor. Realized within the EU-FP7 project „CanDo“, project number: 610472

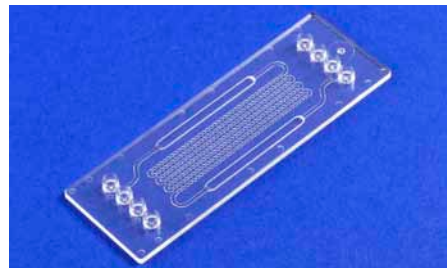

Fig. 776: Pearl chain mixer module. Realized within the EU-FP7 project „Nanodem“, Grant Agreement number: 318372



Fig. 777: Integrated microfluidic chip for the detection of bacterial pathogens, FP7 project Multisense Chip, No. 261810



Fig. 778: Multisense Chip Analyzer: Demonstration of detection of airborne bacterial pathogens, FP7 project Multisense Chip, No. 261810



Fig. 779: Integrated microfluidic chip for the detection of viral pathogens in the food supply chain, FP7 project EDEN, No. 313077



Fig. 780: Analyzer for molecular detection of viral pathogens in the food supply chain, FP7 project EDEN, No. 313077



Fig. 781: Organ-on-chip device operated with hydrostatic fluid management, BMBF project HepaChip, FKZ 031A121D

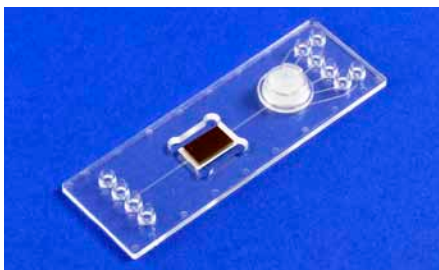

Fig. 782: Flow cell chip for sensor integration Realized within the BMBF project "Plasmosens", FKZ: 13N13734



Fig. 783: Immunoassay-Chip, BMBF-Project HandyLoC, FKZ 13N13714



Fig. 784: Immunoassay-Chip for mycotoxine analysis, BMBF-Project Kombispec, FKZ 13N13757



Fig. 785: Real-time PCR chip for B-agent detection, Horizon 2020 project, No. 700264

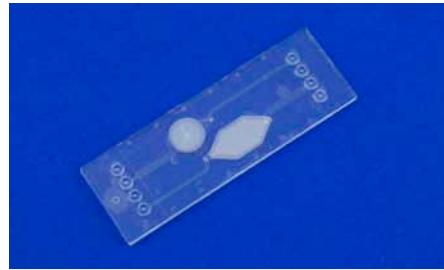

Fig. 786: Plasma generation chip, BMBF project Hämatom, FKZ 13GW01128



Fig. 787: Transwell membrane chip Fluidic 219 with tank Fluidic 234 as fluid reservoir, TAB project number 2013 FE 9021



Fig. 788: Transwell membrane chip Fluidic 219 with tank Fluidic 235 as fluid reservoir, TAB project number 2013 FE 9021



Fig. 789: Photonic biosensing chip for microRNA-based early diagnosis of diseases - Fluidic 866 Horizon 2020 project, Grant agreement no: 644242

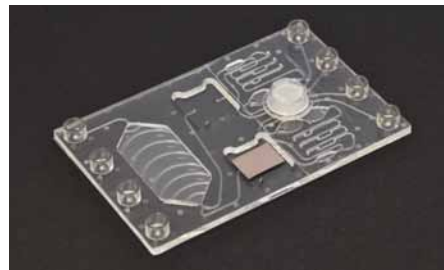
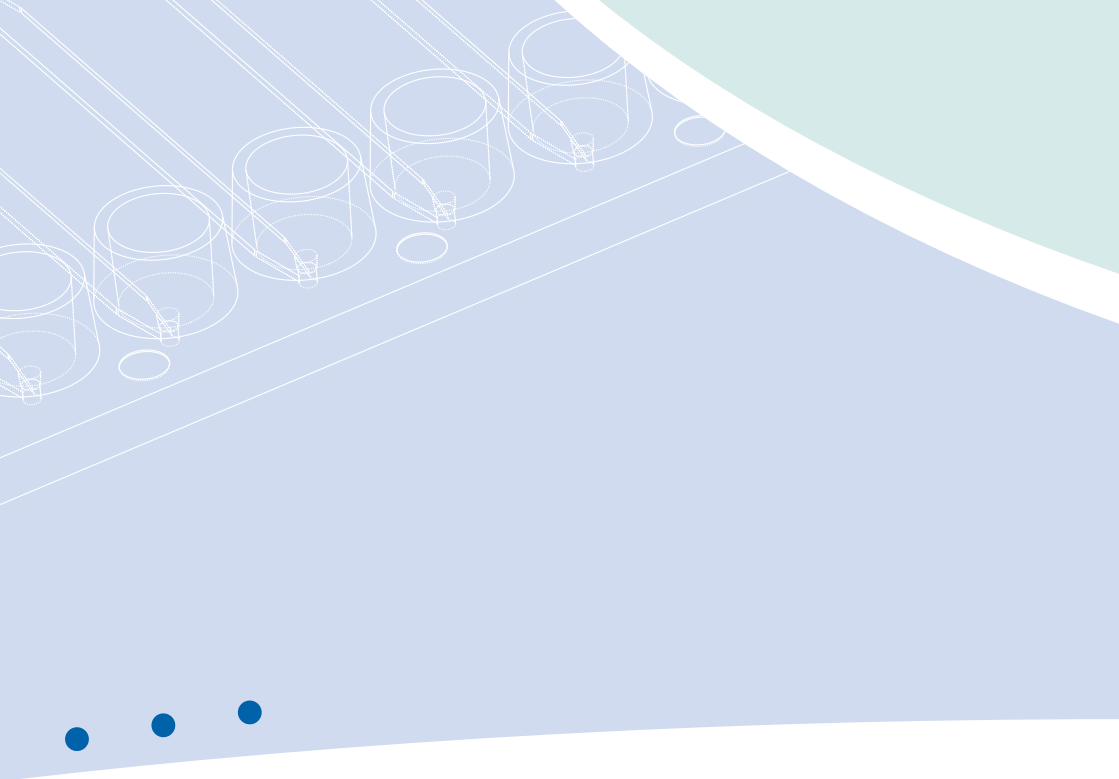

Fig. 790: Multifunctional sensor platform, BMBF Project Plasmosens, FKZ 13N13734

## Disclaimer

Whilst we endeavour to ensure that the information in this catalogue is correct, *microfluidic ChipShop* reserves the right not to be responsible for the correctness, completeness or quality of the information provided. Liability claims regarding damage caused by the use of any information provided, including any kind of information which is incomplete or incorrect, will therefore be rejected. All offers are not-binding and without obligation. Parts of the pages or the complete publication including all offers and information might be extended, changed or partly or completely deleted by *microfluidic ChipShop* without separate announcement.

All products and services offered within this catalogue are intended for R&D use only.



## 18 One for all – A universal diagnostic platform



### **One for all – A partnership with Stratos Product Development for the Bill & Melinda Gates foundation**

“One for all” summarizes the question Bill Gates posed in a recent blog: „Can you create a new device that quickly diagnoses HIV, TB, malaria, and other diseases... accepts different samples, like blood, saliva, and sputum... is affordable... and reliable... and will work in a small clinic that has only a few hours of electricity a day?”



### 18 One for all – A universal diagnostic platform

Delivering a universal point-of-care diagnostic platform allowing for molecular, immunological and clinical chemistry assays in combination with handling of different sample matrices like sputum, plasma, urine etc. is the overall goal of *microfluidic ChipShop's* ChipGenie® edition Dx series.

One of the trigger for this platform was the PanDx project carried out for the Bill & Melinda Gates Foundation.

#### 18.1 One for all – A partnership with Stratos Product Development for the Bill & Melinda Gates foundation

##### Lab-on-a-Chip solutions – Enabling elements for a complete diagnostics platform for health centers in the developing world

A universal diagnostic platform for all different kinds of bioanalytical assays coping with all relevant samples in human diagnostic was the overall goal of the PanDx project.

Within the Grand Challenges in the Global Health initiative of the Bill & Melinda Gates Foundation, Stratos Product Development took care of the development of the instrument platform and partnered with *microfluidic ChipShop* for the lab-on-a-chip and assay development.

Within an 18-month time frame making massive use of *microfluidic ChipShop's* microfluidic toolbox concept to speed up assay development, a fully working breadboard instrument capable of all three assay types was realized by Stratos, complemented by *microfluidic ChipShop's* work delivering three fully integrated cartridges combined with the development and implementation of three different assay types on chip, namely:

1. A tuberculosis assay working on the molecular level.
2. An HIV p24 antigen immunoassay for the early detection of an infection.
3. A clinical chemistry assay for analyzing the liver function through a colorimetric read-out of the ALT level.

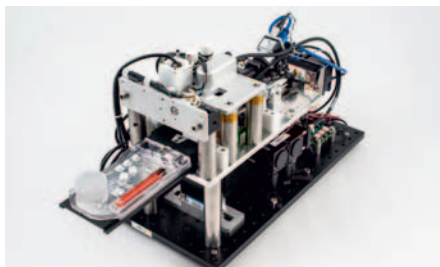

Fig. 791: Stratos breadboard unit – operating molecular, immunological and clinical chemistry assays

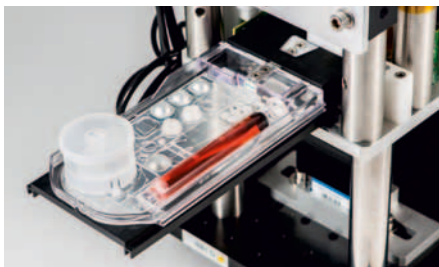

Fig. 792: *microfluidic ChipShop's* tuberculosis cartridge placed in the chip loader

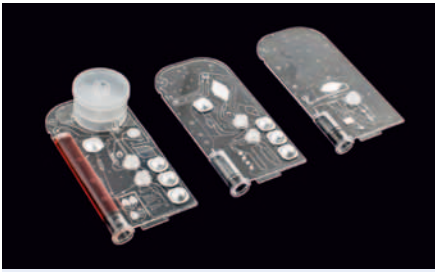

Fig. 793: Cartridges for the detection of tuberculosis, early HIV infection, and liver function (from left to right)

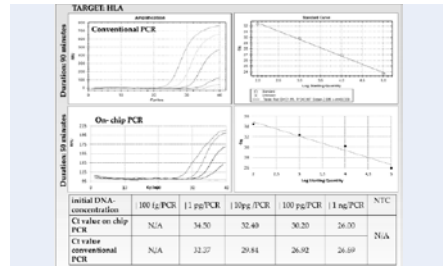

Fig. 794: Experimental results of a HLA-real-time PCR performed on chip and in a conventional RT-PCR instrument (Biorad CFX96TM) - Gärtner, Claudia, et al. „Lab-on-a-chip enabled HLA diagnostic: combined sample preparation and real time PCR for HLA-B57 diagnosis.“ SPIE Sensing Technology+ Applications. International Society for Optics and Photonics, 2015.

microfluidic ChipShop's cartridges are fully equipped with all reagents. The only remaining task for the user is the sample input followed by placement of the cartridge in the Stratos instrument, which takes over the complete assay handling and read-out.

The pictures highlight the three fully working cartridges as well as the breadboard instrument.

Besides the microfluidic chip design and fabrication, *microfluidic ChipShop* covered also the complete assay development making use of its wide service portfolio beyond the microfabrication. The related fabrication tasks include injection molding and assembly, dry and liquid reagent storage and lyophilization, biological reagent formulation, surface tuning, membrane and frit integration, and valve implementation, leading to a fully integrated cartridge as a complete lab-on-a-chip device, demonstrating the potential of the system.

## 18.2 In continuation – The ChipGenie® edition Dx series – The universal diagnostic platform

The ChipGenie® edition Dx platform is an integrated system covering the detection and identification of biological pathogens in a bleed-to-read fashion. Realized as lab-on-a-chip system, a consumable cartridge – the lab-on-a-chip – and the respective instrument constitute the ChipGenie® edition Dx system, leaving only the sample introduction as a hands-on-action to the user.

ChipGenie® edition Dx – Starting point for customization

According to specific needs, the platform will be customized:

The instrument will be equipped with the detection/sensor technology of choice and the chip will be designed for the respective assay panel, target samples and user-scenarios.



Fig. 795: ChipGenie® edition Dx instrument



Fig. 796: ChipGenie® edition Dx cartridge – molecular assay



### The consumable – the Lab-on-a-Chip

The assay-specific consumable cartridge defines all system operations. In order to allow for a minimization of hands-on activities and a fully automated processing of all diagnostic assay steps, the consumable is a fully equipped lab: All reagents are integrated on the device either in a dry or liquid form. Sample preparation modules are included and on-board valves and pumps enable a complete operation of the device by the ChipGenie® edition Dx instrument.

### Assay categories – Cartridge family

The platform is designed to allow for molecular, immunological, cell-based and clinical chemistry assays. These different assay categories and their varying sample preparation methods and assay steps require dedicated lab-on-a-chip devices. For example, cartridges for immunoassays may include a plasma generation unit, chips for molecular assays a DNA extraction unit or a reverse transcription, whereas cell-based assays can include concentration modules.

An expanding cartridge family will address more and more different diagnostic tasks, being designed according to the design rules of the ChipGenie® edition Dx platform concept in order to be operated with a common instrument platform.

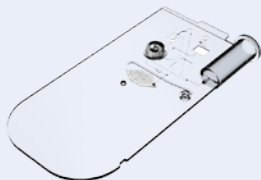

Fig. 797: ChipGenie® Dx cartridge – clinical chemistry assay



Fig. 798: ChipGenie® Dx cartridge – immunoassay



Fig. 799: ChipGenie® Dx cartridge – molecular assay (DNA-based)





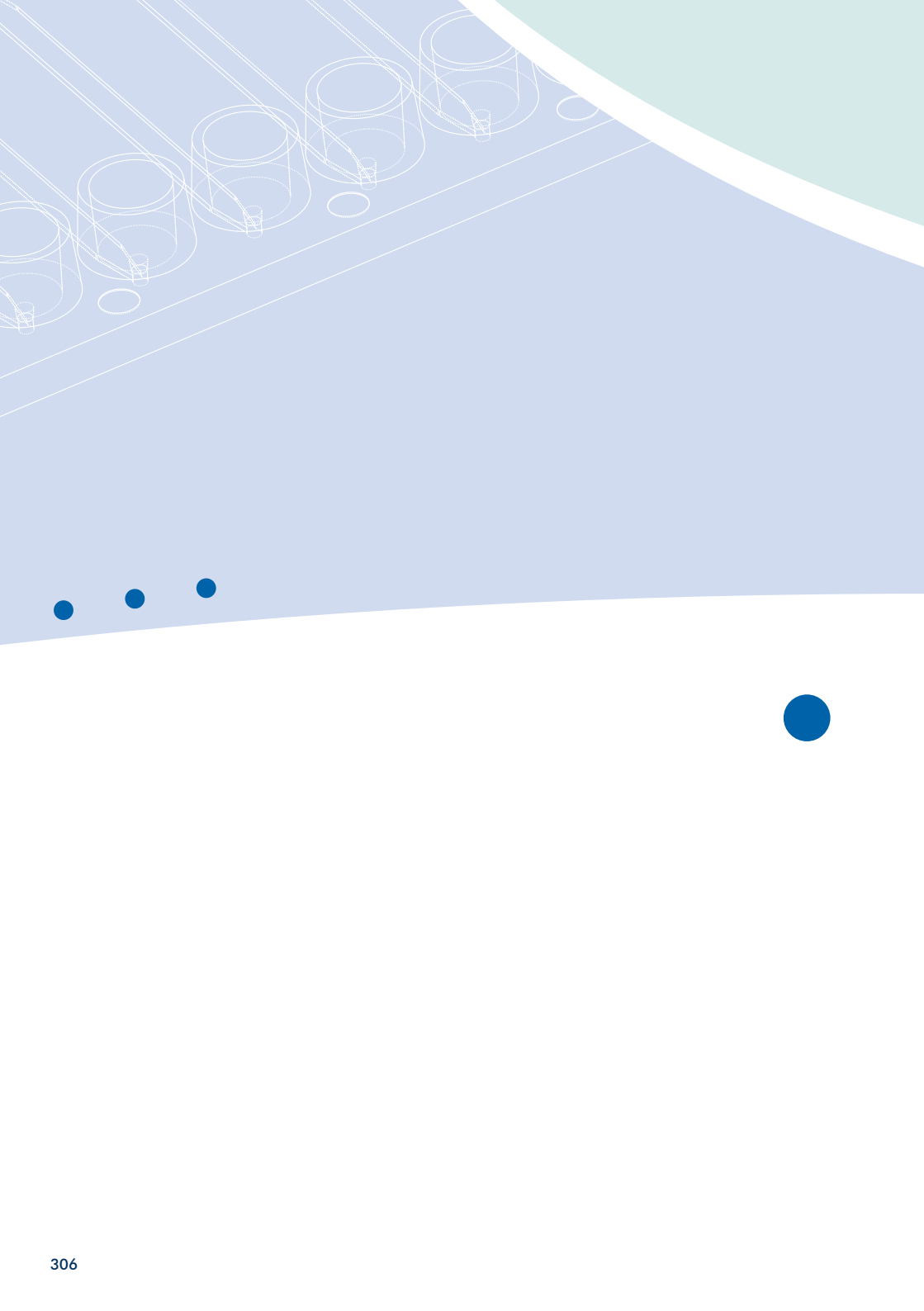

# 19 Literature





## 19 Publications

## 19.1 microfluidic ChipShop's publications - List of selected publications from recent years.

## 19.1.1 Journal and book publications

1. Sandetskaya N., et al., An integrated homogeneous SPARCL™ immunoassay for rapid biomarker detection on a chip, *Anal. Methods*, 19, 2542-2550, 2019.
2. Martens D., et al., A low-cost integrated biosensing platform based on SiN nanophotonics for biomarker detection in urine, *Analytical methods*, 10 (25), 3066-3073, 2018
3. Ramirez-Priego P, et al., Label-Free and Real-Time Detection of Tuberculosis in Human Urine Samples Using a Nanophotonic Point-of-Care Platform, *ACS sensors*, 3 (10), 2079-2086, 2018
4. Sandetskaya N., et al., An integrated versatile lab-on-a-chip platform for the isolation and nucleic acid-based detection of pathogens, *Future Sci. OA* 3(2), FSO177, 2017
5. Theobald J., et al., Monitoring cytochrome P450 activity in living hepatocytes by chromogenic substrates in response to drug treatment or during cell maturation, *Arch.Toxicol.*, 1-17, 2017
6. Smith S, et al., Microfluidic Cartridges for Automated, Point-of-Care Blood Cell Counting, *SLAS TECHNOLOGY*, 22(2), 176-185, 2017.
7. Theobald J., et al., Liver-Kidney-on-Chip To Study Toxicity of Drug Metabolites, *ACS Biomater. Sci. Eng.*, DOI: 10.1021/acsbiomaterials.7b00417, 2017.
8. Beer M., et al., A novel microfluidic 3D platform for culturing pancreatic ductal adenocarcinoma cells: comparison with in vitro cultures and in vivo xenografts, *Sci Rep.*, 7, 1325, 2017.
9. Becker H., Gärtner C., Microfluidics-Enabled Diagnostic Systems: Markets, Challenges, and Examples, in: Taly, V., Viovy, J.L., Descroix, S. (Eds.), *Microchip Diagnostics: Methods and Protocols*, Springer, 3-21, 2017.
10. Marx U., et al., Biology-inspired microphysiological system approaches to solve the prediction dilemma of substance testing. *Altex*, 33(3), 272-321, 2016.
11. Raasch M., et al., An integrative microfluidically supported in vitro model of an endothelial barrier combined with cortical spheroids simulates effects of neuroinflammation in neocortex development. *Biomicrofluidics*, 10(4), 044102, 2016.
12. Julich S., et al., Evaluation of a microfluidic chip system for preparation of bacterial DNA from swabs, air, and surface water samples. *Biologicals*, 44(6), 574-580, 2016.
13. Smith S., et al., Blister pouches for effective reagent storage on microfluidic chips for blood cell counting. *Microfluidics Nanofluidics*, 20(12), 163, 2016.
14. Wienhold T., et al., All-polymer photonic sensing platform based on whispering-gallery mode microgoblet lasers. *Lab Chip* 15(18), 3800-3806, 2015.
15. Ortiz M., et al. Bleed-to-read disposable microsystems for the genetic and serological analysis of celiac disease markers with amperometric detection. *Electrophoresis*, 36(16), 1920-1926, 2015.
16. Raasch M., et al., Microfluidically supported biochip design for culture of endothelial cell layers with improved perfusion conditions. *Biofabrication*, 7(1), 015013, 2015.
17. Gottheil R., et al, Moving the solid phase: a platform technology for cartridge based sandwich immunoassays. *Biomedical Microdevices*, 16(1), 163-172, 2014.
18. Becker H., Hansen-Hagge T., Gärtner C., Microfluidic devices for rapid identification and characterization of pathogens, in: Schaudies, R.P (Ed.), *Biological identification: DNA amplification and sequencing, optical sensing, lab-on-chip and portable systems*, Elsevier, 220-250, 2014.

## 19.1.2. Selected Conference Proceedings

1. Schattschneider S., et al., Minimal instrument immunoassay system by cartridge-integrated inkjet-printed optical detection system, *Proc. MicroTAS 2019*, Basel, 2019
2. Schattschneider S., Handy-LOC: a lab-on-a-chip system with integrated ink-jet printed organic semiconductor detection elements, *SPIE Microfluidics, BioMEMS, and Medical Microsystems XVII 10875*, 108750M, 2019
3. Busche M., et al., HepaChip-MWP-An organ-like perfusable cell culture system in multiwell plate format for pre-clinical drug and substance testing, *NAUNYN-SCHMIEDEBERGS ARCHIVES OF PHARMACOLOGY* 392, S80-S80, 2019
4. Becker H., et al., Lab-on-a-chip analyzer for zoonotic pathogens in remotely-controlled robotic air and ground vehicles, *SPIE Microfluidics, BioMEMS, and Medical Microsystems XVI 10491*, 104910L, 2018
5. Becker H., et al., Integration of silicon photonic devices in microfluidic cartridges, *SPIE Microfluidics, BioMEMS, and Medical Microsystems XVI 10491*, 1049108, 2018
6. Becker H., et al., Microfluidic devices for stem-cell cultivation, differentiation and toxicity testing, *Proc. SPIE Vol 10061*, pp. 1006116-1, 2017.
7. Baldini F., et al., Novel fluorescence-based POCT platform for therapeutic drug monitoring in transplanted patients, *Proc. SPIE 10072*, 100720C, 2017.



8. Becker, H., et al., Microfluidic cartridge for LAM-based TB POC-diagnostics using silicon photonics sensor, Proc. MicroTAS 2017.
9. Becker H., et al., Stem-cell derived two-organ model for metabolism-induced toxicity testing, Proc. MicroTAS 2017.
10. Smith S., et al., Blister technology for the storage of liquid reagents in microfluidic devices, Proc. SPIE, Vol. 9705, 97050F, 2016.
11. Freyberg S., et al., Fully integrated microfluidic device for detecting tumor associated miRNA clusters for point-of-care, et al., Universal lab-on-a-chip system for cell counting and cell density measurements in human and veterinary diagnostic applications, Proc. MicroTAS 2016.
12. Becker H., et al., Modular microfluidic cartridge-based universal diagnostic system for global health applications, Proc. SPIE Vol. 9705, 970514, 2016.
13. Gärtner C., et al., Multisense chip: continuously working air monitoring system: An integrated system for the detection of airborne biological pathogens on molecular and immunological level, Proc. SPIE Vol. 9455, 94550B, 2015.
14. Gärtner C., et al., Sensor enhanced microfluidic devices for cell based assays and organs on chip, Proc. SPIE Vol. 9487, 948704, 2015.
15. Gärtner C., et al., Lab-on-a-chip enabled HLA diagnostic: combined sample preparation and real time PCR for HLA-B57 diagnosis, Proc. SPIE Vol. 9490, 94900F, 2015.
16. Becker H., et al., Sample-in answer-out point-of-care cartridge for fast MTB diagnostics as part of a universal diagnostic system for global health applications, Proc. MicroTAS 2015.
17. Kiessling H., et al., A new organ-on-chip platform for physiological relevant in-vitro reproduction of the blood-brain barrier, Proc. MicroTAS 2015.
18. Becker H., et al., Microfluidic system for the identification of bacterial pathogens causing urinary tract infections, Proc. SPIE Vol. 9320, 93200S, 2015.
19. Becker H., et al., Integrated microfluidic system with automatic sampling for permanent molecular and antigen-based detection of CBRNE-related pathogens, Proc. SPIE Vol. 9320, 93200X, 2015.

## 19.2 Publication referring to microfluidic ChipShop's devices – Selected publications

1. Maurer M., et al., A three-dimensional immunocompetent intestine-on-chip model as in vitro platform for functional and microbial interaction studies, *Biomaterials*, doi: 10.1016/j.biomaterials.2019.119396, 2019
2. Lohasz C., et al., Scalable microfluidic platform for flexible configuration of and experiments with microtissue multiorgan models, *SLAS Technol.*, 24, 79-95, 2019.
3. Theobald J., et al., *In vitro* metabolic activation of vitamin D3 by using a multi-compartment microfluidic liver-kidney organ on chip platform, *Sci Rep.*, 9, 4616, 2019.
4. Pein H., et al, Endogenous metabolites of vitamin E limit inflammation by targeting 5-lipoxygenase, *Nat Commun.*, 9(1), 3834, 2018.
5. Lee J.W., et al., Low-cost and facile fabrication of a paper-based capillary electrophoresis microdevice for pathogen detection, *Biosensors Bioelectronics*, 91, 388-392, 2017.
6. Petit A.E., et al., A major secretory defect of tumour-infiltrating T lymphocytes due to galectin impairing LFA-1-mediated synapse completion. *Nature Commun.* 22,7, 12242, 2016.
7. Cheheltani R., et al., Tunable, biodegradable gold nanoparticles as contrast agents for computed tomography and photoacoustic imaging, *Biomaterials*, 102, 87-97, 2016.
8. Strohmeier O, et al., Centrifugal microfluidic platforms: advanced unit operations and applications, *Chem. Soc. Rev.*, 44(17), 6187-6229, 2015.
9. Rinkenauer A.C., et al., Comparison of the uptake of methacrylate-based nanoparticles in static and dynamic in vitro systems as well as in vivo, *J. Controlled Release*, 216, 158-168, 2015.
10. Mitchell K.A., Chua B., Son A., Development of first generation in-situ pathogen detection system (Gen1-IPDS) based on NanoGene assay for near real time *E. coli* O157: H7 detection, *Biosensors Bioelectronics*, 54, 229-236, 2014.
11. Hitzbleck M., Delamarche E., Reagents in microfluidics: an 'in' and 'out' challenge, *Chem. Soc. Rev.*, 42(21), 8494-8516, 2013.
12. Millet L.J., Gillette M.U., New perspectives on neuronal development via microfluidic environments. *Trends Neurosci.*, 35(12), 752-761, 2012.
13. Dixit C.K., et al., Multisubstrate-compatible ELISA procedures for rapid and high-sensitivity immunoassays, *Nature Protocols*, 6(4), 439, 20, 2011.
14. Kurita R., Yabumoto N, Niwa O., Miniaturized one-chip electrochemical sensing device integrated with a dialysis membrane and double thin-layer flow channels for measuring blood samples, *Biosensors Bioelectronics*, 21(8), 1649-1653, 2006.

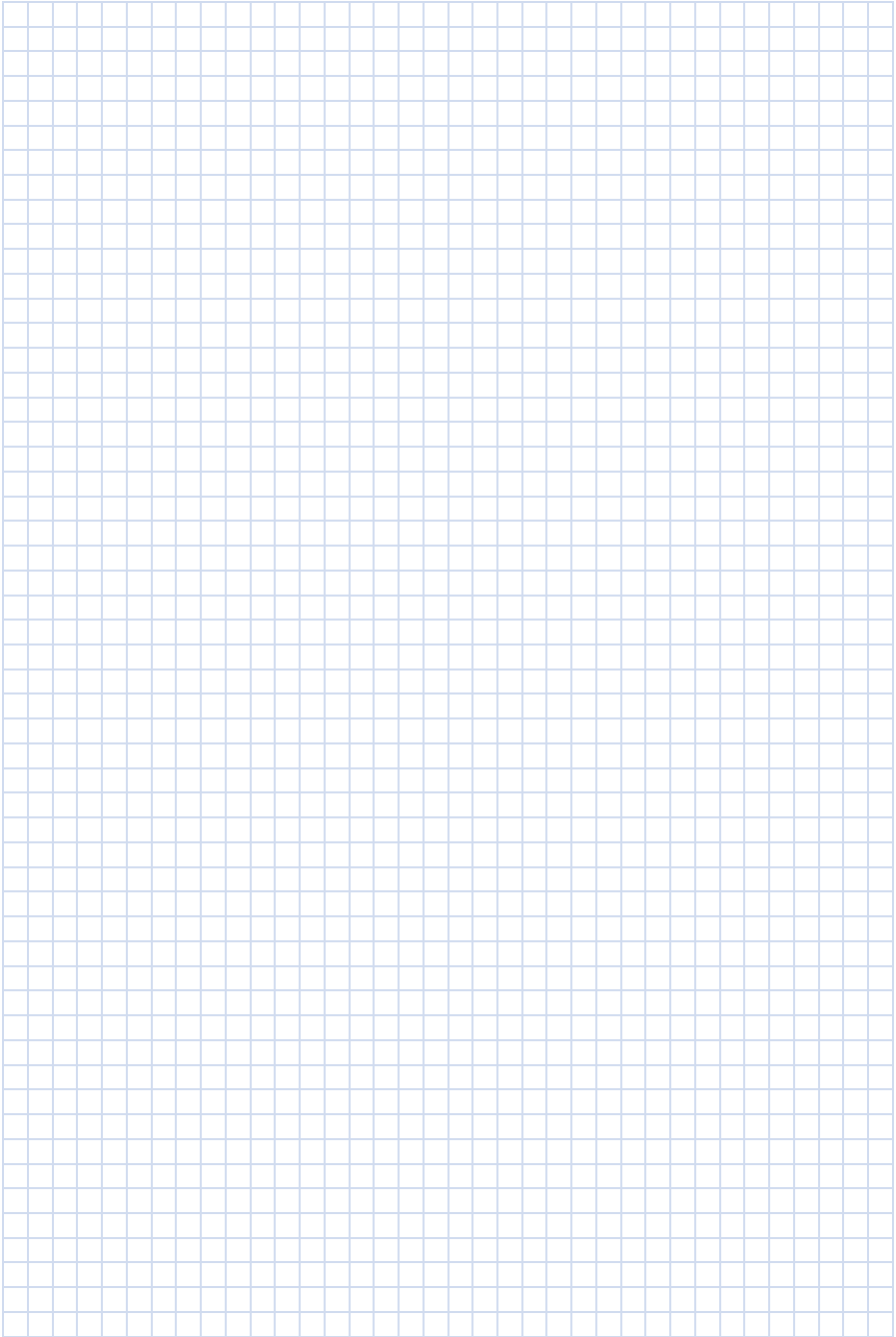

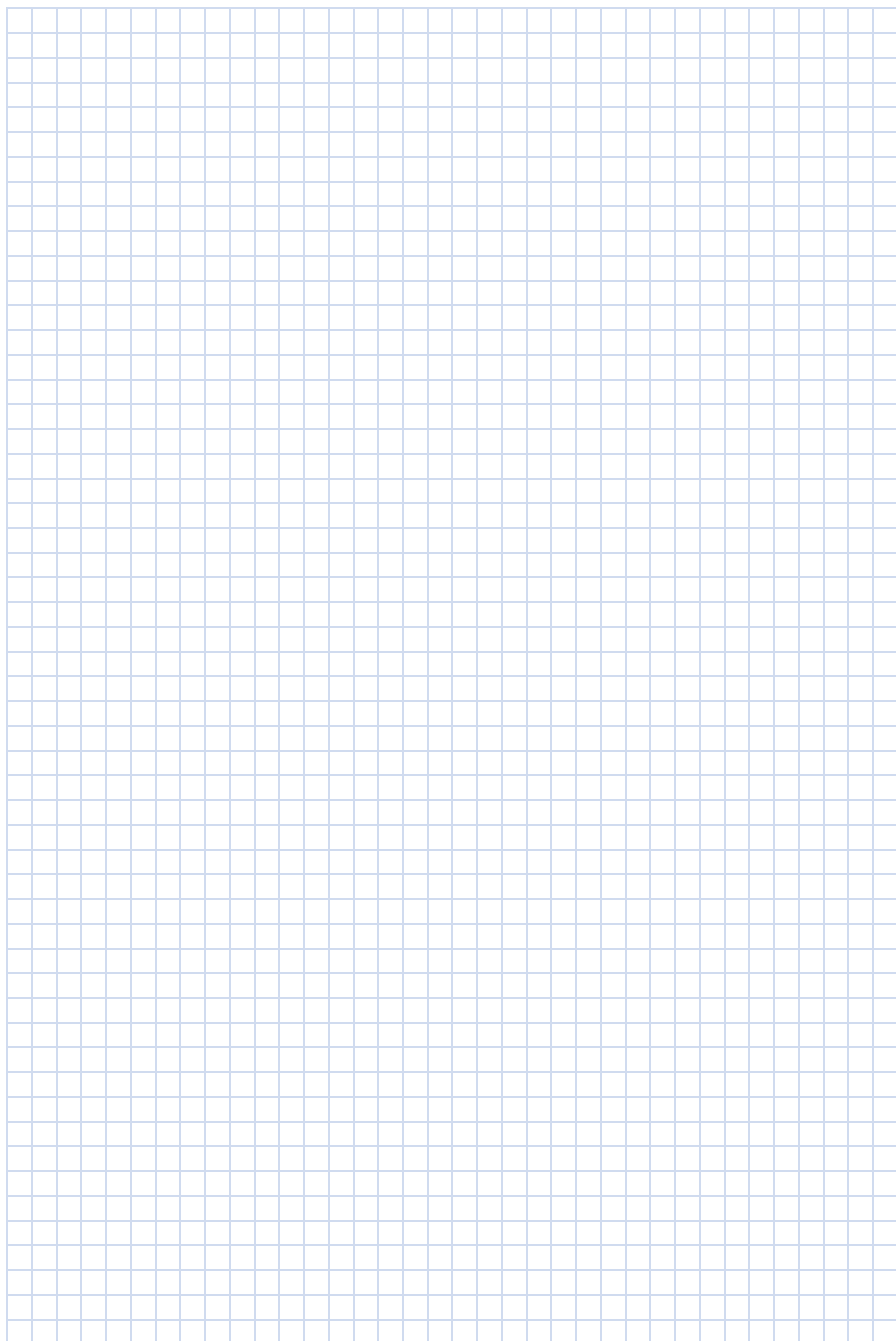

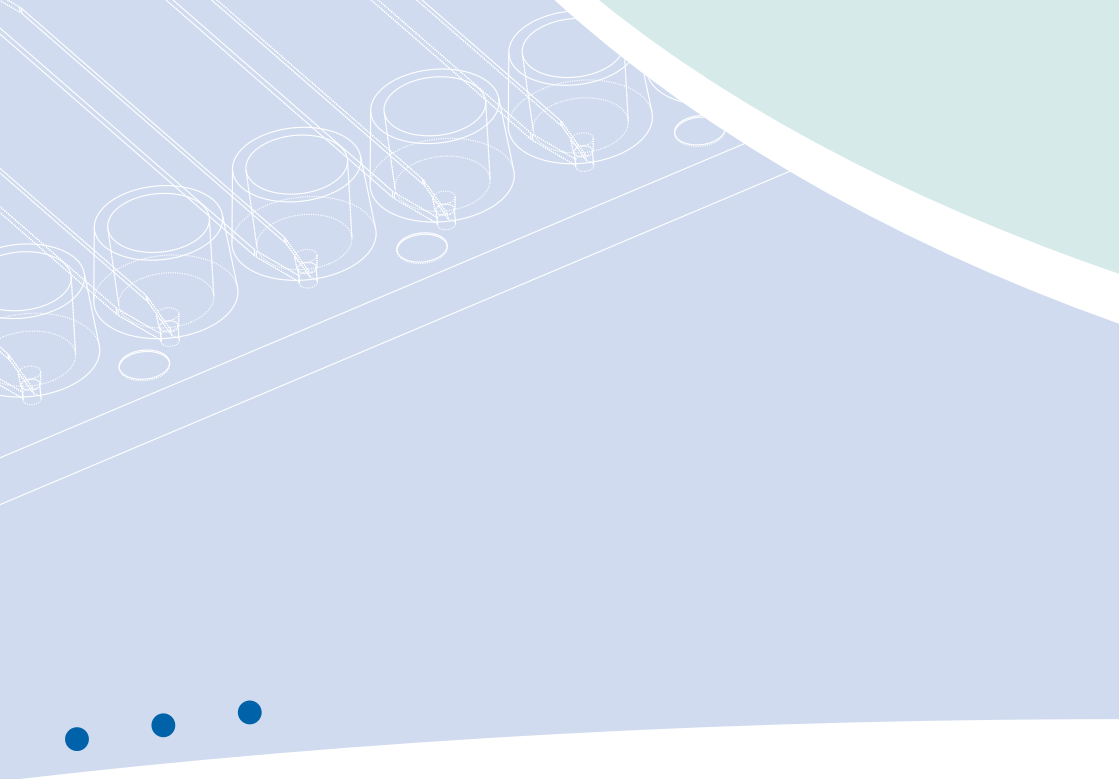



# 20 Order form





**FAX:** + 49 (0) 36 41 347 05 90 • **E-Mail:** sales@microfluidic-chipshop.com  
**Stockholmer Str. 20** • **07747 Jena** • **Germany**

Company Information	
Company:	Department:
Contact Name:	Email:
Shipping Address:	
City, State:	Zip Code: Country:
Phone Number:	Fax Number:
VAT Number (EU only):	Order Number:

Product Number	Product Description	Material	Quantity	Unit Price [€]	Total Price [€]
Total amount without shipping cost and potential minimum quantity surcharge:					*
Minimum quantity surcharge for orders below € 250: € 15.00					
Shipping charges (please choose):					
<input type="checkbox"/> Provide courier account number: <input type="checkbox"/> <i>microfluidic ChipShop</i> prepay and add to invoice (see estimation below**)					
Credit card fee: 3.5% on total invoice amount					
Total amount:					

\* Minimum order volume: € 250 (below this amount we charge a € 15 minimum quantity surcharge)  
 \*\*Estimated shipping charges: Germany: € 15-30 / EU: € 20-60 / RoW: € 60-120

- The prices quoted above are net amounts and do not include packaging, transport, and tax.
- For larger quantities, other materials, or custom designs please ask for a quote.
- Slight variations in the microstructures by +/- 3 – 4 µm may occur.

**You can choose between the following payment options:**

- Payment on account (only for existing customers - verification by microfluidic ChipShop GmbH)
- Payment by credit card (plus 3.5% credit card fee on the order value - for one-time orders or pre-payment)

For Credit Card Payment:	
A credit card fee of 3.5% of the invoice amount applies.	
<input type="checkbox"/> VISA <input type="checkbox"/> MasterCard	Card Number:
Expiration Date (MM/YY):	Security Code:
Name of Cardholder:	
Billing Address:	
City, State:	Zip Code: Country:

Date, name in block letters, signature



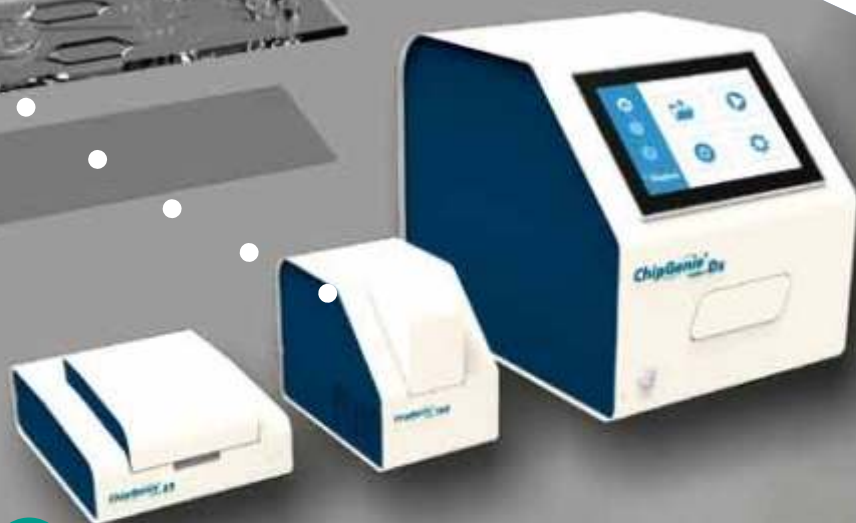

## **microfluidic ChipShop** GmbH

Stockholmer Str. 20  
07747 Jena  
Germany

Phone: + 49 (0) 36 41 - 347 05 0  
Fax: + 49 (0) 36 41 - 347 05 90  
info@microfluidic-ChipShop.com  
[www.microfluidic-ChipShop.com](http://www.microfluidic-ChipShop.com)