

archival storage applications & inspiration



 **GUNNAR** AiOX

materials





GUNNAR AiOX

- matboard
- foamboard
- fluted corrugated board
- solid folding boxboard

- library board
- polypropylene
- coreflute



boxes

Template: F0301a

Length	Width
<input type="text" value="200.00 mm"/>	<input type="text" value="100.00 mm"/>
Height	Distance
<input type="text" value="50.00 mm"/>	<input type="text" value="0.00 mm"/>
Mat Thickness	Radius
<input type="text" value="1.00 mm"/>	<input type="text" value="10.00 mm"/>
Play Top/Bottom	Lobe Length
<input type="text" value="2.00 mm"/>	<input type="text" value="40.00 mm"/>
Corner Size	
<input type="text" value="10.00 mm"/>	

Create Cancel

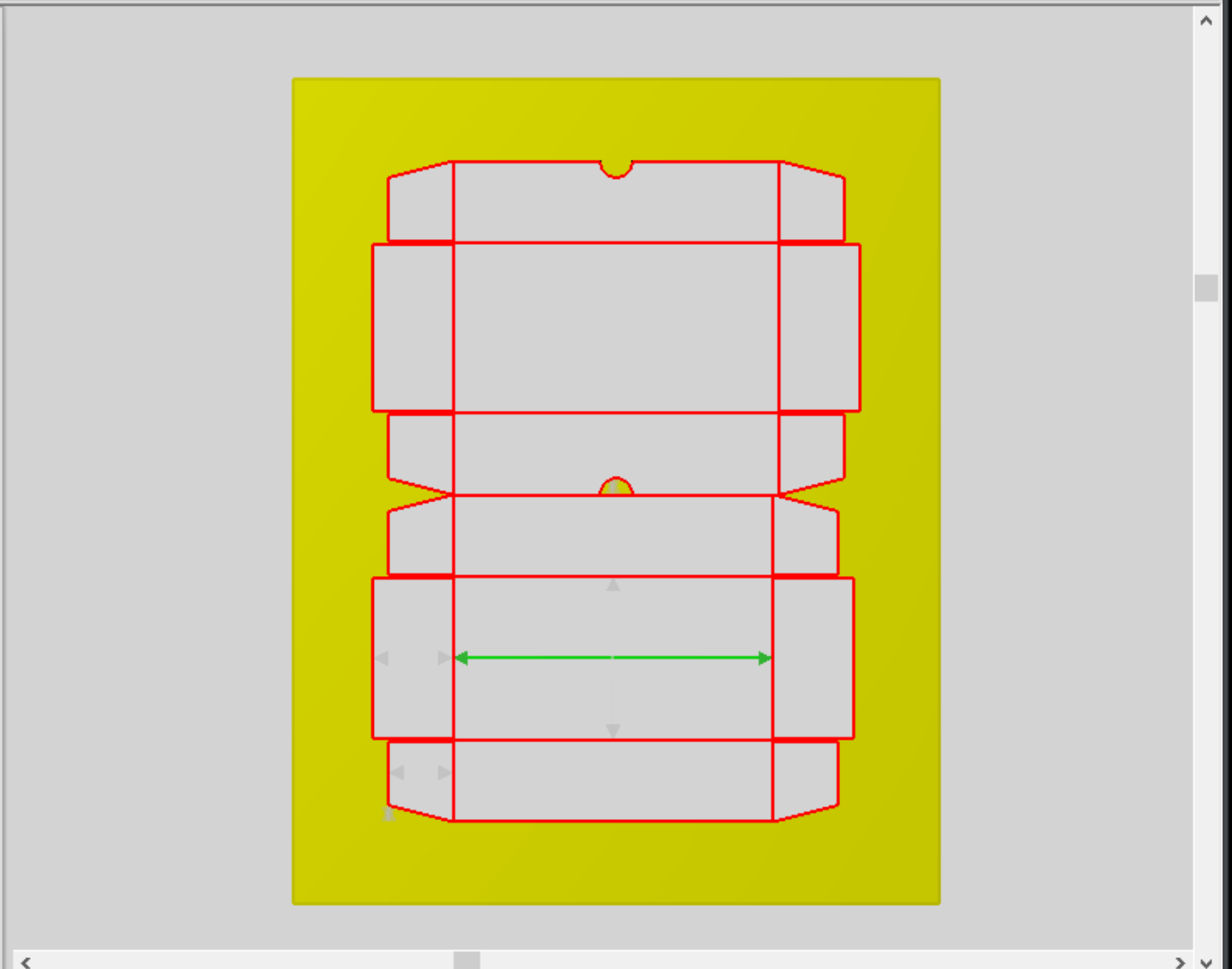

FRAGILE ITEM
VANDERN

Simple Box Base & Lid – F301a

STATE LIBRARY OF NSW
PXD 1408
Box 1
no. 9 1-17

STATE LIBRARY OF NSW
PXD 1408
Box 1
no. 9 1-17



Create Arrange Cut Admin Help

Templates Text Autoload Image ArtView Standard Corner Zoom Auto Zoom Reset View

Design Input Mode View Layer Finish Options

Archival Box Base & Lid – F314a

Template: F0314a

Length	Width
<input type="text" value="200.00 mm"/> + -	<input type="text" value="100.00 mm"/> + -
Height	Mat Thickness
<input type="text" value="50.00 mm"/> + -	<input type="text" value="1.00 mm"/> + -
Gap Width	Gap Length
<input type="text" value="3.00 mm"/> + -	<input type="text" value="20.00 mm"/> + -
Distance 1	Distance 2
<input type="text" value="10.00 mm"/> + -	<input type="text" value="2.00 mm"/> + -
Lobe Length	Play Top/Bottom
<input type="text" value="48.00 mm"/> + -	<input type="text" value="1.00 mm"/> + -
Radius	
<input type="text" value="10.00 mm"/> + -	

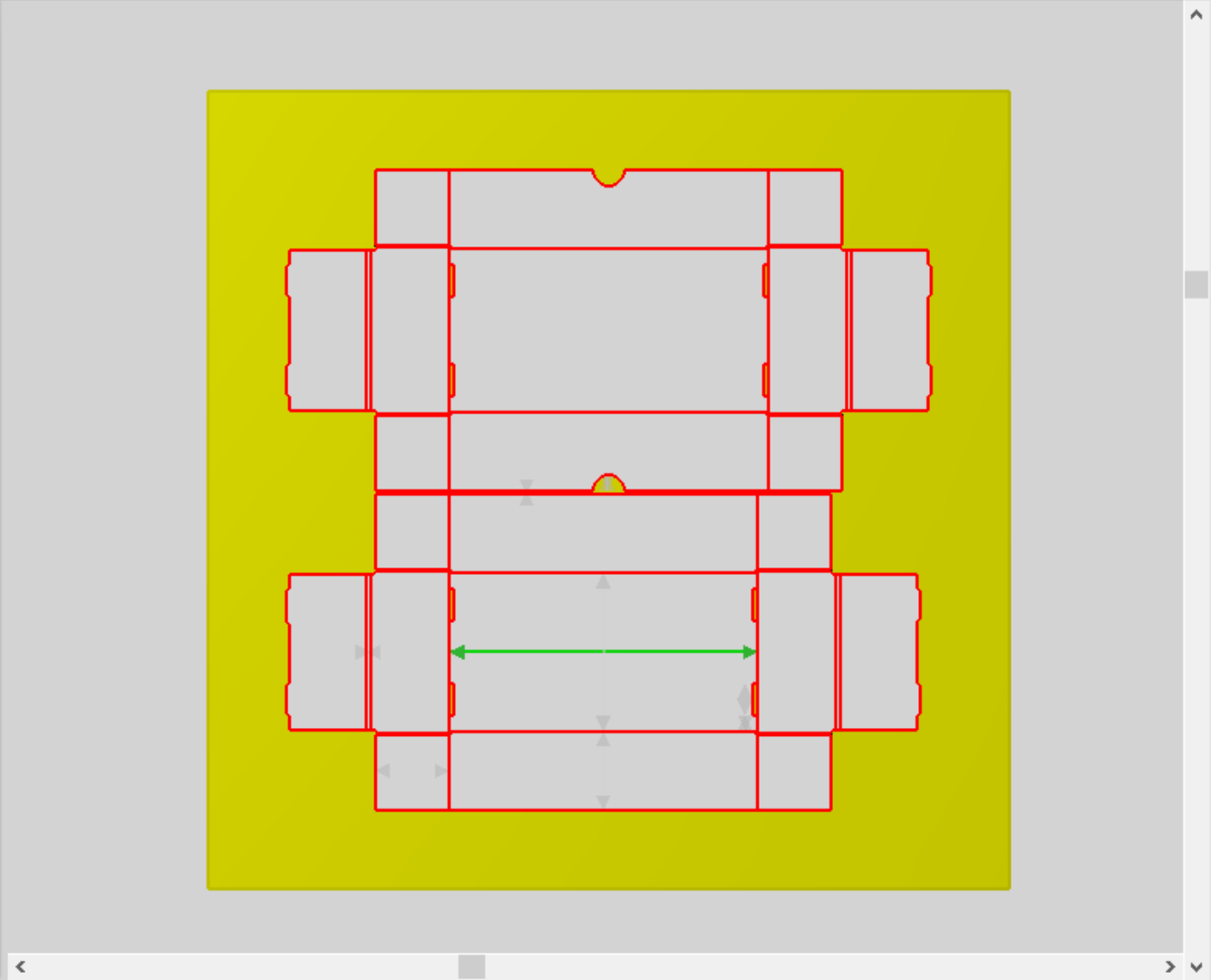

Archival Box Base & Lid – F314a



Archival Box Base & Lid – F314a





Create Arrange Cut Admin Help

Templates Design Input Mode View Layer Finish Options

Text Autoload Standard Corner Zoom Add Mat Layout
Draw Image Inside Out Auto Zoom Next Direct Cut
Clipart Import Four Borders Reset View

Drop Spine Box— F1010

Template: F1010

Length	Width
150.0 mm + -	100.0 mm + -
Height	Mat Thickness
50.0 mm + -	2.0 mm + -
TabHeight	TabLength
3.0 mm + -	25.0 mm + -

Slots

Create Cancel

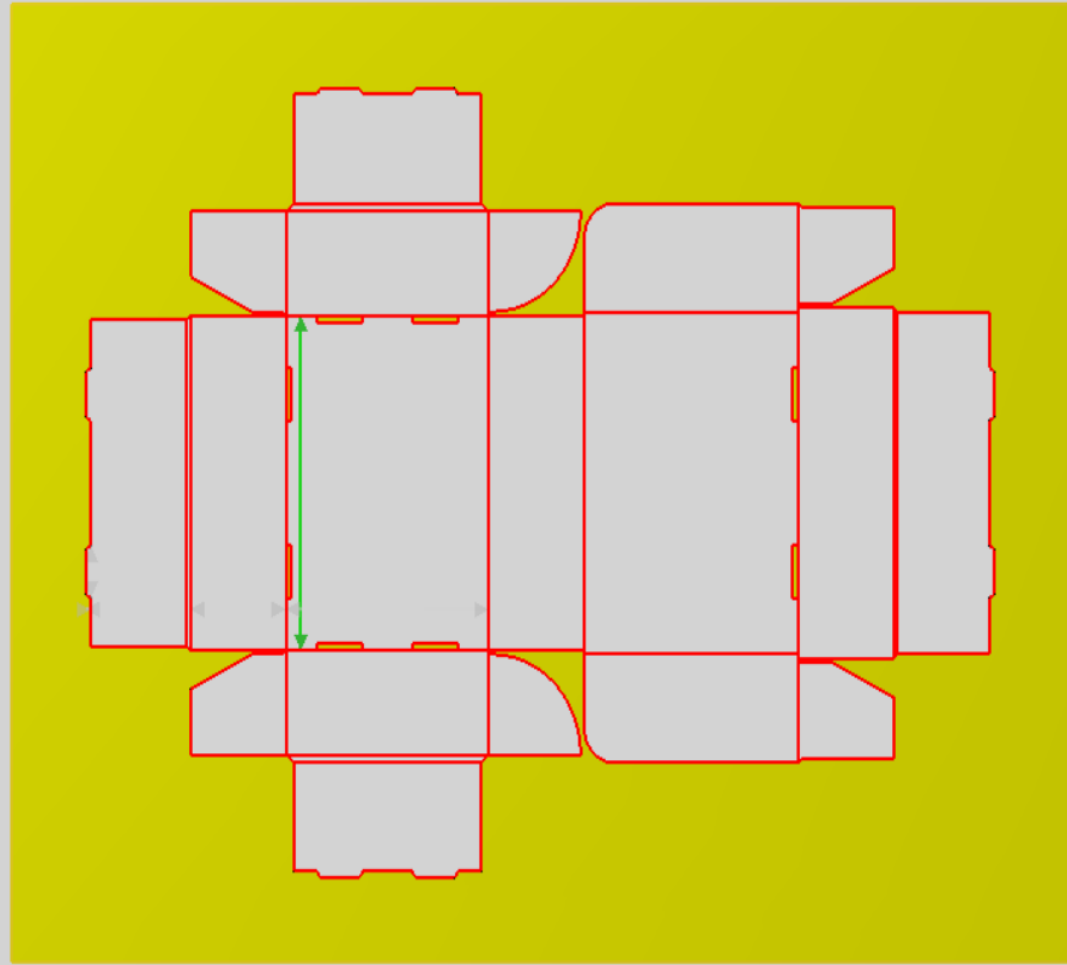

Drop Spine Box— F1010

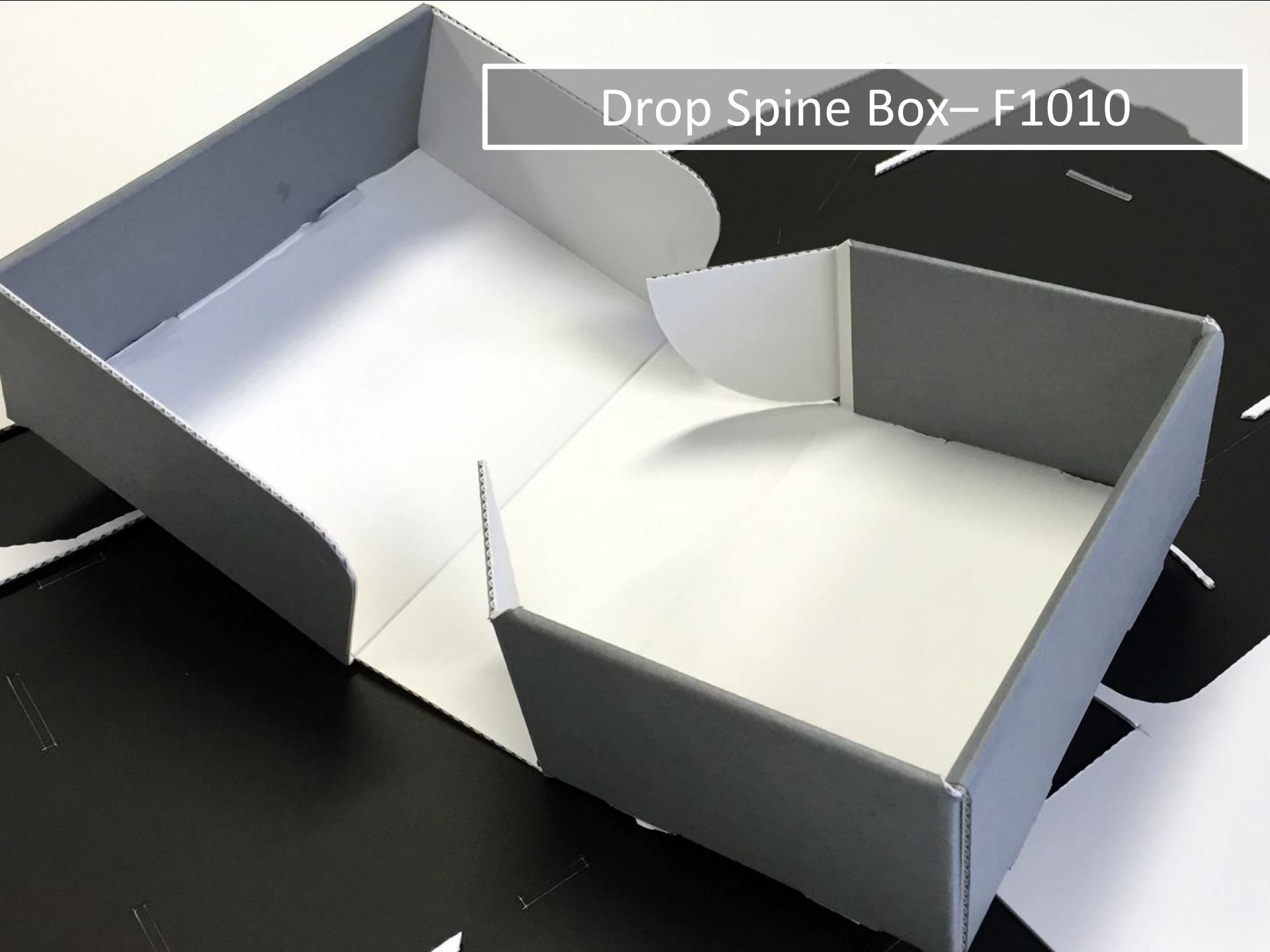

Drop Spine Box— F1010



Drop Spine Box— F1010

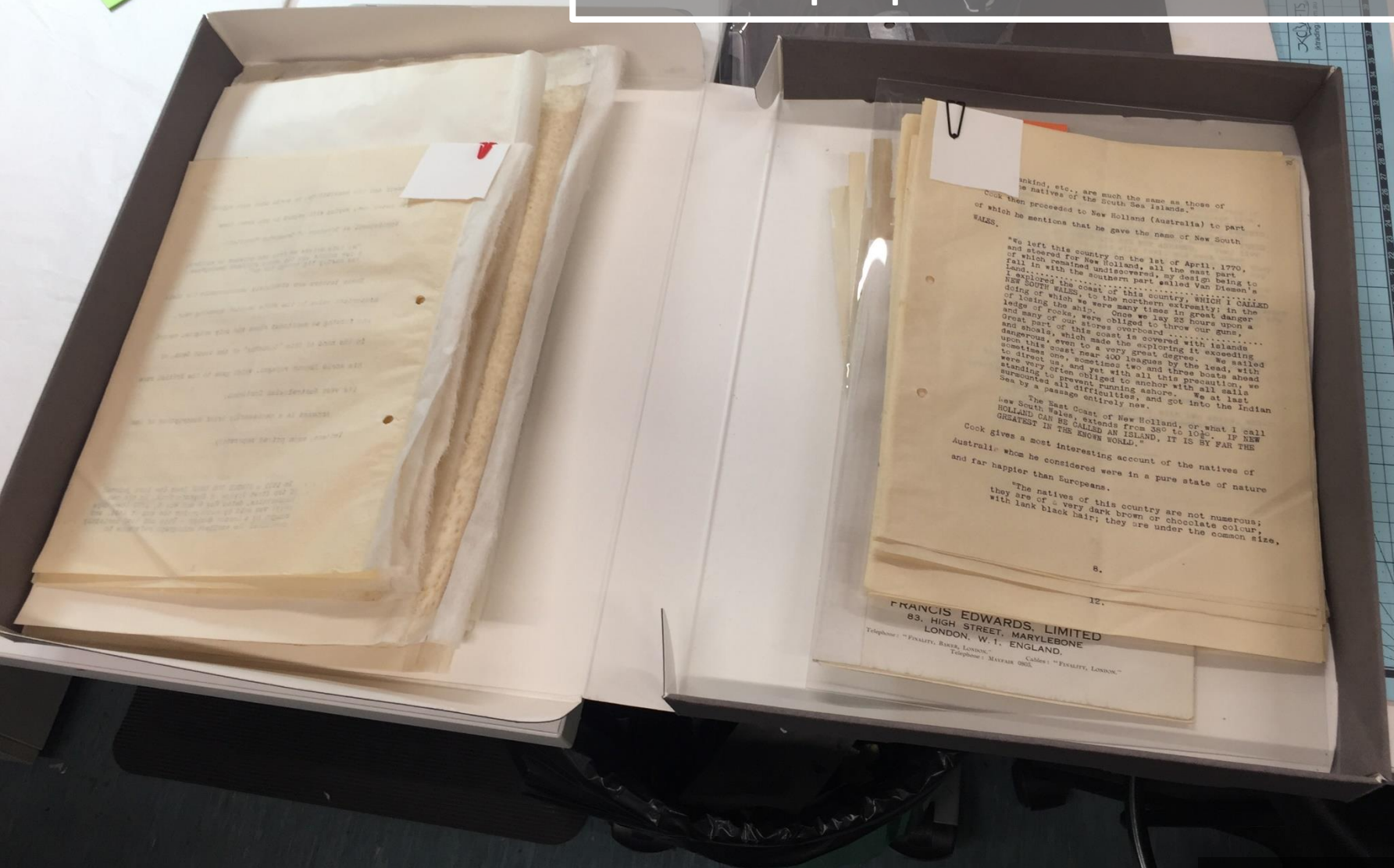

...nking, etc., are much the same as those of
the natives of the South Sea Islands."
Cook then proceeded to New Holland (Australia) to part
of which he mentions that he gave the name of New South
WALES.

"We left this country on the 1st of April, 1770,
and steered for New Holland, all the east part
of which remained undiscovered, my design being to
land.....
I explored the coast.....
NEW SOUTH WALES, to the northern extremity, in the
doing of which we were many times in great danger
of losing the ship. Once we lay 28 hours upon a
ledge of rocks, were obliged to throw our guns,
and many of our stores overboard.....
Great part of this coast is covered with islands
and shoals, which made the exploring it exceeding
dangerous, even to a very great degree. We sailed
upon this coast near 400 leagues by the lead, with
sometimes one, sometimes two and three boats ahead
were very often obliged to anchor with all sails
standing to prevent running ashore. We at last
surmounted all difficulties, and got into the Indian
sea by a passage entirely new.

The East Coast of New Holland, or what I call
New South Wales, extends from 35° to 108°. IF NEW
HOLLAND CAN BE CALLED AN ISLAND, IT IS BY FAR THE
GREATEST IN THE KNOWN WORLD.

Cook gives a most interesting account of the natives of
Australia whom he considered were in a pure state of nature
and far happier than Europeans.

"The natives of this country are not numerous;
they are of a very dark brown or chocolate colour,
with lank black hair; they are under the common size,

8.

12.

FRANCIS EDWARDS, LIMITED
83, HIGH STREET, MARYLEBONE
LONDON, W. 1, ENGLAND.
Telephone: "FENALTY, BAKER, LONDON."
Telegrams: "MAYFAIR 0800."

Drop Spine Box— F1010

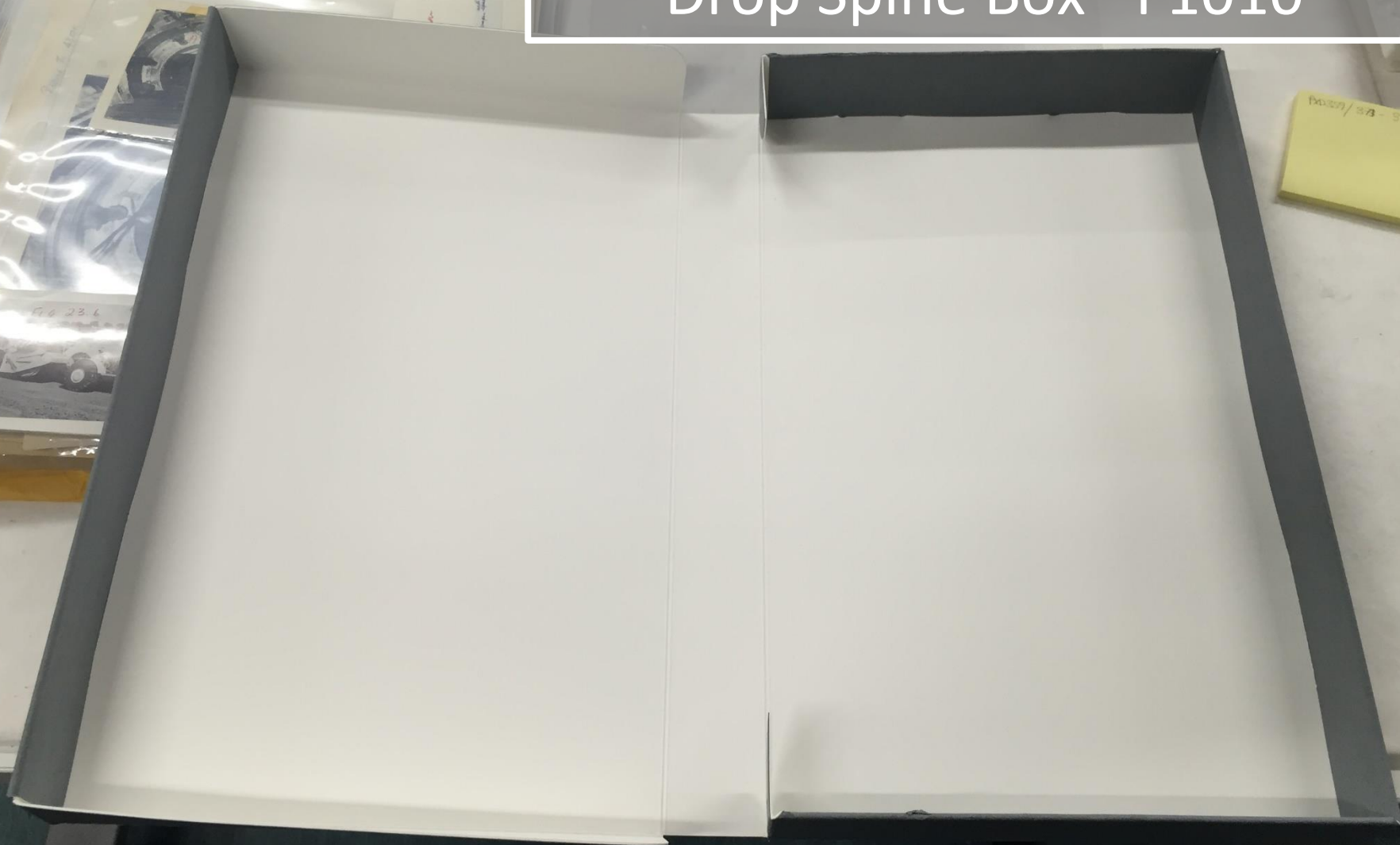

Drop Spine Box— F1010



Drop Spine Box— F1010

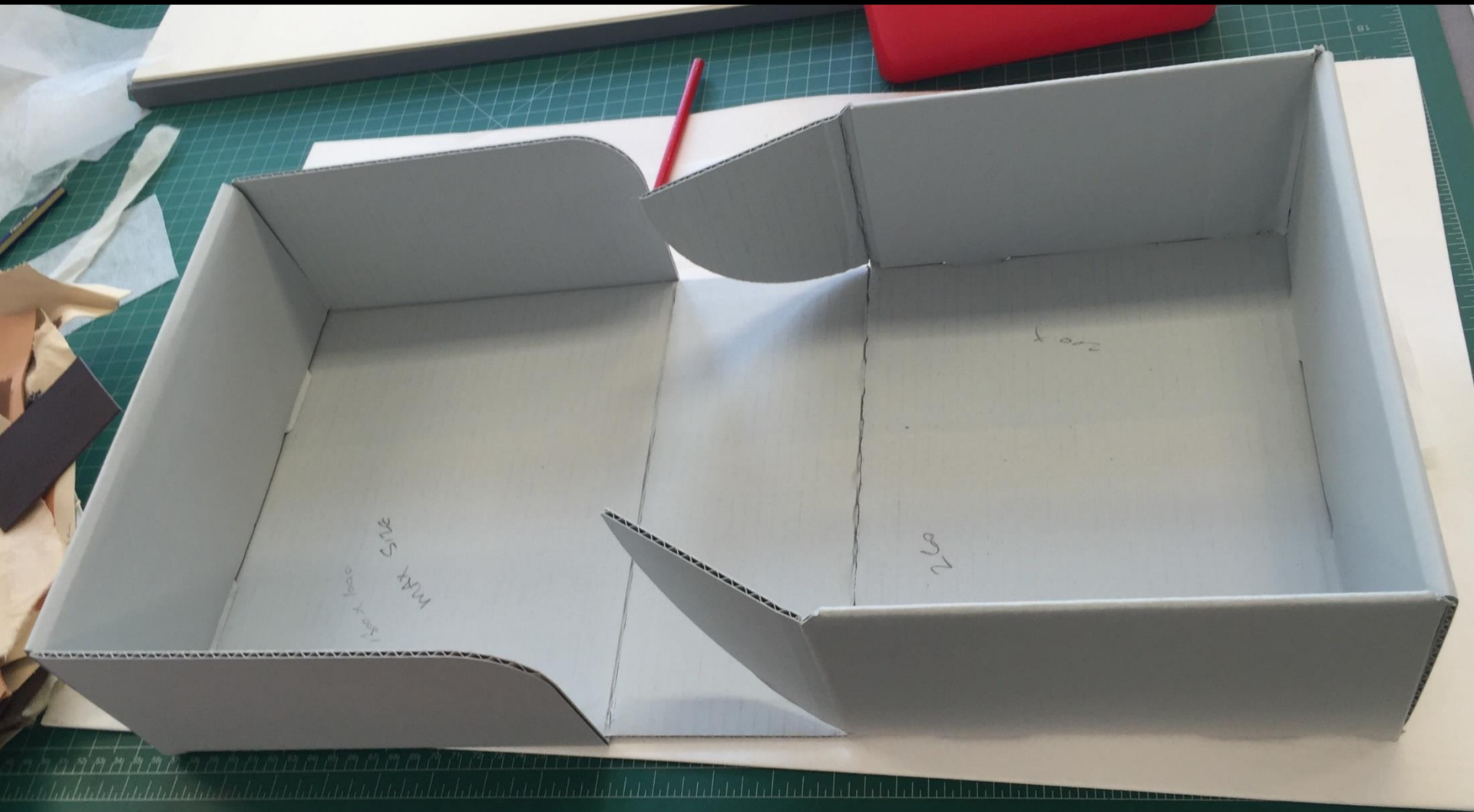

Drop Spine Box— F1010



Simple Hinged Box & Lid- F0421

Create Arrange Cut Admin Help

Standard Corner Zoom Auto Zoom Reset View

Text Autoload Draw Image Clipart Import ArtView

Templates Design Input Mode View Layer Finish Options

Template: F0421

Length	Width
<input type="text" value="300.0 mm"/>	<input type="text" value="200.0 mm"/>
Height	Mat Thickness
<input type="text" value="50.0 mm"/>	<input type="text" value="3.0 mm"/>
SlotWidth	TabLength
<input type="text" value="3.0 mm"/>	<input type="text" value="40.0 mm"/>
Distance	Front Lobe
<input type="text" value="40.0 mm"/>	<input type="text" value="49.0 mm"/>
Lobe Length	Radius
<input type="text" value="48.0 mm"/>	<input type="text" value="10.0 mm"/>
TabHeight	
<input type="text" value="4.5 mm"/>	

Slots

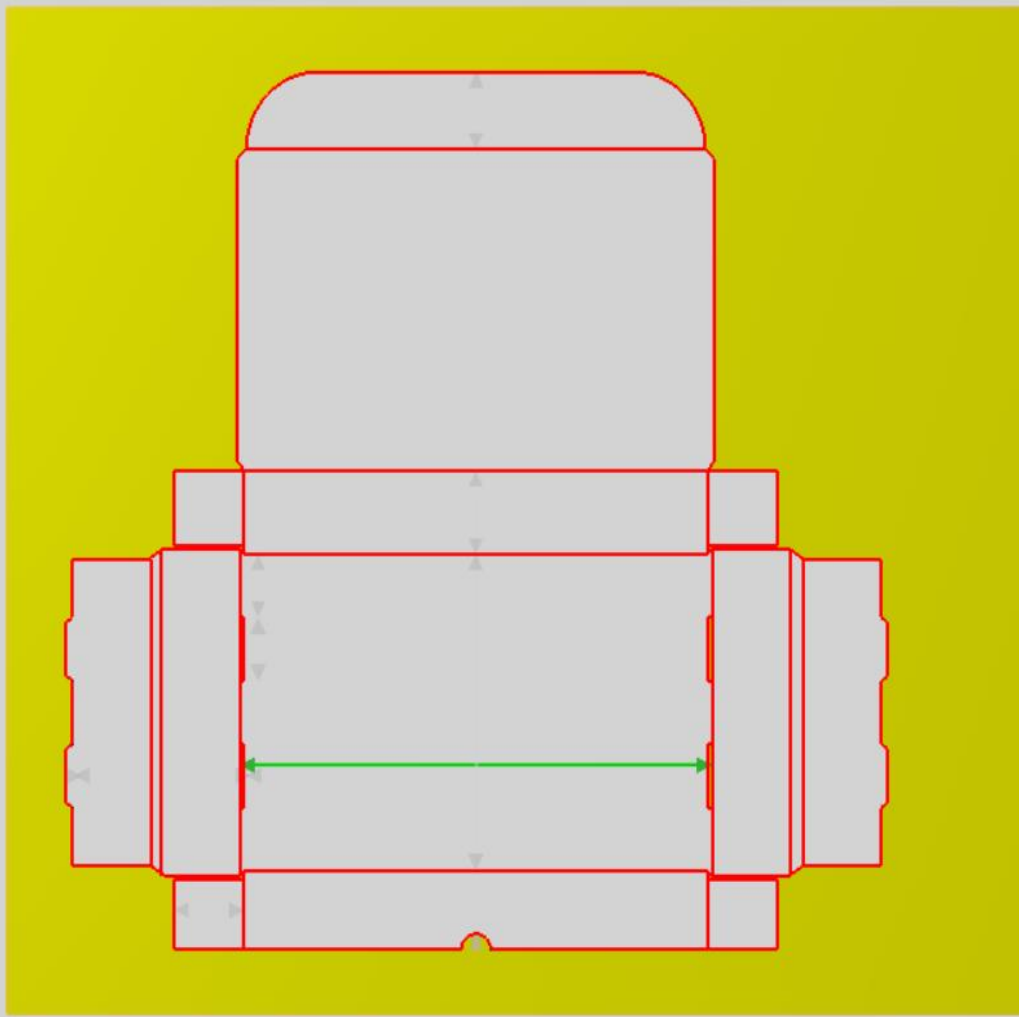

Create Cancel

Simple Hinged Box & Lid– F0421





Create Arrange Cut Admin Help

Templates

Text Autoload
Draw Image
Clipart Import

ArtView

Design

Standard Corner Zoom
Four Borders Reset View

Input Mode view Layer Finish Options

Double Wall Box with Drop Front— F0314b

Template: F0314b

Length	Width
100.0 mm + -	200.0 mm + -
Height	Mat Thickness
50.0 mm + -	3.0 mm + -
Lobe Length	SlotWidth
48.0 mm + -	3.0 mm + -
TabHeight	TabLength
1.5 mm + -	20.0 mm + -
Distance 1	Distance 2
10.0 mm + -	20.0 mm + -

- Slots
- SingleSlots
- Use None Arc Lobe on Top Flap

Create

Cancel

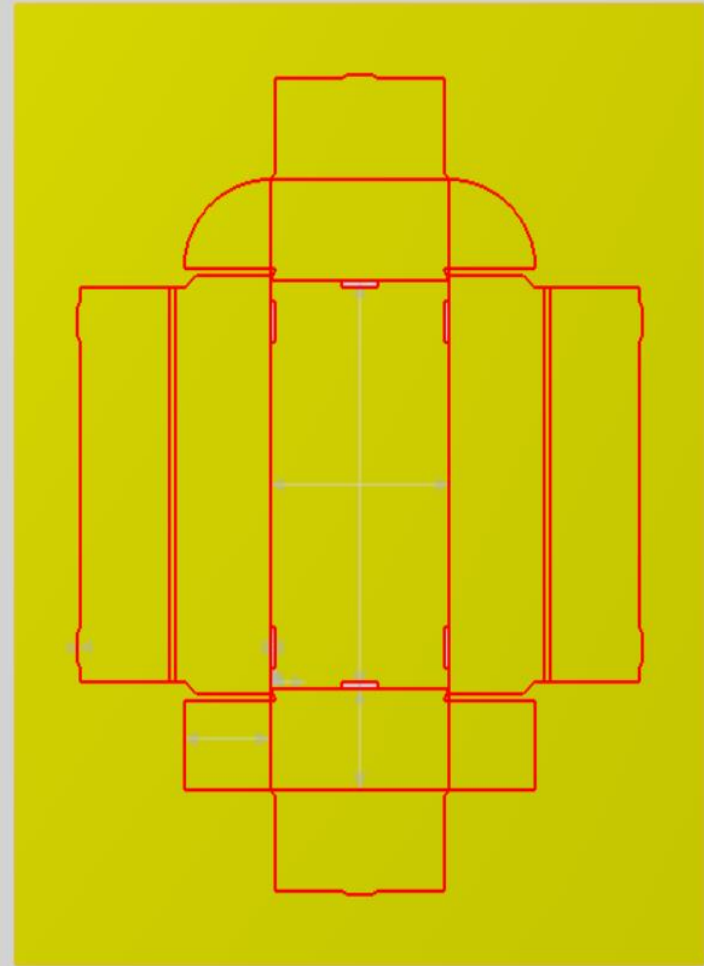

Double Wall Box with Drop Front– F0314b

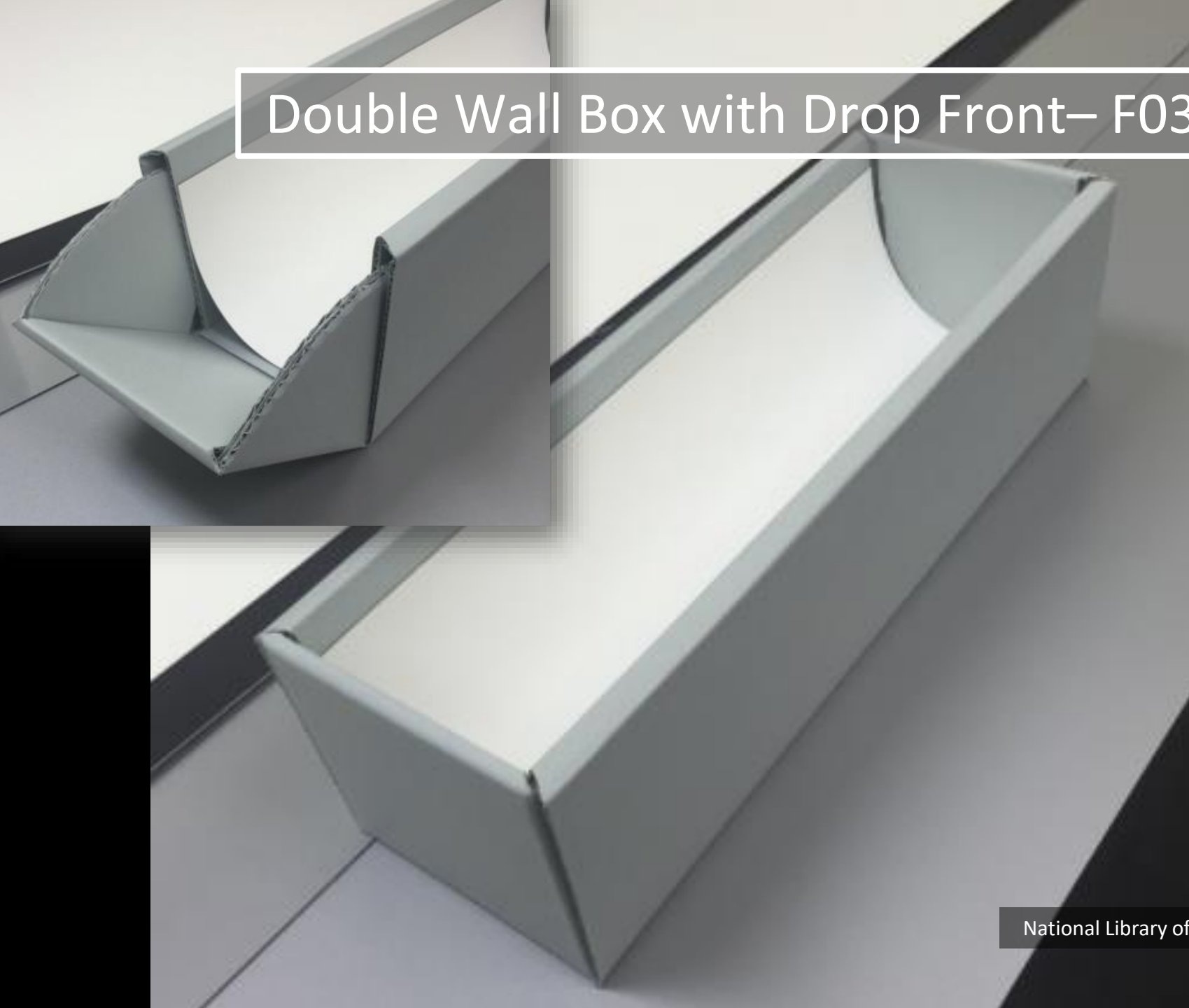

Template: F1100

Length	Width
150.00 mm + -	100.00 mm + -
Height	Side Lobe
60.00 mm + -	40.00 mm + -
Cover	Front Lobe
30.00 mm + -	20.00 mm + -
Corner Size	Distance
10.00 mm + -	5.00 mm + -
Mat Thickness	Radius
3.00 mm + -	10.00 mm + -

Create Cancel

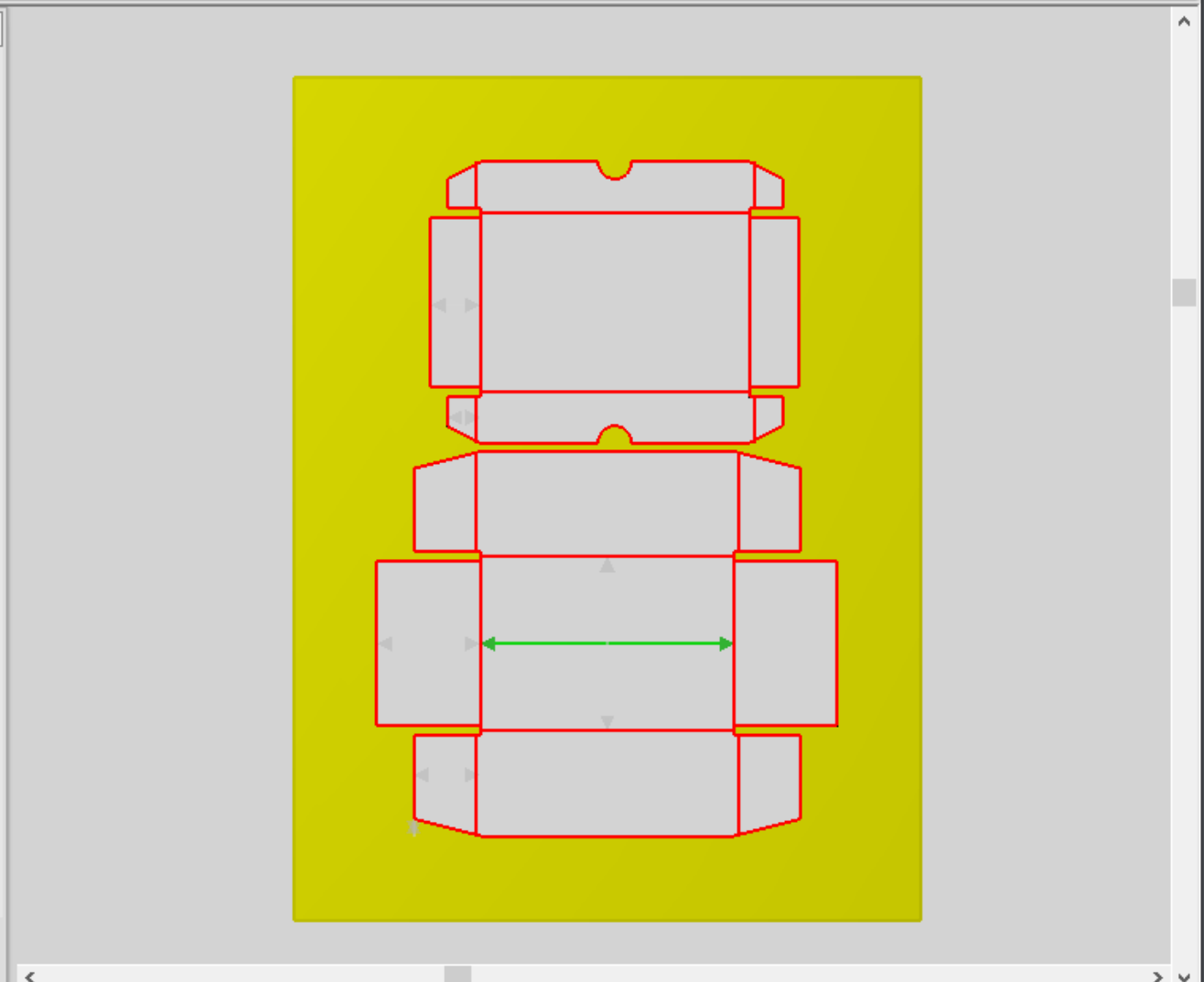

Object Storage Box & Lid – F1100



Object Storage Box & Lid – F1100





Create Arrange Cut Admin Help

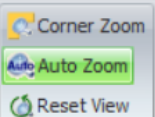
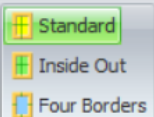
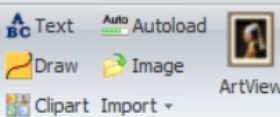
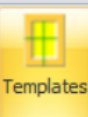

Half Box – K1030



Template: K1030

Length	Width
<input type="text" value="200.0 mm"/>	<input type="text" value="100.0 mm"/>
Height	Mat Thickness
<input type="text" value="50.0 mm"/>	<input type="text" value="3.0 mm"/>
Lobe Length	Corner Size
<input type="text" value="40.0 mm"/>	<input type="text" value="10.0 mm"/>

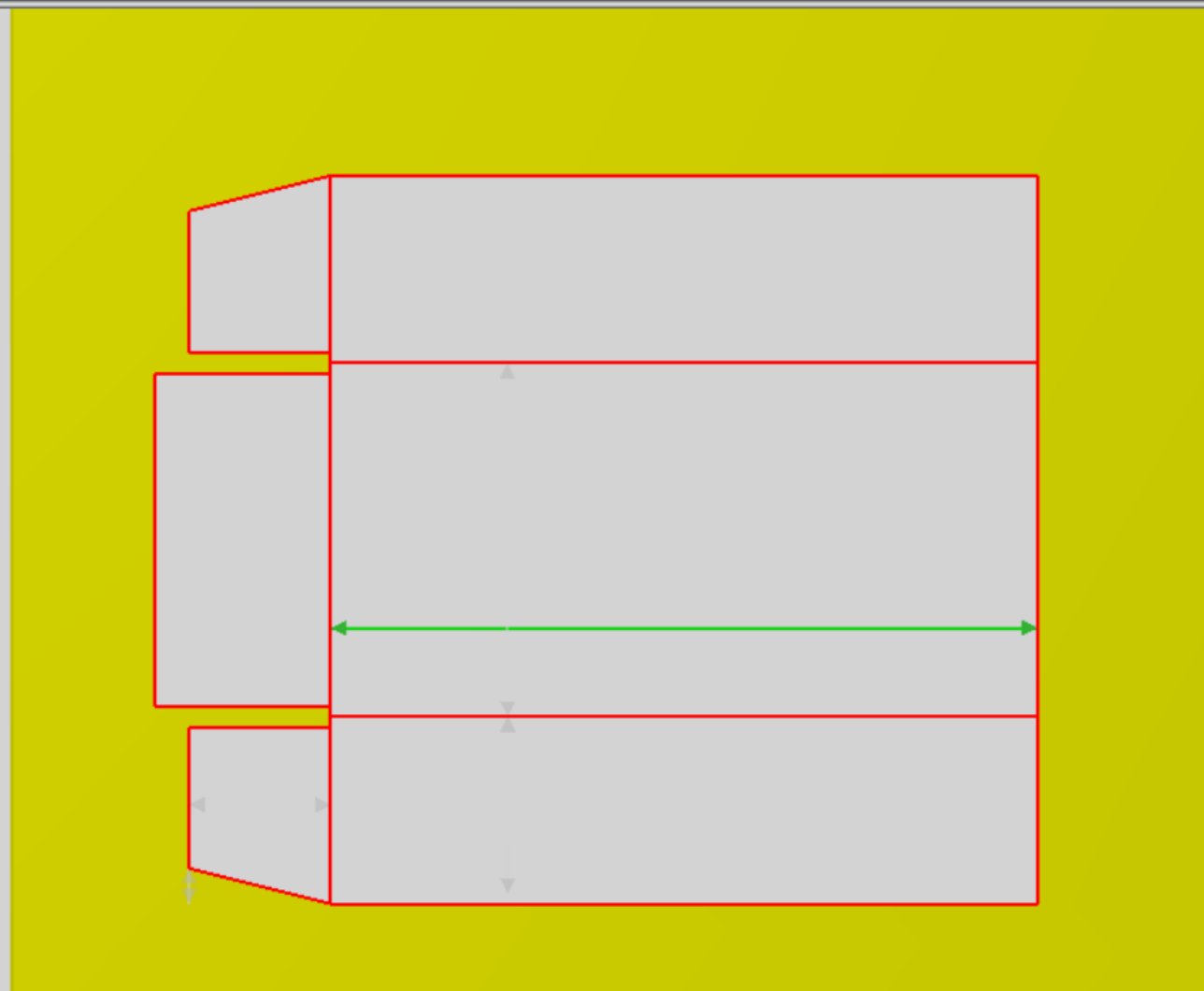

Create Cancel

Half Box – K1030



Half Box – K1030



Half Box – K1030





Create Arrange Cut Admin Help

Templates Design

Text Autoload Draw Image Clipart Import ArtView

Standard Inside Out Four Borders Input Mode

Corner Zoom Auto Zoom Reset View View

C1 Layer

Next Direct Cut Finish Options

Internal Box Divider – G1120

Template: G1120

Length	300.0 mm	+ -	Height	100.0 mm	+ -
Number of Steps	4	+ -	Mat Thickness	3.0 mm	+ -
TabWidth	10.0 mm	+ -			

Create Cancel



Internal Box Divider – G1120



Internal Box Divider – G1120



Internal Box Divider – G1120



863A162



865A126



865A127



865A228



865A230



865A232



865A234



Internal Box Divider – G1120



865A

865A245

865A244

865A243

4-flap folders

Create Arrange Cut Admin Help

Templates Text Autoload Standard Corner Zoom

Draw Image ArtView Inside Out Auto Zoom

Clipart Import Four Borders Reset View

Design Input Mode View Layer Finish Options

4 Flap Folder with Lock – G033

Template: G033

Length	Width
680.00 mm + -	580.00 mm + -
Side Lobe	SideLobeB
140.00 mm + -	140.00 mm + -
Length 1	Front Lobe
640.00 mm + -	292.10 mm + -
Cover	Radius
465.00 mm + -	15.00 mm + -
Slice Width	Lobe Length
3.00 mm + -	120.00 mm + -
Lobe Width	Distance
25.00 mm + -	10.00 mm + -

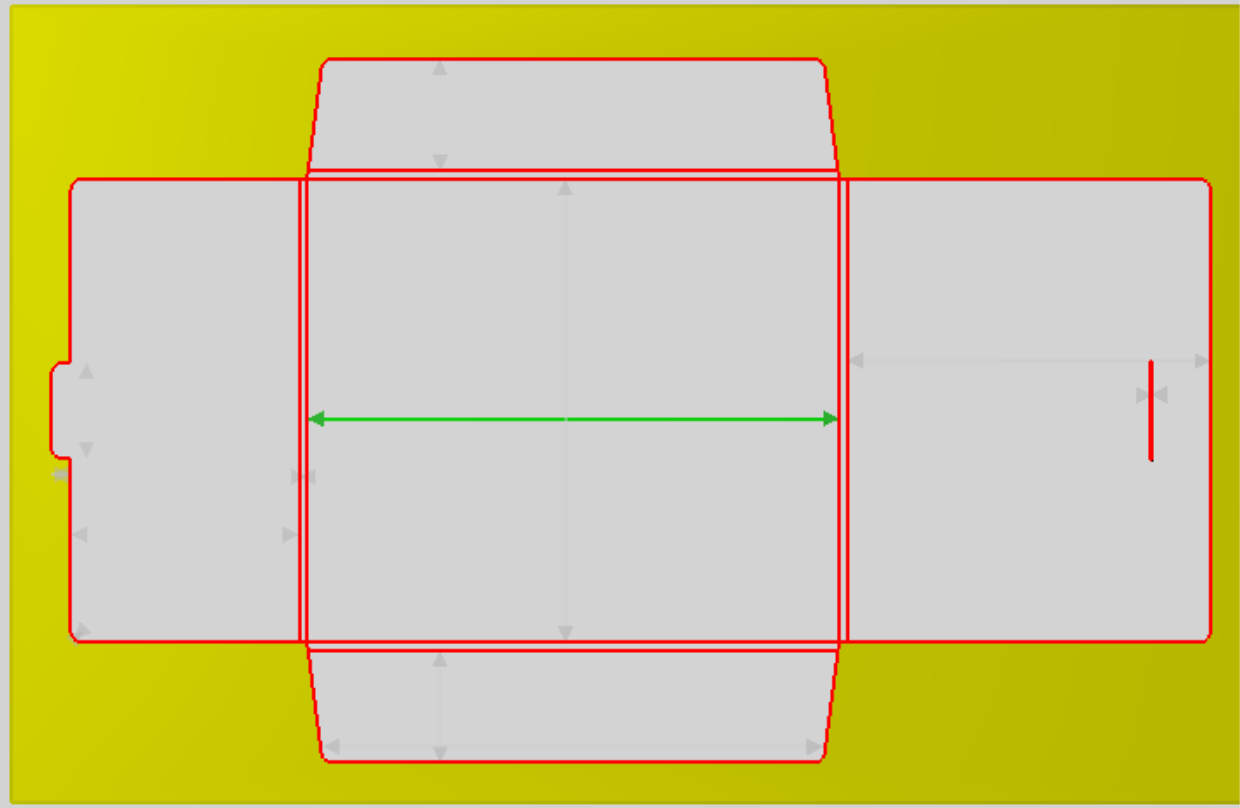

Create Cancel

4 Flap Folder with Lock – G033



4 Flap Folder with Lock – G033



4 Flap Folder with Lock – G033

Templates | Text | Autoload | Standard | Corner Zoom | C3 | Next | Add Mat Layer | Direct Cut

Draw | Image | ArtView | Inside Out | Auto Zoom | Four Borders | Reset View | Finish Options

Design | Input Mode | View | Layer

4 Flap Phase Box – F1020

Template: F1020

Length	Width
<input type="text" value="150.00 mm"/> + -	<input type="text" value="100.00 mm"/> + -
Height	Mat Thickness
<input type="text" value="20.00 mm"/> + -	<input type="text" value="2.00 mm"/> + -
Radius	
<input type="text" value="10.00 mm"/> + -	

Create Cancel

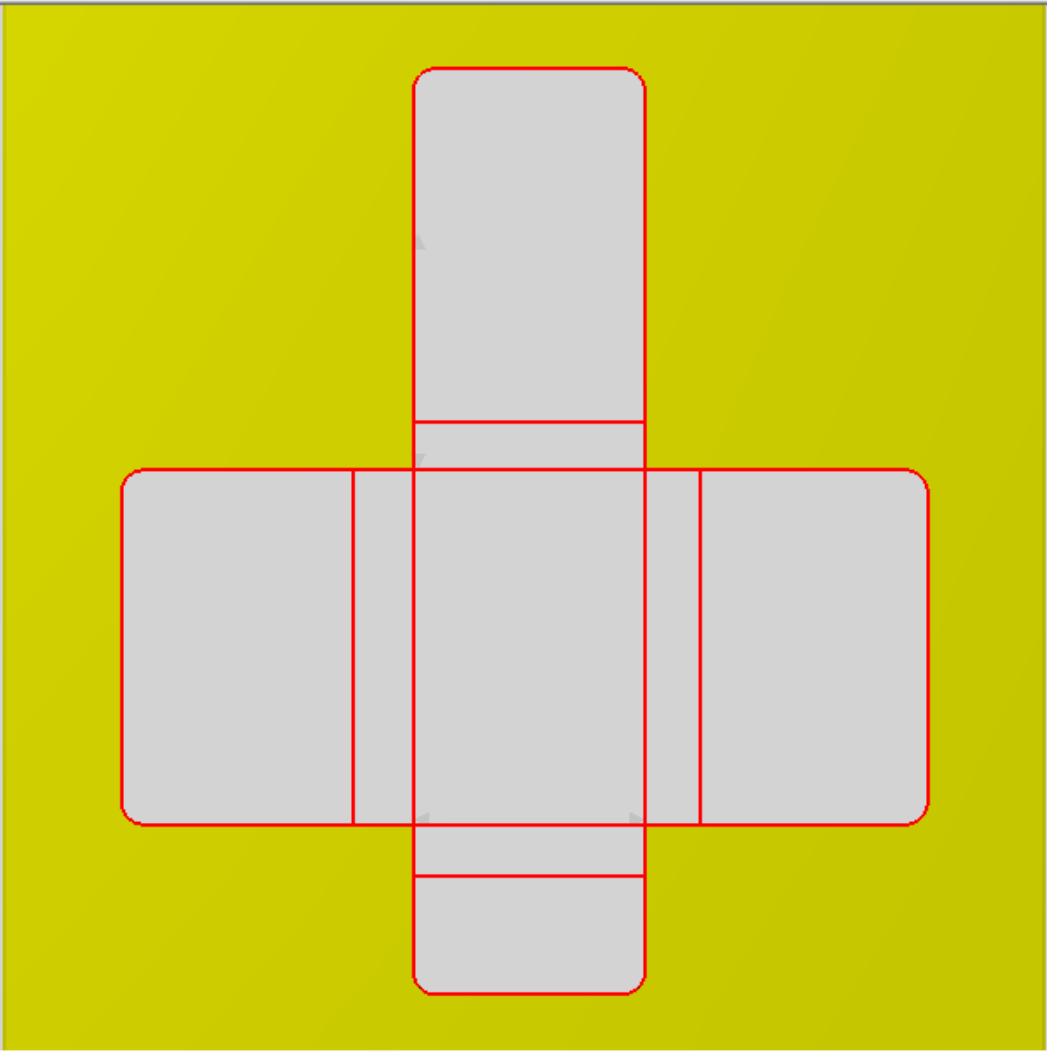

4 Flap Phase Box – F1020



4 Flap Phase Box – F1020

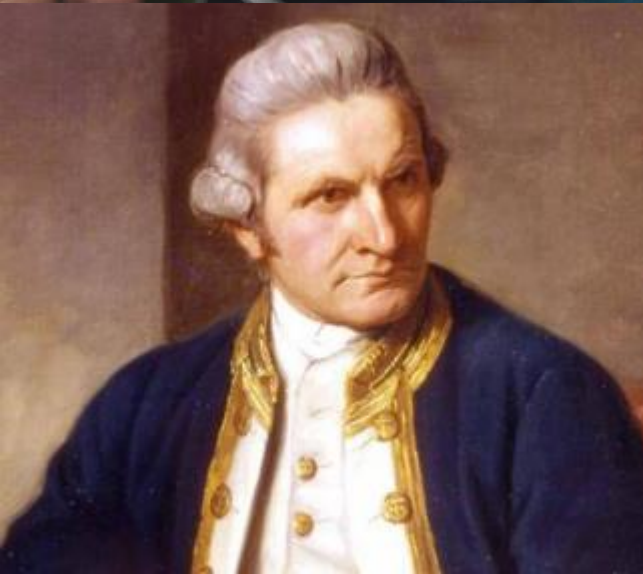



Create Arrange Cut Admin Help

4 Flap Pressure Box – G1070

Templates Design Text Autoload Image ArtView Standard Corner Zoom Auto Zoom Reset View C16 Next Direct Cut Finish Options

Template: G1070

Length	Width
300.0 mm + -	200.0 mm + -
Height	Radius
50.0 mm + -	10.0 mm + -
Distance	Mat Thickness
10.0 mm + -	3.0 mm + -

Cover

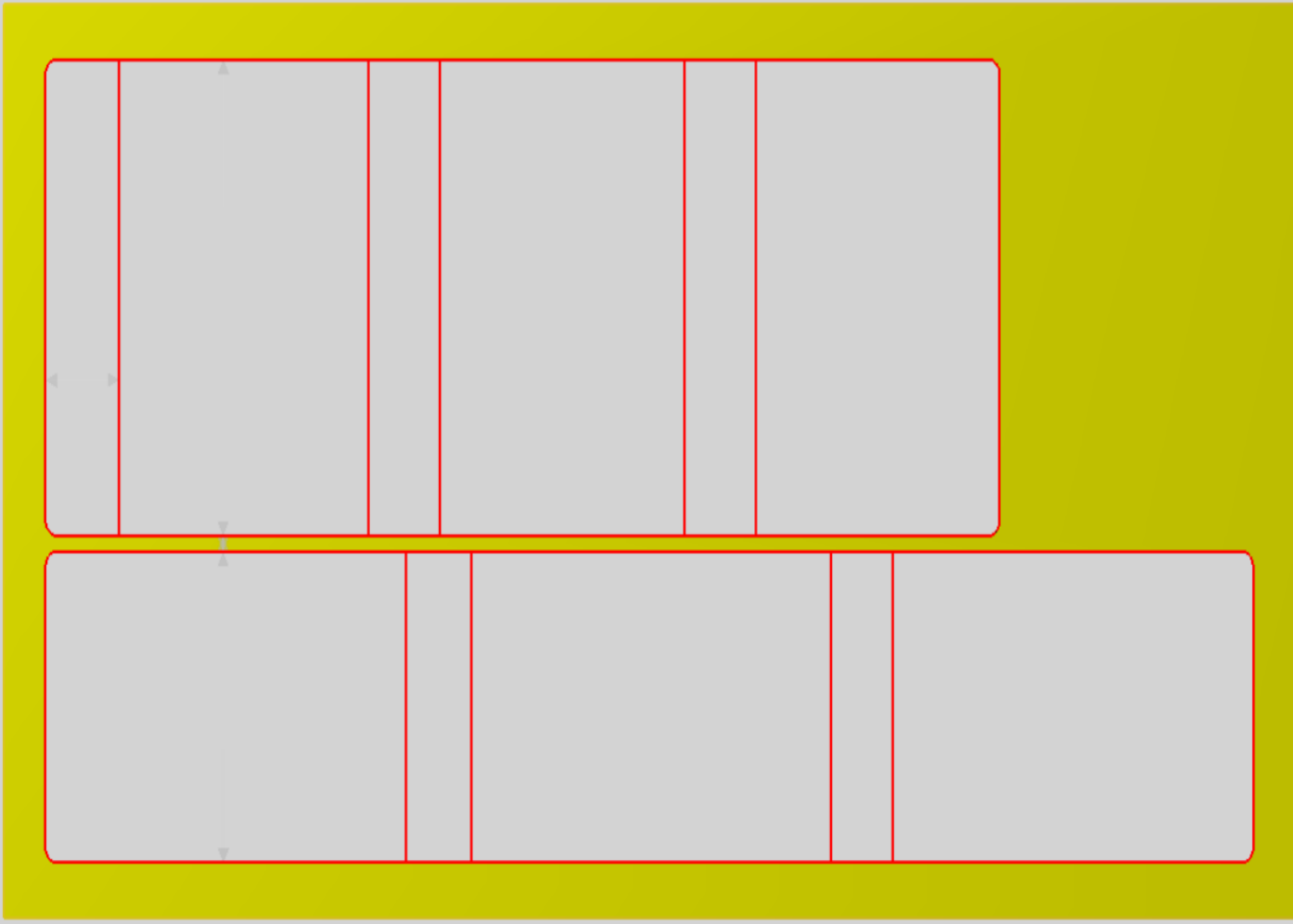

Create Cancel

4 Flap Pressure Box – G1070



4 Flap Pressure Box – G1070

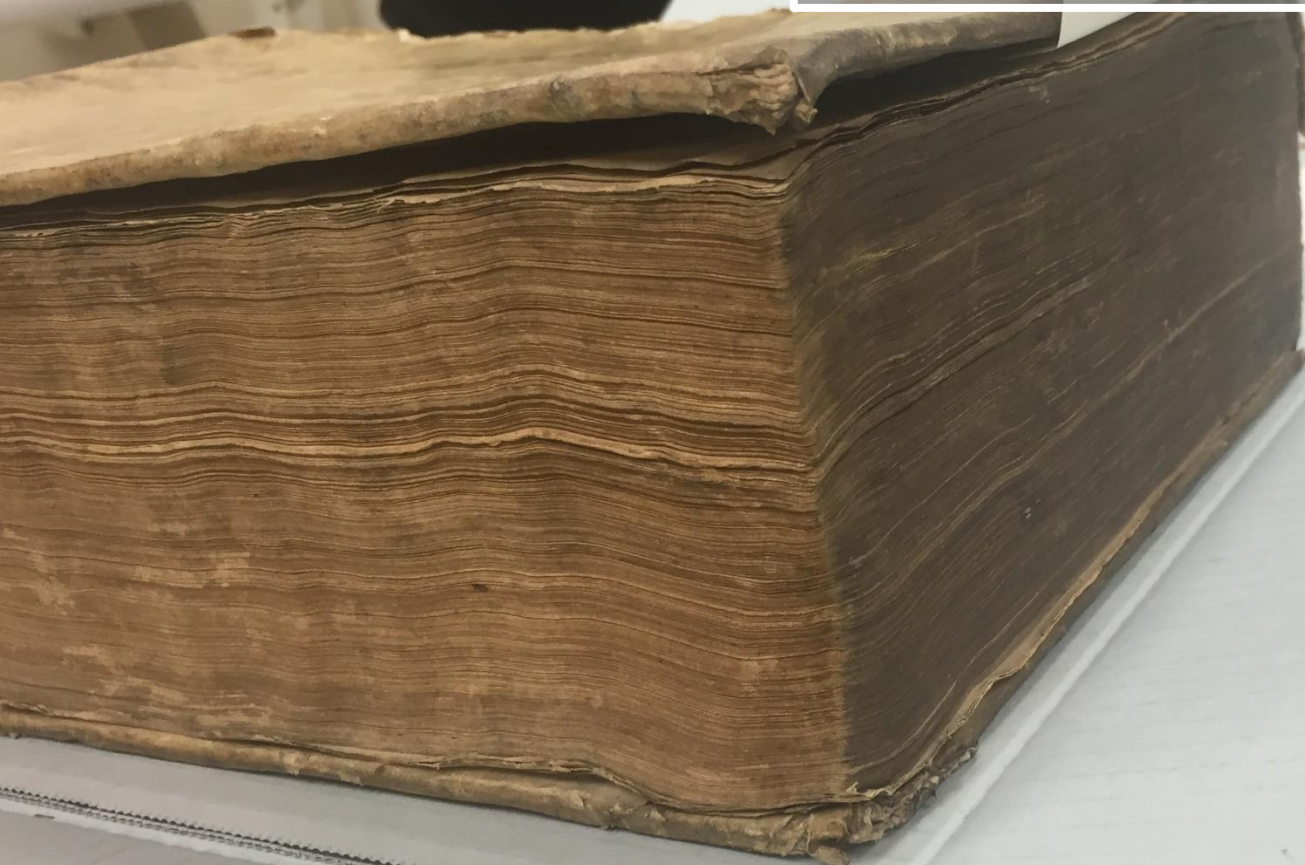

4 Flap Pressure Box – G1070

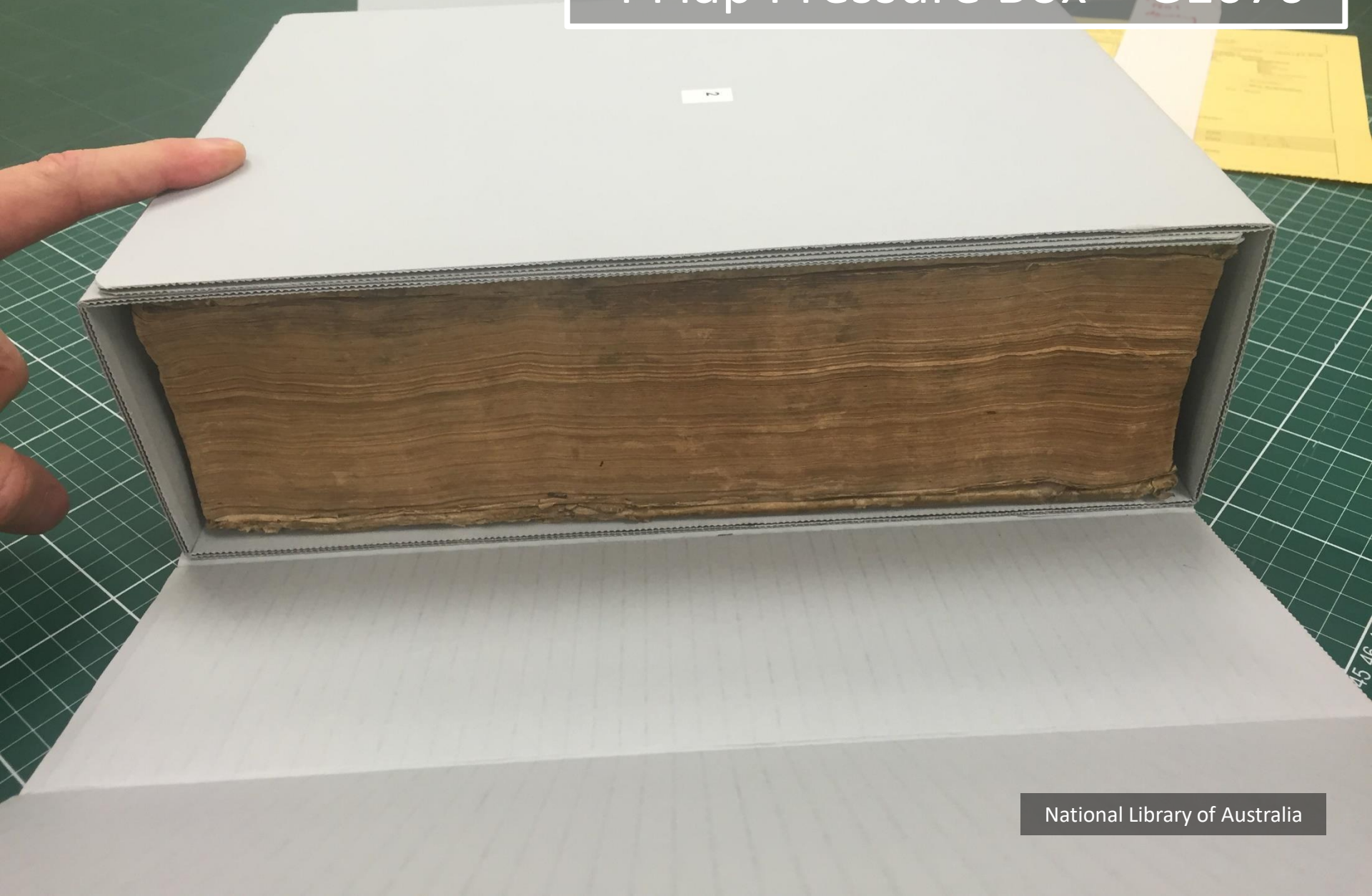

4 Flap Pressure Box – G1070

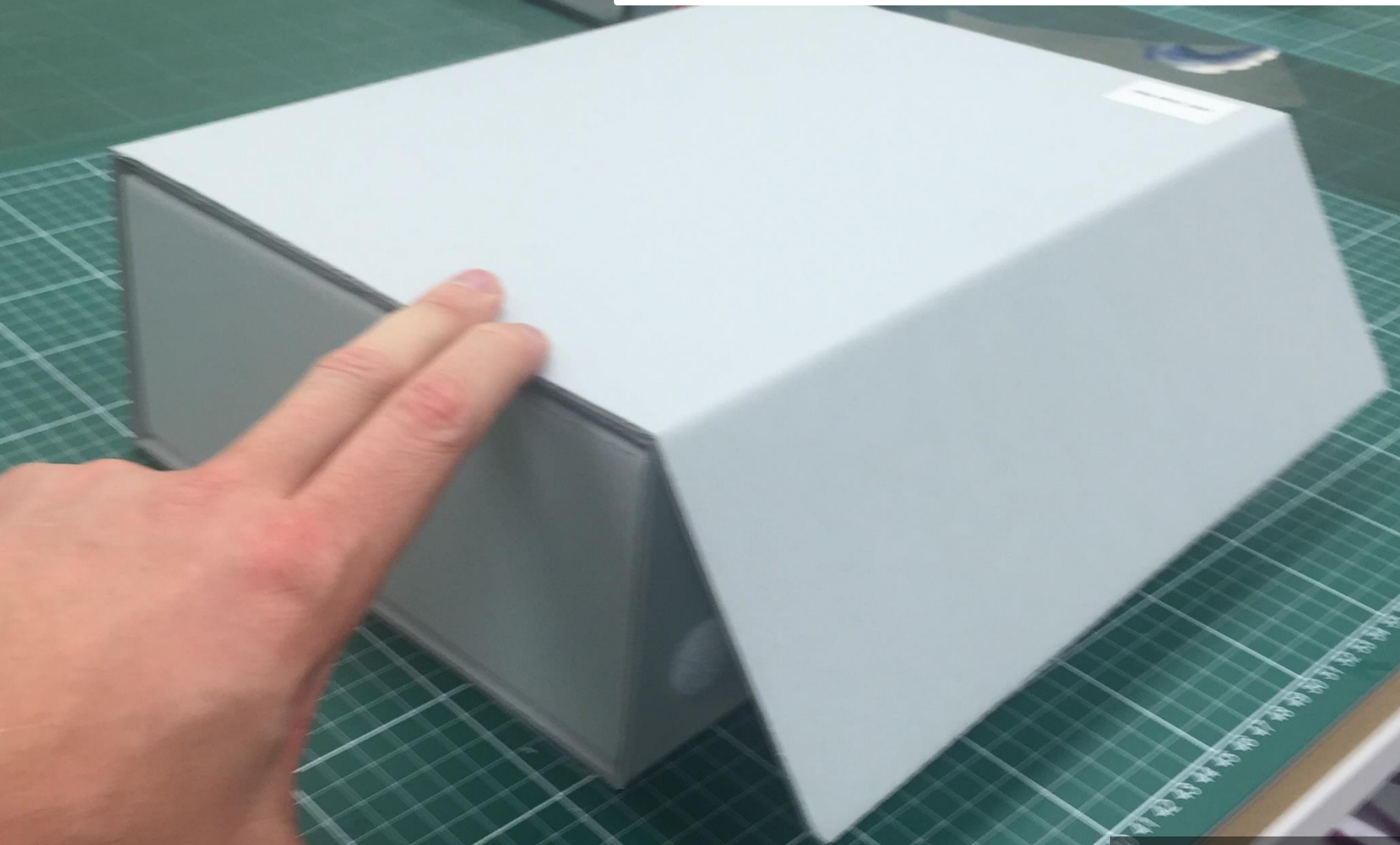

4 Flap Pressure Box – G1070

RLA MISC 2057

packaging



Create Arrange Cut Admin Help

Templates
 Text
 Draw
 Clipart Import
 Autoload
 Image
 ArtView

Standard
 Inside Out
 Four Borders
 Corner Zoom
 Auto Zoom
 Reset View

C3
 Next
 Finish Options

Protective Corner – G010

Template: G010

Length: + -
 Mat Thickness: + -
 Height: + -
 Lobe Width: + -
 Lobe Length: + -

Create Cancel

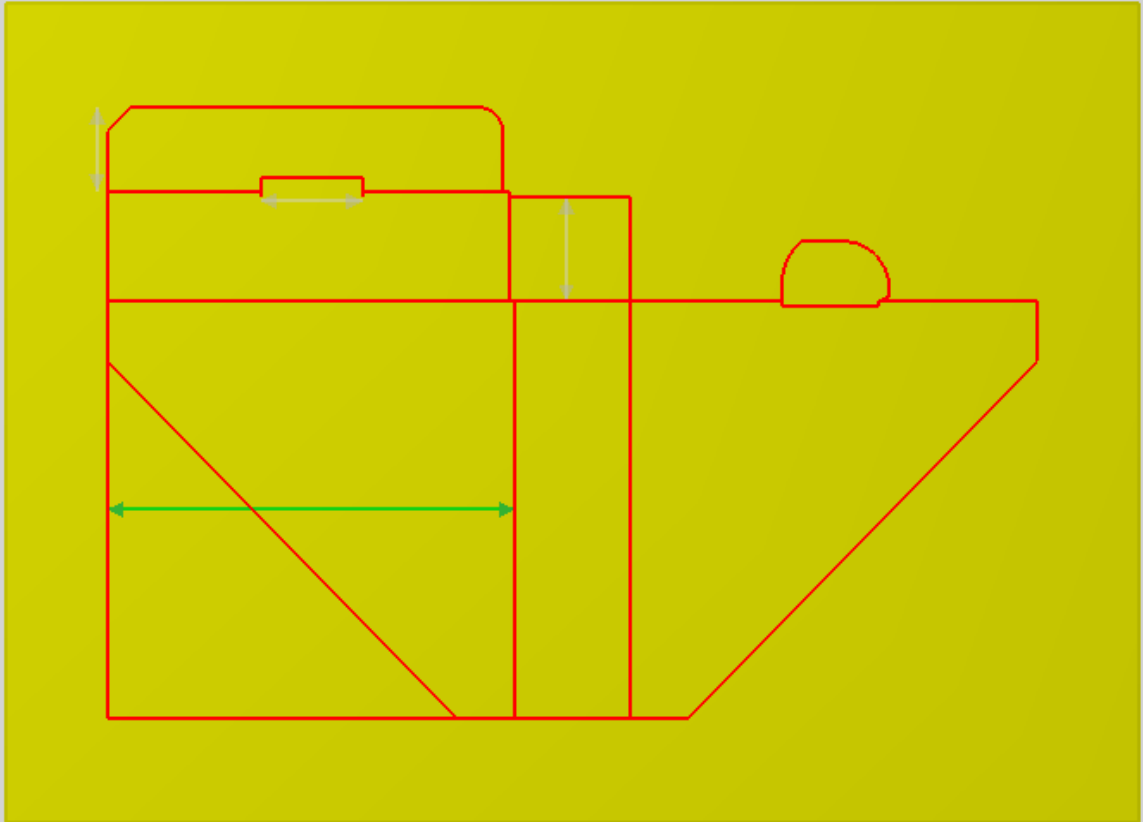

Protective Corner – G010

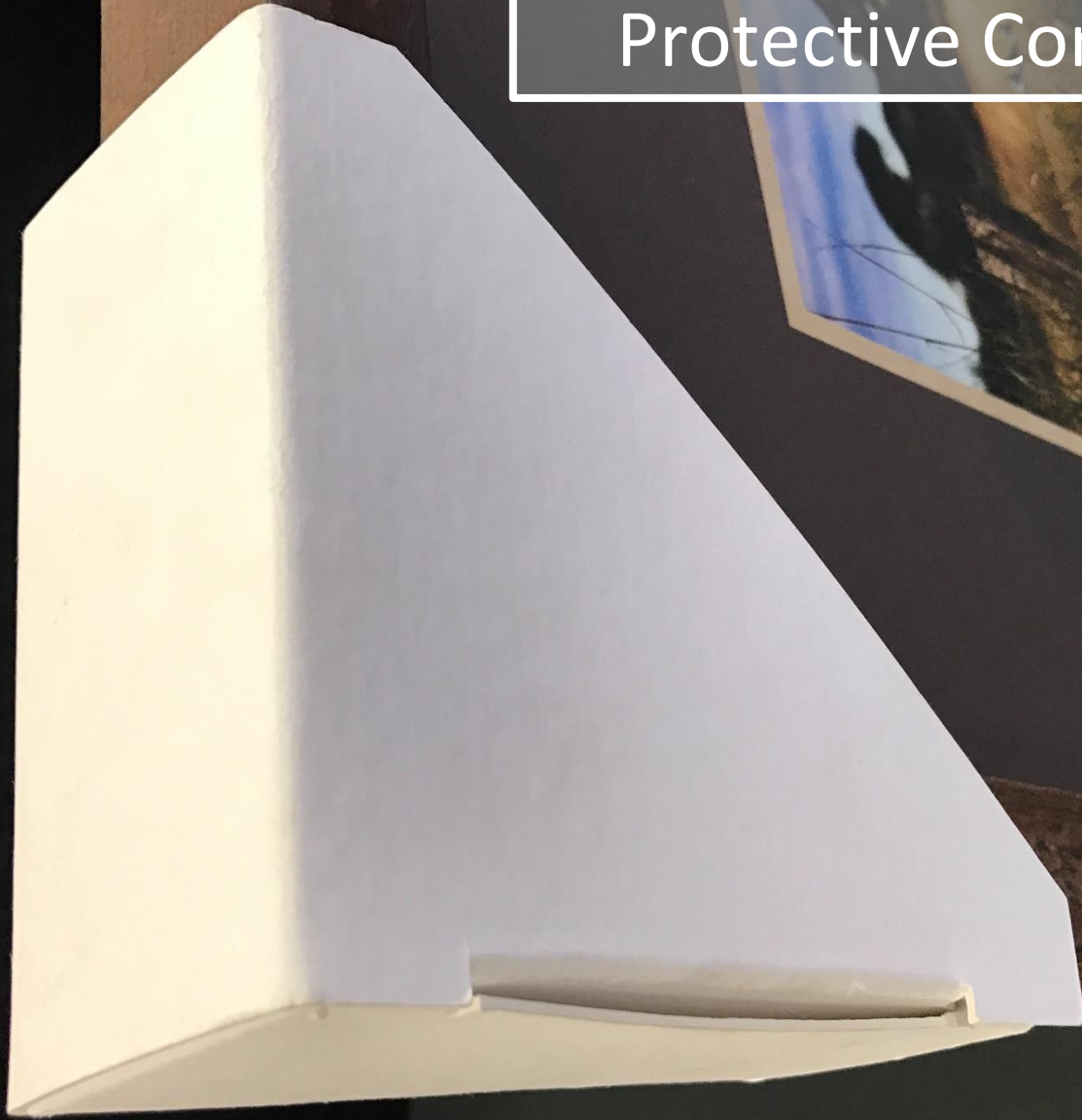



Create Arrange Cut Admin Help

Templates Design

Text Autoload Image ArtView

Clipart Import

Standard

Inside Out

Four Borders

Input Mode

Corner Zoom

Auto Auto

Reset View

View Layer Finish Options

Protective Support Tray – G1150

Template: G1150

Width	500.0 mm	+ -	Height	400.0 mm	+ -
Opening Width	400.0 mm	+ -	Opening Height	300.0 mm	+ -
Depth	30.0 mm	+ -	Gap Size	100.0 mm	+ -

Create Cancel

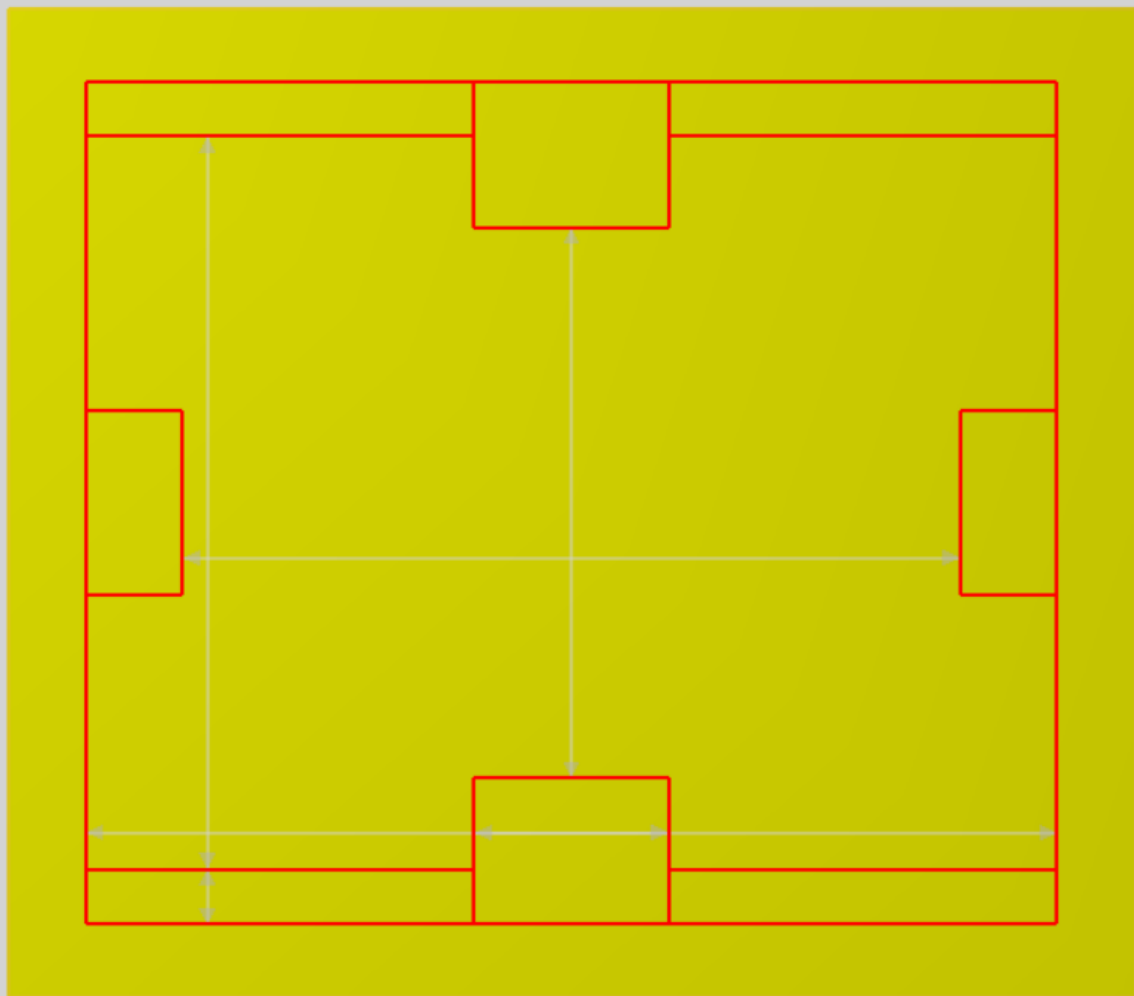

Protective Support Tray – G1150



Protective Support Tray – G1150



Protective Support Tray – G1150



Protective Support Tray – G1150



Protective Support Tray – G1150



other solutions



Create Arrange Cut Admin Help

Templates Design

Text Autoload
Draw Image
Clipart Import

ArtView

Standard Corner Zoom
Inside Cut Add Mat Layout
Four Borders
Input Mode view Layer Finish Options

Dynamic V-Cradle Book Support – G1130

Template: G1130

Height	Width
210.0 mm + -	297.0 mm + -
Border Bottom	Border Top
50.0 mm + -	80.0 mm + -
Angle	Distance
120 + -	50.0 mm + -

Create Cancel

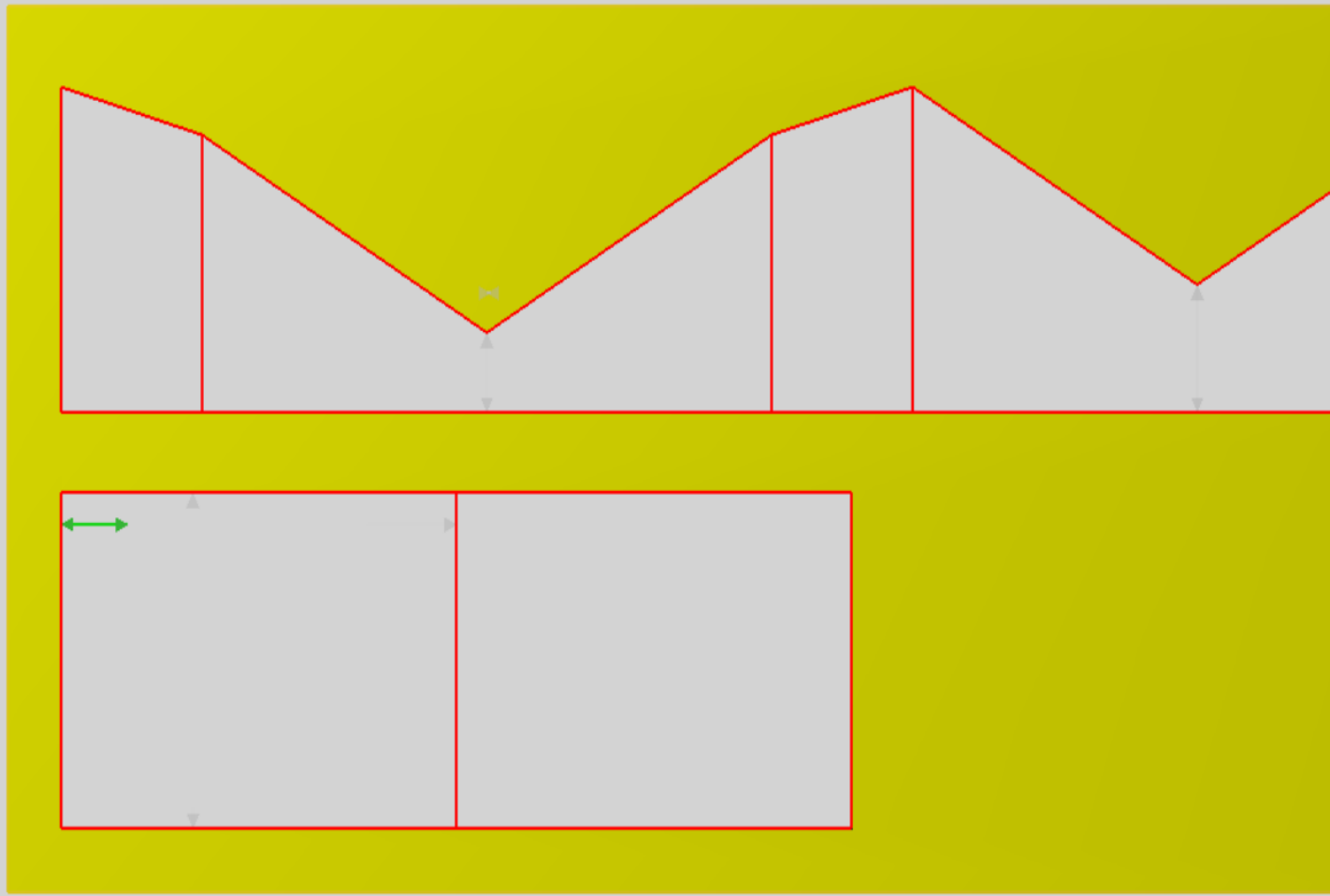

Dynamic V-Cradle Book Support – G1130



Dynamic V-Cradle Book Support – G1130

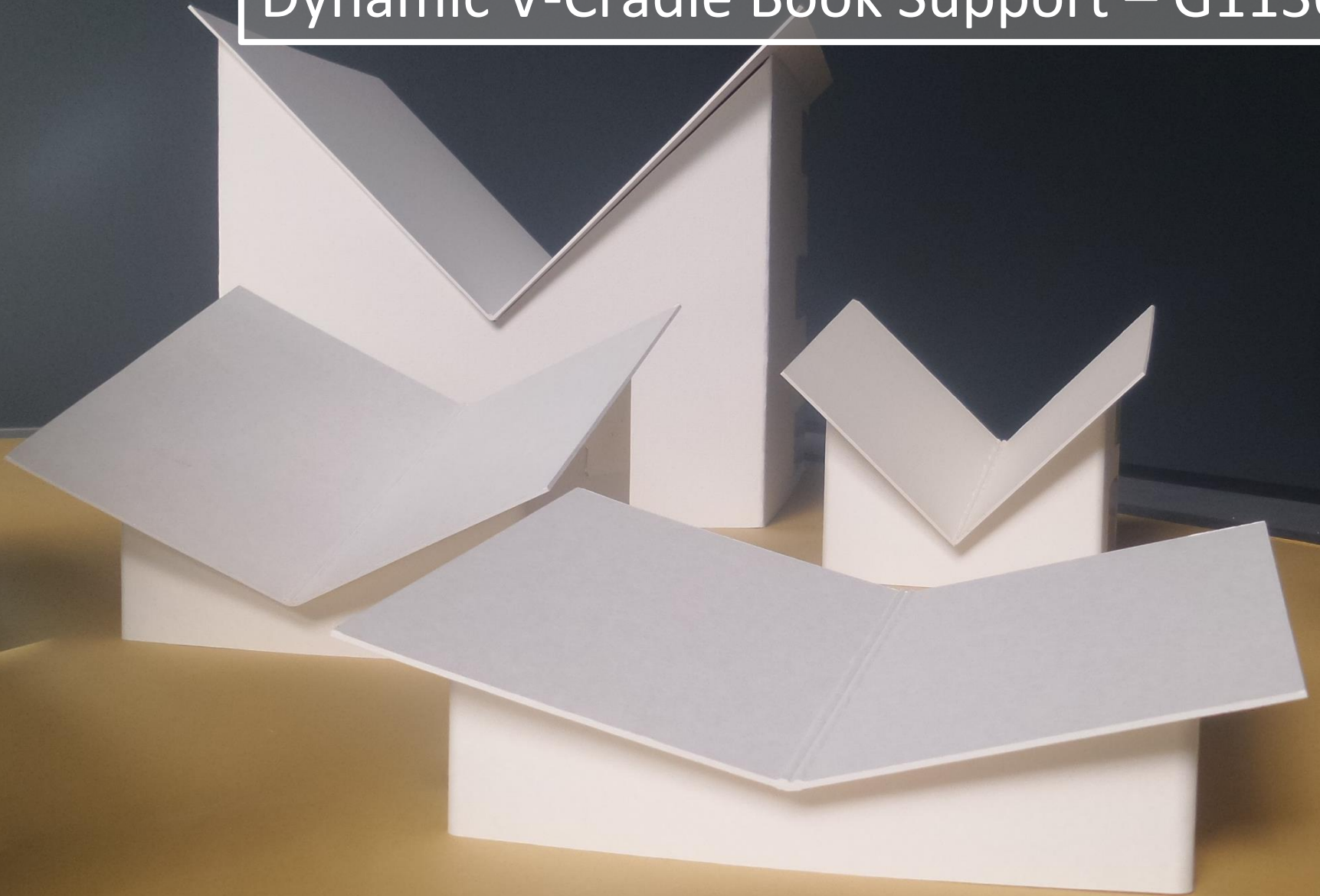



Create Arrange Cut Admin Help

Templates Design

Text Autoload Image ArtView

Draw Clipart Import

Standard

Inside Out

Four Borders

Input Mode

Corner Zoom

Auto Auto

Reset View

View Layer Finish Options

Internal Book Support – G1010



Template: G1010

Gap Width	Gap Length
8.000 Inch + -	10.000 Inch + -
Depth	Width
2.000 Inch + -	11.000 Inch + -
Height	Mat Thickness
14.000 Inch + -	2.000 Inch + -

Create Cancel

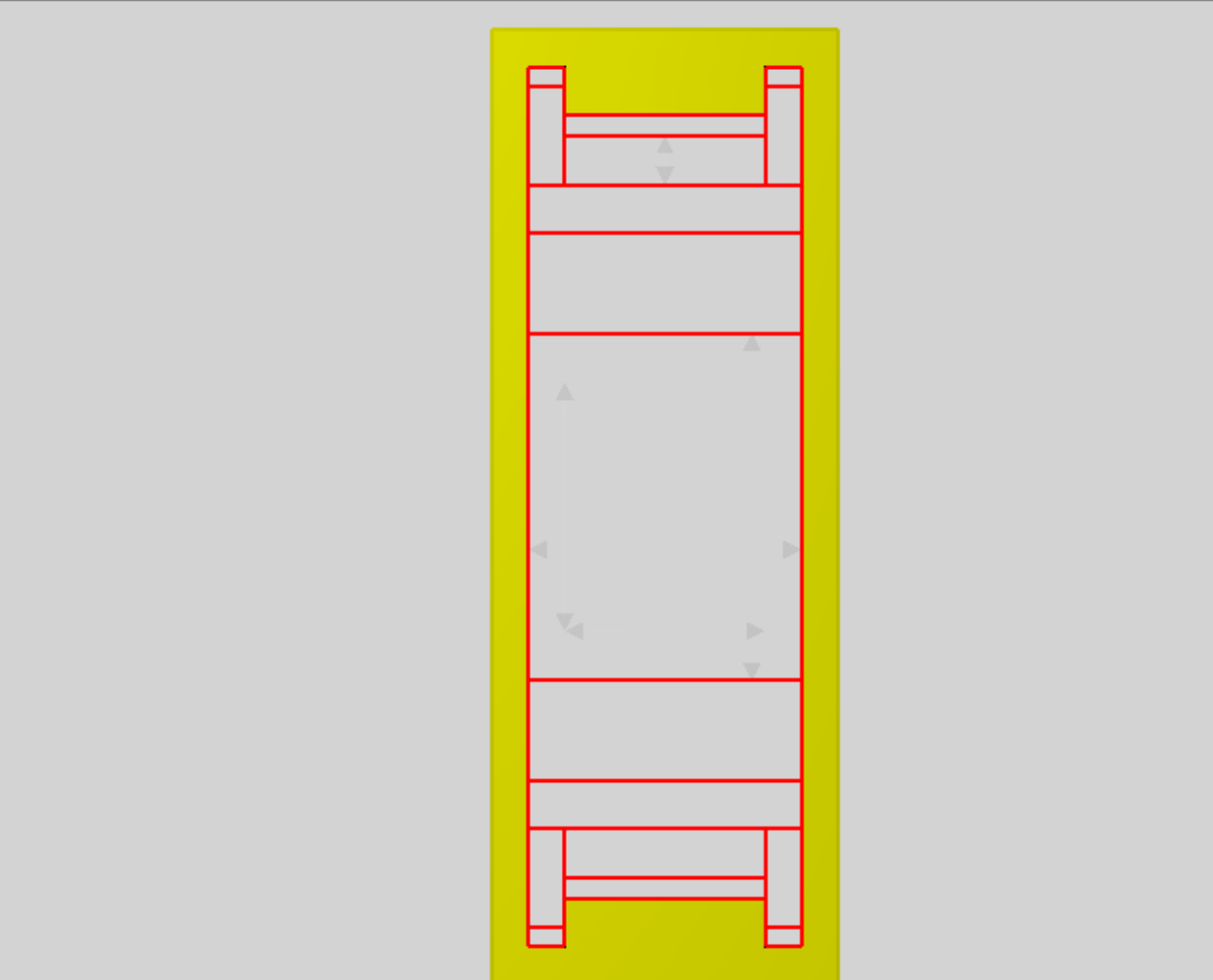

Internal Book Support – G1010

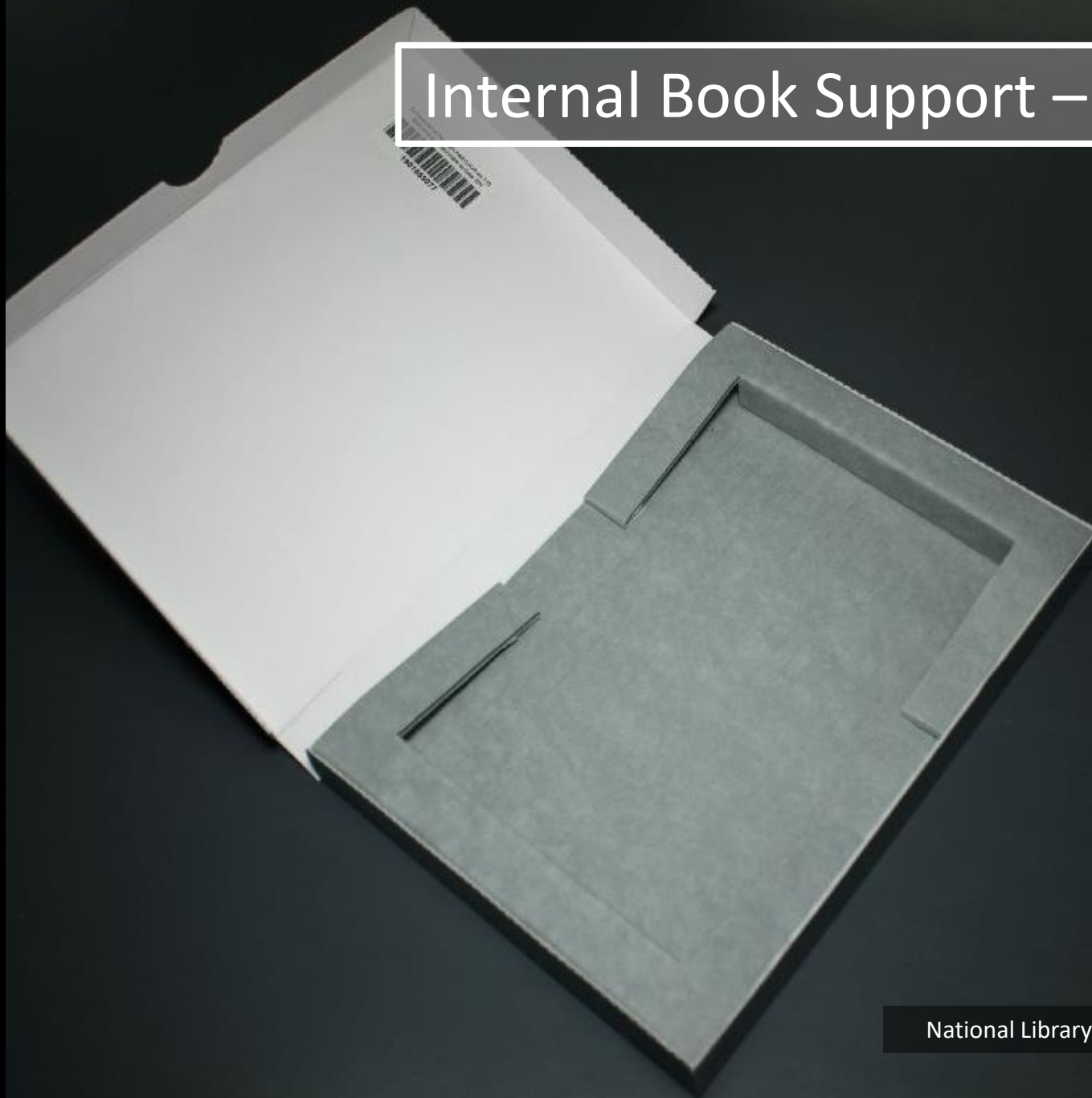



Create Arrange Cut Admin Help

Templates
Text
Autoload
ArtView
Standard
Corner Zoom
C3
Add Mat Layout

Draw
Image
Inside Out
Auto Zoom
Next
Direct Cut

Clipart
Import
Four Borders
Reset View
Layer
Finish Options

Design Input Mode View Layer Finish Options



Template: G1050

Diameter	Front Lobe
200.0 mm + -	30.0 mm + -
Length	Gap Width
800.0 mm + -	3.0 mm + -
Mat Thickness	Side Length
1.4 mm + -	346.4 mm + -

Create Cancel

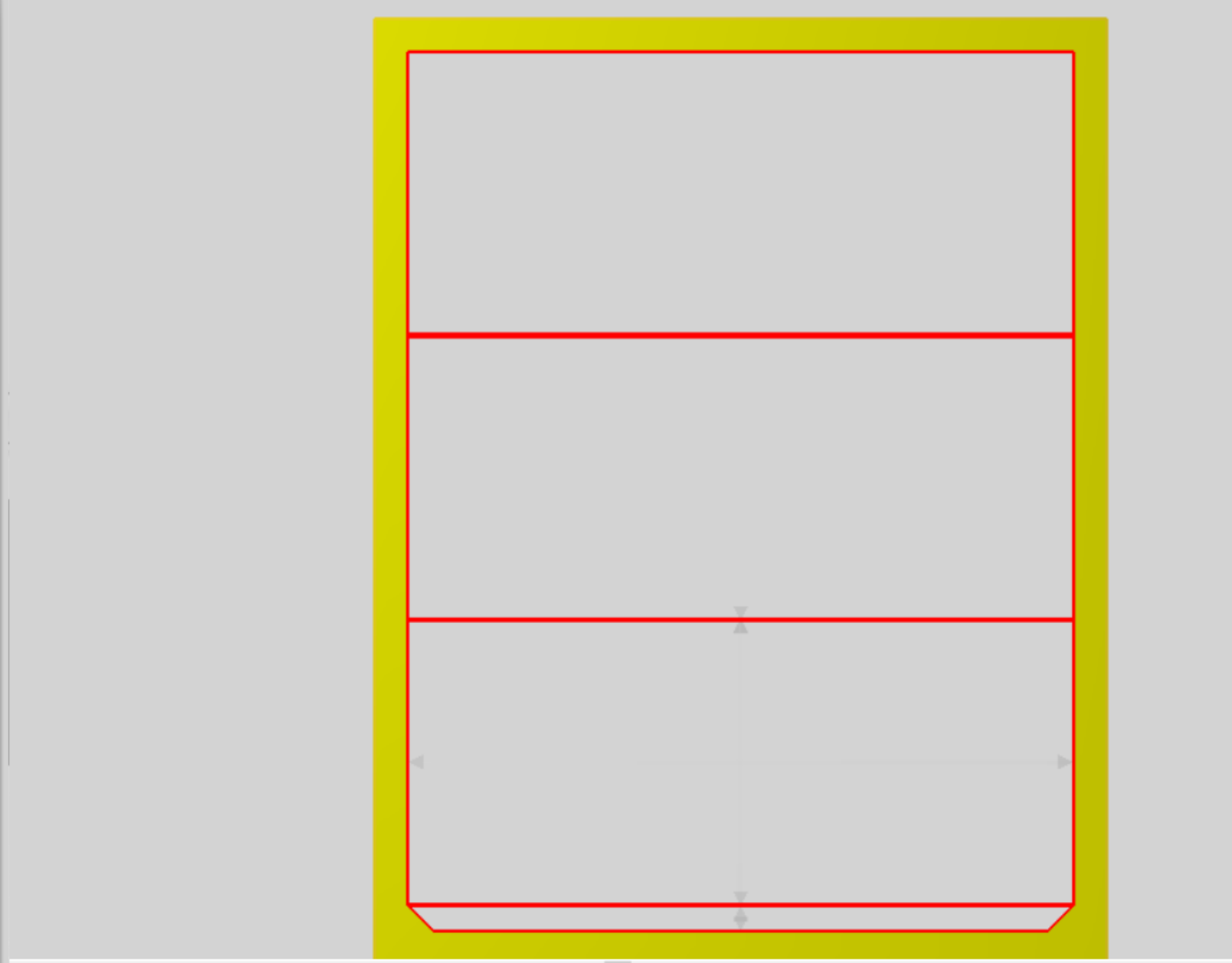



Create Arrange Cut Admin Help

Design: Templates, Text, Autoload, Draw, Image, Clipart, Import, ArtView

Input Mode: Standard, Inside Out, Four Borders

View: Corner Zoom, Auto Zoom, Reset View

Layer: C3

Finish Options: Add Mat Layout, Next, Direct Cut

Template: G1060

Diameter	200.0 mm	+	-
Mat Thickness	3.0 mm	+	-
Gap Width	3.0 mm	+	-
Side Lobe	50.0 mm	+	-
Front Lobe	50.0 mm	+	-
TabLength	80.0 mm	+	-
TabHeight	6.3 mm	+	-

Slots

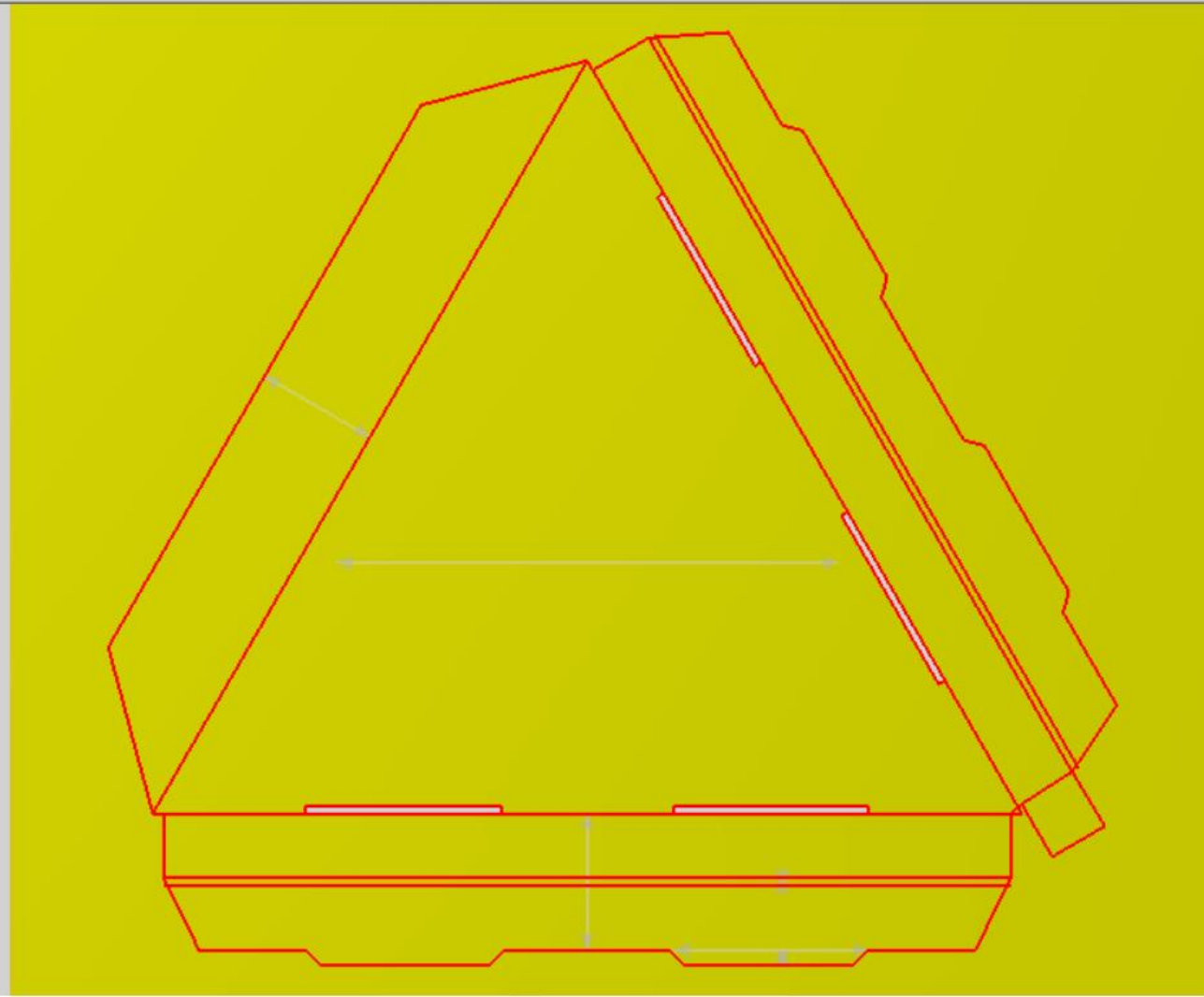

Create Cancel





THANK YOU!