

PRODUCT CATALOGUE

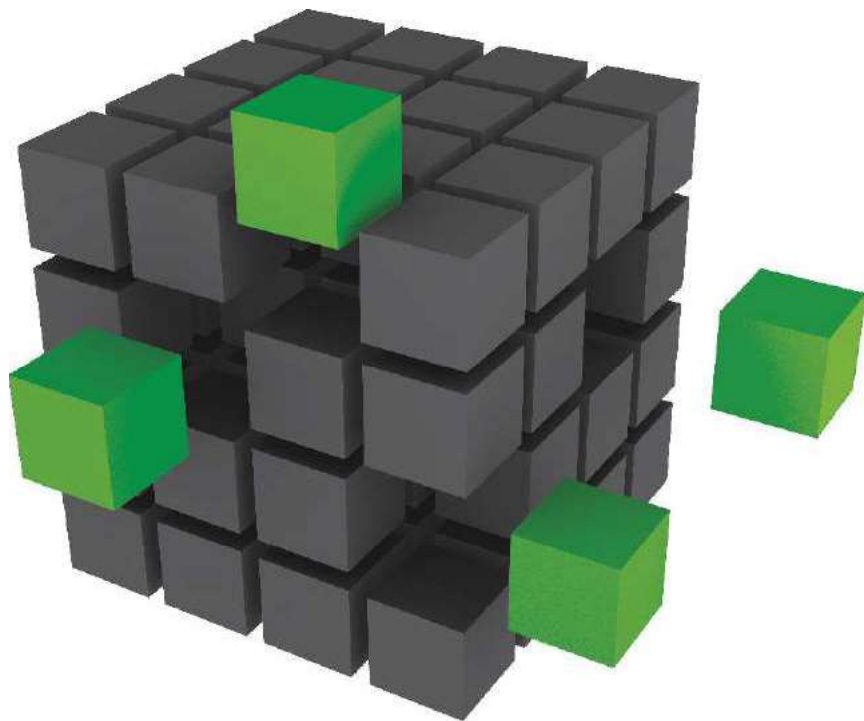

Timers | Time Switches | Hour Meters & Counters | Logic Controllers | Power Supplies |
Converters & Transducers | Isolated Relay Modules | Monitoring Devices |
Temperature Controllers | Process Indicators | Alarm Annunciators

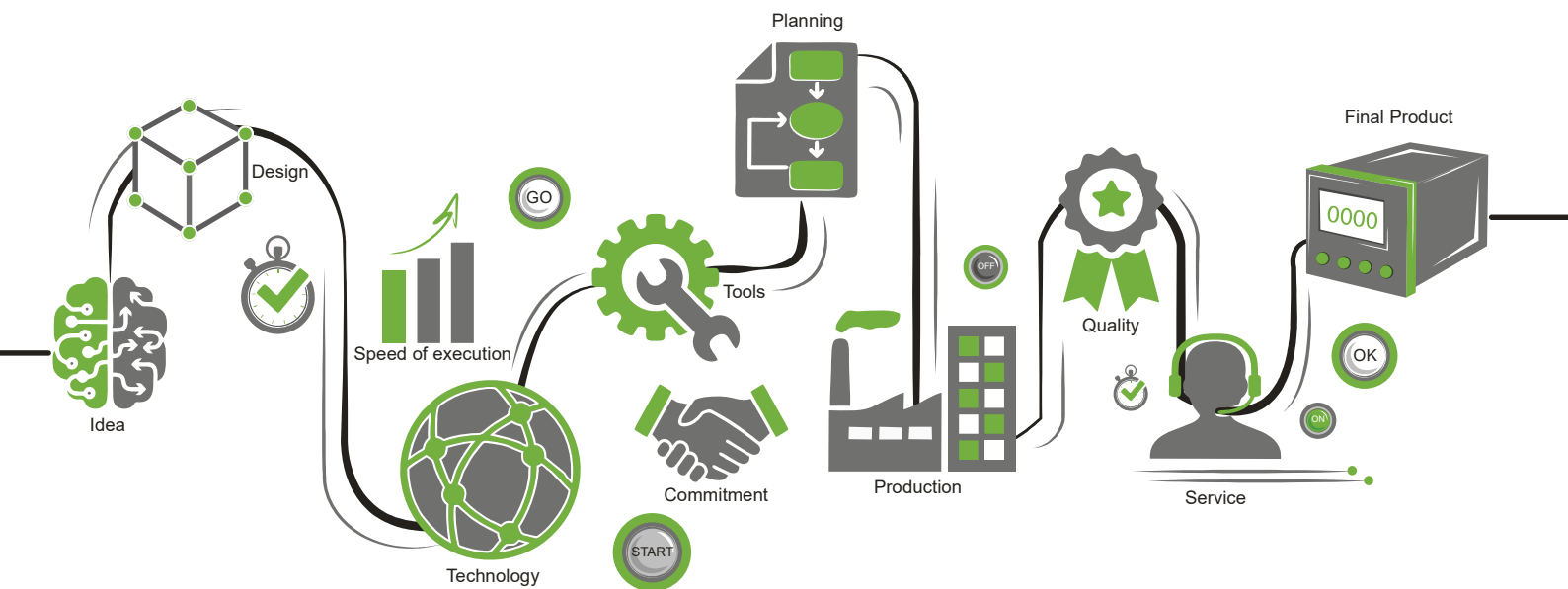

ABOUT GIC

Established in 1972, General Industrial Controls Private Limited (GIC) located in Pune, India, manufactures Process Control, Automation and Instrumentation products. GIC was the first company to launch Time Switches and Timers in India.

What started as a small venture four decades back, is now a company that offers an array of world-class products. With relentless focus on customer satisfaction, GIC has successfully innovated and continuously improved their capabilities to build a product portfolio that embodies finesse and excelled quality.

Today, we are an ISO 9001:2015, IATF 16949 certified organization with state-of-the-art plants having integrated facilities for everything from 'design to delivery' under one roof.

Our high performance products for Process Control and Automation application, together with our ingenious tooling and component manufacturing solutions, have garnered us an excellent reputation world over.



I N D E X

CONTENTS

PAGE NOS.



TIMERS

07

Digital Timer <i>Elvo</i> [®]	08-16
Electronic Timer - Series Staircase	17-19
 Electronic Timer - Series Micon [®] 175	20-28
Electronic Timer - Series Micon [®] 225	29-41
Motor Control Timers	42-48
Synchronous Timer - Series EM 1000	49-50
Product Selection Chart: Timers	51



TIME SWITCHES



53

Time Switch FM Series	54-55
 Digital Time Switch <i>Crono</i> ^{® Pro}	56-57
 Digital Time Switch <i>Astro</i> ^{® Pro}	58-60
Digital Time Switch <i>Astro</i> [®]	61-63
Lighting Automation with <i>Astro</i> [®] Using GSM Technology	64-66



HOUR METERS & COUNTERS



67

Hour Meter Series HM 36	68-73
 Hour Meter Series HR 26	74-75
Digital Hour Meters	76-78
Impulse Counter Series CR 18	79-81
 Impulse Counter Series CR 26	82-88
Impulse Counter Series CR 36	91-92
Digital Counters	93-95
Digital Hour Meter & Counter	96-98
Rate Indicator & Totaliser	99-101



CONTROLLERS

103

Programmable Logic Controllers	
Smart Relay <i>Genie</i> [™] - <i>MX</i>	104-108
 Mini PLC PL - 100	109-113
 GSM Alarm Modem	114-116
GSM Controller	117-119













CONVERTERS AND TRANSDUCERS

121

Protocol Converters	
<i>Lynx+</i> Gateway	122-124
Interface Converters	
USB to RS232 / RS485 / RS422 Converter	125-126
RS232 to RS485 / RS422 Converter	127-128
Signal Transducers	129-131

I N D E X

	CONTENTS	PAGE NOS.
	ISOLATED RELAY MODULES	133
	Isolated Relay Output Module	134-136
	POWER SUPPLIES	137
	Switched Mode Power Supply	138-140
	MONITORING DEVICES	141
	Voltage Monitoring Series	
	 SM 800	142-144
	 SM 175	145-151
	SM 301	152-153
	SM 500	154-159
	SM 501	160-164
	Product Selection Chart: Voltage Monitoring	165
	Three Phase Indicator	166-167
	Frequency Monitoring Series PD 225	168-169
	Current Monitoring Series	
	 Earth Leakage Relay	170-177
	CMR - Current Control	178-182
	Temperature Monitoring Series	
	PTC Thermistor Relay Series PD 225	183-184
	PTC Thermistor & Single Phasing Preventer Series PD225	185-187
	Equipment Room Temperature Control Relay	188-190
Level Monitoring Series		
Liquid Level Controller	191-195	
	TEMPERATURE CONTROLLERS	197
	 Advanced PID Temperature Controller Series PR 69	198-207
	Basic Temperature Controller Series PR 43	208-213
	Product Selection Chart - Temperature Controllers	214
	PT-100 Temperature Control Relay	215-217
	Temperature Control Relay	218-220
	 PROCESS INDICATORS	221-224
	ALARM ANNUNCIATORS	225-230





TIMERS

Digital Timer *Eliso*[®] 17.5 mm

Programmable Digital Timer *Eliso*[®]

Electronic Timer - Series Staircase

Electronic Timer - Series Micon[®] 175

Electronic Timer - Series Micon[®] 225

Motor Control Timers

Synchronous Timer - Series EM 1000

Product Selection Chart: Timers



Digital Timer *Eliro*[®]

- Compact 17.5 mm Wide
- Multi-Function: (8 or 18) Non-Signal & Signal based functions
- Multi-Voltage: 24 - 240 VAC/DC
- Wide Timing Range: 0.1s to 999 Hr
- 3 Digit LCD for Preset time and Run time
- Option to select Up/Down counting
- Tamper proof with key lock feature





Ordering Information

Cat. No.	Description
V0DDTS	24 - 240 VAC/DC, Multi-Function Digital Timer - Eliro (8 Functions), 1 C/O
V0DDTD	24 - 240 VAC/DC, Multi-Function Digital Timer - Eliro (8 Functions), 2 NO
V0DDTS1	24 - 240 VAC/DC, Multi-Function Digital Timer - Eliro (18 Functions), 1 C/O
V0DDTD1	24 - 240 VAC/DC, Multi-Function Digital Timer - Eliro (18 Functions), 2 NO

Digital Timer *Eliso*[®]



Cat. No.	V0DDTS	V0DDTD	V0DDTS1	V0DDTD1	
Parameters					
Timer Description	Multi Function Digital Timer				
Functions	1) ON Delay 2) Cyclic OFF/ON 3) Cyclic ON/OFF 4) Signal ON/OFF 5) Signal OFF Delay 6) Interval 7) Signal OFF/ON 8) One Shot Output		1) ON Delay 2) Cyclic OFF/ON 3) Cyclic ON/OFF 4) Impulse on Energizing 5) Accumulative Delay on Signal 6) Accumulative Delay on Inverted Signal 7) Accumulative Impulse on Signal 8) Signal ON Delay 9) Inverted Signal ON Delay 10) Signal OFF Delay 11) Impulse ON/OFF 12) Signal OFF/ON 13) Leading Edge Impulse 1 14) Leading Edge Impulse 2 15) Trailing Edge Impulse 1 16) Trailing Edge Impulse 2 17) Delayed Impulse 18) Inverted Signal ON Delay		
Supply Voltage (φ)	24 - 240 VAC/DC				
Supply Variation	-15% to +10% (of φ)				
Frequency	50/60 Hz				
Power Consumption (Max.)	0.5 VA (@ 24/48 VAC), 4 VA (@ 110 to 265 VAC/DC)				
Timing Range	0.1s to 999h				
Reset Time	200 ms (Max.)				
Repeat Accuracy	± 0.5%				
Output	Relay Output	1 C/O	2 NO	1 C/O	2 NO
	Contact Rating	8A @ 240 VAC / 24 VDC (Resistive)			
	Electrical Life	1x10 ⁵			
	Mechanical Life	2x10 ⁷			
Utilization Category	AC - 15	Rated Voltage (Ue): 120/240 V, Rated Current (Ie): 3/1.5 A			
	DC - 13	Rated Voltage (Ue): 125/250 V, Rated Current (Ie): 0.22/0.1 A			
Operating Temperature	-10° C to +55° C				
Storage Temperature	-20° C to +65° C				
Humidity (Non Condensing)	95% (Rh)				
LED Indication	Red LED → Relay ON				
Enclosure	Flame Retardant UL94-V0				
Dimension (W x H x D) (in mm)	18 X 85 X 76				
Weight (unpacked) Approx.	85 g				
Mounting	DIN Rail				
Certification	  				
Degree of Protection	IP 20 for Terminals, IP 30 for Enclosure, IP 40 for Front side				

EMI / EMC

Harmonic Current Emissions	IEC 61000-3-2
ESD	IEC 61000-4-2
Radiated Susceptibility	IEC 61000-4-3
Electrical Fast Transients	IEC 61000-4-4
Surges	IEC 61000-4-5
Conducted Susceptibility	IEC 61000-4-6
Voltage Dips & Interruptions (AC)	IEC 61000-4-11
Voltage Dips & Interruptions (DC)	IEC 61000-4-29
Conducted Emission	CISPR 14-1
Radiated Emission	CISPR 14-1

Environmental

Cold Heat	IEC 60068-2-1
Dry Heat	IEC 60068-2-2
Vibration	IEC 60068-2-6
Repetitive Shock	IEC 60068-2-27
Non-Repetitive Shock	IEC 60068-2-27

Digital Timer *Eliso*[®]



FUNCTIONAL DIAGRAMS FOR V0DDTS & V0DDTD

⏻ : Supply Voltage, S: Input Signal, R: Relay Output
T: Preset Time, TON: Preset ON Time, TOFF: Preset OFF Time

ON DELAY (A)

On application of supply voltage, the preset time duration (T) starts. On completion of the preset time, the output is switched ON and remains ON till the supply voltage is present.



CYCLIC OFF/ON {OFF Start, (Sym, Asym)} (b)

On application of supply voltage, the output is initially switched OFF for the preset 'OFF' time duration (TOFF) after which it is switched ON for the preset 'ON' time duration (TON). This cycle repeats and continues till the supply is present.



CYCLIC ON/OFF {ON Start, (Sym, Asym)} (C)

On application of supply voltage, the output is initially switched ON for the preset 'ON' time duration (TON) after which it is switched OFF for the preset 'OFF' time duration (TOFF). This cycle repeats and continues till the supply is present.

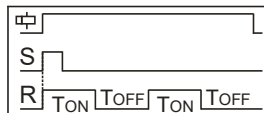

SIGNAL ON/OFF (d)

The output relay is turned ON for Preset Time (T) whenever the Signal(S) is applied or removed.

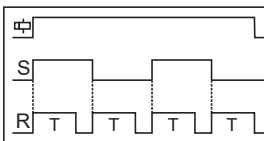

SIGNAL OFF DELAY (E)

On application of supply voltage and input signal, the output is switched ON. When the signal is removed the preset time duration commences & the output is switched OFF at the end of the time duration.

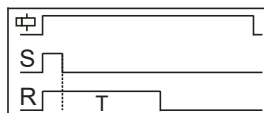

INTERVAL (F)

When supply power is applied to the timer and on application of input signal the output is immediately switched ON. The output remains ON for the preset time duration (T) after which it is switched OFF.

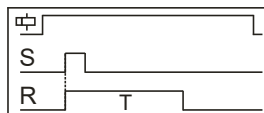

SIGNAL OFF / ON (G)

When Signal (S) is applied or removed, the relay changes its state after Timer Duration (T)

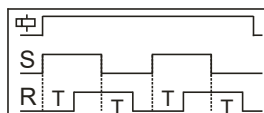

ONE SHOT OUTPUT (H)

When Signal (S) is applied, the Timer Duration (T) starts. At the end of Timer duration (T), the relay gets energized for approximately 1 sec. (Refer Note : 2)

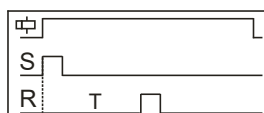

- Note:
1. For Power-On operation, connect the terminal B1 to A1 permanently.
 2. If the Signal (S) changes during the Timer Duration (T), it does not change the output relay but re-triggering takes place and the Timer Duration is extended.

Digital Timer *Eliso*[®]



FUNCTIONAL DIAGRAMS FOR V0DDTS1 & V0DDTD1

⊕: Supply Voltage, S: Input Signal, R: Relay Output
T: Preset Time, TON: Preset ON Time, TOFF: Preset OFF Time

ON DELAY [0]

On application of supply voltage, the preset time duration (T) starts. On completion of the preset time, the output is switched ON and remains ON till the supply voltage is present.

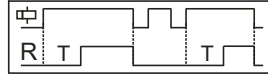

CYCLIC OFF/ON {OFF Start, (Sym, Asym)} [1]

On application of supply voltage, the output is initially switched OFF for the preset 'OFF' time duration (TOFF) after which it is switched ON for the preset 'ON' time duration (TON). This cycle repeats and continues till the supply is present.



CYCLIC ON/OFF {ON start, (Sym, Asym)} [2]

On application of supply voltage, the output is initially switched ON for the preset 'ON' time duration (TON) after which it is switched OFF for the preset 'OFF' time duration (TOFF). This cycle repeats and continues till the supply is present.



IMPULSE ON ENERGIZING [3]

On application of supply voltage, the output is instantly switched ON for the preset time duration (T) after which it is switched OFF.

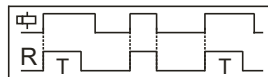

ACCUMULATIVE DELAY ON SIGNAL [4]

On application of supply voltage, the preset timing duration commences. When input signal is applied, the timing pauses and resumes only when the input signal is removed. The output is switched ON at the end of the preset time duration (T).

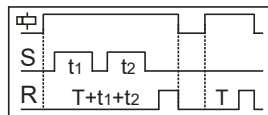

ACCUMULATIVE DELAY ON INVERTED SIGNAL [5]

On application of supply voltage and input signal, the preset timing duration commences. When the signal is removed the timing pauses and resumes when the signal is applied. The output is switched ON at the end of the preset time duration (T).

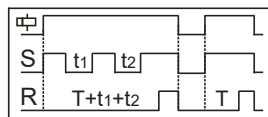

ACCUMULATIVE IMPULSE ON SIGNAL [6]

On application of supply voltage the output is switched ON & the preset timing duration commences. When the signal is applied the timing pauses and resumes when the signal is removed. The output is switched OFF at the end of the preset time duration (T).

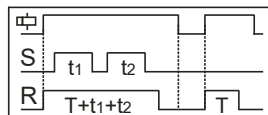

SIGNAL ON DELAY [7]

On application of input signal, the preset time duration (T) starts. On completion of the preset time, the output is switched ON and remains ON till the input signal is present.

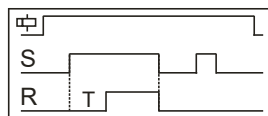

INVERTED SIGNAL ON DELAY [8]

On application of supply voltage, the preset time duration (T) starts. When input signal is applied, the timing pauses & resumes only when the signal is removed. On completion of the preset time, the output is switched ON.

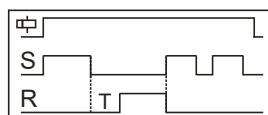

SIGNAL OFF DELAY [9]

On application of supply voltage and input signal, the output is switched ON. When the signal is removed the preset time duration commences & the output is switched OFF at the end of the time duration.

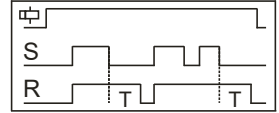

IMPULSE ON/OFF [A]

On application or removal of input signal, the output is switched ON & the preset time duration (T) starts. On completion of the time duration the output is switched OFF. When timing commences, changing the state of the input signal resets the time.

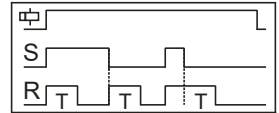

SIGNAL OFF/ON [b]

On application of input signal, the preset delay time period (T) starts. On completion of the preset time, the output is switched ON. On removal of input signal, the preset time period starts again and the output is switched ON when the preset time duration is complete.

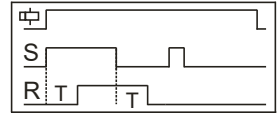

LEADING EDGE IMPULSE1 [C]

On application of input signal the output is immediately switched ON. The output remains ON for the preset time duration (T) after which it is switched OFF. If the input signal is removed during the preset time, the output remains unaffected.

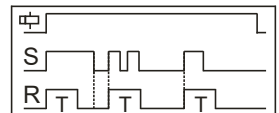

LEADING EDGE IMPULSE2 [d]

On application of input signal the output is immediately switched ON. The output remains ON for the preset time duration (T) after which it is switched OFF. If the input signal is removed during the preset time, the output is immediately switched OFF.

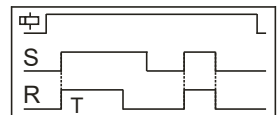

TRAILING EDGE IMPULSE1 [E]

When the input signal to the timer is removed, the output is immediately switched ON for the preset time duration (T) after which it is switched OFF. If the input signal is applied during the preset time, the output is immediately switched OFF.

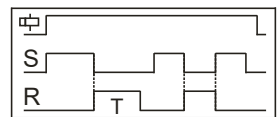

TRAILING EDGE IMPULSE2 [F]

When the input signal to the timer is removed, the output is immediately switched ON for the preset time duration (T) after which it is switched OFF. If the input signal is applied during the preset time, the output remains unaffected.

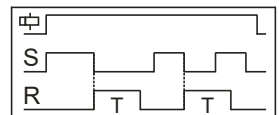

DELAYED IMPULSE [G]

On application of input signal, the preset 'OFF' time duration (TOFF) starts. the output is switched ON at the end of the preset 'OFF' time duration & the preset 'ON' time duration commences irrespective of signal level and remains ON till the completion of 'TON'.

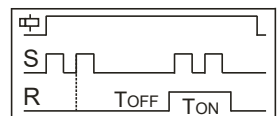

INVERTED SIGNAL ON DELAY-TYPE 2 [H]

Timing starts only upon signal 'S' transition high to low. During timing or after completion of Time (i.e. relay on), any signal transition is ignored. To reset the timer supply has to be interrupted.

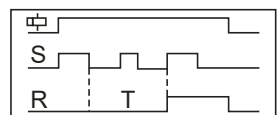

Programmable Digital Timer *Eliro*[®]

- Digital 7-Segment display
- Supply Voltage range of 110-240 VAC
- Input Signal Sensing range of 85-265 VAC/100-265 VDC & 20-60 VAC/DC
- Inbuilt library of 35 functions covering majority applications
- Easy steps to program customized functions
- Suitable for Panel and Base/DIN mounting
- Two Independent Channel outputs with selectable Timer modes
- Wide timing range - 0.1 Sec. to 999 Days
- Tamper proof with key lock feature
- Provision to edit Preset time during Run time
- Provision to save two independent functional Profiles (P1 & P2)





Ordering Information

Cat. No.	Description
V7DFTS3	110 - 240 VAC, Multi Function Digital Timer - Eliro (35 Functions), 2 C/O
V7DDSS3	110 - 240 VAC, Multi Function Digital Timer - Eliro (35 Functions), 2 C/O, 11 Pin

Programmable Digital Timer *Eliso*[®]



Cat. No.	V7DFTS3	V7DDSS3
Parameters	Programmable Multi Function Digital Timer	
Timer Description	Programmable Multi Function Digital Timer	
Default Functions	1) On delay 2) On delay constant supply type 2 3) On delay constant supply type 3 4) On delay (control switch resettable) 5) Signal on delay 6) Inverted signal on delay 7) Inverted signal on delay type 2 8) Signal off delay 9) Off delay const. supply type 2 10) Cyclic on/off 11) Cyclic off/on 12) Asymmetric cycle pulse start 13) Asymmetric recycler pulse start type 2 14) Signal on off delay 15) Signal on off delay type 2 16) Signal off/on (new) 17) Impulse on energizing	18) Impulse on/off 19) Accumulative delay on signal 20) Accumulative delay on inverted signal 21) Accumulative impulse on signal 22) Leading edge impulse 23) Leading edge impulse 2 24) Trailing edge impulse 25) Trailing edge impulse 2 26) Delayed impulse 27) Delayed impulse type 2 28) Delayed pulse (constant supply) 29) Delayed pulse (remote trig.) 30) Delayed pulse (const. supply type 1) 31) On pulse (control switch resettable) 32) On pulse (supply reset)mode 33) Leading edge bi-stable or step relay 34) Forward - Reverse Mode with total time 35) Forward - Reverse Mode without total time
Supply Voltage (φ)	110 - 240 VAC	
Supply Variation	-20% to +10% (of φ)	
Frequency	47-63 Hz	
Power Consumption (Max.)	9 VA	
Timing Range	0.1s to 999 days	
Reset Time/Initiate Time	200 ms (Max.) / 100 ms (Max.)	
Input Signals/Signal Isolation	High Range: 85-265V AC/ 100-265V DC, Low Range: 24-60V AC/DC / 2 KV	
Signal Sensing Time/ Wait Period	50ms. (max.) / 100ms @ Power On & for signal based modes only.	
Timing Accuracy	± 0.01%	
Output	Relay Output	2 C/O
	Contact Rating	5A for NO & 3A for NC @ 250VAC/30VDC (Resistive.)
	Electrical Life	1x10 ⁵
	Mechanical Life	5x10 ⁶
Utilization Category	AC - 15	250V AC/2A, Cos φ = 0.6, 85°C, 100000 Operations.
	DC - 13	Ue rated voltage V – 24; Ie rated current A – 2.0.
Operating Temperature	-5° C to +55° C	
Storage Temperature	-10° C to +60° C	
Humidity (Non Condensing)	95% (Rh)	
LED Indication	SV (Red) - Set Value; P1/P2 (Red) -P1 Running; Up/Down (Red)-Up Counting; SG (Green)- Signal Present;OP1 (Red)-Relay OP1 ON;OP2 (Red)-Relay OP2 ON;	
Dimension (W x H x D) (in mm)	48 X 48 X 92.5	
Weight (unpacked)	160 g	
Mounting	Panel / Flush Mountable	Base / DIN Rail with 11 Pin socket
Certification	  	
Degree of Protection	IP 20 for Terminals, IP 30 for Enclosure, IP 40 for Front side	
EMI / EMC		
Harmonic Current Emissions	IEC 61000-3-2	
ESD	IEC 61000-4-2	
Radiated Susceptibility	IEC 61000-4-3	
Electrical Fast Transients	IEC 61000-4-4	
Surges	IEC 61000-4-5	
Conducted Susceptibility	IEC 61000-4-6	
Voltage Dips & Interruptions (AC)	IEC 61000-4-11	
Voltage Dips & Interruptions (DC)	IEC 61000-4-29	
Conducted Emission	CISPR 14-1	
Radiated Emission	CISPR 14-1	
Environmental		
Cold Heat	IEC 60068-2-1	
Dry Heat	IEC 60068-2-2	
Vibration	IEC 60068-2-6	
Repetitive Shock	IEC 60068-2-27	
Non-Repetitive Shock	IEC 60068-2-27	

Programmable Digital Timer *Eliso*[®]



FUNCTIONAL DIAGRAMS

⊕ : Supply Voltage, S: Input Signal, R: Relay Output
 T: Preset Time, TON: Preset ON Time, TOFF: Preset OFF Time, T-a: Timing Break Before completion

ON DELAY [00]

On application of supply voltage, the preset time duration (T) starts. On completion of the preset time, the output is switched ON and remains ON till the supply voltage is present.

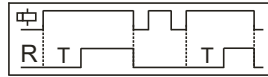

ON DELAY CONSTANT SUPPLY TYPE 2 [01]

Timing will commence when the supply is present and input signal is not applied. After the time period has elapsed, output is switched ON. If signal is applied then the timing period stops. Timing will restart only when signal is removed. Therefore there are two methods this timer can be controlled, either by application or removal of signal input and with the interruption of the supply voltage to the timer with signal removal.

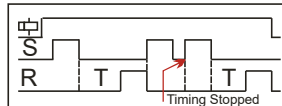

ON DELAY CONSTANT SUPPLY TYPE 3 [02]

A permanent supply is required. The timing period starts when the signal is applied and will continue irrespective of any further changes to signal input. After the time period has elapsed output is switched ON. Signal change has no effect during timing period. To reset the timer, signal must be removed and then applied.

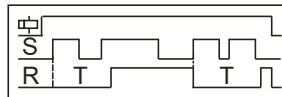

ON DELAY (CONTROL SWITCH RESETTABLE) [03]

When the supply is connected and signal is applied, the timing function starts. If signal is removed and applied during the preset timing then timing is restarted and output stays OFF. After preset time has elapsed the output is ON.

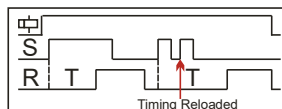

SIGNAL ON DELAY [04]

On application of input signal, the preset time duration (T) starts. On completion of the preset time, the output is switched ON and remains ON till the input signal is present.

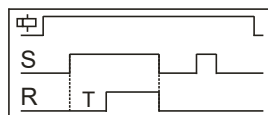

INVERTED SIGNAL ON DELAY [05]

On application of supply voltage, the preset time duration (T) starts. When input signal is applied, the timing pauses & resumes only when the signal is removed. On completion of the preset time, the output is switched ON.

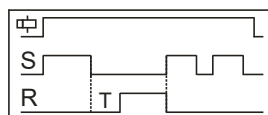

INVERTED SIGNAL ON DELAY-TYPE 2 [06]

Timing starts only upon signal 'S' transition high to low. During timing or after completion of Time (i.e. relay on), any signal transition is ignored. To reset the timer supply has to be interrupted.

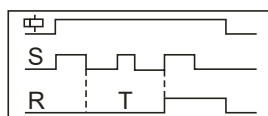

SIGNAL OFF DELAY [07]

On application of supply voltage and input signal, the output is switched ON. When the signal is removed the preset time duration commences & the output is switched OFF at the end of the time duration.

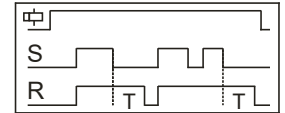

OFF DELAY CONST. SUPPLY TYPE 2 [08]

A permanent supply is required. When the input signal is applied the output is switched ON immediately. When input signal is removed the timing period starts. After the time period has elapsed output is switched OFF. Once the timing period has started further actions of input signal will have no effect. However once the timing cycle has been completed the process may be started again applying input signal. While the timer is executing the only way to reset the timer is to interrupt the supply.

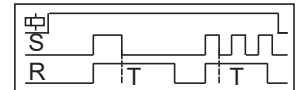

CYCLIC ON/OFF {ON start, (Sym, Asym)} [09]

On application of supply voltage, the output is initially switched ON for the preset 'ON' time duration (TON) after which it is switched OFF for the preset 'OFF' time duration (TOFF). This cycle repeats and continues till the supply is present.



CYCLIC OFF/ON {OFF Start, (Sym, Asym)} [10]

On application of supply voltage, the output is initially switched OFF for the preset 'OFF' time duration (TOFF) after which it is switched ON for the preset 'ON' time duration (TON). This cycle repeats and continues till the supply is present.



ASYMMETRIC CYCLE PULSE START [11]

A permanent supply is required. The timer function is triggered by the input signal. When input signal applied the output is switched ON while the first preset time period (TON) elapses. Once this time period (TON) has elapsed output is switched OFF for the second preset time (TOFF) period. Once this second time period (TOFF) had elapsed then output switched ON and the cycle will start from the beginning again. If input signal is removed during timing (TON or TOFF) the cycle will stop and output is switched OFF, cycle will start with output ON state when the input signal applied again

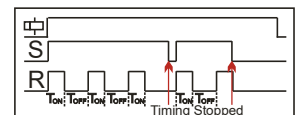

ASYMMETRIC RECYCLER PULSE START TYPE 2 [12]

A permanent supply is required. The timer function is triggered by input signal. When input signal is applied the output is switched OFF while the first preset time period (TOFF) elapses. Once this time period has elapsed output is switched ON for the second preset time period (TON). Once this second time period (TON) had elapsed then output is switched OFF and the cycle will start from the beginning again. If input signal is removed during timing (TON or TOFF) the cycle will stop and output is switched OFF, cycle will start with output OFF state when the input signal applied again.

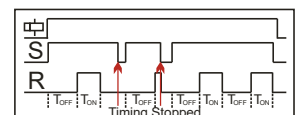

SIGNAL ON OFF DELAY [13]

On application of signal the preset time (T) starts. After this preset time has elapsed, output is switched ON. During this timing, if signal is removed then output is switched ON immediately and OFF delay is started. Once this time period has elapsed the output is switched OFF. During this OFF delay if signal is reapplied the output switched OFF immediately and ON Delay restarted.

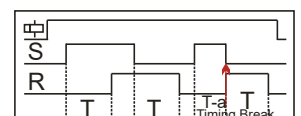

Programmable Digital Timer *Eliso*[®]



FUNCTIONAL DIAGRAMS

SIGNAL ON OFF DELAY TYPE 2 [14]

On application of signal the preset time (T) starts. After this preset time has elapsed, output is switched ON. During this timing, if signal is removed then output is switched ON immediately and preset timing is restarted. Removing the signal during this timing suspends timing but does not reset the time sequence. Timing will resume immediately when signal is applied. Therefore, total time taken before the delayed contact changes state is the preset time plus any time that the signal is removed. Once this time period has elapsed the output is switched OFF.

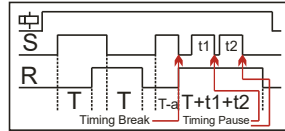

SIGNAL OFF/ON [15]

On application of input signal, the preset delay time period (T) starts. During this timing if signal is removed then timing is stopped and timing will be restarted when signal applied again. After this time period has elapsed output is switched ON. On removal of input signal, the preset time period starts again & the output is switched OFF when the preset time duration is complete. Output stays OFF until supply voltage has been interrupted.

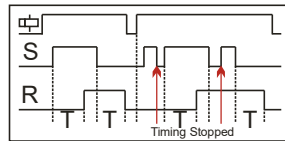

IMPULSE ON ENERGIZING [16]

On application of supply voltage, the output is instantly switched ON for the preset time duration (T) after which it is switched OFF.

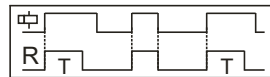

IMPULSE ON/OFF [17]

On application or removal of input signal, the output is switched ON & the preset time duration (T) starts. On completion of the time duration the output is switched OFF. When timing commences, changing the state of the input signal resets the time.

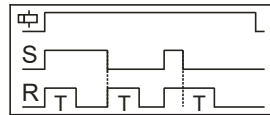

ACCUMULATIVE DELAY ON SIGNAL [18]

On application of supply voltage, the preset timing duration commences. When input signal is applied, the timing pauses and resumes only when the input signal is removed. The output is switched ON at the end of the preset time duration (T).

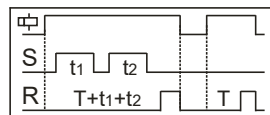

ACCUMULATIVE DELAY ON INVERTED SIGNAL [19]

On application of supply voltage and input signal, the preset timing duration commences. When the signal is removed the timing pauses and resumes when the signal is applied. The output is switched ON at the end of the preset time duration (T).

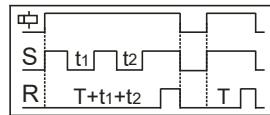

ACCUMULATIVE IMPULSE ON SIGNAL [20]

On application of supply voltage the output is switched ON & the preset timing duration commences. When the signal is applied the timing pauses and resumes when the signal is removed. The output is switched OFF at the end of the preset time duration (T).

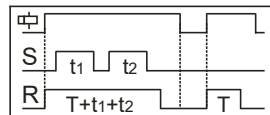

☐: Supply Voltage, S: Input Signal, R: Relay Output

T: Preset Time, TON: Preset ON Time, TOFF: Preset OFF Time

LEADING EDGE IMPULSE1 [21]

On application of input signal the output is immediately switched ON. The output remains ON for the preset time duration (T) after which it is switched OFF. If the input signal is removed during the preset time, the output remains unaffected.

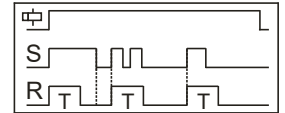

LEADING EDGE IMPULSE2 [22]

On application of input signal the output is immediately switched ON. The output remains ON for the preset time duration (T) after which it is switched OFF. If the input signal is removed during the preset time, the output is immediately switched OFF.

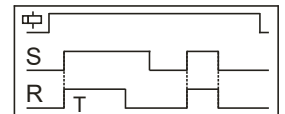

TRAILING EDGE IMPULSE1 [23]

When the input signal to the timer is removed, the output is immediately switched ON for the preset time duration (T) after which it is switched OFF. If the input signal is applied during the preset time, the output is immediately switched OFF.

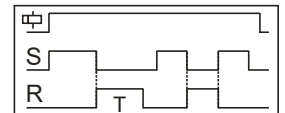

TRAILING EDGE IMPULSE2 [24]

When the input signal to the timer is removed, the output is immediately switched ON for the preset time duration (T) after which it is switched OFF. If the input signal is applied during the preset time, the output remains unaffected.

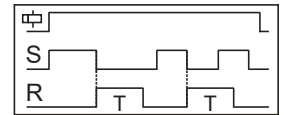

DELAYED IMPULSE [25]

On application of input signal, the preset 'OFF' time duration (TOFF) starts. the output is switched ON at the end of the preset 'OFF' time duration & the preset 'ON' time duration commences irrespective of signal level and remains ON till the completion of 'ToN'.

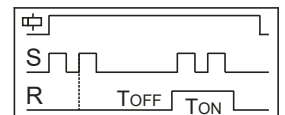

DELAYED IMPULSE TYPE 2 [26]

A permanent supply is required. When signal is applied the output will remain OFF while the first preset time period (TOFF) elapses. Once this time period has elapsed the output is switched ON for the second preset time period (TON). Once this second time period (TON) had elapsed then output is switched OFF and cycle stops. Output stays OFF until supply voltage has been interrupted. During timing period (TON or TOFF) if signal is removed then output is switched OFF and the cycle stops, cycle will start with output OFF state when the input signal applied again.

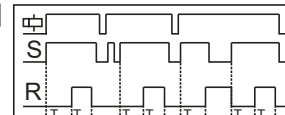

DELAYED PULSE (CONSTANT SUPPLY) POWER BASED [27]

The timing period (TOFF) starts when the supply is applied to the timer. After the preset has elapsed output is switched ON for the preset pulse (TON) duration. To reset the timer the supply has to be interrupted. If this interruption occurs during the pulsed output (TON) then the output is switched OFF and the timer will reset.

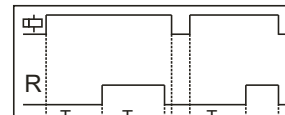

Programmable Digital Timer *Eliso*[®]



FUNCTIONAL DIAGRAMS

DELAYED PULSE (REMOTE TRIG.) [28]

The timing period (TOFF) will start when input signal is applied with the supply connected. After preset time (TOFF) has elapsed the output is switched ON for the per-selected pulse (TON) duration. To reset the timer either input signal needs to be removed or supply has to interrupt. If this action occurs during the pulsed output cycle (TON) then output is switched OFF and the timer will reset.

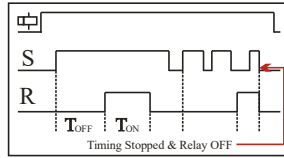

DELAYED PULSE (CONST. SUPPLY TYPE 1) [29]

Supply to the unit must be continuous. On application of input signal the time period 'TOFF' starts to run. On completion of 'TOFF', the relay output is switched ON immediately and the time period 'TON' starts to run. On completion of 'TON' the output is switched OFF. The input signal has no effect until 'TOFF' + 'TON' have completely expired.

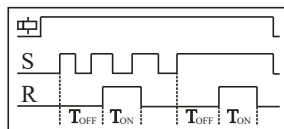

ON PULSE (CONTROL SWITCH RESETTABLE) / WATCH DOG TYPE [30]

When the supply is connected and signal is applied, output is switched ON and the timing function starts. If signal is removed and applied during the preset timing then timing is restarted and output stays ON. After preset time(TON) has elapsed the output is switched OFF

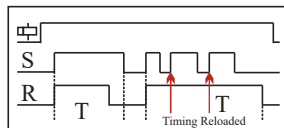

ON PULSE (SUPPLY RESET)[31]

On application of supply voltage the output is switched ON. The first pulse of input signal starts the preset time period. Receiving pulses during the time period extends it and output stays ON. Receiving no signal pulses during the time period completes it and output is switched OFF. Output stays OFF until supply voltage has been interrupted.

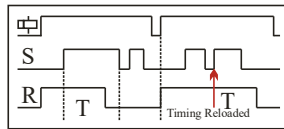

☐: Supply Voltage, S: Input Signal, R: Relay Output

T: Preset Time, TON: Preset ON Time, TOFF: Preset OFF Time

LEADING EDGE BI-STABLE OR STEP RELAY [32]

After every signal, the output contact changes their states, alternately switching from open to close and vice versa.

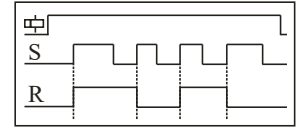

FORWARD- REVERSE MODE WITH TOTAL TIME [33]

On application of supply & input signal the pause time P starts after this output t1 is switched ON again it will take the pause time and output t2 is switched ON.

Note: This mode and total time duration should 'RELOAD' when Signal transition occurs From low to high. In this case, RELOAD means it restarts the cycle.

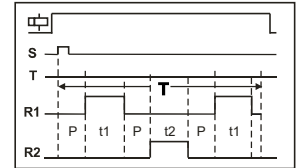



FORWARD- REVERSE MODE WITHOUT TOTAL TIME [34]

On application of supply & input signal the pause time P starts after this output t1 is switched ON again it will take the pause time and output t2 is switched ON. This mode will be continued, till the supply is Present to the device.

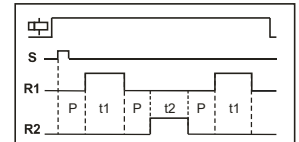
Note: This mode should 'RELOAD' when Signal transition occurs From low to high. In this case, RELOAD means it restarts the cycle.

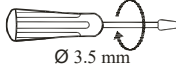

TERMINAL TORQUE & CAPACITY

	0.50 N.m (4.5 Lb.in)
	1 x 1.5 mm ² Solid/Stranded Wire
AWG	1 x 26 to 14

CONNECTION DIAGRAM

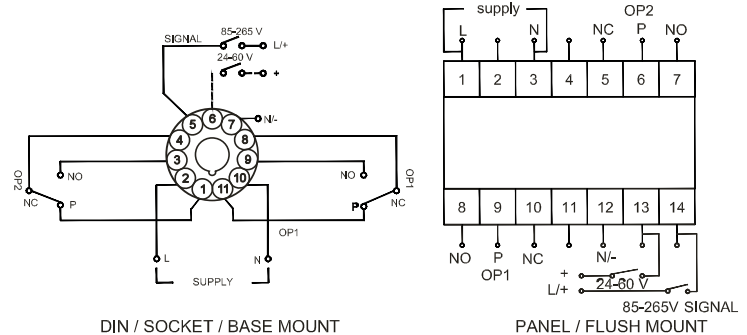

MOUNTING DIMENSIONS (mm)

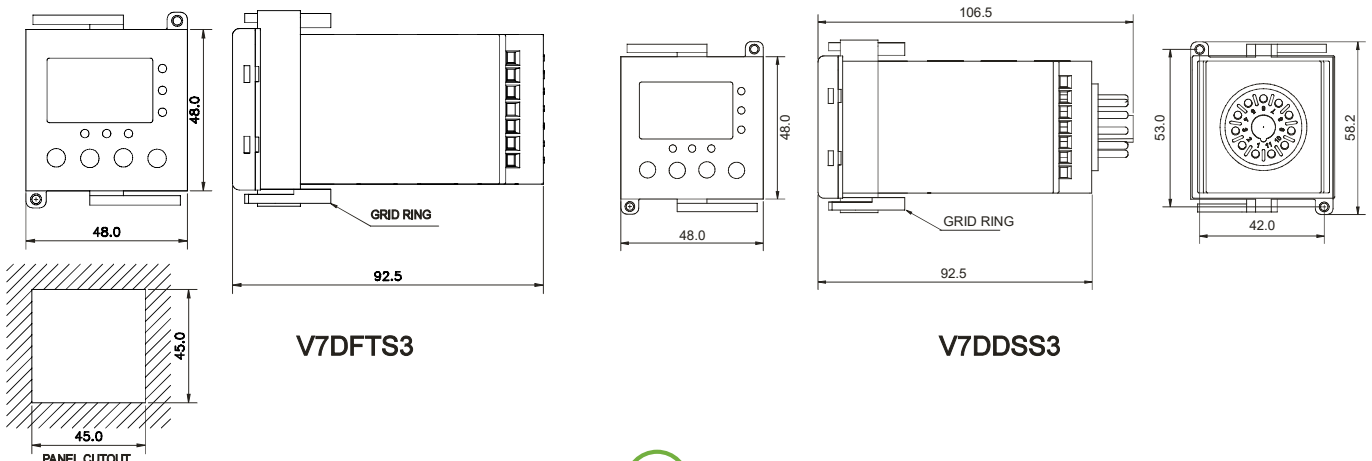

Electronic Timer - Series Staircase

- Multi-Function/Mono-Function Staircase Timer in compact 17.5mm
- Time Range: 0.5min - 20min
- Long Run mode with Time range from 0.5h - 20h
- Functions with Pre-Warning, Cut-Off & Release Delay
- Maintenance Mode available
- Switch indications (Glow-lamps / Pilot lamps) up to 50 mA
- 3 Wire & 4 Wire Configurations





Ordering Information

Casing Colour	Mode	Output Relay Contact
B Casing: White & Knob: Red	1 C Multi Mode	1 1 'NO', 16A, 120A/20ms (Peak Inrush Current)
C Casing: Dark Grey & Knob: Green	2 B Mono Mode	2 1 'NO', 16A, 80A/20ms (Peak Inrush Current)

* For Mono Mode the available mode is 'Timing Step with Release Delay & Cut-Off'

Electronic Timer - Series Staircase



Cat. No.	27B1C3B1	
Parameters	Staircase Timer	
Timer Description	Staircase Timer	
Modes	1) Staircase Relay 2) Staircase Relay with Pre-Warning 3) Staircase Relay with Cut-Off 4) Staircase Relay with Cut-Off & Pre-Warning 5) Timing Step with Release Delay & Cut-Off 6) Timing Step with Release Delay, Cut-Off & Pre-Warning 7) Long Run 8) Long Run with Pre-Warning 9) Step Relay 10) Permanent ON 11) Maintenance Mode	
Supply Voltage (Φ)	230 VAC	
Supply Variation	- 25% to +15% (of Φ)	
Frequency	50 Hz	
Power Consumption (Max.)	3 VA	
Timing Ranges	0.5m, 2m, 4m, 6m, 9m, 15m, 20m (The unit will change from minutes to hours for 'Long Run' modes)	
Reset Time	500 ms (Max.)	
Signal Sensing Time	40 ms < Ts < 5 s (For modes 1, 2, 3, 4, 5, 6, 9) & Ts ≥ 5s (For modes 7, 8, 11)	
Maintenance Mode	If the Relay is 'OFF' and the signal is present for 5 sec or more (Ts ≥ 5 s), the timer will enter 'Maintenance mode'	
Setting Accuracy	± 5% of Marking	
Repeat Accuracy	± 1%	
Output	Relay Output	1 NO (Pole is internally shorted with 'Live')
	Contact Rating	16A @ 240 VAC (Resistive)
	Electrical Life	1X10 ⁵
	Mechanical Life	5X10 ⁶
Utilization Category	AC - 15	Rated Voltage (Ue): 120/240 V, Rated Current (Ie): 3.0/1.5 A
	DC - 13	Rated Voltage (Ue): 24/125/250 V, Rated Current (Ie): 2.0/0.22/0.1 A
Operating Temperature	-10°C to +60°C	
Storage Temperature	-15°C to +70°C	
LED Indication	Green LED → Power ON, Yellow LED → Relay ON	
Enclosure	Flame Retardant UL94-V0	
Dimension (W x H x D) (in mm)	18 X 85 X 65	
Weight (unpacked)	72 gms	
Mounting	DIN Rail	
Certification	 	
Degree of Protection	IP 20 for Terminals, IP 30 for Enclosure, IP 40 for Front side	

EMI / EMC

Harmonic Current Emissions	IEC 61000-3-2
ESD	IEC 61000-4-2
Radiated Susceptibility	IEC 61000-4-3
Electrical Fast Transients	IEC 61000-4-4
Surges	IEC 61000-4-5
Conducted Susceptibility	IEC 61000-4-6
Voltage Dips & Interruptions (AC)	IEC 61000-4-11
Voltage Dips & Interruptions (DC)	IEC 61000-4-29
Conducted Emission	CISPR 14-1
Radiated Emission	CISPR 14-1

Environmental

Cold Heat	IEC 60068-2-1
Dry Heat	IEC 60068-2-2
Vibration	IEC 60068-2-6
Repetitive Shock	IEC 60068-2-27
Non-Repetitive Shock	IEC 60068-2-27



Electronic Timer - Series Staircase

FUNCTIONAL DIAGRAM

1. STAIRCASE RELAY

On Initial Signal, the output is switched ON & timing starts for the set duration. Subsequent signals during this period will extend the time duration by the value indicated on the timer during run time.

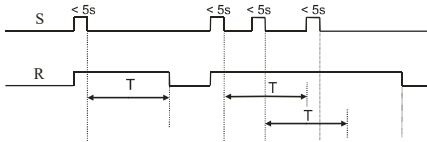

3. STAIRCASE RELAY WITH CUT-OFF

On Initial Signal, the output is switched ON & timing starts for the set duration. If a signal of duration 2 seconds or more is applied, then the output is switched OFF instantly.

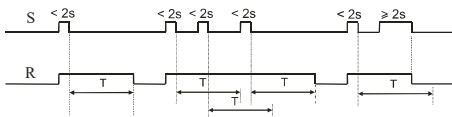

5. TIMING STEP WITH RELEASE DELAY & CUT-OFF

On Initial Signal, the output is switched 'ON' & timing starts for the set duration. During run time, if a signal of duration less than 2 seconds is applied, it is ignored. If the duration of the signal is 2 seconds or more, then the output is switched OFF instantly.

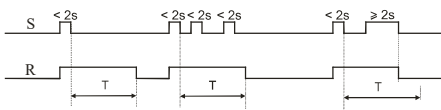

7. LONG RUN

On Initial Signal, the output is switched ON & timing starts for the preset duration. On completion of the time duration the output contacts open. Any signal during the run time is ignored. During run time, if a signal of duration less than 5 seconds is applied, it is ignored. If the duration of the signal is 5 seconds or more, then output is switched OFF instantly.

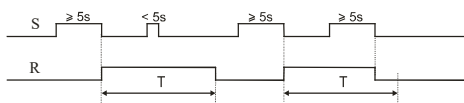

9. STEP RELAY

After every signal, the output changes state, alternately switching from ON to OFF.

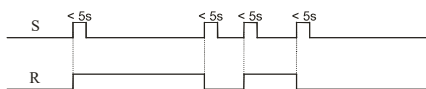

11. MAINTENANCE MODE

If the relay is OFF and a signal of duration more than 5 seconds is applied, the maintenance mode is activated. In this mode the output is switched ON for a duration of 60 minutes after which it is switched OFF. During this period if a signal of duration more than 5 seconds is applied, the maintenance mode is interrupted and the output is switched OFF. The mode can be activated from any one of the modes (Mode 1, 2, 3, 4, 5, 6 & 9) provided that the output is switched OFF initially.

S: Supply, R: Relay Output, T: Preset Time, t: 10 seconds

2. STAIRCASE RELAY WITH PRE-WARNING

On Initial Signal, the output is switched ON & timing starts for the preset duration. On completion of the set time duration the output blinks once & after a delay of 10 seconds, it blinks twice. After a further delay of 10 seconds, the output is switched OFF. Any signal during the run time or the pre-warning period will extend the time duration by the value indicated on the timer during run time.

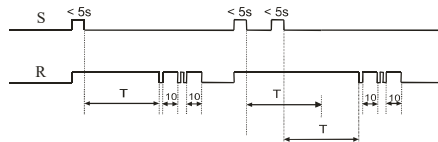

4. STAIRCASE RELAY WITH CUT-OFF & PRE-WARNING

On Initial Signal, the output is switched ON & timing starts for the set duration. On completion of the set time duration the output blinks once & after a delay of 10 seconds, it blinks twice. After a further delay of 10 seconds, the output is switched OFF. Any signal during the run time or the pre-warning period will extend the time duration by the value indicated on the timer during run time. If a signal of duration 2 seconds or more is applied, then the output is switched OFF after completion of the pre-warning period.

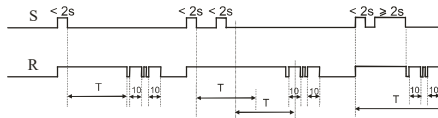

6. TIMING STEP WITH RELEASE DELAY & CUT-OFF & PRE-WARNING

On Initial Signal, the output is switched 'ON' & timing starts for the set duration. On completion of the set time duration the output blinks once & after a delay of 10 seconds, it blinks twice. After a further delay of 10 seconds, the output is switched 'OFF'. During run time, if a signal of duration less than 2 seconds is applied, it is ignored. If the duration of the signal is 2 seconds or more, then the output is switched OFF after completion of the pre-warning period.

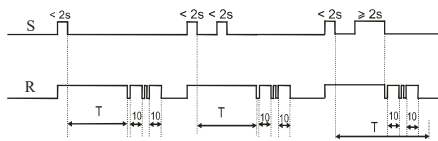

8. LONG RUN WITH PRE-WARNING

On Initial Signal, the output is switched 'ON' & timing starts for the preset duration. On completion of the set time duration the output blinks once & after a delay of 10 seconds, it blinks twice. After a further delay of 10 seconds, the output is switched OFF. During run time, if a signal of duration less than 5 seconds is applied, it is ignored. If the duration of the signal is 5 seconds or more, then output is switched OFF after completion of the prewarning period.

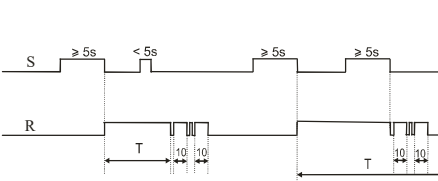

10. PERMANENT ON

In this mode the output contacts are permanently closed until the mode is changed and the device is reset.

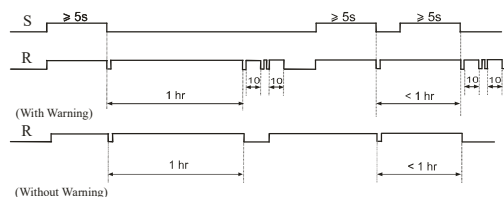
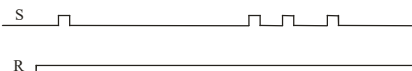

Pre-Warning: On completion of the set time duration the output blinks once & again blinks twice after a delay of 10 seconds and the contacts open after a further delay of 10 seconds.

Electronic Timer - Series Micon® 175

- Compact 17.5mm Wide
- Integrated Dual Voltage
- Functions: ON Delay, Interval, Star Delta, One Shot, Signal Off Delay
- Wide Time Range: 0.1s - 100h
- LED Indications for Power and Relay status
- Low Power Consumption



Ordering Information

Cat. No.	Description
11ODT4	110 VAC / 24 VAC/DC, ON Delay Timer, 1 C/O
12ODT4	240 VAC / 24 VAC/DC, ON Delay Timer, 1 C/O
15ODT4	12 VDC, ON Delay Timer, 1 C/O
12RDT4	240 VAC / 24 VAC/DC, Signal OFF Delay Timer, 1 C/O
11RDT4	110 VAC / 24 VAC/DC, Signal OFF Delay Timer, 1 C/O
15DDT4	12 VDC, Signal OFF Delay Timer, 1 C/O
11BDT4	110 VAC / 24 VAC/DC, One Shot Timer, 1 C/O
12BDT4	240 VAC / 24 VAC/DC, One Shot Timer, 1 C/O
15BDT4	12 VDC, One Shot Timer, 1 C/O
12WDTC	240 VAC / 24 VAC/DC, ON Delay & Interval Timer, 1 C/O
11WDTC	110 VAC / 24 VAC/DC, ON Delay & Interval Timer, 1 C/O

Electronic Timer - Series Micon® 175



Cat. No.	12ODT4	12RDT4
Parameters		
Timer Description	ON-Delay Timer	Signal OFF Delay Timer
Mode	ON-Delay	Signal OFF Delay
Functional Diagram		
Supply Voltage (φ)	240 VAC / 24 VAC/DC	240 VAC / 24 VAC/DC
Supply Variation	- 20% to +10% (of φ)	- 15% to +10% (of φ)
Frequency	50/60 Hz	50/60 Hz
Power Consumption (Max.)	8 VA	8 VA
Timing Ranges	0.3s to 30h	0.3s to 30h
Reset Time	100 ms (Max.)	150 ms (Max.)
Setting Accuracy	± 5% of Full scale	
Repeat Accuracy	± 1%	
Output	Relay Output	1 C/O
	Contact Rating	5A @ 240 VAC / 28 VDC (Resistive) 5A @ 240 VAC / 3A @ 30 VDC (Resistive)
	Electrical Life	1X10 ⁵
	Mechanical Life	5X10 ⁵
Utilization Category	AC - 15	Rated Voltage (Ue): 120/240 V, Rated Current (Ie): 3.0/1.5 A
	DC - 13	Rated Voltage (Ue): 24/125/250 V, Rated Current (Ie): 2.0/0.22/0.1 A
Operating Temperature	-10°C to +55°C	
Storage Temperature	-20°C to +70°C	
Humidity (Non Condensing)	95% (Rh)	
LED Indication	Green LED → Power ON, Red LED → Relay ON	
Enclosure	Flame Retardant UL94-V0	
Dimension (W x H x D) (in mm)	17.5 X 65 X 90	
Weight	75 g	
Mounting	Base / DIN Rail	
Certification		
Degree of Protection	IP 20 for Terminals, IP 40 for Enclosure	

EMI / EMC

Harmonic Current Emissions	IEC 61000-3-2
ESD	IEC 61000-4-2
Radiated Susceptibility	IEC 61000-4-3
Electrical Fast Transients	IEC 61000-4-4
Surges	IEC 61000-4-5
Conducted Susceptibility	IEC 61000-4-6
Voltage Dips & Interruptions (AC)	IEC 61000-4-11
Voltage Dips & Interruptions (DC)	IEC 61000-4-29
Conducted Emission	CISPR 14-1
Radiated Emission	CISPR 14-1

Environmental

Cold Heat	IEC 60068-2-1
Dry Heat	IEC 60068-2-2
Vibration	IEC 60068-2-6
Repetitive Shock	IEC 60068-2-27
Non-Repetitive Shock	IEC 60068-2-27

Electronic Timer - Series Micon® 175



Ordering Information

Cat. No.	Description
11SDT0	110 VAC, Star Delta Timer, 1 NO (Star) + 1 NO (Delta)
12SDT0	240 VAC, Star Delta Timer, 1 NO (Star) + 1 NO (Delta)
14SDT1S	240-415V AC, Star Delta Timer, 1C/O (Star) + 1C/O (Delta), 3-30 Sec.

Electronic Timer - Series Micon® 175



Cat. No.	12SDT0	
Parameters		
Timer Description	Star Delta Timer	
Mode	Star Delta	
Functional Diagram		
Supply Voltage (ϕ)	240 VAC	
Supply Variation	- 20% to +10% (of ϕ)	
Frequency	50 Hz	
Power Consumption (Max.)	10 VA	
Timing Ranges	3s to 120s	
Pause Time	60 ms	
Reset Time	150 ms (Max.)	
Setting Accuracy	± 5% of Full scale	
Repeat Accuracy	± 1%	
Output	Relay Output	Star - 1 'NO', Delta - 1 'NO'
	Contact Rating	5A @ 240 VAC / 3A @ 30 VDC (Resistive)
	Electrical Life	1X10 ⁵
	Mechanical Life	5X10 ⁶
Utilization Category	AC - 15	Rated Voltage (Ue): 120/240 V, Rated Current (Ie): 3.0/1.5 A
	DC - 13	Rated Voltage (Ue): 24/125/250 V, Rated Current (Ie): 2.0/0.22/0.1 A
Operating Temperature	-10°C to +55°C	
Storage Temperature	-20°C to +70°C	
Humidity (Non Condensing)	95% (Rh)	
LED Indication	Red LED 1 → 'Y' ON, Red LED 2 → 'Δ' ON	
Enclosure	Flame Retardant UL94-V0	
Dimension (W x H x D) (in mm)	17.5 X 90 X 58.5	
Weight (unpacked)	65 g	
Mounting	Base / DIN Rail	
Certification		
Degree of Protection	IP 20 for Terminals, IP 40 for Enclosure	

EMI / EMC

Harmonic Current Emissions	IEC 61000-3-2
ESD	IEC 61000-4-2
Radiated Susceptibility	IEC 61000-4-3
Electrical Fast Transients	IEC 61000-4-4
Surges	IEC 61000-4-5
Conducted Susceptibility	IEC 61000-4-6
Voltage Dips & Interruptions (AC)	IEC 61000-4-11
Voltage Dips & Interruptions (DC)	IEC 61000-4-29
Conducted Emission	CISPR 14-1
Radiated Emission	CISPR 14-1

Environmental

Cold Heat	IEC 60068-2-1
Dry Heat	IEC 60068-2-2
Vibration	IEC 60068-2-6
Repetitive Shock	IEC 60068-2-27
Non-Repetitive Shock	IEC 60068-2-27

Electronic Timer - Series Micon® 175

- Multi-Function: 10 Different (Non-Signal & Signal based) Modes
- Wide Voltage range for both AC & DC
- Wide Time range: 0.1s - 100h
- LED Indications for Power and Relay status
- Independent settings for both ON Time & OFF Time
- Low Power Consumption





Ordering Information

Cat. No.	Description
1CMDT0	12 - 240 VAC/DC, Multi Function Timer (10 Modes), 1 C/O
1CQDT9	12 - 240 VAC/DC, Multi Function Timer (10 Modes), 1 C/O - 16A
1CVDT9	12 - 240 VAC/DC, Multi Function Timer (10 Functions with run time setting), 1 C/O - 16A
1CJDT0	12 - 240 VAC/DC, Asymmetric Timer, 1 C/O

Electronic Timer - Series Micon® 175



Cat. No.		1CMDT0	1CQDT9	1CJDT0
Parameters				
Timer Description		Multi Function Timer		Asymmetric Timer
Modes		1) Signal ON Delay 2) Cyclic ON/OFF 3) Cyclic OFF/ON 4) Signal OFF Delay 5) Signal OFF/ON 6) Accumulative Delay on Signal 7) Impulse ON/OFF 8) Leading Edge Impulse 9) Trailing Edge Impulse 10) Leading Edge Bi-stable		1) Asymmetric ON-OFF, 2) Asymmetric OFF-ON
Derived Modes		ON Delay, Interval		N A
Supply Voltage (ϕ)		12 - 240 VAC/DC		
Supply Variation		-15% to +10% (of ϕ)		
Frequency		50/60 Hz		
Power Consumption (Max.)		5 VA		
Timing Range		0.1s to 100h		
Reset Time		200 ms (Max)		
Setting Accuracy		± 5% of Full scale		
Repeat Accuracy		± 1%		
Output	Relay Output	1 C/O		
	Contact Rating	8A @ 240 VAC / 5A @ 24 VDC (Resistive)	16A @ 240 VAC / 16A @ 24 VDC (Resistive)	8A @ 240 VAC / 5A @ 24 VDC (Resistive)
	Electrical Life	5X10 ⁵		
	Mechanical Life	1X10 ⁶		
Utilization Category	AC - 15 DC - 13	Rated Voltage (Ue): 120/240 V, Rated Current (Ie): 3.0/1.5 A Rated Voltage (Ue): 24/125/250 V, Rated Current (Ie): 2.0/0.22/0.1 A		
Operating Temperature	-10°C to +60°C			
Storage Temperature	-15°C to +70°C			
LED Indication	Green LED → Power ON Yellow LED → Relay ON		Green LED → Power ON Amber LED → Relay ON	
Enclosure	Flame Retardant UL94-V0			
Dimension (W x H x D) (in mm)	18 X 60 X 85			
Weight (unpacked)	72 g			
Mounting	DIN Rail			
Certification	  			
Degree of Protection	IP 20 for Terminals, IP 30 for Enclosure, IP 40 for Front side			

EMI / EMC

Harmonic Current Emissions	IEC 61000-3-2
ESD	IEC 61000-4-2
Radiated Susceptibility	IEC 61000-4-3
Electrical Fast Transients	IEC 61000-4-4
Surges	IEC 61000-4-5
Conducted Susceptibility	IEC 61000-4-6
Voltage Dips & Interruptions (AC)	IEC 61000-4-11
Voltage Dips & Interruptions (DC)	IEC 61000-4-29
Conducted Emission	CISPR 14-1
Radiated Emission	CISPR 14-1

Environmental

Cold Heat	IEC 60068-2-1
Dry Heat	IEC 60068-2-2
Vibration	IEC 60068-2-6

Electronic Timer - Series Micon® 175



FUNCTIONAL DIAGRAMS FOR 1CMDT0

☐: Supply Voltage, S: Input Signal, R: Relay Output
T: Preset Time, TON: Preset ON Time, TOFF: Preset OFF Time

SIGNAL ON DELAY [stn]

On application of input signal, the preset delay time period starts. On completion of the preset time, the output is switched ON and remains ON till the input signal is present.

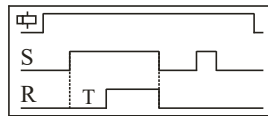

ACCUMULATIVE DELAY On SIGNAL [san]

On application of supply voltage, the preset delay time period starts. If input signal is applied during this period, the preset time stops and resumes only when the input signal is removed. On completion of the preset time, the output is switched ON.

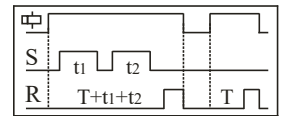

CYCLIC ON/OFF [cnf]

On application of supply voltage, the output is initially switched ON for the preset time duration (T) after which it is switched OFF for the same time duration (T). This cycle continues till the power supply is present.



IMPULSE ON/OFF [inf]

On application or removal of input signal to the timer, the output is immediately switched ON for the preset time duration (T). If the state of the input signal is changed during the preset time, the output does not change state only the time is reset.

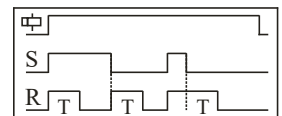

CYCLIC OFF/ON [cfn]

On application of supply voltage, the output is initially switched OFF for the preset time duration (T) after which it is switched ON for the same time duration (T). This cycle continues till the power supply is present.



LEADING EDGE IMPULSE [il]

When input signal is applied to the timer the output is immediately switched ON. The output remains ON for the preset time duration (T) after which it is switched OFF. If the input signal is removed during the preset time, the output is immediately switched OFF.

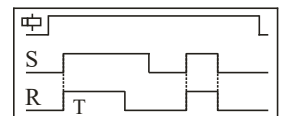

SIGNAL OFF DELAY [sf]

On application of input signal to the timer, the output is immediately switched ON. When the input signal is switched OFF, the preset time delay period starts. On completion of the time period the output is switched OFF.

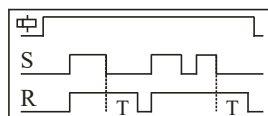

TRAILING EDGE IMPULSE [it]

When the input signal to the timer is removed, the output is immediately switched ON for the preset time duration (T) after which it is switched OFF. If the input signal is applied during the preset time, the output is immediately switched OFF.

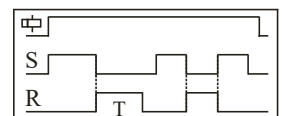

SIGNAL OFF/ON [sfn]

On application of input signal to the timer, the preset delay time period (T) starts. On completion of the time preset time, the output is switched ON. When the input signal is switched OFF, again the preset time delay period (T) starts. On completion of the time period the output is switched OFF.

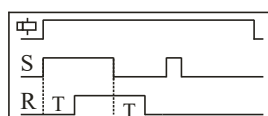

LEADING EDGE BISTABLE [sbi]

On application of input signal to the timer, the output is switched ON and remains ON even after the input signal is removed. On subsequent application of input signal, the output keeps on changing its state.

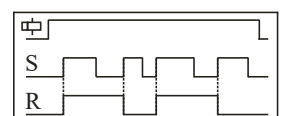

DERIVED MODES

Select 'Signal ON Delay' Mode and short the connection between A1-B1 before power ON OR Select 'Accumulative Delay ON Signal' Mode and keep the connection between A1-B1 open.

ON DELAY

When supply power is applied to the timer, the preset delay time period starts. On completion of the preset time, the output is switched ON and remains ON till the input supply is present.

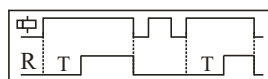

Select mode, "Leading Edge Impulse" and short the connection between A1 & B1.

INTERVAL

When supply power is applied to the timer, the output is instantly switched ON. On completion of the preset time, the output is switched OFF.

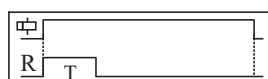

FUNCTIONAL DIAGRAMS FOR 1CJDT0

MODE A

ASYMMETRIC OFF-ON

On application of supply voltage, the output is initially switched OFF for the preset 'OFF' time duration (T) after which it is switched ON for the preset 'ON' time duration (T). This cycle repeats and continues till the supply is present. The ON time & OFF time are set independently.

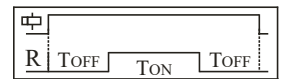

MODE B

ASYMMETRIC ON-OFF

On application of supply voltage, the output is initially switched ON for the preset 'ON' time duration (T) after which it is switched OFF for the preset 'OFF' time duration (T). This cycle repeats and continues till the supply is present. The ON time & OFF time are set independently.





Note: Refer page number 28 for Connection Diagram

Electronic Timer - Series Micon® 175

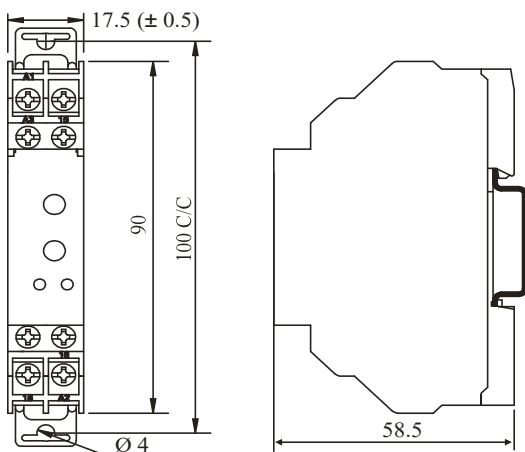
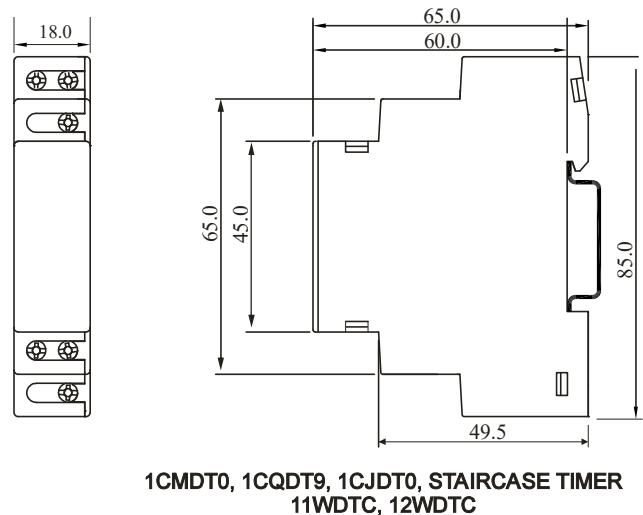
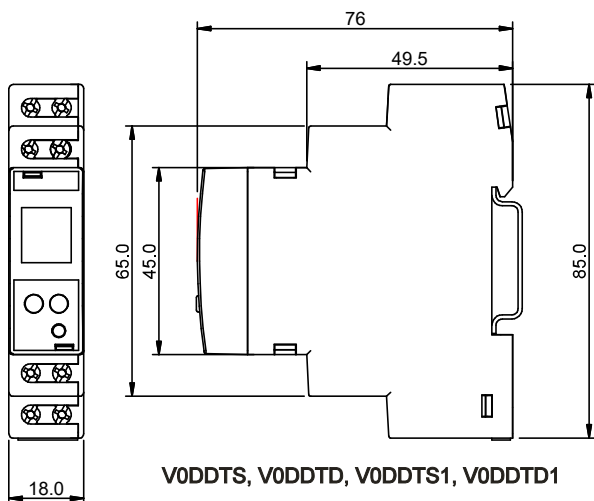

MOUNTING DIMENSIONS (mm)

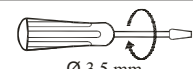

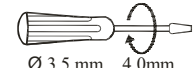

TERMINAL TORQUE & CAPACITY

 Ø 3.5 mm	0.54 N.m (6 Lb.in)
	1 x 2.5 mm ² Solid/Stranded Wire
AWG	1 x 24 to 12

V0DDTS, V0DDTD, V0DDTS1, V0DDTD1, STAIRCASE TIMER

 Ø 3.5 mm...4.0mm	0.6 N.m (5.3 Lb.in)
	1 x 4.0 mm ² Solid/Stranded Wire
AWG	1 x 20 to 10

1CMTD0, 1CQDT9, 1CJDT0

 Ø 4 mm...5.0mm Combi Head Bit./Flat	0.5 N.m (4.4 Lb.in) to 0.7 N.m (6.2 Lb.in)
	2 x 2.5 mm ² Solid/Stranded Wire
AWG	20 to 12

110DT4, 120DT4, 150DT4, 11SDT0, 12SDT0 11ODT8, 12ODT8, 11BDT4, 12BDT4, 15BDT4

Electronic Timer - Series Micon® 175

CONNECTION DIAGRAM

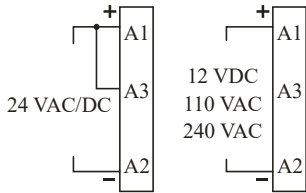

110DT4, 120DT4, 150DT4,
11SDT0, 12SDT0, 11ODT8,
12ODT8, 11BDT4, 12BDT4, 15BDT4

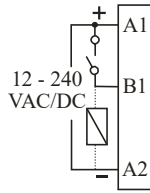

1CMDT0,
1CQDT9,
1CJDT0

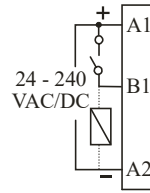

V0DDTS, V0DDTD,
V0DDTS1, V0DDTD1

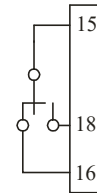

110DT4, 120DT4, 150DT4,
11SDT0, 12SDT0, 11ODT8,
12ODT8, 11BDT4, 12BDT4,
15BDT4, 1CMDT0, 1CQDT9,
V0DDTS, V0DDTS1

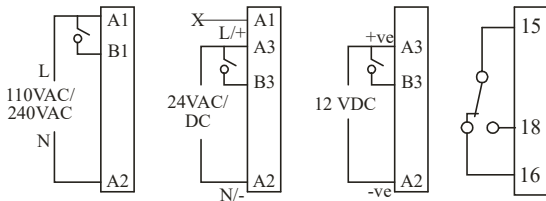

11RDT4, 12RDT4, 15DDT4

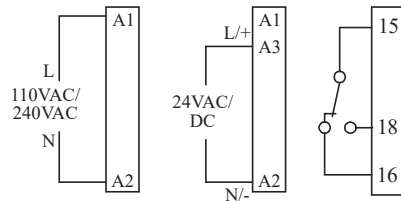

11WDT4, 12WDT4

⚠ Do not apply more than 27VAC/DC to A3 terminal of 11WDT4 & 12WDT4.

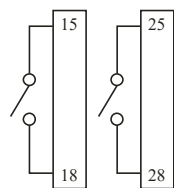

V0DDTD, V0DDTD1,
STAIRCASE TIMER

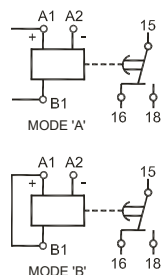

1CJDT0

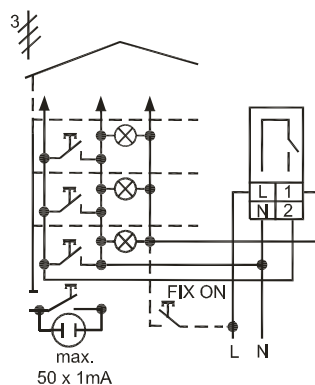

3 Wire rising main without Loft illumination

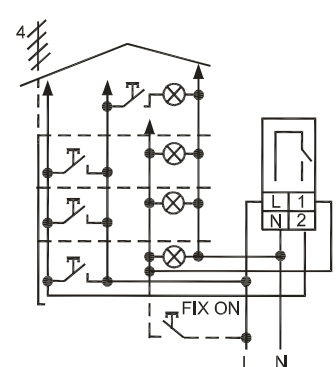

4 Wire rising main without connection for Loft illumination

STAIRCASE TIMER

Electronic Timer - Series Micon® 225 Signal Based Multi - Function

- Multi-function with Signal Start and Supply Start.
- 16 Timing Functions selected by DIP switch.
- Two independent relay outputs with either both relays timed or one timed and one instantaneous.
- Wide Input Signal & Supply range - 24-240V AC/DC.
- Wide Timing Range - 0.1 s to 120 days.
- High timing Accuracy.
- LED indicators for Power Supply & Relay Status.
- 22.5mm DIN Mount Housing.





Ordering Information

Cat. No.	Description
2A8DT6	24-240 VAC / DC, Signal Based Multi - Function, 1 C/O (Delayed) & 1 C/O (Configurable as either Delayed or Instant)

Electronic Timer - Series Micon® 225

Signal Based Multi - Function



Cat. No.	2A8DT6	
Parameters		
Timer Description	Multi-function with Signal Start and Supply Start	
Supply Voltage (Φ)	24-240 VAC / DC	
Supply Variation	- 20% to +10% (of Φ)	
Frequency	50/60 Hz	
Power Consumption (Max.)	< 2 VA @ 24 VAC / DC, < 4 VA @ 230 VAC / DC	
Initiate Time	100 ms (Max.)	
Reset Time	200 ms (Max.)	
Signal Voltage	Low Range (B1L-A2)	24-60V AC/DC
	High Range (B1H-A2)	85-265V AC, 100-265V DC
Signal Sensing Time	For AC Signals: 50 ms Max. For DC Signals: 20 ms Max.	
Signal stabilization Delay	100 ms (Applicable at Power ON Only)	
Setting Accuracy	± 5% of Full scale	
Repeat Accuracy	± 1%	
Output	Relay Output	1 C/O (Delayed) & 1 C/O (Configurable as either Delayed or Instant)
	Contact Rating	5A @ 250 VAC / 28 VDC (Resistive)
	Contact Material	AgNi
	Electrical Life	1x10 ⁵
	Mechanical Life	1x10 ⁷
Set Time (Ts)	0.1 seconds to 120 Days	
Functions	Refer page no. 31 & 32	
LED Indication on front panel	Green LED ON: Power ON, Amber LED ON :Relay ON for Delayed contact	
Mounting	Base / DIN Rail	
Max. Operating Altitude	2000 m	
Housing	Flame retardant (UL 94-V0)	
Operating Temperature	-10°C to +60°C	
Storage Temperature	-20°C to +70°C	
Humidity (Non Condensing)	95% (Rh)	
LED Indication	Green LED → Power ON, Red LED → Relay ON	
Enclosure	Flame Retardant UL94-V0	
Dimension (W x H x D) (in mm)	22.5 X 75 X 100.5	
Weight (unpacked)	153 g	
Pollution Degree	II	
Certification	  	
Degree of Protection	IP 20 for Terminals, IP 40 for Enclosure	

EMI / EMC

Harmonic Current Emissions	IEC 61000-3-2
ESD	IEC 61000-4-2
Radiated Susceptibility	IEC 61000-4-3
Electrical Fast Transients	IEC 61000-4-4
Surges	IEC 61000-4-5
Conducted Susceptibility	IEC 61000-4-6
Voltage Dips & Interruptions (AC)	IEC 61000-4-11
Conducted Emission	CISPR 14-1
Radiated Emission	CISPR 14-1

Safety:

Test Voltage between I/P and O/P	IEC 60947-5-1
Test Voltage between all terminals & enclosure	IEC 60947-5-1
Impulse Voltage between I/P and O/P	IEC 60947-5-1
Single Fault	IEC 61010-1
Insulation Resistance	UL 508
Leakage Current	UL 508
Product Reference Standard	IEC 61812-1

Environmental

Cold Heat	IEC 60068-2-1
Dry Heat	IEC 60068-2-2
Vibration	IEC 60068-2-6
Repetitive Shock	IEC 60068-2-27
Non-Repetitive Shock	IEC 60068-2-27



Electronic Timer - Series Micon® 225

Signal Based Multi - Function

FUNCTIONAL DIAGRAMS

⏻ : Supply Voltage, S: Input Signal, R: Relay Output, R(I): Instant Relay, R(D): Delayed Relay
 T: Preset Time, TON: Preset ON Time, TOFF: Preset OFF Time, T-a: Timing Break Before completion

ON DELAY (Non Signal Based)

When supply is applied, timing starts and after the preset time duration 'T', output switches ON and remains ON till the supply is present.

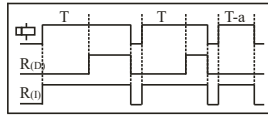

SIGNAL ON DELAY TYPE 1

When the input supply & signal are applied, timing starts and after preset time duration 'T' output switches ON & remains ON till the supply is present. Changing the state of signal during 'T' does not affect the output.

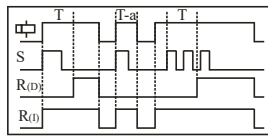

SIGNAL ON DELAY

Time commences as supply and signal is present. When input signal is opened, the timing resets. The output is switched ON at the end of the preset time duration 'T'. When output is ON if signal is opened then the output switches OFF.

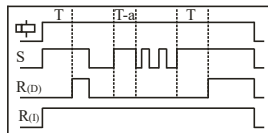

INVERTED SIGNAL ON DELAY

When supply is applied and signal is opened, preset time duration 'T' starts. On completion of the 'T', output switches ON. If the signal is closed during timing 'T', timing resets.

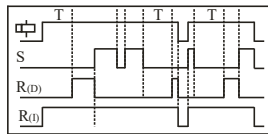

INTERVAL

When supply voltage is applied & signal is closed, output switches ON & timing function starts. If signal is opened and closed during the preset time, the timing restarts. After preset time 'T' has elapsed, the output switches OFF.

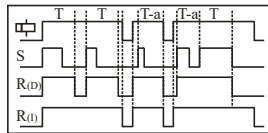

LEADING EDGE IMPULSE

When the supply applied and signal is closed, the output switches ON for preset time 'T'. After the completion of preset time 'T', the output switches OFF. If signal closed or opened during preset time duration 'T', the output remains unaffected.

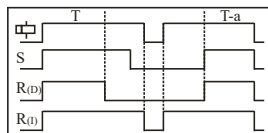

TRAILING EDGE IMPULSE

When supply voltage is applied and signal is opened, output switches ON for the preset time duration 'T'. After completion of preset time 'T', output switches OFF. If the signal is closed during preset timing 'T', output switches OFF & timing stops.

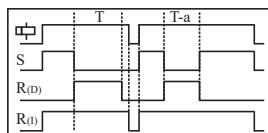

CYCLIC OFF/ON

When the supply applied and signal is closed, output switches OFF for the preset time duration 'T' and then switches ON for preset time duration 'T'. This cycle repeats while the supply is present. Changing the state of signal during 'T' does not affect the output.

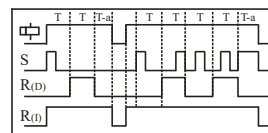

CYCLIC ON/OFF

When the supply applied and signal is closed, output switches ON for the preset time duration 'T' and then switches OFF for preset time duration 'T'. This cycle repeats while the supply is present. Changing the state of signal during 'T' does not affect the output.

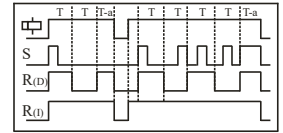

SIGNAL ON/ OFF Delay

Signal ON/OFF Delay: When the supply is applied and signal is closed, outputs switches ON after preset time 'T'. During the timing 'T' if signal is opened, the output switches ON immediately and OFF delay starts. Once this time period has elapsed the output switches OFF. During this OFF delay if signal is closed, the output switches OFF immediately and ON Delay restarts.

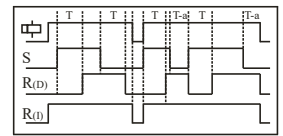

IMPULSE ON/OFF

When supply is applied and if signal closed or opened, output switches ON for preset time duration 'T'. During time period 'T', changing state of input signal does not affect the output but resets the timing.

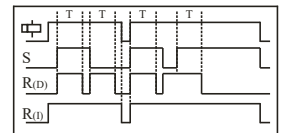

ACCUMULATIVE DELAY ON SIGNAL

Accumulative Delay ON Signal: On application of the supply voltage, the preset timing commences. Whenever signal is closed, timing pauses & resumes back only when the input signal is opened. The output switches ON at the end of the preset time duration 'T'.

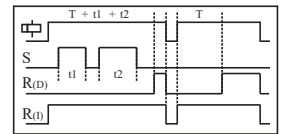

DELAYED IMPULSE

Delayed Impulse: When supply voltage is applied and signal is closed, output switches ON at the end of the preset time 'TOFF'. Then the preset ON time 'TON' starts irrespective of the signal state and remains ON till the completion of preset time duration 'TON'. If signal closed during the timing 'TOFF', the timing restarts but the output state remains unaffected. The signal change does not have any effect during the timing period 'TON'.

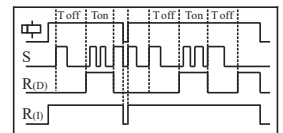

ONE SHOT

One Shot: When the supply voltage is applied and signal is closed, timing starts and after the preset time duration 'T', output switches ON for One sec. only.

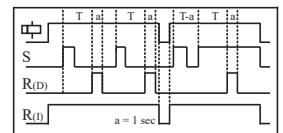

STEP MODE

Step Mode: When the supply voltage is applied and signal closed, output switches ON for preset time duration 'T', removal of the input signal during this time duration 'T' does not affect the output state. But if the signal is closed during time duration 'T', output switches OFF.

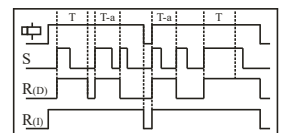

SIGNAL OFF DELAY

Signal OFF Delay: When the supply is applied and signal is closed, output switches ON. When signal is opened, the preset timing commences and output switches OFF at the end of time duration 'T'. If signal is closed during timing period, then timing stops and restarts when signal.

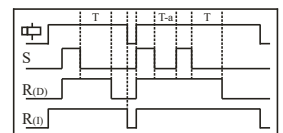



Electronic Timer - Series Micon® 225

Signal Based Multi - Function

Selection of Function: Operating Mode & timing can be selected by using DIP switches

Function		Function	
1	2 3 4	1	2 3 4
<input type="checkbox"/>	<input type="checkbox"/>	<input type="checkbox"/>	<input type="checkbox"/>
On Delay (Non Signal)		Signal OFF Delay	
<input type="checkbox"/>	<input type="checkbox"/>	<input type="checkbox"/>	<input type="checkbox"/>
Signal On Delay Type 1		Step Mode	
<input type="checkbox"/>	<input type="checkbox"/>	<input type="checkbox"/>	<input type="checkbox"/>
Signal On Delay		One Shot	
<input type="checkbox"/>	<input type="checkbox"/>	<input type="checkbox"/>	<input type="checkbox"/>
Inverted Signal On Delay		Delayed Impulse	
<input type="checkbox"/>	<input type="checkbox"/>	<input type="checkbox"/>	<input type="checkbox"/>
Interval		Accumulative Delay On Signal	
<input type="checkbox"/>	<input type="checkbox"/>	<input type="checkbox"/>	<input type="checkbox"/>
Leading Edge Impulse		Impulse ON / OFF	
<input type="checkbox"/>	<input type="checkbox"/>	<input type="checkbox"/>	<input type="checkbox"/>
Trailing Edge Impulse		Signal ON / OFF Delay	
<input type="checkbox"/>	<input type="checkbox"/>	<input type="checkbox"/>	<input type="checkbox"/>
Cyclic OFF / ON		Cyclic ON / OFF	
II + 1D or 2D Selection		Timing Multiplier Selection	
5		6	
<input type="checkbox"/>	II + 1D Operation	<input type="checkbox"/>	Timing = 'T' X 't' X 1
<input type="checkbox"/>	2 Delayed Operation	<input type="checkbox"/>	Timing = 'T' X 't' X 12

MOUNTING DIMENSION (mm)

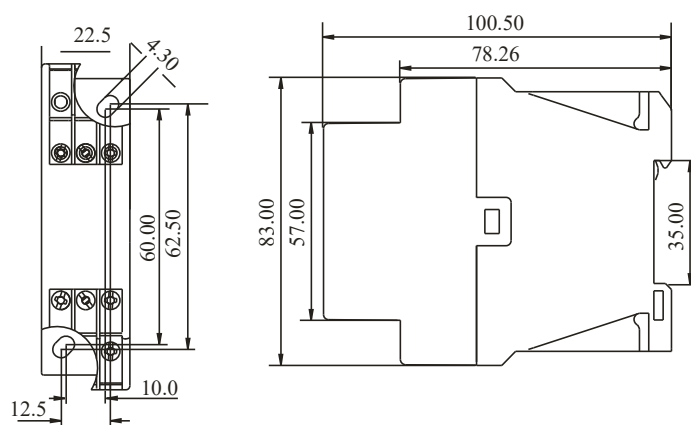

CONNECTION DIAGRAM

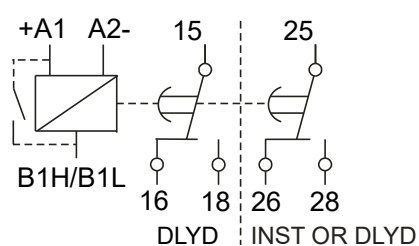

TERMINAL TORQUE & TERMINAL CAPACITY

	0.6 N.m (5.3 Lb.in)
Ø 3.5 mm...4.0mm	1 x 4.0 mm ² Solid/Stranded Wire
AWG	1 x 20 to 10

Electronic Timer - Series Micon® 225

- Compact 22.5mm Wide
- Wide Time Range: 0.1s to 10h
- Wide Voltage range for both AC & DC

Multi Function Timer

- With 5 different Functions
- 2 C/O Configuration

- Flush knobs for better security
- LED Indications for Power and Relay status
- Excellent Noise Immunity to the latest IEC standards

Multi Function Timer with 1 Instant & 1 Delayed C/O

- With 6 different Functions
- Instant + Delayed output Configuration



Ordering Information

Cat. No.	Description
2A5DT5	24 - 240 VAC/DC, Multi-Function Timer (5 Modes), 2 C/O
2B5DT5	240 - 415 VAC, Multi-Function Timer (5 Modes), 2 C/O
2A6DT6	24 - 240 VAC/DC, Multi-Function Timer (6 Modes), 2 C/O (1 Instant + 1 Delayed for 6th Mode)
2B6DT6	240 - 415 VAC, Multi-Function Timer (6 Modes), 2 C/O (1 Instant + 1 Delayed for 6th Mode)
2AODT5	24 - 240 VAC/DC, ON Delay, 2 C/O

UL Approval not applicable for Cat No. 2A6DT6 & 2B6DT6

Electronic Timer - Series Micon® 225



Cat. No.	2A5DT5	2B6DT6
Parameters		
Timer Description	Multi-Function Timer	
Modes	ON Delay, Interval, Cyclic ON-OFF, Cyclic OFF-ON, One Shot	ON Delay, Interval, Cyclic ON-OFF, Cyclic OFF-ON, One Shot, ON Delay with 1 Instant & 1 Delayed
Functional Diagram		
Supply Voltage (φ)	24 - 240 VAC/DC	240 - 415 VAC
Supply Variation	- 20% to +10% (of φ)	
Frequency	50/60 Hz	
Power Consumption (Max.)	4 VA	7 VA
Timing Range	0.1s to 10h	
Reset Time	200 ms (Max.)	
Setting Accuracy	± 5% of Full scale	
Repeat Accuracy	± 1%	
Output	Relay Output	2 C/O
	Contact Rating	5A @ 240 VAC / 28 VDC (Resistive)
	Electrical Life	1x10 ⁵
	Mechanical Life	1x10 ⁷
Utilization Category	AC - 15	Rated Voltage (Ue): 230/125 V, Rated Current (Ie): 1.3/2.5 A
	DC - 13	Rated Voltage (Ue): 250/120/24 V, Rated Current (Ie): 0.1/0.22/2 A
Operating Temperature	-15°C to +60°C	
Storage Temperature	-20°C to +80°C	
Humidity (Non Condensing)	95% (Rh)	
LED Indication	Green LED → Power ON, Red LED → Relay ON	
Enclosure	Flame Retardant UL94V0	
Dimension (W x H x D) (in mm)	22.5 X 75 X 100.5	
Weight (unpacked)	130 g	
Mounting	Base / DIN Rail	
Certification		
Degree of Protection	IP 20 for Terminals, IP 40 for Enclosure	

EMI / EMC

Harmonic Current Emissions	IEC 61000-3-2
ESD	IEC 61000-4-2
Radiated Susceptibility	IEC 61000-4-3
Electrical Fast Transients	IEC 61000-4-4
Surges	IEC 61000-4-5
Conducted Susceptibility	IEC 61000-4-6
Voltage Dips & Interruptions (AC)	IEC 61000-4-11
Voltage Dips & Interruptions (DC)	IEC 61000-4-29
Conducted Emission	CISPR 14-1
Radiated Emission	CISPR 14-1

Environmental

Cold Heat	IEC 60068-2-1
Dry Heat	IEC 60068-2-2
Vibration	IEC 60068-2-6
Repetitive Shock	IEC 60068-2-27
Non-Repetitive Shock	IEC 60068-2-27

Electronic Timer - Series Micon® 225

- Signal based Multi-function with Relay / Solid State Output
- Potential Free Signal Input
- Asymmetric Timer with Solid State Output



Ordering Information

Cat. No.	Description
2ANDT0	24 - 240 VAC/DC, Signal Based Multi Function Timer, 1 C/O
20NDTT	110 - 240 VAC, Signal Based Multi Function Timer with Solid State Output
20JDTT	110 - 240 VAC, Asymmetric Timer with Solid State Output

Electronic Timer - Series Micon® 225



Cat. No.		2ANDT0	20NDTT
Parameters			
Description Signal Based Multi Function			
Modes Signal ON Delay, Accumulative ON Delay, Signal OFF Delay, Signal OFF/ON Delay, Leading Edge Impulse			
Derived Modes ON Delay, Interval			
Functional Diagram			
Supply Voltage (ϕ)		24 - 240 VAC/DC	110 - 240 VAC
Supply Variation		- 20% to +10% (of ϕ)	
Frequency		50/60 Hz	
Power Consumption (Max.)		3 VA	
Timing Ranges		0.1s to 10h	
Reset Time		100 ms	
Setting Accuracy		\pm 5% of Full scale	
Repeat Accuracy		\pm 1%	
Output	Relay Output	1 C/O (SPDT)	N A
	Contact Rating	5A @ 240 VAC / 28 VDC (Resistive)	N A
	Electrical Life	1×10^5	N A
	Mechanical Life	1×10^7	N A
Solid State Output	Type & Form	N A	Optical Isolation, SPST
	Rated Current	N A	1A (AC)
	Max. Admissible Current	N A	20A (10 ms)
	Vol. Breaking Capacity	N A	110 to 240 VAC
	Max. Drop @ Terminals	N A	\leq 8V
	Minimum Load Current	N A	20 mA
	Electrical Life	N A	1×10^6
Utilization Category	AC - 15	Rated Voltage (Ue): 120/240 V, Rated Current (Ie): 3.0/1.5 A	
	DC - 13	Rated Voltage (Ue): 24/125/250 V, Rated Current (Ie): 2.0/0.22/0.1 A	
Operating Temperature		-15° C to +60° C	
Storage Temperature		-20° C to +80° C	
Humidity (Non Condensing)		95% (Rh)	
LED Indication		Green LED \rightarrow Power ON Red LED \rightarrow Relay ON	
Enclosure		Flame Retardant UL94-V0	
Dimension (W x H x D) (in mm)		22.5 X 75 X 100.5	
Weight (unpacked)		130 g	
Mounting		Base / DIN Rail	
Certification			
Degree of Protection		IP 20 for Terminals, IP 40 for Enclosure	

EMI / EMC

Harmonic Current Emissions	IEC 61000-3-2
ESD	IEC 61000-4-2
Radiated Susceptibility	IEC 61000-4-3
Electrical Fast Transients	IEC 61000-4-4
Surges	IEC 61000-4-5
Conducted Susceptibility	IEC 61000-4-6
Voltage Dips & Interruptions (AC)	IEC 61000-4-11
Voltage Dips & Interruptions (DC)	IEC 61000-4-29
Conducted Emission	CISPR 14-1
Radiated Emission	CISPR 14-1

Environmental

Cold Heat	IEC 60068-2-1
Dry Heat	IEC 60068-2-2
Vibration	IEC 60068-2-6
Repetitive Shock	IEC 60068-2-27
Non-Repetitive Shock	IEC 60068-2-27

Electronic Timer - Series Micon® 225

Asymmetric ON-OFF Timer

- Compact 22.5mm Wide
- Independent settings for ON & OFF time
- Wide Time Range
- LED Indications for Power and Relay status

Star Delta Timer

- Settable Start Time
- Settable Pause Time
- Indications for Star & Delta
- Excellent Noise Immunity to the latest IEC standards



Ordering Information

Cat. No.	Description
2AADT5	24 - 240 VAC/DC, Asymmetric ON/OFF Timer, 2 C/O
2ASDT0*	24 - 240 VAC/DC, Star Delta Timer, 1 NO (Star) + 1 NO (Delta)
2ASDT1	24 - 240 VAC/DC, Star Delta Timer, 1 NO (Star) + 1 NO (Delta)
2BSDT0*	240 - 415 VAC, Star Delta Timer, 1 NO (Star) + 1 NO (Delta)
2BSDT1	240 - 415 VAC, Star Delta Timer, 1 NO (Star) + 1 NO (Delta)

*Note: Product with test voltage between input and output at 1.5 kV

Electronic Timer - Series Micon® 225



Cat. No.	2AADT5		2ASDT0	
Parameters				
Timer Description	Asymmetric Timer		Star Delta Timer	
Mode	Asymmetric ON-OFF (A)		Star Delta	
Functional Diagram				
Supply Voltage (ϕ)	24 - 240 VAC/DC			
Supply Variation	- 20% to +10% (of ϕ)			
Frequency	50/60 Hz			
Power Consumption (Max.)	4 VA			
Timing Ranges	0.1s to 10h		3s to 120s	
Pause Time (P)	N A		60ms, 90ms, 120ms, 150ms	
Reset Time	200 ms (Max.)			
Setting Accuracy	± 5% of Full scale			
Repeat Accuracy	± 1%			
Output	Relay Output	2 C/O		Star - 1 'NO', Delta - 1 'NO'
	Contact Rating	5A @ 240 VAC / 28 VDC (Resistive)		
	Electrical Life	1x10 ⁶		
	Mechanical Life	1x10 ⁷		
Utilization Category	AC - 15	Rated Voltage (Ue): 230/125 V, Rated Current (Ie): 1.3/2.5 A		
	DC - 13	Rated Voltage (Ue): 250/120/24 V, Rated Current (Ie): 0.1/0.22/2 A		
Operating Temperature	-15°C to +60°C			
Storage Temperature	-20°C to +80°C			
Humidity (Non Condensing)	95% (Rh)			
LED Indication	Green LED → Power ON, Red LED → Relay ON		Red LED 1 → 'Λ' ON, Red LED 2 → 'Δ' ON	
Enclosure	Flame Retardant UL94-V0			
Dimension (W x H x D) (in mm)	22.5 X 75 X 100.5			
Weight (unpacked)	130 g			
Mounting	Base / DIN Rail			
Certification				
Degree of Protection	IP 20 for Terminals, IP 40 for Enclosure			

EMI / EMC

Harmonic Current Emissions	IEC 61000-3-2
ESD	IEC 61000-4-2
Radiated Susceptibility	IEC 61000-4-3
Electrical Fast Transients	IEC 61000-4-4
Surges	IEC 61000-4-5
Conducted Susceptibility	IEC 61000-4-6
Voltage Dips & Interruptions (AC)	IEC 61000-4-11
Voltage Dips & Interruptions (DC)	IEC 61000-4-29
Conducted Emission	CISPR 14-1
Radiated Emission	CISPR 14-1

Environmental

Cold Heat	IEC 60068-2-1
Dry Heat	IEC 60068-2-2
Vibration	IEC 60068-2-6
Repetitive Shock	IEC 60068-2-27
Non-Repetitive Shock	IEC 60068-2-27

Electronic Timer - Series Micon® 225

- True OFF Delay (Power OFF Delay) up to 600 seconds with 2 C/O.



Ordering Information

Cat. No.	Description
23GDT0	24-240 VAC/DC, True OFF Delay (Power OFF Delay) Timer, 2 C/O

Electronic Timer - Series Micon® 225



Cat. No.	23GDT0	
Parameters		
Timer Description	True OFF Delay (Power OFF Delay) Timer	
Mode	True OFF Delay (Power OFF Delay)	
Functional Diagram		
Supply Voltage (φ)	24 - 240 VAC/DC	
Supply Variation	-10 to +20% (of φ)	
Frequency	50/60 Hz	
Power Consumption (Max.)	2.5 VA	
Energizing Time	1s (Minimum)	
Timing Range	0.6s to 600s	
Setting Accuracy	10% of Full scale	
Repeat Accuracy	± 1%	
Output	Relay Output	2 C/O
	Contact Rating	5A @ 240 VAC / 28 VDC (Resistive)
	Electrical Life	1x10 ⁵
	Mechanical Life	1x10 ⁷
Utilization Category	AC - 15	Rated Voltage (Ue): 120/240 V, Rated Current (Ie): 3.0/1.5 A
	DC - 13	Rated Voltage (Ue): 24/125/250 V, Rated Current (Ie): 2.0/0.22/0.1 A
Operating Temperature	-15°C to +60°C	
Storage Temperature	-20°C to +70°C	
Humidity (Non Condensing)	95% (Rh)	
LED Indication	Green LED → Power ON, Red LED → Relay ON	
Enclosure	Flame Retardant UL94-V0	
Dimension (W x H x D) (in mm)	22.5 X 75 X 100.5	
Weight (unpacked)	130 g	
Mounting	Base / DIN Rail	
Certification		
Degree of Protection	IP 20 for Terminals, IP 40 for Enclosure	

EMI / EMC

Harmonic Current Emissions	IEC 61000-3-2
ESD	IEC 61000-4-2
Radiated Susceptibility	IEC 61000-4-3
Electrical Fast Transients	IEC 61000-4-4
Surges	IEC 61000-4-5
Conducted Susceptibility	IEC 61000-4-6
Voltage Dips & Interruptions (AC)	IEC 61000-4-11
Voltage Dips & Interruptions (DC)	IEC 61000-4-29
Conducted Emission	CISPR 14-1
Radiated Emission	CISPR 14-1

Environmental

Cold Heat	IEC 60068-2-1
Dry Heat	IEC 60068-2-2
Vibration	IEC 60068-2-6
Repetitive Shock	IEC 60068-2-27
Non-Repetitive Shock	IEC 60068-2-27

Electronic Timer - Series Micon® 225



MOUNTING DIMENSION (mm)

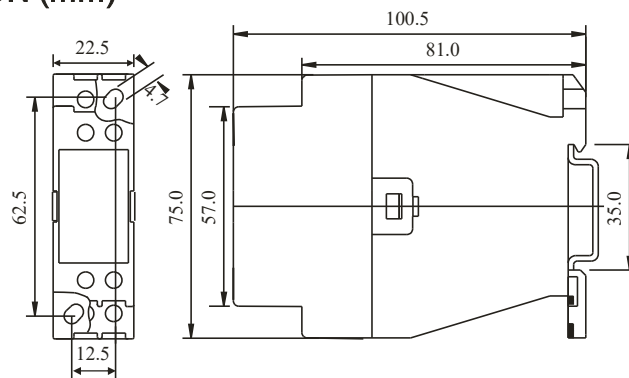

**2A5DT5, 2B5DT5, 2AODT5, 2ASDT0, 2ASDT1,
2BSDT0, 2BSDT1, 2AADT5,
20JDTT, 20NDTT, 2ANDT0, 23GDT0, 2A6DT6, 2B6DT6**

CONNECTION DIAGRAM

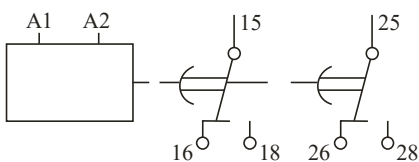

2A5DT5, 2B5DT5, 2AADT5, 23GDT0, 2AODT5

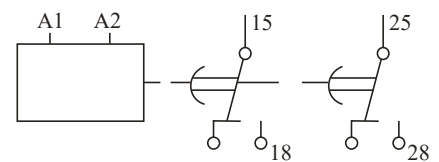

2ASDT0, 2BSDT0, 2ASDT1, 2BSDT1

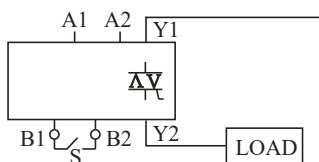

20JDTT, 20NDTT

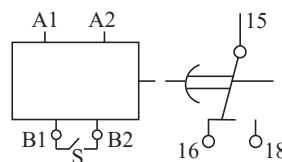

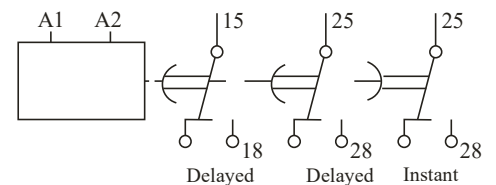

2ANDT0

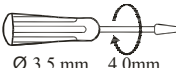

2A6DT6, 2B6DT6

TERMINAL TORQUE & TERMINAL CAPACITY

 Ø 3.5 mm....4.0mm	0.6 N.m (5.3 Lb.in)
	1 x 4.0 mm ² Solid/Stranded Wire
AWG	1 x 20 to 10

Motor Control Timers

- Compact 17.5mm wide
- Brown Out Timer with many functional options
- Detects Voltage Dips and Momentary Loss of Supply & Resets the control panel
- Low Power Consumption
- Fast Response Time
- Excellent Noise Immunity to the latest IEC standards



Ordering Information

Cat. No.	Description
17UDT0	230 VAC, Brown Out Timer (ON Delay), 1 C/O
17UDT1	230 VAC, Brown Out Timer (Interval), 1 C/O
13UDT0	110 VAC, Brown Out Timer (ON Delay), 1 C/O
13UDT1	110 VAC, Brown Out Timer (Interval), 1 C/O
1FUDT0F	110 VAC, Brown Out Timer (Normally Energized / ON Delay Mode), Fast Response (5 msec max), 1C/O
1FUDT1F	110 VAC, Brown Out Timer (Momentary / Pulse Mode), Fast Response (5 msec max), 1C/O
1FUDT2F	110 VAC, Brown Out Timer (Normally De-energized / Pulse Mode), Fast Response (5 msec max), 1C/O

Motor Control Timers



Cat. No.	17UDT0	13UDT1
Parameters	Brown Out Timer	
Timer Description	Brown Out Timer	
Modes	ON Delay	Interval
Functional Diagram		
Supply Voltage (Φ)	160-250 VAC	75-125 VAC
Supply Variation		-30% to +10%
Frequency	50 Hz	60 Hz
Power Consumption (Max.)	10 VA	4 VA
Timing Range		0.3s to 30s
Initiate Time		Max. 100 ms
Trip Voltage	170 V (± 5 V)	88 V (± 5 V)
Recovery Voltage	Trip Voltage + 14 V (± 5 V)	Trip Voltage + 94 V (± 5 V)
Response Time		20 ms (max)
Setting Accuracy	± 10% @ 30s & ± 20% @ 0.3s	
Repeat Accuracy	± 1%	
Output	Relay Output	1 C/O
	Contact Rating	5A @ 240 VAC / 28 VDC (Resistive)
	Electrical Life	1x10 ⁵
	Mechanical Life	1x10 ⁷
Utilization Category	AC - 15	Rated Voltage (Ue): 240/125 VAC, Rated Current (Ie): 1.3/2.5 A
	DC - 13	Rated Voltage (Ue): 24/125/250 V, Rated Current (Ie): 2.0/0.22/0.1 A
Operating Temperature	-10°C to +55°C	
Storage Temperature	-15°C to +60°C	
Humidity (Non Condensing)	80% (Rh)	
LED Indication	Green	Healthy
	Red	Relay ON
Enclosure	Flame Retardant UL94-V0	
Dimension (W x H x D) (in mm)	17.5 X 58.5 X 90	
Weight (unpacked)	75 gm	
Mounting	Base / DIN rail	
Certification		
Degree of Protection	IP 20 for Terminals, IP 40 for Enclosure	

EMI / EMC

Harmonic Current Emissions	IEC 61000-3-2
ESD	IEC 61000-4-2
Radiated Susceptibility	IEC 61000-4-3
Electrical Fast Transients	IEC 61000-4-4
Surges	IEC 61000-4-5
Conducted Susceptibility	IEC 61000-4-6
Voltage Dips & Interruptions (AC)	IEC 61000-4-11
Conducted Emission	CISPR 14-1
Radiated Emission	CISPR 14-1

Environmental

Cold Heat	IEC 60068-2-1
Dry Heat	IEC 60068-2-2
Vibration	IEC 60068-2-6
Repetitive Shock	IEC 60068-2-27
Non-Repetitive Shock	IEC 60068-2-27

BROWN OUT

A dip in voltage causes electro-mechanical devices such as relays and contactors to drop out and electronic devices such as Timers, Programmable Relays, PLC's remain energized. As a result of this the switch sequence of the panel is lost. This can lock out all or a part of the control system causing the entire system to malfunction.

BROWN OUT TIMER

The 'Brown-Out' Timer also known as 'Mains restoration auto restart timer' is used for detection of voltage dips or momentary loss of supply known as 'Brown out' and initiation of a control panel reset following the Brown out.

Motor Control Timers

- Brown Out Timer with 3 Functions: ON Delay, Interval, Pulse
- Detects Voltage Dips and Momentary Loss of Supply & Resets the control panel
- Low Power Consumption
- Fast Response Time
- LED indications for Healthy & Unhealthy conditions
- Excellent Noise Immunity to the latest IEC standards



Ordering Information

Cat. No.	Description
23UDT0	110 VAC, Brown Out Timer with 3 Functions, 1 C/O
27UDT0	240 VAC, Brown Out Timer with 3 Functions, 1 C/O

Motor Control Timers



Cat. No.	23UDT0		27UDT0
Parameters			
Timer Description	Brown Out Timer		
Modes	ON Delay, Interval, Pulse		
Functional Diagram			
Supply Voltage (φ)	110 VAC		240 VAC
Supply Variation	- 40% to +10% (of φ)		
Frequency	50/60 Hz		50 Hz
Power Consumption (Max.)	2 VA		4 VA
Timing Range	0.3s to 30s		
Initiate Time	Max. 200 ms		
Trip Voltage	81 V (± 6 V)		168 V (± 6 V)
Recovery Voltage	96 V (± 4 V)		184 V (± 4 V)
Response Time	Voltage Interruptions Voltage Dips	15 ms (Max.) 30 ms (Max.)	
Setting Accuracy	± 5% of Full scale		
Repeat Accuracy	± 1%		
Output	Relay Output	1 C/O	
	Contact Rating	5A @ 240 VAC / 28 VDC (Resistive)	
	Electrical Life	1x10 ⁵	
	Mechanical Life	1x10 ⁷	
Utilization Category	AC - 15	Rated Voltage (Ue): 240/125 VAC, Rated Current (Ie): 1.3/2.5 A	
	DC - 13	Rated Voltage (Ue): 24/125/250 V, Rated Current (Ie): 2.0/0.22/0.1 A	
Operating Temperature	-10°C to +55°C		
Storage Temperature	-10°C to +60°C		
Humidity (Non Condensing)	80%		
LED Indication	Healthy Condition: Green LED On, Unhealthy Condition: Green LED Flashing slow		
	Colour	Amber	Red
Enclosure	Flame Retardant UL94-V0		
Dimension (W x H x D) (in mm)	22.5 X 75 X 100.5		
Weight (unpacked)	130 g		
Mounting	Base / DIN rail		
Certification			
Degree of Protection	IP 20 for Terminals, IP 40 for Enclosure		

EMI / EMC

Harmonic Current Emissions	IEC 61000-3-2
ESD	IEC 61000-4-2
Radiated Susceptibility	IEC 61000-4-3
Electrical Fast Transients	IEC 61000-4-4
Surges	IEC 61000-4-5
Conducted Susceptibility	IEC 61000-4-6
Voltage Dips & Interruptions (AC)	IEC 61000-4-11
Conducted Emission	CISPR 14-1
Radiated Emission	CISPR 14-1

Environmental

Cold Heat	IEC 60068-2-1
Dry Heat	IEC 60068-2-2
Vibration	IEC 60068-2-6
Repetitive Shock	IEC 60068-2-27
Non-Repetitive Shock	IEC 60068-2-27

Motor Control Timers

- Single phase Motor Restart Control Timer with Memory Time
- Under Voltage Trip and ON Delay



Ordering Information

Cat. No.	Description
22LDT0	240 VAC, Motor Restart Control Timer, 1 C/O
23LDT0	110 VAC, Motor Restart Control Timer, 1 C/O

UL Approval not applicable for Cat No. 23LDT0

Motor Control Timers



Cat. No.	22LDT0	23LDT0
Parameters		
Timer Description	Motor Restart Control Timer	
Functional Diagram	<p style="text-align: center;">t: Power Fail Time; Td: Delay Time; Tm: Memory Time</p>	
Supply Voltage (ϕ)	240 VAC	110 VAC
Supply Variation	- 20% to +10% (of ϕ)	
Frequency	50/60 Hz	
Power Consumption (Max.)	4 VA	2 VA
Timing Ranges	Memory Time (Tm): 0.2 to 6s, Delay Time (Td): 0.2 to 60s	
Trip Voltage	176 VAC, (\pm 6VAC)	80 VAC, (\pm 6VAC)
Hysteresis	10 VAC (Max.)	
Reset Time	200 ms (Max.)	
Setting Accuracy	\pm 5% of Full scale	
Repeat Accuracy	\pm 1%	
Output	Relay Output	1 C/O
	Contact Rating	5A @ 240 VAC / 28 VDC (Resistive)
	Electrical Life	1×10^5
	Mechanical Life	1×10^7
Utilization Category	AC - 15	Rated Voltage (Ue): 230/125 V, Rated Current (Ie): 1.3/2.5 A
	DC - 13	Rated Voltage (Ue): 250/120/24 V, Rated Current (Ie): 0.1/0.22/2 A
Operating Temperature	-15°C to +60°C	
Storage Temperature	-20°C to +70°C	
Humidity (Non Condensing)	95% (Rh)	
LED Indication	Green LED \rightarrow Power ON, Red LED \rightarrow Relay ON	
Enclosure	Flame Retardant UL94-V0	
Dimension (W x H x D) (in mm)	22.5 X 75 X 100.5	
Weight (unpacked)	130 g	
Mounting	Base / DIN Rail	
Certification		
Degree of Protection	IP 20 for Terminals, IP 40 for Enclosure	

EMI / EMC

Harmonic Current Emissions	IEC 61000-3-2
ESD	IEC 61000-4-2
Radiated Susceptibility	IEC 61000-4-3
Electrical Fast Transients	IEC 61000-4-4
Surges	IEC 61000-4-5
Conducted Susceptibility	IEC 61000-4-6
Voltage Dips & Interruptions (AC)	IEC 61000-4-11
Conducted Emission	CISPR 14-1
Radiated Emission	CISPR 14-1

Environmental

Cold Heat	IEC 60068-2-1
Dry Heat	IEC 60068-2-2
Vibration	IEC 60068-2-6
Repetitive Shock	IEC 60068-2-27
Non-Repetitive Shock	IEC 60068-2-27

WORKING

The timer is used for instantaneous or delayed motor startup after a short-time power failure (max. 6 sec). The start occurs immediately if power supply is disrupted for less than 0.2 sec. If the power failure lasts longer, the relay activates its memory for a time that can be set to 0.2 to 6 sec, after which no automatic restart is possible. If power supply is restored while the memory period is elapsing, the relay commands a motor restart with a delay time from power supply restoration that can be set to 0.2 to 60 sec. A system stop cancels the memory function after 50 ms, and therefore the stop signal should be on for at least this time. The relay is non-sensitive to any control voltage fluctuation or disruption during or after the motor stop.

Motor Control Timers

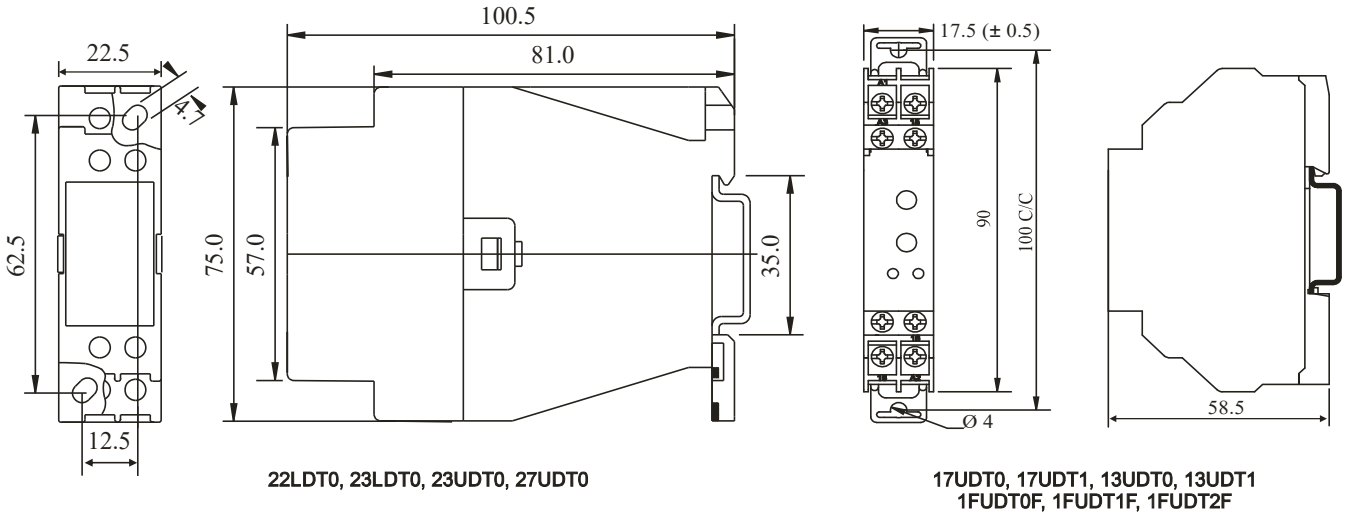

MOUNTING DIMENSION (mm)



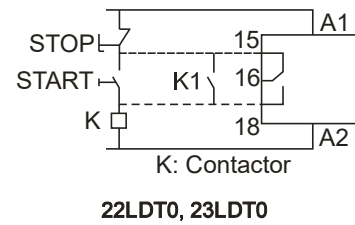
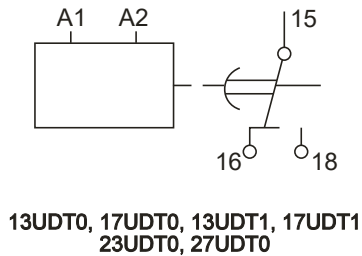

CONNECTION DIAGRAM

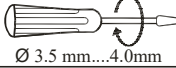

TERMINAL TORQUE & TERMINAL CAPACITY

 Ø 3.5 mm...4.0mm	0.60 N.m (6 Lb.in)
	1 x 4.0 mm ² Solid/Stranded Wire
AWG	1 x 20 to 10

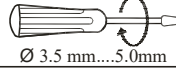
22LDT0, 23LDT0, 23UDT0, 27UDT0

 Ø 3.5 mm...5.0mm	0.80 N.m (7.1 Lb.in)
	2 x 2.5 mm ² Solid/Stranded Wire
AWG	2 x 20 to 14

13UDT0, 17UDT0, 13UDT1, 17UDT1

Synchronous Timer - Series EM 1000

- Time delay is independent of normal voltage and temperature fluctuations
- Black pointer gives clear indication of the time set on the calibrated dial while the red one indicates the time left to complete the cycle
- Automatic reset on de-energisation of the clutch coil
- Base mounting or flush mounting versions
- No-volt feature available



Ordering Information

Timing Ranges(SR)	B	<input type="checkbox"/>	<input type="checkbox"/>	<input type="checkbox"/>	<input type="checkbox"/>	<input type="checkbox"/>
B 0.15 - 3.0 SEC						
C 1.5 - 30 SEC						
D 0.15 - 3.0 MIN						
E 1.5 - 30 MIN						
F 0.15 - 3.0 HRS						
G 1.5 - 30 HRS						
H 0.3 - 6.0 SEC						
J 3.0 - 60 SEC						
K 0.3 - 6.0 MIN						
L 3.0 - 60 MIN						
M 0.3 - 6.0 HRS						
N 3.0 - 60 HRS						
P 0.6 - 12 SEC						
Q 6.0 - 120 SEC						
R 0.6 - 12 MIN						
S 6.0 - 120 MIN						
T 0.6 - 12 HRS						
V 6 - 120 HRS						
	Timing Ranges(MR)					
	X 0.15 SEC.-3.0 HRS.					
	Y 0.3 SEC.- 6.0 HRS.					
	Z 0.6 SEC.-12.0 HRS.					
	Voltage					
	3 110V AC 50 Hz					
	4 240V AC 50 Hz					
	C 110V AC 60 Hz					
	D 240V AC 60 Hz					
	Delay					
	1 Standard ON delay					
	2 With 'NO VOLT'					
	Mounting					
	B Base Mounting					
	F Flush (door) Mtg.					
	Contact					
	1 1 Inst + 1 Del C/O					
	2 1 Inst + 2 Del C/O					

Synchronous Timer - Series EM 1000



Mode	ON Delay	ON Delay Retentive (No Volt)
Functional Diagram		
Supply Variation	- 20% to +10%	
Frequency Variation	95% to 105%	
Power Consumption (Max.)	10 VAC	
Timing Range	0.15s to 120h	
Repeat Accuracy	± 0.5% of Full Scale Range @ Constant Frequency	
Output	Output Contact	1 Instant + 1 Delayed / 1 Instant + 2 Delayed (Optional)
	Contact Rating	6A (resistive) @ 250 VAC
	Switching Frequency	3000 operations/hr. (Max.)
Operating Temperature	-5°C to 45°C	
Enclosure	Conforms to IP30 - IS 13947.	
Dimension (W x H x D) (in mm)	96 X 96 X 100	
Weight (unpacked)	530 g	
Mounting	Flush / Base	
Terminal Connection	1– 2.5 mm ² solid/stranded.	
Degree of Protection	IP20	

MOUNTING DIMENSION (mm)

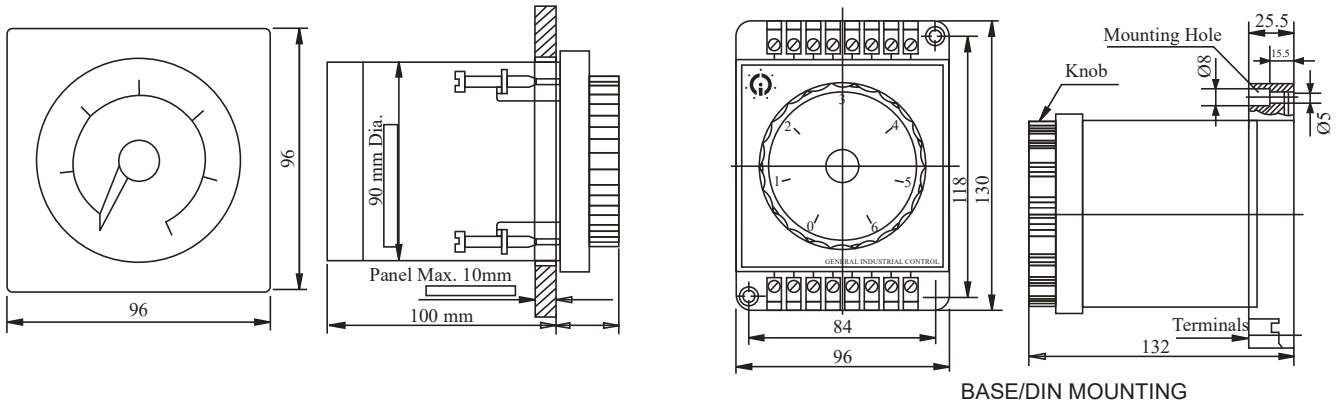

CONNECTION DIAGRAM

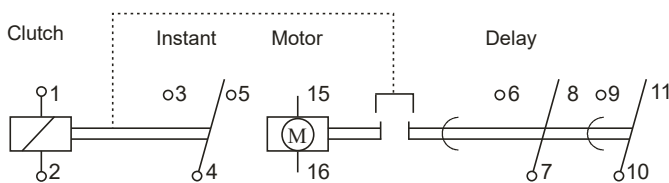

TERMINAL TORQUE & CAPACITY

Ø 3.5 mm....5.0mm	0.80 N.m (7.1 Lb.in)
	2 x 2.5 mm ² Solid/Stranded Wire
AWG	2 x 20 to 14

Product Selection Chart : Timers

Product Selection Chart : Timers

Cat. No.	Supply Voltage					Timing Range							Signal		Relay Output			Function						
	12 to 240 VAC / DC	24 to 240 VAC / DC	240 to 415 VAC / DC	240 VAC or 24 VAC / DC	110 to 240 VAC	3 sec to 120 sec	0.6 Sec to 600 sec	0.1 sec to 10 hrs	0.3 sec to 30 hrs	0.1 sec to 100 hrs	0.1 sec to 999 hrs	0.1 sec to 120 days	0.1 sec to 999 days	Potential Signal	Potential Free Signal	1 C/O	2 C/O	2 NO	ON Delay	Asymmetrical ON/OFF Delay	True OFF Delay	Star Delta	Multi-Function	
12ODT4				●			●									●			●					
12WDTC			●				●									●			●					
1CMDT0	●						●							●		●			●					●
1CJDT0	●						●									●				●				
12SDT0					●													●				●		
2AODT5		●					●											●						
2ASDT0		●					●											●				●		
2BSDT0			●				●											●				●		
2A8DT6		●									●							●					●	
2A5DT5		●					●											●					●	
2B5DT5			●				●											●					●	
2ANDT0		●															●						●	
2AADT5		●					●											●						
23GDT0		●															●				●			
V0DDTS		●															●						●	
V0DDTD		●																●					●	
V0DDTS1		●															●						●	
V0DDTD1		●																●					●	
V7DFTS3																							●	
V7DDSS3																							●	



TIME SWITCHES

Time Switch FM Series

Digital Time Switch *Crono*[®] *Pro*

Digital Time Switch *Astro*[®] *Pro*

Digital Time Switch *Astro*[®]

Lighting Automation with *Astro*[®] Using GSM Technology

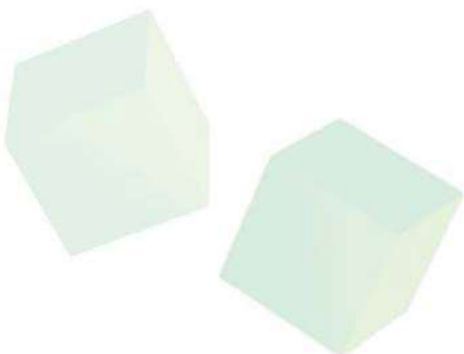

Time Switch FM Series

- Modular construction
- Inbuilt over-ride facility
- High switching capacity
- Tamper proof sealing
- Daily/Weekly programming



Ordering Information

Cat. No.	Description
J648B1	FM/1 QT 240 VAC, Daily Dial, Base / DIN Mounting*
J848B1	FM/1 QW 240 VAC, Weekly Dial, Base / DIN Mounting*
J638B1	FM/1 QT 110 VAC, Daily Dial, Base / DIN Mounting*
J838B1	FM/1 QW 110 VAC, Weekly Dial, Base / DIN Mounting*

Note: For Flush Mounting model, replace B by F in Cat. No.

Time Switch FM Series



Cat. No.		J648B1
Parameters		
Supply Voltage \oplus	240 VAC	
Frequency	50/60 Hz	
Power Consumption (Max.)	2 VA	
Accuracy	± 1.5 s/day at 20°C	
Relay Output	1 C/O	
Contact Rating	Resistive	16A @ 250 VAC, 0.25A @ 220VDC
	Inductive ($\cos\phi = 0.6$)	8A @ 250 VAC, 0.1A @ 220 VDC
	Incandescent Lamp	1350 W
Shortest Switching Time	Daily	15min
	Weekly	2h
Power reserve	150h	
Memory locations	N. A.	
Storage Temperature	- 20°C to + 55°C	
Manual Over-ride	Provided	
Mounting	Flush, Base / DIN rail	
Weight (unpacked)	185 g	
Certification	CE	
Degree of Protection	IP50 for front panel	

MOUNTING DIMENSION (mm)

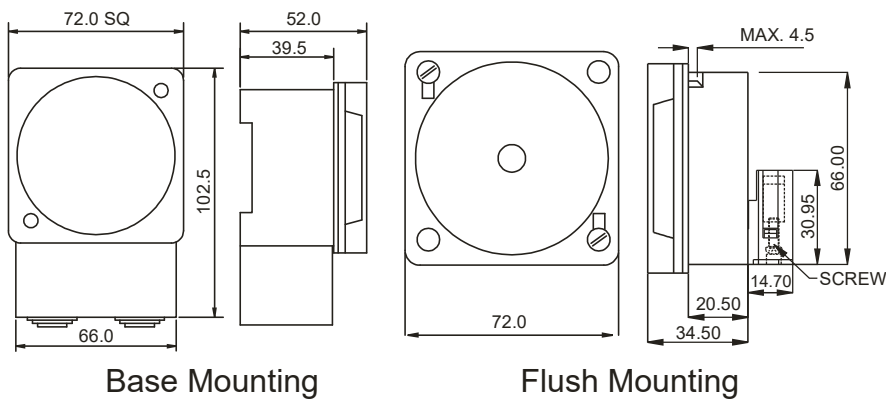

CONNECTION DIAGRAM

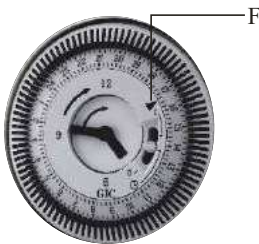
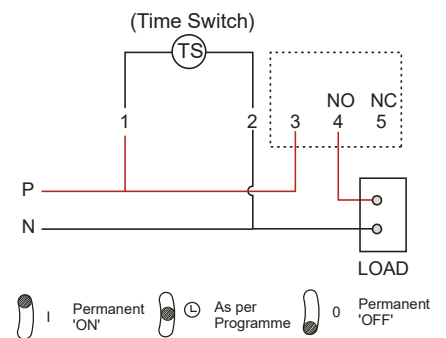



TIME SETTING:

Rotate the switching Dial in clockwise direction until the current time (day / time incase of weekly model) is almost opposite to the marking arrow F. For fine adjustment rotate the minute hand in the clockwise direction until the clock shows the current time.

PROGRAMMING:

Required Switch ON time is set on the Switching Dial by radially pulling outwards the corresponding black segments. Each segment on daily dial corresponds to 15 mins. & on weekly Dial corresponds to 2 hours.

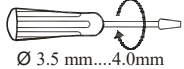
TERMINAL TORQUE & CAPACITY

 Ø 3.5 mm....4.0mm	0.60 N.m (6 Lb.in)
	1 x 4.0 mm ² Solid/Stranded Wire
AWG	1 x 20 to 10

*Products available for sale only in selected Countries

Digital Time Switch *Crono*[®] *Pro*

- LCD Display with Green backlight
- Precise time Programming for Daily / Weekly / Pulse switching
- Bar graph showing Daily program
- 50 ON/OFF programs, 10 Holiday Programs
- Settable DST feature & Password protection
- 16A Single and Dual relay outputs
- Two Separate Relay outputs with independent Programming
- 12/24 Hour Display Format
- 6 Years Battery reserve
- Simple reset & Manual Override
- Service / Load hours measurement





Ordering Information

Cat. No.	Description
WT1SCDS	240 VAC, Digital Time Switch - Crono Pro, 1 C/O
WT2DCDS	110-240 VAC, Digital Time Switch - Crono Pro, 2 C/O
67DDT0	110 - 240 VAC, Digital Time Switch - Crono, 1 C/O
6GHDT0	24 VDC, Digital Time Switch - Crono, 1 C/O
69HDT0	12 VDC, Digital Time Switch - Crono, 1 C/O
67DDT9	110 - 240 VAC, Digital Time Switch - Pulse, 1 C/O
6GHDT9	24 VDC, Digital Time Switch - Pulse, 1 C/O
69HDT9	12 VDC, Digital Time Switch - Pulse, 1 C/O

Note: Digital Time Switch - Crono available with IEC 60730-2-7 approval
UL approval is not applicable for Crono Pro series

Digital Time Switch *Crono*[®] *Pro*



Cat. No.	WT1SCDS (<i>Crono</i> [®] <i>Pro</i>)	67DDT0 (<i>Crono</i> [®])
Parameters		
Supply Voltage	240 VAC	110 - 240 VAC
Supply Variation	-20 % to +10%	
Frequency	50/60 Hz	
Power Consumption (Max.)	6 VA	4 VA
Number of Programs	50 Each channel + 10 for Holiday	25 ON/OFF Programs
Minimum Switching Time	1 sec	1 min
Pulse Duration	1 - 59 sec	N A
Number of Operating Modes	5	
Description of Modes	<ul style="list-style-type: none"> • AUTO - Program Run • ON AUTO - Instant ON up to next Auto Event • AUTO OFF - Instant OFF up to next Auto Event • ON - Continuous ON • OFF - Continuous OFF 	
Display	LCD with backlight	
DST	Programmable	
Clock Accuracy	± 0.5 s/day max. over the Operating Temperature range	± 2 s/day max. over the Operating Temperature range
Power Reserve from Factory	6 Years	
Output	Relay Output	1 C/O
	Contact Rating	16 A (NO) & 16 A (NC) @ 240 VAC/24 VDC (Resistive)
	Electrical Life	5x10 ⁴
	Mechanical Life	5x10 ⁴
Utilization Category	Max switching : 16 A (NO & NC) at 250 VAC, Cos ϕ = 1	AC - 15 Rated Voltage (Ue): 120/240 V, Rated Current (Ie): 3/1.5 A
	Min Switching: 10 A (NO & NC) at 250 VAC, Cos ϕ = 0.6	DC - 13 Rated Voltage (Ue): 24/125/250 V, Rated Current (Ie): 2.0/0.22/0.11 A
Operating Temperature	-10°C to + 55°C	-10°C to + 55°C
Storage Temperature	-20°C to + 70°C	-10°C to + 60°C
Humidity (Non Condensing)	95% (Rh)	
LED Indication	Red LED → Relay ON	
Enclosure	Flame Retardant UL94-V0	
Dimension (W x H x D) (in mm)	36 X 90 X 65	
Weight (unpacked) Approx.	110 g	
Mounting	DIN rail	Base / DIN rail
Certification	  	
Degree of Protection	IP 20 for Terminals, IP 40 for Enclosure	

EMI / EMC

Harmonic Current Emissions	IEC 61000-3-2
ESD	IEC 61000-4-2
Radiated Susceptibility	IEC 61000-4-3
Electrical Fast Transients	IEC 61000-4-4
Surges	IEC 61000-4-5
Conducted Susceptibility	IEC 61000-4-6
Voltage Dips & Interruptions (AC)	IEC 61000-4-11
Conducted Emission	CISPR 14-1
Radiated Emission	CISPR 14-1

Environmental

Cold Heat	IEC 60068-2-1
Dry Heat	IEC 60068-2-2
Vibration	IEC 60068-2-6
Repetitive Shock	IEC 60068-2-27
Non-Repetitive Shock	IEC 60068-2-27

Applications

Ideal for Lighting applications like street lighting, Advertising Displays, Glowsigns. Also can be used for Air conditioners / Coolers, Geysers, conveyors, pumps etc.

Ideal for Siren, Bell applications

Digital Time Switch *Astro*[®] *Pro*

- LCD Display with Green backlight
- Precise time programming for Astro / Daily / Weekly / Pulse / Cyclic switching
- Latitude / Longitude Database for 45 Countries and 280 cities
- Settable Latitude / Longitude precise to the minute with time zone
- Sunrise/Sunset or Twilight rise/set trigger modes
- Ease of Day selection in Weekly programming
- 50 ON/OFF programs, 10 Holiday Programs
- Settable DST feature & Password protection
- 16A Single and Dual relay outputs
- Two Separate Relay outputs with independent Programming
- 12/24 Hour Display Format
- 6 Years Battery reserve
- Simple Reset & Manual Override
- Service/Load hours measurement



Ordering Information

Cat. No.	Description
AT1SCDS	240 VAC, Digital Time Switch - Astro Pro+, 1 C/O
AT2DCDS	110-240 VAC, Digital Time Switch - Astro Pro+, 2 C/O
AS1SCDS	240 VAC, Digital Time Switch - Astro Pro, 1 C/O
AS2DCDS	110-240 VAC, Digital Time Switch - Astro Pro, 2 C/O
T2DDT7	110 - 240 VAC, Digital Time Switch - Astro Mini, 1 C/O
T2DDT8	110 - 240 VAC, Digital Time Switch - Astro Mini, 1 C/O (With Pre-defined City codes)

Digital Time Switch *Astro*[®] *Pro*



Cat. No.	AT1SCDS (<i>Astro Pro+</i>)	AS1SCDS (<i>Astro Pro</i>)	T2DDT7 (<i>Astro Mini</i>)
Parameters			
Supply Voltage (⊕)	240 VAC		110 - 240 VAC
Supply Variation	-20 % to +10% (of ⊕)		
Frequency	50/60 Hz		
Power Consumption	6 VA		
Programming	Latitude / Longitude Database for 45 Countries and 280 cities		Based on Latitude/Longitude precise to the minute with time-zone
	Precise time Programming for Daily / Weekly / Pulse / Cyclic switching	NA	NA
Number of Programs	50 Each channel + 10 for Holiday		NA
Trigger Modes	Sunrise/Sunset or Twilight Rise/Set		
Offset	00 to 99 minutes (Programmable)		
OFF Hours	Programmable		
Weekly Off	User Defined		
DST	User Defined		
Number of Operating Modes	5		3
Description of Modes	<ul style="list-style-type: none"> • AUTO - As per user defined program settings • ON AUTO - Instant ON up to next Auto Event • AUTO OFF - Instant OFF up to next Auto Event • ON - Continuous ON • OFF - Continuous OFF 		<ul style="list-style-type: none"> • AUTO - As per user defined program settings • ON AUTO - Instant ON up to next Auto Event • AUTO OFF - Instant OFF up to next Auto Event
Minimum Switching Time	1 min (1s for Pulse)	1 min	1 min
Display	LCD with backlight		3 Lines Text LCD
Clock Accuracy	± 0.5 s/day max. over the Operating Temperature range		± 2 s/day max. over the Operating Temperature range
Power Reserve from Factory	6 Years		
Output	Relay Output	1 C/O	
	Contact Rating	16 A (NO) & 16 A (NC) @ 240 VAC/24 VDC (Resistive)	16A (NO) & 5A (NC) @ 240 VAC / 24 VDC (Resistive)
	Electrical Life	5x10 ⁴	3x10 ⁴
	Mechanical Life	5x10 ⁴	5x10 ⁴
Utilization Category	AC - 15	16 A (NO & NC) at 250 VAC, Cos Ø = 1	Rated Voltage (Ue): 120/240 V, Rated Current (Ie): 3/1.5 A
	DC - 13	10 A (NO & NC) at 250 VAC, Cos Ø = 0.6	Rated Voltage (Ue): 24/125/250 V, Rated Current (Ie): 2.0/0.22/0.11 A
Operating Temperature	-15°C to + 55°C		-10 C to + 55 C
Storage Temperature	-20°C to + 70°C		-10 C to + 60 C
Humidity (Non Condensing)	95% (Rh)		
LED Indication	Indication on LCD		Red LED → Relay ON
Enclosure	Flame Retardant UL94-V0		
Dimension (W x H x D) (in mm)	36 X 90 X 65		
Weight (unpacked)	110 g		
Mounting	DIN rail		Base / DIN rail
Certification			
Degree of Protection	IP 20 for Terminals, IP 40 for Enclosure		
EMI / EMC	Harmonic Current Emissions IEC 61000-3-2 ESD IEC 61000-4-2 Radiated Susceptibility IEC 61000-4-3 Electrical Fast Transients IEC 61000-4-4 Surges IEC 61000-4-5 Conducted Susceptibility IEC 61000-4-6 Voltage Dips & Interruptions (AC) IEC 61000-4-11 Conducted Emission CISPR 14-1 Radiated Emission CISPR 14-1		Environmental Cold Heat IEC 60068-2-1 Dry Heat IEC 60068-2-2 Vibration IEC 60068-2-6 Repetitive Shock IEC 60068-2-27 Non-Repetitive Shock IEC 60068-2-27

Applications

Street lighting applications in cities, industrial townships, university campuses
Lighting automation in sports complex, hotels, parks & other outdoor applications.

Digital Time Switch *Crono*[®] *Pro* & *Astro*[®] *Pro*

MOUNTING DIMENSION (mm)

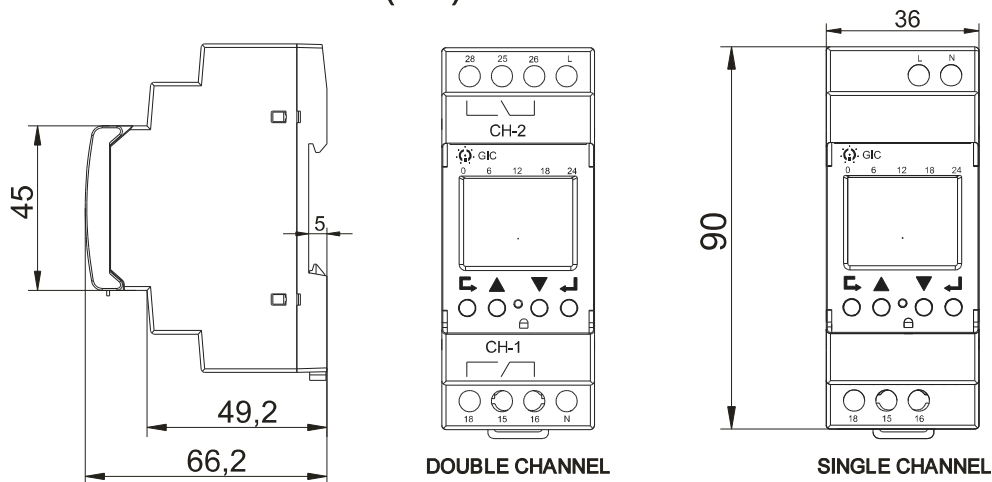

CONNECTION DIAGRAM

Digital Time Switch *Crono*[®] *Pro*

A) 1 CH Device

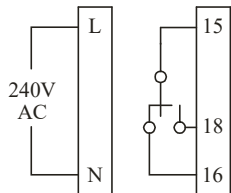

B) 2 CH Device

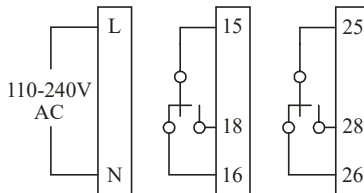

Digital Time Switch *Astro*[®] *Pro*

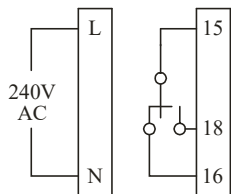

A) 1 CH Device

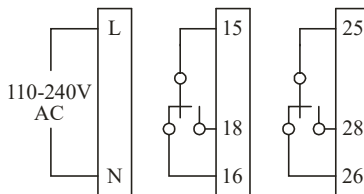

B) 2 CH Device



TERMINAL TORQUE & CAPACITY

 Ø 4.5 mm	0.5 N.m (4.4 Lb.in)
	1 x 4.0 mm ² Solid/Stranded Wire
AWG	26 to 10

Digital Time Switch *Astro*[®]

- Dynamic and Accurate control based on Astronomical Mathematics
- Sunrise / Sunset or Twilight rise / set trigger
- Yearly programming with Season mode, DST, Offset, OFF hours, Weekly Off features
- Protection against Under Voltage and Over Voltage
- Alternate Mode with Auto Load Changeover feature
- Active Phase selection
- Manual override facility
- Single phase and Three phase versions
- Modbus Communication
- User friendly software for device configuration





Ordering Information

Cat. No.	Description
T2DDT0	110 - 240 VAC, Astro with Two Independent Channel Output, 2 NO
T3DDT0	110 - 240 VAC, Astro with Three Independent Channel Output, 3 NO
TGDDT6	Windows based Application software for Astro
GFDNN1	USB Interface Cable
GFDNN2S	RS 232 Serial Interface Cable
GFDNN3M	Memory Card

Digital Time Switch *Astro*[®]



Cat. No.	T2DDT0	T3DDT0
Parameters		
Supply Voltage (φ)	110 - 240 VAC	110 - 240 VAC (3 Phase, 4 Wire)
Supply Variation	-20 % to +10% (of φ)	
Frequency	50/60 Hz	
Programming	Based on Latitude/Longitude precise to the minute with time-zone	
Trigger Modes	Sunrise/Sunset or Twilight Rise/Set	
Offset	1 min to 23 hr 59 min (Programmable)	
OFF Hours	Programmable	
Weekly Off	User Defined	
Alternate Mode	Yes	
Seasonal Mode	User Defined	
DST	User Defined	
Number of Operating Modes	3	
Mode Description	<ul style="list-style-type: none"> • AUTO - As per user defined program settings • ON AUTO - Instant ON up to next Auto Event • AUTO OFF - Instant OFF up to next Auto Event 	
Minimum Switching Time	1 min (1s for Pulse)	
Display	Backlit LCD	
Under Voltage Trip Level	N A	0 - 220 V (Settable)
Over Voltage Trip Level	N A	130 - 330 V (Settable)
Trip Time for UV/OV	N A	2 - 5 sec
Recovery Time	N A	10 - 20 sec
Clock Accuracy	± 1 s/day max. over the Operating Temperature range	
Power Reserve from Factory	6 years	
Output	Relay Output	2 NO
	Contact Rating	8A @ 240 VAC & 5A @ 30 VDC (Resistive)
	Electrical Life	1x10 ⁵
	Mechanical Life	1x10 ⁷
Utilization Category	AC - 15	Rated Voltage (Ue): 120/240 V, Rated Current (Ie): 3/1.5 A
	DC - 13	Rated Voltage (Ue): 24/125/250 V, Rated Current (Ie): 2.0/0.22/0.11 A
Operating Temperature	-10°C to + 50°C	
Storage Temperature	-10°C to + 60°C	
Humidity (Non Condensing)	95% (Rh)	
Enclosure	Flame Retardant UL94-V0	
Dimension (W x H x D) (in mm)	72 X 90 X 67	
Weight (unpacked)	190 g	208 g
Mounting	Base / DIN rail	
Certification	  	
Degree of Protection	IP 20 for Terminals, IP 40 for Enclosure	

EMI / EMC

Harmonic Current Emissions	IEC 61000-3-2
ESD	IEC 61000-4-2
Radiated Susceptibility	IEC 61000-4-3
Electrical Fast Transients	IEC 61000-4-4
Surges	IEC 61000-4-5
Conducted Susceptibility	IEC 61000-4-6
Voltage Dips & Interruptions (AC)	IEC 61000-4-11
Conducted Emission	CISPR 14-1
Radiated Emission	CISPR 14-1

Environmental

Cold Heat	IEC 60068-2-1
Dry Heat	IEC 60068-2-2
Vibration	IEC 60068-2-6
Repetitive Shock	IEC 60068-2-27
Non-Repetitive Shock	IEC 60068-2-27

Digital Time Switch *Astro*[®]



MOUNTING DIMENSION (mm)

Astro[®]

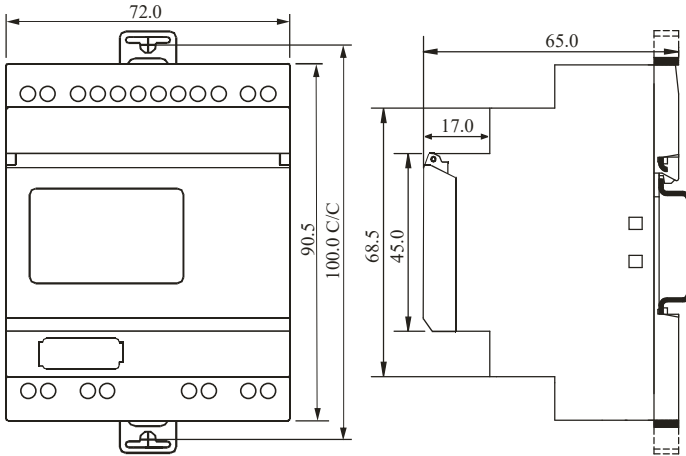

T2DDT0, T3DDT0

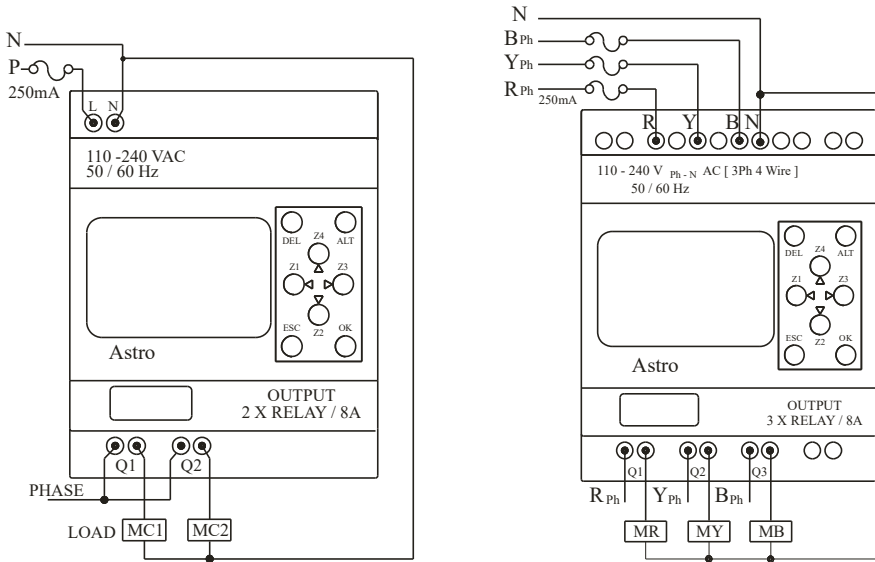

CONNECTION DIAGRAM



T2DDT0, T3DDT0

MC1, MC2, MR, MY, MB: CONTACTOR COILS

TERMINAL TORQUE & CAPACITY

 Ø 3.5	0.54 N.m (6 Lb.in)
	1 x 2.5 mm ² Solid Wire/Stranded
AWG	1 x 24 to 12

T2DDT0, T3DDT0

Lighting Automation with *Astro*[®] using GSM Technology

- Most of the "ASTRO" parameters can be set remotely using SMS queries. I.e. Output mode, Offset Hrs etc, UV, OV settings.
- Relay Output can be override remotely using SMS query.
- Energy Meter Functionality. Parameter like Load current, Supply voltage, Power, Energy can be known remotely.
- With the help of "Auto Error Code Update" following onsite error can be known remotely during output event.
 - Under Voltage
 - Over Voltage
 - Over Current
 - Output actuator short.
 - Load Open





Ordering Information

Cat. No.	Description
19D2000C	Surge Suppressor
19D20B00	Astro GSM Module (GSM-ERT5), Remote Side
19A1000B	Communication Cable (TTL-TTL) between Astro & GSM Module
TGDDT6	Windows based application software for Astro

Lighting Automation with *Astro*[®] using GSM Technology



Cat. No.	19D20B00 (ERT 5)
Parameters	
Supply Voltage (ϕ)	240 VAC (3 Phase, 4 Wire)
Supply Variation	-30% to +25% (of ϕ)
Frequency	50/60 Hz
Active Phase selection	Yes
Operating Temperature	-15°C to + 60°C
GSM Type	Dual band 900 / 1800 GSM
GPRS Packet data	Class 10 coding scheme
AT cCommand set Suitability	N. A.
SMS Type Functionality	Data Call through GSM, SMS
SIM Holder	Text, Cell Broadcast
Antenna	Connected with the product
Antenna Impedance	50 Ω
Energy Measurement	Yes
Energy Measurement Accuracy	Class 0.5
Current Sensing Range	5A
CT Ratio	Settable up to 40
LED Indications	Tx, Rx, Network, Power, Pulse Out
Pulse Out rate	3200 pulses / kWh
Auxiliary Output	12 V DC, 200 mA
Mounting	Base / DIN Rail
Enclosure	Flame Retardant UL94-V0
Dimension (W x H x D) (in mm)	72 X 90 X 67
Weight (unpacked)	190 g
Certification	 

EMI / EMC

Harmonic Current Emissions	IEC 61000-3-2
ESD	IEC 61000-4-2
Radiated Susceptibility	IEC 61000-4-3
Electrical Fast Transients	IEC 61000-4-4
Surges	IEC 61000-4-5
Conducted Susceptibility	IEC 61000-4-6
Voltage Dips & Interruptions (AC)	IEC 61000-4-11
Conducted Emission	CISPR 14-1
Radiated Emission	CISPR 14-1

Environmental

Cold Heat	IEC 60068-2-1
Dry Heat	IEC 60068-2-2
Vibration	IEC 60068-2-6
Repetitive Shock	IEC 60068-2-27
Non-Repetitive Shock	IEC 60068-2-27

Note:

- ERT5 can measure maximum 5A & 1A current respectively.
- Maximum current measurement limit for ERT-5 is 200A.

Ex: 1. For CT selection if current required to be measured is upto 200A then CT of 200:5 A (CT ratio 40) needs to be used.

Lighting Automation with *Astro*[®] using GSM Technology



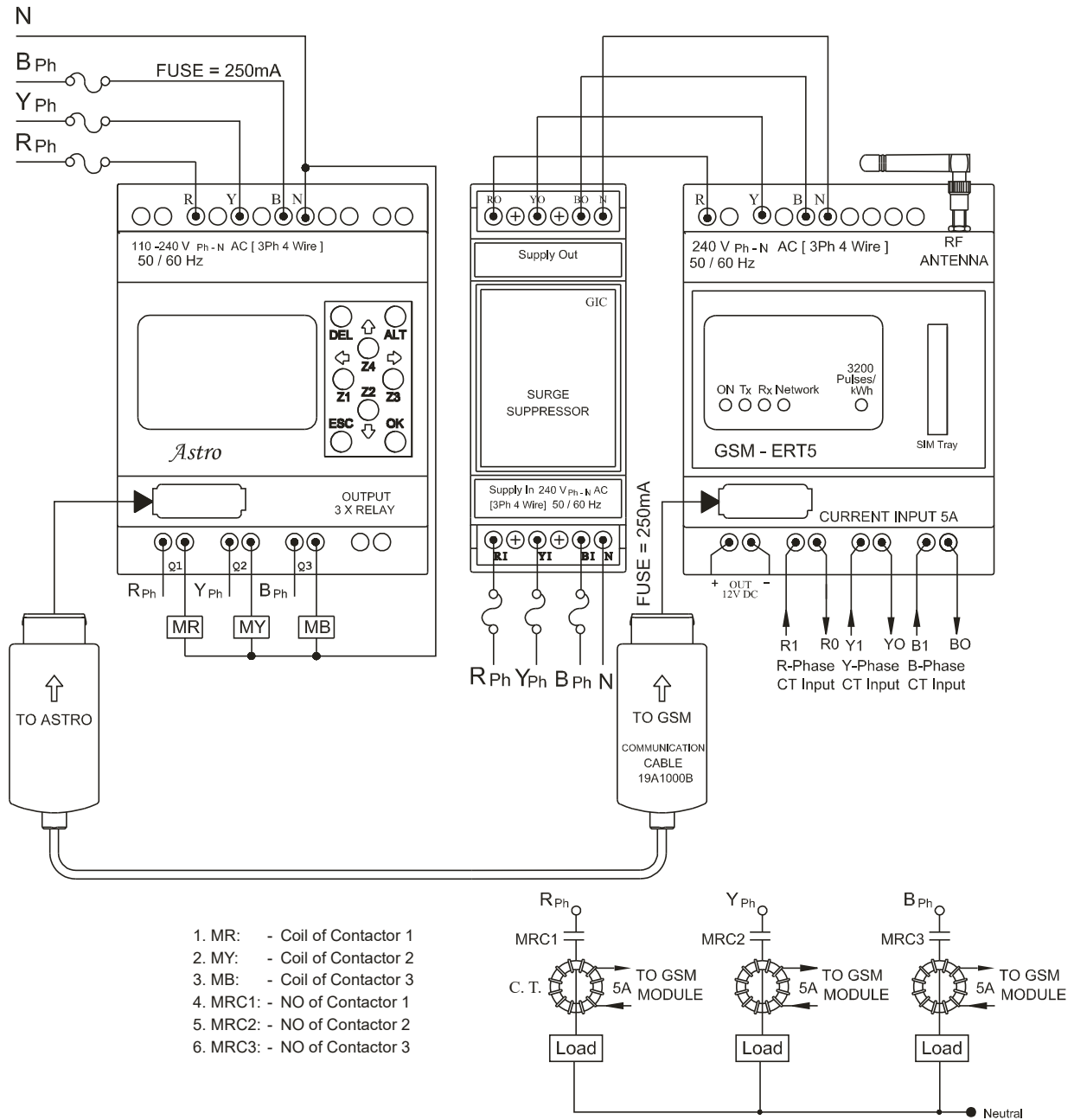

- Maximum 5 valid users can access the system remotely, using GSM functionality.
- To avoid Remote module's SIM theft, "SIM PIN" facility can be enabled remotely using SMS query.
- To avoid changes in system configuration by unauthorized user amongst valid users, important SMS queries are provided with "MODULE PIN" lock.
- Device supports for 12 to 14 digit mobile number. i.e. (10 Digit Mobile number + 2/3/4 digit country code).

CONNECTION DIAGRAM



TERMINAL TORQUE & CAPACITY

 Ø 3.5	0.54 N.m (6 Lb.in)
	1 x 2.5 mm ² Solid Wire/Stranded
AWG	1 x 24 to 12



HOUR METERS & COUNTERS

Hour Meter Series HM 36

Hour Meter Series HR 26

Digital Hour Meters

Impulse Counter Series CR 18

Impulse Counter Series CR 26

Impulse Counter Series CR 36

Digital Counters

Digital Hour Meter & Counter

Rate Indicator & Totaliser

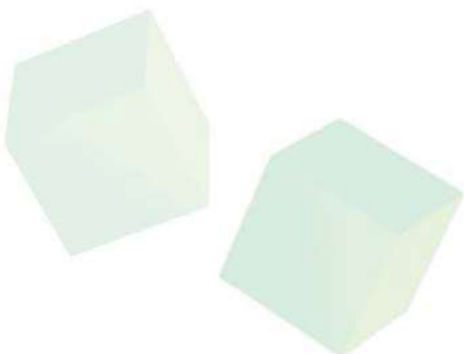

Hour Meter Series HM 36

- Robust design with high degree of Accuracy and Compact size
- Frequency independent for AC applications
- Indicates operating time in hours and tenths with running indicators
- Panel mountable with 7 Bezel options
- 6 Digit Non-Resettable with automatic recycle to zero
- Wide supply voltage range: 4 - 36V AC/DC, 10 - 80V DC & 90 - 264V AC
- Shock & Vibration Proof



Ordering Information

Cat. No.	Description
LA21F1	90 - 264 VAC, Rectangular Bezel
LA22F1	90 - 264 VAC, Rectangular 2 holes Bezel
LA23F1	90 - 264 VAC, Round Bezel
LA24F1	90 - 264 VAC, Round 3 holes Bezel
LA25F1	90 - 264 VAC, Square Mount Bezel
LA26F1	90 - 264 VAC, Cup Mount Bezel
LA27F1	90 - 264 VAC, Stirrup Mount Bezel
LD11F1	10 - 80 VDC, Rectangular Bezel
LD12F1	10 - 80 VDC, Rectangular 2 holes Bezel
LD13F1	10 - 80 VDC, Round Bezel
LD14F1	10 - 80 VDC, Round 3 holes Bezel
LD15F1	10 - 80 VDC, Cup Mount Bezel
LD16F1	10 - 80 VDC, Stirrup Mount Bezel
LD17F1	10 - 80 VDC, Square Mount Bezel
LC31F1	4 - 36 VAC/DC, Rectangular Bezel
LC32F1	4 - 36 VAC/DC, Rectangular 2 holes Bezel
LC33F1	4 - 36 VAC/DC, Round Bezel
LC34F1	4 - 36 VAC/DC, Round 3 holes Bezel
LC35F1	4 - 36 VAC/DC, Cup Mount Bezel
LC36F1	4 - 36 VAC/DC, Stirrup Mount Bezel
LC37F1	4 - 36 VAC/DC, Square Mount Bezel

Hour Meter Series HM 36



Cat. No.	LA25F1	LD15F1	LC36F1
Parameters			
Supply Voltage (Φ)	90 - 264 VAC	10 - 80 VDC	4 - 36 VAC/DC
Frequency	50/60 Hz	N A	50/60 Hz
Over Voltage & Reverse Polarity Protection	N A	Protected for 2 times Battery voltage and / or Reverse polarity	Not applicable to AC and 48V for DC Application
Power Consumption (Max.)	0.5 VA	0.25 VA	1 VA
Bezel	Square Mount	Cup Mount	Stirrup Mount
Register	6 Digit (3.6mm)		
Read Out	99999.9		
Least Count	1/10 h		
Accuracy	± 0.02% over entire range		
Vibration	10-80Hz with 20g max (SAE J1378)		
Shock	55g @ 9-13ms (SAE J1378)		
Weight (unpacked)	47g		
Temperature	-40° C to +85° C		
Humidity (Non Condensing)	95% (Rh)		
Mounting	Panel		
Termination	1/4" [6.3] Spade Terminal		
Degree of Protection	IP 66 (Front only with gasket)		
Approvals	SAE & NEMA 4X (Front only with gasket)		SAE & NEMA 4X (Front only with gasket)

Note: NEMA 4X IP 66 gaskets available for different Bezels

VIEWS OF DIFFERENT BEZELS



Rectangular Bezel



Rectangular 2 holes Bezel



Round Bezel



Round 3 holes Bezel



Cup Mount Bezel



Stirrup Mount Bezel

Hour Meter Series HM 36

- Robust design with high degree of Accuracy and Compact size
- Frequency independent for AC applications
- Indicates operating time in hours and tenths with running indicators
- 6 Digit Non-Resettable with automatic recycle to zero
- Wide supply voltage range: 90 - 460V AC, 10 - 80V DC & 110 V DC
- Suitable for Control Panel applications



Ordering Information

Cat. No.	Description
30A6B1	90 - 264 / 270 - 460 V AC, Hour Meter, Base/DIN
30A7B1	48 V AC, Hour Meter, Base/DIN
30D1B1	10 - 80 V DC, Hour Meter, Base/DIN
30D4B1	110 VDC, Hour Meter, Base/DIN
30C3B1	4 -36 VAC/DC, Hour Meter, Base/DIN

Hour Meter Series HM 36



Cat. No.	30A6B1	30D1B1	30D4B1	30C3B1
Parameters				
Supply Voltage (Φ)	90 - 264 / 270 - 460 VAC	10 - 80 VDC	110 VDC	4-36 VAC/DC
Frequency	50/60 Hz	N A	N A	50/60 Hz
Over Voltage	N A	96 VDC, 1 min	96 VDC, 1 min	48 VDC, 1 min
Reverse Polarity Protection	N A	Yes	Yes	Yes
Power Consumption (Max.)	1 VA Max	0.25 VA	0.5 VA	1 Watt (Max)
Register	6 Digit (3.6mm)			
Read Out	99999.9			
Least Count	1/10 h			
Accuracy	± 0.02% over entire range			
Weight (unpacked)	70g			
Operating Temperature	-5° C to +55° C			
Storage Temperature	-20° C to +70° C			
Humidity (Non Condensing)	95% (Rh)			
Mounting	Base/DIN Rail			
Degree of Protection	IP 20 for Terminals, IP 40 for Enclosure			
Approvals				

MOUNTING DIMENSIONS (mm)

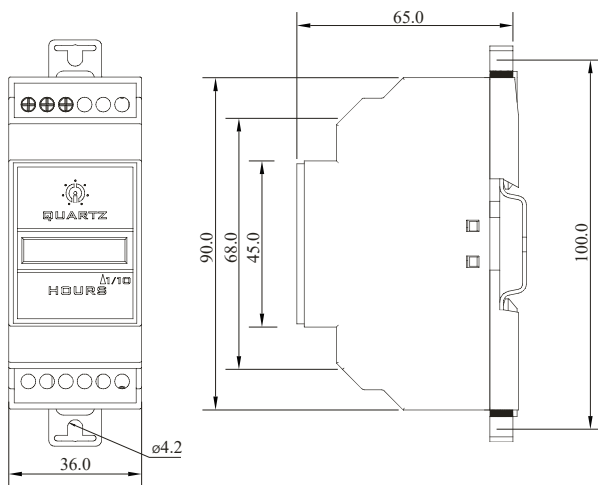

30A6B1, 30A7B1, 30D1B1, 30D4B1

TERMINAL TORQUE & CAPACITY

\varnothing 3.5...4.0 mm	Torque - 0.54 N.m (5 Lb.in) Terminal screw - M2.6
	Solid Wire - 1 X 0.2...3.3 mm ²
AWG	1 X 24 to 12

CONNECTION DIAGRAM

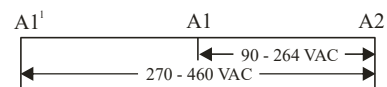

Hour Meter Series HM 36

MOUNTING DIMENSION (mm)

SQUARE MOUNT BEZEL (45 X 45 PANEL CUTOUT)

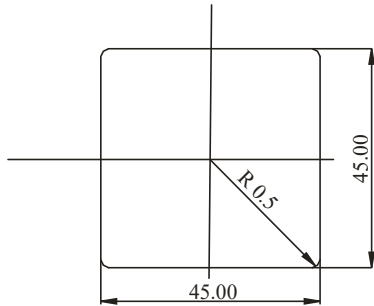

ROUND BEZEL, ROUND 3 HOLES BEZEL, CUP MOUNT BEZEL & STIRRUP MOUNT BEZEL

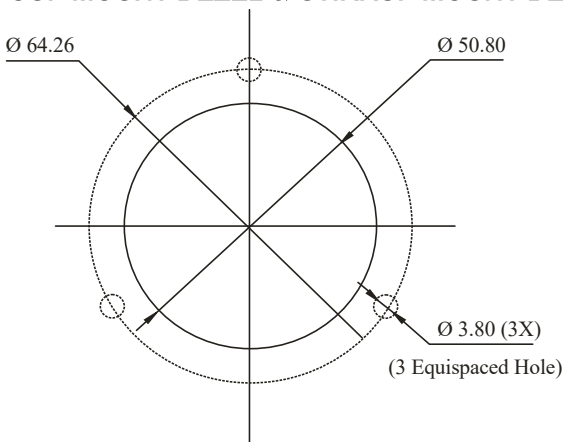

RECTANGULAR BEZEL

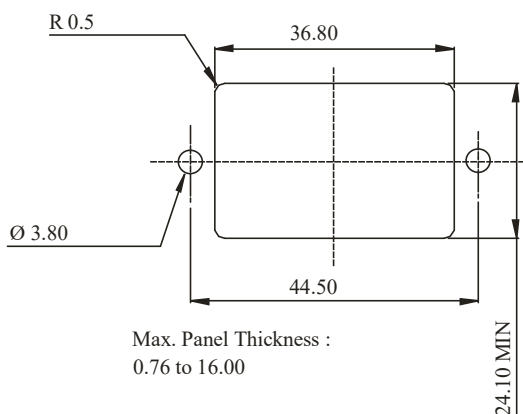

CONNECTION DIAGRAM

FOR: DC SERIES

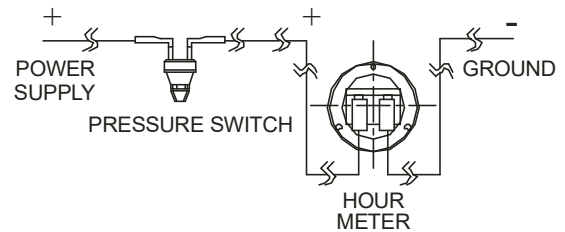
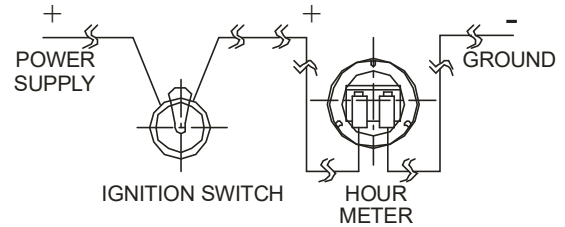

FOR: AC SERIES

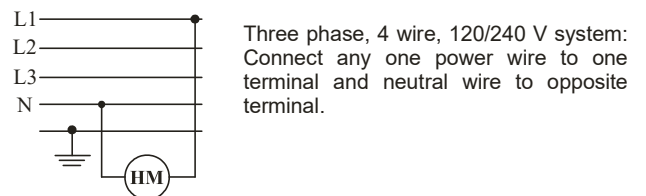
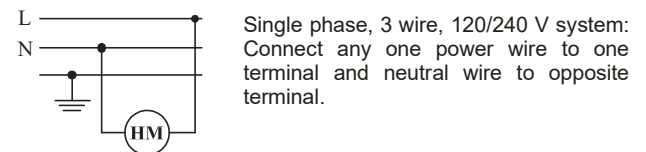
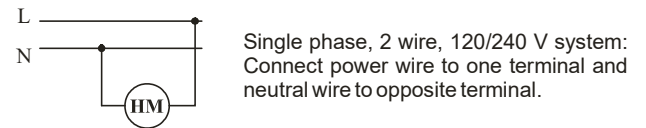

CAUTION
Tighten terminals with flat head screwdriver with tip size 4.3 x 0.6 mm.

Hour Meter Series HM 36

VIEWS OF DIFFERENT BEZELS

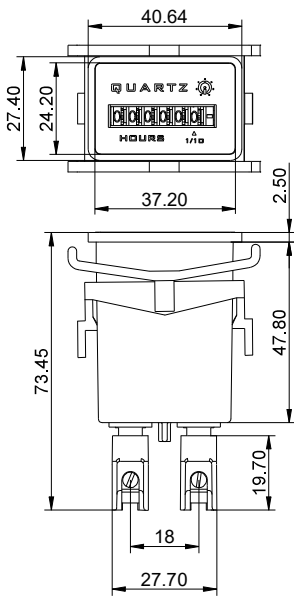

Rectangular Bezel

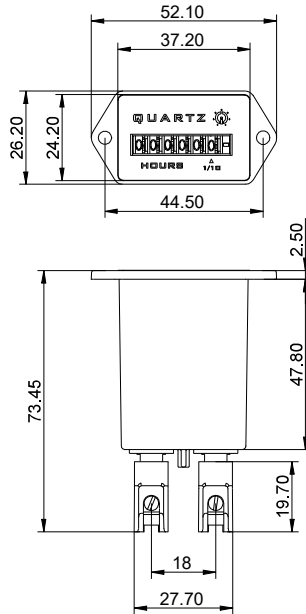

Rectangular 2 holes Bezel

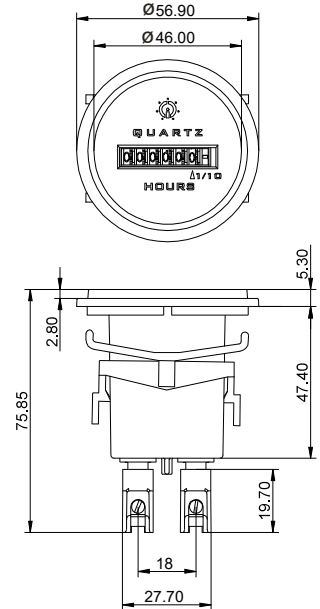

Round Bezel

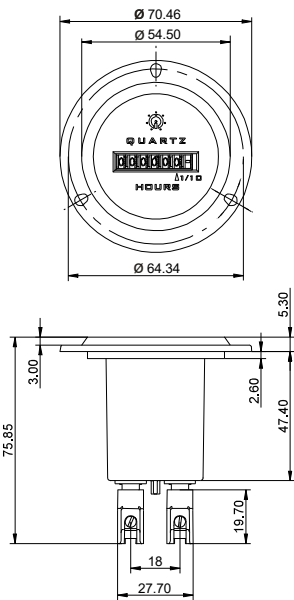

Round 3 holes Bezel

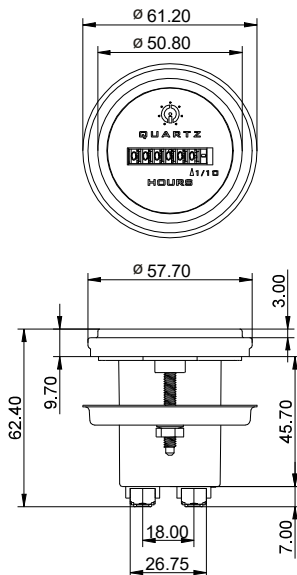

Cup Mount Bezel

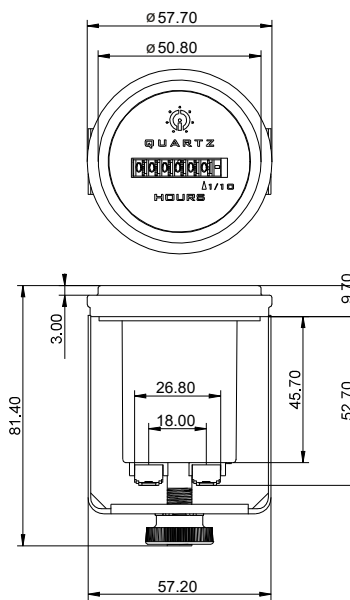

Stirrup Mount Bezel

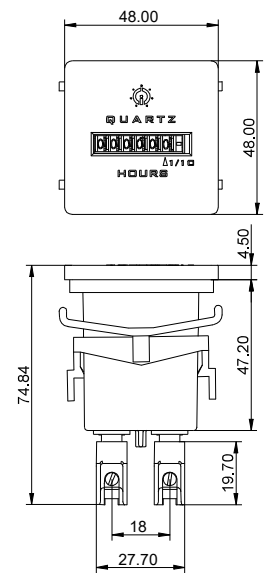

Square Bezel

Dimensions in mm

Hour Meter Series HR 26

- 6-digit Compact and Robust Design
- Push-button quick reset
- High Accuracy and Reliability
- Requires no lubrication or maintenance
- Optional locking for reset button
- Ideal where space is limitation
- Three mounting options: Bail, Panel, Base

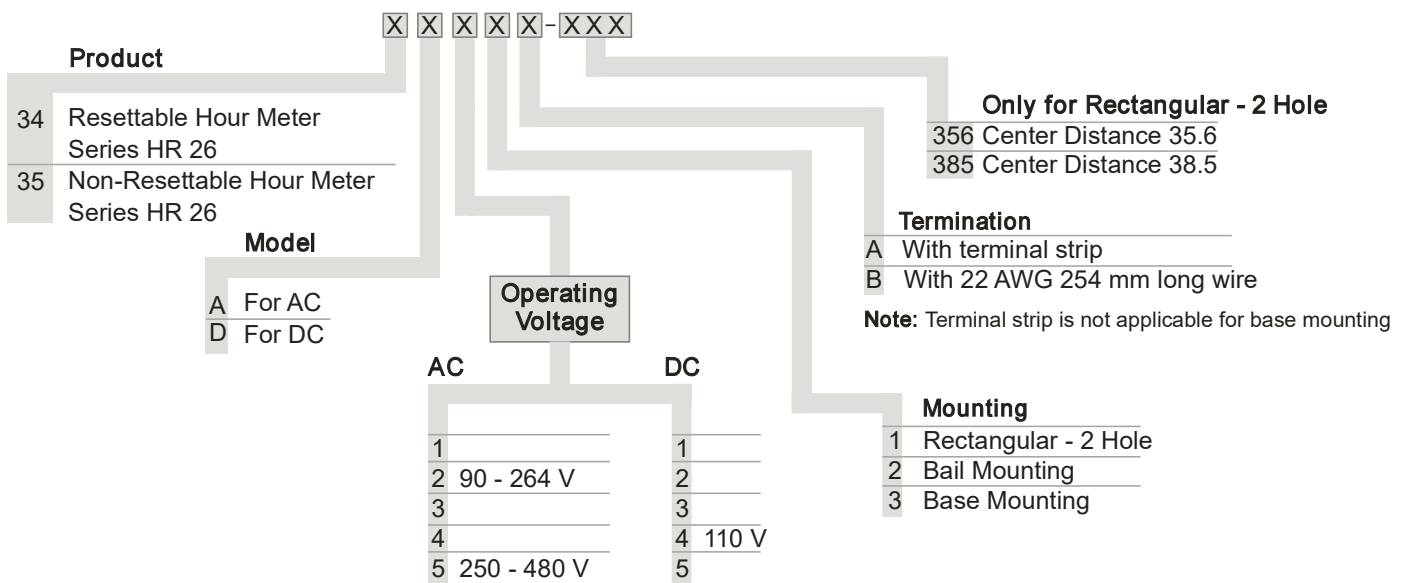

Hour Meter Series HR 26



Parameters	AC		DC
Supply Voltage & Frequency	90 - 264 VAC, 50/60 Hz	250 - 480, 50/60 Hz	110 VDC
Power Consumption (Max.)	0.35 VA	0.5 VA	0.25 W
Register	6 Digit (4.0 mm)		
Read Out	9999.9		
Least Count	1/10 Hrs		
Accuracy	±0.02% over entire range		
Weight	150gms (approx)		
Operating Temperature	-5° C to +55° C (Non-Freezing)		
Operating Humidity	45 ~ 85% RH (non-condensing)		
Termination	Termination- Pin type or Solid Wire 2.5mm ² , M3 Screw, 0.6Nm Torque. Or Termination also available with Wire 22 AWG, 254mm long.		
Type of Mounting	Panel, Bail & Base		
Degree of Protection	IP 30		
Certification			

MOUNTING DIMENSIONS (mm)

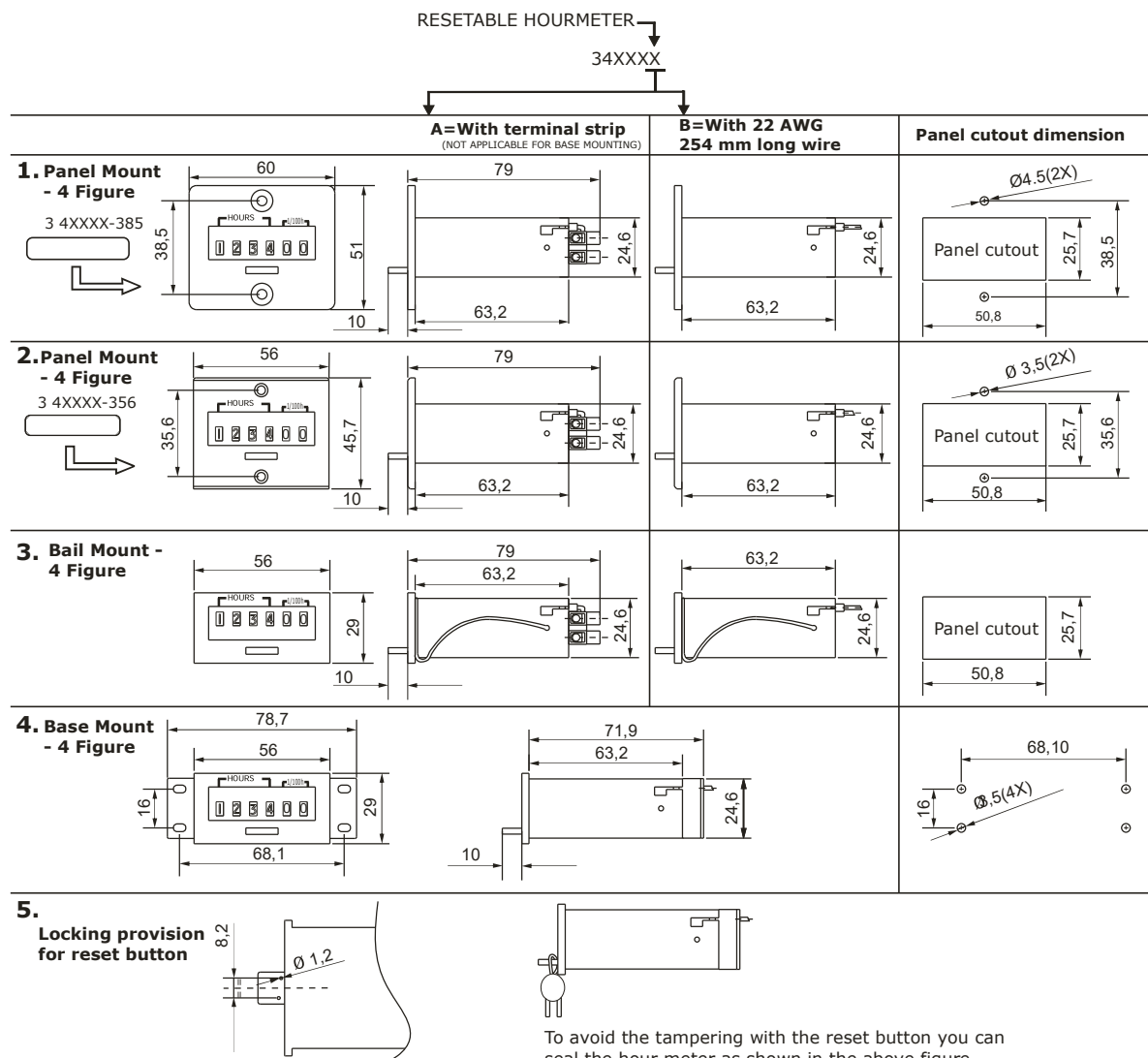

Note: For Resettable Hour Meter do not reset push button during change over.

Digital Hour Meter

- 6-digit LCD
- In-built nonvolatile memory (EEPROM) offering exceptional reliability
- Wide range of supply voltage
- Remote reset
- Available in 3 different Bezels
- Low Power Consumption



Ordering Information

Cat. No.	Description
Z71FBX	85-265 VAC model
ZJ1FBX	12-48 VAC/DC model
ZH1FBX	10-80 VDC model
X	A = Round Bezel, B = 24x48 Bezel, C = Screw Mount Bezel

Digital Hour Meter



Cat. No.	Z71FBX	ZJ1FBX	ZH1FBX
Parameters			
Supply Voltage (中)	85 - 265 VAC	12 - 48 VAC/DC	10 - 80 VDC
Frequency	50/60 Hz	50/60 Hz	N A
Power Consumption (Max.)	0.8 VA	0.4 W	0.6 W
Range	99999.9 h		
Display	6-digit LCD 5mm Height		
Resolution	1/10 h		
Accuracy	± 0.02%		
Memory Retention	100 Years		
Operating Temperature	-10° C to +50° C		
Storage Temperature	-20° C to +65° C		
Humidity	95% (Rh)		
Degree of Protection	IP54 (for front side only)		
Enclosure	UL94-V0		
Terminals	1, 2: Input Supply, 3: Enable 4: Reset		
Panel cut outs	Round Bezel, 24 x 48 Bezel, Screw Mount Bezel		
Mounting	Flush / Panel Mounting		
Certification			
Weight (unpacked)	With Round Bezel- 35g, with 24 x 48 Bezel- 29 g, with Screw Mount Bezel- 31 g		

EMI / EMC

Harmonic Current Emissions	IEC 61000-3-2 : Class A
ESD	IEC 61000-4-2 : Level III
Radiated Susceptibility	IEC 61000-4-3 : Level III
Electrical Fast Transients	IEC 61000-4-4 : Level IV
Surges	IEC 61000-4-5 : Level III
Conducted Susceptibility	IEC 61000-4-6 : Level III
Voltage Dips & Interruptions (AC)	IEC 61000-4-11 : Criteria A
Voltage Dips & Interruptions (DC)	IEC 61000-4-29 : Criteria A
Conducted Emission	CISPR 14-1 : Class B
Radiated Emission	CISPR 14-1 : Class B

Environmental

Cold Heat	IEC 60068-2-1
Dry Heat	IEC 60068-2-2
Vibration	IEC 60068-2-6
Repetitive Shock	IEC 60068-2-27
Non-Repetitive Shock	IEC 60068-2-27

Digital Hour Meter

MOUNTING DIMENSION (mm)

DIGITAL HOUR METER

SCREW MOUNT BEZEL

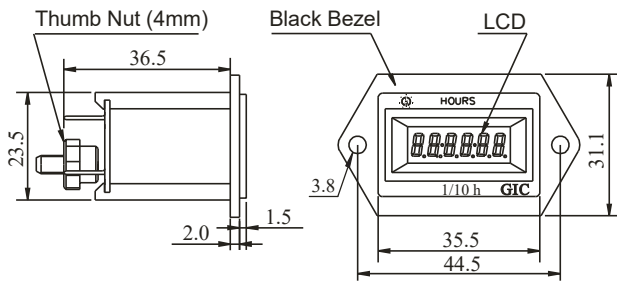

Recommended Panel Cutout :
37.0 (+0.5)mm x 24.6 (+0.5)mm

24X48 BEZEL

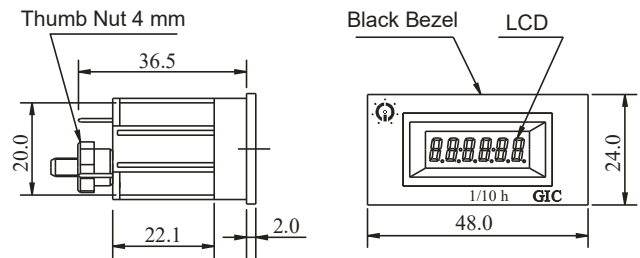

Recommended Panel Cutout :
45.5 (+0.5)mm x 23.0 (+0.5)mm

ROUND BEZEL

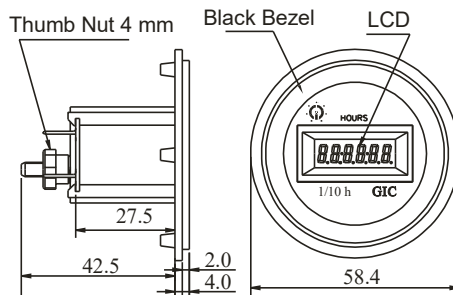

Recommended Panel Cutout :
37.0 (+0.5)mm x 24.6 (+0.5)mm

CONNECTION DIAGRAM

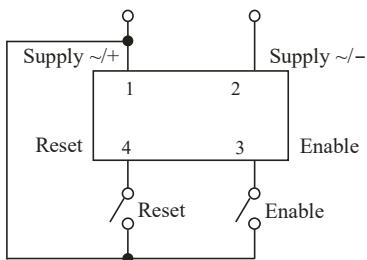

TERMINAL DESCRIPTION

- Pin 1: Supply (~ / +)
- Pin 2: Supply (~ -)
- Pin 3: Enable
- Pin 4: Reset

DIGITAL HOUR METER

Impulse Counter Series CR 18

- 7-digit Compact Size
- High Accuracy and Reliability
- Requires no lubrication or maintenance
- Ideal where space is limitation
- Mounting options: Panel, PCB, REAR

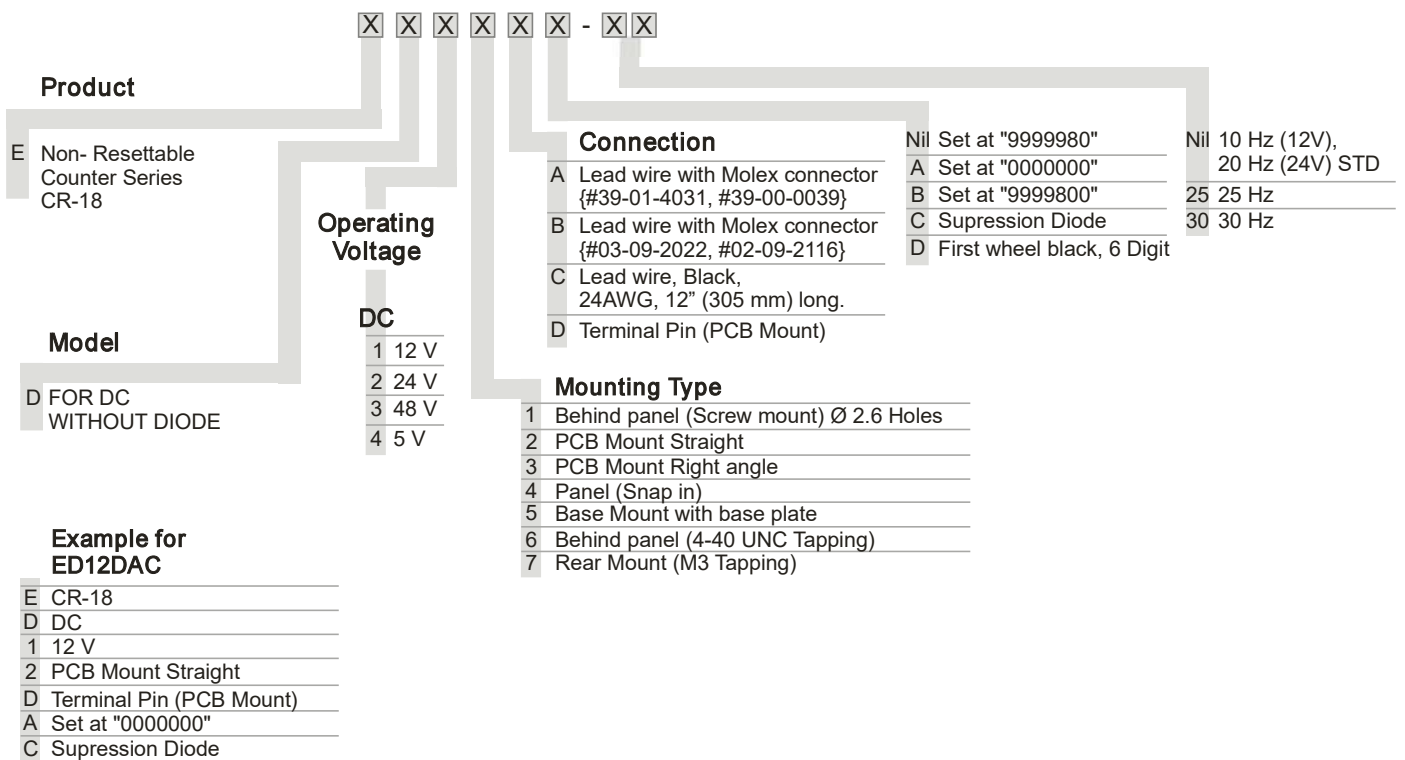

Impulse Counter Series CR 18

Cat. No.	ED11C	ED17C	ED22D	ED23D	ED24C
Parameters					
Supply Voltage (⌀)	12 V DC		24 V DC		
Supply Variation	±10%				
Power Consumption (Max.)	1.2 W				
Figure	7 Digit, Black, 4.0 mm Height (With magnifying glass)				
Maximum Range	99,99,999				
Operating Life	10,000,000 counts minimum				
Speed (Counts / Minute)	600 (50ms-ON / 50ms-OFF)		1200 (25ms-ON / 25ms-OFF)		
Pulse Width (minimum)	50 ms		25 ms		
Type of Mounting	Behind the panel	Rear Mount	PCB mount (Straight)	PCB mount (Right angle)	Panel (Snap-in type)
Connection	Lead wire 24 AWG		Terminal PIN (Pitch : 10 mm)	Terminal PIN (Pitch : 3.80 mm)	Lead Wire 24 AWG
Panel Cutout	N.A				1.20'(30.48) x 0.96'(24.38) Panel thickness - 0.04'(1.0) to 0.08'(2.0)
Weight (unpacked)	142 g				
Operating Temperature	-5° C to +55° C (Non-Freezing)				
Humidity (Non Condensing)	45 to 85% (Rh)				
Display	0.12'(3.0) x 0.06' (1.6) - White & black background				
Counting Method	One pulse - One count (energizing - ½ count, unenergized - ½ count)				
Reset	None				
Shock test	Endurance: 300 m/s (30g) XYZ 5 times each direction, Total : 3, Mismovement : 50 m/s (5g) XYZ 4 times each direction, Total : 24.				
Vibrations test	Endurance: 16.7 Hz, Width : 4mm ; XYZ each direction for 1 hour Mismovement : 10~55 Hz, Width : 0.5mm ; XYZ each direction for 10 mins				
Degree of Protection	IP 30				
Construction	Cover : Plastic (Noryl UL94V-1), Black				
Approvals					

VIEWS OF DIFFERENT BEZELS



Screw mount



Panel (Snap-in type)



PCB mount (Straight)



Horizontal Base Mount



Screw Mount Behind the panel

Impulse Counter Series CR 26

- 6-digit Compact Non Reset and Robust Design
- High Accuracy and Reliability
- Requires no lubrication or maintenance
- Ideal where space is limitation
- Three mounting options: Bail, Panel, Base, Behind Panel

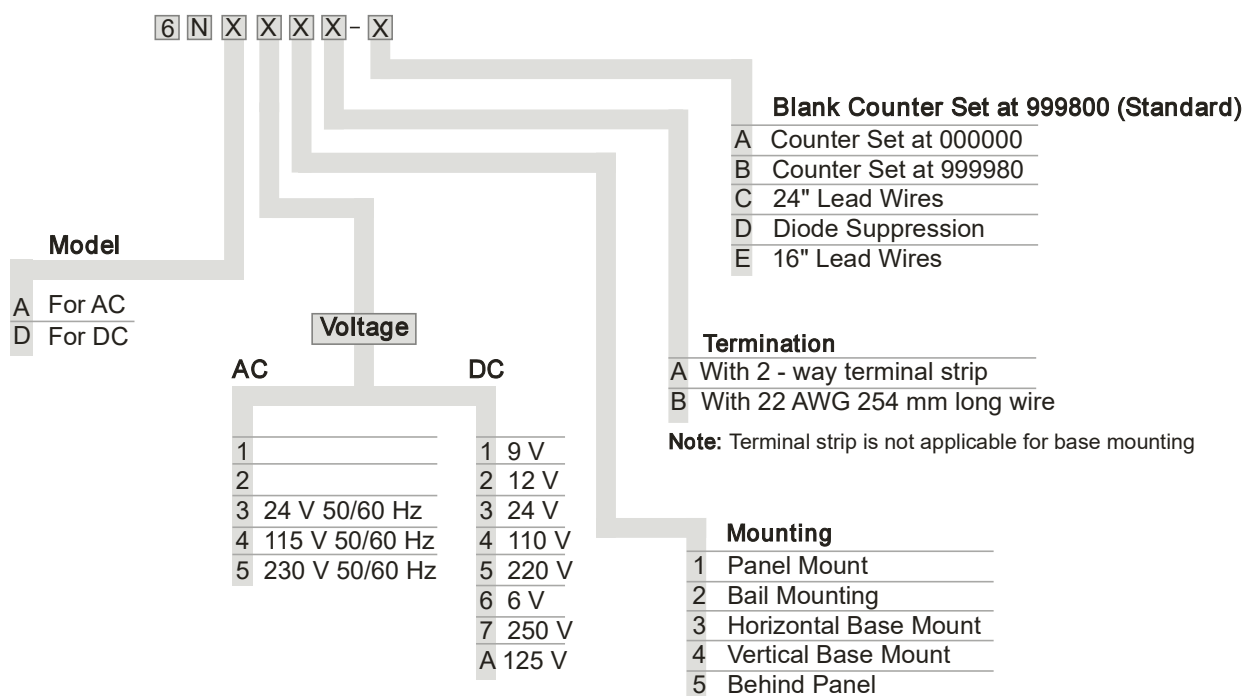

Impulse Counter Series CR 26

Cat. No.	6ND21A	6ND31A	6NA41A	6NA51A
Parameters				
Supply Voltage (ϕ)	12 VDC	24 VDC	115 VAC	230 VAC
Supply Variation	+10% to -10% (of ϕ)			
Power Consumption (Max.)	2 W		3 W	
Figure	6 Digit, White on Black, (2.0 X 4.0 mm) Height			
Maximum Range	999999			
Speed	10 Hz Maximum (600 Counts / Minute)			
Pulse Width	50 ms minimum			
Counting Method	One Pulse - One count (energizing - 1/2 count, de-energized - 1/2 count)			
Weight (unpacked)	113 g			
Operating Temperature	-5° C to +50° C (Non-Freezing, Non Condensing)			
Humidity (Non Condensing)	45 to 85% (Rh) (Non-Freezing, Non Condensing)			
Termination	22 AWG, 105° C wire leads, 280 mm long / 2 way Terminal Strip			
Type of Mounting	Panel, Bail, Base & Behind Panel			
Degree of Protection	IP 40 Front Panel			
Certification				
Applications	Ideal for use in - Machine tools, Business Machines, Test Instruments, Amusement Instruments and Measuring devices			

Note: Other voltages will be made available upon request.

VIEWS OF DIFFERENT BEZELS



Panel (Snap-in-type)



Screw Mount (Behind the Panel)



Horizontal Base Mount

Impulse Counter Series CR 26

MOUNTING DIMENSION (mm)

IMPULSE COUNTER CR 26 NON RESET (6 FIG)

Non Resettable Counter
6NXXXX

	A = With terminal strip	B = With 22 AWG 254 mm long wire	Panel cutout dimension
1. Panel Mount - 6 Figure 6NXX1X 			
2. Bail Mount - 6 Figure 6NXX2X 			
3. Horizontal Base Mount - 6 Figure 6NXX3X 			
4. Vertical Base Mount - 6 Figure 6NXX4X 			
5. Behind Panel Mount - 6 Figure 6NXX5X 			

Impulse Counter Series CR 26

- 6-digit Compact and Robust Design
- Push-button quick reset
- High Accuracy and Reliability
- Requires no lubrication or maintenance
- Optional locking for reset button
- Ideal where space is limitation
- Three mounting options: Bail, Panel, Base

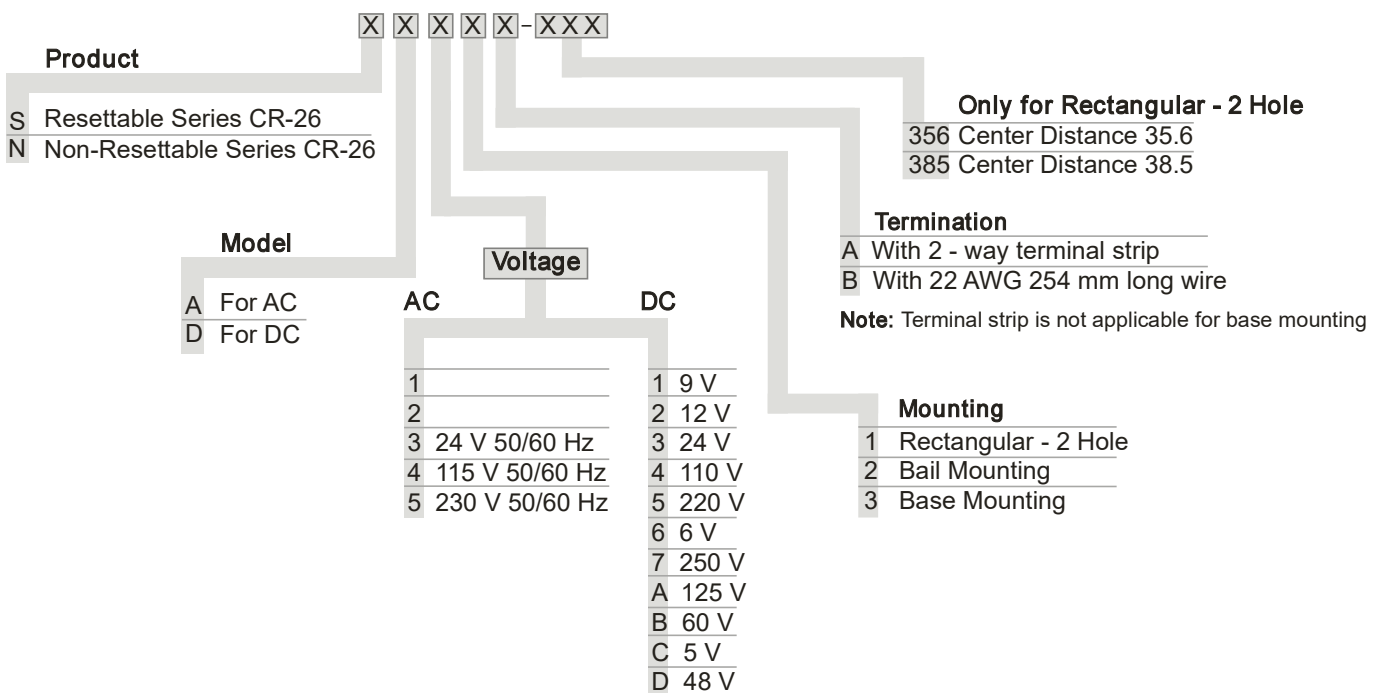

Note: Other voltages will be made available upon request.

Impulse Counter Series CR 26



Cat. No.	SD21A-385	SD31A-385	SA41A-356	SA51A-356
Parameters				
Supply Voltage (ϕ)	12 VDC	24 VDC	115 VAC	230 VAC
Supply Variation	+10% to -15% (of ϕ)			
Power Consumption (Max.)	2 W		3 W	
Figure	6 Digit, White on Black, (4.0 mm) Height			
Maximum Range	9,99,999			
Operating Life	Beyond 100 million counts			
Speed	10 Hz Maximum (600 Counts / Minute)			
Pulse Width	50 ms minimum			
Counting Method	One Pulse - One count (energizing - 1/2 count, de-energized - 1/2 count)			
Continuous Energizing	Permissible			
Reset	Manual push button Reset (Reset button can be locked or sealed to avoid accidental reset)			
Weight (unpacked)	142 g			
Operating Temperature	-5° C to +50° C (Non-Freezing)			
Humidity (Non Condensing)	45 to 85% (Rh)			
Termination	22 AWG, 105° C wire leads, 254 mm long / 2 way Terminal Strip			
Type of Mounting	Panel, Bail & Base			
Degree of Protection	IP 30			
Certification				
Applications	Ideal for use in - Machine tools, Business Machines, Test Instruments, Amusement Instruments and Measuring devices			

Note: Do not push reset button during change over.

Impulse Counter Series CR 26 (4-Digit)

- 4-digit Compact and Robust Design
- Push-button quick reset
- High Accuracy and Reliability
- Requires no lubrication or maintenance
- Optional locking for reset button
- Ideal where space is limitation
- Three mounting options: Bail, Panel, Base

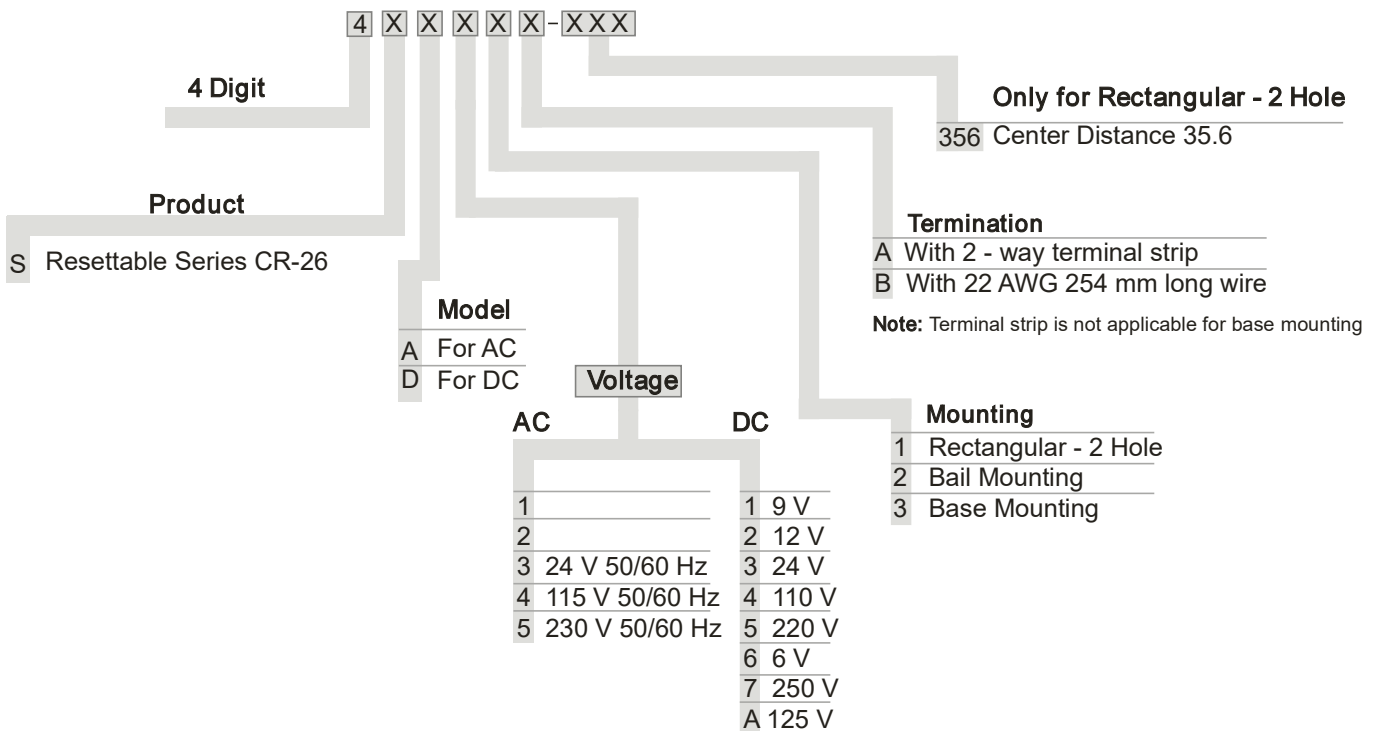

Note: Other voltages will be made available upon request.

Impulse Counter Series CR 26 (4-Digit)



Cat. No.	4SD21A-356	4SD31A-356	4SA41A-356	4SA51A-356
Parameters				
Supply Voltage (ϕ)	12 VDC	24 VDC	115 VAC	230 VAC
Supply Variation	+10% to -15% (of ϕ)			
Power Consumption (Max.)	2 W		3 W	
Figure	4 Digit, White on Black, (4.0 mm) Height			
Maximum Range	9999			
Operating Life	Beyond 100 million counts			
Speed	10 Hz Maximum (600 Counts / Minute)			
Pulse Width	50 ms minimum			
Counting Method	One Pulse - One count (energizing - 1/2 count, de-energized - 1/2 count)			
Continuous Energizing	Permissible			
Reset	Manual push button Reset (Reset button can be locked or sealed to avoid accidental reset)			
Weight (unpacked)	113 g			
Operating Temperature	-5° C to +50° C (Non-Freezing)			
Humidity (Non Condensing)	45 to 85% (Rh)			
Termination	22 AWG, 105° C wire leads, 254 mm long / 2 way Terminal Strip			
Type of Mounting	Panel, Bail & Base			
Degree of Protection	IP 30			
Certification				
Applications	Ideal for use in - Machine tools, Business Machines, Test Instruments, Amusement Instruments and Measuring devices			

Note: Do not push reset button during change over.

Impulse Counter Series CR 26

MOUNTING DIMENSION (mm)

IMPULSE COUNTER CR 26

Resettable Counter
SXXXA

	A=With terminal strip	B=With 22 AWG 254 mm long wire	Panel cutout dimension
1. Panel Mount - 6 Figure SXXX-385			
2. Panel Mount - 6 Figure SXXX-356			
3. Bail Mount - 6 Figure			
4. Base Mount - 6 Figure			
5. Optional locking for reset button			To avoid the tampering with the reset button you can seal the counter as shown in the above figure
NON RESETTABLE COUNTER- NXXXXA			
<p>A = Counter with Terminal Strip(not applicable for Base Mounting)</p> <p>B = Counter with Wire (22 AWG 254 mm Long)</p>			
<p>Note: For Non Resettable Counters, reset arm lever will not be present and all other details will be common with resettable counter.</p>			

Impulse Counter Series CR 26 (4-Digit)

MOUNTING DIMENSION (mm)

IMPULSE COUNTER CR 26 (4 FIG)

Resettable Counter
4XXXXA

	A=With terminal strip	B=With 22 AWG 254 mm long wire	Panel cutout dimension
1. Panel Mount - 4 Figure 4XXXXX-356			
2. Bail Mount - 4 Figure 4XXXXX			
3. Base Mount - 4 Figure 4XXXXX			
4. Optional locking for reset button			To avoid the tampering with the reset button you can seal the counter as shown in the above figure

Impulse Counter Series CR 36

- Compact Size & Robust Design
- 7 Digit, Non-Resettable
- High Degree of Accuracy & Reliability
- Wide Temperature range
- Shock & Vibration Proof





Ordering Information

Cat. No.	Description
QD11A	12 VDC, Rectangular Bezel
QD21A	24 VDC, Rectangular Bezel
QD12A	12 VDC, Rectangular 2 Hole Bezel
QD22A	24 VDC, Rectangular 2 Hole Bezel
QD23A	24 VDC, Round Bezel

Impulse Counter Series CR 36



Cat. No.	QD11A	QD22A
Parameters		
Supply Voltage (Φ)	12 VDC	24 VDC
Supply Variation	-15% to +10%	
Power Consumption (Max.)	0.25 VA	
Figure	7 Digit, White on Black, (3.6mm) High	
Maximum Range	9999999	
Speed	10 Hz Maximum (600 counts/minute)	
Pulse Width	50 ms. minimum	
Counting Method	One Pulse - One Count (energizing - ½ count, de-energizing - ½ count)	
Weight	45 gm	
Operating Temperature	-5°C to +50°C	
Humidity (Non Condensing)	45% to 85% (Rh)	
Mounting	Panel	
Degree of Protection	NEMA 4X (IP 65)	
Certification	 	

Digital Counters

- 6-digit LCD
- In-built nonvolatile memory (EEPROM) offering exceptional reliability
- Wide range of supply voltage
- Remote reset
- Available in 3 different shaped Bezels
- Low Power Consumption





Ordering Information

Cat. No.	Description
Z72FBX	85-265 VAC model
ZJ2FBX	12-48V AC/DC model
ZH2FBX	10-80V DC model
X	A=Round Bezel, B=24x48 Bezel, C=Screw Mount Bezel

Digital Counters



Cat. No.	Z72FBX	ZJ2FBX	ZH2FBX
Parameters			
Supply Voltage (Φ)	85 - 265 VAC	12 - 48 VAC/DC	10 - 80 VDC
Frequency	50/60 Hz	50/60 Hz	N A
Power Consumption (Max.)	0.8 VA	0.4 W	0.6 W
Counting frequency	10Hz	10Hz	30Hz
Maximum Range	999999		
Display	Large 6-Digit display, easy to read		
Resolution	1 Count		
Reset	Electrical		
Memory Retention	100 Years		
Operating Temperature	- 10° C to +50° C		
Storage Temperature	- 20° C to +65° C		
Accuracy	± 1 Count		
Humidity (Non Condensing)	95% (Rh)		
Degree of Protection	IP54		
Enclosure	UL94-V0		
Terminals	1 & 2: Input Supply, 3: Count 4: Reset		
Panel cut outs	Round Bezel, 24 x 48 Bezel, Screw Mount Bezel		
Mounting	Flush/ Panel Mounting		
Certification	 		
Weight (unpacked)	With Round Bezel - 35g, with 24 x 48 Bezel - 29 g, with Screw Mount Bezel - 31 g		

EMI / EMC

Harmonic Current Emissions	IEC 61000-3-2
ESD	IEC 61000-4-2
Radiated Susceptibility	IEC 61000-4-3
Electrical Fast Transients	IEC 61000-4-4
Surges	IEC 61000-4-5
Conducted Susceptibility	IEC 61000-4-6
Voltage Dips & Interruptions (AC)	IEC 61000-4-11
Conducted Emission	CISPR 14-1
Radiated Emission	CISPR 14-1

Environmental

Cold Heat	IEC 60068-2-1
Dry Heat	IEC 60068-2-2
Vibration	IEC 60068-2-6
Repetitive Shock	IEC 60068-2-27
Non-Repetitive Shock	IEC 60068-2-27

Impulse Counter Series CR 36 & Digital Counter

MOUNTING DIMENSIONS (mm)

IMPULSE COUNTER CR 36

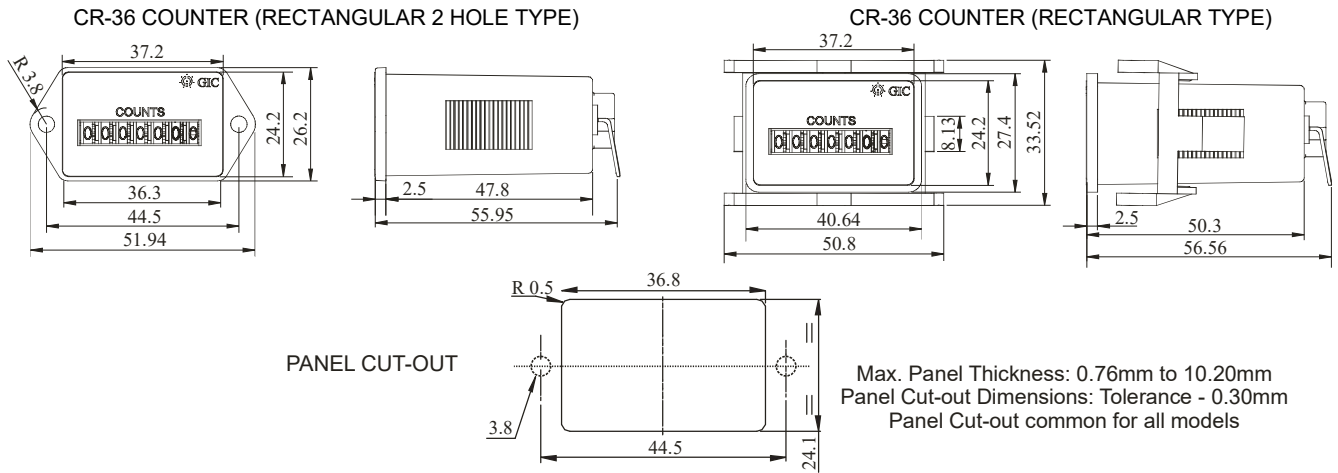

DIGITAL COUNTER

SCREW MOUNT BEZEL

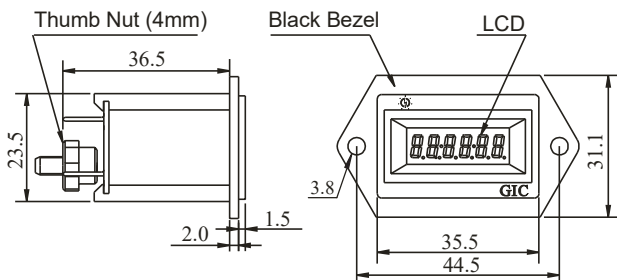

Recommended Panel Cutout :
37.0 (+0.5)mm x 24.6 (+0.5)mm

24X48 BEZEL

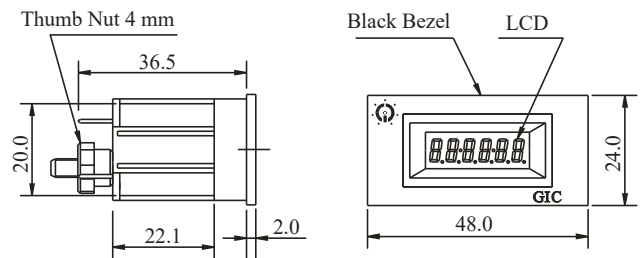

Recommended Panel Cutout :
45.5 (+0.5)mm x 23.0 (+0.5)mm

ROUND BEZEL

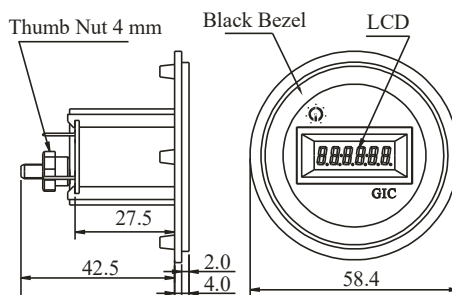

Recommended Panel Cutout :
37.0 (+0.5)mm x 24.6 (+0.5)mm

CONNECTION DIAGRAM

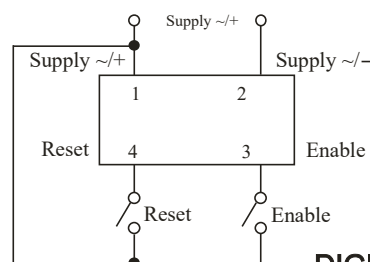

TERMINAL DESCRIPTION

- Pin 1: Supply (~ / +)
- Pin 2: Supply (~ / -)
- Pin 3: Enable
- Pin 4: Reset

DIGITAL COUNTER

Digital Hour Meter & Counter

- Suitable for Hour meter & Counter (Up / Down) application
- Wide Hour meter range from 1 sec to 9999999 hrs
- Wide counter range from 1 to 9999999 counts
- Prescaling facility for Counter
- Runtime set point change & Alarm facility for both Hour meter & Counter
- Configurable NO/NC Relay & MOSFET Output with Over Load detection
- Retentive & Non-Retentive modes
- 7 Digit LCD with luxurious green backlight & Password Protection
- Compact size
- Suitable for panel mounting



Ordering Information

Cat. No.	Description
Z2301N0G1FT00	9-30 V DC (with dual MOSFET output)
Z2221N0G2FT00	85-265 V AC/DC (with Relay output)

Digital Hour Meter & Counter



Cat. No.		Z2301N0G1FT00	Z2221N0G2FT00	
Parameters				
Supply Voltage (Φ)		9 - 30 VDC	85 - 265 VAC/DC	
Power Consumption (W)		2 W max.	2 VA / 1W	
Supply Frequency		50 / 60 Hz		
I/P Signal Characteristics				
Signal Voltage Range		9 - 30 VDC	85 - 265 VAC & 100 - 265 VDC	
Signal Isolation		2kV		
Output Characteristics				
Output type		2 MOSFET: 30 VDC/60 mA (Max.) Note: Use isolated input supply	Relay: 1 NO, Contact Rating: 5 A(Res.) @ 250 VAC/30 VDC Contact Material: Ag Alloy	
Functional Characteristics				
Display		7 digit LCD , 6.5 mm Height, 12 O' Clock, Transmissive		
Number of keys		2 (SET key & RST key)		
Reset function	Reset type	Terminal	Front	
	Time (min.)	80 ms	3 Sec	
		Auto Reset		
		-		
Hour Meter Functions	Accuracy	± 2sec per Day		
	Ranges	Hrs : Min : Sec (999:59:59), Hrs : Min (99999:59), Hrs (9999999), Min (9999999), Sec (9999999)		
Counter Functions	Input Signal	For Hour counting detection, Signal has to be present for min. 3msec & signal has to be absent for min 20msec.		
	Accuracy	100%		
	Range	1 to 9999999.999		
	Decimal Point Position(max.)	3		
	Pre-scaler	4 Digit		
	Input	Switching Freq.(max.)	10 Hz for AC and 40 Hz for DC	
	Signal	Pulse Width min.	50ms ON/50ms OFF for AC, 12.5ms ON/12.5ms OFF for DC	
Environmental Characteristics				
Operating Temperature		-5° C to +55° C		
Storage Temperature		-10° C to +60° C		
Humidity		5 to 95% Rh (Without condensation)		
Maximum Operating Altitude		2000 m		
Pollution Degree		II		
Degree of Protection		Front side: IP40; Terminals: IP20, Housing : IP30		
Enclosure material		UL 94 V0 Plastic		
Casing color		Black		
Other Characteristics				
Mounting		Flush mounting on panel cut-out		
Panel Cut-out		22mm X 44.8mm		
Weight (Un-packed)		52 gm		
Operating position		Horizontal		
Termination wire Sizes		Wire size : 22-14 AWG, 0.3-2.5 mm		

EMI / EMC

Harmonic Current Emissions	IEC 61000-3-2
Voltage Flicker & Fluctuation	IEC 61000-3-3
ESD	IEC 61000-4-2
Radiated Susceptibility	IEC 61000-4-3
Electrical Fast Transients (Supply)	IEC 61000-4-4
Electrical Fast Transients (Signal)	IEC 61000-4-4
Surge	IEC 61000-4-5
Conducted Susceptibility	IEC 61000-4-6
Power Frequency Magnetic Field	IEC 61000-4-8
Voltage Dips	IEC 61000-4-29
Conducted Emission	CISPR 11
Radiated Emission	CISPR 11

Safety Compliance:

Test Voltage (All terminal to housing)	UL 508
Single fault	IEC 61010-1
Leakage Current	UL 508



Environmental

Cold Heat	IEC 60068-2-1
Dry Heat	IEC 60068-2-2
Vibration	IEC 60068-2-6
Repetitive Shock	IEC 60068-2-27
Non-Repetitive Shock	IEC 60068-2-27

Digital Hour Meter & Counter

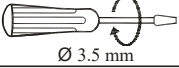

TERMINAL TORQUE & CAPACITY

 Ø 3.5 mm	0.40 N.m (3.5 Lb.in)
	1 x 2.5 mm ² Solid/Stranded Wire
AWG	22 to 14

MOUNTING DIMENSIONS (mm)

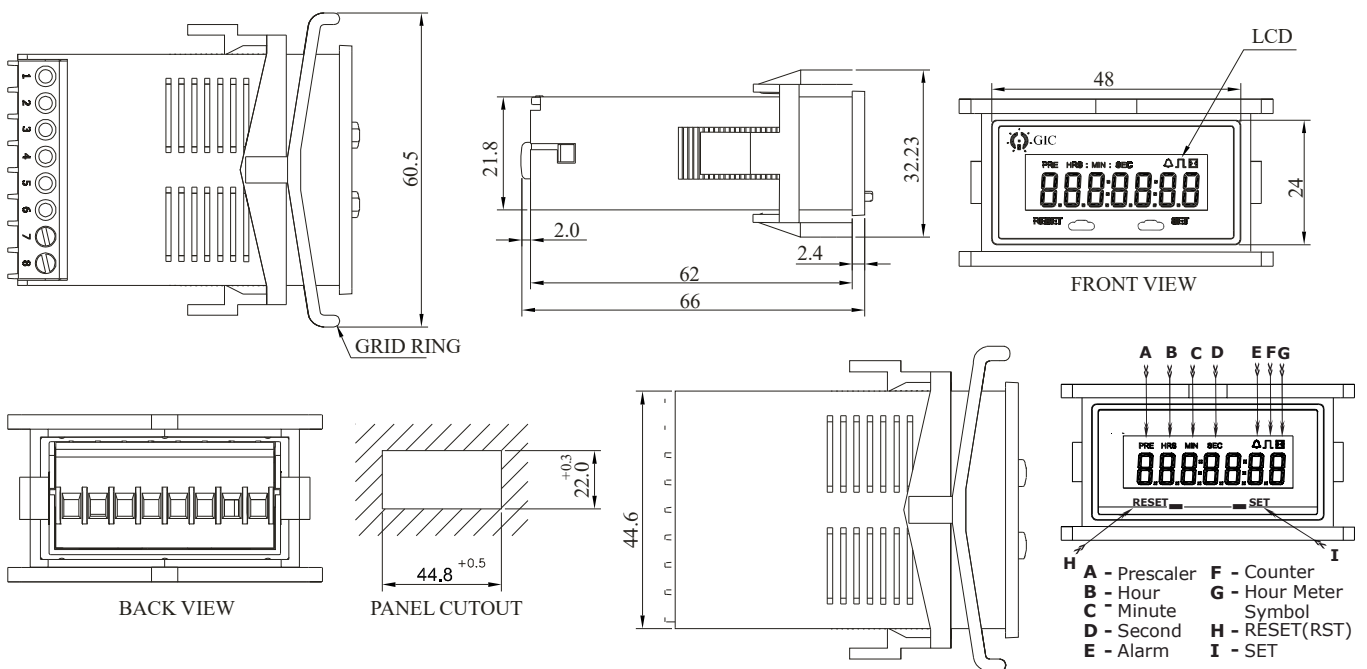

CONNECTION DIAGRAM

For Z2301N0G1FT00

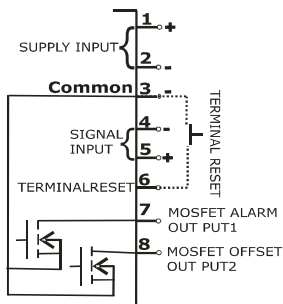

For Z2221N0G2FT00

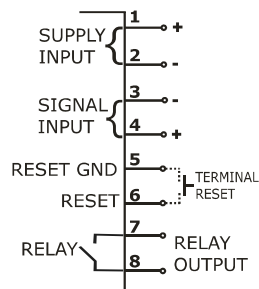

Proximity Switch Connection Diagram:

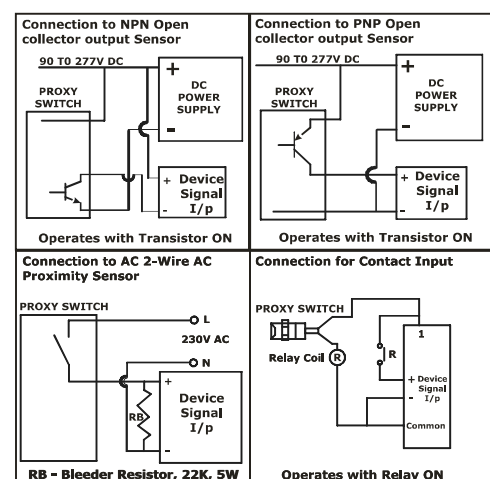

Rate Indicator & Totaliser

- Wide input signal sensing range 0.01Hz to 20KHz
- Wide Totalizer range from 1 to 9999999
- Wide Rate range from 1 to 999999
- Prescaling facility for Rate Indicator
- Alarm facility for both Rate Indicator & Totalizer
- Password protection
- Signal Over-range displayed



Ordering Information

Cat. No.	Description
Z3301N0G2FT00	9 - 30 VDC (with Relay output)

Rate Indicator & Totaliser



Cat. No.		Z3301N0G2FT00		
Parameters				
Supply Voltage (±)		9 - 30 VDC		
Max. Power Consumption (W)		1.5 W		
Input Signal		Range 1 : 0.01 Hz to 50 Hz		
Frequency Range		Range 2 : 0.01 Hz to 20 KHz		
Output Type		Relay: 1 NO, Contact Rating:5 A(Res.) @250 VAC / 30VDC Contact Material: Ag Alloy		
Display		7 digit LCD, 6.5mm Height, 12 O' Clock, Transmissive		
Rate Display		6 digit Display		
Number of keys		2 (SET & RST)		
Reset	Reset type	Terminal	Front	Auto Reset
Function	Time (min.)	80 ms	3 Sec	-
Rate Accuracy		± 0.01%		
Totalizer Accuracy		100 %		
Decimal Point Position (max.)		4		
Pre-scaler		4 digits before decimal point & 3 digits after decimal point.		
Operating Temperature		- 10° C to +55° C		
Storage Temperature		- 10° C to +60° C		
Humidity		5 to 95% Rh (Without condensation)		
Maximum Operating Altitude		2000 m		
Pollution Degree		II		
Degree of Protection		Front side : IP40; Terminals: IP20, Housing: IP30		
Enclosure material		UL 94 V0 Plastic		
Casing color		Black		
Weight (Unpacked)		64g		
Operating Position		Horizontal		
Termination wire Sizes		Wire size : 22-14 AWG, 0.3-2.5 mm		
Panel Cut-out		22mm X 44.8mm		
Mounting		Flush / Panel Mounting		
Certification				

EMI / EMC

ESD	IEC 61000-4-2
Radiated Susceptibility	IEC 61000-4-3
Electrical Fast Transients (Supply)	IEC 61000-4-4
Electrical Fast Transients (Signal)	IEC 61000-4-4
Surge	IEC 61000-4-5
Conducted Susceptibility	IEC 61000-4-6
Power Frequency Magnetic Field	IEC 61000-4-8
Voltage Dips	IEC 61000-4-29
Conducted Emission	CISPR 11
Radiated Emission	CISPR 11

Safety Compliance:

Test Voltage (All Terminal & Housing)	IEC 60947-5-1
Signal Fault	IEC 61010-1
Leakage Current	UL 508



Environmental

Cold Heat	IEC 60068-2-1
Dry Heat	IEC 60068-2-2
Vibration	IEC 60068-2-6
Repetitive Shock	IEC 60068-2-27
Non-Repetitive Shock	IEC 60068-2-27

Rate Indicator & Totaliser

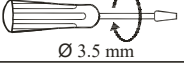

TERMINAL TORQUE & CAPACITY

 Ø 3.5 mm	0.40 N.m (3.5 Lb.in)
	1 x 2.5 mm ² Solid/Stranded Wire
AWG	22 to 14

MOUNTING DIMENSIONS (mm)

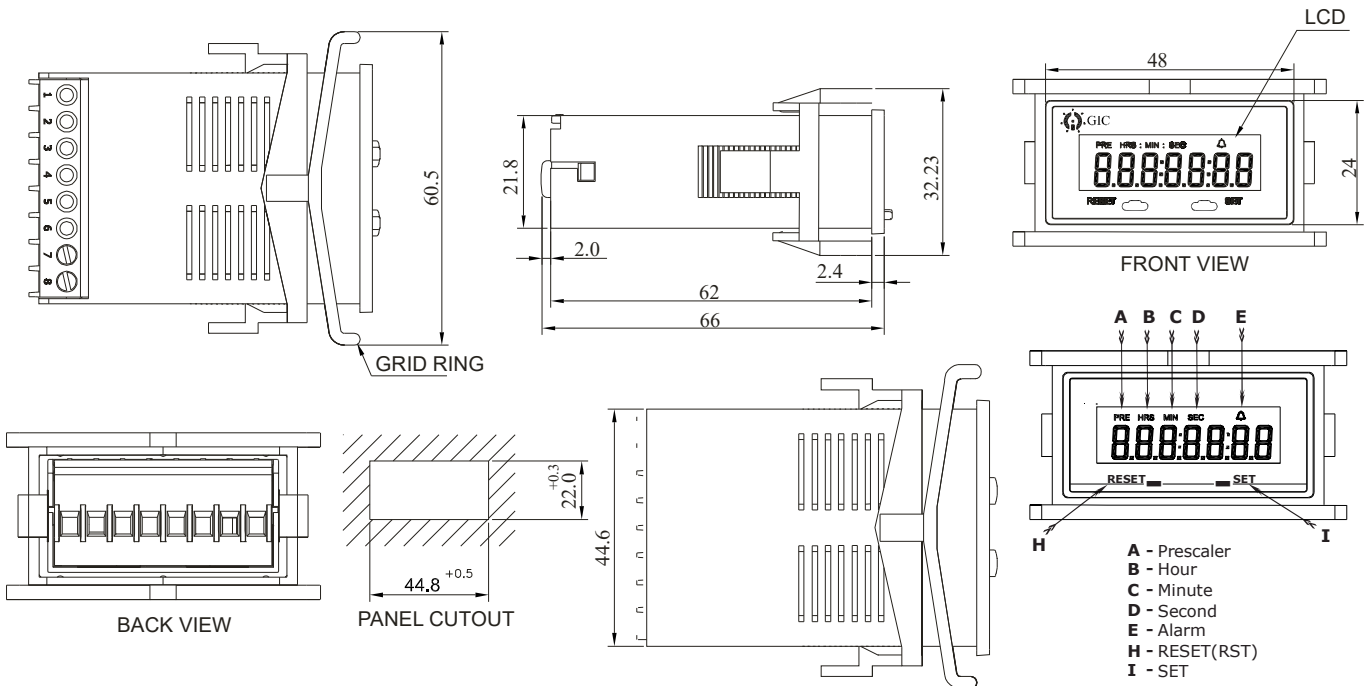

CONNECTION DIAGRAM

Z3301N0G2FT00

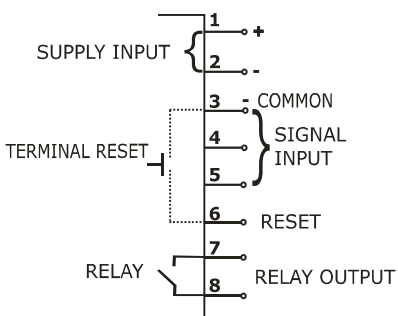

Magnetic pickup:

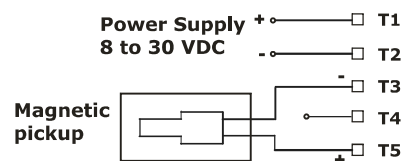

Proximity Switch Connection Diagram:

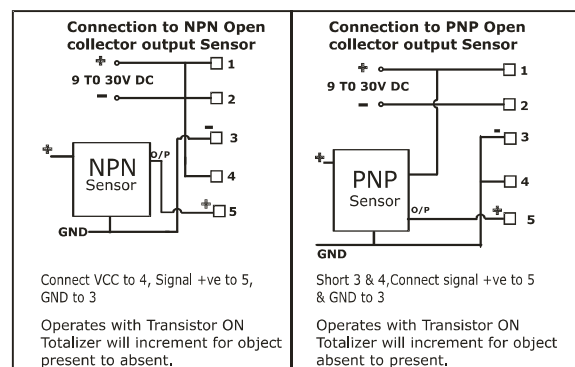



CONTROLLERS

Programmable Logic Controllers

Smart Relay *Genie™-AX*

Mini PLC PL - 100

GSM Alarm Modem

GSM Controller

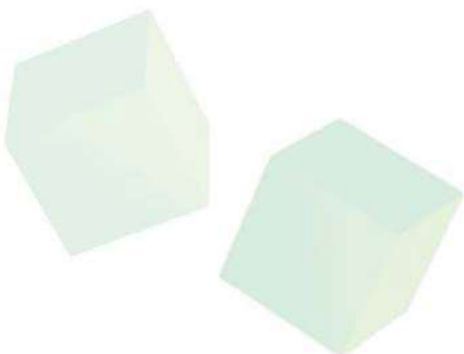

Smart Relay *Genie™ - NX*

- Supports up to 48 I/Os
(32 Digital Inputs & 16 Digital Outputs)
- 250 lines of ladder programming
- 16 soft text messages, Time Switches, Compare Counters, Timers, Counters & 12 Analog functions, 4 Hour Meters
- DST Feature Available
- Backlit LCD Screen for display & modification of pre-selected parameters of functional blocks, viewing I/O status and programming on the device
- PC software for programming, online & offline simulation, documentation & printing
- Designed for use in automation for commercial & Industrial sectors
- Multi level password and run time parameter save facility





Ordering Information

Cat. No.	Description	Cat. No.	Description
G7DDT11	110 - 240 VAC, Genie Nx Base Module	G7DDT10E	110 - 240 VAC, Genie Nx Extension Module
G7DDT11B	110 - 240 VAC, Genie Nx Base Module, Without LCD Display	G8DDT10E	12 - 24 VDC, Genie Nx Extension Module
G8DDT11	12 - 24 VDC, Genie Nx Base Module	G9DDT10E	24V AC/DC, Genie Nx Extension Module
G8DDT11B	12 - 24 VDC, Genie Nx Base Module, Without LCD Display	G9ADT10E	24V AC/DC, Genie Nx Base Module With 2 Analog I/P (for 24V DC only), Extension Module
G9DDT11	24V AC/DC, Genie Nx Base Module	GFDNN3M	Memory Card
G9DDT11B	24V AC/DC, Genie Nx Base Module, Without display	GFDNN2S	RS 232 Serial Communication Cable
G9ADT11	24V AC/DC, Genie Nx Base Module With 2 Analog I/P (for 24V DC only)	GFDNN1	USB Cable
G9ADT11B	24V AC/DC, Genie Nx Base Module With 2 Analog I/P (for 24V DC only), Without display	GNXNN2	Genie Nx Software supplied on CD-ROM compatible with Windows 7, Windows 8, Windows 8.1 & Windows 10

UL approval is not applicable for G9 Cat. Nos.
Note: 10 Series Cat. No. available on request.

Smart Relay *Genie™* - *MX*



Cat. No.		G7DDT11	G8DDT11
Parameters			
Supply Voltage (φ)		110 - 240 VAC	12 - 24 VDC
Supply Variation		-20% to +10%(of φ)	
Frequency		50/60 Hz	
Power Consumption		5W	
Digital Input		8	6
Analog Input		N A	2 (Can be used as Digital Inputs)
Digital Input Range		(0 - 50 VAC) OFF, (80 - 265 VAC) ON	(0 - 4 VDC) OFF, (8 - 26.4 VDC) ON
Analog Input Range		N A	0 to 10 VDC
Digital Output	Relay Output	4 'NO'	
	Contact Rating	8A @ 240 VAC / 5A @ 30 VDC (Resistive)	
	Electrical Life	10 ⁵	
	Mechanical Life	10 ⁷	
Utilization Category	AC - 15	Rated Voltage (Ue): 120/240 V, Rated Current (Ie): 3.0/1.5 A	
	DC - 13	Rated Voltage (Ue): 24/125/250 V, Rated Current (Ie): 2.0/0.22/0.1 A	
I/O Extensions (Max.)		3	
Power Reserve (For Clock Only)		7 yrs. (at -10°C to 55°C)	
Modbus Communication		Yes (RTU) (Slave)	
DST		Settable	
Lines for Ladder Programming		250	
Function Blocks	Timers	16 (ON Delay, Interval, Cyclic ON-OFF, OFF Delay)	
	Counters	16 (Up / Down, Retentive selectable)	
	Time Switches	16 (Weekly / Daily)	
	Compare Counters	16	
	Analog Functions	N A	12
	Soft Text Messages	16 (Priority Driven)	
	Auxiliary Relays	64	
Hour Meter		4	
Operating Temperature		-10° C To + 55° C	
Storage Temperature		-20° C To + 70° C	
Humidity (Non Condensing)		35 to 85% (Rh)	
Enclosure		Flame Retardant UL 94-V0	
Dimension (W x H x D) (in mm)		72 X 90 X 65	
Weight (unpacked) Approx.		230 g	
Mounting		Base / DIN Rail	
Degree of Protection		IP 20 for Terminals, IP 40 for Enclosure	
Certification		  	

EMI / EMC

Harmonic Current Emissions	IEC 61000-3-2
ESD	IEC 61000-4-2
Radiated Susceptibility	IEC 61000-4-3
Electrical Fast Transients	IEC 61000-4-4
Surges	IEC 61000-4-5
Conducted Susceptibility	IEC 61000-4-6
Voltage Dips & Interruptions (AC)	IEC 61000-4-11
Voltage Dips & Interruptions (DC)	IEC 61000-4-11
Conducted Emission	CISPR 14-1
Radiated Emission	CISPR 14-1

Environmental

Cold Heat	IEC 60068-2-1
Dry Heat	IEC 60068-2-2
Vibration	IEC 60068-2-6
Repetitive Shock	IEC 60068-2-27
Non-Repetitive Shock	IEC 60068-2-27

Smart Relay *Genie*[™] - *N*

- Nx-Comm RS 485 Module





Ordering Information

Cat. No.	Description
G7XDTR4	110 - 240 VAC, RS 485 Communication Module
G8XDTR4	12 - 24 VDC, RS 485 Communication Module

Smart Relay *Genie™* - *MX*



Cat. No.	G7XDTR4	G8XDTR4
Parameters		
Supply Voltage (⊕)	110 - 240 VAC	12 - 24 VDC
Input	TTL Level	
Output	RS 485 Protocol (Two wires, D +, D -)	
Number of Nodes	32 Standard unit loads	
Isolation voltage	2000 Vrms	
Baud Rate	300, 600, 1200, 2400, 4800, 9600	
Operating Temperature	-10°C to + 55°C	
Storage Temperature	-20°C to + 70°C	
Modbus Communication	Yes (RTU) (Slave)	
LED Indications	Red LED's for Tx & Rx. Green LED for Power indication.	
Certification	  	
Weight (unpacked)	80 g	84 g

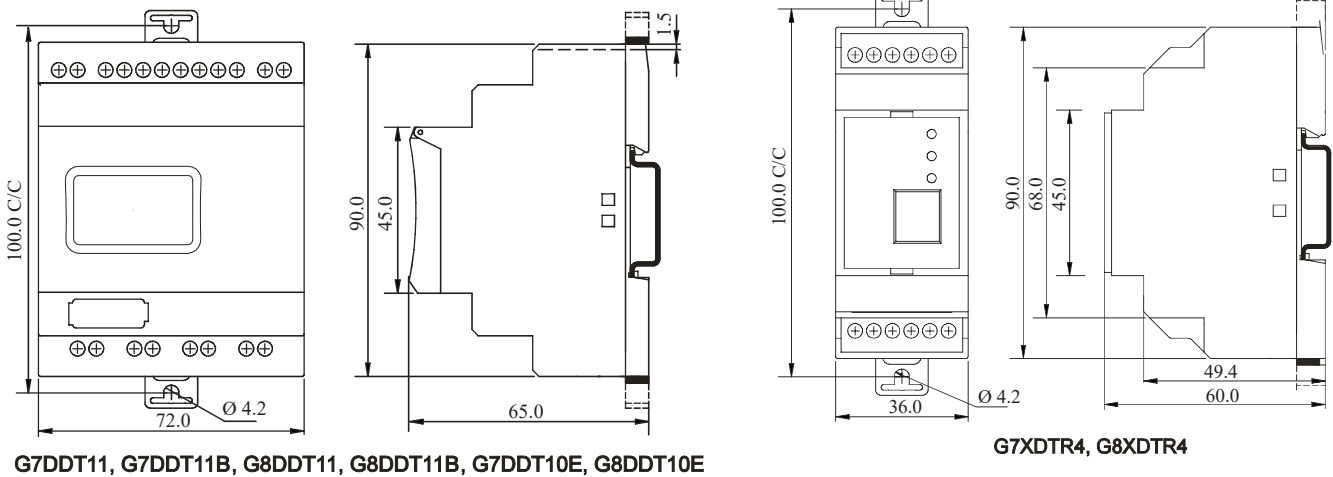

MOUNTING DIMENSION (mm)

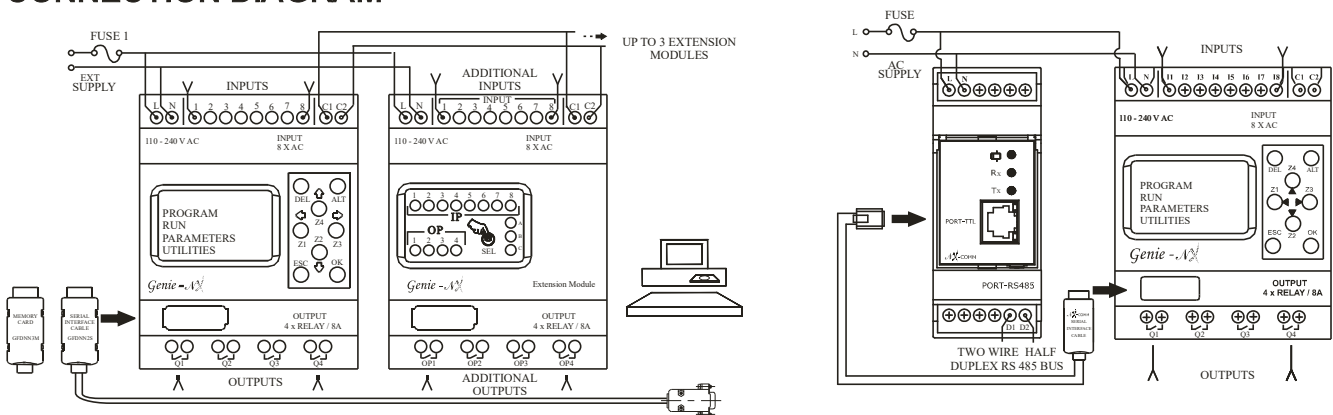

CONNECTION DIAGRAM



TERMINAL TORQUE & CAPACITY

	0.54 N.m (6 Lb.in)
	1 x 2.5 mm ² Solid Wire/Stranded
AWG	1 x 24 to 12

Smart Relay *Genie™ - NX*



FEATURES

Programming:

Programming can be carried out independently using the keys on the Genie-NX base module with the help of ladder diagram or on a PC, using "G-Soft NX." software.

LCD Backlighting:

Backlight of the LCD display is present for a minimum 15 seconds whenever the device is powered ON or a key is pressed on the base module. The backlight can also be configured to be permanently ON or permanently OFF by configuring the "Device Utilities" option in the device menu or by using the G-Soft NX application software.

Memory Card:

Genie-NX has a Program Transfer feature, which allows programs to be transferred or copied into another Genie-NX with the help of memory card. This feature enables quick copy of the programs without the use of a laptop or a PC.

I/O Extensions:

User can connect a maximum of 3 Extension Modules to the Genie-NX base module & each Extension Module has 8 inputs and 4 outputs, so we can expand up to 48 I/O extensions if necessary via the Genie-NX. Expansions are made in daisy chain fashion.

Communication Module:

A module for communication on the Modbus network is available, which is called "NX-Comm "to facilitate communication of the logic relay over a 2 wire half duplex RS 485 link. Modules are powered by 110- 240 VAC or 12- 24 VDC power supplies. The base module can be connected to this communication interface by means of the cable and the communication takes place via the NX-Comm. on the RS 485 link.

APPLICATIONS

- HVAC Controls
- Machine Controls involving Motor, Pump and Valve
- Operational Monitoring systems like Access control, Vehicle Control Monitoring, Baggage handling etc.
- Materials handling Equipments, Conveyor systems and Elevators
- Exhaust and Filtering Systems
- Water-treatment plants
- Printing and Packaging Machines
- Ancillary equipments in Textile and Plastic Industry
- Interior and Exterior Lighting Control
- Door, Gate, Shutter, Sun blinds and Awning control
- Irrigation Control Systems
- Automation of Compressors and Pumps for Air Conditioning requirements

Mini PLC PL - 100

- Supports up to 112 IOs
- Relay Base & Transistor Low Side Base modules
- Stacking using FRC cable up to maximum 6 Expansion Modules
- Isolated Digital Inputs with sourcing & sinking capability
- Isolated Digital Transistorized Outputs (Low Side and High side driver)
- High Speed Inputs - Single / Quadrature (1x/2x/4x)
- High Speed Outputs (PTO / PWM / S-Profile)
- Analog Voltage/Current Inputs and Outputs of 0-10 V / 4-20 mA
- PC Software for programming, online & offline simulation
- Standard RS232/RS485 port with RJ11 for HMI/SCADA Interface
- Modbus RTU support
- 128 Weekly, Monthly & Yearly Time Switches each
- Multiple Timers, Counters including retentive counters, Hour meters & many more function blocks



Ordering Information

Cat. No.	Description
Base Models:	
PC10BD16001D1	DC Base with 8 Digital I/Ps, 8 Relay Outputs
PC10BD14002D1	DC Base with 8 Digital I/Ps (6 Normal I/Ps + 2 High Speed I/Ps) 6 Transistor Low Side Outputs (4 Normal O/Ps + 2 High Speed O/Ps)
PC10BD14003D1	DC Base with 8 Digital I/Ps (4 Normal I/Ps + 4 High Speed I/Ps) 6 Transistor Low Side Outputs (4 Normal O/Ps + 2 High Speed O/Ps)
Extension Models:	
PC10ED08001N	Extension with 8 Digital Inputs
PC10ED08002N	Extension with 8 Relay Outputs
PC10ED16003N	Extension with 8 Digital Inputs and 8 Relay Outputs
PC10ED08004N	Extension with 8 Transistor Low Side Outputs
PC10ED08005N	Extension with 8 Transistor High Side Outputs
PC10EA04001N	Extension with 4 Analog Inputs (Max. 24, 0-10V / 4-20mA)
PC10EA02002N	Extension with 2 Analog Outputs (Max. 12, 0-10V / 4-20mA)
Application Software:	
PC10SN000N	PL-Soft
Accessories:	
28D33B0	Accessory, USB 2.0 Cable, Type A Male to B Male
PC10AC2	RS232 Communication Cable, PL-100 to HMI / SCADA
PC10AC3	RS485 Communication Cable, PL-100 to HMI / SCADA (DB9 Female to RJ-11)
PC10AC4	RS485 Communication Cable, PL-100 to HMI / SCADA (DB9 Male to RJ-11)

Mini PLC PL - 100





Cat. No.	PC10BD16001D1	PC10BD14003D1
Parameters		
Supply Voltage (±)	24 VDC	
Supply Tolerance	- 20% to +10%	
Internal Current Consumption	65mA @ 24 VDC	60mA @ 24 VDC
Inrush Current	2.5A @ 24VDC	
Battery Backup (In Event of Power failure)	5 years	
Separate Power Supply For Output	Not required	19.2 To 26.4 VDC (External fuse of 10A is recommended)
Digital Inputs		
No. of Inputs	8	4+4 High Speed
Grouping	(4+1 Common)*2	
Type of Inputs	Sinking / Sourcing	
Input Voltage Range	0 - 26.4 VDC	
Level (Logic 0)	Max. 7VDC	
Level (Logic 1)	Min. 16VDC	
Max. Input Current	1.2 mA per input	
Hardware Delay	5 msec	
Digital Filter Time (Sampling Time)	28 msec	
Min. Pulse Width	(Hardware Delay + Digital Filter Time) OR (System Loop Time) whichever is higher.	
Max. I/P frequency	10 Hz (for worst case condition)	
High Speed Level (Logic 0)	-	Max 3 VDC
High Speed Level (Logic 1)	-	Min 5 VDC
Max Input Current	-	1.2 mA per Input
Max High Speed Input Current	-	3 mA per Input
Min. Pulse width for High Speed Inputs (for 'low to high' or 'high to low' transition)	-	50 µSec (Min.)
Max. I/P frequency for high speed inputs.	-	Single Phase Mode - 10 kHz. Quadrature Mode 1X - 10 KHz, 2X - 5 KHz, 4X - 2.5 KHz
Digital Outputs		
No. of Outputs	8	4+2 High Speed
Grouping	(4+1 Common)*2	NA
Output Hardware	Relay (NO)	Transistor Low Side Driver
Rated Load	5 A (Res.) @ 230 VAC / 30 VDC	24 VDC, 500 mA
Max load per common	10 A	
Max operations	1x10 ⁵	
Protection	External Fuse	Internally Protected (Max 3 A Per output)
Min. load for High Speed Output	-	10% of Rated Load (24 VDC, 500 mA)
HSO frequency	-	25 kHz max. for High Speed Outputs
Isolation		
Between Output & Supply	2KV	
Between Input & Supply	2KV	
Communication		
PC Port (USB)	USB Port (Type B) for PC Communication	
Isolation for USB Port	2KV between communication lines and internal circuit	
HMI Port (RS-232 / RS-485)	RJ11 Port for HMI (or any MODBUS Device)	
Communication parameters	Software selectable for HMI Port	
HMI port comm. Protocol	MODBUS Slave / MODBUS Master	
Functional		
Programming language	Ladder	
Scan Time	50 mS max.	
User Program memory	32 k	
User Data memory	1 k	
Maximum no. of I/O s	100	
Maximum no. of Extension modules	6	

Details continued on next page

Mini PLC PL - 100



Cat. No.	PC10BD16001D1	PC10BD14003D1
Indication		
Input	Yes (Green LED)	
Output	Yes (Red LED)	
RUN	Yes (Green LED)	
STOP	Yes (Red LED)	
ERROR	Yes (Red LED Blinking)	
Operating Temperature	0°C to 55°C	
Storage Temperature	-20°C to 70°C	
Relative Humidity	20-90% RH (Without condensation)	
Environmental Air	No excessive dust or corrosive gas allowed	
Dimension (W x H x D) (in mm)	72 x 90 x 58	
Weight (unpacked) Approx.	220g	
Mounting	DIN Rail (35 mm)	
Enclosure Material	UL 94 V0	
Degree of Protection	IP 20 for Terminals, IP 40 for Enclosure	
Certification	 	

EMI / EMC

ESD	IEC 61000-4-2
Radiated Susceptibility	IEC 61000-4-3
Electrical Fast Transients	IEC 61000-4-4
Surge	IEC 61000-4-5
Conducted Susceptibility	IEC 61000-4-6
Power Frequency Magnetic Field Test	IEC 61000-4-11
Conducted Emission	CISPR 14-1
Radiated Emission	CISPR 14-1
Conducted Emission	CISPR 11
Radiated Emission	CISPR 11



Safety Compliance

Test Voltage between I/P and O/P	UL 508
Impulse Voltage between I/P and O/P	IEC 60947-5-1
Single Fault	IEC 61010-1
Insulation Resistance	UL 508
Leakage Current	UL 508

Environmental Compliance

Cold Heat	IEC 60068-2-1
Dry Heat	IEC 60068-2-2
Vibration	IEC 60068-2-6

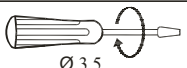
TERMINAL TORQUE & CAPACITY

 Ø 3.5	0.54 N.m (6 Lb.in)
	1 x 2.5 mm ² Solid Wire/Stranded
AWG	1 x 24 to 12

Mini PLC PL - 100



FUNCTION BLOCKS:

Sr. No.	Contact Blocks	Max. Available*
1	Positive Edge Contact	128
2	Negative Edge Contact	128
3	Not Contact	128
4	First Scan Contact	1
5	Auxiliary Relay State change	512
6	Auxiliary Relay Level change	512
7	Auxiliary Relay Bistable Set Reset	512

Sr. No.	Special I/O	Max. Available*
1	Timed I/O	1
2	Interrupt I/O	1

Sr. No.	Arithmetic Functions	Max. Available*
1	Arithmetic ADD	128
2	Arithmetic SUB	128
3	Arithmetic MUL	128
4	Arithmetic DIV	128
5	Arithmetic INC	128
6	Arithmetic DEC	128
7	Arithmetic MOD	128

Sr. No.	High Speed Output	Max. Available*
1	High Speed Output (PTO01)	1
2	High Speed Output (PTO02)	1
3	High Speed Output (PWM01)	1
4	High Speed Output (PWM02)	1
5	High Speed Output (SPO01)	1

Sr. No.	Move & Convert Functions	Max. Available*
1	Move	128
2	Block Move	8
3	Block Set	8
4	Compare	128
5	Conversion	128
6	Scale Converter	16
7	Shift Left (SHL)	128
8	Shift Right (SHR)	128

Sr. No.	Timer & Time Switch Blocks	Max. Available*
1	ON Delay Timer	128
2	OFF Delay Timer	128
3	Cyclic ON/Off	128
4	Cyclic OFF/ON	128
5	Accumulative Delay ON Signal Timer	128
6	Accumulative Impulse ON Signal Timer	128
7	Impulse ON/OFF Timer	128
8	Signal OFF/ON Timer	128
9	Leading Edge Impulse 1 Timer	128
10	Leading Edge Impulse 2 Timer	128
11	Trailing Edge Impulse 1 Timer	128
12	Trailing Edge Impulse 2 Timer	128
13	Delayed Impulse Timer	128
14	Retentive ON Delay Timer	128
15	Retentive OFF Delay Timer	128
16	Time switch Weekly	128
17	Time switch Monthly	128
18	Time switch Yearly	128

Sr. No.	Logical Functions	Max. Available*
1	NOT	128
2	AND	128
3	OR	128
4	EXOR	128

Sr. No.	Hour & Counter blocks	Max. Available*
1	Up counter	128
2	Down counter	128
3	Up-Down counter	128
4	Retentive Up counter	128
5	Retentive Down counter	128
6	Retentive Up-Down counter	128
7	Hour meter	128
8	High Speed Counter 1	1
9	High Speed Counter 2	1
10	High Speed Counter 3	1
11	High Speed Counter 4	1

Sr. No.	MODBUS Functions	Max. Available*
1	MODBUS INIT (Slave / Master)	1
2	MODBUS MASTER	16
3	Variable	1024**

*Maximum number of blocks that can be used in ladder depends on the user program memory.

**No of variables can be varied according to defined variable types.

i. Byte / SByte Type Variables - 1024. ii. Word / Sword Type Variables - 512. iii. Dword / SDword Type Variables - 256.

iv. Maximum size of Byte / Sbyte Type Array - 999

Mini PLC PL - 100



CONNECTION DIAGRAM

Connecting Power Supply to PL-100 Units

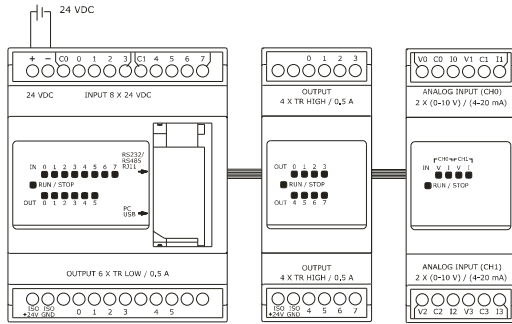

Connecting Positive Common

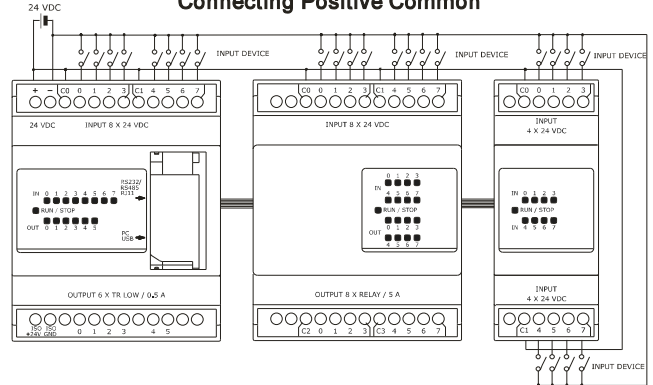

Connecting Negative Common

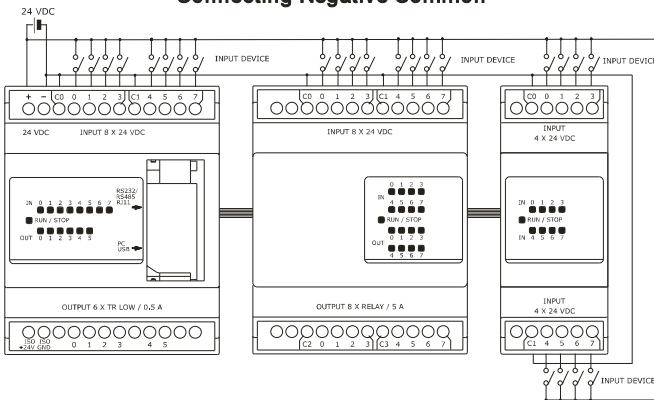

Connecting DC Relay Output

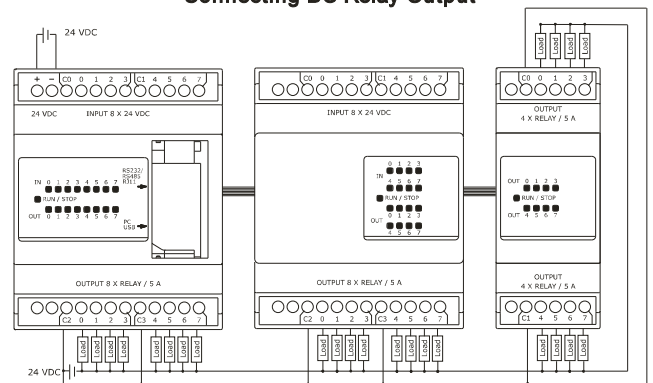

Connecting AC Relay Output

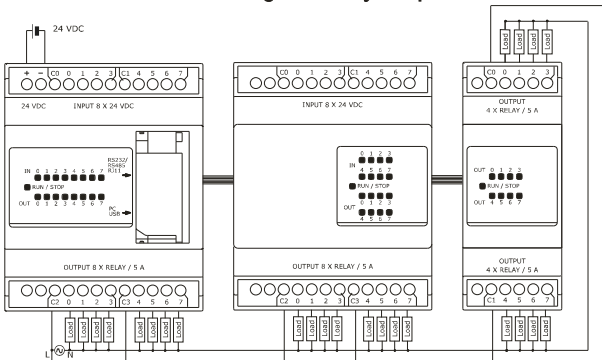

Connecting Low Side Output

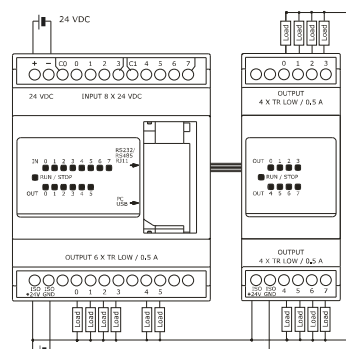

Connecting High Side Output

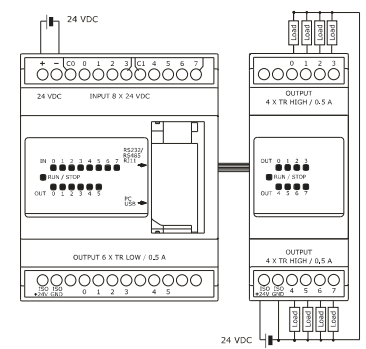

Connecting Analog Input Model

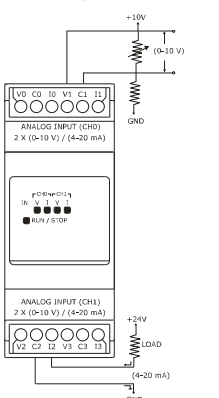

Connecting Analog Output Model

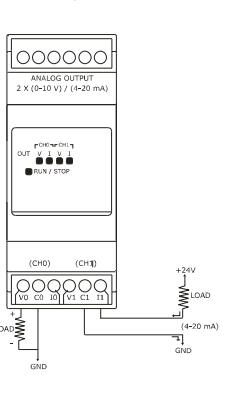

MOUNTING DIMENSIONS (mm)

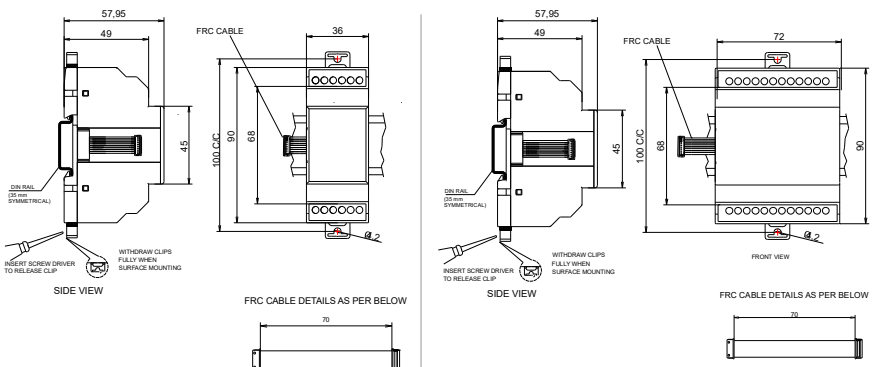

GSM Alarm Modem

- GSM Alarm Modem is specifically designed to provide GSM features to Mini PLC PL-100
- GSM Alarm Modem enables monitoring of inputs, outputs and controlling of outputs of Mini PLC PL-100 through SMS facility
- The preset and current value related to special function blocks (SFB) that are available in the ladder logic can be monitored
- Analog input and output values can also be effectively monitored and controlled
- Diagnostic information about all the inputs and outputs of devices connected in the System is available for users
- Device and Clock settings can be configured by sending respective queries to the device
- User can integrate Special Function Blocks such as Send and Receive SMS along with others like Timers, Time Switches, Counters, etc. for various applications
- Alert messages can be received from the GSM Alarm modem depending on the ladder logic
- Power Failure condition can also be effectively reported





Ordering Information

Cat. No.	Description
40B2BBVAA	24 VDC, Module for GSM Alarm Modem with wire type antenna

GSM Alarm Modem



Cat. No.	40B2BBVAA
Parameters	
Supply Voltage (Φ)	24 VDC
Supply Variation	-20% to +10% (of Φ)
Interface Port	RJ11
Interface	RS485
Signal	D+, D-
Power Fail SMS	Yes
Power ON SMS	Yes
Communication Break SMS	Yes
Power ON	Yes (Green LED)
Transmit Data	Yes (Green LED)
Receive Data	Yes (Green LED)
Network	Yes (Green LED)
Error	Yes (Red LED Blinking)
Enclosure type	4 Modular
Operating Temperature	-5 °C to 55 °C
Storage Temperature	-10 °C to 60 °C
Relative Humidity	20-90% RH (Without condensation)
Environmental Air	No excessive dust or corrosive gas allowed
Mounting	Base / DIN rail
Certification	 
Degree of Protection	IP 20 for Terminals, IP 40 for Enclosure

EMI / EMC Tests

ESD	IEC 61000-4-2
Radiated Susceptibility	IEC 61000-4-3
Electrical Fast Transients	IEC 61000-4-4
Surge	IEC 61000-4-5
Conducted Susceptibility	IEC 61000-4-6
Voltage Dips	IEC 61000-4-29
Conducted Emission	CISPR 11:2015
Radiated Emission	CISPR 11:2015

Safety Compliance

Single Fault	IEC 61010-1
Insulation Resistance	UL 508
Leakage Current	UL 508

Environmental Compliance

Cold Heat	IEC 60068-2-1
Dry Heat	IEC 60068-2-2
Vibration	IEC 60068-2-6
Repetitive Shock	IEC 60068-2-27
Non-repetitive Shock	IEC 60068-2-27

GSM Alarm Modem



MOUNTING DIMENSIONS (mm)

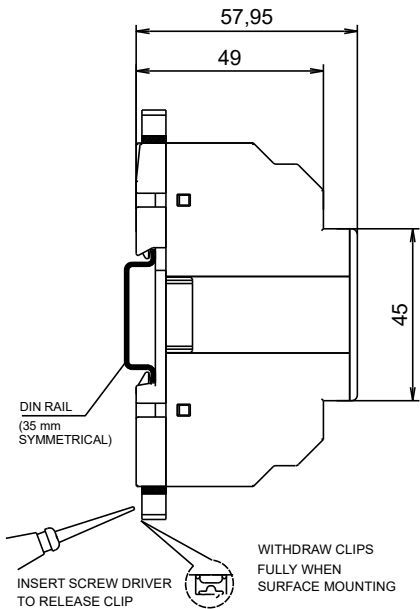
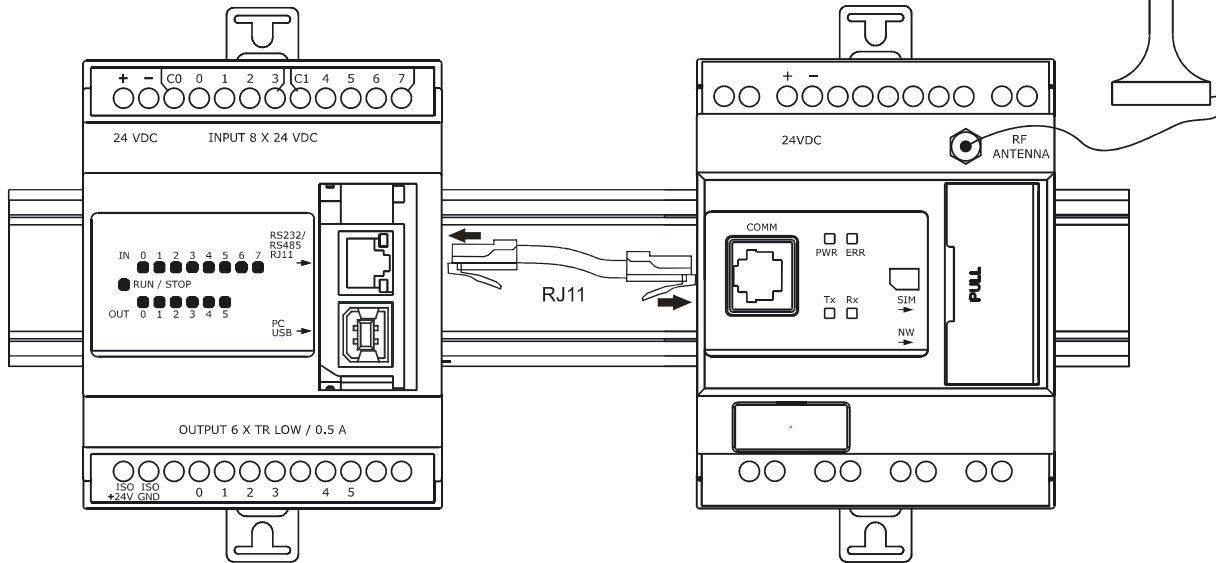

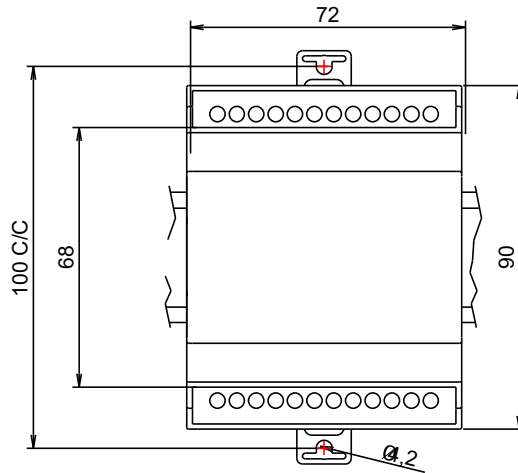

SIDE VIEW

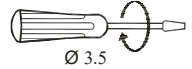

FRONT VIEW

TERMINAL TORQUE & CAPACITY

	0.54 N.m (6 Lb.in)
	1 x 2.5 mm ² Solid Wire/Stranded
AWG	1 x 24 to 12

GSM Controller

- Load can be made ON / OFF using mobile phone from remote location either by making an IVRS call, missed call or sending SMS to the device
- Device is suitable for Single Phase and Three Phase supply
- Device is compatible with SASD, FASD & DOL starters and controllers
- One Master and two other Master or Monitor numbers can be configured to control and monitor the Load operation
- Load can be operated in Manual Mode, GSM Auto Mode, Timer Mode, Retentive Timer Mode or Multiple Daily Timer Mode
- Wire antenna for flexible positioning to get proper signal strength
- User can get information of events like Load ON/OFF, Phase error, Error recovery, Power Fail, Power ON, Phase fail, Contactor pick up fault through SMS and call back from device
- Anti-theft feature
- Powered with Android App "M-Remote"



Ordering Information

Cat. No.	Description
26A11AV	180 - 500 VAC, Module For Mobile Starter with wire type antenna
26A21AV	85 - 265 VAC, Module For Mobile Starter with wire type antenna
26A11AVL	Module for regulating pump side ON/OFF operation for remote water level management.
26A12AVT	Module for controlling level at tank side for remote water level management.
26100V0 (Accessory)	Wire type antenna

GSM Controller



Cat. No.	26A11AV		
Parameters			
Supply Voltage (±)	180V AC to 500V AC (For Single Phase : Connect Live to R or Y & Neutral to B & COM terminal of Controller)		
Frequency	50-60 Hz		
Power Consumption (Max.)	10 VA		
Initialisation Time	Max 80 Sec		
Contact Ratings	Terminal 15 & 16 – NC , Terminal 25 & 28 – NO, 5A @ 250V AC / 30V DC (Res)		
FUNCTIONAL CHARACTERISTICS :			
LED Indications	LED	INDICATION	DEVICE STATUS
	ON (Green)	ON	Master number configured.
	CFG (Red)	Blinking @ 500 m Sec	GSM modem in factory default mode
		Flash every 800 m sec	GSM modem in configuration mode
	N/W (Green)	Flash every 3 sec	Not registered with N/W
		Both ON	Registered with N/W
	I1 & I2 (Yellow)	Both OFF	Starter ON
		I1 Blinking @ 500 m Sec	Starter OFF
		Both blinking	Phase fail
	Tx/Rx (Green)	Randomly Blinking	Power fail indication till super capacitor back up
Flash every 400 m Sec		Communication between CPU and Modem SIM card not detected	
GSM Modem	Quad band 850MHz,900MHz / 1800MHz,1900MHz, 2G		
Operating Temperature	0° C to +60° C		
Storage Temperature	-20° C to +70° C		
Humidity (Non Condensing)	95% (Rh)		
Enclosure	Flame Retardant UL94-V0		
Dimension (W x H x D) (in mm)	72 X 90.5 X 65		
Weight (unpacked)	220 g approx.		
Mounting	DIN rail / Base		
Certification			
Degree of Protection	IP 20 for Terminals, IP 30 for Enclosure		

EMI / EMC

Harmonic Current Emissions	IEC 61000-3-2
ESD	IEC 61000-4-2
Radiated Susceptibility	IEC 61000-4-3
Electrical Fast Transients	IEC 61000-4-4
Surges	IEC 61000-4-5
Conducted Susceptibility	IEC 61000-4-6
Voltage Dips & Interruptions (AC)	IEC 61000-4-11
Voltage Dips & Interruptions (DC)	IEC 61000-4-29
Conducted Emission	CISPR 14-1
Radiated Emission	CISPR 14-1

Environmental Compliance

Cold Heat	IEC 60068-2-1
Dry Heat	IEC 60068-2-2
Vibration	IEC 60068-2-6
Repetitive Shock	IEC 60068-2-27
Non-Repetitive Shock	IEC 60068-2-27

MOUNTING DIMENSIONS (mm)

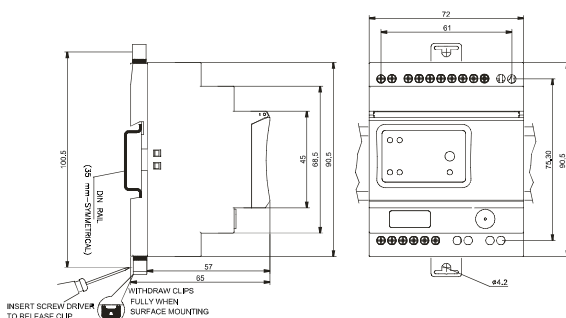

CONNECTION DIAGRAM TERMINAL TORQUE & CAPACITY

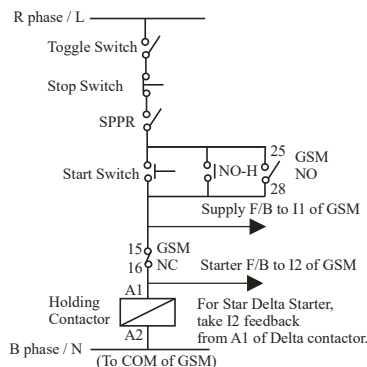

	0.54 N.m (5 Lb.in)
Ø 3.5	1 x 2.5 mm ² Solid Wire/Stranded
AWG	1 x 24 to 12

Note: It is strongly recommended to use Single Phasing Protection Device (SPPR) for Motor Protection with GSM Controller

Note: This Product is only available for Sale Outside India

GSM Controller



Configuration Steps

- Step 1:** Insert SIM card in the slot provided and connect Antenna.
- Step 2:** Power on device & wait for 50 sec. ON (Green) LED will start blinking*, indicating that device is in factory default mode. After every power on, device will take 50 to 80 sec for initialization during which user should wait.
- Step 3:** Ensure that NW (Network) LED is flashing after every 3 sec. It means device is registered with inserted SIM N/W. If NW LED is blinking faster, it means that the device is not registered with SIM NW & hence not ready for operation.
- Step 4:** Press the CFG (Configuration) key on the device till CFG (RED) LED starts blinking. The device goes in the configuration mode to configure the master number in the device.
- Step 5:** CFG LED will blink for 3 min, user should configure the master number within this time.
- Step 6:** Call the device number, call will be disconnected after 1 to 2 rings.
- Step 6 :** Call the device number, call will be disconnected after 1 to 2 rings.
- Step 7 :** After call gets disconnected, ON LED stops blinking & becomes permanently ON. CFG LED turns OFF. This will indicate that, master number has been configured in the device. User will receive SMS of "ROLE : MASTER".
- Step 8 :** To configure other Master numbers if required, send query 55<Space>Mobile no.1<Space>Mobile no.2 from the master number.
- Step 9 :** After installing device for the first time, set the device clock by sending query "16". User will receive SMS,"TIME : SET , TM : 14.10,01/12/16".
- Step 10 :** If device is connected to single phase supply, then configure device for single phase supply by sending query 18<space>1. User will receive SMS - SUPPLY- 1PHASE
- Step 11 :** If device is connected in Semi Automatic Star Delta starter then configure the device in SASD system by sending query 77<space>0. User will receive SMS – PANEL : SASD.
- Step 12 :** User should refer the "General SMS Queries" for functional details of the device.
- *Note :** In factory default, ON LED will continuously remain ON for approx. 10 sec till super capacitor charging and then start blinking.

General SMS Queries : (To be sent only from Master number to Device number)

SMS QUERY	ACTION
Functional Queries	
Voice Call (IVRS)	When call is made to device, recorded voice guide the User to operate the Load. (Factory set)
Missed Call	If Master number disables Voice call (IVRS) feature by 41<space>0 query, then User can operate the Load by Missed Call mode. When User call device, then device cut the call after 3-4 rings to make Load ON and cut the call after 5-6 rings to make Load OFF.
00	After receiving SMS 00, device turns OFF the Load.
11<space>0	After receiving SMS 11 0, device turns ON the Load.
11<space>HH<space>MM (Timer Mode)	After receiving this query, Load is turned ON in timer mode till specified end time. Here HH indicates Hour and MM indicates Minutes. E.g. after receiving 11 00 30 query, Load is turned ON till next 30 minutes. In Timer mode, error and power fail duration is not compensated. Load can be operated in timer mode from min 1 min to max 23.59 Hrs.
21<space>HH<space>MM (Retentive Timer Mode)	After receiving this query, Load is turned ON in Ret. timer mode for set time. Here HH indicates Hour and MM indicates Minutes. E.g. after receiving 21 00 30 query, Load is turned ON for 30 minutes. In Ret. Timer mode, error and power fail duration is compensated. Load can be operated in Ret. Timer mode from min 1 min to max 23.59 Hrs.
22<space>HH.MM <space> HH.MM (Daily Timer Mode)	After receiving this query, device make Load ON and OFF as per set time on daily basis. Here HH indicates Hour and MM indicates Minutes. Load ON and OFF time can be set in 24 Hrs format only. Master number can set min 1 and max 4 daily timers. E.g. If master send query 22 10.30 12, then device daily make Load ON at 10.30AM and OFF at 12PM. If master want to operate 4 daily timers, then send query e.g. 22 9 11.30, 11.35 13.45, 15 16, 17.30 19 After receiving this query, Load turns ON and OFF 4 times a day as per set time. There should be 1 min difference between 2 daily timers.
22	After receiving this query from Master number, daily timer settings are disabled.
23 (Hour Meter)	After receiving this query, User get to know, for how many hours Load was ON since installation of the device. Only Master number can reset hour meter to zero by sending query 23<space>0.
41<space>0 or 1	0 – To disable Voice call (IVRS) and enable Missed call mode 1 – To enable Voice call (IVRS) and disable Missed call mode (Factory Set)
42<space>0 or 1	0 – To disable Call back from device (Factory Set) / 1 – To enable Call back from device
43<space>0 or 1	0 – To stop receiving Event SMS from Device. / 1 – To start receiving Event SMS from Device. (Factory Set)
66<space>1	To make Load ON in Auto mode.
66<space>0	To make Load OFF only if it is ON in Auto mode.
97	To know System settings.
98	To know daily timer settings.
99	To know current status of Load.
INFO	To know all frequently used queries.
Configuration Queries	
15<space>0, balance code	After receiving this query, User get balance information. Balance code need to be correctly set. E.g. 15 0,*121# (*12# is balance code. It changes as per Service provider)
15<space>1, balance code	After receiving this query, User get balance information automatically after every 16 to 20th SMS.
16	After receiving this query, Device time will be set as per time of Master's SIM Network.
17	To know configured master & other master / monitor numbers.
18<space>1 or 3	1 -To configure with 1 PH Supply / 3 - To configure with 3 PH Supply (Factory Set).
44<space>xxxx (xxxx indicates last four digit of previous master number)	To replace the previous master number with new one, send query 44<space>xxxx from a new number which is to be configured as Master. (Note: 1.Before sending this query first press configuration key on device till CFG LED starts blinking 2. After this query, previously stored other master/monitor numbers will be deleted & new numbers need to be configured)
50<space>X (X is ON delay which ranges from 0 to 5 minutes)	Master number can configure ON delay in the Device by sending query 50. To set ON delay of 30 sec, Master number should send query 50<space>0, similarly 50<space>1 for 1 minute ON delay and upto 5 minutes in multiple of 1 minutes. The default setting of ON delay in the device is 30 sec. ON delay is applied whenever Load is to be turned ON after error or power fail or command off.
55<space> First number<space> Second number	By sending this query Master number can configure 2 other Master numbers with device. Other Master numbers can also turn ON and OFF Load by call or SMS. OR Master number can configure 2 Monitor numbers by suffixing letter M to mobile numbers in 55 query. (e.g 55<space>xxxxxxxM). Monitor numbers can only receive event SMS from device. To change the numbers, Master can resend 55 query with new numbers which are to be configured. (Note: While entering numbers, ensure that correct number is entered. Numbers can be verified by sending 17 query).
55	To remove other master /monitor numbers, send only 55 query to device from Master number.
77<space>0 or 1	0 -To configure with SASD starter / 1 - To configure with DOL/FASD starter (Factory Set).
Troubleshooting / Security Queries	
12	To check network range
13	To know IMEI number and F/W version of the device.
NOTE : 1) Other Master numbers have access to call and queries 00, 11, 12, 13,17,21,23,44, 66, 97,98, 99 and info. 2) Monitor numbers have access to queries 12, 13,17,21,23,44, 97,98,99 and info.	



CONVERTERS AND TRANSDUCERS

Protocol Converters

Lynx+ Gateway

Interface Converters

USB to RS232 / RS485 / RS422 Converter

RS232 to RS485 / RS422 Converter

Signal Transducers

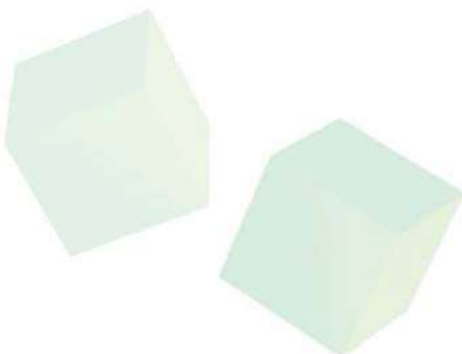

Lynx+ Gateway

- Serial protocol support for Modbus (RTU and ASCII) Master/Slave
- Network protocol support for Modbus TCP (Server/Client)
- Supports Raw Serial to Ethernet conversion with Telnet RFC2217
- Serial Interface support for RS232, RS422 and RS485 network
- Serial Baud rate: 300 bps to 115.2 Kbps
- Ethernet interface support: 10/100Mbps with Auto Negotiation
- Configurable using Embedded Web server and Application software
- Network Protocols: ARP, TCP/IP, HTTP, BOOTP, TFTP, ICMP, TELNET, DHCP, AutoIP, UPnP
- Isolation between Communication Ports & Input Power supply



Ordering Information

Cat. No.	Description
25A11A0	12 - 24 VDC, Protocol Converter, Modbus TCP - Modbus RTU/ASCII
25B11A0	12 - 24 VDC, Serial to Ethernet Converter

Lynx+ Gateway



Cat. No.	25A11A0	25B11A0		
Parameters				
Supply Voltage (≠)	12 - 24 VDC			
Supply Variation	-10% to +25%			
Power Consumption (Max.)	2 W			
Protocol Conversion	Modbus RTU / ASCII to Modbus TCP	N.A		
Operation Mode	Modbus RTU / ASCII (Master / Slave), Modbus TCP (Server / Client)	Raw, Telnet		
Configuration Management	HTTP Web Server and Application software			
Serial Interface	Number of Serial Ports	1	2	
	Serial Interface	Port1: Screw terminals for RS232, RS422 and RS485 interface	Port1: Screw terminals for RS232, RS422 and RS485 interface, Port2: RJ11 for RS232 Interface	
	Signals	RS232 : RXD, TXD, GND RS422 :TX+, TX-, RX+, RX-, GND RS485 : TX+ (D+), TX- (D-), GND		
	Serial Interface Selection	For Port1: Mode selection using RST switch with Mode LED indication		
	Serial Communication Parameters	Baud Rate : 300bps to 115.2Kbps		
		Data Bits : 7,8 ; Flow Control : None		
		Parity : Odd, Even, None Stop Bits : 1,2		
	Fail safe resistor	4K7 Resistor Pull up (TX+) & Pull Down (TX-) on BUS		
	Terminating Resistor Isolation	Connect externally if required Isolation 2 KVrms		
	LAN Interface	Port	RJ45, Ethernet 10/100 Mbps	
LAN Isolation		1.5KVrms magnetic Isolation		
Network Protocol's Supported		Protocols for Communication : TCP/IP, Modbus	Protocols for Communication : Raw, Telnet-RFC2217	
		Standard Protocols used : HTTP, DHCP, AutoIP, UPnP, TCP, UDP, IP, ARP, ICMP, Protocols used for firmware updating : BOOTP, TFTP	Standard Protocols used : HTTP, DHCP, AUTOIP, UPnP, TCP, UDP, IP, ARP, ICMP, Protocols used for firmware updating : BOOTP, TFTP	
Isolation	1.5KVrms magnetic Isolation			
Feature	Mapping and Background Processing Data Block (BPD)	N.A		
Configuration Software	Windows Based Software to Configure Ports as well as Selection of Protocol Driver			
Reset	Front Panel recessed , Loads Default Factory Settings & Serial Mode selection			
LED Indications	Serial TX and RX, LAN: LINK and Activity, Power ON, Error, Mode Selection Indication LED			
Operating Temperature	0°C to + 55°C			
Enclosure	Flame Retardant UL94-V0			
Dimension (W x H x D) (in mm)	72 X 90 X 58			
Weight (unpacked)	185 g			
Mounting	Base / DIN Rail			
Certification				

EMI / EMC

ESD	IEC 61000-4-2
EFT (On Supply Lines)	IEC 61000-4-4
EFT (On Communication Line)	Port1: IEC 61000-4-4
Radiated Susceptibility	IEC 61000-4-3
Surges (DC Power Ports)	IEC 61000-4-5
Conducted Susceptibility	IEC 61000-4-6
Voltage Dips & Interruptions (DC)	IEC 61000-4-29
Conducted Emission	CISPR 11
Radiated Emission	CISPR 11
Power Frequency Magnetic Field Immunity	IEC 61000-4-8

Environmental Compliance

Cold Heat	IEC 60068-2-1
Dry Heat	IEC 60068-2-2
Vibration	IEC 60068-2-6
Repetitive Shock	IEC 60068-2-27
Non-Repetitive Shock	IEC 60068-2-27

Lynx+ Gateway



MOUNTING DIMENSIONS (mm)

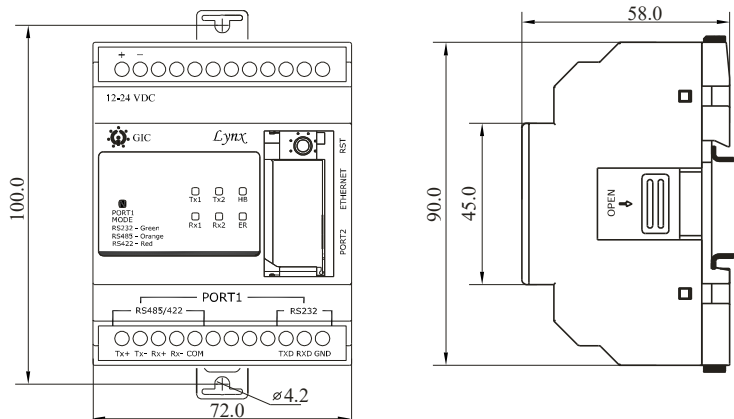

TERMINAL TORQUE & CAPACITY

	0.54 N.m (6 Lb.in)
	1 x 2.5 mm ² Solid Wire/Stranded
AWG	1 x 24 to 12

USB to RS232 / RS485 / RS422 Converter

- Compatible with USB 2.0
- Input : USB 2.0 Protocol
- Output : RS232 on DB9 Male connector compatible to PC RS485/RS422 on terminal block.
- Communication Speed : 300bps to 230Kbps.
- Auto direction control for RS485-2W data transmission.
- Cable: USB 2.0 type A to type B cable.
- Galvanic Isolation of 1.5kV
- RS232/RS485 line protection: +/- 15kV ESD.
- LED Indication for Transmit Receive signals.
- Input power from USB port, no external power required.
- 2M enclosure with DIN Rail mounting.
- Virtual COM port USB Drivers provided for Windows 7, 8, 8.1 and 10





Ordering Information

Cat. No.	Description
28A11A0	USB to RS232 / RS485 / RS422 Converter
28D33B0	Accessory for Converter 28A11A0, USB 2.0 Cable, Type A Male to B Male
28NNN10	Accessory for Converter 28A11A0, Software CD for Windows 8, 8.1 and 10

USB to RS232 / RS485 / RS422 Converter



Cat. No.	28A11A0
Parameters	
USB	
Version	USB Specification 2.0 compliant
Speed	12 Mbps
Isolated Serial Interface	
RS232	TX, RX, GND
RS485	D+, D-, GND
RS422	TX+, TX-, RX+, RX-, GND
Auto direction control for RS485-2W	
Serial line Protection	Internal 15kV ESD protection
Isolation	1500 V Galvanic Isolation
Connector	RS232 - D Type 9 Pin Male Compatible with PC, RS485, RS422- Screw Terminals
LED Indication	TX, RX, Communication Mode Indication.
Power Requirements	USB BUS Powered
Operating Temperature	0° C To + 60° C
Storage Temperature	-20° C To + 70° C
Humidity	5% (Rh) to 95% (Rh)
Enclosure	Flame Retardant UL 94-V0
Dimension (W x H x D) (in mm)	36 X 90 X 52.3
Weight (unpacked) Approx.	100 g
Mounting	Base / DIN rail
Degree of Protection	IP 20 for Terminals, IP 40 for Enclosure
Certification	 
Function and Application	This converter allows serial devices on RS232/RS485/RS422 to systems using USB interface. It has galvanic isolation of 1500V between USB and Serial ports. It drives power from USB connector and does not need any power adapter.

EMI / EMC

ESD	IEC 61000-4-2
Radiated Susceptibility	IEC 61000-4-3
Electrical Fast Transients	IEC 61000-4-4
Surges	IEC 61000-4-5
Conducted Susceptibility	IEC 61000-4-6
Conducted Emission	CISPR 14-1
Radiated Emission	CISPR 14-1



Environmental

Cold Heat	IEC 60068-2-1
Dry Heat	IEC 60068-2-2
Vibration	IEC 60068-2-6
Repetitive Shock	IEC 60068-2-27
Non-Repetitive Shock	IEC 60068-2-27

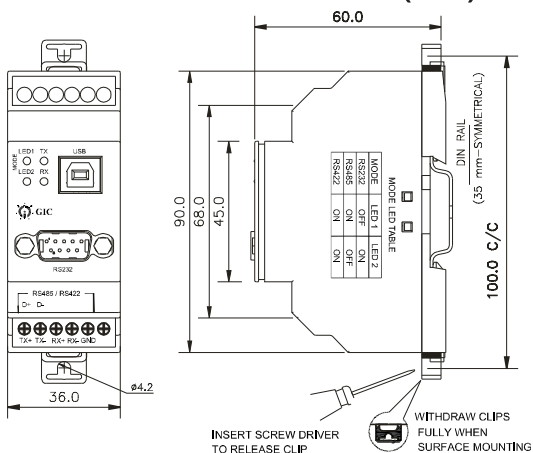
MOUNTING DIMENSIONS (mm)



TERMINAL TORQUE & CAPACITY

	0.54 N.m (6 Lb.in)
	1 x 2.5 mm ² Solid Wire/Stranded
AWG	1 x 24 to 12

RS232 to RS485 / RS 422 Converter

- Isolated RS485/RS422 on terminal block.
- RS232 with DB9 Female connector
- Auto direction control for RS485-2W transmission.
- Galvanic Isolation of 1500V for RS485/RS422.
- Supports Baud rate up to 230Kbps.
- Internal 1.5 kV ESD protection both RS232 and RS485/RS422.
- LED Indication for Transmit, Receive signal communication traffic.
- Input power supply range 9 to 26.4 VDC
- 2M enclosure with DIN Rail mounting.



Ordering Information

Cat. No.	Description
28B21A0	RS 232 to RS485/RS422 Converter
28E34B0	Accessory for Converter 28B21A0, Cable, DB9 Female to DB9 Male

RS232 to RS485 / RS 422 Converter



Cat. No.	28B21A0
Parameters	
RS232 Port	
Connector	D type 9 pin Female
Serial line protection	Internal 15 kV ESD
Isolated RS485/RS422 Port	
No. of Ports	1
RS422	TX+, TX-, RX+, RX
RS485	D+, D-
Serial line Protection	15kV ESD
Serial Communication Parameter	
Isolation	1500 V Galvanic
Parity	None, Even, Odd, Space, Mark
Data Bits	5,6,7,8
Stop Bits	1,1.5,2
Flow Control	None, XON/XOFF,
Speed	300 bps to 230 Kbps
LED Indication	TX, RX LED indication
Input Supply Voltage	9.4 - 26.4 VDC
Power Consumption	1W
Operating Temperature	0° C to + 60° C
Storage Temperature	-25° C to + 70° C
Humidity	95% (Rh)
Enclosure	Flame Retardant UL 94-V0
Dimension (W x H x D) (in mm)	36 X 90 X 52.3
Weight (unpacked) Approx.	100 g
Mounting	Base / DIN rail
Degree of Protection	IP 20 for Terminals, IP 40 for Enclosure
Certification	CE RoHS Compliant
Function and Application	This converter allows to interface any device using RS232 serial link to RS485/RS422 link. The RS485 specification allows to network up to 32 Nodes on the same lines, at speeds up to 10 Mbps to distances of 4,000 feet (1200 meters). RS485/RS422 links are much used in industrial process control where reliability is important.

EMI / EMC

ESD	IEC 61000-4-2
Radiated Susceptibility	IEC 61000-4-3
Electrical Fast Transients	IEC 61000-4-4
Surges	IEC 61000-4-5
Conducted Susceptibility	IEC 61000-4-6
Voltage Dips & Interruptions (DC)	IEC 61000-4-29
Conducted Emission	CISPR 14-1
Radiated Emission	CISPR 14-1

Environmental

Cold Heat	IEC 60068-2-1
Dry Heat	IEC 60068-2-2
Vibration	IEC 60068-2-6
Repetitive Shock	IEC 60068-2-27
Non-Repetitive Shock	IEC 60068-2-27

MOUNTING DIMENSIONS (mm)

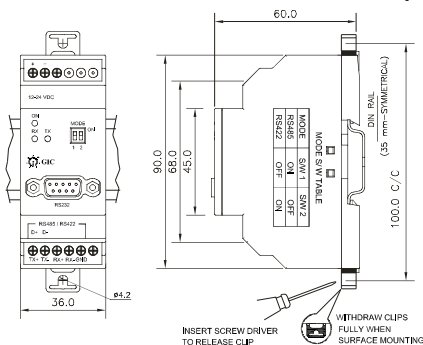

TERMINAL TORQUE & CAPACITY

	0.54 N.m (6 Lb.in)
	1 x 2.5 mm ² Solid Wire/Stranded
AWG	1 x 24 to 12

Signal Transducer

- Input / Output configuration selected via DIP switch combinations
- Choice of multiple analog input-output configurations
- Provides 3-way galvanic isolation of 3.75kV
- Fast output Response Time (<100ms)
- Sleek 22.5mm wide





Ordering Information

Cat. No.	Description
2SC3D11CC3	Signal Transducer, 24 VDC, 1 Input & 1 Output, Voltage & Current, 3 Port Isolation, Base / DIN, Input Signal: 0-10 VDC, 2-10 VDC, 0-20 mA, 4-20 mA
2SC3D11DC3	Signal Transducer, 24 VDC, 1 Input & 1 Output, Voltage & Current, 3 Port Isolation, Base / DIN, Input Signal: 0-5 VDC, 1-5 VDC, 0-20 mA, 4-20 mA
2SC3D11EC3	Signal Transducer, 24 VDC, 1 Input & 1 Output, Voltage & Current, 3 Port Isolation, Base / DIN, Input Signal: 0-10 VDC, 2-10 VDC, 0-10 mA, 2-10 mA

Signal Transducer



Cat. No.	2SC3D11CC3	2SC3D11DC3	2SC3D11EC3
Parameters			
Supply Voltage (ϕ)	24 V DC		
Supply Variation	-15% to +15% (of ϕ)		
Power Consumption (Max.)	4 VA		
Device Characteristics			
Input Signal	0-10V DC 2-10V DC 0-20mA DC 4-20mA DC	0-5 V DC 1-5 V DC 0-20mA DC 4-20mA DC	0-10V DC 2-10V DC 0-10mA DC 2-10mA DC
Input Impedance	Voltage I/P - 100K Ohm approx. Current I/P - 100 Ohm approx.		Voltage I/P - 100K Ohm approx. Current I/P - 200 Ohm approx.
Output Signal	0-10VDC, 2-10VDC (min. 1 kOhm load) 0-20mA DC, 4-20mA DC (max. 500 Ohm load)		
Accuracy	1% of full Scale		
Offset	± 5% of full scale Adjustable		
Gain	± 10% of full scale Adjustable		
Linearity	<0.02% of full scale		
Protections			
Input supply reverse polarity	Yes		
Input signal reverse polarity	Yes		
Output short circuit current	<25mA (Output Voltage mode)		
Output open circuit voltage	(12-14)VDC (Output Current mode)		
LED Indication	GREEN LED: Power ON		
Operating Temperature	-10°C to +55°C		
Storage Temperature	-15°C to +60°C		
Humidity (Non Condensing)	95% (Rh)		
Enclosure	Flame Retardant UL94-V0		
Dimension (W x H x D) (in mm)	22.5 X 83 X 100.5		
Weight (unpacked)	130 g		
Mounting	Din Rail Mounting		
Certification	 		
Degree of Protection	IP 20 for Terminals, IP 40 for Enclosure		

EMI / EMC

ESD	IEC 61000-4-2
Radiated Susceptibility	IEC 61000-4-3
Electrical Fast Transients on Supply	IEC 61000-4-4
Electrical Fast Transients on I/O Signal	IEC 61000-4-4
Surge on Supply	IEC 61000-4-5
Surge on I/O Signal	IEC 61000-4-5
Conducted Susceptibility	IEC 61000-4-6
Voltage Dips & Interruptions (DC)	IEC 61000-4-29
Conducted Emission	CISPR 14-1
Radiated Emission	CISPR 14-1

Environmental

Cold Heat	IEC 60068-2-1
Dry Heat	IEC 60068-2-2
Vibration	IEC 60068-2-6
Repetitive Shock	IEC 60068-2-27
Non-Repetitive Shock	IEC 60068-2-27

Signal Transducer



DIP SWITCH MODE SELECTION

SIGNAL TRANSDUCER-SERIES 225 SELECTION OF INPUT & OUTPUT SIGNAL MODE

Mode	Input Voltage / Input Current			Output Signal
	2SC3D11CC3	2SC3D11DC3	2SC3D11EC3	
	(0-10)V / (0-20)mA	(0-5)V / (0-20)mA	(0-10)V / (0-10)mA	(0-10)V
	(0-10)V / (0-20)mA	(0-5)V / (0-20)mA	(0-10)V / (0-10)mA	(0-20)mA
	(0-10)V / (0-20)mA	(0-5)V / (0-20)mA	(0-10)V / (0-10)mA	(2-10)V
	(0-10)V / (0-20)mA	(0-5)V / (0-20)mA	(0-10)V / (0-10)mA	(4-20)mA
	(2-10)V / (4-20)mA	(1-5)V / (4-20)mA	(2-10)V / (2-10)mA	(0-10)V
	(2-10)V / (4-20)mA	(1-5)V / (4-20)mA	(2-10)V / (2-10)mA	(0-20)mA
	(2-10)V / (4-20)mA	(1-5)V / (4-20)mA	(2-10)V / (2-10)mA	(2-10)V
	(2-10)V / (4-20)mA	(1-5)V / (4-20)mA	(2-10)V / (2-10)mA	(4-20)mA

1 2 3 4 5 6

MOUNTING DIMENSIONS (mm)

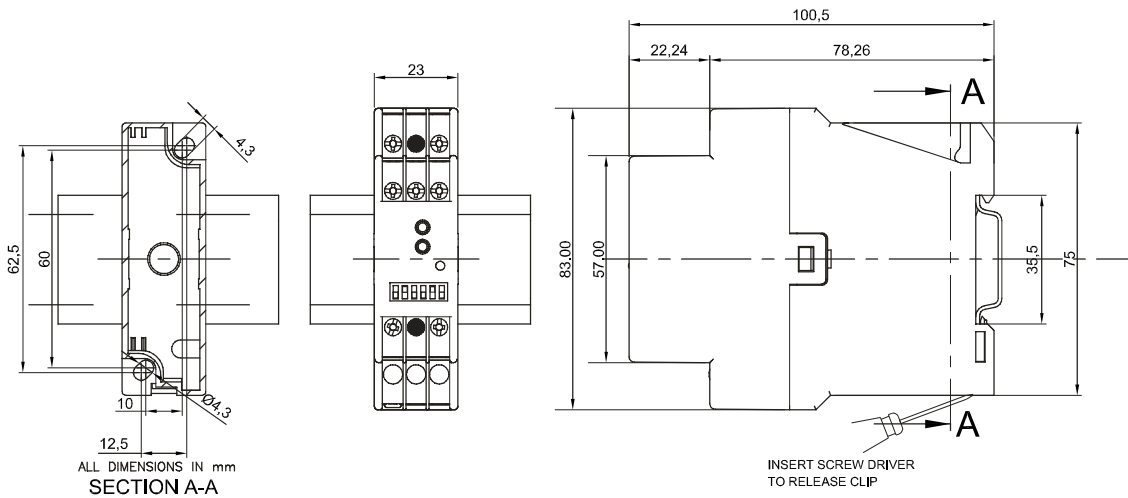

CONNECTION DIAGRAM

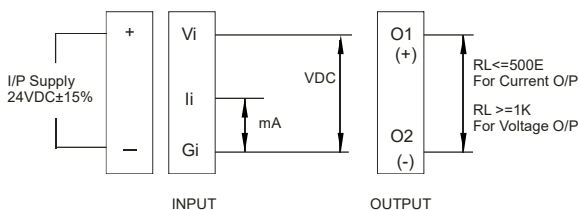

3 PORT ISOLATION DIAGRAM

3,75kV AC (input, supply and output)

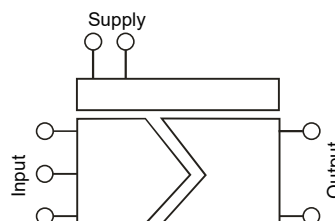

TERMINAL TORQUE & CAPACITY

	0.60 N.m (5.3 Lb.in)
Ø 3.5 mm...4.0mm	
	1 x 4.0 mm ² Solid/Stranded Wire
AWG	1 x 20 to 10



ISOLATED RELAY MODULES

.....
Isolated Relay Output Module
.....

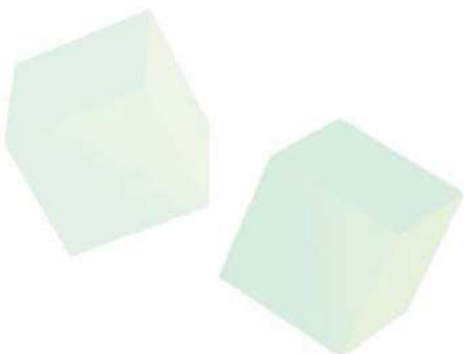

Isolated Relay Output Module

- Provides effective 3 way Isolation between supply, input switch & relay output
 - Provides isolation of dissimilar circuits
 - Enables control of multiple loads when only one relay output is available
 - Isolated Relays are mainly used in fire safety applications that interface with HVAC system, elevator controls and access control doors.
- It can also be integrated with PLC systems.





Ordering Information

Cat. No.	Description
IRLA01S	110-240 VAC, Isolated Relay Output Module with One channel, 1C/O, 8A
IRLA02S	110-240 VAC, Isolated Relay Output Module with Two channel, 2C/O, 8A
IRLA04S	110-240 VAC, Isolated Relay Output Module with Four channel, 4C/O, 8A
IRLA08S	110-240 VAC, Isolated Relay Output Module with Eight channel, 8C/O, 8A

Isolated Relay Output Module



Cat. No.			IRLA01S	IRLA02S	IRLA04S	IRLA08S
Parameters						
Function			Interface/ Control Relay			
Supply Voltage (Φ)			85 - 265 VAC			
Frequency			47 - 63 Hz			
Power Consumption (Maximum)			2.5 VA	3 VA	3.8 VA	5.6 VA
LED Indication	GREEN	ON	Power ON			
		OFF	Power OFF			
	RED	ON	Relay ON			
		OFF	Relay OFF			
Output	Relay	1 C/O, 8A (Res.) @ 240 VAC / 30 VDC				
	Contact Material	AgNi / AgSnO ₂				
Mechanical Life Expectancy			1x10 ⁷ Operations			
Electrical Life Expectancy			1x10 ⁷ Operations			
Operating Temperature			-20° C to +55 °C			
Storage Temperature			-25° C to +70 °C			
Relative Humidity (Non-Condensing)			15 to 85% (RH)			
Max. Operating Altitude			2000 m			
Degree of Protection			IP-20 for Terminals; IP-40 for Housing			
Pollution Degree			2			
Housing			Flame Retardant UL 94-V0			
Mounting			Base / Din-Rail (35 mm Symmetrical)			
Dimension (W x H x D) (in mm)			See the related Diagram			
Weight (packed) approx.			90 g	129 g	209 g	303 g
Certification			 			
Safety						
Test Voltage Between IEC 60947-5-1 ED.3.0 (2003-11)	Supply I/P to I/P Switch	4 kVAC				
	Supply I/P to O/P Switch	4 kVAC				
	I/P Switch to Relay O/P	4 kVAC				
Impulse Voltage Between I/P & O/P			IEC 60947-5-1			
Single Fault			IEC 61010-1			
Insulation Resistance			UL 508			
Leakage Current			UL 508			

EMI / EMC

Harmonic Current Emissions	IEC 61000-3-2
ESD	IEC 61000-4-2
Radiated Susceptibility	CISPR 14-1
Electrical Fast Transients	IEC 61000-4-4
Surges	IEC 61000-4-5
Conducted Susceptibility	IEC 61000-4-6
Voltage Dips & Interruptions (AC)	IEC 61000-4-11
Conducted Emission	CISPR 14-1
Radiated Emission	CISPR 14-1

Environmental Compliance

Cold Heat	IEC 60068-2-1
Dry Heat	IEC 60068-2-2
Vibration	IEC 60068-2-6
Repetitive Shock	IEC 60068-2-27
Non-Repetitive Shock	IEC 60068-2-27

Isolated Relay Output Module



MOUNTING DIMENSIONS (mm)

Single Channel

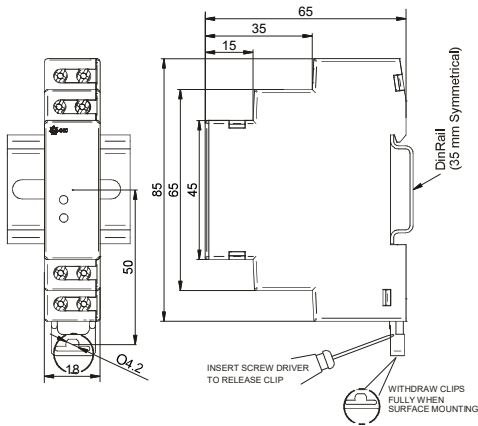

Two Channel

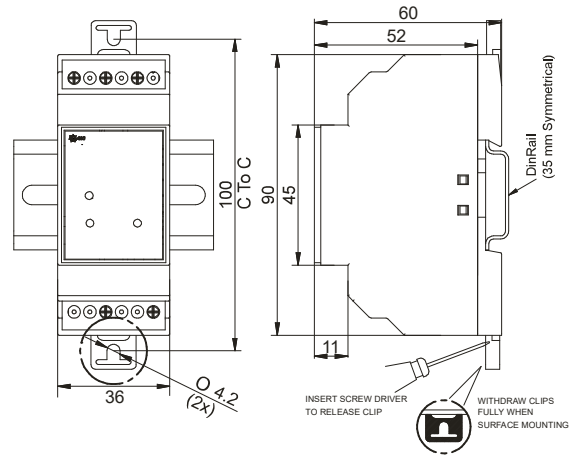

Four Channel

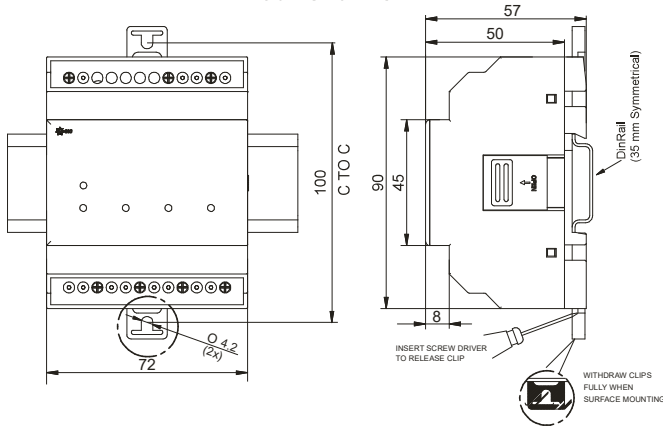

Eight Channel

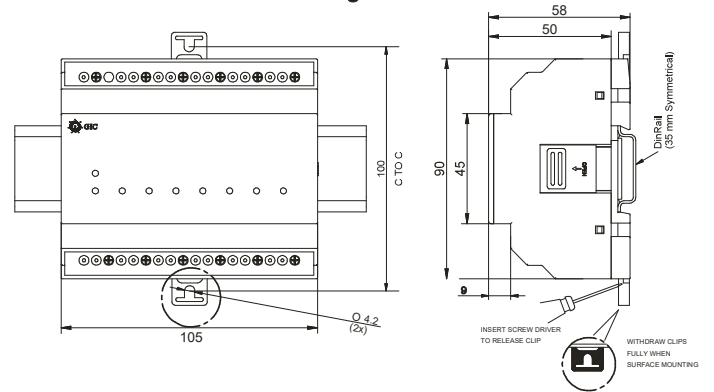

CONNECTION DIAGRAM

Single Channel

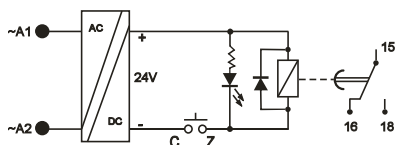

Two Channel

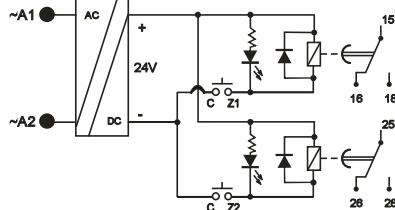

Four Channel

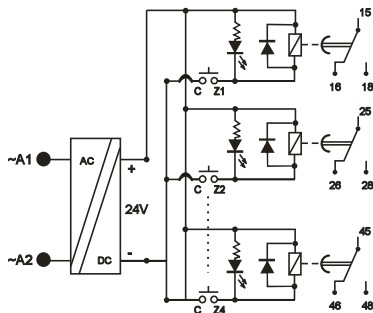

Eight Channel

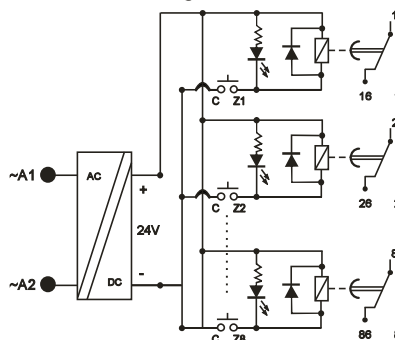

TERMINAL TORQUE & CAPACITY

Single Channel

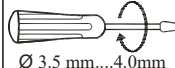
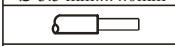
	0.60 N.m (6 Lb.in)
 Ø 3.5 mm....4.0mm	1 x 4.0 mm ² Solid/Stranded Wire
AWG	1 x 20 to 10

Two, Four & Eight Channel

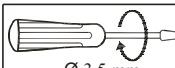
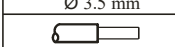
	0.54 N.m (6 Lb.in)
 Ø 3.5 mm	1 x 2.5 mm ² Solid/Stranded Wire
AWG	1 x 24 to 12



POWER SUPPLIES

Switched Mode Power Supply

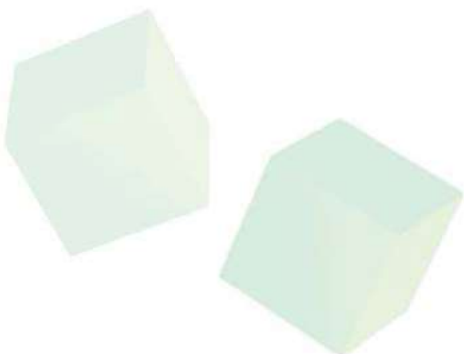

Switched Mode Power Supply

- Excellent Load & Line Regulation
- High Noise Immunity & Low Ripple
- No Load Power Consumption of less than 0.5W
- Overload & Short Circuit Protection
- High Efficiency of Operation
- Suitable for Temperatures upto 55°C
- Small Form Factor
- Peak Power Capacity
- Compact Design with DIN Mounting



Ordering Information

Cat. No.	Description
24AS244D6D	96W, 230V AC, 24 VDC / 4A, Switched Mode Power Supply (6M Size)
24AS126D6D	72W, 230V AC, 12 VDC / 6A, Switched Mode Power Supply (6M Size)
24BS24AD4E	60W, 110 - 240 VAC, 24 VDC / 2.5A, Switched Mode Power Supply (4M Size)
24BS241D2F	24W, 110 - 240 VAC, 24 VDC / 1A, Switched Mode Power Supply (2M Size)
24BS24BD1F	12W, 110 - 240 VAC, 24 VDC / 0.5A, Switched Mode Power Supply (1M Size)
24BS121D2F	12 W, 110 - 240 VAC, 12 VDC / 1.0A, Switched Mode Power Supply (2M Size)
24BS101D2F	10 W, 110 - 240 VAC, 10 VDC / 1.0A, Switched Mode Power Supply (2M Size)
24BS051D1F	5W, 110 - 240 VAC, 5 VDC / 1.0A, Switched Mode Power Supply (1M Size)

Switched Mode Power Supply



Cat. No.	24AS244D6D	24BS24AD4E	
Parameters			
Supply Voltage (⊕)	230 VAC	110-240V AC	
Supply Variation	-15% to 10%		
Frequency	50 Hz		
Power Consumption @ No Load	0.4W Max. @ 230 VAC		
AC Current	0.8A / 230 VAC	1.3A/115VAC & 0.7A/230VAC	
Efficiency	> 85%		
Inrush Current	Cold Start 50A / 230 VAC		
Leakage Current	< 0.2μA / 230 VAC		
Output	Voltage	24 VDC	
	Rated Current	4A	2.5A
	Current Range	0 - 4A	0 - 2.5A
	Rated Power	96W	60W
	Output Voltage Accuracy	± 1%	
	Line Regulation	1%	
	Load Regulation	1%	
	Ripple & Noise	150 mV (P-P)	
	Over Voltage Protection	26V ~ 33 V	26V ~ 38V
Over Load Capacity	168% of rated output (Max. 10s)	160% of rated output (Max. 10s)	
Continuous Open Circuit	Normal Operation		
Over Current Protection	Voltage Drop		
Continuous Short Circuit Protection	Auto Recovery after fault condition is removed		
Start Up Time	3s Max. (At minimum input voltage and rated load)		
Hold Up Time	30ms Min. (At minimum input voltage and rated load)		
Withstand Voltage	Input to Output 3 KV AC for 1 Minute, 5 mA		
LED Indications	Green LED: Output ON		
Operating Temperature	-10°C to + 55°C		
Storage Temperature	-25°C to + 85°C		
Enclosure	Flame Retardant UL94-V0		
Dimension (W x H x D) (in mm)	105 X 90 X 58	72 X 90 X 58	
Weight (unpacked) Approx.	105 g	260 g	
Mounting	Base / DIN Rail		
Certification			

EMI / EMC

Harmonic Current Emissions	IEC 61000-3-2
ESD	IEC 61000-4-2
Radiated Susceptibility	IEC 61000-4-3
Electrical Fast Transients	IEC 61000-4-4
Surges	IEC 61000-4-5
Conducted Susceptibility	IEC 61000-4-6
Voltage Dips & Interruptions (AC)	IEC 61000-4-11
Conducted Emission	CISPR 14-1
Radiated Emission	CISPR 14-1

Switched Mode Power Supply



MOUNTING DIMENSIONS (mm)

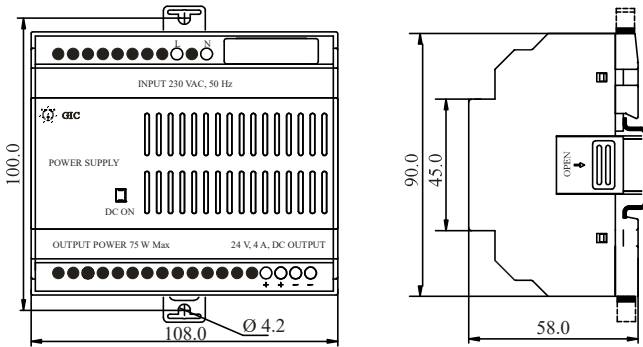

24AS244D6D, 24AS126D6D

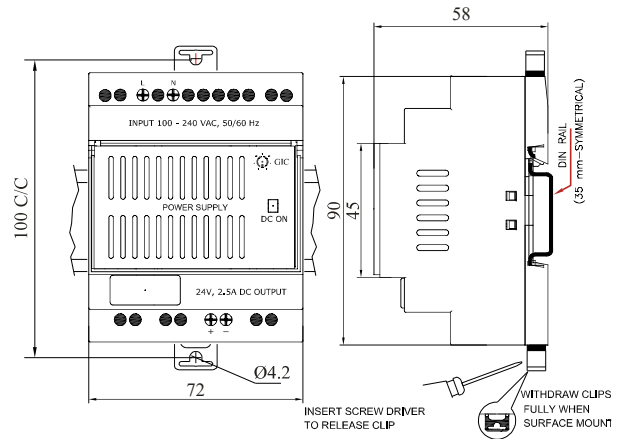

24BS24AD4E

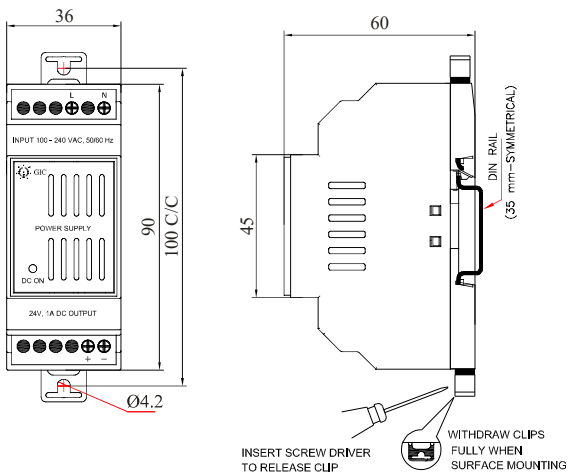

24BS241D2F, 24BS121D2F, 24BS101D2F

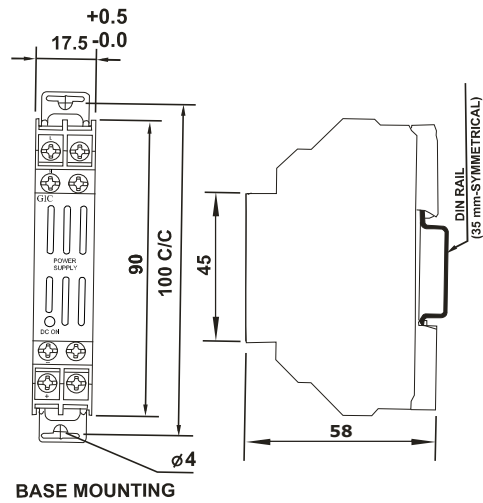

BASE MOUNTING

24BS24BD1F, 24BS051D1F

TERMINAL TORQUE & CAPACITY

	0.54 N.m (5 Lb.in)
	1 x 2.5 mm ² Solid Wire/Stranded
AWG	1 x 24 to 12

24AS244D6D, 24AS126D6D, 24BS24AD4E, 24BS241D2F, 24BS121D2F, 24BS101D2F

	0.7 N.m (6.2 Lb.in)
	2 x 2.5 mm ² Solid/Stranded Wire
AWG	24 x 10

24BS24BD1F, 24BS051D1F



MONITORING DEVICES

Voltage Monitoring Series

SM 800

SM 175

SM 301

SM 500

SM 501

Product Selection Chart: Voltage Monitoring

Three Phase Indicator

Frequency Monitoring Series PD 225

Current Monitoring Series

Earth Leakage Relay Series CMR

CMR - Current Control

Temperature Monitoring Series

PTC Thermistor Relay Series PD 225

PTC Thermistor & Single Phasing Preventer Series PD225

Equipment Room Temperature Control Relay

Level Monitoring Series

Liquid Level Controller



Voltage Monitoring Series SM 800

- LCD Display with Green backlight
- Multi-Voltage: Three Phase 4 Wire & Three Phase 3 Wire @ 145-500 VAC
- Protection against Phase loss, Phase Sequence, Phase Asymmetry, Under Voltage, Over Voltage, Neutral Open, Over Frequency and Under Frequency
- Can be configured for 3 Phase 3 Wire or 3 Phase 4 Wire system
- Selectable Over Voltage/ Under Voltage, Asymmetry, Phase Loss, Phase Sequence, Over Frequency/ Under Frequency
- Adjustable ON/OFF Time Delay in seconds/ minutes
- 5A Single and Dual relay outputs
- Two Separate Relay outputs with independent Programming
- Password protection
- Log of 5 previous faults for better monitoring
- Fail safe/ Non-Fail safe relay output
- Latch (Manual) and Non-Latch (Auto) Modes





Ordering Information

Cat. No.	Description
DMS110	145-500 VAC, Digital Voltage Monitoring Relay, 1C/O
DMS120	145-500 VAC, Digital Voltage Monitoring Relay, 1C/O + 1C/O
DMA220	85- 300 VAC/DC, Digital Voltage Monitoring Relay with Auxiliary supply, 1C/O + 1C/O

Voltage Monitoring Series SM 800



Cat. No.		DMS110	DMS120	DMA220
Parameters				
Supply Voltage (⊕)		145 - 500 VAC		85 - 300 VAC/DC
Frequency		45 to 65 Hz		
Trip Settings	Phase Loss	Configurable (Enable/Disable) (Default : Enable)		
	Phase Reverse	Configurable (Enable/Disable) (Default : Enable)		
	Phase Asymmetry	2 to 50%		
	Under Voltage	Phase voltage : 90 to 288 VAC		Phase voltage : 50 to 288 VAC
		Line voltage : 155 to 500 VAC		Line voltage : 85 to 500 VAC
	Under Voltage Hysteresis	3 to 20VAC +/- 2V (7V Default)		
	Over Voltage	Phase voltage : 90 to 288 VAC		Phase voltage : 50 to 288 VAC
		Line voltage : 155 to 500 VAC		Line voltage : 85 to 500 VAC
	Over Voltage Hysteresis	3 to 20VAC +/- 2V (7V Default)		
	Under Frequency	45 to 65 Hz		
Over Frequency	45 to 65 Hz			
Frequency Hysteresis	0.1 to 5 Hz			
Asymmetry	Voltage : 5 to 99 VAC (Default 60V)			
	Percentage : 2 to 50%			
Hysteresis for Asymmetry	Voltage : 3 to 99 VAC +/- 2V (Default 7V)			
	Percentage : 2 to 15%			
Power Consumption (Max.)		5 VA		
Time Delay	ON Delay	2sec to 999sec (Default : 5sec)		
	Trip Time (OFF Delay)	0.1 to 999sec (Phase loss & Phase reverse : <100ms) Default : Neutral Loss is <500ms & UV, OV, Asymmetry fault 5sec.		
Output	Relay Output	1 C/O	1 C/O + 1 C/O	1 C/O + 1 C/O
	Contact Rating	5A (Resistive) @ 240 VAC / 30 VDC		
	Electrical Life	1X10 ⁵ Operations		
	Mechanical Life	1X10 ⁷ Operations		
Utilization Category	AC-15	(V)	120/240 V	
		(A)	3/1.5 A	
	DC-13	(V)	24/125/250 V	
		(A)	2/0.22/0.1 A	
Operating Temperature		-10°C to + 60°C		
Storage Temperature		-20°C to + 70°C		
Humidity (Non Condensing)		95% (Rh)		
Enclosure		Flame Retardant UL 94-V0		
Dimension (W x H x D) (in mm)		36 x 90 x 67		
Weight		100 g		
Mounting		Base / DIN		
Degree of Protection		IP-20 for Enclosure & Terminals, IP-40 with Front Facia for Dust cover		
Certification		 		

EMI / EMC

Harmonic Current Emissions	IEC 61000-3-2
Voltage Flicker and Fluctuations	IEC 61000-3-3
ESD	IEC 61000-4-2
Radiated Susceptibility	IEC 61000-4-3
Electrical Fast Transients	IEC 61000-4-4
Surges	IEC 61000-4-5
Conducted Susceptibility	IEC 61000-4-6
Voltage Dips & Interruptions (AC)	IEC 61000-4-11
Voltage Dips & Interruptions (DC)	IEC 61000-4-29
Conducted Emission	CISPR 11
Radiated Emission	CISPR 11
Swell	As per GTS Standard's

Environmental

Cold Heat	IEC 60068-2-1
Dry Heat	IEC 60068-2-2
Vibration	IEC 60068-2-6

Safety:

Test Voltage Between I/P & O/P	IEC 60947-5-1 / UL 508
Test Voltage Between all Terminals & Enclosure	IEC 60947-5-1 / UL 508
Impulse Voltage Between I/P & O/P	IEC 60947-5-1



Voltage Monitoring Series SM 800

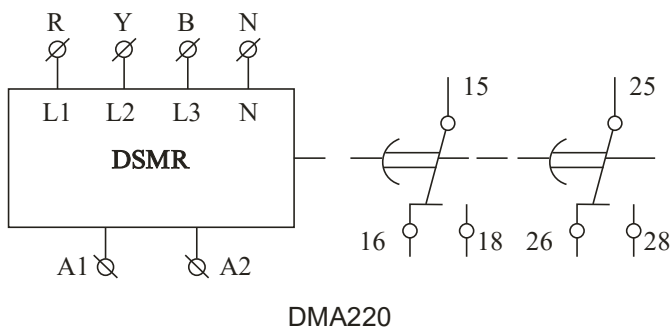
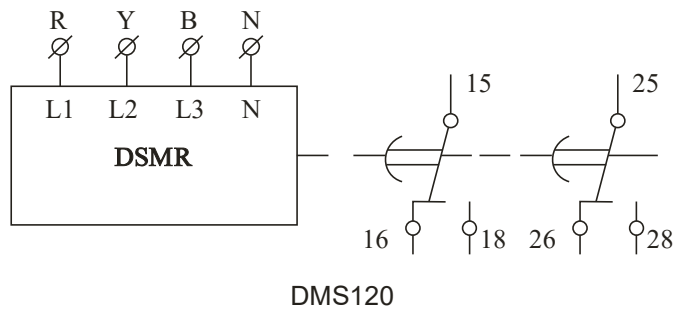
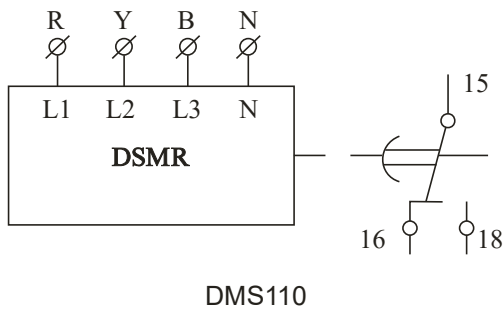

CONNECTION DIAGRAM

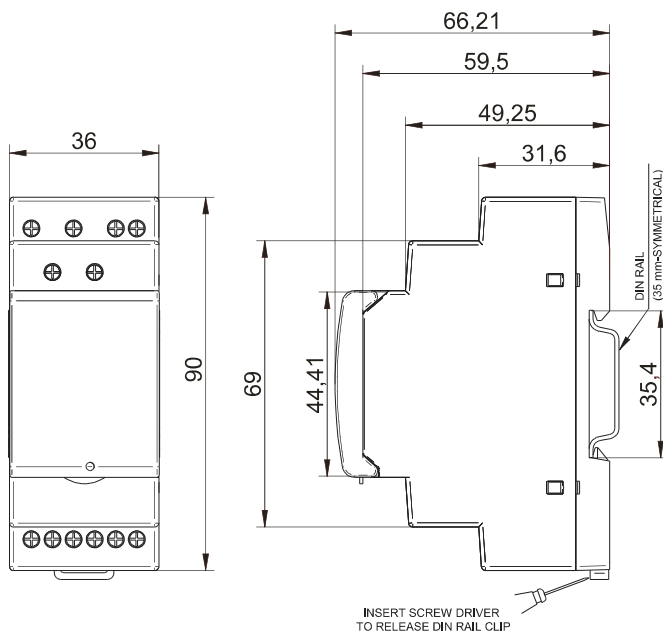

MOUNTING DIMENSION (mm)

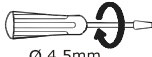

TERMINAL TORQUE & CAPACITY

 Ø 4.5mm	0.5 N.m (4.4 lb.in)
	1 x 4mm Solid / Standard Wire
AWG	26 to 10

Voltage Monitoring Series SM 175

- Compact 17.5 mm Wide
- Multi-Voltage: Three Phase 3 Wire @ 208-480 VAC or Three Phase 4 Wire @ 120-277 VAC
- Can be configured for 3 Phase 3 Wire or 3 Phase 4 Wire system
- Protection against Phase loss, Phase Sequence, Phase Asymmetry, Under Voltage & Over Voltage
- Selectable Under Voltage / Over Voltage, Asymmetry and Phase Sequence
- LED Indication for all Faults & for change in dip switch settings during runtime for better security
- Adjustable ON/OFF Time Delay in seconds / minutes
- 1 C/O Configuration





Ordering Information

Cat. No.	Description
MAG03D0424	208-480 VAC, UV/OV, Phase Loss, Phase Sequence, Phase Asymmetry Monitoring, 1 C/O
MAG03D0425	415 VAC (3P, 3W) / 240 VAC (3P, 4W), UV/OV, Phase Loss, Selectable Phase Sequence, Phase Asymmetry, 1C/O
MAG03D0426	415 VAC (3P, 3W) / 240 VAC (3P, 4W), UV/OV, Selectable Phase Sequence & Phase Asymmetry, ON Delay and OFF Delay (in sec/min), 1C/O
MAG03D0427	208-480 VAC (3P, 3W), Phase loss Monitoring, 1 C/O
MAG03D0428	208-480 VAC (3P, 3W), Phase Loss, Phase Sequence, 1C/O

Voltage Monitoring Series SM 175



Cat. No.		MAG03D0424	MAG03D0425	MAG03D0426	MAG03D0427	
Parameters						
Supply Voltage (ϕ)		208 to 480 VAC (3P,3W) 120 to 277 VAC (3P,4W)	415 VAC(3P,3W) / 240 VAC(3P,4W)		208-480 VAC(3P,3W)	
Supply Variation		+/- 23% (of ϕ)				
Frequency		50/60 Hz				
Reference Voltage		Settable	Fixed	Fixed	Fixed	
Trip Settings	Phase Loss	Yes	Yes	Yes	Yes	
	Phase Reverse	Yes	Settable through DIP S/W	Settable through DIP S/W	NA	
	Phase Asymmetry	10% Fixed	10% Fixed	10% Fixed / 5% to 25% Settable	30% Fixed	
	Under Voltage	2% to 22% (of ϕ)	5% to 25% (of ϕ) / 60% (of ϕ) Fixed	5% to 25% (of ϕ) / 80% (of ϕ) Fixed	NA	
	Over Voltage	2% to 22% (of ϕ)	110%(of ϕ) Fixed / 5% to 25%(of ϕ)	110%(of ϕ) Fixed	NA	
	Hysteresis (Phase Asy.)	2.7% Fixed			NA	
Hysteresis (UV/OV)		2% Fixed	2% to 12% Settable	2.7% Fixed	NA	
Power Consumption (Max.)		16 VA @ 415 VAC				
Time Delay	ON Delay	(0 to 15 Sec) settable / 5 sec (selectable DIP switch)		(0.5 to 15) settable sec / min	<=750 msec	
	Trip Time (OFF Delay)	5 sec / (0 to 15 Sec) settable (selectable DIP switch)		(0.5 to 15) settable sec / min	<=500 msec	
		100ms max for Phase loss & Phase Sequence				
Output	Relay Output	1 C/O				
	Contact Rating	5A @ 250 VAC / 30 VDC (Resistive)				
	Electrical Life	5X10 ⁴				
	Mechanical Life	1X10 ⁷				
Utilization Category	AC - 15	Rated Voltage (Ue): 120/240 V, Rated Current (Ie): 3.0/1.5 A				
	DC - 13	Rated Voltage (Ue): 24/125/250 V, Rated Current (Ie): 2.0/0.22/0.1 A				
LED Indications on front plate	Respective fault condition will be indicated by LED immediately & Relay will be tripped after specified trip time only.					
		Power LED/RV (Green)	UV (Red LED)	OV (Red LED)	ASY/PR (Red LED)	R LED ON indicates healthy supply & OFF indicates Phase loss
	Power ON	ON	OFF	OFF	OFF	
	Phase reverse	ON	OFF	OFF	ON	
	Asymmetry	ON	OFF	OFF	Slow BLINK	
	UV	ON	ON	OFF	OFF	
	OV	ON	OFF	ON	OFF	
	B Phase Loss	Slow BLINK	OFF	OFF	OFF	
Voltage Int.	OFF	OFF	OFF	OFF		
* 1. Multiple LEDs can operate indicating multiple faults at a time e.g. in case of phase loss, UV and phase asymmetry faults may also occur. 2. For cat id MAG03D0428, R LED ON indicates healthy supply & OFF indicates Phase loss. 3. For Outer Mode fault in MAG03D0425 product, UV and OV LED blinks@200 msec.						
Operating Temperature		- 20°C to +60°C				
Storage Temperature		- 25°C to +70°C				
Humidity (Non Condensing)		95% (Rh)				
Enclosure		Flame Retardant UL 94-V0				
Dimension (W x H x D) (in mm)		18 X 90 X 66.5				
Weight (unpacked)		72 g				
Mounting		Base / DIN rail				
Degree of Protection		IP 20 for Terminals, IP 30 for Enclosure				
Certification		 				

EMI / EMC

Harmonic Current Emissions	IEC 61000-3-2
ESD	IEC 61000-4-2
Radiated Susceptibility	IEC 61000-4-3
Electrical Fast Transients	IEC 61000-4-4
Surges	IEC 61000-4-5
Conducted Susceptibility	IEC 61000-4-6
Voltage Dips & Interruptions (AC)	IEC 61000-4-11
Conducted Emission	CISPR 11
Radiated Emission	CISPR 11

Environmental

Cold Heat	IEC 60068-2-1
Dry Heat	IEC 60068-2-2
Vibration	IEC 60068-2-6

Voltage Monitoring Series SM 175



Selection of Function: Operating Mode & timing can be selected by using DIP switches

DIP SWITCH SELECTION



Cat. No.: MAG03D0424

1	<input checked="" type="checkbox"/>	480	277
1	<input checked="" type="checkbox"/>	440	256
1	<input checked="" type="checkbox"/>	415	240
1	<input checked="" type="checkbox"/>	400	230
1	<input checked="" type="checkbox"/>	380	220
1	<input checked="" type="checkbox"/>	240	139
1	<input checked="" type="checkbox"/>	220	127
1	<input checked="" type="checkbox"/>	208	120
1 2 3	<input checked="" type="checkbox"/> <input checked="" type="checkbox"/> <input checked="" type="checkbox"/>	Ph - Ph (VAC)	Ph - N (VAC)
1	<input checked="" type="checkbox"/>	Settable OFF Delay	Fix ON Delay
1	<input checked="" type="checkbox"/>	Settable ON Delay	Fix OFF Delay
4	<input checked="" type="checkbox"/>	Delay	
1	<input checked="" type="checkbox"/>	Ph - Ph	
1	<input checked="" type="checkbox"/>	Ph - N	
5	<input checked="" type="checkbox"/>	Supply Type	

Cat. No.: MAG03D0425

1	<input checked="" type="checkbox"/>	Settable UV with fix OV *
1	<input checked="" type="checkbox"/>	Settable OV with fix UV *
1	<input checked="" type="checkbox"/>	Inner Mode
1	<input checked="" type="checkbox"/>	Outer Mode
1 2	<input checked="" type="checkbox"/> <input checked="" type="checkbox"/>	Function
1	<input checked="" type="checkbox"/>	Phase Seq. Disable
1	<input checked="" type="checkbox"/>	Phase Seq. Enable
3	<input checked="" type="checkbox"/>	Function
1	<input checked="" type="checkbox"/>	Settable OFF Delay
1	<input checked="" type="checkbox"/>	Fix ON Delay
1	<input checked="" type="checkbox"/>	Settable ON Delay
1	<input checked="" type="checkbox"/>	Fix OFF Delay
4	<input checked="" type="checkbox"/>	Delay
1	<input checked="" type="checkbox"/>	Ph - Ph
1	<input checked="" type="checkbox"/>	Ph - N
5	<input checked="" type="checkbox"/>	Supply Type

* Note : When POT - P1 is set as UV or OV through DIP S/W setting, then POT-P2 is used to set hysteresis ranging from 2% to 12%.

Cat. No.: MAG03D0426

1	<input checked="" type="checkbox"/>	Phase Seq. Disable
1	<input checked="" type="checkbox"/>	Phase Seq. Enable
1	<input checked="" type="checkbox"/>	Function
1	<input checked="" type="checkbox"/>	Settable UV(POT-P1) with fix assymetry
1	<input checked="" type="checkbox"/>	Settable ASY (POT-P1) with fix UV
2	<input checked="" type="checkbox"/>	Function
1	<input checked="" type="checkbox"/>	Settable (POT-P2) ON Delay in sec
1	<input checked="" type="checkbox"/>	Settable (POT-P2) ON Delay in min
3	<input checked="" type="checkbox"/>	Delay
1	<input checked="" type="checkbox"/>	Settable (POT-P3) OFF Delay in sec
1	<input checked="" type="checkbox"/>	Settable (POT-P3) OFF Delay in min
4	<input checked="" type="checkbox"/>	Delay
1	<input checked="" type="checkbox"/>	Ph - Ph
1	<input checked="" type="checkbox"/>	Ph - N
5	<input checked="" type="checkbox"/>	Supply Type

Cat. No.: MAG03D0425

Inner Mode: If user requires both UV and OV protection along with the healthy status of relay between UV and OV range then the user can set Inner mode configuration by selecting DIP switch 1 - high & 2 as low. For this setting P1 potentiometer will work as UV threshold and P2 potentiometer will work as OV threshold with fixed recovery hysteresis of 2% for both.

Outer Mode: If user requires both UV and OV protection along with the unhealthy status of relay between UV and OV range then the user can set outer configuration by selecting both DIP switches high. For this setting P1 potentiometer will work as UV threshold and P2 potentiometer will work as OV threshold with fixed recovery hysteresis of 2% for both.

CONNECTION DIAGRAM

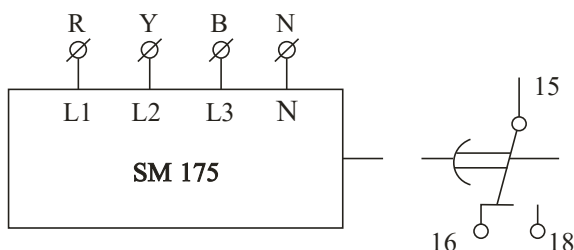

MAG03D0424, MAG03D0425, MAG03D0426, MAG03D0427, MAG03D0428

Voltage Monitoring Series SM 175

- Compact 17.5 mm Wide
- Protects against Phase Loss, Phase Reversal & Phase Asymmetry
- Multi-Voltage: Three Phase Three Wire @ 208 - 480 VAC
- Selectable Under Voltage / Over Voltage & Asymmetry
- LED Indication for all Faults & for change in settings during run time for better security
- Adjustable Time Delay
- 1 C/O Configuration





Ordering Information

Cat. No.	Description
MN21D5	208 - 480 VAC, Phase Loss Monitoring, 1 C/O
MK21D5	208 - 480 VAC, Phase Loss, Phase Sequence Monitoring , 1 C/O
MC21D5	208 - 480 VAC, Phase Loss, Phase Sequence, Phase Asymmetry Monitoring (30% Fixed), 1 C/O
MA21DN	208 - 480 VAC, Phase Loss, Phase Sequence, Phase Asymmetry Monitoring (5% to 15% Variable), 1 C/O
MOF1D51	208 - 480 VAC, Phase Loss, Phase Asymmetry Monitoring (10% Fixed), with trip time < 65 ms, 1 C/O

Voltage Monitoring Series SM 175



Cat. No.		MN21D5	MK21D5	MC21D5	MA21DN
Parameters					
Supply Voltage (φ)		208 - 480 VAC, (3 Phase 3 Wire)			
Supply Variation		-12% to + 10% (of φ)			
Frequency		50/60 Hz			
Power Consumption (Max.)		3 VA			
Trip Levels	Phase Loss	Yes	Yes	Yes	Yes
	Phase Sequence	N A	Yes	Yes	Yes
	Phase Asymmetry	30% Fixed	N A	30% Fixed	5% to 15%
Time Delay	ON Delay	< 750 ms	< 750 ms	< 750 ms	5s
	Trip Time (OFF Delay)	< 65 ms	100 ms	100 ms	0.5 to 15 s (Selectable)
Output	Relay Output	1 C/O			
	Contact Rating	5A @ 250 VAC / 30 VDC (Resistive)			
	Electrical Life	1X10 ⁵			
	Mechanical Life	3X10 ⁶			
Utilization Category	AC - 15	Rated Voltage (Ue): 120/240 V, Rated Current (Ie): 3.0/1.5 A			
	DC - 13	Rated Voltage (Ue): 24/125/250 V, Rated Current (Ie): 2.0/0.22/0.1 A			
LED Indication	Healthy	Relay LED Continuous ON			
	Phase Reverse	N A	Relay LED Flashing		
	Asymmetry	Relay LED Off (Red Colour)	N A	Relay LED Off (Red Colour)	
Operating Temperature		- 15° C to +60° C			
Storage Temperature		- 20° C to +80° C			
Humidity (Non Condensing)		95% (Rh)			
Enclosure		Flame Retardant UL 94-V0			
Dimension (W x H x D) (in mm)		18 x 58.5 x 90			
Weight (unpacked)		70 g			
Mounting		Base / DIN rail			
Degree of Protection		IP 20 for Terminal, IP 30 for Enclosure			
Certification		  			

EMI / EMC

Harmonic Current Emissions	IEC 61000-3-2
ESD	IEC 61000-4-2
Radiated Susceptibility	IEC 61000-4-3
Electrical Fast Transients	IEC 61000-4-4
Surges	IEC 61000-4-5
Conducted Susceptibility	IEC 61000-4-6
Voltage Dips & Interruptions (AC)	IEC 61000-4-11
Conducted Emission	CISPR 14-1
Radiated Emission	CISPR 14-1

Environmental

Cold Heat	IEC 60068-2-1
Dry Heat	IEC 60068-2-2
Vibration	IEC 60068-2-6
Repetitive Shock	IEC 60068-2-27
Non-Repetitive Shock	IEC 60068-2-27

Voltage Monitoring Series SM 175





Ordering Information

Cat. No.	Description
MD21DF	208 - 480 VAC, UV / OV, Phase Loss & Sequence with Selectable OFF Delay, 1 C/O
MG21DH	208 - 480 VAC, UV / OV & SPP with Selectable ON Delay, 1 C/O
MG21DF	208 - 480 VAC, UV / OV & SPP with Selectable OFF Delay, 1 C/O
MGD1DR	208 - 480 VAC, UV / OV & SPP with Selectable ON Delay & OFF Delay, 1 C/O
MAE03D0200	240 VAC/DC, UV / OV with Selectable ON & OFF Delay, 1 C/O
MF41B0	230 VAC, Single Phase Under Voltage Relay
MF51B0	400 VAC, Three Phase Under Voltage Relay

UL Approval not applicable to Cat Nos. MN21D5, MOF1D51, MGD1DR, MAE03D0200, MF41B0, MF51B0

Voltage Monitoring Series SM 175



Cat. No.		MD21DF	MG21DH	MG21DF	MGD1DR
Parameters					
Supply Voltage (ϕ)		208 - 480 VAC, (3 Phase 3 Wire)			400 VAC, (3 Phase 3 Wire)
Supply Variation		-12% to + 10% (of ϕ)			
Frequency		50/60 Hz			
Power Consumption (Max.)		3 VA			
Settable Nominal Voltage		208 - 220 - 380 - 400 - 415 - 440 - 480 VAC			N A
Trip Levels	Phase Loss	Yes			
	Phase Sequence	Yes			
	Phase Asymmetry	N A	10% Fixed		
	Under Voltage	-2% to -20% (of ϕ)	-5% to -25% (of ϕ)		
	Over Voltage	+2% to +20% (of ϕ)	+5% to +25% (of ϕ)		
Time Delay	ON Delay	5 s	0.5 to 100 s (Selectable)	5 s	0.5 to 100 s (Selectable)
	Trip Time (OFF Delay)	0.5 to 15 s (Selectable)	5 s	0.5 to 100 s (Selectable)	0.5 to 15 s (Selectable)
Output	Relay Output	1 C/O			
	Contact Rating	5A @ 250 VAC / 30 VDC (Resistive)			
	Electrical Life	1X10 ⁵			
	Mechanical Life	3X10 ⁶			
Utilization Category	AC - 15	Rated Voltage (Ue): 120/240 V, Rated Current (Ie): 3.0/1.5 A			
	DC - 13	Rated Voltage (Ue): 24/125/250 V, Rated Current (Ie): 2.0/0.22/0.1 A			
LED Indication	Healthy	Red LED: Supply Healthy → Continuous ON, Phase Reverse → Flashing			
	UV	Red LED: Under Voltage → Continuous ON			
	OV	Red LED: Over Voltage → Continuous ON			
	Asymmetry	Red LED: Asymmetry → Continuous ON			
	All LED's	Phase Fail or Higher Cut OFF(> 560 VAC) or lower cut off (<175 VAC), Blinking → Pot changed during running conditions			
Operating Temperature		- 15° C to +60° C			
Storage Temperature		- 20° C to +80° C			
Humidity (Non Condensing)		95% (Rh)			
Enclosure		Flame Retardant UL 94-V0			
Dimension (W x H x D) (in mm)		18 X 90 X 58.5			
Weight (unpacked) Approx.		70 g			
Mounting		Base / DIN rail			
Degree of Protection		IP 20 for Terminal, IP 30 for Enclosure			
Certification		  			

EMI / EMC

Harmonic Current Emissions	IEC 61000-3-2
ESD	IEC 61000-4-2
Radiated Susceptibility	IEC 61000-4-3
Electrical Fast Transients	IEC 61000-4-4
Surges	IEC 61000-4-5
Conducted Susceptibility	IEC 61000-4-6
Voltage Dips & Interruptions (AC)	IEC 61000-4-11
Conducted Emission	CISPR 14-1
Radiated Emission	CISPR 14-1

Environmental

Cold Heat	IEC 60068-2-1
Dry Heat	IEC 60068-2-2
Vibration	IEC 60068-2-6
Repetitive Shock	IEC 60068-2-27
Non-Repetitive Shock	IEC 60068-2-27

Voltage Monitoring Series SM 301

- Protects against Phase Loss, Phase Reversal & Phase Asymmetry
- No Auxiliary Supply needed
- Voltage Sensing principle
- 1 C/O & 2 C/O Configurations
- Designed to meet Industrial and Agricultural segment applications





Ordering Information

Cat. No.	Description
MA51BC	415 VAC, Single Phasing Preventor with 65 VAC Asymmetry, 1 C/O
MA51BK	415 VAC, Single Phasing Preventor with 40 VAC Asymmetry, 1 C/O
MC21B5	415 VAC, Single Phasing Preventor with 65 VAC Asymmetry, 2 C/O
MA59B5	415 VAC, Phase Loss Monitoring with Non Fail Safe Type, 1 C/O

Voltage Monitoring Series SM 301



Cat. No.		MA51BC	MA51BK	MC21B5
Parameters				
Supply Voltage (±)		415 VAC		
Frequency		50/60 Hz		
Power Consumption (Max.)		15 VA		
Trip Settings	Phase Loss	Yes	Yes	Yes
	Phase Sequence	Yes	Yes	Yes
	Phase Asymmetry	65 V (± 10V)	40 V (± 10 V)	65 V (± 10V)
	Hysteresis	10 to 18 V	10 to 18 V	10 to 18 V
Time Delay	ON Delay	2 s (± 2 s)	2 s (± 2 s)	< 550 ms
	Trip Time (OFF Delay)	7 s (± 2 s)	7 s (± 2 s)	< 550 ms
Output	Relay Output	1 C/O		2 C/O
	Contact Rating	5A (For 'NO') & 3A (For 'NC') @ 250 VAC / 28 VDC (Resistive)		5A @ 250 VAC / 28 VDC (Resistive)
	Electrical Life	1X10 ⁵		
	Mechanical Life	3X10 ⁵		
Utilization Category	AC - 15	Rated Voltage (Ue): 120/240 V, Rated Current (Ie): 3.0/1.5 A		
	DC - 13	Rated Voltage (Ue): 24/125/250 V, Rated Current (Ie): 2.0/0.22/0.1 A		
LED Indication		Red → Relay ON (Healthy), See Note 1		
Operating Temperature		- 15° C to + 50° C		
Storage Temperature		- 20° C to + 65° C		
Humidity (Non Condensing)		95% (Rh)		
Enclosure		Flame Retardant UL 94-V0		
Dimension (W x H x D) (in mm)		36 X 90 X 60		
Weight (unpacked)		120 g		
Mounting		Base / DIN rail		
Degree of Protection		IP20 for Terminals, IP 40 for Enclosure		
Certification		 		

EMI / EMC

Harmonic Current Emissions	IEC 61000-3-2
ESD	IEC 61000-4-2
Radiated Susceptibility	IEC 61000-4-3
Electrical Fast Transients	IEC 61000-4-4
Surges	IEC 61000-4-5
Conducted Susceptibility	IEC 61000-4-6
Voltage Dips & Interruptions (AC)	IEC 61000-4-11
Conducted Emission	CISPR 14-1
Radiated Emission	CISPR 14-1

Environmental

Cold Heat	IEC 60068-2-1
Dry Heat	IEC 60068-2-2

Note 1:- ON: Relay ON, OFF: Phase Loss, Blinking: Asymmetry (200 ms, On/Off), Flashing: Phase Sequence (1 s, On/Off)

Voltage Monitoring Series SM 500

- Protects against Phase Loss, Phase Reversal & Phase Asymmetry
- Can be configured for 3 Phase 4 Wire or 1 Phase system
- Selectable Over Voltage / Under Voltage Trip level
- Selectable Time Delay
- LED Indications for Power and Fault conditions
- Voltage Sensing principle
- 1 C/O or 2 C/O Configuration





Ordering Information

Cat. No.	Description
MD71BH	240 VAC, UV / OV with Selectable ON Delay (0.5 to 15 sec), 1 C/O
MD71BF	240 VAC, UV / OV with Selectable OFF Delay (0.5 to 15 sec), 1 C/O
MD71B9	240 VAC, UV / OV with Selectable ON Delay (0.5 s to 15 min), 1 C/O

Voltage Monitoring Series SM 500



Cat. No.		MD71BH	MD71BF	MD71B9
Parameters				
Supply Voltage (ϕ)		240 VAC (1 Phase & 3 Phase, 4 Wire)		
Frequency		50/60 Hz		
Power Consumption (Max.)		4 VA		
Trip Settings	Phase Loss	Yes	Yes	Yes
	Phase Sequence	N.A	N.A	N.A
	Phase Asymmetry	N.A	N.A	N.A
	Under Voltage	55% to 95% (of ϕ)		
	Over Voltage	105% to 125% (of ϕ)		
Time Delay	ON Delay	0.5 to 15 s (Selectable)	5 s	0.5 s to 15 min (Selectable)
	Trip Time (OFF Delay)	5 s	0.5 to 15 s (Selectable)	5 s
Output	Relay Output	1 C/O		
	Contact Rating	5A @ 250 VAC / 28 VDC (Resistive)		
	Electrical Life	1X10 ⁵		
	Mechanical Life	3X10 ⁶		
Utilization Category	AC - 15	Rated Voltage (Ue): 120/240 V, Rated Current (Ie): 3.0/1.5 A		
	DC - 13	Rated Voltage (Ue): 24/125/250 V, Rated Current (Ie): 2.0/0.22/0.1 A		
LED Indication		Separate indications for Power ON, UV and OV		
Operating Temperature		-15° C To + 55° C		
Storage Temperature		-25° C To + 70° C		
Humidity (Non Condensing)		95% (Rh)		
Enclosure		Flame Retardant UL 94-V0		
Dimension (W x H x D) (in mm)		36 X 60 X 90		
Weight (unpacked) Approx.		120 g		
Mounting		Base / DIN rail		
Degree of Protection		IP 20 for Terminals, IP 40 for Enclosure		
Certification		 		

EMI / EMC

Harmonic Current Emissions	IEC 61000-3-2
ESD	IEC 61000-4-2
Radiated Susceptibility	IEC 61000-4-3
Electrical Fast Transients	IEC 61000-4-4
Surges	IEC 61000-4-5
Conducted Susceptibility	IEC 61000-4-6
Voltage Dips & Interruptions (AC)	IEC 61000-4-11
Conducted Emission	CISPR 14-1
Radiated Emission	CISPR 14-1

Environmental

Cold Heat	IEC 60068-2-1
Dry Heat	IEC 60068-2-2
Vibration	IEC 60068-2-6
Repetitive Shock	IEC 60068-2-27
Non-Repetitive Shock	IEC 60068-2-27

Note: 1) Voltage setting is with respect to Neutral. Voltage Setting Accuracy: ± 5 % of Full Scale; Time Setting Accuracy: ± 10 % of Full Scale

Voltage Monitoring Series SM 500





Ordering Information

Cat. No.	Description
MG73B9	240 VAC, UV / OV & Single Phasing Preventor (SPP) with Selectable ON Delay (0.5 s to 15 min), 2 C/O
MG73BH	240 VAC, UV / OV & SPP with Selectable ON Delay (0.5 to 15 sec), 2 C/O
MG73BF	240 VAC, UV / OV & SPP with Selectable OFF Delay (0.5 to 15 sec), 2 C/O
MG73BQ	120 - 240 VAC Selectable, UV / Selectable OV & SPP with Selectable OFF Delay (0.5 to 15 sec), 2 C/O
MG73BR	240 VAC, Fixed UV / OV & SPP, 20% Asymmetry with Fixed ON (10 sec) & OFF (5 sec) Delay, 2 C/O
MGH3BH	220 VAC, UV / OV & SPP with Selectable ON Delay (0.5 to 15 sec), 2 C/O
MGH3BF	220 VAC, UV / OV & SPP with Selectable OFF Delay (0.5 to 15 sec), 2 C/O
MGI3BF	230 VAC, UV / OV & SPP with Selectable OFF Delay (0.5 to 15 sec), 2 C/O

Voltage Monitoring Series SM 500



Cat. No.		MG73BH	MG73BF	MG73B9
Parameters				
Supply Voltage (φ)		240 VAC (1 Phase & 3 Phase, 4 Wire)		
Frequency		50/60 Hz		
Power Consumption (Max.)		4 VA (Max)		
Trip Settings	Phase Loss	Yes		
	Phase Sequence	Yes		
	Phase Asymmetry	10% (of φ)		
	Under Voltage	55% to 95% (of φ)		
	Over Voltage	105% to 125% (of φ)		
	Hysteresis	7 V (± 2 V)		
Time Delay	ON Delay	0.5 to 15 s (Selectable)	5 s	0.5 s to 15 min (Selectable)
	Trip Time (OFF Delay)	5 s	0.5 to 15 s (Selectable)	5 s
Output	Relay Output	2 C/O		
	Contact Rating	5A @ 250 VAC / 28 VDC (Resistive)		
	Electrical Life	1X10 ⁵		
	Mechanical Life	3X10 ⁶		
Utilization Category	AC - 15	Rated Voltage (Ue): 120/240 V, Rated Current (Ie): 3.0/1.5 A		
	DC - 13	Rated Voltage (Ue): 24/125/250 V, Rated Current (Ie): 2.0/0.22/0.1 A		
LED Indication		Separate indications for Power ON, UV and OV; ON: Phase Reverse; BLINK: Phase Asymmetry		
Operating Temperature		-15° C To + 55° C		
Storage Temperature		-25° C To + 70° C		
Humidity (Non Condensing)		95% (Rh)		
Enclosure		Flame Retardant UL 94-V0		
Dimension (W x H x D) (in mm)		36 X 60 X 90		
Weight (unpacked)		120 g		
Mounting		Base / DIN rail		
Degree of Protection		IP 20 for Terminals, IP 40 for Enclosure		
Certification		 		

EMI / EMC

Harmonic Current Emissions	IEC 61000-3-2
ESD	IEC 61000-4-2
Radiated Susceptibility	IEC 61000-4-3
Electrical Fast Transients	IEC 61000-4-4
Surges	IEC 61000-4-5
Conducted Susceptibility	IEC 61000-4-6
Voltage Dips & Interruptions (AC)	IEC 61000-4-11
Conducted Emission	CISPR 14-1
Radiated Emission	CISPR 14-1

Environmental

Cold Heat	IEC 60068-2-1
Dry Heat	IEC 60068-2-2
Vibration	IEC 60068-2-6
Repetitive Shock	IEC 60068-2-27
Non-Repetitive Shock	IEC 60068-2-27

Note: 1) Voltage setting is with respect to Neutral. Voltage Setting Accuracy: ± 5 % of Full Scale; Time Setting Accuracy: ± 10 % of Full Scale

Voltage Monitoring Series SM500 - Neutral Loss Protection

- Phase loss (failure) detection
- Neutral loss detection
- Phase reverse detection
- Phase asymmetry
- Adjustable Over & Under voltage trip level
- LED indication for all failure conditions
- Automatic recovery on fault removal



Ordering Information

Cat. No.	Description
MAC04D0100	415 VAC, Neutral Loss Protection with Phase and Voltage Control, 2 C/O
MAC04D0119	380 VAC, Neutral Loss Protection with Phase and Voltage Control, 2 C/O
MAC04D0121	415VAC, Neutral Loss Protection with Phase & Voltage Control, Phase reverse disable, 2C/O
MAC04D0123	Selectable reference voltage (220-480VAC), Neutral Loss Protection with Phase & Voltage Control, 2C/O

Voltage Monitoring Series SM 501

- Protects against Phase Loss, Phase Reversal & Phase Asymmetry
- Suitable for 3 Phase 3 Wire system
- Selectable Under Voltage / Over Voltage Trip level
- Selectable Time Delay
- Models for Selectable Phase Asymmetry
- LED Indications for Power and Fault conditions
- Voltage Sensing Principle
- 2 C/O Configuration





Ordering Information

Cat. No.	Description
MG53BH	415 VAC, UV / OV & Single Phasing Preventor (SPP) with Selectable ON Delay (0.5 to 15 sec), 2 C/O
MG53BF	415 VAC, UV / OV & SPP with Selectable OFF Delay (0.5 to 15 sec), 2 C/O
MG63BH	220 VAC, UV / OV & SPP with Selectable ON Delay (0.5 to 15 sec), 2 C/O
MG63BF	220 VAC, UV / OV & SPP with Selectable OFF Delay (0.5 to 15 sec), 2 C/O

Voltage Monitoring Series SM 501



Cat. No.		MG53BH	MG53BF	MG63BH	MG63BF
Parameters					
Supply Voltage (ϕ)		415 VAC (3 Phase, 3 Wire)		220 VAC (3 Phase, 3 Wire)	
Frequency		50/60 Hz			
Power Consumption (Max.)		10 VA		5 VA	
Trip Settings	Phase Loss	Yes			
	Phase Sequence	Yes			
	Phase Asymmetry	10% (of ϕ)			
	Under Voltage	55% to 95% (of ϕ)			
	Over Voltage	105% to 125% (of ϕ)			
	Hysteresis	7 V (\pm 2 V) of Trip Voltage			
Time Delay	ON Delay	0.5 to 15 s (Selectable)	5 s	0.5 to 15 s (Selectable)	5 s
	Trip Time (OFF Delay)	5 s	0.5 to 15 s (Selectable)	5 s	0.5 to 15 s (Selectable)
Output	Relay Output	2 C/O			
	Contact Rating	5A @ 250 VAC / 28 VDC (Resistive)			
	Electrical Life	1X10 ⁵			
	Mechanical Life	3X10 ⁶			
Utilization Category	AC - 15	Rated Voltage (Ue): 120/240 V, Rated Current (Ie): 3.0/1.5 A			
	DC - 13	Rated Voltage (Ue): 24/125/250 V, Rated Current (Ie): 2.0/0.22/0.1 A			
LED Indication		Separate indications for Power ON, UV and OV; ON: Phase Reverse; BLINK: Phase Asymmetry			
Operating Temperature		-15° C To + 55° C			
Storage Temperature		-25° C To + 70° C			
Humidity (Non Condensing)		95% (Rh)			
Enclosure		Flame Retardant UL 94-V0			
Dimension (W x H x D) (in mm)		36 X 90 X 60			
Weight (unpacked)		120 g			
Mounting		Base / DIN rail			
Degree of Protection		IP 20 for Terminals, IP 40 for Enclosure			
Certification		 			

EMI / EMC

Harmonic Current Emissions	IEC 61000-3-2
ESD	IEC 61000-4-2
Radiated Susceptibility	IEC 61000-4-3
Electrical Fast Transients	IEC 61000-4-4
Surges	IEC 61000-4-5
Conducted Susceptibility	IEC 61000-4-6
Voltage Dips & Interruptions (AC)	IEC 61000-4-11
Conducted Emission	CISPR 14-1
Radiated Emission	CISPR 14-1

Environmental

Cold Heat	IEC 60068-2-1
Dry Heat	IEC 60068-2-2
Vibration	IEC 60068-2-6
Repetitive Shock	IEC 60068-2-27
Non-Repetitive Shock	IEC 60068-2-27

Note: 1) Voltage Setting Accuracy: \pm 5 % of Full Scale; Time Setting Accuracy: \pm 10 % of Full Scale

2) In the event of Phase Sequence or Phase Loss, OFF Delay is 100 ms

Voltage Monitoring Series SM 501



Ordering Information

Cat. No.	Description
MG53BI	415 VAC, UV / OV & Single Phasing Preventor (SPP) with 65 V Asymmetry, 2 C/O
MG53BO	415 VAC, UV / OV & SPP with 3 min ON Delay & 5s OFF Delay, 2 C/O
MB53BM	415 VAC, UV / OV (110% Fixed) & SPP with Selectable Asymmetry (5% to 17%), 2 C/O
MG53BQ	415 VAC, UV / OV & SPP with 30 V Asymmetry, 3 Sec ON Delay, 2 C/O

Voltage Monitoring Series SM 501



Cat. No.		MG53BI	MG53BO	MB53BM
Parameters				
Supply Voltage (ϕ)		415 VAC (3 Phase, 3 Wire)		
Frequency		50/60 Hz		
Power Consumption (Max.)		10 VA		
Trip Settings	Phase Loss	Yes	Yes	Yes
	Phase Sequence	Yes	Yes	Yes
	Phase Asymmetry	65 V	10%	5% to 17%
	Under Voltage	55% to 95% (of ϕ)	85% (of ϕ) Fixed	80% (of ϕ) Symmetrical
	Over Voltage	105% to 125% (of ϕ)	110% (of ϕ) Fixed	110% Fixed
	Hysteresis	7 V (\pm 2 V) of Trip Voltage	7 V (\pm 2 V) of Trip Voltage	7 V (\pm 2 V) of Input Voltage
Time Delay	ON Delay	5 s	3 min	0.5 to 15 s (Selectable)
	Trip Time (OFF Delay)	5 s	5 s	0.5 to 15 s (Selectable)
Output	Relay Output	2 C/O		
	Contact Rating	5A @ 250 VAC / 28 VDC (Resistive)		
	Electrical Life	1X10 ⁵		
	Mechanical Life	3X10 ⁶		
Utilization Category	AC - 15	Rated Voltage (Ue): 120/240 V, Rated Current (Ie): 3.0/1.5 A		
	DC - 13	Rated Voltage (Ue): 24/125/250 V, Rated Current (Ie): 2.0/0.22/0.1 A		
LED Indication		Separate indications for Power ON, UV and OV; ON: Phase Reverse; BLINK: Phase Asymmetry		
Operating Temperature		-15° C To + 55° C		
Storage Temperature		-25° C To + 70° C		
Humidity (Non Condensing)		95% (Rh)		
Enclosure		Flame Retardant UL 94-V0		
Dimension (W x H x D) (in mm)		36 X 90 X 60		
Weight (unpacked)		120 g		
Mounting		Base / DIN rail		
Degree of Protection		IP 20 for Terminals, IP 40 for Enclosure		
Certification		 		

EMI / EMC

Harmonic Current Emissions	IEC 61000-3-2
ESD	IEC 61000-4-2
Radiated Susceptibility	IEC 61000-4-3
Electrical Fast Transients	IEC 61000-4-4
Surges	IEC 61000-4-5
Conducted Susceptibility	IEC 61000-4-6
Voltage Dips & Interruptions (AC)	IEC 61000-4-11
Conducted Emission	CISPR 14-1
Radiated Emission	CISPR 14-1

Environmental

Cold Heat	IEC 60068-2-1
Dry Heat	IEC 60068-2-2
Vibration	IEC 60068-2-6
Repetitive Shock	IEC 60068-2-27
Non-Repetitive Shock	IEC 60068-2-27

Note: 1) Voltage Setting Accuracy: \pm 5 % of Full Scale; Time Setting Accuracy: \pm 10 % of Full Scale

2) In the event of Phase Sequence or Phase Loss, OFF Delay is 100 ms

3) MG53BQ does not detect Phase Sequence Fault

Voltage Monitoring Series



CONNECTION DIAGRAM

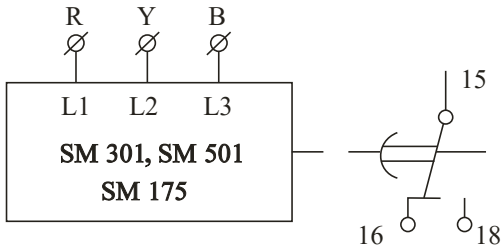

MA51BC, MA51BK, MN21D5, MK21D5, MC21D5
MA21DN, MD21DF, MG21DH, MG21DF, MGD1DR

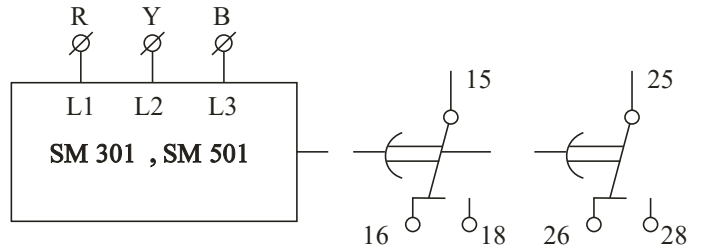

MG53BH, MG53BF, MG63BH, MG63BF
MG53BI, MG53BO, MB53BM, MC21B5

SINGLE PHASE

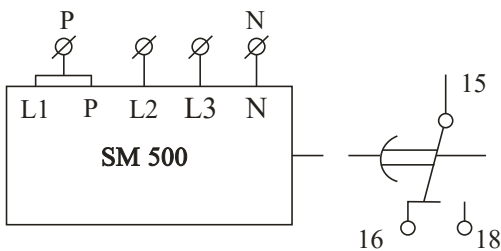

MD71BH, MD71BF, MD71B9

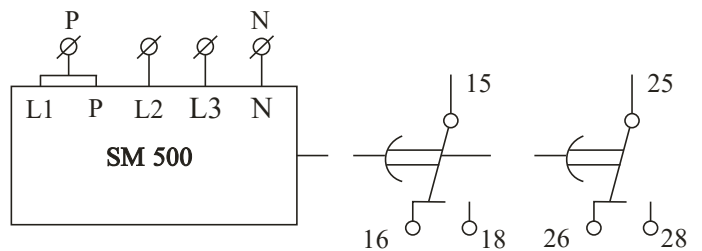

MG73BH, MG73BF, MG73B9

THREE PHASE

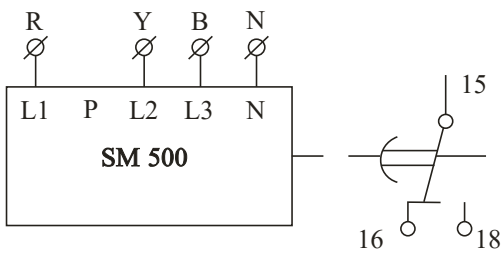

MD71BH, MD71BF, MD71B9

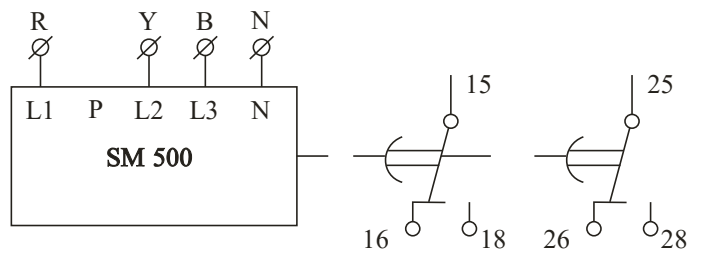

MG73BH, MG73BF, MG73B9, MAC04D0100 (P is not applicable in neutral loss)

MOUNTING DIMENSION (mm)

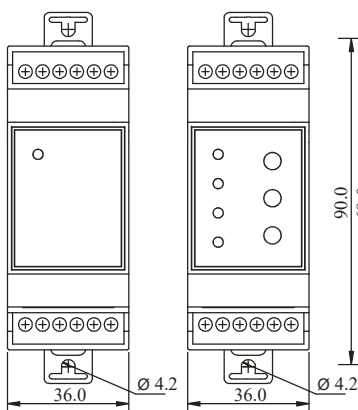

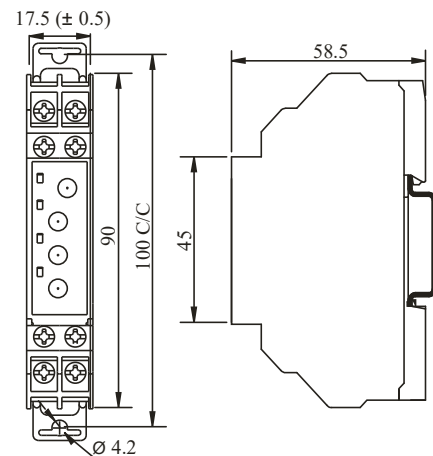

SM 301

SM 500, SM 501



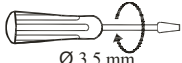

SM 175

TERMINAL TORQUE & CAPACITY

 Ø 3.5 mm	0.54 N.m (5 Lb.in) Terminal Screw - M2.6
	1 x 0.2...3.3 mm ² Solid Wire
AWG	1 x 24 to 12

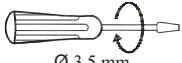
SM 301, SM 500, SM 501

 Ø 3.5 mm	Torque-0.4 N.m (3.6 Lb.in) Terminal Screw - M3
	1 x 2.5 mm ² Solid/Stranded Wire
AWG	1 x 24 to 12

SM 175

Product Selection Chart: Voltage Monitoring

Cat. No.	3P - 3W	3P - 4W	1 - Phase	Under Voltage	Over Voltage	Phase Loss	Phase Sequence	Phase Asymmetry	Settable ON Delay	Settable OFF Delay	1 C/O Relay Output	2 C/O Relay Output	1 C/O+ 1 C/O Relay Output	Neutral Loss	115 VAC	208 to 480 VAC	240 VAC	415 VAC	145 to 500 VAC	Auxiliary Supply
MAG03D0424 MAG03D0425 MAG03D0426	●	●	●	●	●	●	●	●	●	●	●					●				
DMS110	●	●		●	●	●	●	●	●	●	●			●		●			●	
DMS120	●	●		●	●	●	●	●	●	●			●	●		●			●	
DMA220	●	●		●	●	●	●	●	●	●			●	●		●				●
MN21D5	●					●					●					●				
MK21D5	●					●	●				●					●				
MC21D5	●					●	●	●			●					●				
MA21DN	●					●	●	●		●	●					●				
MD21DF	●			●	●	●	●			●	●					●				
MG21DH	●			●	●	●	●	●	●		●					●				
MG21DF	●			●	●	●	●	●		●	●					●				
MOF1D51	●					●		●			●					●				
MAE03D0200			●	●	●				●	●	●				●		●			
MA51BC	●					●	●	●			●								●	
MA51BK	●					●	●	●			●								●	
MC21B5	●					●	●	●				●							●	
MD71BH		●	●	●	●	●			●		●						●			
MD71BF		●	●	●	●	●				●	●						●			
MD71B9		●	●	●	●	●		●	●		●						●			
MG73BH		●	●	●	●	●	●	●	●			●					●			
MG73BF		●	●	●	●	●	●	●		●		●					●			
MG73BR		●	●	●	●	●	●	●		●		●					●			
MG73B9		●	●	●	●	●	●	●	●			●					●			
MAC04D0100		●		●	●	●	●	●				●		●					●	
MG53BH	●			●	●	●	●	●	●			●							●	
MG53BF	●			●	●	●	●	●		●		●							●	
MG53BT	●			●	●	●	●	●		●		●							●	
MG53BQ	●			●	●	●		●		●		●							●	
MG53BI	●			●	●	●	●	●				●							●	
MG53BO	●			●	●	●	●	●				●							●	
MB53BM	●			●	●	●	●	●	●	●		●							●	

Note: The product can be made available in 120 VAC, 220 VAC, 230 VAC and 400 VAC.

Three Phase Indicator

- Compact 17.5 mm Wide
- Available for Single, Two and Three Phase indications
- Choice of four colours
- LED technology for long life
- Integrated front product labeling



Ordering Information

Cat. No.	Description
MM1NDV	240V AC, Single Phase Indicator, Red
MM1NDW	240V AC, Single Phase Indicator, Yellow
MM1NDX	240V AC, Single Phase Indicator, Blue
MM1NDY	240V AC, Single Phase Indicator, Green
MMENDVW	240V AC, Two Phase Indicator, Red & Yellow
MM3ND	240V AC, Three Phase Indicator, Red, Yellow & Blue
MM3NDVH	240V AC, Three Phase Indicator, Red, Yellow & Green
MM3NDVD	240V AC, Three Phase Indicator, Red
MM3NDZ	240V AC, Three Phase Indicator, Green
MM3NDXD	240V AC, Three Phase Indicator, Blue

Three Phase Indicator



Cat. No.		MM1NDV	MMENDVW	MM3ND
Parameters				
Supply Voltage (Φ)		240 VAC		
Supply Variation		-25 to +10%(ofΦ)		
Frequency		50/60Hz		
Power Consumption (Max.)		1.8 W		
Number of Indications		1	2	3
LED Colour	Red	R Phase	R Phase	R Phase
	Yellow	N A	Y Phase	Y Phase
	Blue	N A	N A	B Phase
LED Type		Through Hole (Water Clear)		
LED Size		3mm		
Operating Temperature		- 15° C to +60° C		
Storage Temperature		- 25° C to +80° C		
Humidity (Non Condensing)		95% (Rh)		
Enclosure		Flame Retardant UL94-V0		
Dimension (W x H x D) (in mm)		17.5 X 90 X 65		
Weight (unpacked)		75 g		
Mounting		DIN rail		
Certification				
Degree of Protection		IP 20 for Terminals, IP 30 for Enclosure, IP 40 for Front side		

EMI / EMC

Harmonic Current Emissions	IEC 61000-3-2
ESD	IEC 61000-4-2
Radiated Susceptibility	IEC 61000-4-3
Electrical Fast Transients	IEC 61000-4-4
Surges	IEC 61000-4-5
Conducted Susceptibility	IEC 61000-4-6
Voltage Dips & Interruptions (AC)	IEC 61000-4-11
Conducted Emission	CISPR 14-1
Radiated Emission	CISPR 14-1

Environmental

Cold Heat	IEC 60068-2-1
Dry Heat	IEC 60068-2-2
Vibration	IEC 60068-2-6
Repetitive Shock	IEC 60068-2-27
Non-Repetitive Shock	IEC 60068-2-27

MOUNTING DIMENSIONS (mm)

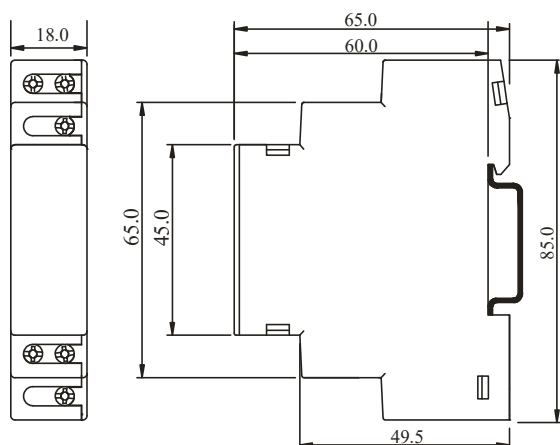

TERMINAL TORQUE & CAPACITY

 Ø 3.5 mm....4.0mm	0.60 N.m (6 Lb.in)
 AWG	1 x 4.0 mm ² Solid/Stranded Wire 1 x 20 to 10

Frequency Monitoring Series PD 225

- Wide Auxiliary Supply voltage Range:
110 - 240 VAC, 220 - 440 VAC
- Models for Over Frequency and Under/Over Frequency Monitoring
- Monitors Frequency of Three signals - Sine, Square & Triangular
- Model for Frequency Limit Control: 5 Hz to 135 Hz
- Wide Signal Input Voltage: 15 to 500 VAC
- Adjustable Relay status in Healthy or Unhealthy condition using DIP switch "ET" (Energize to Trip) or "DT" (De-energize to trip.)
- Ease of Frequency setting with simple Addition & Subtraction
- LED Indications for Healthy, Unhealthy & No signal conditions





Ordering Information

Cat. No.	Description
MI81BJ	110 - 240 VAC, Over Frequency Relay, 1 C/O
MI91BJ	220 - 440 VAC, Over Frequency Relay, 1 C/O
MI81BL	110 - 240 VAC, Over Frequency & Under Frequency Relay, 1 C/O
MI91BL	220 - 440 VAC, Over Frequency & Under Frequency Relay, 1 C/O

UL Approval for Cat Nos. MI81BL & MI91BL only.



Frequency Monitoring Series PD 225

Cat. No.		MI81BJ	MI91BL
Parameters			
Supply Voltage (Φ)		110 - 240 VAC	220 - 440 VAC
Supply Variation		-15% to +15% (of Φ)	
Frequency		50/60 Hz	
Power Consumption (Max.)		3 VA	
Signal Type		Sinusoidal, Square, Triangular	
Signal Input Voltage Range		(15 to 500) V	
Overall Frequency Range		(5 to 135) Hz	(40 to 70) Hz
Trip Settings	Over Frequency	0.33 to 1 of Full Scale	(+1 to +10) Hz above Selected Value
	Under Frequency	N A	(-1 to -10) Hz below Selected Value
	Reset Hysteresis	1.5 % of Full Scale selected	
Setting Accuracy		± 5%	
Repeat Accuracy		± 0.02%	
Time Delay	ON Delay	500 ms	
	OFF Delay	100 ms	500 ms to 5 s
	Reset Time	150 ms	
Output	Relay Output	1 C/O	
	Contact Rating	6A (Resistive) @ 250 VAC / 28 VDC	
	Electrical Life	1 x 10 ⁵	
	Mechanical Life	3 x 10 ⁶	
Utilization Category	AC - 15	Rated Voltage (U _e): 120/240 V, Rated Current (I _e): 3.0/1.5 A	
	DC - 13	Rated Voltage (U _e): 24/125/250 V, Rated Current (I _e): 2.0/0.22/0.1 A	
LED Indications	Relay	Red LED Flashing if No Signal	N A
	UF / OF	N A	Separate for UF & OF
Operating Temperature		- 15° C to +60° C	
Storage Temperature		- 40° C to +80° C	
Enclosure		Flame Retardant UL94-V0	
Dimension (W x H x D) (in mm)		22.5 X 83 X 100.5	
Weight (unpacked)		120 g	
Mounting		Base / DIN rail	
Certification		  	
Degree of Protection		IP 20 for Terminals, IP 40 for Enclosure	

EMI / EMC

Harmonic Current Emissions	IEC 61000-3-2
ESD	IEC 61000-4-2
Radiated Susceptibility	IEC 61000-4-3
Electrical Fast Transients	IEC 61000-4-4
Surges	IEC 61000-4-5
Conducted Susceptibility	IEC 61000-4-6
Voltage Dips & Interruptions (AC)	IEC 61000-4-11
Conducted Emission	CISPR 14-1
Radiated Emission	CISPR 14-1

Environmental

Cold Heat	IEC 60068-2-1
Dry Heat	IEC 60068-2-2
Vibration	IEC 60068-2-6
Repetitive Shock	IEC 60068-2-27
Non-Repetitive Shock	IEC 60068-2-27

Earth Leakage Relay

- Flush Mounting Version 96x96 mm with Digital Seven Segment Display
- Monitors, Detects and Protects Power systems from Earth Leakage Fault (Type 'A' & 'AC')
- Wide range of selectable Earth Leakage Current: 30 mA - 30 A
- Configurable Earth Leakage Trip time: 0 - 10 s
- Wide Auxiliary Supply Range: 110 - 240 VAC / DC
- Nano Crystalline CBCT measures the leakage current to the highest accuracy
- Instantaneous Trip for 5 times of set value of Leakage current
- Test feature to check complete product functionality
- LED Indication for Relay Status, Earth Leakage Fault & Alarm Condition
- Manual / Remote Reset feature
- Continuous Scrolling display for Set Current and Set time
- 1 C/O (Alarm Relay) + 1 C/O (Fault Relay)
- RS 485 Communication





Ordering Information

Cat. No.	Description
17K716QF4N	110-240V AC / DC, Current Range 30 mA - 30 A, 2 C/O
17K716QF4M	110-240V AC / DC, Current Range 30 mA - 30 A, 2 C/O with RS 485
17K726QF4N	220-415V AC / 220 V DC, Current Range 30 mA - 30 A, 2 C/O
17K726QF4M	220-415V AC / 220 V DC, Current Range 30 mA - 30 A, 2 C/O with RS 485
17H7NNHN3	CBCT 38 mm, Type A & AC Current
17H7NNIN3	CBCT 57 mm, Type A & AC Current
17H7NNQN3	CBCT 70 mm, Type A & AC Current
17H7NNJN3	CBCT 92 mm, Type A & AC Current
17H7NNLN3	CBCT 120 mm, Type A & AC Current
17H7NNKN3	CBCT 210 mm, Type A & AC Current
17H7NNRN3	CBCT 38 mm, Type AC Current
17H7NNVN3	CBCT 57 mm, Type AC Current
17H7NNSN3	CBCT 70 mm, Type AC Current
17H7NNTN3	CBCT 92 mm, Type AC Current
17H7NNUN3	CBCT 120 mm, Type AC Current

Earth Leakage Relay



Cat. No.	17K716QF4N	17K716QF4M	17K726QF4N	17K726QF4M
Parameters				
Supply Voltage (±)	110 - 240 V AC / DC		240-415 VAC/DC	
Supply Variation	-20 to +10%			
Frequency	50/60Hz			
Power Consumption (Max.)	6 VA			
Leakage Current Range (I Δ n)	30 mA to 30 A			
Threshold I Δ n (A)	I Δ n x 1	0.03 - 0.05 - 0.075 - 0.1 - 0.15 - 0.2-0.3 (A)		
	I Δ n x 10	0.03 - 0.5 - 0.75 - 1.0 - 1.5 - 2.0 - 3.0 (A)		
	I Δ n x 100	0.03 - 5 - 7.5 - 10.0 - 15.0 - 20.0 - 30.0 (A)		
Type Class	'A' True RMS measurement up to I Δ 1A & I Δ 3A (As per IEC 60947-2 Annex M)			
	'AC' True RMS measurement 30mA to 30A (As per IEC 60947-2 Annex M)			
Max. Crest Factor	4 (for 30 mA to 30 A)			
Reset Mode	Manual / Auto Reset			
No. of Resets	4 (Auto Mode)			
Clear Auto Reset	After 1 hour of healthy condition or supply interruption			
Reset Enable	Below 50% of set current threshold in presence of CBCT			
Trip Time (Δ t in sec)	0 - 0.06 - 0.15 - 0.25 - 0.5 - 0.8 - 1 - 2.5 - 5 - 10			
Test / Reset	Local & Remote (Non Potential free contacts, upto 10 m)			
Setting Accuracy	-20% (Including CBCT Accuracy)			
Repeat Accuracy	± 2%			
Output	Relay Output	1 C/O (Alarm Relay) + 1 C/O (Fault relay)		
	Contact Rating	5A (Resistive) @ 240 VAC / 30 VDC		
	Electrical Life	5 x 10 ⁴		
	Mechanical Life	5 x 10 ⁶		
Display	Trip Current Hold	Enable / Disable		
	Scrolling Display	Enable / Disable		
LED Indication	Power On	ON (Green LED)		
	Alarm	ON (Yellow LED) @ Alarm Relay Trip, (60% of set I Δ n)		
	Fault	ON (RED LED) @ 85% of set I Δ n (A) & Blink @ CT open		
RS 485 Communication	NA	Available	NA	Available
Operating Temperature	- 20° C to +55° C			
Storage Temperature	- 20° C to +70° C			
Humidity (Non Condensing)	95% (Rh)			
Enclosure	Flame Retardant UL94-V0			
Dimension (W x H x D) (in mm)	96 X 96 X 83.7			
Weight (unpacked) Approx.	275 g			
Mounting	Panel / Flush Mountable			
Certification	 			
Degree of Protection	IP 20 for Terminals, IP 40 for Enclosure			

EMI / EMC

Harmonic Current Emissions	IEC 61000-3-2
ESD	IEC 61000-4-2
Radiated Susceptibility	IEC 61000-4-3
Electrical Fast Transients	IEC 61000-4-4
Surges	IEC 61000-4-5
Conducted Susceptibility	IEC 61000-4-6
Voltage Dips & Interruptions (AC)	IEC 61000-4-11
Conducted Emission	CISPR 11
Radiated Emission	CISPR 11

Environmental

Cold Heat	IEC 60068-2-1
Dry Heat	IEC 60068-2-2
Vibration	IEC 60068-2-6

Earth Leakage Relay



CONNECTION DIAGRAM

NON-FAIL SAFE MODE
(SHUNT TRIP COIL/UV TRIP COIL)

THREE PHASE APPLICATION

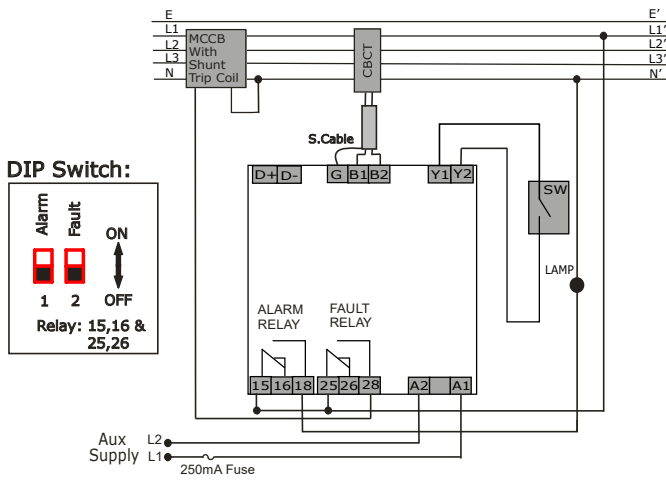

FAIL SAFE MODE (CONTRACTOR)

THREE PHASE APPLICATION

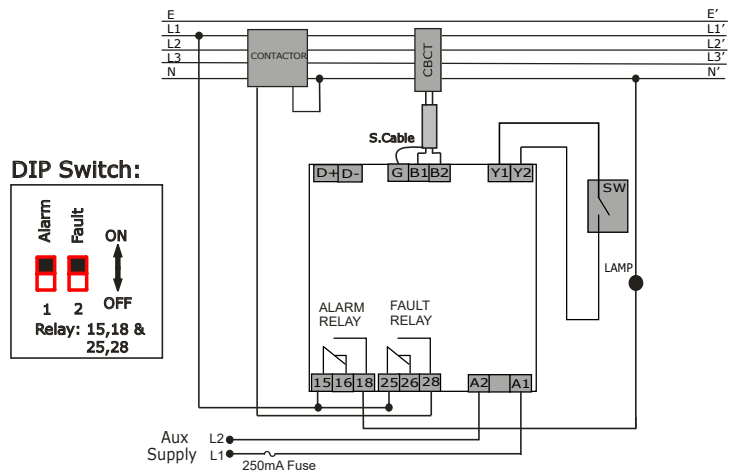

NON-FAIL SAFE MODE
(SHUNT TRIP COIL/UV TRIP COIL)

SINGLE PHASE APPLICATION

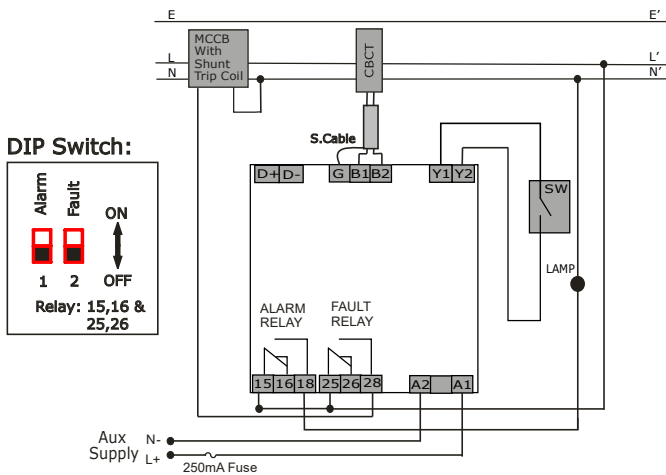

FAIL SAFE MODE (CONTRACTOR)

SINGLE PHASE APPLICATION

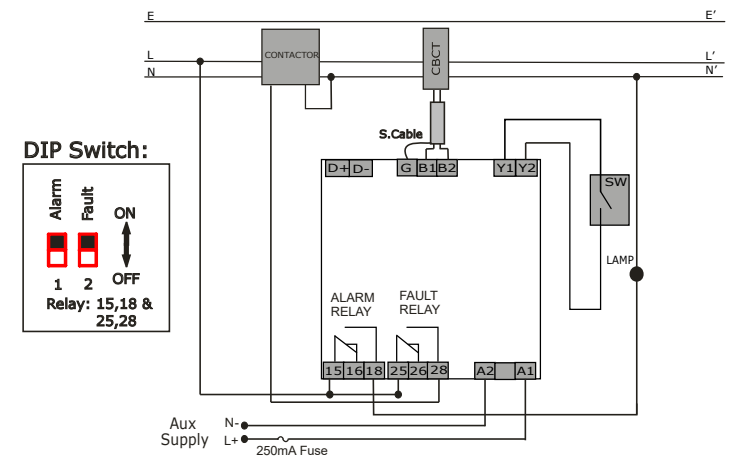

Earth Leakage Relay



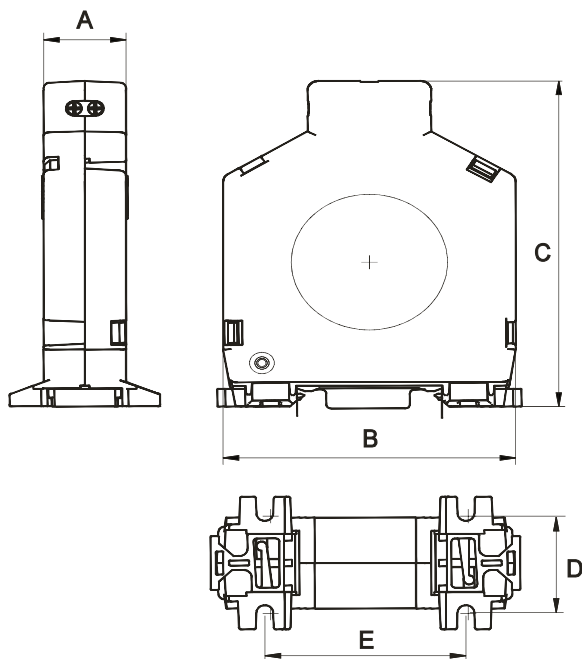
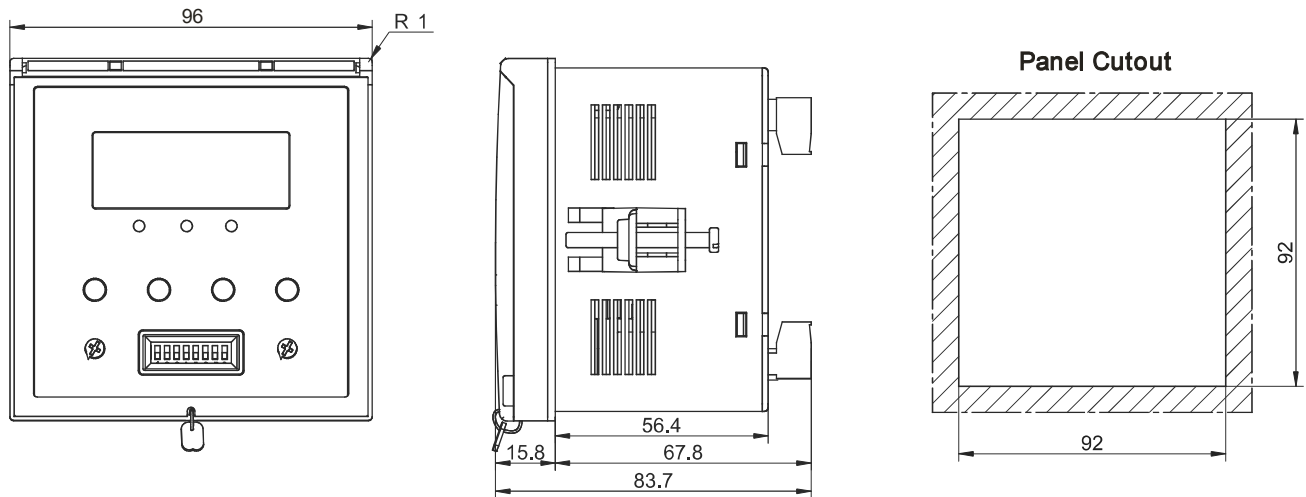

MOUNTING DIMENSIONS (mm)



CBCT	SIZE	WEIGHT (in gms)	A	B	C	D	E
17H7NNHN3	38	110	20	71	91	27	48
17H7NNRN3							
17H7NNIN3	57	185	20	97	117	27	55
17H7NNQN3	70	240	20	109	133	27	60
17H7NNSN3							
17H7NNJN3	92	250	20	132	155	27	73
17H7NNTN3							
17H7NNLN3	120	255	20	153	176	27	73
17H7NNUN3							
17H7NNKN3	210	280	20.5	250	282	28	128

Dimensions in mm

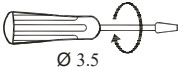
TERMINAL TORQUE & CAPACITY

	0.5 N.m (4.4 Lb.in)
	1 x 2.5 mm ² Solid Wire/Stranded
AWG	1 x 28 to 12

Earth Leakage Relay

- Monitors, Detects and Protects Power systems from Earth Leakage Faults
- Wide range of selectable Earth Leakage Current: 30 mA - 30 A
- Configurable Earth Leakage Trip time: 0 - 10 s
- Wide Auxiliary Supply Range: 110 - 240 V AC / DC, 220 - 415 V AC / 220 V DC
- Instantaneous Trip for 5 times of set value of Leakage current
- Test feature to check complete product functionality
- LED Indication for Relay status, CT open, Earth Leakage fault & Test/Reset switch feature
- Manual / Remote Reset feature
- 1 C/O + 1 NO Relay Output





Ordering Information

Cat. No.	Description
17G715GF2	110-240V AC / DC, Current Range 30 mA - 30 A, 1 C/O + 1 NO, Manual Reset
17G715KF2	110-240V AC / DC, Current Range 30 mA - 30 A, 1 C/O + 1 NO, Auto Reset
17G745GF2	220-415V AC / 220 V DC, Current Range 30 mA - 30 A, 1 C/O + 1 NO, Manual Reset
17G745KF2	220-415V AC / 220 V DC, Current Range 30 mA - 30 A, 1 C/O + 1 NO, Auto Reset
17G755GF2	15V DC, Current Range 30 mA - 30 A, 1 C/O + 1 NO, Manual Reset
17G755KF2	15V DC, Current Range 30 mA - 30 A, 1 C/O + 1 NO, Auto Reset
17G815GF2	110-240V AC / DC, Current Range 30 mA - 10 A, 1 C/O + 1 NO, Manual Reset
17G815KF2	110-240V AC / DC, Current Range 30 mA - 10 A, 1 C/O + 1 NO, Auto Reset
17G845GF2	220-415V AC / 220 V DC, Current Range 30 mA - 10 A, 1 C/O + 1 NO, Manual Reset
17G845KF2	220-415V AC / 220 V DC, Current Range 30 mA - 10 A, 1 C/O + 1 NO, Auto Reset

Note: For CBCT ordering information please refer to page no 170.

Earth Leakage Relay



Cat. No.	17G715GF2	17G715KF2	17G745GF2	17G745KF2
Parameters				
Supply Voltage (φ)	110 - 240 V AC / DC		220 - 415 V AC / 220 V DC	
Supply Variation	-20 to +10%			
Frequency	50/60Hz			
Power Consumption (Max.)	5 VA		10 VA	
Leakage Current Range (IΔn)	30 mA to 30 A			
Threshold IΔn (A)	For '17G7' Devices	0.03 - 0.1 - 0.3 - 0.5 - 1 - 3 - 5 - 10 - 20 - 30		
	For '17G8' Devices	0.03 - 0.05 - 0.1 - 0.3 - 0.5 - 0.75 - 1 - 3 - 5 - 10		
Type Class	'A' True RMS measurement (As per IEC 60947-2 appendix M) up to IΔN= 3A			
Max. Crest Factor	5 (for 30 mA to 30 A)			
Reset Mode	Manual Reset	Auto Reset	Manual Reset	Auto Reset
No. of Resets	N A	4	N A	4
Clear Auto Reset	After 1 hour of healthy condition or supply interruption			
Reset Enable & Reset Time	Below 50% of set current threshold in presence of CBCT			
Trip Time (Δt in sec)	0 - 0.06 - 0.15 - 0.25 - 0.5 - 0.8 - 1 - 2.5 - 5 - 10			
Test / Reset	Local & Remote (Non Potential free contacts, upto 10 m)			
Setting Accuracy	-20% (Including CBCT Accuracy)			
Repeat Accuracy	± 2%			
Output	Relay Output	1 C/O + 1 NO		
	Contact Rating	5A (Resistive) @ 240 VAC / 30 VDC		
	Electrical Life	1 x 10 ⁵		
	Mechanical Life	1 x 10 ⁷		
Utilization Category	AC - 15	Rated Voltage (Ue): 120/240 V, Rated Current (Ie): 3.0/1.5 A		
	DC - 13	Rated Voltage (Ue): 24/125/250 V, Rated Current (Ie): 2.0/0.22/0.1 A		
LED Indication	Power	Green LED (ON)		
	EL / CT	Red LED (ON) → Relay Trip / Red LED (Blinking) → CT Open		
	Leakage Current / TST	By Bar Graph: 30% (Green), 45% (Green), 60% (Yellow), 75% (Red), Blink Test / Reset Switch is pressed		
Operating Temperature	- 15° C to +60° C			
Storage Temperature	- 25° C to +80° C			
Humidity (Non Condensing)	95% (Rh)			
Enclosure	Flame Retardant UL94-V0			
Dimension (W x H x D) (in mm)	36 X 90 X 65			
Weight (unpacked) Approx.	150 g			
Mounting	Base / DIN rail			
Certification	 			
Degree of Protection	IP 20 for Terminals, IP 40 for Enclosure			

EMI / EMC

Harmonic Current Emissions	IEC 61000-3-2
ESD	IEC 61000-4-2
Radiated Susceptibility	IEC 61000-4-3
Electrical Fast Transients	IEC 61000-4-4
Surges	IEC 61000-4-5
Conducted Susceptibility	IEC 61000-4-6
Voltage Dips & Interruptions (AC)	IEC 61000-4-11
Conducted Emission	CISPR 11
Radiated Emission	CISPR 11

Environmental

Cold Heat	IEC 60068-2-1
Dry Heat	IEC 60068-2-2
Vibration	IEC 60068-2-6
Repetitive Shock	IEC 60068-2-27
Non-Repetitive Shock	IEC 60068-2-27

Earth Leakage Relay



CONNECTION DIAGRAM

FAIL SAFE MODE (CONTACTOR)

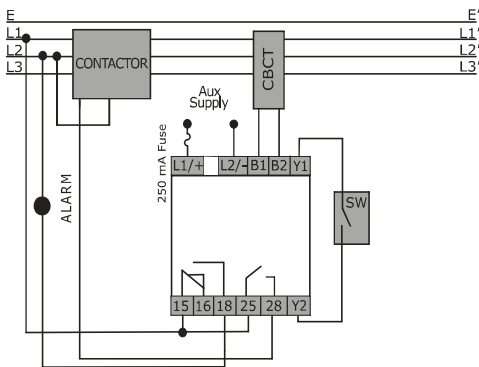

NON-FAIL SAFE MODE (SHUNT TRIP COIL)

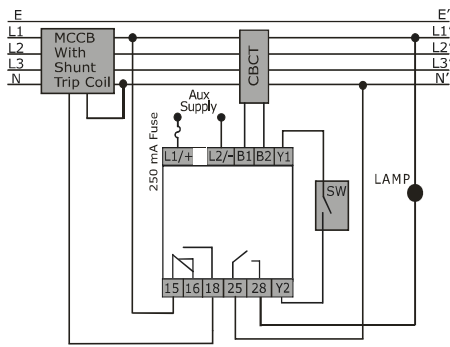

FAIL SAFE MODE (CONTACTOR)

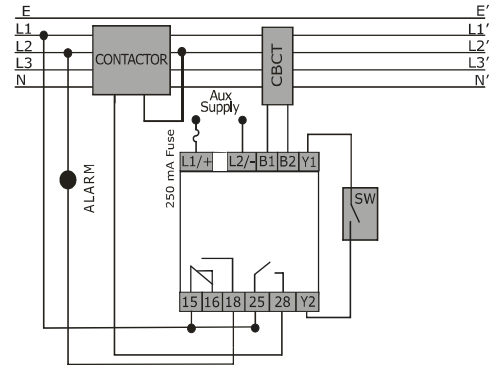

NON-FAIL SAFE MODE (UV TRIP COIL)

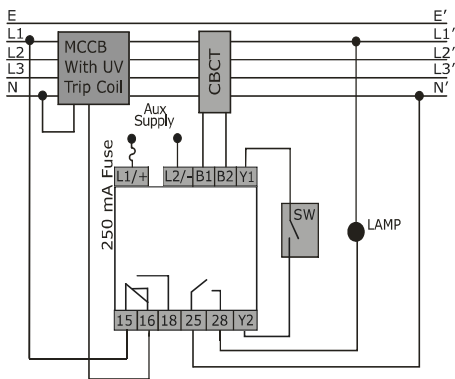

NON-FAIL SAFE MODE (CONTACTOR)

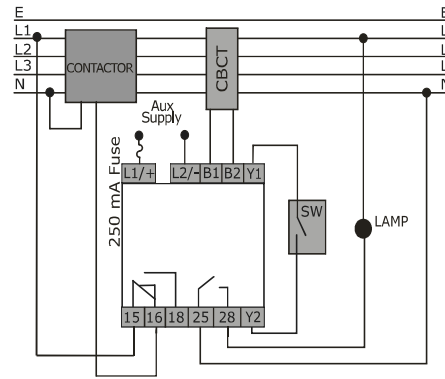

FAIL SAFE MODE (UV TRIP COIL)

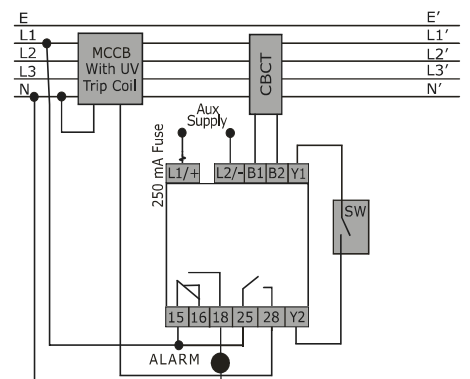

Earth Leakage Relay



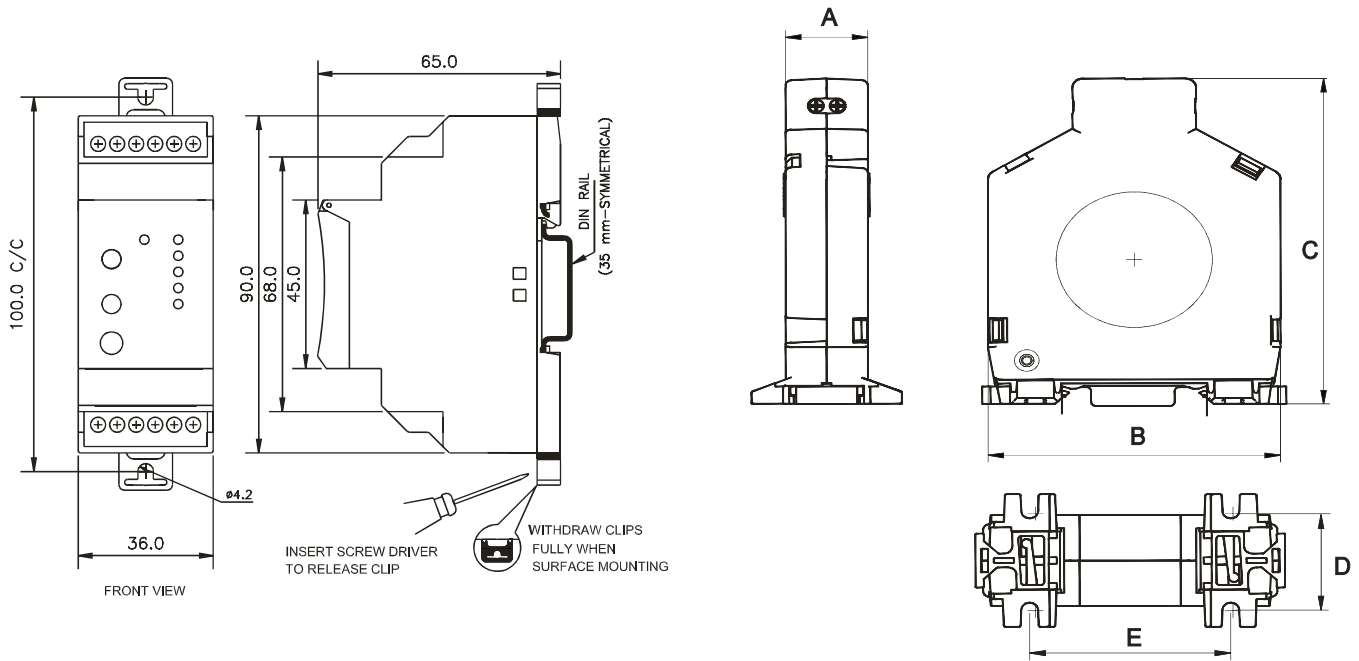

MOUNTING DIMENSIONS



CBCT	SIZE	WEIGHT (in gms)	A	B	C	D	E
17H7NNHN3	38	110	20	71	91	27	48
17H7NNRN3							
17H7NNIN3	57	185	20	97	117	27	55
17H7NNQN3	70	240	20	109	133	27	60
17H7NNSN3							
17H7NNJN3	92	250	20	132	155	27	73
17H7NNTN3							
17H7NNLN3	120	255	20	153	176	27	73
17H7NNUN3							
17H7NNKN3	210	280	20.5	250	282	28	128

Dimensions in mm

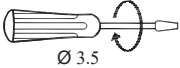
TERMINAL TORQUE & CAPACITY

 Ø 3.5	0.54 N.m (5 Lb.in)
	1 x 2.5 mm ² Solid Wire/Stranded
AWG	1 x 24 to 12

Current Monitoring Series CMR - Current Control

- Protects against Overload, Phase Reverse, Phase Loss and Phase Unbalance faults
- Wide Range of Sensing Current : 1A-45A
- Models for 1 Phase and 3 Phase systems
- Auto/Manual Reset selection
- Fail-Safe Protection
- Inverse Time model with Underload, Locked Rotor Protection and Selectable Trip Class
- Definite Time model with Underload and selectable Start and Trip time





Ordering Information

Cat. No.	Trip Type	Current	Auto Reset Time
17C112EB0	Inverse	3 A - 9 A	As per trip class
17C212EB0	Inverse	8 A - 24 A	As per trip class
17C312EB0	Inverse	15 A - 45 A	As per trip class
17C412EB0	Inverse	2 A - 5 A	As per trip class
17B822MM0	Definite	0.5 - 3 A	As per trip class
17B922MM0	Definite	0.2 - 1.4 A	As per trip class
17D112DA0	Definite	3 A - 9 A	6 min
17D212DA0	Definite	8 A - 24 A	6 min
17D312DA0	Definite	15 A - 45 A	6 min
17D412DA0	Definite	2 A - 5 A	6 min

Current Monitoring Series CMR - Current Control



Cat. No.		17C112EB0	17C212EB0	17D312DA0
Parameters				
Supply Voltage (ϕ)		110 - 240 VAC		
Supply Variation		-20% to +10% of (ϕ)		
Frequency		50 / 60 Hz		
Power Consumption (Max.)		5 VA		
Trip Settings	Trip Type	Inverse Time	Inverse Time	Definite Time
	Tripping Class	10, 10, 20, 30	10, 10, 20, 30	N A
	Current Ranges	3 - 9 A	8 - 24 A	15 - 45 A
	Thermal Memory	Yes	Yes	N A
	Underload	40% to 90%	40% to 90%	50%
	Trip Time	< 4sec after starting	< 4sec after starting	N A
Number of In-Built CT's		1		
Reset Mode		Auto, Manual		
Test Function		Yes		
Time Delay	Start Time	N A	N A	0.2 to 30s
	Delay Time	As per trip class	As per trip class	0.2 to 10s
	Auto Reset Time	3-15 min (As per trip class)	3-15 min (As per trip class)	6 min
	ON Delay	450 ms (±50ms)		
Setting Accuracy		± 5%		
Repeat Accuracy		± 2%		
Output	Relay Output	1 C/O		
	Contact Rating	5A @ 240 VAC (Resistive)		
	Electrical Life	1 x 10 ⁵		
	Mechanical Life	1 x 10 ⁷		
Utilization Category	AC - 15	Rated Voltage (Ue): 120/240 V, Rated Current (Ie): 3.0/1.5 A		
LED Indications		ON: Power ON, UL: Underload, OL: Overload		
Operating Temperature		- 10° C to +60° C		
Storage Temperature		- 25° C to +70° C		
Humidity (Non Condensing)		95% (Rh)		
Enclosure		Flame Retardant UL94-V0		
Dimension (W x H x D) (in mm)		110.8 X 36.5 X 76.8		
Weight (unpacked) Approx.		200 g		
Mounting		Base Mounting		
Certification		 		
Degree of Protection		IP 20 for Enclosure		

EMI / EMC

Harmonic Current Emissions	IEC 61000-3-2
ESD	IEC 61000-4-2
Radiated Susceptibility	IEC 61000-4-3
Electrical Fast Transients	IEC 61000-4-4
Surges	IEC 61000-4-5
Conducted Susceptibility	IEC 61000-4-6
Voltage Dips & Interruptions (AC)	IEC 61000-4-11
Power Frequency Magnetic Field	IEC 61000-4-8
Voltage Flickers & Fluctuation	IEC 61000-3-3
Conducted Emission	CISPR 14-1
Radiated Emission	CISPR 14-1

Environmental

Cold Heat	IEC 60068-2-1
Dry Heat	IEC 60068-2-2
Vibration	IEC 60068-2-6

Current Monitoring Series CMR - Current Control





Ordering Information

Cat. No.	Trip Type	Current	Auto Reset Time
17A122CB0	Inverse	3 A - 9 A	As per trip class
17A222CB0	Inverse	8 A - 24 A	As per trip class
17A322CB0	Inverse	15 A - 45 A	As per trip class
17A422CB0	Inverse	2 A - 5 A	As per trip class
17B122AA0	Definite	3 A - 9 A	6 min
17B222AA0	Definite	8 A - 24 A	6 min
17B322AA0	Definite	15 A - 45 A	6 min
17B422AA0	Definite	2 A - 5 A	6 min
17B122PA0	Definite	3 A - 9 A	Instant (< 500 msec)
17B222PA0	Definite	8 A - 24 A	Instant (< 500 msec)
17B322PA0	Definite	15 A - 45 A	Instant (< 500 msec)
17B422PA0	Definite	2 A - 5 A	Instant (< 500 msec)

Current Monitoring Series CMR - Current Control



Cat. No.		17A122CB0	17B222AA0	17A322CB0
Parameters				
Supply Voltage (φ)		220 - 415 VAC (3 Phase, 3 Wire)		
Supply Variation		-20% to +15% of (φ)		
Frequency		50/60 Hz		
Power Consumption (Max.)		12 VA		
Trip Settings	Trip Type	Inverse Time	Definite Time	Inverse Time
	Tripping Class	10A, 10, 20, 30	N A	10A, 10, 20, 30
	Current Ranges	3 - 9 A	8 - 24 A	15 - 45 A
	Thermal Memory	Yes	N A	Yes
	Phase Reverse Protection	Yes / (100 ms Approx.)		
	Phase Loss	> 70% of Unbalance		
	Current unbalance Protection	>50% of Unbalance		
	Underload	40% to 90%	50%	40% to 90%
Trip Time		< 4sec after starting	N A	< 4sec after starting
Number of In-Built CT's		2		
Reset Mode		Auto, Manual		
Test Function		Yes		
Time Delay	Start Time	N A	0.2 to 30s	N A
	Delay Time	As per trip class		As per trip class
	Auto Reset Time	3-15 min (As per trip class)	6 min	3-15 min (As per trip class)
	ON Delay	450 ms (±50ms)		
Setting Accuracy		± 5%		
Repeat Accuracy		± 2%		
Output	Relay Output	1 C/O		
	Contact Rating	5A @ 240 VAC (Resistive)		
	Electrical Life	1 x 10 ⁵		
	Mechanical Life	1 x 10 ⁷		
Utilization Category	AC - 15	Rated Voltage (Ue): 120/240 V, Rated Current (Ie): 3.0/1.5 A		
LED Indications		Separate indications for Phase Asymmetry, Phase Loss & Phase Sequence / Reverse, Power ON, Underload & Overload		
Operating Temperature		- 10° C to +60° C		
Storage Temperature		- 25° C to +70° C		
Humidity (Non Condensing)		95% (Rh)		
Enclosure		Flame Retardant UL94-V0		
Dimension (W x H x D) (in mm)		110.8 X 36.5 X 76.8		
Weight (unpacked) Approx.		210 g		
Mounting		Base Mounting		
Certification		 		
Degree of Protection		IP 20 for Enclosure		



EMI / EMC

Harmonic Current Emissions	IEC 61000-3-2
ESD	IEC 61000-4-2
Radiated Susceptibility	IEC 61000-4-3
Electrical Fast Transients	IEC 61000-4-4
Surges	IEC 61000-4-5
Conducted Susceptibility	IEC 61000-4-6
Voltage Dips & Interruptions (AC)	IEC 61000-4-11
Power Frequency Magnetic Field	IEC 61000-4-8
Voltage Flickers & Fluctuation	IEC 61000-3-3
Conducted Emission	CISPR 14-1
Radiated Emission	CISPR 14-1

Environmental

Cold Heat	IEC 60068-2-1
Dry Heat	IEC 60068-2-2
Vibration	IEC 60068-2-6

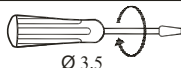
TERMINAL TORQUE & CAPACITY

 ∅ 3.5	0.45 N.m (4 Lb.in)
 AWG	1 x 4 mmsq Rigid wire (without wire protection) 1 x 2.5 mmsq (with wire protection)
	1 x 22 to 12

Note: 2 A - 5A products can be used with external CT. Load wires to be passed through the external CT and Secondary's wire terminals are to be looped through the Product CT.

Current Monitoring Series CMR - Current Control

MOUNTING DIMENSION (mm)

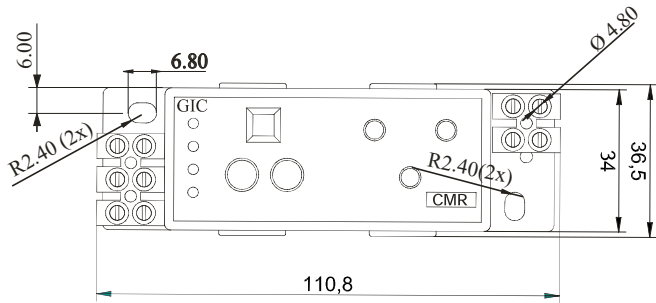

RELAY CONNECTION DIAGRAM

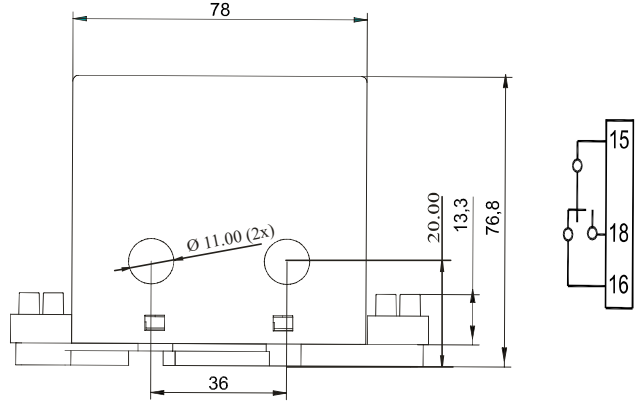

CONNECTION DIAGRAM

SINGLE PHASE

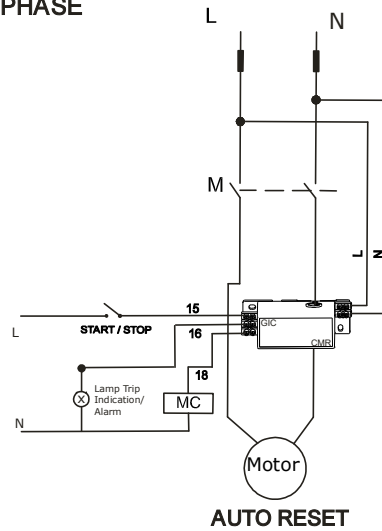
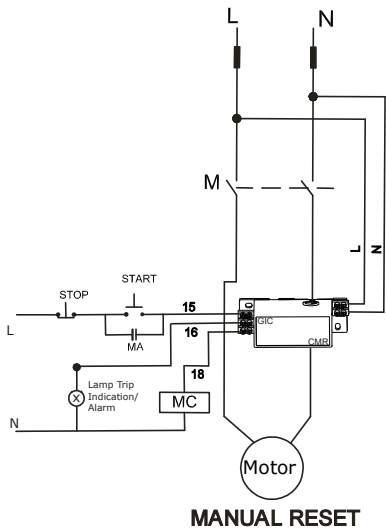

THREE PHASE

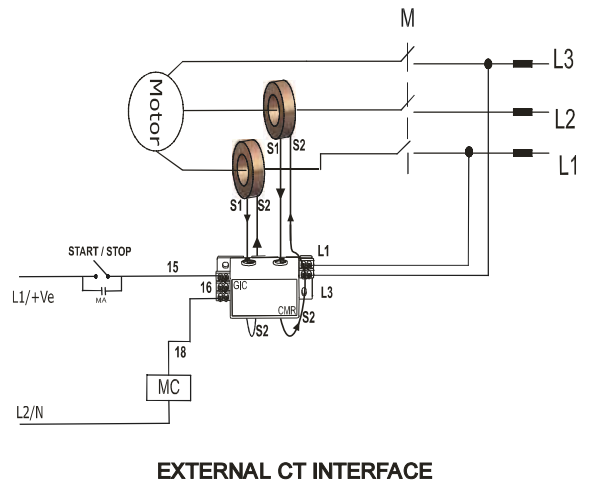
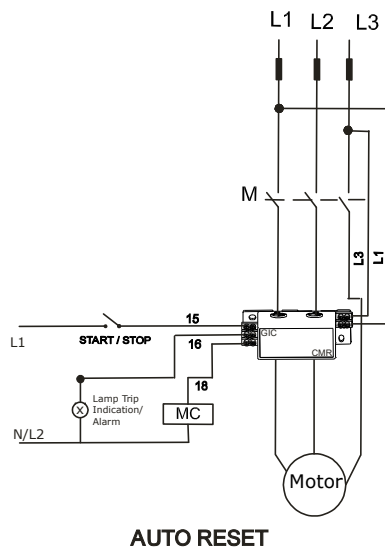
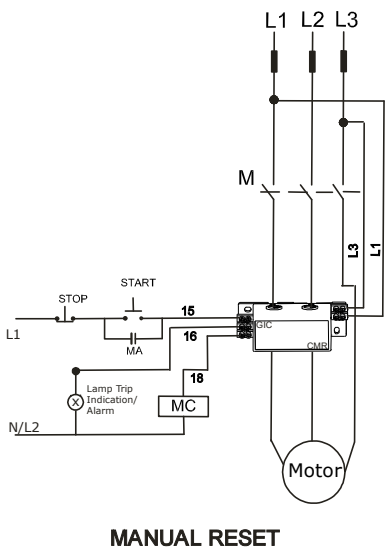

PTC Thermistor Relay Series PD 225

- Monitors and Protects Motors with Integrated PTC Resistor sensors
- Protection against Over heating for Heavy Duty Load, High Switching Frequency, High operating temperature & Insufficient cooling conditions
- Wide Auxiliary Supply Voltage: 24 VAC/DC, 110 - 240 VAC & 220 - 415 VAC
- LED Indications for Healthy, Unhealthy, Sensor Open/Short conditions
- 1 C/O & 2 C/O Configuration
- Reset Options: Auto, Manual and Remote





Ordering Information

Cat. No.	Description
MJ83BK	110 - 240 VAC, PTC Thermistor Relay, 2 C/O
MJ93BK	220 - 440 VAC, PTC Thermistor Relay, 2 C/O
MJA3BK	24 VAC/DC, PTC Thermistor Relay, 2 C/O
MJ81BK	110 - 240 VAC, PTC Thermistor Relay, 1 C/O
MJ91BK	220 - 440 VAC, PTC Thermistor Relay, 1 C/O



PTC Thermistor Relay Series PD 225

Cat. No.		MJ83BK	MJ93BK	MJA3BK
Parameters				
Supply Voltage (ϕ)		110 - 240 VAC	220 - 440 VAC	24 VAC/DC
Supply Variation		-20% to + 10% (of ϕ)		
Frequency		50/60 Hz		
Power Consumption (Max.)		4 VA	8 VA	2 VA
Trip Settings	Trip Level	2.7 k Ω , (\pm 5%)		
	Reset Level	1.71 k Ω , (\pm 5%)		
	Sensor Short	<20 Ω , (\pm 4 Ω)		
	Hysteresis	40 Ω , (\pm 4 Ω)		
	Sensor Open	> 20 k Ω , (\pm 5%)		
Max Cold Res(Ω) of Sensor Chain		< 1.5 k Ω		
Reset Mode		Auto, Manual, Remote		
Repeat Accuracy		1%		
Time Delay	ON Delay	< 350 ms		
	OFF Delay	100 ms		
	Reset Time	150 ms		
Output	Coil Output	2 C/O		
	Contact Rating	5A (Resistive) @ 250 VAC / 28 VDC		
	Electrical Life	1 x 10 ⁵		
	Mechanical Life	3 x 10 ⁶		
Utilization Category	AC - 15	Rated Voltage (Ue): 120/240 V, Rated Current (Ie): 3.0/1.5 A		
	DC - 13	Rated Voltage (Ue): 24/125/250 V, Rated Current (Ie): 2.0/0.22/0.1 A		
LED Indications	Green LED	Continuous ON \rightarrow Healthy Flashing \rightarrow Sensor Open		
	Red LED	Continuous ON \rightarrow Relay ON Flashing \rightarrow Sensor Short		
	All LEDs OFF	Power Supply Fail		
Operating Temperature		- 15° C to +60° C		
Storage Temperature		- 25° C to +80° C		
Humidity (Non Condensing)		95% (Rh)		
Enclosure		Flame Retardant UL94-V0		
Dimension (W x H x D) (in mm)		22.5 X 83 X 100.5		
Weight (unpacked)		120 g		
Mounting		Base / DIN rail		
Certification		 		
Degree of Protection		IP 20 for Terminals, IP 40 for Enclosure		

EMI / EMC

Harmonic Current Emissions	IEC 61000-3-2
ESD	IEC 61000-4-2
Radiated Susceptibility	IEC 61000-4-3
Electrical Fast Transients	IEC 61000-4-4
Surges	IEC 61000-4-5
Conducted Susceptibility	IEC 61000-4-6
Voltage Dips & Interruptions (DC)	IEC 61000-4-29
Power Frequency Magnetic Field	IEC 61000-4-8
Voltage Flickers & Fluctuation	IEC 61000-3-3
Conducted Emission	CISPR 11
Radiated Emission	CISPR 11

Environmental

Cold Heat	IEC 60068-2-1
Dry Heat	IEC 60068-2-2
Vibration	IEC 60068-2-6
Repetitive Shock	IEC 60068-2-27
Non-Repetitive Shock	IEC 60068-2-27

PTC Thermistor & Single Phasing Preventer Series PD225

- Thermistor Relay combined with Protection against Phase Sequence, Phase Loss & Phase Asymmetry Faults
- Monitor and Protects Motors with Integrated PTC Resistor sensors
- Protection against Over heating for Heavy Duty Load, High Switching Frequency, High operating temperature & Insufficient cooling conditions
- LED indications for Healthy, Unhealthy, Sensor Open/Short and Phase Sequence fault conditions





Ordering Information

Cat. No.	Description
ML64BS	230 VAC, Three Phase Three Wire PTC Thermistor & SPP, 1 NO + 1 NO
ML67BS	230 VAC, Three Phase Three Wire PTC Thermistor & SPP, 1 NO + 1 NC
MLD4BS	400 VAC, Three Phase Three Wire PTC Thermistor & SPP, 1 NO + 1 NO
MLD7BS	400 VAC, Three Phase Three Wire PTC Thermistor & SPP, 1 NO + 1 NC

PTC Thermistor & Single Phasing Preventer Series PD225



Cat. No.		ML64BS	MLD7BS
Parameters			
Supply Voltage (ϕ)		230 VAC (3 Phase 3 Wire)	400 VAC (3 Phase 3 Wire)
Supply Variation		-15% to + 15% (of ϕ)	-15% to + 15% (of ϕ)
Frequency		50/60 Hz	50/60 Hz
Power Consumption (Max.)		15 VA	24 VA
Trip Settings	Trip Level	2.7 kΩ, (± 5%)	
	Reset Level	1.71 kΩ, (± 5%)	
	Sensor Short	<20Ω, (±4Ω)	
	Hysteresis	40Ω, (± 4Ω)	
	Sensor Open	> 20 kΩ, (± 5%)	
Max Cold Res(Ω) of Sensor Chain		< 1.5 kΩ	
Cable Resistance		20Ω	
Phase Asymmetry		70 VAC (± 10 VAC)	104 VAC (± 10 VAC)
Asymmetrical Phase Loss		110 VAC (± 10 VAC)	220 VAC (± 10 VAC)
Symmetrical Phase Loss		130 VAC (± 10 VAC)	240 VAC (± 10 VAC)
Restart Voltage		145 VAC (± 10 VAC)	265 VAC (± 10 VAC)
Reset Mode		Auto	
Repeat Accuracy		1%	
Time Delay	Operate Time	< 350 ms	
	Release Time	360 - 550ms for Asymmetrical or Symmetrical Phase Fault & 100ms (max.) for Phase Sequence, Thermistor Trip	
	Reset Time	100 - 750 ms	
Output	Relay Output	1 NO (SPP) + 1 NO (PTC Thermistor)	1 NO (SPP) + 1 NC (PTC Thermistor)
	Contact Rating	5A 'NO' & 3A 'NC' @ 240 VAC / 28 VDC (Resistive)	
	Electrical Life	1 x 10 ⁵	
	Mechanical Life	3 x 10 ⁷	
Utilization Category	AC - 15	Rated Voltage (Ue): 120/240 V, Rated Current (Ie): 3.0/1.5 A	
	DC - 13	Rated Voltage (Ue): 24/125/250 V, Rated Current (Ie): 2.0/0.22/0.1 A	
LED Indications	(Green)	Continuous ON	Power Supply Healthy
		Continuous OFF	Power Fail
		Flashing	Sensor Open
	(Amber)	Continuous ON	Over Temperature Trip
		Continuous OFF	Thermistor Relay ON
		Flashing	Sensor Short or Cable Short
(Red)	Continuous ON	SPP Relay Trip (For Supply Above Restart Voltage)	
	Continuous OFF	SPP Relay ON (After ensuring the input Voltage of 5V above the Restart Voltage)	
Flashing	Supply & SPP Fault below restart voltage		
Operating Temperature		- 10° C to +60° C	
Storage Temperature		- 15° C to +70° C	
Humidity (Non Condensing)		95% (Rh)	
Enclosure		Flame Retardant UL94-V0	
Dimension (W x H x D) (in mm)		22.5 X 83 X 100.5	
Weight (unpacked)		150 g	
Mounting		Base / DIN rail	
Certification		 	
Degree of Protection		IP 20 for Terminals, IP 40 for Enclosure	

EMI / EMC

Harmonic Current Emissions	IEC 61000-3-2
ESD	IEC 61000-4-2
Radiated Susceptibility	IEC 61000-4-3
Electrical Fast Transients	IEC 61000-4-4
Surges	IEC 61000-4-5
Conducted Susceptibility	IEC 61000-4-6
Voltage Dips & Interruptions (AC)	IEC 61000-4-1
Conducted Emission	CISPR 14-1
Radiated Emission	CISPR 14-1

Environmental

Cold Heat	IEC 60068-2-1
Dry Heat	IEC 60068-2-2
Vibration	IEC 60068-2-6
Repetitive Shock	IEC 60068-2-27
Non-Repetitive Shock	IEC 60068-2-27

Frequency Monitoring & PTC Thermistor Relay Series PD225

MOUNTING DIMENSION (mm)

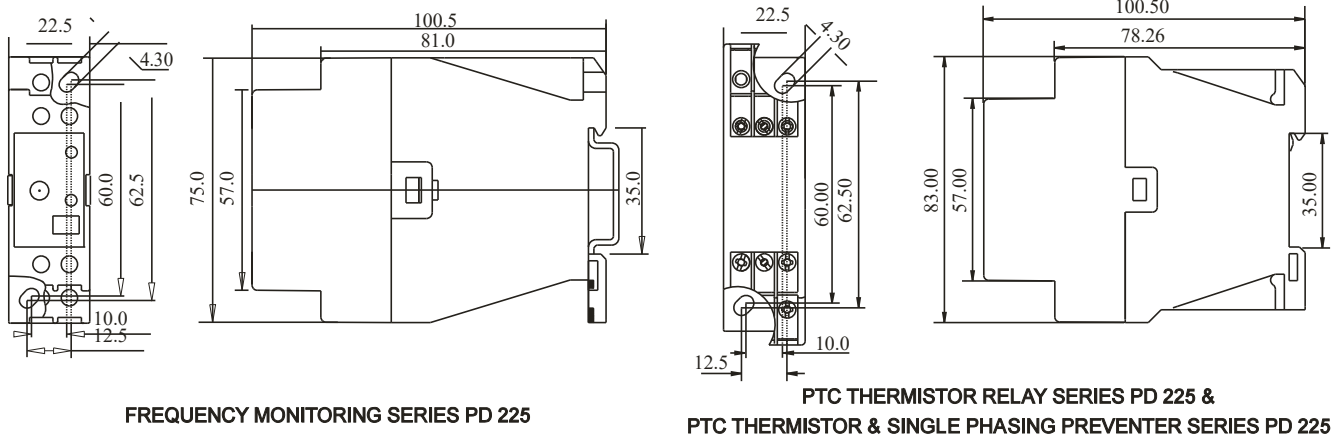

FREQUENCY MONITORING SERIES PD 225

PTC THERMISTOR RELAY SERIES PD 225 & PTC THERMISTOR & SINGLE PHASING PREVENTER SERIES PD 225

CONNECTION DIAGRAM

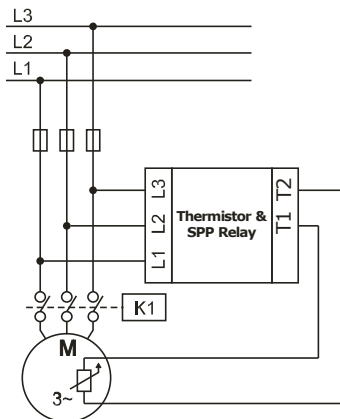

PTC THERMISTOR & SINGLE PHASING PREVENTER SERIES PD 225

CONTACT ARRANGEMENT

For 1 NO + 1 NO PRODUCT:
ML64BS, MLD4BS



For 1 NO + 1 NC PRODUCT:
ML67BS, MLD7BS

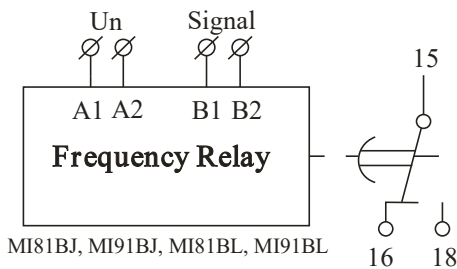

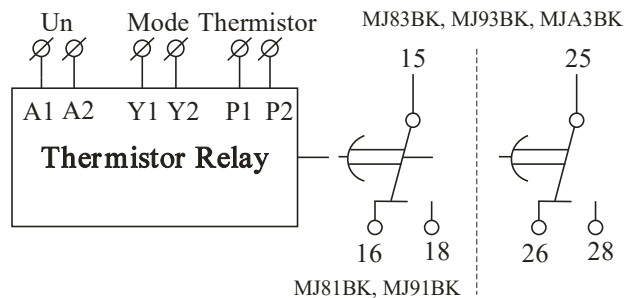

FREQUENCY MONITORING SERIES PD 225

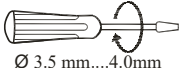

PTC THERMISTOR RELAY SERIES PD 225

TERMINAL TORQUE & CAPACITY

 Ø 3.5 mm...4.0mm	0.60 N.m (6 Lb.in)
	1 x 4.0 mm ² Solid/Stranded Wire
AWG	1 x 20 to 10

FREQUENCY MONITORING SERIES PD 225

PTC THERMISTOR RELAY SERIES PD 225

PTC THERMISTOR & SINGLE PHASING PREVENTER SERIES PD 225

Equipment Room Temperature Control Relay

- Provides protection against variations of the ambient temperature (min/max) in equipment or lift rooms
- Suitable for use in Traction and Hydraulic Lift Types
- Supports an External sensor module
- LED Indication for Relay Trip & Power ON



Ordering Information

Cat. No.	Description
45A131AR	5°C to 40°C (Traction lift type), 230V AC, 1NO, External NTC two wire sensor. Base/DIN
45A231AR	5°C to 40°C (Traction lift type), 110V AC, 1NO, External NTC two wire sensor. Base/DIN
45A231ARN	5°C to 40°C (Traction lift type), 110V AC, 1NO, Without Sensor, Base/DIN
45D331AR	5°C to 40°C (Traction Lift Type), 24V DC, 1NO, External NTC two wire sensor. Base/DIN
45A131BR	15°C to 35°C (Hydraulic Lift Type), 230V AC, 1NO, External NTC two wire sensor. Base/DIN
45A231BR	15°C to 35°C (Hydraulic Lift Type), 110V AC, 1NO, External NTC two wire sensor. Base/DIN
45D331BR	15°C to 35°C (Hydraulic Lift Type), 24V DC, 1NO, External NTC two wire sensor. Base/DIN
45SP01	Accessory, NTC 2 wire sensor assembly with 2 sensors

Equipment Room Temperature Control Relay



Cat. No.	45A131AR	45A231AR	45D331AR
Parameters			
Supply Voltage (Φ)	230 VAC	110 VAC	24 VDC
Supply Variation	± 15%		
Frequency	47Hz - 63Hz		NA
Power Consumption (Max.)	10 VA	5 VA	1.2 W
Device Characteristics			
Accuracy	± 1°C		
Output Control Mode	Relay ON/OFF		
Relay ON Delay	10 sec (Fixed), ± 1sec		
Relay OFF Delay	10 sec (Fixed), ± 1sec		
Hysteresis	2°C		
Trip Level			
High Trip Level	+ 40°C		
Low Trip Level	+ 5°C		
LED Indication			
Power ON	Green LED ON		
Relay ON	Red LED ON		
Relay OFF	Red LED OFF		
Sensor Open / Short	Red LED Blinking		
Contact Ratings	Terminal 15 – Pole, Terminal 18 – NO, 8 Amp at 250VAC, 1Amp at 30VDC 3 KV Isolation between coil and contact		
Max Power Output Rating of Relay	1840 VA for AC / 30W for DC approx		
Operating Temperature	- 15° C to +60° C		
Storage Temperature	- 20° C to +70° C		
Humidity (Non Condensing)	95% (Rh)		
Enclosure	Flame Retardant UL94-V0		
Dimension (W x H x D) (in mm)	22.5 X 75 X 100.5		
Weight (unpacked)	100 g		
Mounting	Base / DIN rail		
Certification			
Degree of Protection	IP 20 for Terminals, IP 40 for Enclosure		

EMI / EMC

Harmonic Current Emissions	IEC 61000-3-2
ESD	IEC 61000-4-2
Radiated Susceptibility	IEC 61000-4-3
Electrical Fast Transients	IEC 61000-4-4
Surge	IEC 61000-4-5
Conducted Susceptibility	IEC 61000-4-6
Voltage Dips & Interruptions (AC)	IEC 61000-4-11
Conducted Emission	CISPR 14-1
Radiated Emission	CISPR 14-1

Environmental

Cold Heat	IEC 60068-2-1
Dry Heat	IEC 60068-2-2
Vibration	IEC 60068-2-6
Repetitive Shock	IEC 60068-2-27
Non-Repetitive Shock	IEC 60068-2-27

Equipment Room Temperature Control Relay



FUNCTION DIAGRAM

For Traction Type

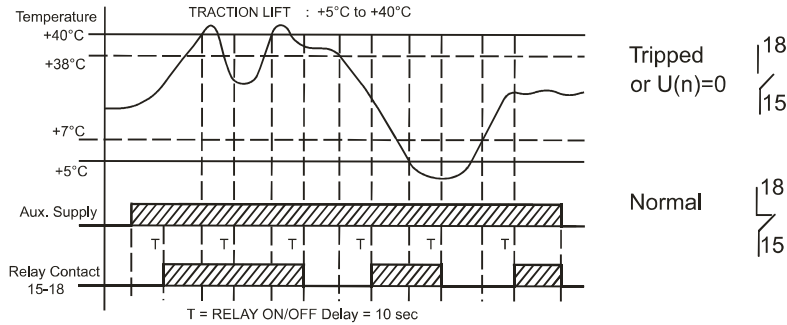

For Hydraulic Type

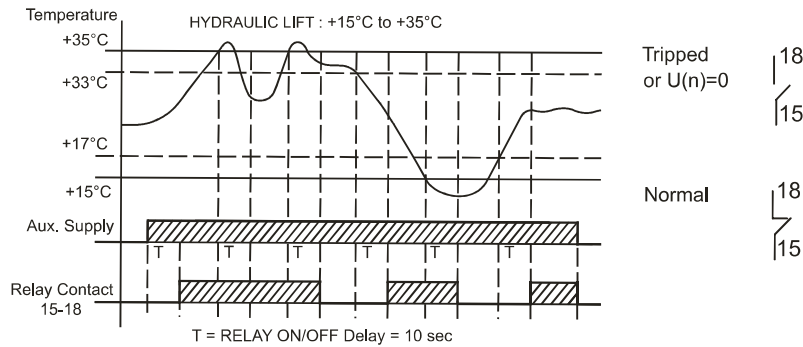

MOUNTING DIMENSIONS (mm)

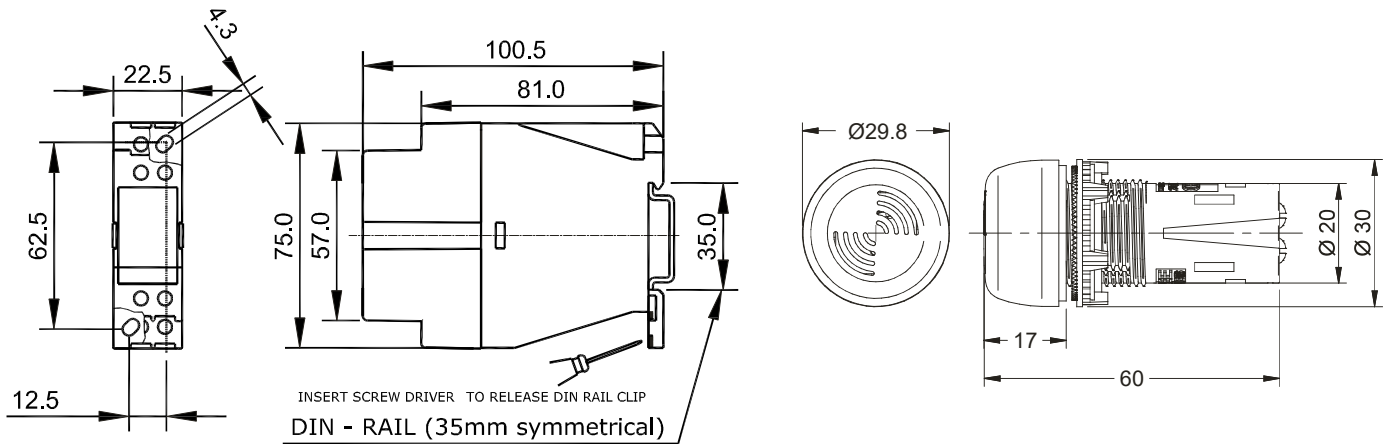

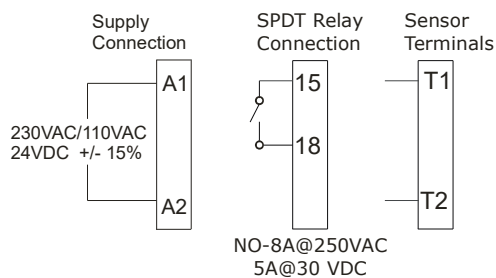

CONNECTION DIAGRAM



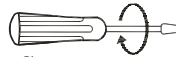

TERMINAL TORQUE & CAPACITY

For 8 and 12 terminal 225

 Ø 3.5 mm...4.0mm	0.60 N.m (6 Lb.in)
	1 x 4.0 mm ² Solid/Stranded Wire
AWG	1 x 20 to 10

Liquid Level Controller



Cat. No.	4411AD1	4421AD1	4431AD1
Parameters			
Supply Voltage (±)	110VAC, +/-20%	240VAC, +/-20%	415VAC, +/-20%
Frequency	47Hz - 63Hz		
Power Consumption (Max.)	3VA		
Device Characteristics			
Conductive Sensor Probes	Stainless Steel SS304, 3 or 6 Nos		
Sensor Length	10 cm		
Control Action Modes	Only Draining, Only Filling, Draining & Filling Simultaneous (One Tank or Two tanks)		
Sensitivity	1K to 200 K Ohm (Potentiometer adjustable)		
Sensor Voltage & Current	12 Vp-p, 100 Hz, < 1 mA		
Sensor cable	Cable gauge (Min):0.5 sq mm Tin coated, Cable dia(Min):1.5mm Max Cable Length-1000m (For set value < 50%) Max Cable Length-300m (For set value 100%) Max capacitances of wire- 80 nF / km		
Settable ON & OFF Delay Time	0.5 sec to 10 sec		
Manual Start Switch	If Lower tank water level is greater than Low level & upper tank water level is below High level then by pressing a switch Relay can be switched ON manually.		
Output Control Mode	Relay ON/OFF		
Contact Ratings	1 C/O,8A@250VAC,Resistive,Terminal 15-Pole, Terminal 16-NC,Terminal 18-NO		
Utilization Category	AC-15: Rated Voltage (Ue):120/240V, Rated Current(Ie): 3.0/1.5A DC-13: Rated Voltage (Ue):24/125/250V, Rated Current(Ie): 2.0/0.22/0.1A		
Electrical Life	1 x 10 ⁵ Operations		
Mechanical Life	1 x 10 ⁷ Operations		
LED Indication	GREEN LED: Power ON, RED LED : Relay Output ON		
Operating Temperature	-10°C to +60°C		
Storage Temperature	-10°C to +70°C		
Relative Humidity	5 to 95 % RH (non condensing)		
Mounting	Base/DIN Rail		
Dimension (W x H x D) (in mm)	36 X 90 X 65		
Weight (unpacked)	235 g (Controller), 45 g (Sensor)		
Certification	 		

EMI/EMC

Harmonic Current Emission	IEC 61000-3-2
ESD	IEC 61000-4-2
Radiated Susceptibility	IEC 61000-4-3
Electrical Fast Transient	IEC 61000-4-4
Surge	IEC 61000-4-5
Conducted Susceptibility	IEC 61000-4-6
Voltage Dips & Interruptions (AC)	IEC 61000-4-11
Conducted Emission	CISPR 14-1
Radiated Emission	CISPR 14-1

Environmental

Cold Heat	EC 60068-2-1
Dry Heat	IEC 60068-2-2
Vibration	IEC 60068-2-6
Repetitive Shock	IEC 60068-2-27
Non-Repetitive Shock	IEC 60068-2-27

Liquid Level Controller



OPERATING FUNCTION DIAGRAM

Simultaneous filling and draining with 6 Sensors

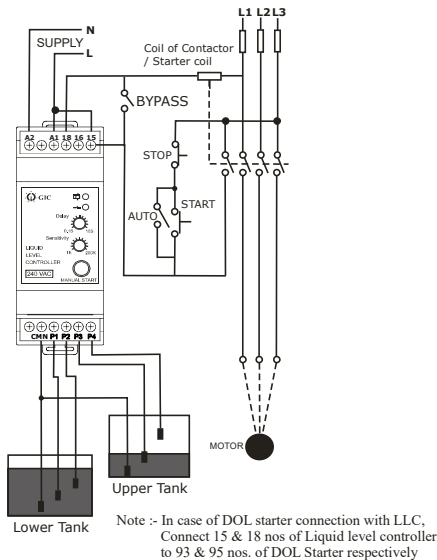

The system starts up whenever the upper tank requires liquid and the lower tank has sufficient level to supply it, and it stops when the liquid reaches its maximum level in the upper tank or if the Lower tank reaches its minimum level. If all Sensors are non conducting then Relay is "OFF". If Liquid level reaches "P1" Sensor then relay will be OFF (maintains previous state). When the level reaches "P2" Sensor then relay will be switched ON (As the liquid level has reached maximum level of Lower tank). Now Filling of Upper tank will start. When liquid level reaches "P3" Sensor, relay will be ON (maintains previous state). Now when liquid level reaches "P4" Sensor relay will be switched "OFF" (As Liquid level has reached maximum level in the Upper tank). Now if Liquid level of upper tank is decreasing and it goes below "P4" Sensor, then the relay will be "OFF" (Maintains previous state), But when it falls below "P3" level, then relay will be switched "ON" until there is enough liquid in the upper tank).

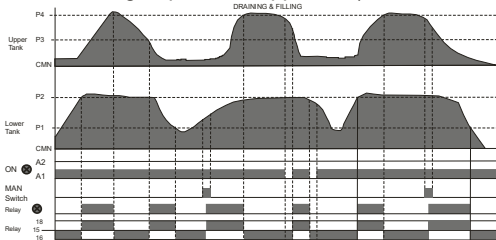

P1	P2	P3	P4	Relay & RED LED Indication
OUT	OUT	OUT	OUT	OFF
IN	OUT	OUT	OUT	OFF
IN	IN	OUT	OUT	ON
IN	IN	IN	OUT	ON
IN	IN	IN	IN	OFF
IN	IN	IN	OUT	OFF
IN	IN	OUT	OUT	ON
IN	OUT	OUT	OUT	ON
OUT	OUT	OUT	OUT	OFF

Filling Control (Single Tank Monitoring with 3 Sensors)

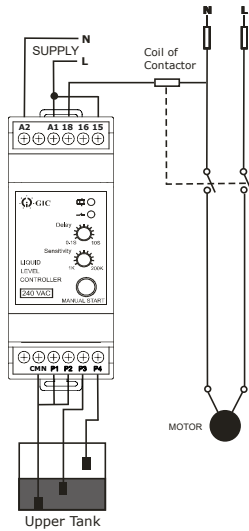

When the level in the tank drops below the low level Sensor, the relay energises. The relay then remains energised until the level reaches the high level Sensor. As soon as the high level Sensor becomes submerged, the relay de-energises and remains OFF until the level has dropped sufficiently below the low level Sensor. When "P3" & "P4" are non-conducting i.e. tank is empty, Relay is "ON". Whenever water level reaches "P3" Sensor, then again the relay will be ON (Maintains previous state of relay). But when water level touches the "P4" Sensor, then relay will be switched "OFF" (As Liquid reaches the maximum level). Again when water level decreases below "P4" level, then the relay will be switched "OFF" (Maintains previous state of relay). When water level reaches below "P3", then the relay will be switched "ON" (As the Liquid reaches minimum level)

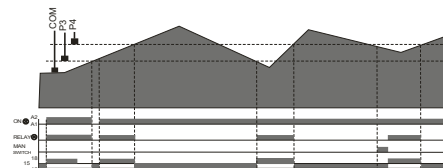

P3	P4	Relay & RED LED Indication
OUT	OUT	ON
IN	OUT	ON
IN	IN	OFF
IN	OUT	OFF
OUT	OUT	ON

Filling Control (Single level Monitoring with two Sensors)

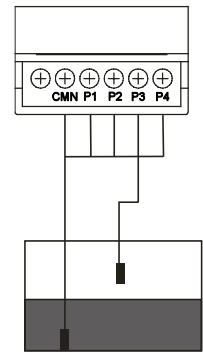

The output relay switches "ON" which starts up the relay when the Minimum level Sensor "P3" is no longer in contact with the liquid and switches "OFF" when the liquid reaches "P3". **This operation is not recommended for pump controlling.**

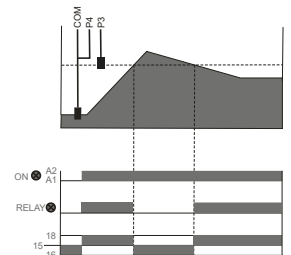

P3	Relay & RED LED Indication
OUT	ON
IN	OFF

Liquid Level Controller



OPERATING FUNCTION DIAGRAM

Draining Control (Single Tank Monitoring with 3 Sensors)

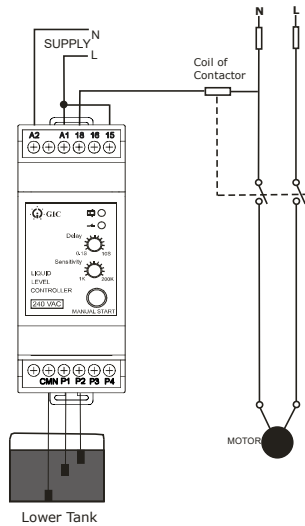

When the level in the tank rises sufficiently to submerge the high level Sensor, the relay energizes. The relay then remains energized until the level has dropped below the low level Sensor. As the liquid drops below the low level Sensor, the relay de-energizes and remains off until the level has risen sufficiently to submerge the high level Sensor. When "P1" & "P2" are non-conducting i.e. when the tank is empty, relay is "OFF". Whenever water level reaches "P1" Sensor, then again the relay will be "OFF" (maintains previous state of relay). But when water level touches the "P2" Sensor, then relay will be switched "ON" (as the Liquid reaches maximum level). Again, when water level decreases below "P2" level, then the relay will remain switched "ON" (maintains previous state of relay). When water level reaches below "P1", then relay will be switched "OFF" (as the liquid reaches minimum level).

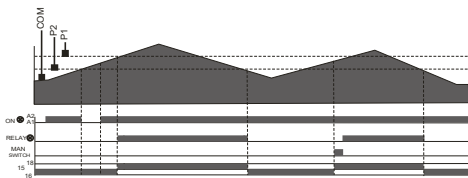

P1	P2	Relay & RED LED Indication
OUT	OUT	OFF
IN	OUT	OFF
IN	IN	ON
IN	OUT	ON
OUT	OUT	OFF

Draining Control (Single level Monitoring with two Sensors)

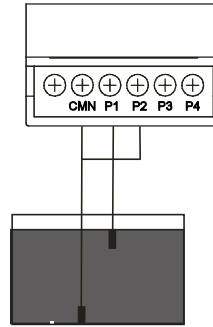

The output relay switches ON, when liquid level goes above a maximum level, fixed by the Sensor "P1", when the level drops below a "P1" Sensor, relay switches "OFF". **This operation is not recommended for pump controlling.**

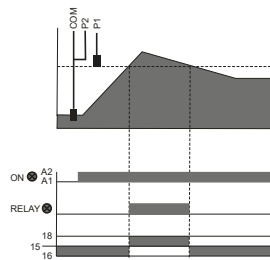

P1	Relay & RED LED Indication
OUT	OFF
IN	ON

Liquid Level Controller



SENSOR DIAGRAM

A single pole electrode used for level control in wells or storage tanks. It comprises of stainless steel Sensor with plastic holder and cable gland. A sealed ring and cable gland prevents liquid from entering the cable terminal connector and causing its oxidation.

Maximum operating temperature : -10°C to +65°C

Cable connection: Screw

The external cable diameter must be 1.5 mm to warrant perfect sealing.

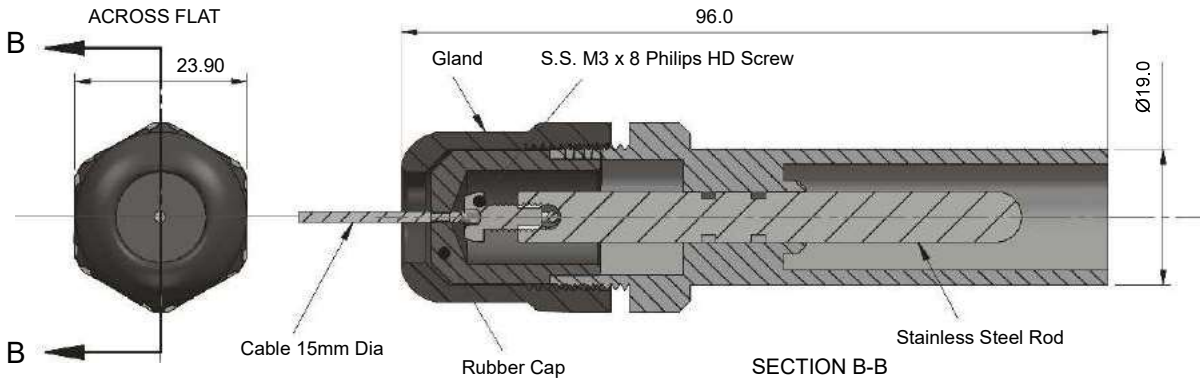

MOUNTING DIMENSIONS (mm)

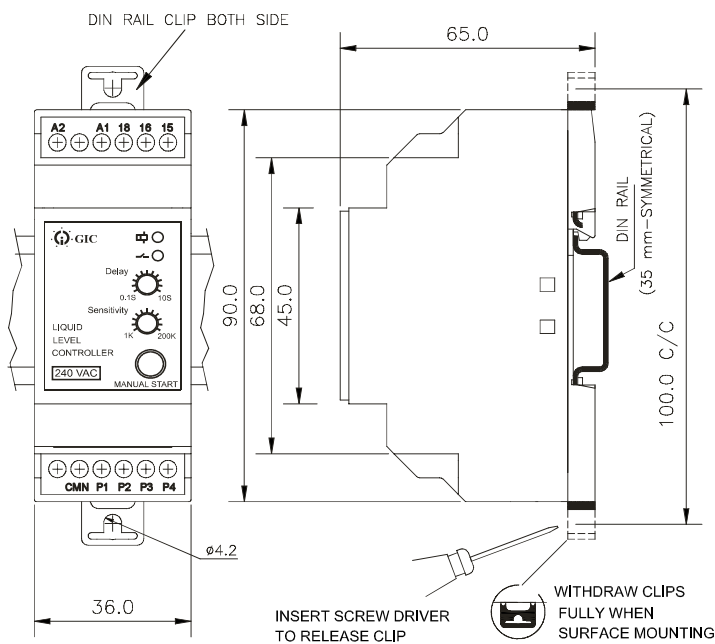

CONNECTION DIAGRAM

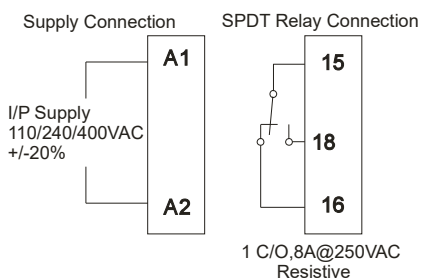

TERMINAL TORQUE & CAPACITY

	0.54 N.m (6 Lb.in)
	1 x 2.5 mm ² Solid Wire/Stranded
AWG	1 x 24 to 12



TEMPERATURE CONTROLLERS

Advanced PID Temperature Controller Series PR 69

Basic Temperature Controller Series PR 43

Product Selection Chart - Temperature Controllers

PT-100 Temperature Control Relay

Temperature Control Relay

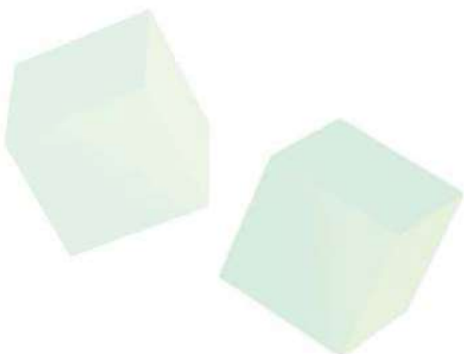

Advanced PID Temperature Controller Series PR 69

- Flush Mounting Version 96x96 mm with Dual Line Digital Seven Segment Display
- Universal Input
- Configurable Output combination
- Configurable: Band, Deviation, Sensor break & Loop break alarms
- Single/Dual acting PID controllers with 4 Control modes
- Analog Voltage / Current Inputs (0-5 V, 1-5 V, 0-10 V / 4-20 mA) and Outputs (0-10 V / 4-20 mA)
- Auto-tuning PID with provision for Soft-Start
- 6 Segment Ramp & Soak profile with Power Failure resumption modes
- Rapid Set Point change feature
- RS 485 Communication
- Bumpless Auto-Manual transfer
- IP 20 (for Terminals & Enclosure) IP 40 (for Front Panel only)
- Timer functionality with settable time from 1min to 9999 min



Ordering Information

Dual Acting PID Controller

Cat. No.	Description
151F43B	2 Relays (SPST 5A each), SSR (12 VDC, 24mA)
151G43B	1 Relay (SPST 5A), Analog output (0-10V, 4-20mA), SSR (12 VDC, 24mA)
151H43B	2 Relays (SPST 5A each), Analog output (0-10V, 4-20mA)
151J43B	3 Relays (SPST 5A each)
151F43B1	2 Relays (SPST 5A each), SSR (12 VDC, 24mA) with RS485
151G43B1	1 Relay (SPST 5A), Analog output (0-10V, 4-20mA), SSR (12 VDC, 24mA) with RS485
151H43B1	2 Relays (SPST 5A each), Analog output (0-10V, 4-20mA) with RS485
151J43B1	3 Relays (SPST 5A each) with RS485

Advanced PID Temperature Controller Series PR 69



Cat. No.	151F43B1	151G43B1	151H43B1	151J43B1
Parameters				
Supply Voltage (ϕ)	110 - 240 VAC/DC			
Supply Variation	-20% to +20%(of ϕ)			
Frequency	50/60 Hz			
Control Action	ON/OFF (Symmetric/ Asymmetric), PID (Single/ Dual Acting) (Neutral zone only for dual acting)			
Tuning Method	Auto Tuning / Manual Tuning			
Temperature sensors / Inputs	Thermocouple: J, K, E, S, B, R; RTD: PT100 - 3 wire compensation; Analog Signal DC: (0-50 mV, 0-60 mV, 12-60 mV)			
Analog Input	0-5 V, 1-5 V, 0-10 V / 4-20 mA			
Measurement Range	Sensor J: 0 to 700°C/32 to 1292°F, Sensor K: 0 to 1300°C/32 to 2372°F, Sensor E: 0 to 600°C/32 to 1112°F, Sensor R: 0 to 1750°C/32 to 3182°F, Sensor S: 0 to 1750°C/32 to 3182°F, Sensor B: 250 to 1820°C/482 to 3308°F, Sensor PT100 3 wire: - 200 to 700°C/328 to 1292°F			
Measurement Accuracy	0.5 % of full scale of Pt100, for j, K +/-1% & for other thermocouple it is +/- 3%, For Tc and mV signals +/- 0.2 % at 25°C (for DC analog input)			
Resolution	0.1°C for RTD, J,E & 1° for S,B,K,R & 0.001°C for mV signals, +/-1 Digit (For DC Analog Input)			
Configurable Set Points	4			
Display	Dual row 7 segment display with LED indications, 4-digit process value, 4 digit set value			
Keypad	4-Keys: - Exit / Configurable Key, - Down, - Up, - Enter / Select			
Output 1	Relay: SPST 5A@240VAC/24VDC	Analog: 0 - 10V DC / 4 - 20 mA Configurable Retransmission Output	Relay: SPST 5A @ 240 VAC / 24 VDC	
Output 2	Relay: SPST 5A @ 240 VAC / 24 VDC			
Output 3	SSR: 12 VDC, 24 mA Short Circuit Protection		Relay: SPST 5A @ 240 VAC / 24 VDC	
Analog Output Update Rate	N A	150ms to 5s		N A
Alarm Types	Absolute (High/Low/Band), Deviation (High/Low/Band), Sensor Break, Loop Break,			
Soft Start Feature	Yes			
Ramp Soak Feature	3 Ramp & 3 Soak			
RS 485 Communication	RS 485 Communication			
Transmission Speed & Type	300 to 19200 BPS (Half Duplex)			
Transmission Protocol	Modbus RTU			
Operating Temperature	0°C to +50°C			
Storage Temperature	-20°C to +60°C			
Humidity (Non Condensing)	80% (Rh)			
Enclosure	Flame Retardant UL94V0			
Dimensions (W x H x D) (in mm)	96 x 96 x 69.1			
Weight (unpacked)	280 g			
Mounting	Flush			
Certification				
Degree of Protection	IP 20 Terminal & Enclosure, IP 40 (For Front Panel only)			

EMI / EMC

Harmonic Current Emissions	IEC 61000-3-2
ESD	IEC 61000-4-2
Radiated Susceptibility	IEC 61000-4-3
Electrical Fast Transients	IEC 61000-4-4
Surges	IEC 61000-4-5
Conducted Susceptibility	IEC 61000-4-6
Voltage Dips Immunity Test (DC)	IEC 61000-4-29
Conducted Emission	CISPR 11
Radiated Emission	CISPR 11

Environmental

Cold Heat	IEC 60068-2-1
Dry Heat	IEC 60068-2-2
Vibration	IEC 60068-2-6
Repetitive Shock	IEC 60068-2-27
Non-Repetitive Shock	IEC 60068-2-27

Advanced PID Temperature Controller Series PR 69



Ordering Information

Single Acting PID Controller

Advanced PID Series PR 69

Cat. No.	Description
151F42B	2 Relays (SPST 5A each), SSR driving output (12 VDC, 24 mA)
151G42B	1 Relay (SPST 5A), Analog output (0-10V, 4-20 mA), SSR driving output (12 VDC, 24mA)
151H42B	2 Relays (SPST 5A each), Analog output (0-10V, 4-20 mA)
151J42B	3 Relays (SPST 5A each)
151K42B	1 Relay (1 C/O 10A), SSR driving output (12 VDC, 24 mA)
151L42B	2 Relays (1 C/O 10A & SPST 5A), SSR driving output (12 VDC, 24 mA) without Analog Input

Advanced PID Temperature Controller Series PR 69



Cat. No.	151F42B	151G42B	151H42B	151J42B
Parameters				
Supply Voltage (φ)	110 - 240 VAC/DC			
Supply Variation	-20% to +20% (of φ)			
Frequency	50/60 Hz			
Control Action	ON/OFF (Symmetric / Asymmetric), PID (Single Acting)			
Tuning Method	Auto Tuning / Manual Tuning			
Temperature sensors / Inputs	Thermocouple: J, K, E, S, B, R; RTD: PT100 - 3 wire compensation; Analog Signal DC: (0-50 mV, 0-60 mV, 12-60 mV)			
Analog Input	0-5 V, 1-5 V, 0-10 V / 4-20 mA			
Measurement Range	Sensor J: 0 to 700°C/32 to 1292°F, Sensor K: 0 to 1300°C/32 to 2372°F, Sensor E: 0 to 600°C/32 to 1112°F, Sensor R: 0 to 1750°C/32 to 3182°F, Sensor S: 0 to 1750°C/32 to 3182°F, Sensor B: 250 to 1820°C/482 to 3308°F, Sensor PT100 3 wire: - 200 to 700°C/-328 to 1292°F			
Measurement Accuracy	0.5 % of full scale of Pt100, for j, K +/-1% & for other thermocouple it is +/- 3%, For Tc and mV signals +/- 0.2 % at 25°C (for DC analog input)			
Resolution	0.1°C for RTD, J,E & 1° for S,B,K,R & 0.001°C for mV signals			
Configurable Set Points	2			
Display	Dual row 7 segment display with LED indications, 4-digit process value, 4 digit set value			
Keypad	4-Keys: (Exit / Configurable Key), (Down), (Up), (Enter / Select)			
Output 1	Relay: SPST 5A @ 240 VAC / 24 VDC	Analog: 0 - 10V DC / 4 - 20 mA Configurable Retransmission Output		Relay: SPST 5A @ 240 VAC / 24 VDC
Output 2	Relay: SPST 5A @ 240 VAC / 24 VDC			
Output 3	SSR: 12 VDC, 24 mA Short Circuit Protection		Relay: SPST 5A @ 240 VAC / 24 VDC	
Analog Output Update Rate	N A		150ms to 5s	
Alarm Types	Absolute (High/Low/Band), Deviation (High/Low/Band), Sensor Break, Loop Break,			
Soft Start Feature	Yes			
Ramp Soak Feature	No			
Operating Temperature	0°C to +50°C			
Storage Temperature	-20°C to +60°C			
Humidity (Non Condensing)	80% (Rh)			
Enclosure	Flame Retardant UL94V0			
Dimensions (W x H x D) (in mm)	96 x 96 x 69.1			
Weight (unpacked)	280 g			
Mounting	Flush			
Certification				
Degree of Protection	IP 20 Terminal & Enclosure, IP 40 (For Front Panel only)			

EMI / EMC

ESD	IEC 61000-4-2
Radiated Susceptibility	IEC 61000-4-3
Electrical Fast Transients	IEC 61000-4-4
Surges	IEC 61000-4-5
Conducted Susceptibility	IEC 61000-4-6
Voltage dips Immunity test (DC)	IEC 61000-4-29
Conducted Emission	CISPR 11
Radiated Emission	CISPR 11

Environmental

Cold Heat	IEC 60068-2-1
Dry Heat	IEC 60068-2-2
Vibration	IEC 60068-2-6

Advanced PID Temperature Controller Series PR 69



CONNECTION DIAGRAM

151F42B / 151F43B

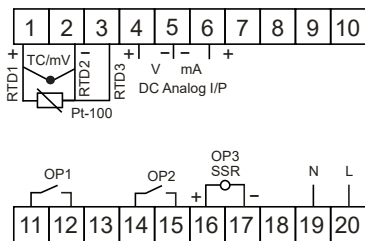

151G42B / 151G43B

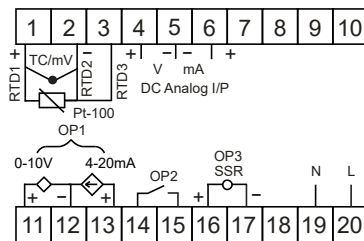

151H42B / 151H43B

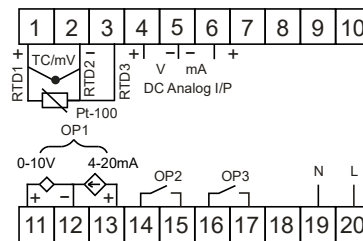

151J42B / 151J43B

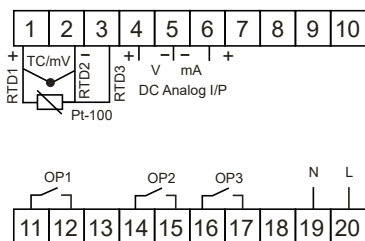

151F43B1

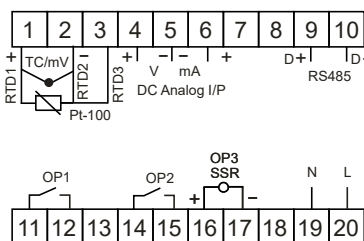

151G43B1

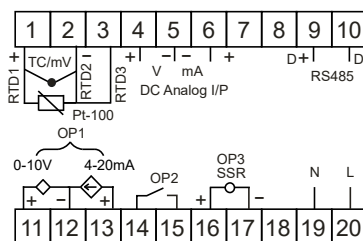

151H43B1

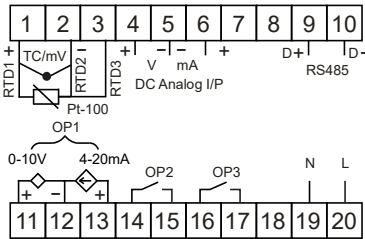

151J43B1

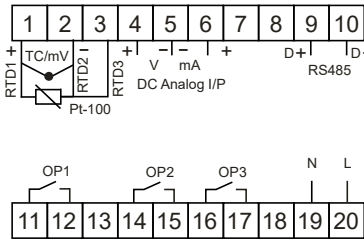

151K42B

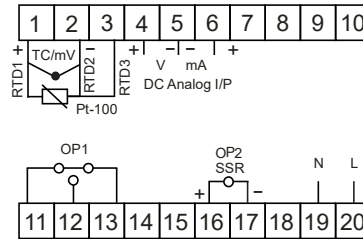

MOUNTING DIMENSION (mm)

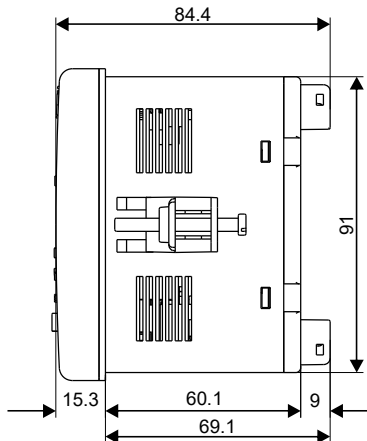
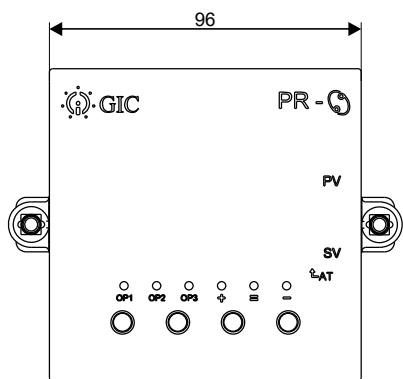

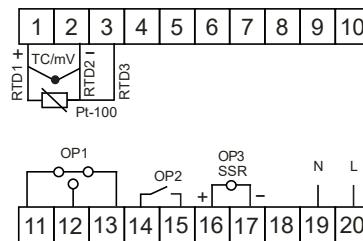

151L42B

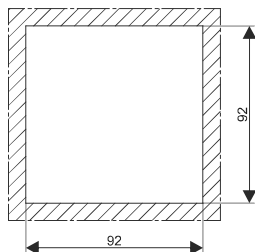

Panel Cutout



TERMINAL TORQUE & CAPACITY

 Ø 4 5.0mm Combi Head Bit./Flat	0.5 N.m (4.4 Lb.in) to 0.7 N.m (6.2 Lb. in)
	2 x 2.5 mm ² Solid/Stranded Wire
AWG	1 x 20 to 12

Advanced PID Temperature Controller Series PR 69

- Universal Input
- Flush Mounting Version 48x48 mm with Dual Line Digital Seven Segment Display
- Configurable Output combination
- Configurable: Band, Deviation, Sensor break & Loop break alarms
- Single/Dual acting PID controllers with 4 Control modes
- Auto-tuning PID with provision for Soft-Start
- 6 Segment (3 Ramp & 3 Soak) with Power Failure resumption modes
- RS 485 Communication
- IP 20 (for Terminals & Enclosure) IP 40 (for Front Panel only)
- Timer functionality with settable time from 1min to 9999 min



Ordering Information

Dual Acting PID Controller

Cat. No.	Description
151A13B	2 Relays (SPST 5A each), SSR (12 VDC, 24 mA)
151B13B	1 Relay (SPST 5A), Analog output (0-10V, 4-20 mA), SSR (12 VDC, 24 mA)
151C13B	2 Relays (SPST 5A each), Analog output (0-10V, 4-20 mA)
151D13B	3 Relays (SPST 5A each)
151A13B1	2 Relays (SPST 5A each), SSR (12 VDC, 24 mA) with RS485
151B13B1	1 Relay (SPST 5A), Analog output (0-10V, 4-20 mA), SSR (12 VDC, 24 mA) with RS485
151C13B1	2 Relays (SPST 5A each), Analog output (0-10V, 4-20 mA) with RS485
151D13B1	3 Relays (SPST 5A each) with RS485

Advanced PID Temperature Controller Series PR 69



Cat. No.	151A13B1	151B13B1	151C13B1	151D13B1
Parameters				
Supply Voltage (ϕ)	110 - 240 VAC/DC			
Supply Variation	-20% to +10%(of ϕ)			
Frequency	50/60 Hz			
Control Action	ON/OFF (Symmetric/ Asymmetric), PID (Single/ Dual Acting) (Neutral zone only for dual acting)			
Tuning Method	Auto Tuning / Manual Tuning			
Temperature sensors / Inputs	Thermocouple: J, K, E, S, B, R; RTD: PT100 - 3 wire compensation; Analog Signal DC: (0-50 mV, 0-60 mV, 12-60 mV)			
Measurement Range	Sensor J: 0 to 700°C/32 to 1292°F, Sensor K: 0 to 1300°C/32 to 2372°F, Sensor E: 0 to 600°C/32 to 1112°F, Sensor R: 0 to 1750°C/32 to 3182°F, Sensor S: 0 to 1750°C/32 to 3182°F, Sensor B: 250 to 1820°C/482 to 3308°F, Sensor PT100 3 wire: - 200 to 700°C/-328 to 1292°F			
Measurement Accuracy	+/-0.5% of full scale of PT100, +/-1% of full scale for TC & mV signals			
Resolution	0.1°C for RTD, J,E & 1° for S,B,K,R & 0.001°C for mV signals			
Configurable Set Points	4			
Display	Dual row 7 segment display with LED indications, 4-digit process value, 4 digit set value			
Keypad	4-Keys: - Exit / Configurable Key, - Down, - Up, - Enter / Select			
Output 1	Relay: SPST 5A @ 240 VAC / 28 VDC	Analog: 0 - 10V DC / 4 - 20 mA Configurable Retransmission Output	Relay: SPST 5A @ 240 VAC / 28 VDC	
Output 2	Relay: SPST 5A @ 240 VAC / 24 VDC			
Output 3	SSR: 12 VDC, 24 mA Short Circuit Protection		Relay: SPST 5A @ 240 VAC / 24 VDC	
Analog Output Update Rate	N A	150ms to 5s		N A
Alarm Types	Absolute (High/Low/Band), Deviation (High/Low/Band), Sensor Break, Loop Break,			
Soft Start Feature	Yes			
Ramp Soak Feature	3 Ramp & 3 Soak			
RS 485 Communication	RS 485 Communication			
Transmission Speed & Type	300 to 19200 BPS (Half Duplex)			
Transmission Protocol	Modbus RTU			
Operating Temperature	0°C to +50°C			
Storage Temperature	-20°C to +60°C			
Humidity (Non Condensing)	80% (Rh)			
Enclosure	Flame Retardant UL94V0			
Dimensions (W x H x D) (in mm)	48 x 48 x 107.4			
Weight (unpacked)	160 g			
Mounting	Flush			
Certification				
Degree of Protection	IP 20 Terminal & Enclosure, IP 40 (For Front Panel only)			

EMI / EMC

ESD	IEC 61000-4-2
Radiated Susceptibility	IEC 61000-4-3
Electrical Fast Transients	IEC 61000-4-4
Surges	IEC 61000-4-5
Conducted Susceptibility	IEC 61000-4-6
Voltage Dips & Interruptions (AC)	IEC 61000-4-11
Conducted Emission	CISPR 11
Radiated Emission	CISPR 11

Environmental

Cold Heat	IEC 60068-2-1
Dry Heat	IEC 60068-2-2
Vibration	IEC 60068-2-6

Advanced PID Temperature Controller Series PR 69



Ordering Information

Single Acting PID Controller
Advanced PID Series PR 69

Cat. No.	Description
151A12B	2 Relays (SPST 5A each), SSR (12 VDC, 24 mA)
151B12B	1 Relay (SPST 5A), Analog output (0-10V, 4-20 mA), SSR (12 VDC, 24 mA)
151C12B	2 Relays (SPST 5A each), Analog output (0-10V, 4-20 mA)
151D12B	3 Relays (SPST 5A each)
151E12B	1 Relay (1 C/O 10A), SSR (12VDC, 24 mA)

Advanced PID Temperature Controller Series PR 69



Cat. No.	151A12B	151B12B	151C12B	151D12B
Parameters				
Supply Voltage (φ)	110 - 240 VAC/DC			
Supply Variation	-20% to +10% (of φ)			
Frequency	50/60 Hz			
Control Action	ON/OFF (Symmetric / Asymmetric), PID (Single Acting)			
Tuning Method	Auto Tuning / Manual Tuning			
Temperature sensors / Inputs	Thermocouple: J, K, E, S, B, R; RTD: PT100 - 3 wire compensation; Analog Signal DC: (0-50 mV, 0-60 mV, 12-60 mV)			
Measurement Range	Sensor J: 0 to 700°C/32 to 1292°F, Sensor K: 0 to 1300°C/32 to 2372°F, Sensor E: 0 to 600°C/32 to 1112°F, Sensor R: 0 to 1750°C/32 to 3182°F, Sensor S: 0 to 1750°C/32 to 3182°F, Sensor B: 250 to 1820°C/482 to 3308°F, Sensor PT100 3 wire: - 200 to 700°C/-328 to 1292°F			
Measurement Accuracy	± 0.5% of full scale of PT100, ± 1% of full scale for TC & mV signals			
Resolution	0.1°C for RTD, J,E & 1° for S,B,K,R & 0.001°C for mV signals			
Configurable Set Points	2			
Display	Dual row 7 segment display with LED indications, 4-digit process value, 4 digit set value			
Keypad	4-Keys: [Exit/Configurable Key] - Exit / Configurable Key, [Down] - Down, [Up] - Up, [Enter/Select] - Enter / Select			
Output 1	Relay: SPST 5A @ 240 VAC / 24 VDC	Analog: 0 - 10V DC / 4 - 20 mA Configurable Retransmission Output	Relay: SPST 5A @ 240 VAC / 24 VDC	
Output 2	Relay: SPST 5A @ 240 VAC / 28 VDC			
Output 3	SSR: 12 VDC, 24 mA Short Circuit Protection		Relay: SPST 5A @ 240 VAC / 28 VDC	
Analog Output Update Rate	NA	150ms to 5s		NA
Alarm Types	Absolute (High/Low/Band), Deviation (High/Low/Band), Sensor Break, Loop Break,			
Soft Start Feature	Yes			
Ramp Soak Feature	No			
Operating Temperature	0°C to +50°C			
Storage Temperature	-20°C to +60°C			
Humidity (Non Condensing)	80% (Rh)			
Enclosure	Flame Retardant UL94V0			
Dimensions (W x H x D) (in mm)	48 x 48 x 107.4			
Weight (unpacked)	160 g			
Mounting	Flush			
Certification				
Degree of Protection	IP 20 Terminal & Enclosure, IP 40 (For Front Panel only)			

EMI / EMC

ESD	IEC 61000-4-2
Radiated Susceptibility	IEC 61000-4-3
Electrical Fast Transients	IEC 61000-4-4
Surges	IEC 61000-4-5
Conducted Susceptibility	IEC 61000-4-6
Voltage Dips & Interruptions (AC)	IEC 61000-4-11
Conducted Emission	CISPR 11
Radiated Emission	CISPR 11

Environmental

Cold Heat	IEC 60068-2-1
Dry Heat	IEC 60068-2-2
Vibration	IEC 60068-2-6

Advanced PID Temperature Controller Series PR 69



CONNECTION DIAGRAM

151A12B/151A13B

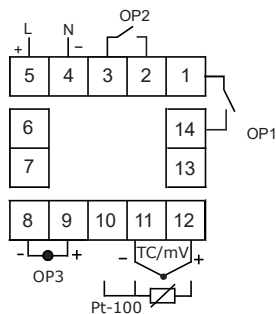

151B12B/151B13B

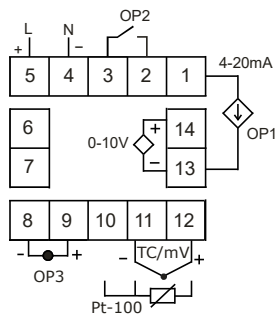

151C12B/151C13B

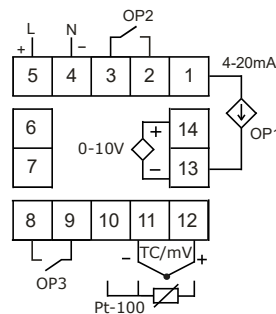

151D12B/151D13B

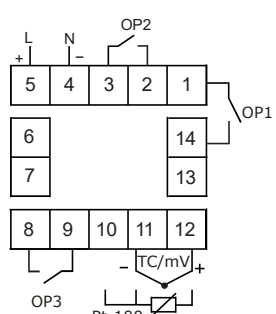

151A13B1

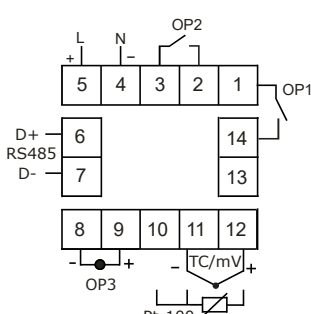

151B13B1

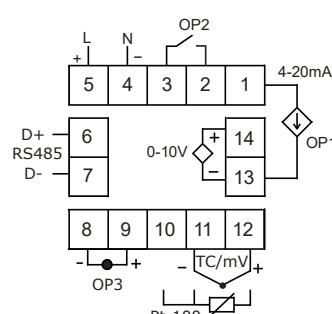

151C13B1

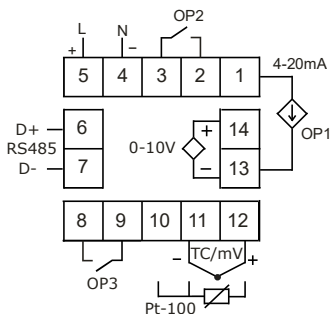

151D13B1

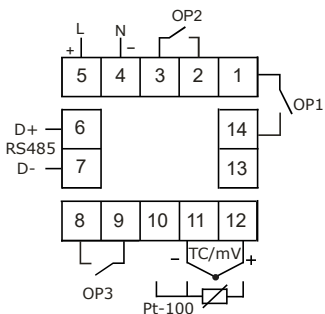

151E12B

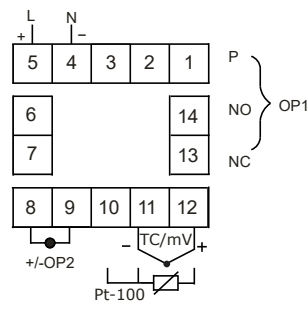

MOUNTING DIMENSION (mm)

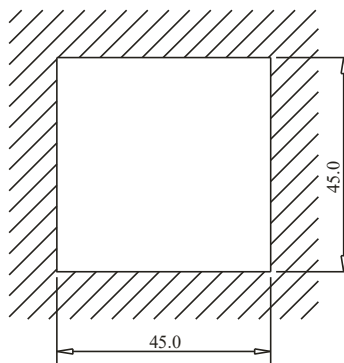
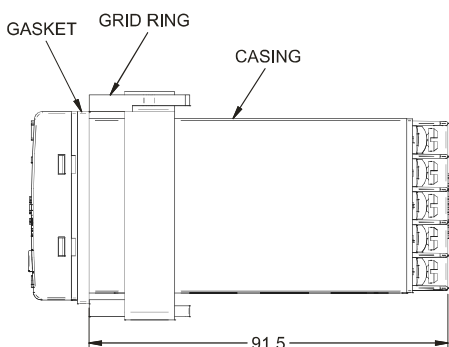

Terminal Connection: AWG 20 to 12, Ph1- 4...5.0 mm, Torque 0.5 N. m (4.4 lb.in)

Basic Temperature Controller Series PR 43

- Highly Accurate Performance.
- Flush Mounting Version 96x96 mm with luxurious single 4-digit LED Display.
- Wide supply range: 110-240 VAC/DC , -20 to +10% of Un.
- Front keypad with 4 keys.
- Thermocouple (J, K & T), RTD 3-wire (Pt-100) sensor inputs.
- Control Modes: Proportional, ON-OFF Asymmetric, ON-OFF Symmetric.
- °C & °F temperature unit selectable
- Selectable Output: Relay or SSR Drive
- Alarm Functionality



Ordering Information

Basic PID Temperature Controller

Cat. No. Description

151M42B	Series PR 43, Relay Output (SPDT 10A) & SSR driving output (12 VDC, 24mA max), One Relay Output (SPDT 5A)
151N42B	Series PR 43, Relay Output (SPDT 10A) & SSR driving output (12 VDC, 24mA max)

Basic Temperature Controller Series PR 43



Cat. No.	151N42B	151M42B
Parameters		
Supply Voltage (ϕ)	110 - 240 VAC/DC	
Supply Variation	-20% to +10% (of ϕ)	
Frequency	50/60 Hz	
Control Action	ON/OFF (Symmetric / Asymmetric) & Proportional	
Power Consumption	8 VA @ 265 VAC	
Temperature sensors / Inputs	Thermocouple: J, K ; RTD: PT100 - 3 wire compensation;	
Measurement Range	TC (J-type): -50 to 1000°C OR -58 to 1832°F TC (K-type): -50 to 1350°C OR -58 to 1350°F TC (T-type): -50 to 400°C OR -58 to 752°F RTD (Pt-100): -100 to 650°C OR -148 to 1202°F	
Measurement Accuracy	± 0.5% of full scale	
Resolution	1°C Fixed	
Configurable Set Points	1	
Display	7 segment, 4 digit LED display	
Keypad	4-Keys: - ESC, - Down, - Up, - Enter / Select	
Contact Arrangement	Relay: 1 C/O (SPDT)	
Contact Rating	10A RES. @ 250VAC/30VDC	5A(NO), 3A(NC), RES. @ 250VAC/30VDC
Output 1	Relay 1C/O 10A OR SSR Drive, 12 VDC 30mA (Selectable)	
Output 2	NA	Relay 1C/O 5A
Error Indications		
	<i>SEn5</i>	Sensor open/break error
	<i>oUr9</i>	Over range error
	<i>Unr9</i>	Under range error
	<i>ErRt</i>	Error in auto-tuning
	<i>noRt</i>	Auto-tuning not finished within 10 hour
	<i>cbRt</i>	Loop break interrupted
Operating Temperature	0°C to +50°C	
Storage Temperature	-20°C to +60°C	
Humidity (Non Condensing)	5 to 80% RH	
Enclosure	Flame Retardant UL 94 - V0	
Dimensions (W x H x D) (in mm)	96 x 96 x 84.4	
Weight (unpacked)	250 g	
Mounting	Flush	
Certification		
Degree of Protection	IP 20 Terminal & Enclosure, IP 40 (For Front Panel only)	

EMI / EMC

Harmonic Current Emissions	IEC 61000-3-2 (Class A)
ESD	IEC 61000-4-2 (Level II)
Radiated Susceptibility	IEC 61000-4-3 (Level III)
Electrical Fast Transients	IEC 61000-4-4 (Level IV)
Surges	IEC 61000-4-5 (Level IV)
Conducted Susceptibility	IEC 61000-4-6 (Level III)
Voltage Dips & Interruptions (AC)	IEC 61000-4-11
Conducted Emission	CISPR 11 (Class A)
Radiated Emission	CISPR 11 (Class A)

Environmental

Cold Heat	IEC 60068-2-1
Dry Heat	IEC 60068-2-2
Vibration	IEC 60068-2-6 (5g)
Repetitive Shock	IEC 60068-2-27 (40g, 6ms)
Non-Repetitive Shock	IEC 60068-2-27 (30g, 15ms)

Basic Temperature Controller Series PR 43



CONNECTION DIAGRAM

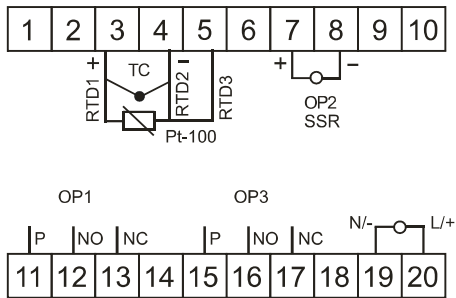

151M42B

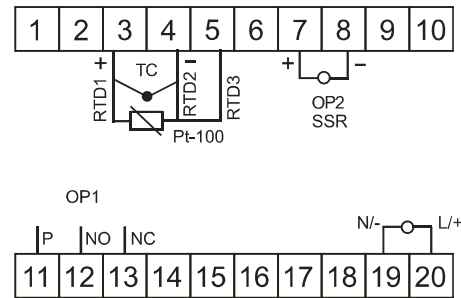

151N42B

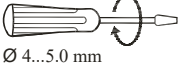

TERMINAL TORQUE & CAPACITY

 Ø 4...5.0 mm Combi Head Bit./Flat	0.5 N.m (4.4 lb.in) 0.7 N.m (6.2 lb.in)
	2 x 2.5 mm ² Solid/Stranded Wire
AWG	20 to 12

MOUNTING DIMENSION (mm)

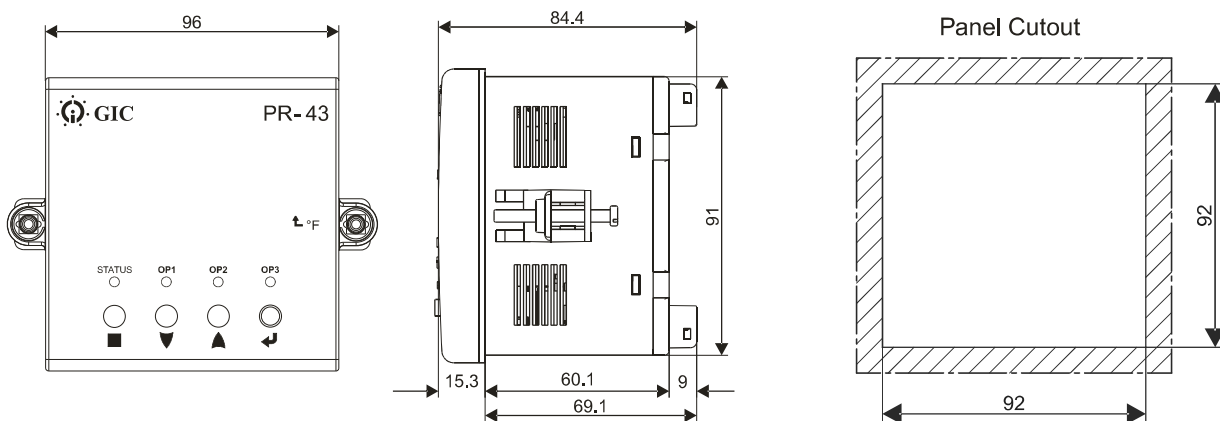

Basic Temperature Controller Series PR 43

- Highly Accurate Performance.
- Flush Mounting Version 48x48 mm with luxurious single 3-digit LED Display.
- Wide supply range:110-240VAC/DC (Un),-20 to +10% of Un.
- Front keypad with 4 keys.
- Thermocouple (J & K)/RTD 3-wire (Pt-100) sensor inputs.
- Control Modes: Proportional, ON-OFF Asymmetric, ON-OFF Symmetric.
- °C & °F temperature unit selectable
- Control Output: Relay & SSR Drive (Individual products)



Ordering Information

ON - OFF Temperature Controller

Cat. No.	Description
151G11B	Series PR 43, Relay Output (1 C/O, 5A)
151H11B	Series PR 43, SSR (12 VDC, 30 mA)
151F11B	Series PR 43, Relay Output (1 C/O, 10A)

Basic PID Temperature Controller

Cat. No.	Description
151G12B	Series PR 43, Relay Output (1 C/O, 5A)
151H12B	Series PR 43, SSR (12 VDC, 24 mA)
151F12B	Series PR 43, Relay Output (1 C/O,10A)

Basic Temperature Controller Series PR 43



Cat. No.	151G11B	151H11B	
Parameters			
Supply Voltage (φ)	110 - 240 VAC/DC		
Supply Variation	-20% to +10% (of φ)		
Frequency	50/60 Hz		
Control Action	ON/OFF (Symmetric / Asymmetric) & Proportional		
Power Consumption	6 VA @ 265 VAC		
Temperature sensors / Inputs	Thermocouple: J, K ; RTD: PT100 - 3 wire compensation;		
Measurement Range	Sensor J: -5°C to 750°C / 23°F to 999°F, Sensor K: -20°C to 850°C / -4°F to 999°F, Sensor PT100 3 wire: - 100°C to 650°C / -148°F to 999°F		
Measurement Accuracy	± 0.5% of full scale		
Resolution	1°C Fixed		
Configurable Set Points	1		
Display	7 segment, 3 digit LED display		
Keypad	4-Keys: - ESC, - Down, - Up, - Enter / Select		
Output 1	Relay: 1 C/O 5A @ 240 VAC / 30 VDC	SSR: 12 VDC, 30 mA	
LED Indications:			
	OP1 (Red LED)	Continuous ON	Relay output ON
	°F (Red LED)	Continuous ON	Display °F value
	°C (Red LED)	Continuous OFF	Display °C value
Error Indications			
	SBR	Sensor open/break error	
	OVR	Over range error	
	UNR	Under range error	
Operating Temperature	0°C to +50°C		
Storage Temperature	-20°C to +60°C		
Humidity (Non Condensing)	80% (Rh)		
Enclosure	Flame Retardant UL 94 - V0		
Dimensions (W x H x D) (in mm)	48 x 48 x 107.4		
Weight (unpacked)	120 g		
Mounting	Flush		
Certification			
Degree of Protection	IP 20 Terminal & Enclosure, IP 40 (For Front Panel only)		

EMI / EMC

Harmonic Current Emissions	IEC 61000-3-2
ESD	IEC 61000-4-2
Radiated Susceptibility	IEC 61000-4-3
Electrical Fast Transients	IEC 61000-4-4
Surges	IEC 61000-4-5
Conducted Susceptibility	IEC 61000-4-6
Voltage Dips & Interruptions (AC)	IEC 61000-4-11
Conducted Emission	CISPR 11
Radiated Emission	CISPR 11

Environmental

Cold Heat	IEC 60068-2-1
Dry Heat	IEC 60068-2-2
Vibration	IEC 60068-2-6
Repetitive Shock	IEC 60068-2-27
Non-Repetitive Shock	IEC 60068-2-27

Basic Temperature Controller Series PR 43



CONNECTION DIAGRAM

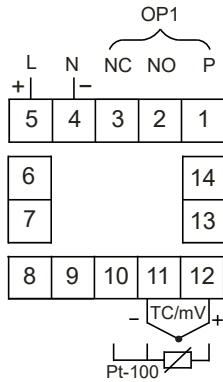

151G11B/151F11B/151G12B/151F12B

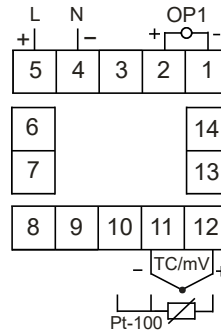

151H11B / 151H12B



TERMINAL TORQUE & CAPACITY

 Ø 4...5.0 mm Combi Head Bit./Flat	0.5 N.m (4.4 lb.in) 0.7 N.m (6.2 lb.in)
	2 x 2.5 mm ² Solid/Stranded Wire
AWG	20 to 12

MOUNTING DIMENSION (mm)

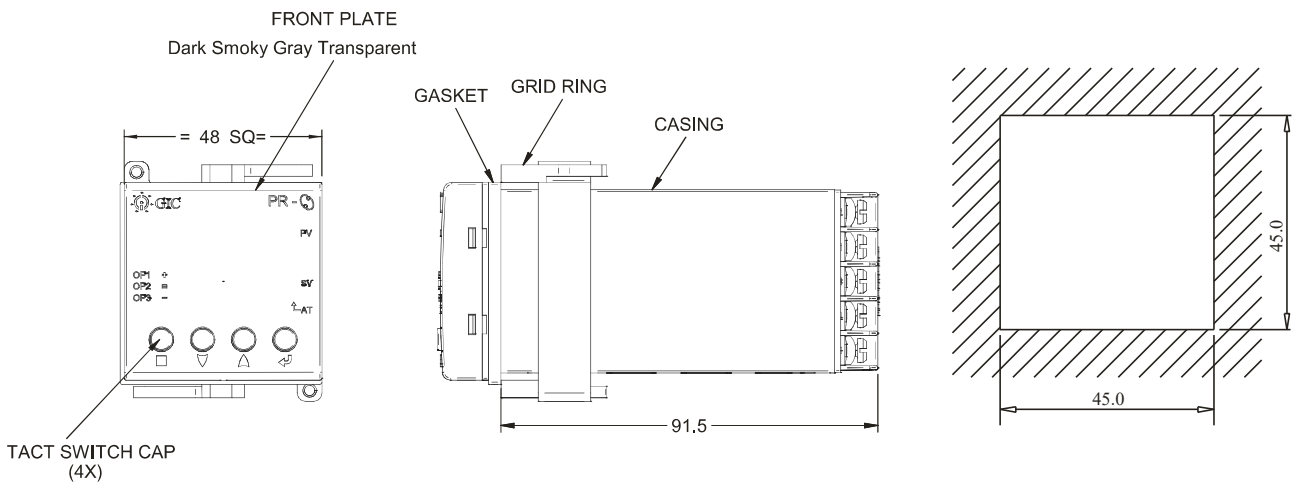

Product Selection Chart - Temperature Controllers

Cat. No.	Flush Mount 96x96 mm	Flush Mount 48x48 mm	Dual Acting PID	Single Acting PID	PID ON/ OFF	Universal Sensor Input	Timer func-tion-ality	J,K and PT100 Sensor	Analog Input (0-5 V, 1-5 V 0-10 V / 4-20 mA)	Configurable Set Points			Output Configuration					RS 485 Comm.
										4	2	1	1 C/O	1 SPST	2 SPST	3 SPST	SSR output (12 VDC, 24 mA)	
151F43B	●		●			●			●	●					●			
151G43B	●		●			●			●	●			●		●	●		
151H43B	●		●			●			●	●				●		●		
151J43B	●		●			●			●	●					●			
151F43B1	●		●			●			●	●				●			●	
151G43B1	●		●			●			●	●			●		●	●		●
151H43B1	●		●			●			●	●			●		●	●		●
151J43B1	●		●			●			●	●				●				●
151F42B	●			●		●	●		●		●			●		●		
151G42B	●			●		●	●		●		●			●		●	●	
151H42B	●			●		●	●		●		●			●		●		
151J42B	●			●		●	●		●		●				●			
151K42B	●			●		●	●		●		●				●			
151L42B	●			●			●	●			●	●		●		●		
151A13B		●	●			●				●				●		●		
151B13B		●	●			●				●			●		●	●		
151C13B		●	●			●				●			●			●		
151D13B		●	●			●				●				●				
151A13B1		●	●			●				●				●			●	
151B13B1		●	●			●				●			●		●	●		●
151C13B1		●	●			●				●			●			●		●
151D13B1		●	●			●				●				●				●
151A12B		●		●		●	●				●			●		●		
151B12B		●		●		●	●				●			●		●	●	
151C12B		●		●		●	●				●			●		●		
151D12B		●		●		●	●				●				●			
151G11B		●						●			●	●						
151H11B		●						●				●			●			
151F11B		●						●				●	●					
151G12B		●			●			●				●	●					
151H12B		●			●			●					●		●			
151F12B		●			●			●					●	●				
151E12B		●		●		●	●					●	●		●			

PT-100 Temperature Control Relay

- Wide operating Supply Range 24V to 240V AC/DC.
- Two analog outputs of 0 to 10V DC.
- Sensor Fault detection (open/short) indication through LED's as well as Analog outputs.
- LED Indications for power ON and relay ON status display.
- Adjustable wide temperature range from -50°C to 300°C through DIP switches.
- Auto/Manual reset mode selectable through DIP switch.
- Relay Normal/Inversion mode selectable through DIP switch.
- High load switching capacity of output up to 10A.

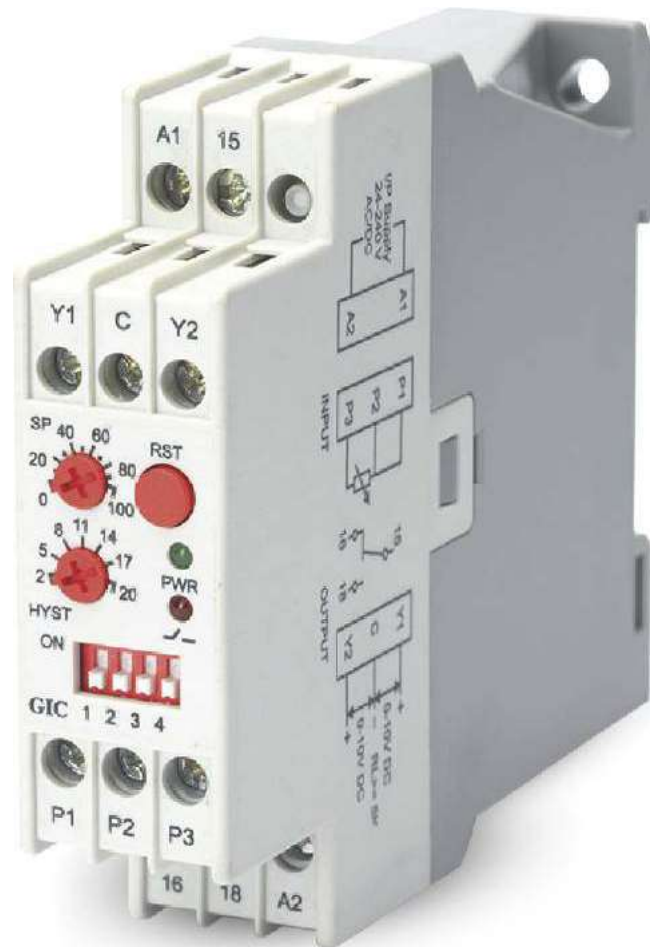



Ordering Information

Cat. No.	Description
47A3D412	24 - 240 VAC/DC, PT-100 Temperature Control Relay, 1C/O (10A), Two Analog Outputs (0-10) VDC

PT-100 Temperature Control Relay



Cat. No.	47A3D412
Parameters	
Supply Voltage	24V to 240V AC/ DC (±15%)
Supply Frequency	50/60Hz
Power Consumption(Max)	For AC <5 VA For DC approx. 1W
Device Characteristics	
Max Lead Resistance Compensated in 3 wire Pt-100 Sensor	10 Ohm per Lead
Max Error in 2 wire Sensor	2.6°C per Ohm
Temperature Trip Accuracy	±1°C
Temperature Drift	Max 0.05°C/°C
Temperature Ranges	-50°C to 50°C, 0°C to 100°C, 100°C to 200°C, 200°C to 300°C
Set Point	0%-20%-40%-60%-80%-100%
Hysteresis	2%-5%-8%-11%-14%-17%-20%
Sensor Fault	Open and Short (Relay OFF)
Sensor Fault Detection Time	<500 ms
Sensor Fault Recovery Time	1.8 to 2 sec.
Output Characteristics	
Contact Arrangement	1 C/O
Contact Ratings	10A @ 250VAC / 30VDC, 4KV Isolation between Coil & Contact.
Utilization Category	AC-15: 3A/250VAC
Response Time(Trip Delay)	min 600 ms to 1 sec
Analog Output Details	
Measured Point (Y1)	(0-10) VDC ± 200 mV
Set Point (Y2)	(0-10) VDC ± 100 mV
In case of sensor Fault (Open/Short) Measured Point output (Y1) is 12VDC.	
Ambient Conditions	
Operating Temperature	-10°C to +55°C
Storage Temperature	-15°C to +60°C
Relative Humidity	5 to 85% RH(non-condensation)
Degree of Protection	IP 20 for terminals & IP 40 for Enclosure
Max. Altitude	2000 m
Pollution Degree	II
Type of Insulation	Reinforced
Certification	 

EMI/EMC Compliance

Harmonic Current Emission	IEC 61000-3-2
ESD	IEC 61000-4-2
Radiated Susceptibility	IEC 61000-4-3
EFT on Supply	IEC 61000-4-4
EFT on I/P & O/P signal	IEC 61000-4-4
Surge	IEC 61000-4-5
Conducted Susceptibility	IEC 61000-4-6
Voltage Dips & Interruptions (AC model)	IEC 61000-4-11
Voltage Dips (DC model)	IEC 61000-4-29
Conducted Emission	CISPR 14-1
Radiated Emission	CISPR 14-1

Safety Compliance:

Dielectric test voltage between I/P & O/P	IEC 60947-5-1
Impulse Voltage between I/P & O/P	IEC 60947-5-1
Single Fault Test	IEC 61010-1
Insulation Resistance	UL 508
Leakage Current	UL 508

Environmental Compliance:

Cold Heat	IEC 60068-2-1
Dry Heat	IEC 60068-2-2
Vibration	IEC 60068-2-6
Non-Repetative Shock	IEC 60068-2-27

PT-100 Temperature Control Relay



SELECTION OF TEMPERATURE RANGE & MODE

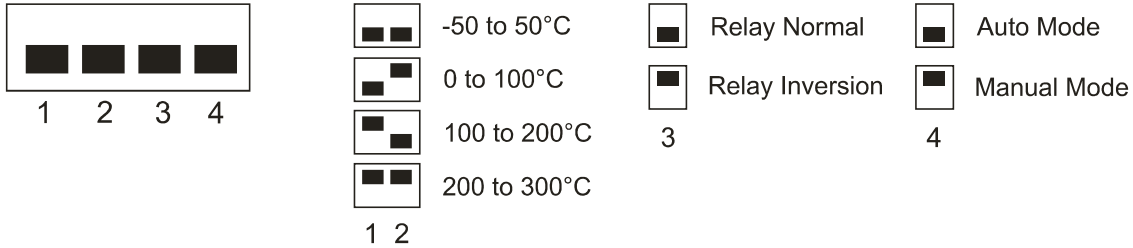

FUNCTION DIAGRAM

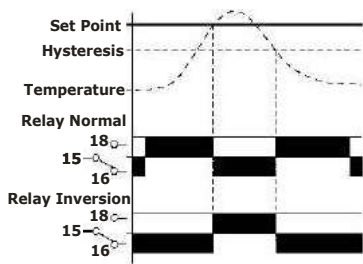

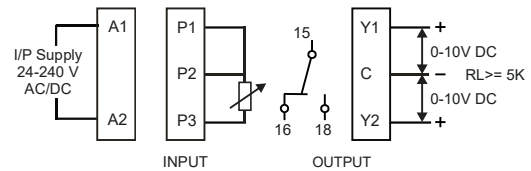

CONNECTION DIAGRAM

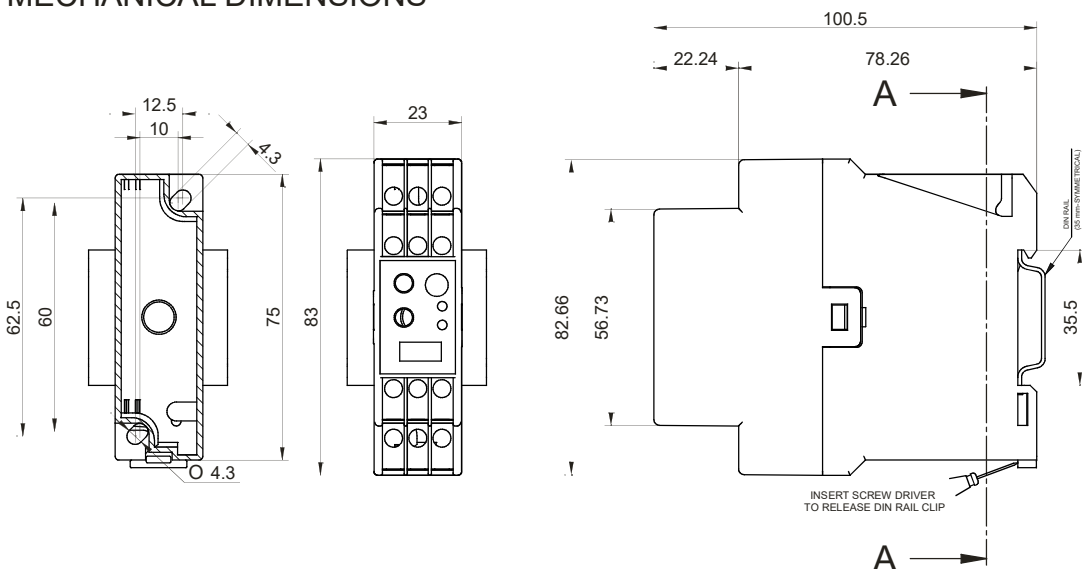

MECHANICAL DIMENSIONS

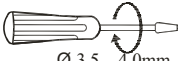

TERMINAL TORQUE & CAPACITY

 Ø 3.5...4.0mm	0.6 N.m (5.3 Lb.in) Terminal screw - M3
	1 x 0.5...6mm ² Solid Wire
WG	1 x 20 to 10

Temperature Control Relay

- Wide ambient Temperature monitoring & controlling range with inbuilt temperature sensor.
- Protection Relay against variations of the ambient temperature set point (StH & StL)
- 3 digit LCD display for Real time Temperature Indication.
- User adjustable offset (-10°C to +10°C)
- LED indication for Relay Trip.





Ordering Information

Cat. No.	Description
41A111AR	110 - 240 VAC, Temperature Control Relay (TCR - 111) Double SP
41A111BR	110 - 240 VAC, Temperature Control Relay (TCR - 112) Single SP

Temperature Control Relay



Cat. No.	41A111AR		41A111BR	
Parameters				
Series nos.	TCR - 111		TCR - 112	
Number of set points	Double SP		Single SP	
Supply Voltage (±)	110 - 240 VAC, -20% to +10%			
Frequency	50/60 Hz			
Power Consumption (Max.)	3 VA			
Device Characteristics				
Sensor	Inbuilt Temperature Sensor			
Temperature Unit	°C			
Display Resolution	0.1°C			
Accuracy	± 3°C Max			
Output Control Mode	Relay ON/OFF			
Hysteresis	2°C (Fixed)			
Temperature measurement and Controlling Range	-10°C to 55°C		-5°C to 55°C	
Set Point Range	Low Level (StL)	-10°C to (StH-4°C)		Internally Fixed to -5°C
	High Level (StH)	(StL + 4°C) to +55°C		0°C to +55°C
Offset	-10°C to 10°C			
Minimum difference between StH & StL (for double SP only)	4°C			
LED Indication	ON - Relay ON condition (Red Color)			
Display Type	Positive Image, Reflective, TN			
Contact Ratings	NO - 5A & NC - 3A @ 250 VAC / 30 VDC Resistive			
Operating Temperature	- 10° C to +55° C			
Storage Temperature	- 20° C to +65° C			
Dimension (W x H x D) (in mm)	18 X 85 X 82			
Weight (unpacked)	70 g			
Mounting	DIN rail			
Certification	 			
Degree of Protection	IP 20 for Terminals, IP 40 for Enclosure			

EMI / EMC

Harmonic Current Emissions	IEC 61000-3-2
ESD	IEC 61000-4-2
Radiated Susceptibility	IEC 61000-4-3
Electrical Fast Transients	IEC 61000-4-4
Surge	IEC 61000-4-5
Conducted Susceptibility	IEC 61000-4-6
Voltage Dips & Interruptions (AC)	IEC 61000-4-11
Conducted Emission	CISPR 14-1
Radiated Emission	CISPR 14-1

Environmental

Cold Heat	IEC 60068-2-1
Dry Heat	IEC 60068-2-2
Vibration	IEC 60068-2-6
Repetitive Shock	IEC 60068-2-27
Non-Repetitive Shock	IEC 60068-2-27

Temperature Control Relay



FUNCTION DIAGRAM

Double SP - 41A111AR:

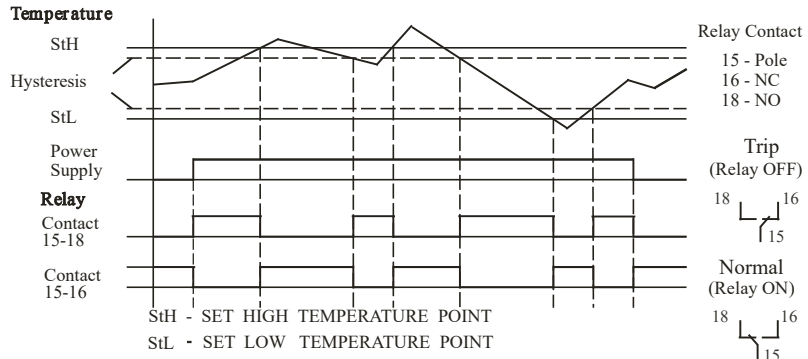

Single SP - 41A111BR:

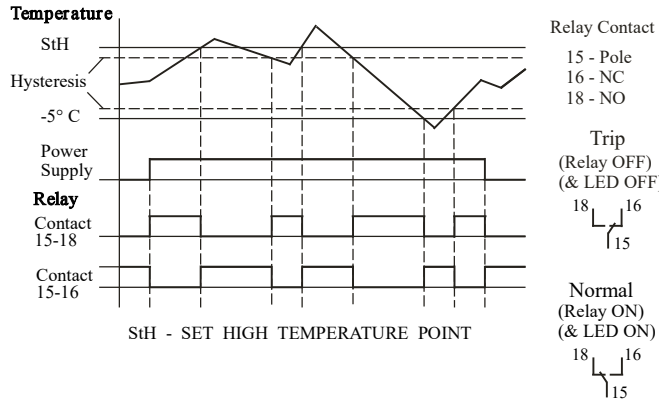

MOUNTING DIMENSIONS (mm)

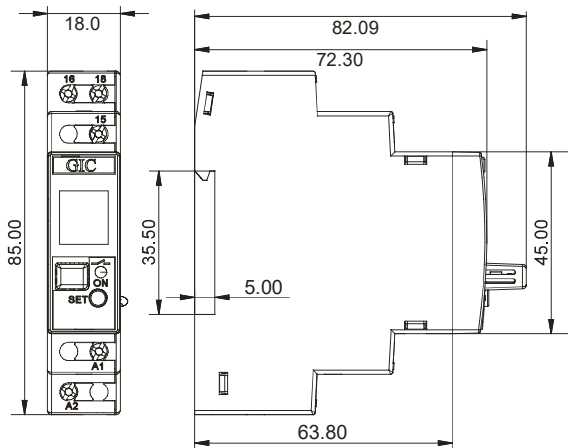

CONNECTION DIAGRAM

SUPPLY CONNECTION

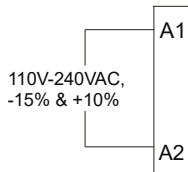

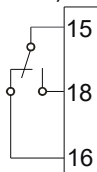

SPDT Relay CONNECTION

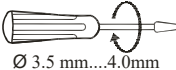

NO-5A & NC-3A@
250VAC/30VDC RESISTIVE

TERMINAL TORQUE & CAPACITY

 Ø 3.5 mm...4.0mm	0.60 N.m (5.3 Lb.in)
	1 x 4.0 mm ² Solid/Stranded Wire
AWG	1 x 20 to 10



PROCESS INDICATORS

.....
Process Indicators
.....

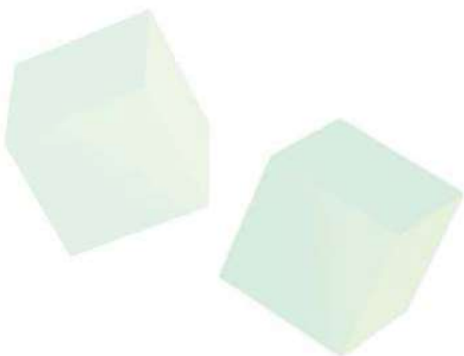

Process Indicators

- Flush Mounting Version 96X48 mm with 7 segment display
- Thermocouple (J, K, T, R & S) / RTD 3-wire (Pt-100) sensor inputs
- Analog Inputs (0-10 VDC / 0-20mA / 4-20mA), mV (Linear) - 5 to 56mV
- Alarm Outputs, Analog (0-20mA/ 4-20mA or 0-10V/ 0-5V) & Relay 5A for alarm indication
- Configurable Band, Deviation Alarms
- °C & °F temperature unit selectable
- Short depth of 65 mm
- RS 485 Communication
- IP 20 (For terminal and enclosure) & IP 55 (For Front Panel only)



Ordering Information

Cat. No.	Description
PIA200	180-270 VAC, Process Indicator, Analog Input (0-10 VDC / 4-20 mA)
PIT200	180-270 VAC, Process Indicator, Thermocouple & RTD input
PIB110	85-270 VAC/DC, Process Indicator, Analog Input (0-10 VDC / 4-20 mA), Thermocouple & RTD Input, 24 VDC sensor supply
PIB120	85-270 VAC/DC, Process Indicator, Analog Input (0-10 VDC / 4-20 mA), Thermocouple & RTD Input, Alarm Outputs - Analog (0-10 V / 0-5 V, 0-20 mA / 4-20 mA) & Relay 5A for alarm indication, 24 VDC sensor supply
PIB12C	85-270 VAC/DC, Process Indicator, Analog Input (0-10 VDC / 4-20 mA), Thermocouple & RTD Input, Alarm Outputs - Analog (0-10 V / 0-5 V, 0-20 mA / 4-20 mA) & Relay 5A for alarm indication with RS-485 Modbus communication, 24 VDC sensor supply

Process Indicators



Cat. No.	PIA200	PIT200	PIB110	PIB120	PIB12C
Parameters					
Supply Voltage (±)	230V AC, ± 20%		85 to 270V AC/DC		
Frequency	50/60 Hz				
Temperature Sensors/ Inputs	Current, Voltage	Thermocouples: J, K, T, R, S RTD (Pt100) (2 wire & 3 wire)	Thermocouples: J, K, T, R, S RTD input (2 wire & 3 wire) Analog inputs: mV, Current, Voltage		
Measurement Ranges	Voltage : 0 to 10VDC Current : 0 to 20mA and 4 to 20mA	PT100 : -200 to 850 J : -200 to 750 K : -200 to 1350 T : -200 to 400 R & S : 0 to 1750	PT100 : -200°C to 850°C J : -200°C to 750°C K : -200°C to 1350°C T : -200°C to 400°C R & S : 0°C to 1750°C Analog Inputs: Voltage : 0 to 10VDC Current : 0 to 20mA, 4 to 20 mA mV (Linear) : - 5 to 56mV		
Resolution	Decimal point position selectable: Current: 1 / 0.1 / 0.01 / 0.001 Voltage: 1 / 0.1 / 0.01 / 0.001	J, K, T, PT-100: 1°C / 0.1°C R & S: 1°C	J, K, T, PT-100: 1°C / 0.1°C R & S: 1°C Analog Input: 1° / 0.1° / 0.01 / 0.001	J, K, T, PT-100: 1° / 0.1° R & S: 1° Decimal point position selectabel for analog input: Voltage: 1 / 0.1 / 0.01 / 0.001 Current: 1 / 0.1 / 0.01 / 0.001	
Temperature Unit	N.A		°C / °F (User selectable)		
Error Indications	Sensor break, Over range and Under range				
Display	4 Digit, 7 Segment display, Red color				
Keypad	4 keys for digital setting				
Alarm output 1	N.A		NO & NC 5A @ 250VAC/ 24V DC (SPDT)		
Alarm output 2	N.A				
Analog DC output	N.A		Re-transmission : Current: 0 to 20mA/ 4 to 20mA or Voltage: 0 to 10V/ 0 to 5V		
Analog output update rate	N.A		100 msec.		
Alarm types	N.A		Absolute (High/Low/Band), Deviation (High/Low/Band)		
Sensor supply			24 VDC		
Operating Temperature	0°C to 50°C (32°F to 122°F)				
Storage Temperature	-20°C to 75°C (-4°F to 167°F)				
Humidity (Non-condensing)	95% RH (non-condensing)				
Enclosure	Flame Retardant UL94V0				
Dimensions (W x H x D) (in mm)	96 x 48 x 70.6				
Weight (Unpacked)	64g				
Mounting	Flush / Panel Mounting				
Certification					
Degree of Protection	IP 20 Terminal & Enclosure, IP 55 for Front plate				

EMI / EMC

Harmonic current emissions	IEC 61000-3-2
ESD	IEC 61000-4-2
Radiated Susceptibility	IEC 61000-4-3
Electrical Fast Transients	IEC61000-4-4
Surge	IEC61000-4-5
Conducted Susceptibility	IEC 61000-4-6
Voltage Dip (AC) & Short interruptions	IEC 61000-4-11
Conducted Emission	CISPR 11
Radiated Emission	CISPR 11
Voltage Fluctuations and flicker	IEC 61000-3-3

Safety Compliance:

Test Voltage	IEC 60255-5
Impulse voltage	IEC 60255-5
Single Fault	IEC 61010-1
Insulation Resistance	UL 508, > 100MΩ
Leakage Current	UL 508, < 3 mA

Environmental

Cold Heat	IEC 60068-2-1
Dry Heat	IEC 60068-2-2
Component Temperature Rise	IEC 61010-1

Process Indicator Series



CONNECTION DIAGRAM

PIB12C

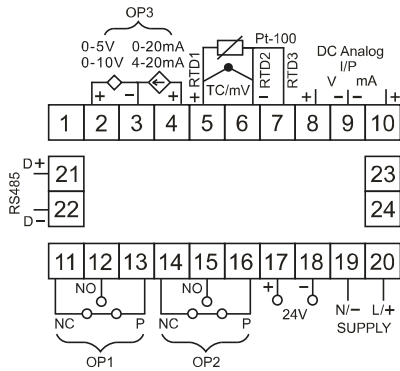

PIB120

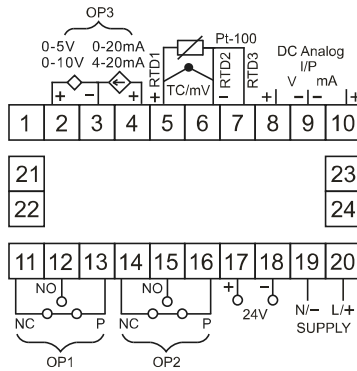

PIB110

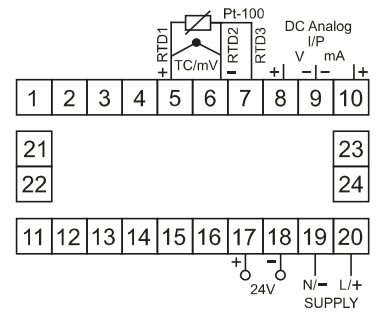

PIT200

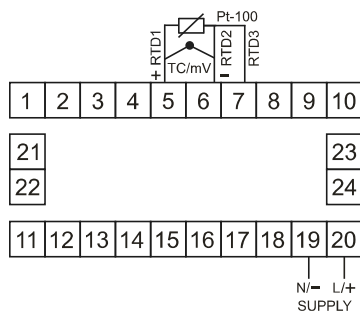

PIA200

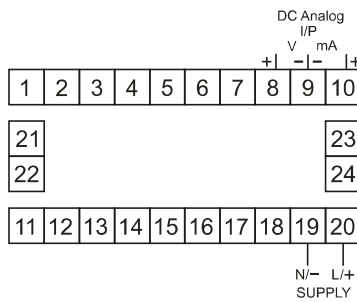

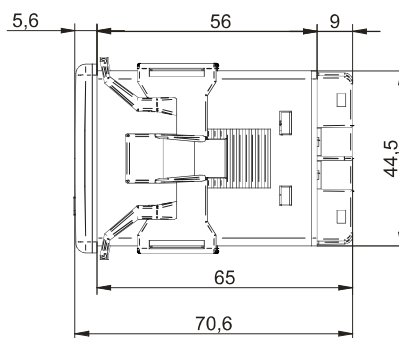
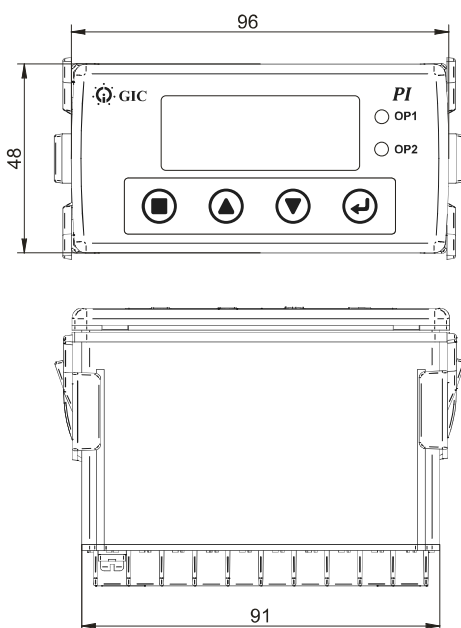

MOUNTING DIMENSION (mm)

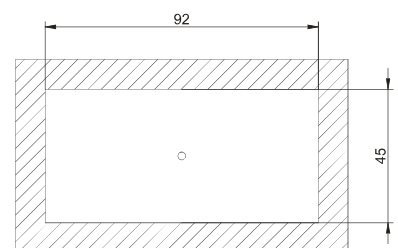

Panel Cutout

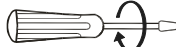

TERMINAL TORQUE & CAPACITY

 Ø 4 5.0mm Combi Head Bit/Flat	0.5 N.m (4.4 Lb.in) to 0.7 N.m (6.2 Lb.in)
	2 x 2.5 mm ² Solid/Stranded Wire
AWG	1 x 20 to 12



ALARM ANNUNCIATORS

.....
2-48 Windows Alarm Annunciators
.....

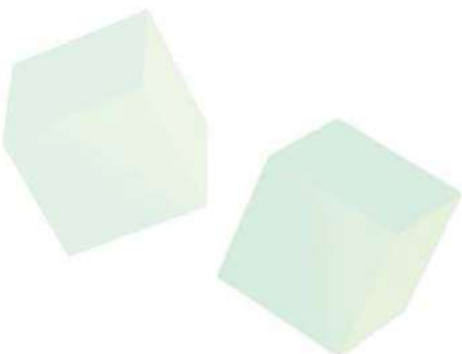

Alarm Annunciators

- Standard models available from 2 to 48 windows
- Choice of 3 window sizes and 6 different window colours
- Optically isolated fault inputs with wide fault input voltage range (12 - 240V AC/DC +/-10%)
- Field selection for NO / NC fault input contacts, grouping of alarms, window size configuration
- Space saving due to lower depth of only 100mm
- Integral push buttons for Test, Acknowledge, Mute and Reset operations
- Four SPDT relay outputs (2 for grouping, 1 for external hooter, 1 for ring back sequence)
- 7 Field selectable operation sequences as per ISA standard
- Integral buzzer for audible alarm output of 80 dB
- Communication interface with RS485 Modbus RTU protocol
- Replaceable LEDs, Fast Scan, Manned / Unmanned, Supervisory Relay & Supply fail annunciation available



Working Principle

Whenever there is a change of input contacts from Normally Open to Close or from Normally Close to Open position, annunciator changes from rest condition to alarm condition.

Hence there is an immediate recognition of fault input which will have a corresponding visual and audio alarm as per the particular selected program sequence.

The base unit of alarm annunciator has four programmable keys for Mute, Acknowledge, Reset & Test function. On pressing the Mute key the internal buzzer can be deactivated. Acknowledge key is used to accept the fault condition, Reset key enables to reset the alarm annunciator to its default state and Test key helps to perform the complete test of the system.



Technical Specifications

Parameters	Fast Scan	Normal Scan
Supply Voltage (Φ)	90 - 270 V AC/DC or 18 - 60 V DC	
Supply Frequency (AC)	50/60 Hz	
LED Indication (Green)	ON - Healthy / Manned Mode	ON - Healthy
	Blinking - Unmanned Mode [Slow Blinking Rate - 300msec ON, 3sec OFF] Blinking - Error [Fast Blinking Rate - 500msec Cyclic ON/OFF] Error: 1) User selected wrong windows configuration 2) Slave Communication error	Blinking - Error [Fast Blinking Rate - 500msec Cyclic ON/OFF] Error: 1) User selected wrong windows configuration 2) Number of windows are more than number of fault inputs.
No. of Windows	2 to 48 windows in different configurations	
Window Size	Small: 34x31mm, Medium: 68x31mm, Large: 68x63mm	
Window Colour	Red, Yellow, Blue, Green, Amber and White	
Illumination	Low power super bright white LEDs (replacable LEDs available)	Low power super bright white LEDs
Fault Input Signal	Potential free (NO/NC field selectable)	
Fault Input Voltage	Internal: 12V DC (Potential free)	Internal: 12V DC / External: 12V-270V AC/DC
Scan Time	10 msec	100 msec
Flash Rate	1) Fast flash - 0.5 Sec ON / 0.5 Sec OFF (60 flashes/Min) 2) Slow flash - 0.5 Sec ON / 1.5 Sec OFF (30 flashes/Min)	
Terminal	Pluggable terminal blocks for conductor up to 2.5mm ²	
Output Relay Contact	4 C/O Relays (2 for grouping + 1 for external hooter + 1 for Ring back sequence)	
Relay Contact Rating	NO - 5A / NC - 3A @250V AC & NO - 5A / NC - 3A @ 30V DC (resistive), (Relay Actuation time 10 to 130ms after signal detection)	NO - 5A / NC - 3A @ 250V AC & NO - 5A / NC - 3A @ 30V DC (resistive), (Relay Actuation time 130ms after signal detection)
Audible Alarm Output	80 dB at 1 metre distance (In-built configurable Buzzer)	
Facia Type	Individual window lens, replaceable from front.	
Alarm Sequences	As per ISA standard (Field configurable) 1) Manual Reset (M-1) 2) Auto Reset (A-1) 3) Ring Back (R-1-12) 4) Auto Reset with No-lock(A-1-4) 5) Manual reset first out with no subsequent alarm flashing and silence push button (F2M-1) 6) Auto reset first out with no subsequent alarm flashing and silence push button (F2A-1) 7) Manual Reset (M-2) [Applicable for Fast Scan Module]	
Push Button Controls	Integral Push buttons for Test, Mute, Acknowledge and Reset functions. Provision of output connections for remote access of push buttons.	
Communication Port	Computer interface with RS 485 Modbus RTU protocol.	
Operating Temperature	-10°C to +55°C	
Storage Temperature	-15°C to +60°C	
Humidity	95% R.H.	
Mounting Type	Panel Mounting	
Certification		
Degree of Protection	Front panel IP40, Rear panel IP20	

EMI / EMC Compliance

Harmonic Current Emissions
ESD
Radiated Susceptibility
Electrical Fast Transient

IEC 61000-3-2 Class A
IEC 61000-4-2 Level II Class A
IEC 61000-4-3 Level III Class A
IEC 61000-4-4 Level III (Power Supply and Input Signal with external supply),
IEC 61000-4-4 Level III (Capacitive coupled on Input Signal and Remote keys with internal 12V supply),
IEC 61000-4-4 Level II (Capacitive coupled on Communication)
IEC 61000-4-5 Level IV (Power supply and Input Signal with external supply)
IEC 61000-4-6 Level III Class A
IEC61000-4-11 All VII Level Pass
CISPR 11 / CISPR 14-1 Class A
CISPR 11 / CISPR 14-1 Class A

Surge
Conducted Susceptibility
Voltage Dips and Interruptions(AC)
Conducted Emission
Radiated Emission

Safety Compliance

Test Voltage Between I/P and O/P
Impulse Voltage Between I/P
And O/P
Single Fault Test
Insulation Resistance
Leakage Current
Pollution Degree

IEC 60255-5, 2.5kV, 50Hz, 1Min
IEC 60255-5, 5kV, 1.2/50us, 0.5J





IEC 61010-1
UL 508 > 50 kΩ
UL 508 < 3.5 mA
II

Environmental Compliance

Cold Heat
Dry Heat
Vibration

IEC 60068-2-1
IEC 60068-2-2
IEC 60068-2-6, 10 to 55Hz

Ordering Information

	Cat. No.	Product Size	No. of Windows	Window Size	Keys
	AU1D8S	1D	8	Small	Small
	AU1D6SP	1D	6	Small	Big
	AD1D8S	1D	8	Small	Small
	AD1D6SP	1D	6	Small	Big
	AU2D16S	2D	16	Small	Small
	AU2D14SP	2D	14	Small	Big
	AD2D16S	2D	16	Small	Small
	AD2D14SP	2D	14	Small	Big
	AU3D24S	3D	24	Small	Small
	AU3D22SP	3D	22	Small	Big
	AD3D24S	3D	24	Small	Small
	AD3D22SP	3D	22	Small	Big
	AU4D32S	4D	32	Small	Small
	AU4D30SP	4D	30	Small	Big
	AD4D32S	4D	32	Small	Small
	AD4D30SP	4D	30	Small	Big

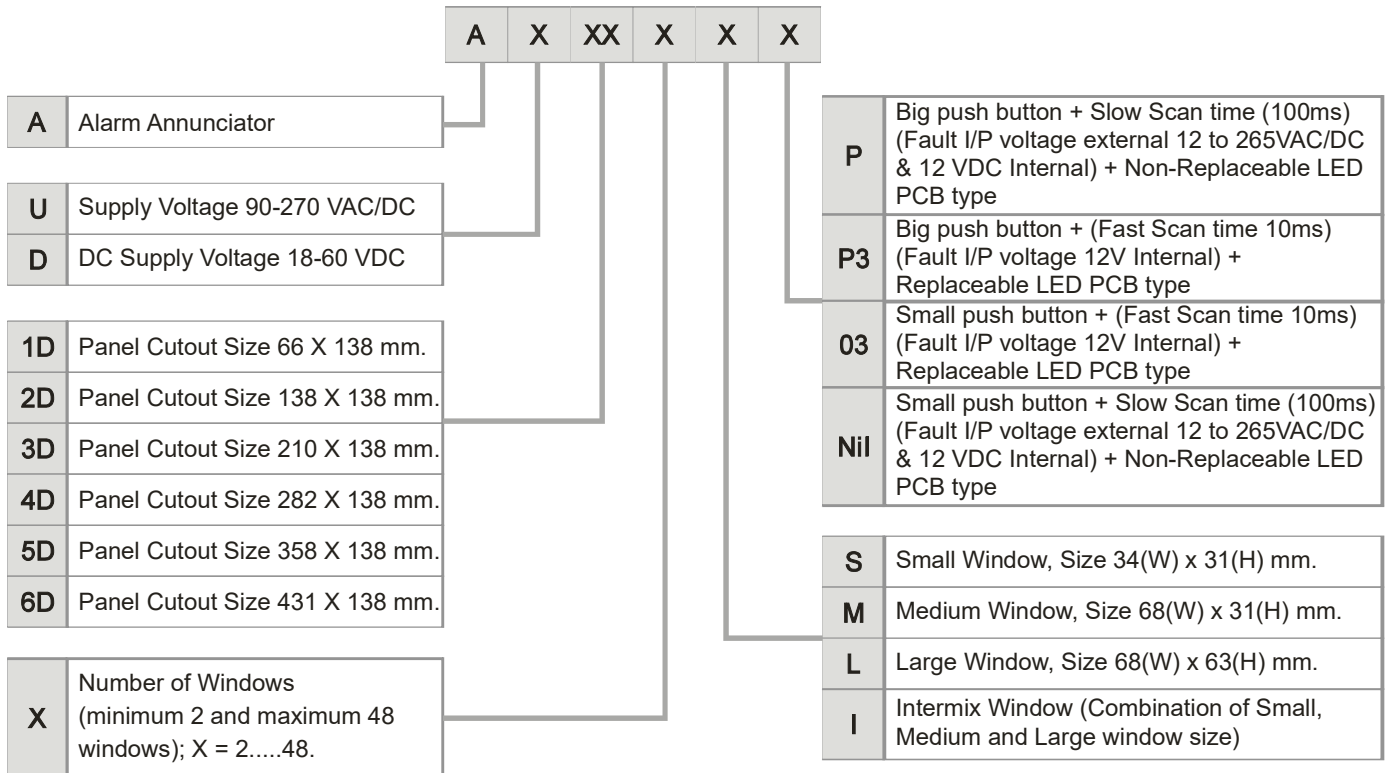

Product Ordering code

Note 1 : For other customised products, use live product configurator available on our website to generate part number & enquiry request form: www.gicindia.com

Note 2 : Legend templates are available on our website : www.gicindia.com

MOUNTING DIMENSIONS (mm)

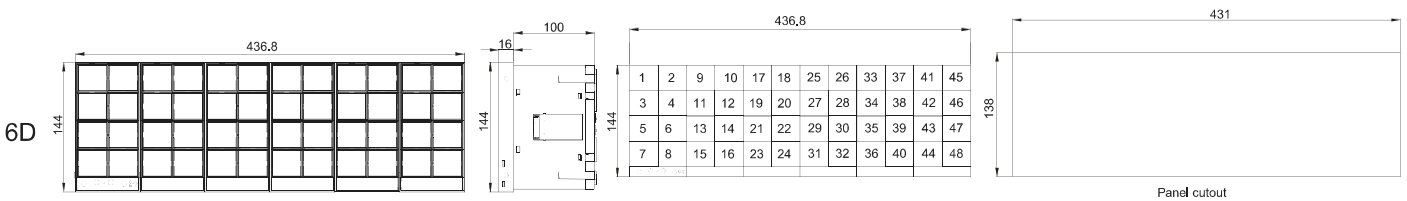
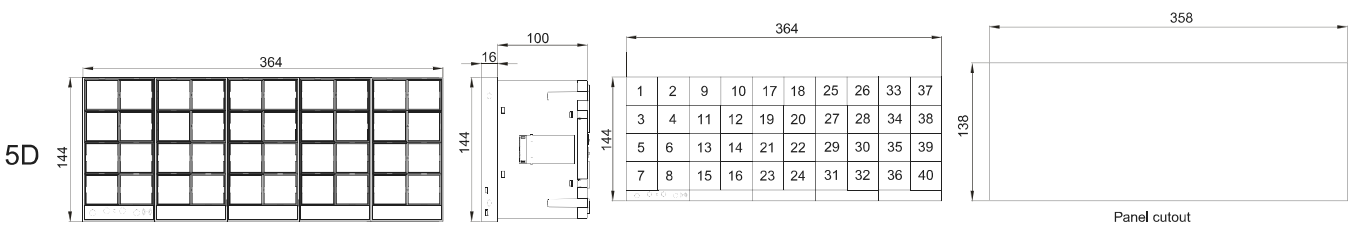
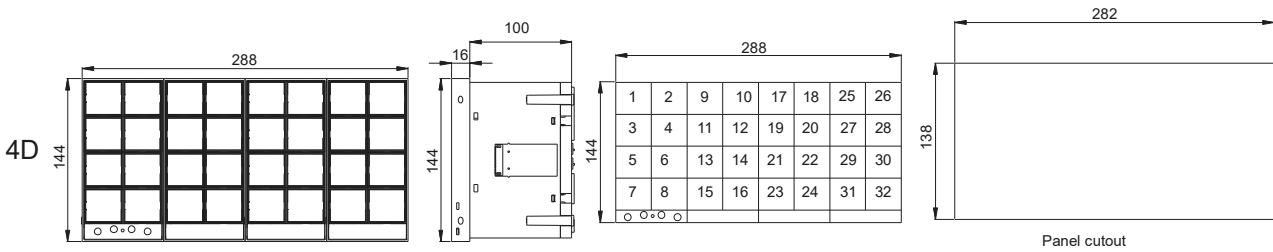
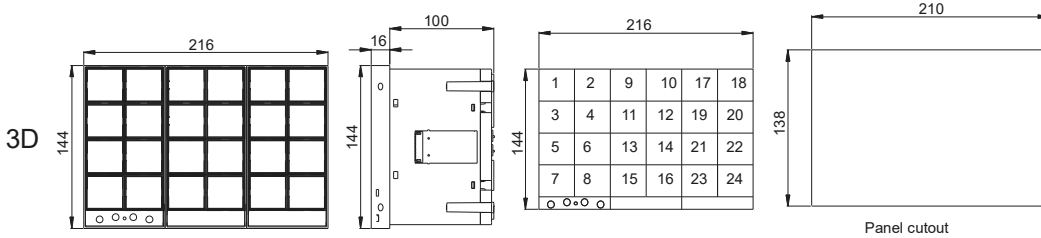
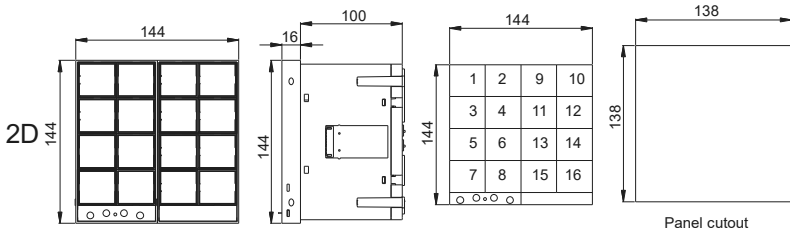
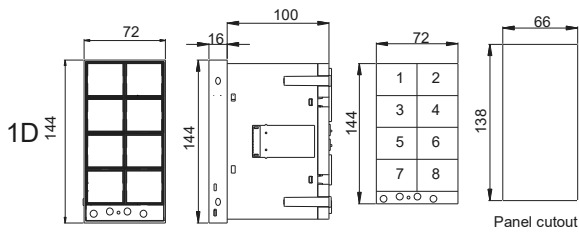

Weight with box (approx.): 1D=580g, 2D=950g, 3D=1320g, 4D=1690g, 5D=2060g, 6D=2430g

CONNECTION DIAGRAM

Fast Scan

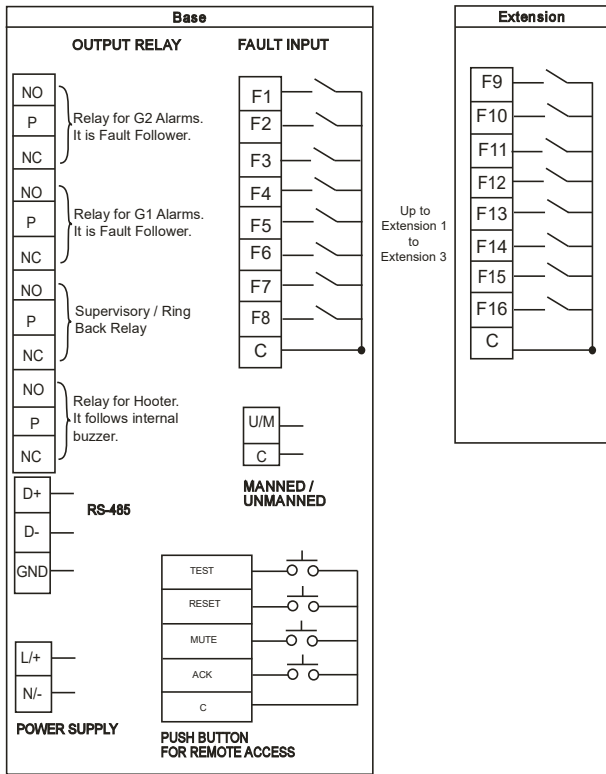

Normal Scan

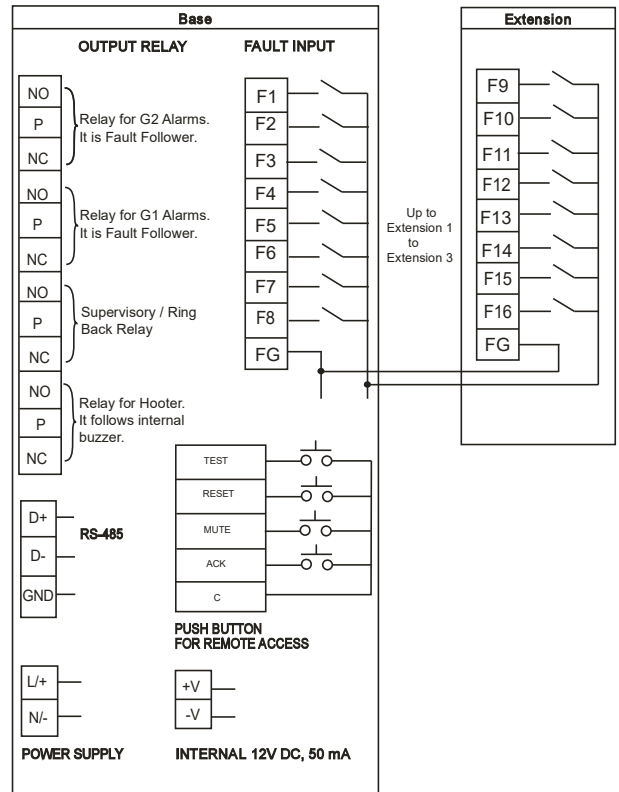

Terminal Connection: For Output Relay, Fault Input, Remote Keys,
 Power Supply Connection: AWG 28 to 12, Ph1- 3.5mm, Torque 0.5Nm(4.5lb.in)
 For Internal 12V supply, RS485 Connection: AWG 28 to 16, Flat- 2.5mm, Torque 0.2Nm(1.77lb.in)

WARRANTY POLICY

All the products sold carry a warranty, against manufacturing defects for a period of 24 months from the date of manufacturing.

Should the product prove to be defective due to faulty workmanship or otherwise, we will remedy the defect or replace the faulty parts or the whole product at our discretion, as soon as possible, free of cost.

In no event shall the responsibility of GIC for any act exceed the individual price of the product on which the liability is asserted.

The warranty is however subject to the provision of proper usage, efficient maintenance and does not cover defects arising out of fire, accident, inefficient maintenance, faulty operation and willful or accidental damage. It also does not cover damage to power electronic components like Thyristors, IGBTs etc. which fail predominantly due to over temperature or over voltage. The user needs to take adequate precautions to eliminate these conditions. GIC shall not be liable for any consequential loss, injury or damages attributable to defect or failure of its products.

*Proof of Purchase to be retained to avail warranty.

Note:

- Innovation being a continuous process, design and specifications are subject to change without prior notice.
- User is recommended to ensure the suitability of the products for intended application.
- GIC is not responsible for consequential damage out of use of its products.