

# Vehicle Hard Top Lift Aid

**EZTRUNK™ ASSEMBLY**

# MANUAL

**#1900 0074**

## MAKE IT EZ

**Print the latest manual &  
Watch the Video**



**Scan QR CODE for Video &  
PDF MANUALS**



## Customer Service

*Any question? WE ARE HERE TO HELP!*

**Text or Call 203-901-0055 / Call 203-591-9060**











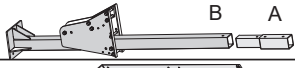
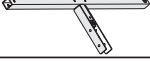



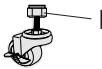

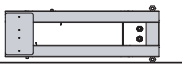
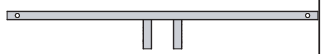







**EMAIL US: SERVICE@EZTRUNK.NET**

*7 days a week 8:30 am EST*

## WE CAN HELP YOU!

PO# :

**Please read instructions fully before beginning assembly**

NO	Illustration	Description	Part#	QTY.
1		Upright Pillar	19007401	1
2		Base Tube Long Side	19007402	1
3		Base Middle Tube	19007403	1
4		Base Tube Short Side	19007404	1
5		Pillar Base Plate	19007405	1
6		Wheel with Nut	19007406	4
7		Slanted Tube	19007407	1
8		Top Front Rail	19007408	1
9		Top Support	19007409	1
10		Top Back Rail	19007410	1
11		Handle Bar	19007410	1
12		Hand Crank	19007412	1
13		Bracket for Top Support	19007413	1
14		Small Metal Washer	15801	13
15		Big Metal Washer	18101	3
16		Rubber Stopper Screw	19007414	6
17		Bolt M8x65	08652	3
18		Bolt M8x70	08702	7
19		Bolt M8x75	08752	1
20		Lock Nut M8	10082	13
21		Lock Nut M10	10102	3
22		Hex Head Bolt Set M10x65	10652	3
23		Hex Head Bolt M8x20	08203	2
24		Locking Pin	28720	2
25		Pull Pin	18600	1
26		#5 Allen Wrench	#5	1
27		Wrench	#1317	2

# BEFORE BEGINNING, SEE THE ASSEMBLY INSTRUCTION VIDEO ON [EZTRUNK.NET](http://EZTRUNK.NET)

**1**

19007401  
19007402 Base tube long side  
19007403  
19007404 Base tube short side  
19007405  
19007406

Component parts for Base.  
Lay all parts on floor as shown in diagram to start assembly.

**2**

10082  
19007406

Install the wheels to 2 Base tubes.

**3**

19007403  
19007404  
Short  
wider  
08652  
10082

Install Middle Tube to Base Short Side with 2 bolts and nuts.

**4**

19007402 Base tube long side  
19007401  
19007402 Base tube long side  
10652  
19007405  
10102

Install Upright Pillar to Base Long Side.  
Attention: Wheels side is bottom side, upright pillar is upper side.

**5**

19007402 Base tube long side  
28722  
08752  
10082

Install Middle Tube to Base Tube Long Side, Keep bolt head same as other side of middle tube. Don't over tighten the bolt.

**6**

08702  
19007407  
10082

Install Slanted Tube to sliding bracket. Install 4 Bolts to hole first and after tightening the 4 Nuts to the bolts.

# BEFORE BEGINNING, SEE THE ASSEMBLY INSTRUCTION VIDEO ON [EZTRUNK.NET](http://EZTRUNK.NET)

**7**

Install Part #A to upright pillar #B with bolts # 08652 and nuts. Install Handle Bar and Hand Crank to Upright Pillar #A with bolts #08702 and nuts. IMPORTANT: Keep the gear of Winch on low side. TIP: Use a paper tape to attach a nut on wrench for lower bolt.

**8**

Install Front Rail and Rear Rail to Support part. Make Sure the REAR HOLE location first and install rear rail. Install bracket bar to top support with Bolt #08203.

**9**

Install the Top Support set to slanted tube. Keep the plate locked with Pin all the time when stands.

**10**

Remove nut from Hand Crank and install crank handle and nut to gear winch if necessary.

**11**

Put the pipe in the loop of webbing. Install the pipe in the sliding bracket.

**12**

Install the Pull Pin in hole on sliding bracket. Assembly completed.



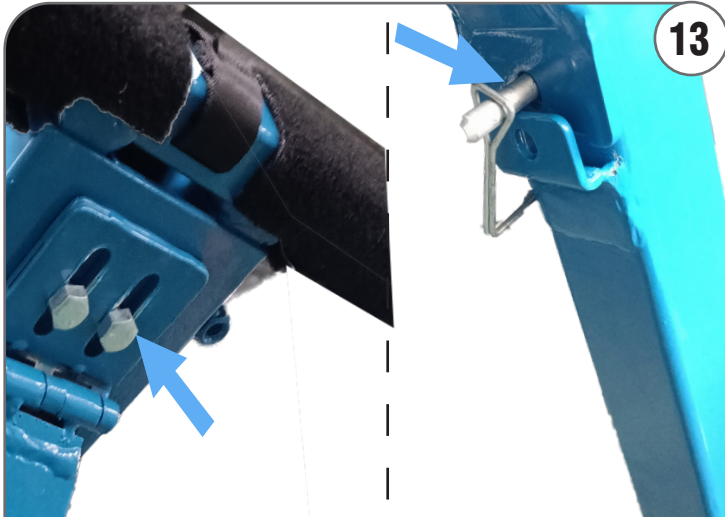

**13**

You can adjust the top support ground level with (2) bolts on top or second hole on slanted tube.  
When storing the Hard Top Lift Aid, roll down to the lowest height possible. Keep away from children's reach at all times.

**Lifting Hard Top**

**14**



Drive vehicle on even ground.  
Remove the Bolts from vehicle Hard top bottom edge.  
Take off the freedom Hard tops. Disconnect the wire cable, open the rear doors.



**15**

Install Rubber stopper screws into top rails if necessary.



**16**

Push Lift in the vehicle, set the support close middle of hard top.



**17**

Slide front rail forward until it reaches correct position. Adjust rubber stopper screws so that top support bars touch the roof with rubber stoppers evenly supporting the top.



**18**

Hook both webbing to rear window hinge bracket and pull the webbing tight. Lift the Hard top off the vehicle.  
Do the opposite steps to load the hard top on the vehicle. You can push the hard top to assist align the pin to hole from hard top to vehicle. Release 2 webbing straps when the hard top set on.

**Folding Option**

**19**

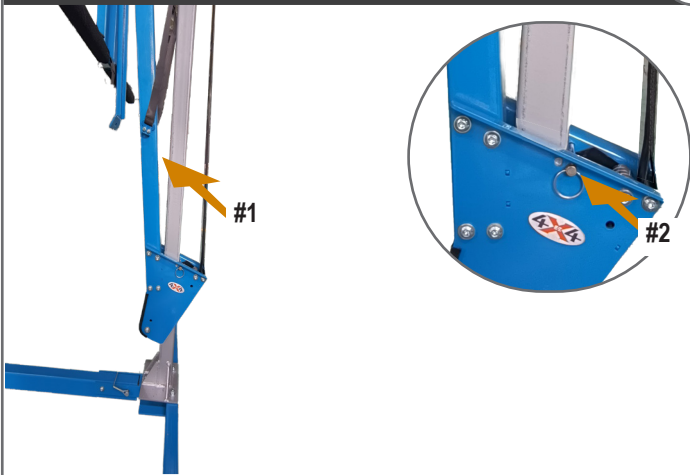

Remove the Pull Pin from Sliding Bracket. Fold the slanted tube to upright pillar (Photo #1). Install the pull pin in hole #2 (Photo #2). Roll down the Sliding Bracket to bottom.

**Folding Option**

**20**



Store the locking pin in hole on slide bracket. Use the Webbing with Hook bind the slanted tube and secure the webbing tight.

**Folding Option**

**21**

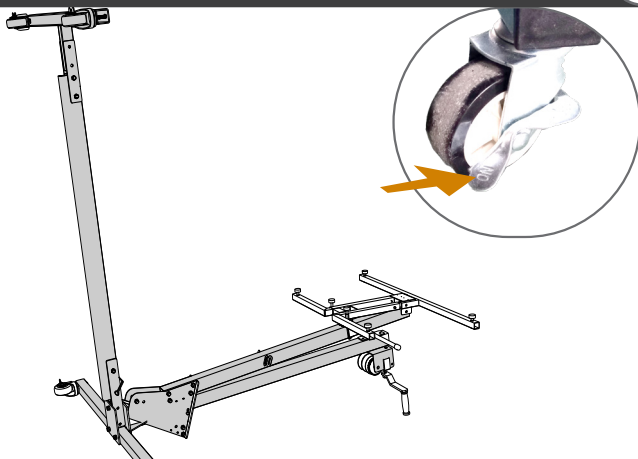

Lock the wheels.  
Fold Lift Aid upright Pillar to the ground

**Folding Option**

**22**

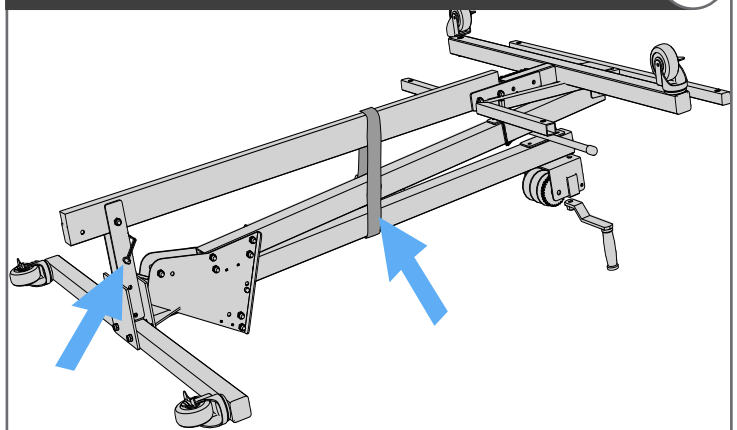

Fold down the Middle Tube and install the Locking Pin back the previous hole. Use the Webbing with Hook bind the Middle Tube and secure the webbing tight.

**Folding Option**

**23**



**CAUTION:** The Hard Top Lift Aid should be secured to a wall or placed in a safe area when in upright folded position. Can cause injury and/or damage if it should fall.

# Customer Service

*Any question? WE ARE HERE TO HELP!*

**203-901-0055 / Call 203-591-9060**  
**EMAIL US: [SERVICE@EZTRUNK.NET](mailto:SERVICE@EZTRUNK.NET)**

*7 days a week 8:30 am EST*

**WE CAN HELP YOU!**