

# JL 2018 & UP 2 DOOR

## **EZ WINDOW** ASSEMBLY

# MANUAL

#1918 0044

## MAKE IT EZ

Print the latest manual &  
Watch the EZWINDOW Video  
Part #1918 0044



Scan QR CODE for  
Video & PDF MANUALS

## READ FIRST

There are many variations of Jeeps, soft tops, hardtops, and those with & without speakers.

When **INSTALLING**, if your **EZTRUNK** or **EZWINDOW** doesn't fit due to your Jeeps' variations, please call us.

**WE HAVE THE COMPONENTS TO MAKE IT WORK PROPERLY.** We also offer help with installations via FaceTime, Skype, cell, or any other way you would like to get the install done quickly.



## Customer Service

*Any questions? WE ARE HERE TO HELP!*

**Text or Call 203-901-0055 / Call 203-591-9060**

**EMAIL US: SERVICE@EZTRUNK.NET**











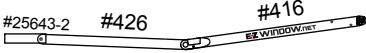

7 day a week 8:30 am EST

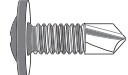
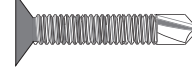
**DO NOT RETURN, WE CAN HELP YOU!**

PO# :

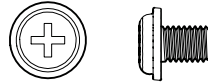
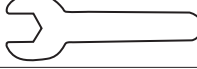
**MAKE IT EZ: CHECK OUT THE ASSEMBLY INSTRUCTION VIDEO - USE QR CODE**

**Please read instructions fully before beginning assembly**

NO	Illustration	Description	Part #	QTY.
1		Clamps For Roll Bar	25643-1B	2
2		Support Bar For Driver Side	53416B	1
3		Support Bar For Passenger Side	53417B	1
4		Plastic Bracket For Driver Side	189004	1
5		Plastic Bracket For Passenger Side	189003	1
6		Metal Plates	15900	2
7		Metal Plate Bolts M5x30	55301	4
8		Self-drill Screws	4122	2
9		Self-drill Screws	4322	5
10		Clamp Lock Nuts M6	10062	2+1 extra
11		Pins	25641	2
12		Velcro Straps	251802	2
13		Roll Bar Clamp Screws	66041	2+1 extra
14		Wrench	#10	1
15		Corrugated Pins	24811	2+1 extra
16		Bungees w/ Hooks	5001	2
17		Rubber Cap For Clamp Bolt	M6	1 extra

**MAKE IT EASY: CHECK OUT THE ASSEMBLY INSTRUCTION VIDEO - USE QR CODE**

**1**

#55301      #15900



#189004 Driver side      #189003 Passenger side

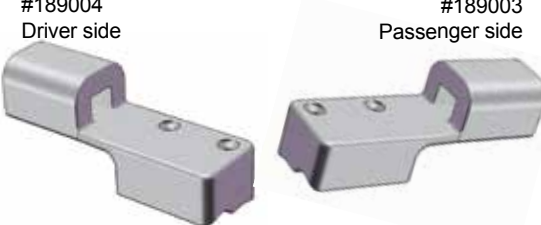

**2**

**Driver side**

#15900  
window rear bar

Drop metal plate inside groove of window rear bar.



Remove window rear bar



**3**

**Driver side**  
**WINDOW REAR BAR WITH OPEN SLOT**

#55301

#189004 Driver side

Line up part 189004 as close as you can to the first ridge



#189004 Driver side

#15900  
window rear bar



**DO NOT USE POWER TOOLS**

**4**

**Driver side**  
**WINDOW REAR BAR WITHOUT OPEN SLOT**

#4322

#189004 Driver side

Line up part 189004 as close as you can to the first ridge



#189004 Driver side

window rear bar



**Follow instructions to install the left & right sides**

**5**

#4122



1. Remove rear window from Jeep  
2. Use self-drill screw to make a hole 1/2" from the side  
3. Drill a hole on each side of the rear window



**6**

#5001

#24811



**MAKE IT EASY: CHECK OUT THE ASSEMBLY INSTRUCTION VIDEO - USE QR CODE**

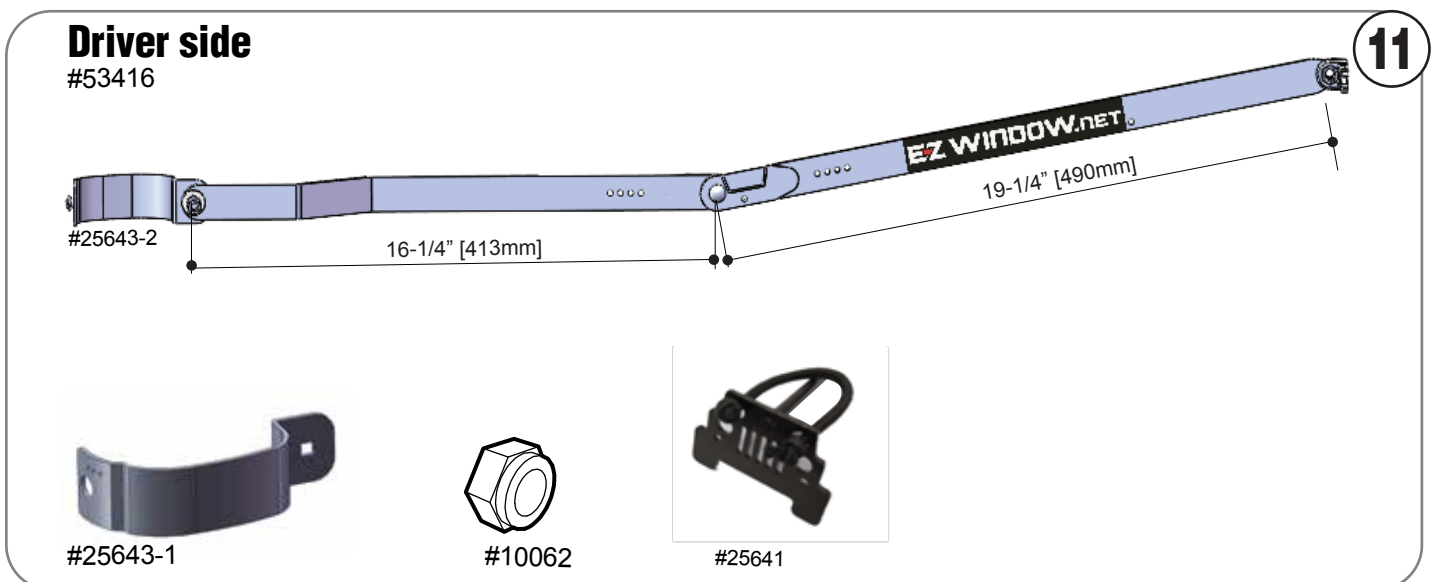
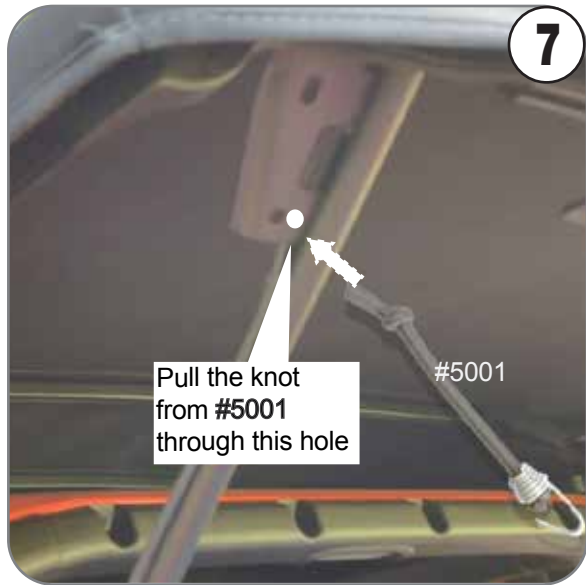

**MAKE IT EASY: CHECK OUT THE ASSEMBLY INSTRUCTION VIDEO - USE QR CODE**



**MAKE IT EASY: CHECK OUT THE ASSEMBLY INSTRUCTION VIDEO - USE QR CODE**

**Driver side**

Squeeze pin, push in until it clicks in place.

**18**

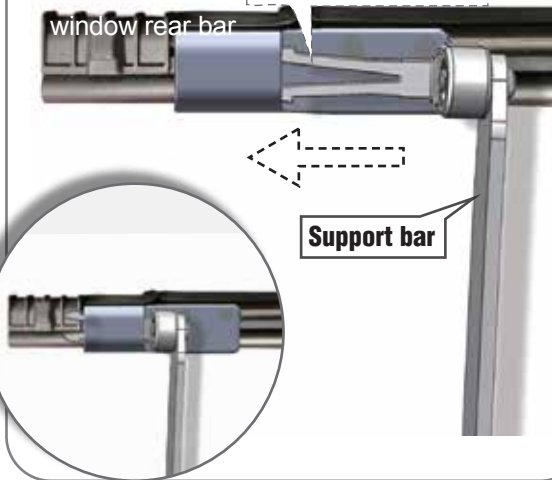

**Passenger side**

**19**

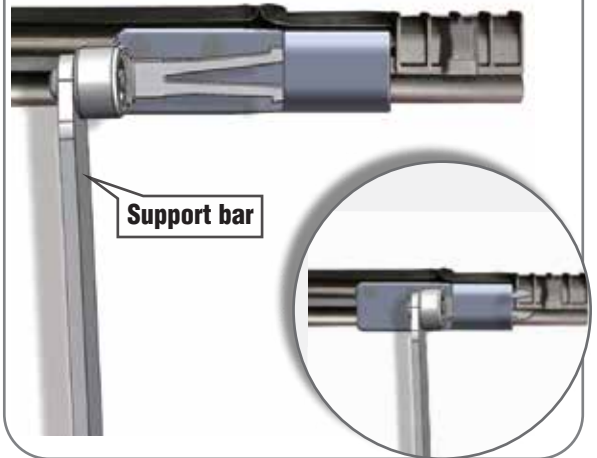

**How to use EZWINDOW**

**With EZWINDOW Installed**

**20A**



1. Fold the side of the window with one hand
2. Pull the EZWINDOW towards you

**Without EZTRUNK version**

**20B**



1. Open the back door
2. Pull up the rear window with both hands

**21**



Use the **pin** to lock in place

**22**

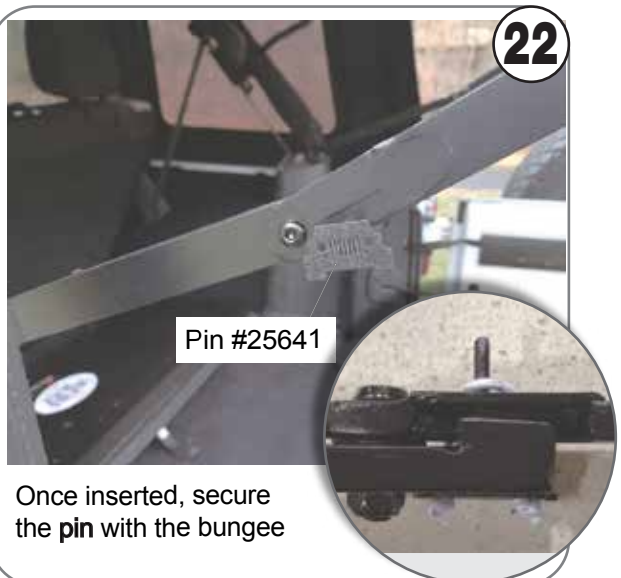

Pin #25641

Once inserted, secure the **pin** with the bungee

## How to Storage EZWINDOW

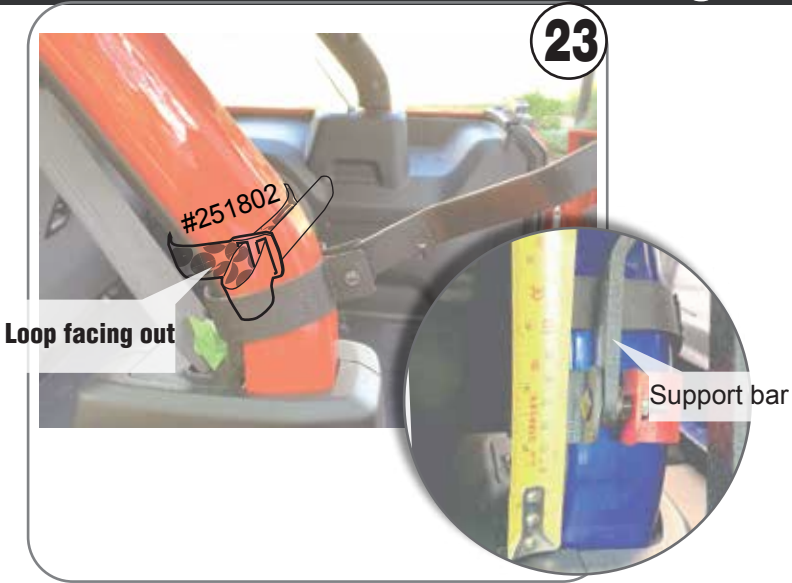



**Scan QR CODE for  
Video & PDF MANUALS**

# **Customer Service**

*Any questions? WE ARE HERE TO HELP YOU!*

**Text or Call 203-901-0055 / Call 203-591-9060**

**EMAIL US: SERVICE@EZTRUNK.NET**

7 day a week 8:30 am EST

**DO NOT RETURN, WE CAN HELP YOU!**