

**EZTRUNK**

# JK 2011 - 2018 2 DOOR

#19110019 ASSEMBLY MANUAL

BEFORE BEGINNING, SEE THE ASSEMBLY INSTRUCTION VIDEO ON **EZTRUNK.NET**



## Customer Service

*Any question call*

Call **203-901-0055 / 203-591-9060**









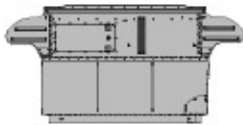

**EMAIL US: SERVICE@EZTRUNK.NET**

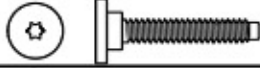
*Monday - Friday 8:30 am - 4:30 pm EST*

Go to **EZTRUNK.NET** for Video Manual

**DO NOT RETURN TO THE STORE!**

**Please read instructions fully before beginning assembly**

| NO | Illustration                                                                                    | Description                                                                                   | Part #  | QTY. |
|----|-------------------------------------------------------------------------------------------------|-----------------------------------------------------------------------------------------------|---------|------|
| 1  |                | EZTRUNK                                                                                       | 201121  | 1    |
| 2  |                | Round Panel                                                                                   | 2011213 | 2    |
| 3  |                | Base Plate Bolts M6x40                                                                        | 76401   | 2    |
| 4  |                | Base Plate Screws M5 x 7                                                                      | 55071   | 7    |
| 5  |                | Base Plate Wrench - T30                                                                       | 60030   | 1    |
| 6  |                | Door Latch Wrench - T45                                                                       | 60045   | 1    |
| 7  |               | Rubber Strip (On Trunk)                                                                       | 00214   | 1    |
| 8  |              | You can also use this rubber instead of the Rubber on the EZTRUNK if your DOOR does not close | 00134   | 1    |
| 9  |              | Webbing Bracket - Driver                                                                      | 11256   | 1    |
| 10 |              | Webbing Hook - Passenger                                                                      | 11257   | 1    |
| 11 |  Extra Parts | Rubber Pad insulator<br>This is for Noise Supression if needed                                | 11203   | 6    |

**RECOMMENDED TOOLS**



**PLEASE NOTE:**  
**DO NOT USE ELECTRIC TOOLS, THIS WILL CAUSE SCREWS TO STRIP**  
**USE SCREW DRIVER**  
**DO NOT OVER TIGHTEN**

## Figure A

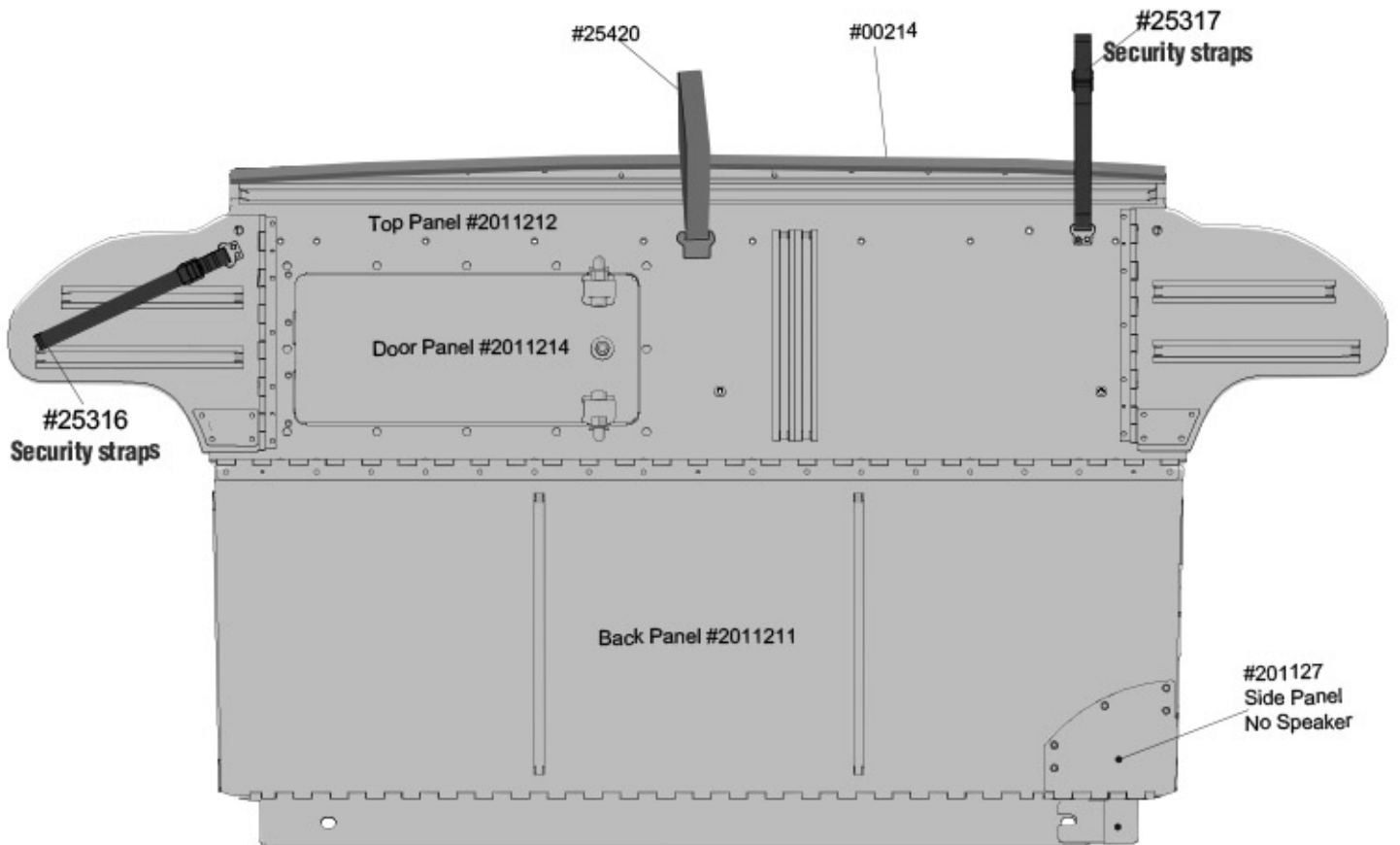

Driver side

Passenger side



#2011213  
Round Panel  
If you have an OEM  
speaker

If you don't have a speaker skip steps 1,2 and 3 on Page 4.

## PLEASE NOTE



**THIS RUBBER PIECE COMES ON  
EZTRUNK**



**YOU CAN ALSO USE THIS RUBBER INSTEAD  
OF THE RUBBER ON THE EZTRUNK IF YOUR  
DOOR DOES NOT CLOSE**

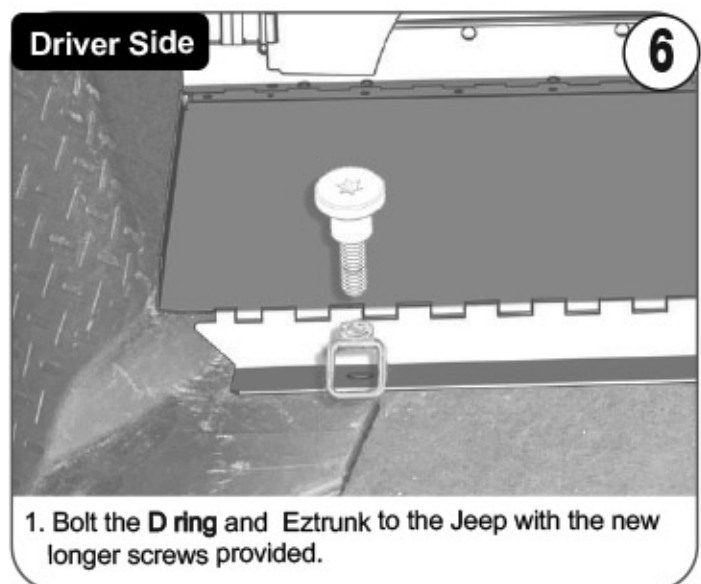
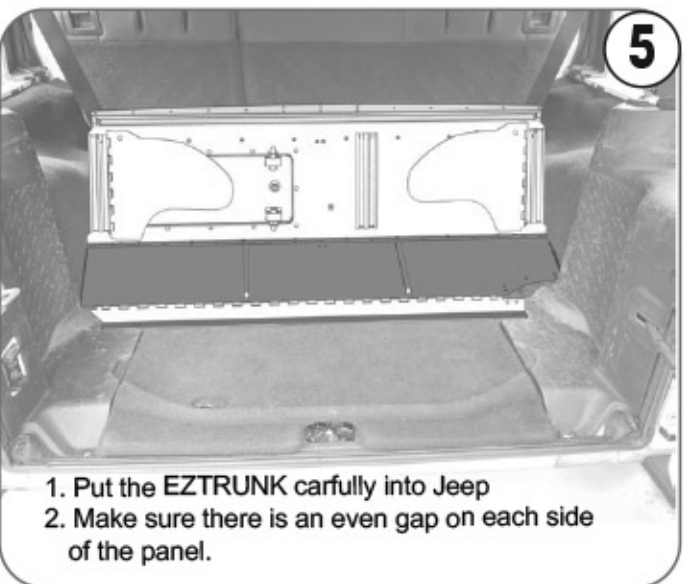
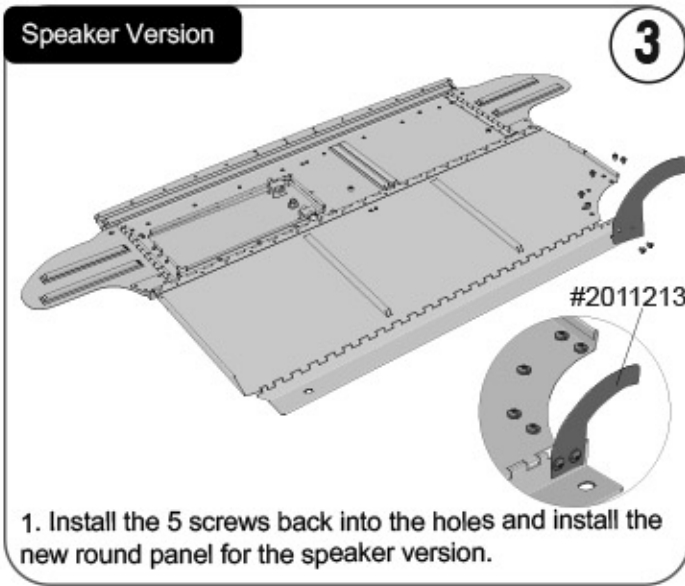
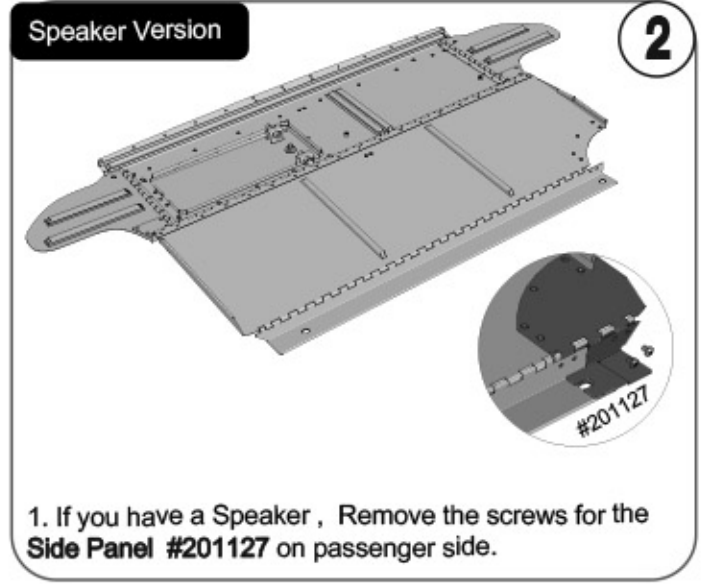
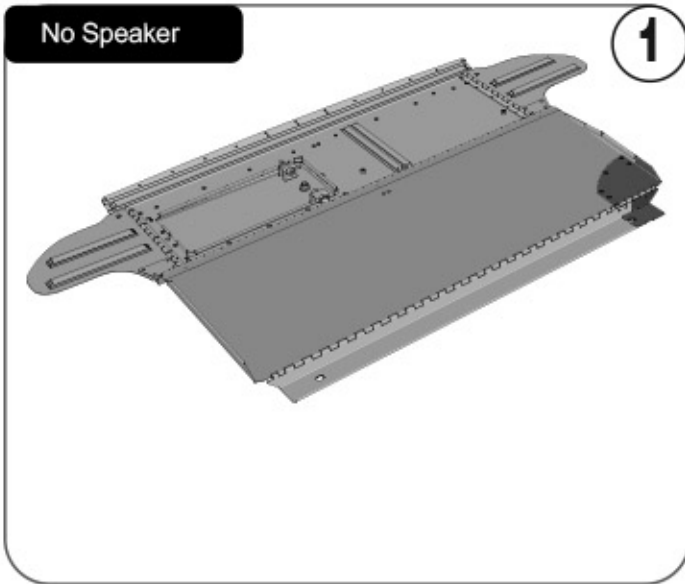

**Passenger Side W/O Speaker**

**7A**

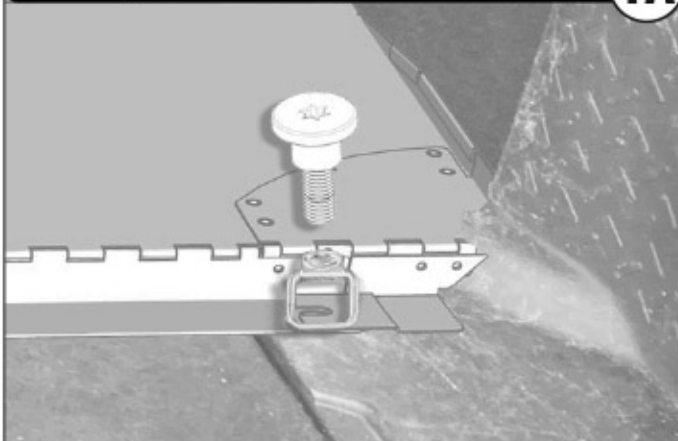

1. Bolt the **D ring** and Eztrunk to the Jeep with the new longer screws provided.

**IF YOU HAVE THE OEM SPEAKER USE THIS MOUNTING BRACKET**

**7B**

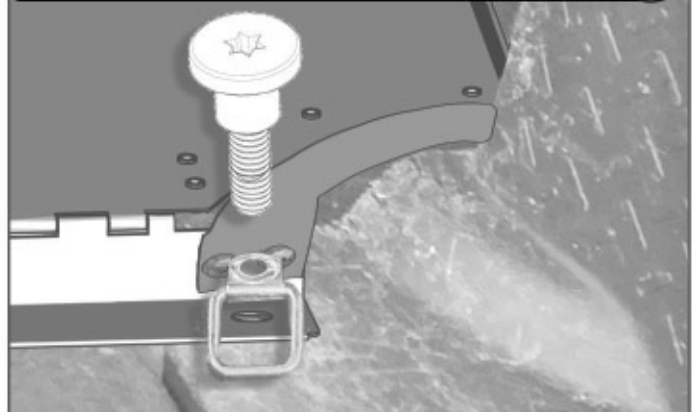

1. Bolt the **D ring** and Eztrunk to the Jeep with the new longer screws provided.

**Extra Security Brackets Driver side**

**8**



1. Remove upper door latch bolt to install the Bracket
2. **Do not loosen the bottom bolt or you will need to adjust the door**

**Extra Security Passenger side**

**9**



1. Locate D Ring on the passenger side near the door hinge
2. Remove bolt and install the webbing hook on top of the D Ring

**How to open and close the EZTRUNK**

**10**

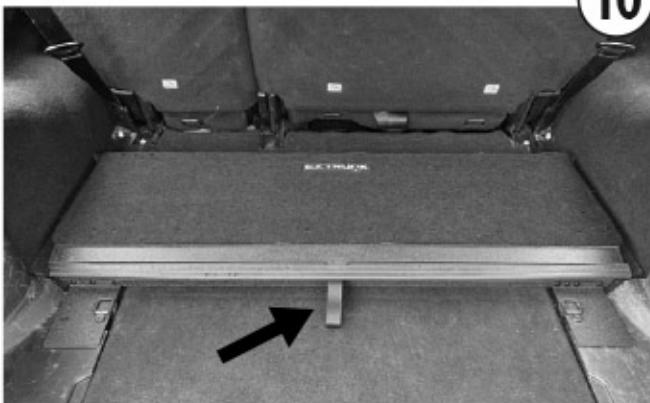

1. Pull the EZTRUNK up with webbing.

**11**



1. Flip open both side Wing panels

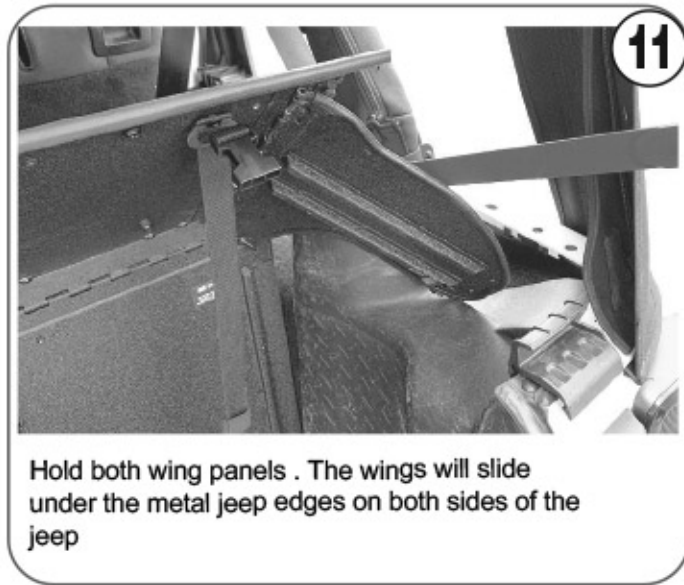

Hold both wing panels . The wings will slide under the metal jeep edges on both sides of the jeep



Closing the the rear door. You will need to close the door a little harder to make sure the EZTRUNK locks in place.

## **Security straps are for Extra Protection DO NOT OVER TIGHTEN**

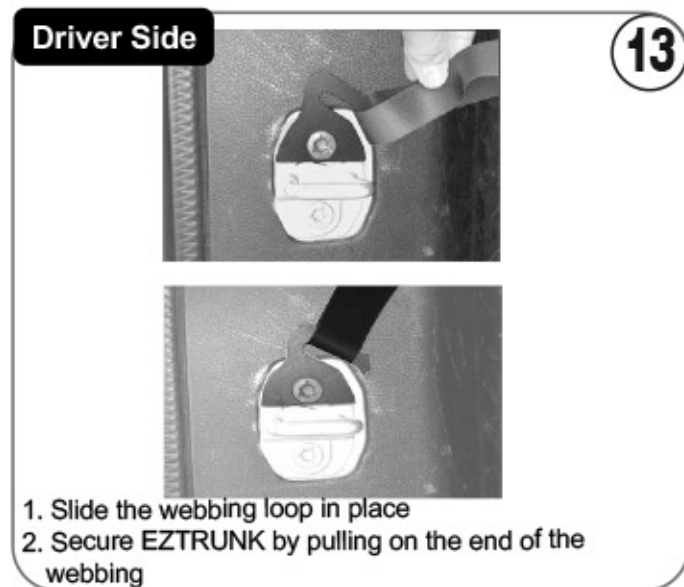

1. Slide the webbing loop in place  
2. Secure EZTRUNK by pulling on the end of the webbing

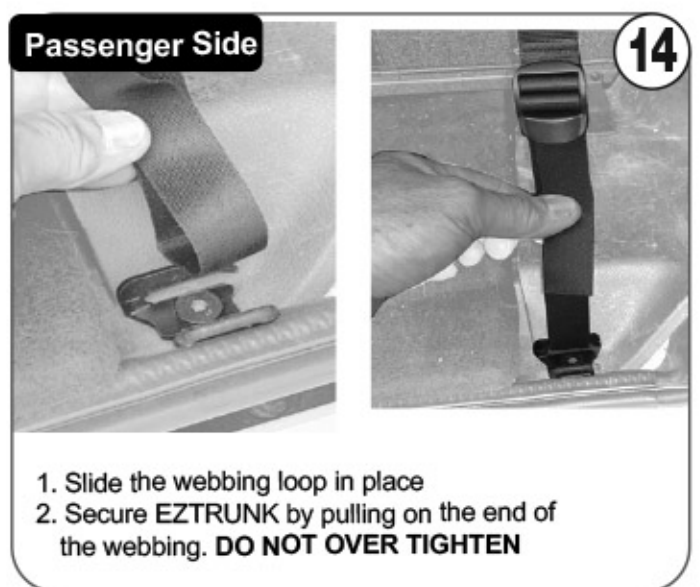

1. Slide the webbing loop in place  
2. Secure EZTRUNK by pulling on the end of the webbing. **DO NOT OVER TIGHTEN**



1. Pull the webbing snug  
2. Make sure the trunk fits into the groove in the back of the tailgate door. **DO NOT OVER TIGHTEN**

# **Customer Service**

*Any question call*

**Call 290-901-0055 / 203-591-9060**

**EMAIL US: [SERVICE@EZTRUNK.NET](mailto:SERVICE@EZTRUNK.NET)**

*Monday - Friday 8:30 am - 4: 30 pm EST*

Go to **EZTRUNK.NET** for Video Manual

**DO NOT RETURN TO THE STORE!**

# WHEN INSTALLING AN EZTRUNK with hardtop wire & hose

## A1 & A2

When installing the EZTRUNK with the hardtop on, there will be a wire and a hose in the back corner, take them both and push them in the corner before putting EZTRUNK in place.

**A1**



**A2**



## B1 & B2

If the wires are there but not connected to the hardtop then take the wires and hose then lift the plastic on the side by the rollbar and place the wires under the plastic for storage. This needs to be done before the EZTRUNK is placed in an upright closed secure position.

**B1**



**B2**

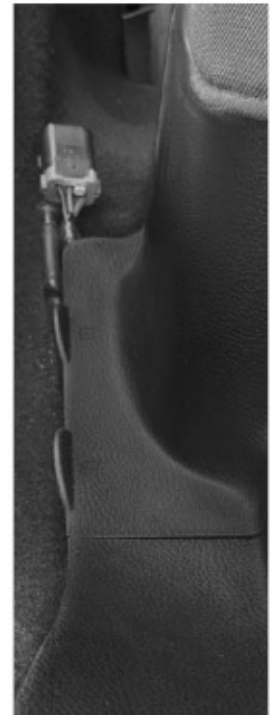

# **ELECTRIC DOOR LOCKS**

**Look at the video on  
EZTRUNK.NET  
to unplug/disable  
the power door lock  
actuator in  
the tailgate.**

**Any problems call  
203-591-9060**

**EZTRUNK.net**  
**Service@EZTRUNK.net**  
**EZTRUNK**