

Venture Capital & the Finance of Innovation

Andrew Metrick & Ayako Yasuda



Second Edition

This page intentionally left blank

*VENTURE CAPITAL &
THE FINANCE OF
INNOVATION*

This page intentionally left blank

VENTURE CAPITAL & THE FINANCE OF INNOVATION

SECOND EDITION

ANDREW METRICK

Yale School of Management

AYAKO YASUDA

Graduate School of Management, UC Davis



WILEY

John Wiley & Sons, Inc.

EDITOR *Lacey Vitetta*
PROJECT EDITOR *Jennifer Manias*
SENIOR EDITORIAL ASSISTANT *Emily McGee*
MARKETING MANAGER *Diane Mars*
DESIGNER *RDC Publishing Group Sdn Bhd*
PRODUCTION MANAGER *Janis Soo*
SENIOR PRODUCTION EDITOR *Joyce Poh*

This book was set in Times Roman by MPS Limited and printed and bound by Courier Westford. The cover was printed by Courier Westford.

This book is printed on acid free paper.

Copyright 2011, 2007 John Wiley & Sons, Inc. All rights reserved. No part of this publication may be reproduced, stored in a retrieval system or transmitted in any form or by any means, electronic, mechanical, photocopying, recording, scanning or otherwise, except as permitted under Sections 107 or 108 of the 1976 United States Copyright Act, without either the prior written permission of the Publisher, or authorization through payment of the appropriate per-copy fee to the Copyright Clearance Center, Inc. 222 Rosewood Drive, Danvers, MA 01923, website www.copyright.com. Requests to the Publisher for permission should be addressed to the Permissions Department, John Wiley & Sons, Inc., 111 River Street, Hoboken, NJ 07030-5774, (201)748-6011, fax (201)748-6008, website <http://www.wiley.com/go/permissions>.

Evaluation copies are provided to qualified academics and professionals for review purposes only, for use in their courses during the next academic year. These copies are licensed and may not be sold or transferred to a third party. Upon completion of the review period, please return the evaluation copy to Wiley. Return instructions and a free of charge return shipping label are available at www.wiley.com/go/returnlabel. Outside of the United States, please contact your local representative.

Library of Congress Cataloging-in-Publication Data:

Metrick, Andrew.

Venture capital and the finance of innovation / Andrew Metrick, Ayako Yasuda. — 2nd ed.
p. cm.

Includes index.

ISBN 978-0-470-45470-1 (hardback)

1. Venture capital. 2. Technological innovations—Finance. I. Yasuda, Ayako. II. Title.

HG4751.M48 2010

332'.04154—dc22

2010020655

Printed in the United States of America

10 9 8 7 6 5 4 3 2 1

BRIEF CONTENTS

PREFACE TO 2ND EDITION—A READER'S GUIDE vii

ACKNOWLEDGMENTS xiii

CONTENTS xvii

PART I

VC BASICS

CHAPTER 1 *THE VC INDUSTRY* 3

CHAPTER 2 *VC PLAYERS* 21

CHAPTER 3 *VC RETURNS* 46

CHAPTER 4 *THE COST OF CAPITAL FOR VC* 65

CHAPTER 5 *THE BEST VCs* 83

CHAPTER 6 *VC AROUND THE WORLD* 99

PART II

TOTAL VALUATION

CHAPTER 7 *THE ANALYSIS OF VC INVESTMENTS* 123

CHAPTER 8 *TERM SHEETS* 146

CHAPTER 9 *PREFERRED STOCK* 163

CHAPTER 10 *THE VC METHOD* 178

CHAPTER 11 *DCF ANALYSIS OF GROWTH COMPANIES* 195

CHAPTER 12 *COMPARABLES ANALYSIS* 214

PART III

PARTIAL VALUATION

- CHAPTER 13** *OPTION PRICING* 231
- CHAPTER 14** *THE VALUATION OF PREFERRED STOCK* 252
- CHAPTER 15** *LATER-ROUND INVESTMENTS* 272
- CHAPTER 16** *PARTICIPATING CONVERTIBLE PREFERRED STOCK* 290
- CHAPTER 17** *IMPLIED VALUATION* 305
- CHAPTER 18** *COMPLEX STRUCTURES* 320

PART IV

THE FINANCE OF INNOVATION

- CHAPTER 19** *R&D FINANCE* 339
- CHAPTER 20** *MONTE CARLO SIMULATION* 357
- CHAPTER 21** *REAL OPTIONS* 378
- CHAPTER 22** *BINOMIAL TREES* 400
- CHAPTER 23** *GAME THEORY* 419
- CHAPTER 24** *R&D VALUATION* 445
- APPENDIX A** *SAMPLE TERM SHEET* 466
- APPENDIX B** *THE VCFI SPREADSHEETS* 484
- APPENDIX C** *GUIDE TO CRYSTAL BALL[®]* 487
- GLOSSARY* 512
- INDEX* 535

PREFACE TO 2ND EDITION— A READER'S GUIDE

Many interesting developments have occurred in the world of venture capital since the publication of the first edition of this book in 2006, which prompted us to revise the book for the second edition. While the organization of the book remains unchanged, many of the chapters are substantially rewritten. For example, in Chapter 5, we re-ranked top VC firms, incorporating the latest performance statistics, fundraising and investment activities, notable exits, and (as always) our subjective opinions. In Chapter 6, we examine further evidence of the deepening globalization of the industry. In Chapters 3, 4, and 7, we analyze the impact of the 1999–2000 Internet bubble years on the VC risk and returns, as investments made in those years are finally mature and thus now a part of the performance evaluation analysis. We also incorporated expositional improvements throughout the book based on reader feedback on the first edition.

Another feature of the new edition is that the VCV model, used extensively in Part III of the book, is now available as a Web-based application available on <http://VCVtools.com>. Significant collaborative efforts went into developing this tool, which we believe will be of interest to a broad audience, including practitioners interested in valuing VC-backed company stocks and employee stock options.

THE ORGANIZATION OF THIS BOOK

The book is divided into four parts, with six chapters each. Each of these four parts has a major finance theme: the theme of Part I is the relationship between risk and return; the theme of Part II is the valuation of high-growth companies; the theme of Part III is the analysis of capital structure; and the theme of Part IV is the relationship between strategy and finance. Overall, Parts I and II are heavy on data and definitions and are intended to provide students with the vocabulary of VC and knowledge of the key industry facts. Although these two parts contain some new definitions and approaches, most of the material should seem familiar to a VC practitioner. In contrast, Parts III and IV are more theory based and provide a new perspective on the evaluation of VC and other high-technology investments. Although these latter two parts might seem experimental to a practicing VC, financial economists will recognize the material as a straightforward translation of well-known methods.

In Part I, “An Introduction to VC”, we provide an overview of the VC industry, with discussions of history (Chapter 1), major players (Chapters 2 and 5), performance measurement (Chapters 3 and 4), and global patterns (Chapter 6). The discussion of risk and return in Chapters 3 and 4 provide a key translation between the language of VC and the language of financial economics—a translation that we rely on heavily throughout the book.

In Part II, “Total Valuation”, we provide data and methods used to value a high-growth company. We first review the investment process used by VCs and provide data on their historical performance (Chapter 7). We next describe the structure of VC transactions (Chapters 8 and 9) and then demonstrate the industry-standard technique for the valuation of VC investments (Chapter 10). This technique, known loosely as “the venture capital method”, requires that analysts estimate company values far into the future. Although such estimates will always contain a fair amount of guesswork, we show how to use a “reality-check” model to frame these estimates (Chapter 11) and how to use evidence from comparable companies to provide an additional input for the investment decision (Chapter 12).

In Part III, “Partial Valuation”, we take the total valuation (Part II) as given and analyze the special features of VC transactions. In most VC transactions, the investors receive preferred stock with several special features. When there are many VC investors, the capital structure of the company grows quite complex, with each investor holding a unique place in the capital-structure hierarchy of the company. In Part III, we show how to divide the total valuation of the company into its component parts (partial valuation) for each investor. The key step in this analysis is the recognition that all flavors of preferred stock can be represented as a portfolio of options. In Chapter 13, we show how the classic option-pricing analysis of Black and Scholes can be extended to VC settings. We then apply this extended analysis to the valuation of preferred stock (Chapters 14, 15, and 16). The techniques used in these chapters can also be used to refine some industry-standard measures of company valuation (Chapter 17) and to estimate the partial valuation of complex nonstandard transaction structures (Chapter 18).

Parts II and III of the book take the perspective of a venture capitalist making an investment in a high-technology company. In Part IV, we take the perspective of the company deciding what to do with VC money or other capital. Specifically, we develop a framework for modeling investment in “research and development” (R&D). Since VC-backed companies typically spend a significant fraction of their capital on R&D, an understanding of R&D finance is crucial for both VCs and for financial decision-makers at technology companies of all sizes. After introducing typical kinds of R&D investment problems (Chapter 19), we study several of the most interesting and cutting-edge techniques in finance, including Monte Carlo analysis (Chapter 20), real options (Chapter 21), binomial trees (Chapter 22), and game theory (Chapter 23). In Chapter 24, we pull all of these tools together and solve the investment problems originally posed in Chapter 19.

Several appendices supplement the text. Appendix A provides an example “term sheet” VC contract developed by the National Venture Capital Association.

Appendix B provides some basic documentation for the companion spreadsheets and the web-based valuation model used in the book. Appendix C is a brief primer on Crystal Ball[®] software, a commercial product from Oracle that is useful for solving some of the models in Part IV. Finally, a glossary at the end of the book gives definitions for all key terms used in the book.

WHAT THIS BOOK COVERS . . . AND WHAT IT DOESN'T

To be successful, VCs must have a broad general knowledge of business and all its disciplines: marketing, management, finance, operations, accounting, and so on. In addition, most VCs must acquire specialized knowledge in one or more high-technology industries. It is not possible to cover all these areas in one textbook, nor is it advisable to even try. This book focuses almost exclusively on finance, specifically on the valuation of high-technology investments. The ideal reader is an MBA student or advanced undergraduate who is both interested in VC and intellectually curious about finance. We wrote the book for this prototypical reader; your distance from this prototype will likely predict your satisfaction with this book. In particular, readers looking for a “how to” guide for being a successful VC are sure to be disappointed. We doubt such a book is even possible, and we are sure that we could not write it.

For instructors, the 24 chapters of the book can provide for 24 class meetings with 75 minutes each (= 30 hours) for a course of the same name as the book. That is how we taught it at Wharton.¹ Alternatively, a finance course on “Venture Capital” could omit Part IV of the book and include six additional case-study classes to fill out a full semester course. For a quarter-length course that meets 20 times for 90 minutes each (= 30 hours), some chapters can be combined (for example, chapters 1 and 2, 3 and 4, and 11 and 12) or omitted (e.g., 18, 22–24). For a six-week course (= 15 class hours) on “Venture Capital”, the first two parts of the book can provide a self-contained framework.

For any of these VC courses, many instructors may choose to combine this book with case studies. At Wharton, we used this book as the main text, with case studies from the books by Josh Lerner and Felda Hardyman of Harvard Business School used to illustrate the practical applications of the concepts. Alternatively, one could use the case studies as the main classroom topics, with this textbook as background. A companion instructor’s manual suggests some cases that work well with each of the chapters.

For VC courses taught outside of a finance department, instructors will rightly want to emphasize different aspects of VC practice. At Yale and UC Davis, we have a highly successful VC course taught by management faculty—a course

¹Both authors previously taught at Wharton, 1999–2008 for Metrick and 2001–2009 for Yasuda.

that has virtually no overlap with this book. Furthermore, as one might expect, courses taught by VC practitioners are often much more “practical”, with many class sessions dedicated to the nuts and bolts of working with young companies. While we believe that some chapters of this book could provide useful background for these practitioner courses, we are certain that most of the book would be useless. We have found that students can learn a tremendous amount from these practice-based courses, and have made no attempt to substitute for these valuable lessons.

There are several related topics for which this book has some imperfect overlap. For example, for courses in “entrepreneurial finance”, students typically need some exposure to VC. For these students, Part I should be useful, while the other parts are likely to be overkill. This book takes the perspective of a venture capitalist—not the perspective of an entrepreneur. The latter perspective requires a careful study of non-VC sources of capital for young companies, a perspective that this book does not cover at all. Furthermore, the financial management of young growth companies is another important topic in entrepreneurial finance. While such a topic could conceivably have been included in this book, we chose instead to focus on the valuation aspects of VC finance.

Another topic of some overlap would be a general course on “private equity”. As will be discussed in Chapter 1, private equity is a broad class of investing that includes VC as well as investments in leveraged buyouts, mezzanine structures, and distressed companies. (All these terms will be defined in Chapter 1.) For instructors of such classes, the usefulness of the book depends on the relative emphasis on VC. Six weeks (= 15 hours) of VC can be supported by Parts I and II, supplemented with (or supplementing) case studies. For private equity courses with less than six weeks of VC, the reductions can be accomplished in Parts I and II by omitting some combination of Chapter 5, Chapter 6, and Chapter 9, and combining Chapters 11 and 12 into a single class meeting.

NOTES ON TERMINOLOGY, STYLE, AND MATHEMATICS

The text assumes that readers have familiarity, but not mastery, of the basic concepts from first-year MBA courses in finance, statistics, and accounting. (For example, the book assumes that readers know the definitions for “mean” and “standard deviation”,² but does not assume that readers have memorized formulas for the mean and standard deviation of any specific probability distributions.) Most of the mathematics in the book goes no further than simple algebra. In Parts III and IV of the book, we use some basic calculus in a few places, but even there it is more

²This book follows British style in the “logical” placement of some punctuation marks outside of quotation marks. This annoys some people. Sorry.

important that readers know what an integral “does” rather than know how to solve any specific integrals.

The book assumes *no prior knowledge of venture capital*. All key terms are given in **bold type** in their first appearance in the text. Because this book is attempting to provide a bridge between the language of VC and the language of finance, it is sometimes helpful to introduce new terminology in order to ease the translation. Such new terminology is given in ***bold italic*** type in its first appearance in the text. All key terms are listed at the end of the chapter of their first appearance. At the end of the textbook, a glossary provides definitions for all key terms. The text uses many acronyms to shorten the exposition. Each acronym is spelled out in its first appearance, followed by the acronym given in parenthesis: for example, **venture capital (VC)**. All acronyms are also listed in the glossary.

This page intentionally left blank

ACKNOWLEDGMENTS

This book would not have been possible without the guidance, encouragement, and support of many of our academic colleagues; special gratitude goes to Paul Gompers, Steve Kaplan, Josh Lerner, and David Scharfstein for their continuous generosity with their knowledge and insights.

We are also indebted to our friends in the VC industry for their willingness to help us with their time, knowledge and resources. Special thanks to Susan Woodward, who graciously made available to us the venture capital database at Sand Hill Econometrics, Mike Holt of Holt Private Equity Consultants for sharing with us the coveted compensation data from his annual compensation survey, and John Taylor of National Venture Capital Association for his help with the LP data. We also thank Louis Radovich for his superb assistance with the analysis of the Sand Hill Econometrics data.

We continue to rely on the dedication of highly skilled students for development of the VCV model, used in Part III to value deal structures with preferred stock and now newly offered as a Web-based application. This valuation model in its current incarnation would not have been possible without the contribution of Tony Curnes, Holland Gary, Jonathan Reinstein, David Smalling, and Rebecca Yang. We also thank Garris Shipon for building the Web application and designing the site (VCVtools.com) that houses the VCV model, and Greta Lin for co-authoring Appendix C.

The book benefited greatly from the feedback on the first edition from many individuals, including our former Wharton colleague David Wessels, who taught courses using the book, and generations of students at Wharton and Yale. Ayako thanks her colleagues at UC Davis Graduate School of Management for supporting her in creating a new VC finance course in her first year there, and her MBA students for being test-marketed for the pre-publication manuscript of the second edition. Several of our students and colleagues made important contributions to the first edition of this book, and these contributions are still evident in this new version: Izhar Armony, Albert Cheng, Christine Chou, Colleen Pontious, and Yin Yin. We also would like to thank the Mack Center for Technological Innovation at the Wharton School of the University of Pennsylvania for their generous financial support for the first edition of the book.

We would also like to thank Lacey Vitetta, Jennifer Manias, Emily McGee, and Joyce Poh at Wiley for their contributions to the completion of this book. Finally, we each are most indebted to our families, for making this all possible and worthwhile. Andrew dedicates the book to: his wife Susie, his son David, and his daughter Amy; Ayako dedicates the book to: her husband Garris, and her daughter Miumi.

This page intentionally left blank

For Susie, David, and Amy
AM

For Garris and Miami
AY

This page intentionally left blank

CONTENTS

PART I

VC BASICS

CHAPTER 1 *THE VC INDUSTRY* 3

- 1.1 What Is Venture Capital? 3
- 1.2 What Do Venture Capitalists Do? 9
- 1.3 The History of Venture Capital 10
- 1.4 Patterns of VC Investment in the United States 14
 - 1.4.1 Investments by Stage 14
 - 1.4.2 Investments by Industry 16
 - 1.4.3 Investments by U.S. Region 18
- Summary 19
- Key Terms 20
- References 20

CHAPTER 2 *VC PLAYERS* 21

- 2.1 Firms and Funds 21
- 2.2 The Limited Partners 27
- 2.3 VC Partnership Agreements 30
 - 2.3.1 Management Fees 30
 - 2.3.2 Carried Interest 32
 - 2.3.3 Restrictive Covenants 39
- Summary 41
- Key Terms 42
- References 42
- Exercises 42
- Appendices: Key Terms and Conditions for Three VC Funds 43
 - Appendix 2.A: EarlyBird Ventures I 43
 - Appendix 2.B: Talltree Ventures IV 44
 - Appendix 2.C: Owl Ventures IX 45

xviii CONTENTS

CHAPTER 3 VC RETURNS 46

- 3.1 Industry Returns **46**
 - 3.1.1 Definitions **46**
 - 3.1.2 A Gross-Return Index **48**
 - 3.1.3 A Net-Return Index **50**
- 3.2 Fund Returns **53**
 - 3.2.1 Definitions **53**
 - 3.2.2 Evidence **59**
- Summary **62**
- Key Terms **63**
- References **63**
- Exercises **63**

CHAPTER 4 THE COST OF CAPITAL FOR VC 65

- 4.1 The Capital Asset Pricing Model **65**
- 4.2 Beta and the Banana Birds **69**
- 4.3 Estimating the Cost of Capital for VC **74**
- Summary **79**
- Key Terms **80**
- References **80**
- Exercises **80**

CHAPTER 5 THE BEST VCs 83

- 5.1 The Economics of VC **83**
- 5.2 The Best VCs: A Subjective List **86**
- 5.3 VC Value Added and the Monitoring of Portfolio Firms **95**
- Summary **98**
- Key Terms **98**
- References **98**

CHAPTER 6 VC AROUND THE WORLD 99

- 6.1 The Global Distribution of VC Investing **99**
- 6.2 The Cost of Capital for International VC **111**
 - 6.2.1 Baseline Model: The Global CAPM **112**
 - 6.2.2 Objective and Extensions to the Global CAPM **114**
 - 6.2.3 A Global Multifactor Model for Venture Capital **118**
- Summary **119**
- Key Terms **119**
- References **119**
- Exercises **120**

PART II***TOTAL VALUATION*****CHAPTER 7 *THE ANALYSIS OF VC INVESTMENTS* 123**

- 7.1 VC Investments: The Historical Evidence **123**
- 7.2 The Investment Process **135**
- Summary **144**
- Key Terms **145**
- References **145**

CHAPTER 8 *TERM SHEETS* 146

- 8.1 The Basics **147**
 - 8.1.1 Investors **148**
 - 8.1.2 Price Per Share **149**
 - 8.1.3 Pre-Money and Post-Money Valuation **149**
 - 8.1.4 Capitalization **150**
- 8.2 The Charter **151**
 - 8.2.1 Dividends **153**
 - 8.2.2 Liquidation Preference **153**
 - 8.2.3 Voting Rights and Other Protective Provisions **154**
 - 8.2.4 Mandatory Conversion **154**
 - 8.2.5 Redemption Rights **154**
- 8.3 Investor Rights Agreement **155**
 - 8.3.1 Registration Rights **158**
 - 8.3.2 Matters Requiring Investor-Director Approval **158**
 - 8.3.3 Employee Stock Options **158**
- 8.4 Other Items **159**
 - 8.4.1 Rights and Restrictions **160**
 - 8.4.2 Founders' Stock **161**
- Summary **161**
- Key Terms **161**
- References **162**
- Exercises **162**

CHAPTER 9 *PREFERRED STOCK* 163

- 9.1 Types of Preferred Stock **163**
- 9.2 Antidilution Provisions **173**
- Summary **176**
- Key Terms **177**

XX CONTENTS

Reference 177

Exercises 177

CHAPTER 10 THE VC METHOD 178

- 10.1 The VC Method: Introduction 178
 - 10.1.1 Exit Valuation 179
 - 10.1.2 Target Returns 180
 - 10.1.3 Expected Retention 182
 - 10.1.4 The Investment Recommendation 183
- 10.2 The Standard VC Method 184
- 10.3 The Modified VC Method 185
- Summary 192
- Key Terms 192
- References 192
- Exercises 192

CHAPTER 11 DCF ANALYSIS OF GROWTH COMPANIES 195

- 11.1 DCF Analysis: Concepts 196
- 11.2 DCF Analysis: Mechanics 198
- 11.3 Graduation Value 204
- 11.4 DCF Analysis: The Reality-Check Model 207
 - 11.4.1 Baseline Assumptions for the Reality-Check DCF 207
- Summary 212
- Key Terms 212
- References 213
- Exercises 213

CHAPTER 12 COMPARABLES ANALYSIS 214

- 12.1 Introduction to Comparables Analysis 215
- 12.2 Choosing Comparable Companies 219
- 12.3 Using Comparable Companies to Estimate the Cost of Capital 224
- Summary 226
- Key Terms 227
- References 227
- Exercises 227
- Appendix 12.A: Potential Comparables for Semico 228

PART III*PARTIAL VALUATION***CHAPTER 13** *OPTION PRICING* **231**

- 13.1 European Options **232**
- 13.2 Pricing Options Using a Replicating Portfolio **234**
- 13.3 The Black-Scholes Solution **238**
- 13.4 American Options **242**
- 13.5 Random-Expiration Options **243**
- 13.6 Reading Exit Diagrams **245**
- 13.7 Carried Interest as an Option **247**
- Summary **248**
- Key Terms **249**
- References **249**
- Exercises **249**
- Appendix 13.A RE Options: Technical Details **250**

CHAPTER 14 *THE VALUATION OF PREFERRED STOCK* **252**

- 14.1 Base-Case Option-Pricing Assumptions **253**
- 14.2 RP Valuation **254**
- 14.3 Excess Liquidation Preferences **257**
- 14.4 Dividends **259**
- 14.5 CP Valuation **261**
- 14.6 CP with Excess Liquidation Preferences or Dividends **263**
- 14.7 Combining RP and CP **266**
- 14.8 Comparing RP and CP **268**
- Summary **269**
- Key Terms **270**
- References **270**
- Exercises **270**

CHAPTER 15 *LATER-ROUND INVESTMENTS* **272**

- 15.1 Series B **272**
- 15.2 A Conversion Shortcut **277**
- 15.3 Series C **278**
- 15.4 Dividends in Later Rounds **282**
 - 15.4.1 Accrued Cash Dividends **282**
 - 15.4.2 PIK Dividends **284**
- 15.5 Beyond Series C **285**

xxii CONTENTS

Summary **288**
Key Terms **288**
Exercises **288**

CHAPTER 16 PARTICIPATING CONVERTIBLE PREFERRED STOCK 290

16.1 Binary Options **291**
16.2 The Valuation of PCP **292**
16.3 The Valuation of PCPC **294**
16.4 Series B and Beyond **296**
Summary **303**
Key Terms **303**
References **303**
Exercises **303**

CHAPTER 17 IMPLIED VALUATION 305

17.1 Post-Money Valuation Revisited **306**
17.2 Measurement of Portfolio Value **310**
17.3 Down Rounds? **314**
17.4 How to Avoid Valuation Confusion **317**
Summary **318**
Key Terms **318**
Exercises **319**

CHAPTER 18 COMPLEX STRUCTURES 320

18.1 Management Carve-outs **320**
18.2 Dealing with Partners **327**
18.3 A Complex Example **329**
Summary **334**
Key Terms **334**
Exercises **334**

PART IV

THE FINANCE OF INNOVATION

CHAPTER 19 R&D FINANCE 339

19.1 R&D Around the World **339**

19.2	Two Touchstones	345
19.2.1	Drug Development	345
19.2.2	Energy Innovation	348
19.3	How Is R&D Financed?	349
19.4	Where Do We Go from Here?	354
	Summary	355
	Key Terms	356
	References	356

CHAPTER 20 *MONTE CARLO SIMULATION* **357**

20.1	Event Trees	357
20.2	Simulation with Continuous Probability Distributions	362
20.3	Simulation with Multiple Sources of Uncertainty	373
	Summary	376
	Key Terms	376
	Exercises	376

CHAPTER 21 *REAL OPTIONS* **378**

21.1	Decision Trees	379
21.2	Real Options in R&D	381
21.3	The Valuation of Real Options	382
21.4	Risk-Neutral Probabilities	388
21.5	Drugco, Revisited	395
	Summary	398
	Key Terms	398
	Exercises	398

CHAPTER 22 *BINOMIAL TREES* **400**

22.1	The Black-Scholes Equation, Revisited	400
22.2	Multiple Strike Prices and Early Exercise	409
22.3	Dividends	411
	Summary	417
	Key Terms	418
	References	418
	Exercises	418

CHAPTER 23 *GAME THEORY* **419**

23.1	What Is Game Theory?	419
23.2	Simultaneous Games	423

xxiv CONTENTS

23.3 Sequential Games **433**
23.4 Game Theory and Real Options **438**
Summary **443**
Key Terms **443**
Exercises **444**

CHAPTER 24 R&D VALUATION 445

24.1 Drug Development **445**
24.2 Energy **455**
24.3 The Forest and the Trees **464**
Summary **464**
References **465**
Exercises **465**

APPENDIX A SAMPLE TERM SHEET 466

APPENDIX B THE VCFI SPREADSHEETS 484

APPENDIX C GUIDE TO CRYSTAL BALL[®] 487

GLOSSARY 512

INDEX 535

PART

VC BASICS

This page intentionally left blank

THE VC INDUSTRY

IN THIS CHAPTER, we provide a definition of **venture capital** (Section 1.1), take a preliminary look at the activities of **venture capitalists** (Section 1.2), explore the history of venture capital (Section 1.3), and review a variety of statistics on the patterns of venture capital investment (Section 1.4). Throughout this text, we use the abbreviation **VC** to refer to both the venture capital industry and to an individual venture capitalist.

1.1 WHAT IS VENTURE CAPITAL?

A VC has five main characteristics:

1. A VC is a **financial intermediary**, meaning that it takes the investors' capital and invests it directly in **portfolio companies**.
2. A VC invests only in private companies. This means that once the investments are made, the companies cannot be immediately traded on a public exchange.
3. A VC takes an active role in monitoring and helping the companies in its portfolio.
4. A VC's primary goal is to maximize its financial return by **exiting** investments through a sale or an **initial public offering (IPO)**.
5. A VC invests to fund the internal growth of companies.

Characteristic (1) defines VCs as financial intermediaries. This is similar to a bank, because just as a bank takes money from depositors and then loans it to businesses and individuals, a VC fund takes money from its investors and makes equity investments in portfolio companies. Typically, a VC fund is organized as a **limited partnership**, with the venture capitalist acting as the **general partner (GP)** of the fund and the investors acting as the **limited partners (LP)**.¹ If all goes

¹The organization structure of VC funds will be discussed at length in Chapter 2.

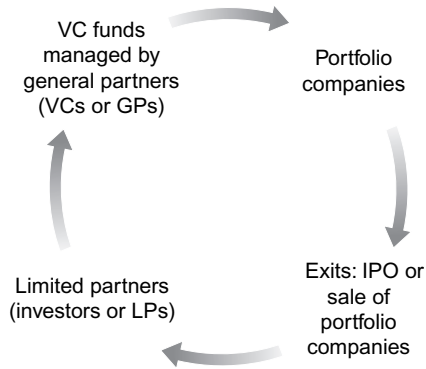
EXHIBIT 1-1*THE FLOW OF FUNDS IN THE VENTURE CAPITAL CYCLE*

well, the VC eventually sells its stake in the portfolio company, returns the money to its limited partners, and then starts the process all over again with a different company. Exhibit 1-1 illustrates the key players and the flow of funds in the VC industry.

VCs are often compared to—and confused with—**angel investors**. Angel investors, often just called **angels**, are similar to VCs in some ways but differ because angels use their own capital and, thus, do not satisfy characteristic (1). There are many types of angels. At one extreme are the wealthy individuals with no business background who are investing in the business of a friend or relative. At the other end are groups of angels with relevant business or technical backgrounds who have banded together to provide capital and advice to companies in a specific industry. In the latter case, the angel groups look very much like VCs, but the fact that they use their own capital changes the economics of their decisions: Since they can keep all the returns to on their labor, they have a correspondingly lower cost of capital and can invest in deals that would not work for a VC. Although it is difficult to get reliable figures on angel investing, the best available survey evidence for recent years suggests that total angel investments are approximately the same magnitude as total VC investments.² Although the total flow of capital is similar, angels tend to focus on younger companies than do VCs and make a larger number of smaller investments.

²The most comprehensive data on the angel market is maintained by the Center for Venture Research at the University of New Hampshire: <http://wsbe.unh.edu/cvr/>. Their annual reports on the state of the angel market provide the evidence cited in this paragraph.

Characteristic (2) defines VC as a type of **private equity**. Although the definitions of “private company” and “public company” have some nuances, the key distinction is that a public company’s securities can be traded in a formal market, like the NYSE or the NASDAQ, whereas a private company’s securities cannot. Any company that is publicly traded in the United States must also file regular reports with the Securities and Exchange Commission (SEC) detailing its financial position and material changes to its business. When combined with the activities of professional traders in public markets, this requirement to file creates significant amounts of information about public companies. In comparison, information about private companies is practically nonexistent. Private equity is considered to be a category of **alternative investing**, where “alternative” stands in contrast to “traditional” investing in stocks and bonds.

Characteristic (3) is central on our list—and central to the success of any VC. Without (3), a VC would only be providing capital, and his success (or failure) would be entirely due to his ability to choose investments. Although success can, of course, be entirely built on these choices, the comparative advantage of the VC would be greatly improved if the investor could also help the company directly.

This help takes many forms. Most notably, VCs typically take at least one position on the board of directors of their portfolio firms. Having board representation allows them to provide advice and support at the highest level of the company. (More than one VC has remarked that his job could be described as being “a professional board member”.) In addition to board service, VCs often act as unofficial recruiters and matchmakers for their portfolio firms. Young companies often have a difficult time attracting high-quality talent to a fledgling operation, and VCs can significantly mitigate this problem by drawing on their reputation and industry contacts. A VC who performs these value-added services well has a sustainable form of competitive advantage over other investors.

Because VCs are financial intermediaries, they need some mechanism to give money back to their investors. Thus, a savvy VC will only make an investment if he can foresee a path to exit, with proceeds of this exit returning to the VC and his investors. Exits can occur through an IPO, with a subsequent sale of the VC stake in the open market, through a sale of the company to another investor, or through the sale of the company to a larger company. Because of the need to exit, VCs avoid investments in “lifestyle” businesses (companies that might provide a good income to the entrepreneurs, but have little opportunity for a sale or IPO).

Characteristic (4), the requirement to exit and the focus on financial return, is a key distinction between venture capital and **strategic investing** done by large corporations. As a perpetual entity, a corporation can afford to take stakes in other businesses with the intention of earning income, forming long-term alliances, and providing access to new capabilities. It is possible for the corporation to maintain this stake indefinitely.

A strategic investor may satisfy all the other characteristics, but without the need to exit, the strategic investor will choose and evaluate investments very differently from a VC. In some cases, a corporation may set up an internal venture

capital division. In the industry, this is referred to as **corporate venture capital**. This label can be confusing, as only sometimes do such divisions satisfy characteristic (4). These corporate VC efforts will often have strategic objectives other than financial returns and will have neither dedicated supplies of capital nor an expectation that capital will be returned within a set time period. When (4) is not satisfied, the investment activity can take on a very different flavor than the type studied in this book.

The requirement to exit provides a clear focus for VC investing activities. There are over 20 million businesses in the United States; more than 99 percent of these businesses would meet the government definition of a “small business”.³ In general, small businesses are difficult to exit, and only “large businesses”—those in the top 1 percent of all businesses—have a realistic chance to go public or be sold in a liquid acquisition market. It is therefore typical for VCs to invest in small businesses—but they only do so when these small companies have a realistic chance to grow enough to become a large company within five to seven years after the initial investment. Such rapid growth is difficult to attain in most industries; therefore, VCs tend to focus on high-technology industries, where new products can potentially penetrate (or even create) large markets.

Characteristic (5) refers to “internal growth”, by which we mean that the investment proceeds are used to build *new* businesses, not to acquire existing businesses. Although the legendary VC investments tend to be those adventurous VCs who backed “three guys in a garage”, the reality of VC investing is much more varied. As a simple classification, we divide portfolio companies into three **stages: early-stage, mid-stage** (also called **expansion-stage**), and **late-stage**. At one extreme, early-stage companies include everything through the initial commercialization of a product. At the other extreme, late-stage companies are businesses with a proven product and either profits or a clear path toward profitability. A late-stage VC portfolio company should be able to see a plausible exit on the horizon. This leaves mid-stage (expansion) companies, who represent the vast landscape between early-stage and late-stage. With all this territory to cover, it is not surprising that mid-stage investments make up the majority of VC investment. In Section 1.4.1 of this chapter, we give more precise definitions of these stages, along with evidence about the investment patterns by stage.

Characteristic (5) also allows us to distinguish VC from other types of private equity. Exhibit 1-2 illustrates the overlapping structure of the four main types of private equity investing and also shows the intersection of these types with **hedge funds**, another category of alternative investments. The relationship between private equity and hedge funds will be discussed below.

The largest rectangle in the exhibit contains all of alternative investing, of which private equity and hedge funds are only two of many components. These components are represented by two smaller rectangles within alternative investing.

³See <http://www.sba.gov/size/>

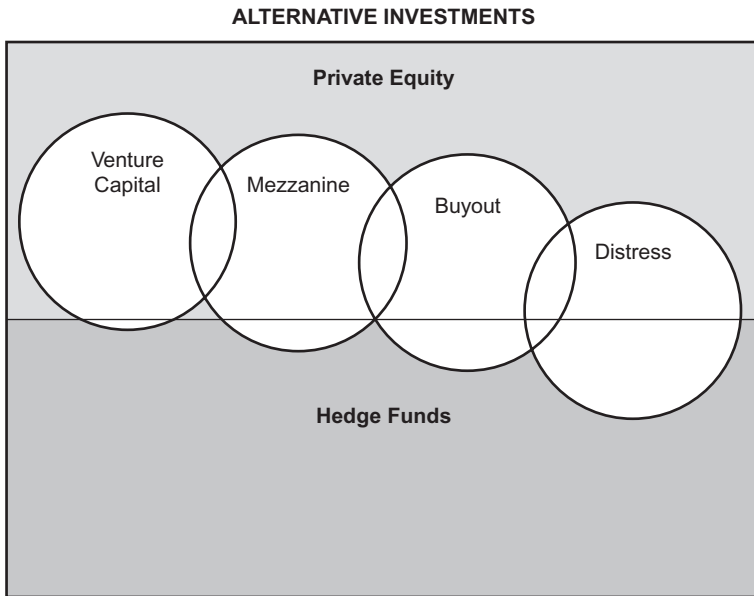
EXHIBIT 1-2**PRIVATE EQUITY AND HEDGE FUNDS**

The different types of private equity investing are represented by the overlapping circles within private equity, with some overlap with hedge funds. The sizes of the circles and rectangles are not matched to the scale of the investing categories, but rather are intended to illustrate the relative scopes of overlap.

Venture capital sits on the far left of Exhibit 1-2 and intersects with the **mezzanine** category. The term *mezzanine* has developed two distinct meanings within the private equity industry. The first meaning is a form of late-stage (often very late-stage) venture capital. Some VC funds do this kind of investing (hence the intersection); but so do other financial intermediaries, including hedge funds, banks, insurance companies, specialty finance corporations, and non-VC private equity funds. This financing is typically in the form of subordinated debt (junior to bank loans), with some additional equity participation in the form of options (warrants) to buy common stock. Some firms refer to this kind of investing as **growth capital**. The second meaning of “mezzanine” first arose in the mid-1980s, when investors began to use the same capital structure—subordinated debt with some equity participation—to provide another layer of debt financing for highly leveraged buyout (LBO) transactions. Today, most private equity firms with “mezzanine” in their title are doing this second type of investing.

Because the subordinated debt in mezzanine investing will often be attached to some equity ownership, mezzanine investing can also intersect with the pure equity investing done in buyouts, the next category in Exhibit 1-2. Buyout investing is the largest category of private equity, with total funds under management about three times as great as for venture capital. Buyout investors pursue a variety of strategies, but a key feature of buyout investors is that they almost always take majority control of their portfolio companies. (In contrast, VCs usually take minority stakes in their portfolio companies.) Large buyouts of public companies typically garner the biggest headlines, and the most famous buyout of all time—the \$25 billion purchase of RJR Nabisco by Kohlberg, Kravis, and Roberts (KKR) in 1989—was the largest transaction of its kind until 2007, when KKR, Texas Pacific Group, and Goldman Sachs bought TXU Corp. for \$45 billion. In these large buyouts, the investors put up the equity stake (these days it is usually between 20 and 40 percent of the total purchase price) and then borrow the rest from banks, public markets (noninvestment grade or “junk bonds”), and mezzanine investors—hence the term **leveraged buyouts (LBOs)**.

Despite the publicity generated by these large buyouts, most buyout firms are engaged in more everyday deals involving the purchase of “middle-market” companies. Although some of these so-called middle-market companies may qualify among the largest 1 percent, many of them still lack the growth potential to generate much interest from public markets. This is typically because the company is in an older industry that has more stable cash flows and limited potential for internal growth. In this case, private equity investors can create liquidity for the current owners through a buyout. Such buyouts do not always include leverage. A related strategy is “buy-and-build”, where a buyout investor will acquire a series of firms in a fragmented industry for the purpose of taking advantage of changes in the optimal industrial scale. Although buy-and-build is a growth investment strategy, the growth comes *externally* from the purchase of existing businesses.

The final category of private equity is **distress investing**, also called **special situations**. As the name suggests, distress investors focus on troubled companies. Because many distress investments are buyouts, this category intersects with the previous one. Some private equity investors do both traditional leveraged buyouts and distress buyouts, but most investors specialize in either one or the other.

A separate category of alternative investing, hedge funds, is also included in Exhibit 1-2. Hedge funds are flexible investing vehicles that share many characteristics of private equity funds, including the limited partnership structure and the forms of GP compensation. The main difference, however, is that hedge funds tend to invest in public securities. A good example of this distinction can be seen in the area of distress investing, the area with the greatest overlap for private equity and hedge fund investors. The private equity funds that engage in distress investing usually do so with the intention of gaining control of the distressed company (or some subset of the company). These investors then operate and restructure the company before reselling it to another investor or to the public markets. Hedge funds also engage in distress investing, but their main strategy is to

trade in the public securities of distressed companies with the intention of making a trading profit by quickly reselling these securities. In recent years, the distinction between hedge funds and private equity funds has grown more blurred, with some hedge funds beginning to invade the traditional private equity territory, particularly in the buyout and distress space. For now, traditional VC investing, with its long holding periods and relatively small investments, remains relatively free of hedge fund involvement.

Although there are exceptions to this pattern, the basic distinction is that while private equity funds are long-term investors, hedge funds are short-term traders. Both strategies have the potential for outstanding returns, but the skill sets and investment approaches are different enough that it is rare that a single individual can excel at both. However, because their investments are more liquid than those for private equity investors, hedge funds can offer their investors faster access to their money, with withdrawals usually allowed on a quarterly or annual basis. This is a case of form following function: if you have an investment strategy in illiquid assets, then you need to lock up your investors for a long period of time (private equity); if you have an investment strategy in liquid assets, then you can allow for quicker withdrawals (hedge funds). Although hedge funds have occasionally crossed over to private equity, any large-scale crossover would require a change of contractual form toward a longer lockup. At that point, they would become private equity funds.

1.2 WHAT DO VENTURE CAPITALISTS DO?

VC activities can be broken into three main groups: **investing**, **monitoring**, and **exiting**. In later chapters, we will describe these activities in more detail. For now, we will give brief summaries of each group and use these summaries to define the scope of this book.

Investing begins with VCs prospecting for new opportunities and does not end until a contract has been signed. For every investment made, a VC may **screen** hundreds of possibilities. Out of these hundreds, perhaps a few dozen will be worthy of detailed attention, and fewer still will merit a preliminary offer. Preliminary offers are made with a **term sheet**, which outlines the proposed valuation, type of security, and proposed control rights for the investors. If this term sheet is accepted by the company, then the VC performs extensive **due diligence** by analyzing every aspect of the company. If the VC is satisfied, then all parties negotiate the final set of terms to be included in the formal set of contracts to be signed in the final **closing**. These investing activities—especially the term sheet valuation and structure—are ideal topics for financial analysis and are the main subjects of this book.

Once an investment is made, the VC begins working with the company through board meetings, recruiting, and regular advice. Together, these activities comprise the **monitoring** group. Many VCs argue that these activities provide the best opportunity to add value and are the main source of comparative advantage for

a successful VC. This argument may indeed be correct, but monitoring activities do not lend themselves well to quantitative analysis. Thus, aside from a discussion of the academic literature in Chapter 5, we will not go into monitoring in this text.

The final group of activities is **exiting**. As discussed earlier, VCs are financial intermediaries with a contractual obligation to return capital to their investors. However, the exit process itself requires knowledge and skills that are somewhat distinct from the earlier investment and monitoring activities. VCs plan their exit strategies carefully, usually in consultation with investment bankers. A typical IPO underwritten by a top investment bank will sell at least \$50 million of new stock and have a total equity value of at least \$200 million. Historically, the IPO has been the source of the most lucrative exits. The main alternative to the IPO is a sale to a strategic buyer, usually a large corporation. Sometimes these sales can be very profitable for the VC, but only if there is significant competition for the deal, which often includes the possibility of an IPO. Financial analysis is crucial for the valuation of IPO firms and acquisition candidates, and this analysis is discussed at length in the rest of this book.

1.3 THE HISTORY OF VENTURE CAPITAL

Equity investments in risky new ventures are as old as commerce itself. The modern organizational form of venture capital, however, dates back only to 1946. Bank lending rules then (and now) looked for evidence that borrowers had collateral and could make timely payments of interest and principal. Most entrepreneurial firms, however, didn't meet these standards, so they required risk capital in the form of equity. There was usually no regular source of such capital, meaning that entrepreneurs without wealthy friends or family had little opportunity to fund their ventures. Along came George Doriot to solve this problem. General Doriot, so called for his rank in the U.S. Army quartermaster's office during World War II, recognized the need for risk capital and created a firm to supply it. His firm, American Research and Development Corporation (ARD), began operations in 1946 as the first true VC firm. Unlike modern funds, it was organized as a corporation and was publicly traded. In its 25-year existence as a public company, ARD earned annualized returns for its investors of 15.8 percent.⁴ ARD also set a standard for generating these returns that has persisted to the present day. Excluding the \$70,000 investment in their biggest "home run", the Digital Equipment Corporation, ARD's 25-year annualized performance drops to 7.4 percent. Many modern venture capitalists spend their days searching for their own home runs, now with more fanciful names like Yahoo!, eBay, and Google—all firms that started as venture capital investments and made legendary reputations for their investors.

Today, venture capital is a well-established business throughout the developed world, but remains quite geographically concentrated both across and within

⁴Fenn, Liang, and Prowse (1998).

countries, with the United States still comprising nearly half the VC activity in the world.⁵ Because the United States represents so much of the worldwide VC industry, the data providers have followed the money, and we now know much more about American VCs than we do about those of the rest of the world. In this chapter, we focus on the history and statistics from the well-studied U.S. market, and most of this book will refer to U.S. data and legal structures. This focus on the United States does not limit the applicability of the analysis, because most global VCs follow U.S. practices. Most importantly for our purposes, the financial concepts of VC investing are universal, and all the quantitative analysis in this book can be applied to VC investments anywhere in the world. In Chapter 6, we provide statistics on the world distribution of VC and discuss some reasons for the observed patterns.

General Doriot's innovation in 1946 did not change the world overnight, and even ten years later the VC landscape remained barren. In recognition of this problem faced by small-growth businesses, the U.S. government began its own VC efforts as part of the Small Business Act of 1958, which was legislation that created the Small Business Administration and allowed the creation of **Small Business Investment Companies (SBICs)**. Perhaps the greatest success of the SBIC program was to provide a vehicle to train a pool of professional VCs for the later decades. SBICs still exist today and share many characteristics of modern VC firms; however, regulatory restrictions affiliated with SBICs keep it from becoming the dominant institutional form.

An important milestone for the VC industry came in the 1960s with the development of the limited partnerships for VC investments. In this arrangement, limited partners put up the capital, with a few percentage points of this capital paid every year for the **management fees** of the fund. The remaining capital is then invested by the general partner in private companies. Successful investments are exited, either through a private sale or a public offering, before the ten-year life of the partnership expires. The most common profit-sharing arrangement is an 80–20 split: after returning all the original investment to the limited partners, the general partner keeps 20 percent of everything else.

This profit sharing, known as **carried interest**, is the incentive that makes private equity investing so enticing for investment professionals. In recent years, the most successful general partners have demanded—and received—as much as 30 percent carried interest on new partnerships. Limited partnerships are by far the most common form of organization in the VC industry, and in Chapter 2 we will discuss these partnerships in detail.

Despite inroads made by SBICs and the new limited partnerships, total VC fundraising in the United States was still less than \$1 billion a year throughout the 1970s. The next big change for VC came in 1979, when the relaxation of investment rules for U.S. pension funds led to historically large inflows from these investors to the asset class. To this day, pension funds continue to supply nearly half of all the money for VC in the United States.

⁵PricewaterhouseCoopers, Global Private Equity Report 2008, p. 44.

EXHIBIT 1-3

VC INVESTMENT, PREBOOM (IN \$B)

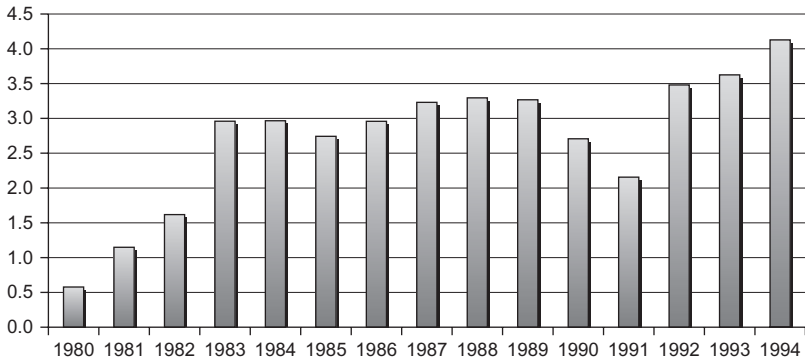

SOURCE: National Venture Capital Association Yearbooks.

The participation by pension funds hastened the participation by other institutional investors, and the modern era of venture capital began. Exhibit 1-3 displays the total amount of venture capital invested by year from 1980 to 1994.

Investing activity rose sharply to \$3B in 1983 and remained remarkably stable through the 1980s. After a slight drop in 1990–1991, VC investment began a steady climb; from \$2.2B in 1991, it rose gradually to \$4.1B in 1994. We refer to these first 15 years of the modern VC industry as the **preboom period**. As shown in Exhibit 1-4, it was in 1995 that investment really began to grow quickly.

EXHIBIT 1-4

VC INVESTMENT, BOOM AND POSTBOOM (IN \$B)

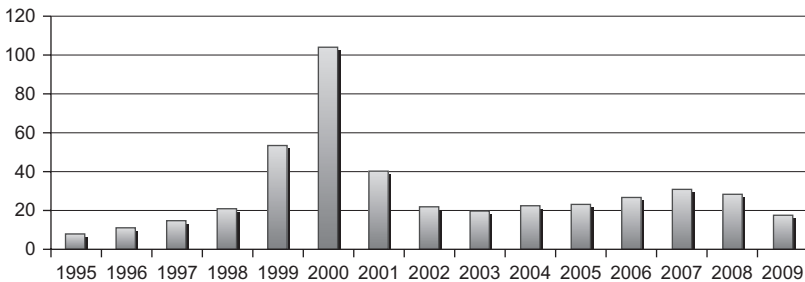

SOURCE: 2009 NVCA Yearbook, NVCA website.

Exhibit 1-4 shows investment nearly doubling to \$7.9B in 1995 (from \$4.1B in 1994) at the beginning of an incredible growth period. This was the dawn of the Internet era, and some of the VC investments made in 1995 and 1996 had spectacular returns. This caused institutional investors to rush for a piece of the asset class, and investments rose to \$11.0B in 1996, \$14.7B in 1997, and \$20.9B in 1998—before exploding to the previously unimaginable levels of \$53.4B in 1999 and \$104.0B in 2000. For obvious reasons, we refer to 1995 to 2000 as the **boom period**.

As the euphoria faded in the early 21st century, VCs still had large commitments from their investors, and many portfolio companies—funded in the late 1990s and 2000—were hungry for follow-on investments. Still, spending fell to \$40.3B in 2001 before leveling off at between \$20B and \$30B in the subsequent years. We refer to the years after 2000 as the **postboom period**. Indeed, the boom period ended abruptly at the end of 2000, as investment fell by nearly half from the fourth quarter of 2000 to the first quarter of 2001.

Although the postboom numbers are well below the peak of 2000, they still represent a considerable increase on investment prior to 1995. This can be seen by looking at VC investment as a fraction of GDP, where VC investment hit a new peak of 0.084 percent in 1983 and fell steadily to its modern all-time low of 0.036 percent in 1991 before rising to 0.058 percent at the end of the preboom period in 1994. The percentage jumped to 0.106 percent to mark the beginning of the boom period in 1995, then rose steadily to hit 0.571 percent in 1999 and its maximum of 1.045 percent in 2000. In the postboom period, the percentage has leveled off to about 0.2 percent in 2002–2008, well above the levels of the 1980s and approximately the same as the percentages in 1997 and 1998.

It is difficult to put these investment levels in perspective without some model of VC's place in the economy. How can we tell if the new levels of investment (\$20–30B, or 0.2 percent of GDP) is too low, too high, or just right? One way to approach this question is to start with the definition of VC at the beginning of this chapter. There, we discussed how VCs invest in small companies that have the potential to become large quickly through internal growth. To qualify, a company usually needs some sort of product innovation, usually a novel item that can penetrate a large market. Sometimes the proposed innovation is high tech, such as a new drug or a new type of software. Alternatively, the innovation might be in a business process, where an early mover could erect barriers to entry by competitors. Many of the Internet startups took this route, although most of them unfortunately ignored the requirement that there be a barrier to entry.

With this framework, we can see that it is not just an innovation that is necessary, but rather an innovation that should be made by a small company. Tremendous innovation goes on all the time in large companies, and large companies are the optimal place for the majority of high-tech innovations. With large research staffs, a stockpile of trade secrets, and decades of organizational learning, companies like IBM, Microsoft, Intel, Pfizer, and Merck are factories of innovation. If a small

company proposed to develop, build, and sell a new microprocessor for personal computers, it would face almost certain failure in the face of the industry giants. If, however, a small company proposed to develop a small piece of the technology for such microprocessors—a piece that could be patented and potentially licensed across a wide range of products—then this might be (and has been) accomplished.

So how much innovation should occur in small companies? In general, this will depend on the factors that drive the optimal scale of an innovative enterprise. In the 1990s, communications technology changed radically, with development of the Internet occurring alongside large price decreases for telecommunications. This communications revolution was real, even if some potential profits from the revolution proved to be illusory. Lower costs of communication opened up new opportunities for market transactions, with lower transaction costs than traditional methods. According to the theory of the firm first introduced by Ronald Coase in 1937, a universal reduction in transaction costs should reduce the optimal scale of firms and allow for greater levels of innovation by small companies.

By this reasoning, the higher levels of VC investment that we see today—as compared to the 1980s—may indeed represent an optimal reaction to structural changes in the economy. Even the massive investments of 1999 and 2000, although clearly excessive in some respects, also appear to be at least in part a response to rapid changes in transaction costs. Prior to the Internet era, national retail brands required massive infrastructure and logistics support. With the Internet, retailers could operate from a single location, and consumers could find them from anywhere in the world.

The organizational constraints of large enterprises seemed to prevent the rapid competitive reactions that could have stifled some of these innovations. For example, large booksellers such as Barnes and Noble already possessed the brand name, the infrastructure, and the inventory to compete effectively as online booksellers. Nevertheless, Amazon.com, a venture-backed startup, managed to out-innovate and out-compete them, to the point that Amazon's business became far more valuable than that of its older competitor. Amazon, although among the most successful, is one of many examples of successful entrants that relied on the new communications technology.

1.4 PATTERNS OF VC INVESTMENT IN THE UNITED STATES

In this section, we provide evidence about VC investing by stage, industry, and region.

1.4.1 Investments by Stage

There are many steps, or stages, to building a new VC-backed business. In Section 1.1, we introduced the terminology for the three broad stages: early-stage, mid-stage, and

late-stage. A more complete description of these stages, along with some sub-categories, is found in Exhibit 1-5.

EXHIBIT 1-5

STAGES OF GROWTH⁶

Seed/Startup Stage Financing

This stage is a relatively small amount of capital provided to an inventor or entrepreneur to prove a concept. If the initial steps are successful, this may involve product development, market research, building a management team, and developing a business plan. This is a pre-marketing stage.

Early Stage Financing

This stage provides financing to companies completing development where products are mostly in testing or pilot production. In some cases, products may have just been made commercially available. Companies may be in the process of organizing, or they may already be in business for three years or less. Usually such firms will have made market studies, assembled the key management, developed a business plan, and are ready to or have already started conducting business. This involves the first round of financing following startup, which includes an institutional venture capital fund. Seed and startup financing tend to involve angel investors more than institutional investors. The networking capabilities of the venture capitalists are used more here than in more advanced stages.

Expansion (Mid) Stage Financing

This stage involves applying working capital to the initial expansion of a company. The company is now producing and shipping and has growing accounts receivable and inventories. It may or may not be showing a profit. Some of the uses of capital may include further plant expansion, marketing, or development of an improved product. More institutional investors are likely to be included along with initial investors from previous rounds. The VC's role in this stage involves a switch from a support role to a more strategic role.

Later Stage

Capital in this stage is provided for companies that have reached a fairly stable growth rate—that is, companies that are not growing as fast as the rates attained in the expansion stages. Again, these companies may or may not be profitable, but are more likely to be profitable than in previous stages of development. Other financial characteristics of these companies include positive cash flow. This also includes companies considering IPOs.

⁶These descriptions are nearly verbatim from the 2009 National Venture Capital Association Yearbook, p. 87.

The main theme of next exhibit is the steady trend toward later-stage investing. In the early 1980s, the three categories of “seed/startup”, “early”, and “expansion” were approximately equal, and “later stage” was the smallest. This pattern reflects VC’s focus on true startups in the early years of the industry. Gradually, new VC firms were created to focus on later stages, and some of the original firms grew so large from their successes that they needed to find larger investments to put all their capital to work. By the mid-1990s, expansion stage investments were larger than all early-stage investments (seed/startup plus other early-stage), and later-stage investments exceeded those in seed/startup. By the late 1990s, angel investors had largely replaced VCs at the seed/startup stage, and expansion investments comprised more than half of all VC investments. More recently, there are modest reversals in this trend, with the share of startup/seed investments exceeding 5 percent of total for the first time since 1999, while the share of expansion investments declined to less than 40 percent in 2008.

The definition of the company stage should not be confused with the definition of the **financing round**. The negotiation of a VC investment is a time-consuming and economically costly process for all parties. Because of these costs, neither the VCs nor the portfolio firms want to repeat the process very often. Typically, a VC will try to provide sufficient financing for a company to reach some natural milestone, such as the development of a prototype product, the acquisition of a major customer, or a cash-flow breakeven point. Each financing event is known as a **round**, so the first time a company receives financing is known as the **first round** (or **Series A**), the next time is the **second round** (or **Series B**), and so on. With each well-defined milestone, the parties can return to the negotiating table with some new information. These milestones differ across industries and depend on market conditions; a company might receive several rounds of investment at any stage, or it might receive sufficient investment in one round to bypass multiple stages.

With these definitions in hand, we are now ready to examine the investment patterns by stage. Exhibit 1-6 illustrates these patterns by plotting the percentage of investment each year by stage.

1.4.2 Investments by Industry

Traditionally, VC investments have been concentrated in two broad sectors: health care and information technology (IT), where the latter sector is defined to include the communications, semiconductor, software, and hardware industries. This concentration is no accident: because VCs invest in small companies with the potential to quickly grow large, they need to look for businesses with large, addressable markets. To make headway in such markets, a business usually needs a technological advantage of some kind—hence the VC focus on the high-tech industries of health care and IT. Of course, other industries can also provide these opportunities,

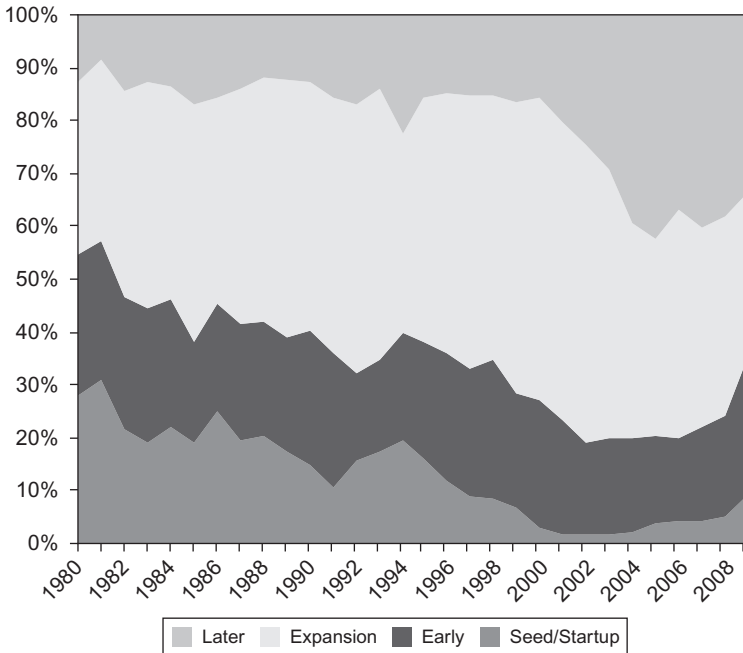
EXHIBIT 1-6*VC INVESTMENT BY STAGE*

SOURCE: 2009 NVCA Yearbook, NVCA website.

particularly during times of disruptive economic change. The communications revolution of the late 1990s provided such an opportunity for Internet-based retail businesses, and periodic oil shocks have provided the impetus for energy investments.

Exhibit 1-7 illustrates the industry concentration of VC investment for three periods: the preboom period of 1980–1994, the boom period of 1995–2000, and the postboom period of 2001–2009. The data show the dominance of IT (including communications, software, hardware, and semiconductors/electronics) and health care (including biotech and medical devices) for VC investment; together, these two sectors comprise about 75 and 80 percent of all investments in the preboom and postboom period, respectively. During the boom, media/retail investment had a brief (and expensive) rise, but even then the main story was the enormous increase in IT relative to health care. Within the

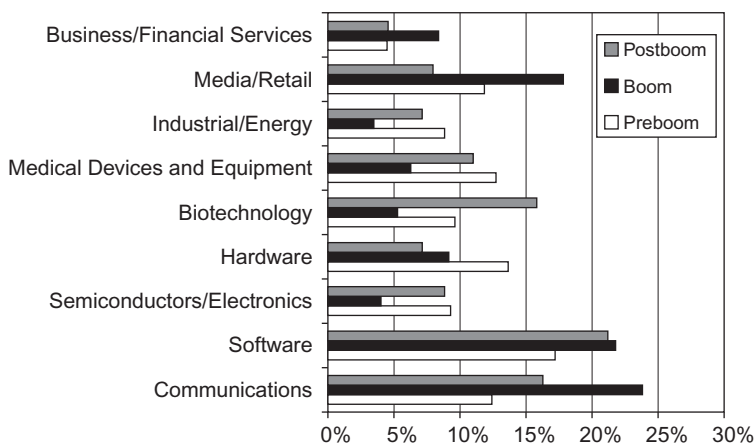
EXHIBIT 1-7**VC INVESTMENT BY INDUSTRY**

SOURCE: Various years, NVCA Yearbooks.

broad IT sector, the two most important industries in the boom and post-boom periods were communications and software, followed by semiconductors/electronics and hardware. Within health care, the story has been a gradual emergence of biotechnology as the dominant industry, receiving almost 60 percent of total health care investment in recent years.

1.4.3 Investments by U.S. Region

With all the evidence of globalization in manufacturing and IT services, the U.S. regional concentration of VC investment is particularly striking. Since the beginnings of the industry, the Silicon Valley area of northern California has remained the epicenter of VC activity, with a consistent share of about one-third of total U.S. VC investments per year. The area surrounding Boston has remained a secondary center for most of this time, with between 10 and 15 percent share of the total. Exhibit 1-8 illustrates the distribution of VC investment for these centers and other U.S. regions for 2008.

The dominance of Silicon Valley and New England (mainly Boston) hides some important globalizing forces. Although companies headquartered in these two regions receive almost half of all VC dollars, much of these funds are then reinvested in foreign operations, particularly in India, by IT companies. This is a 21st-century phenomenon that has taken the industry by storm. Although it is

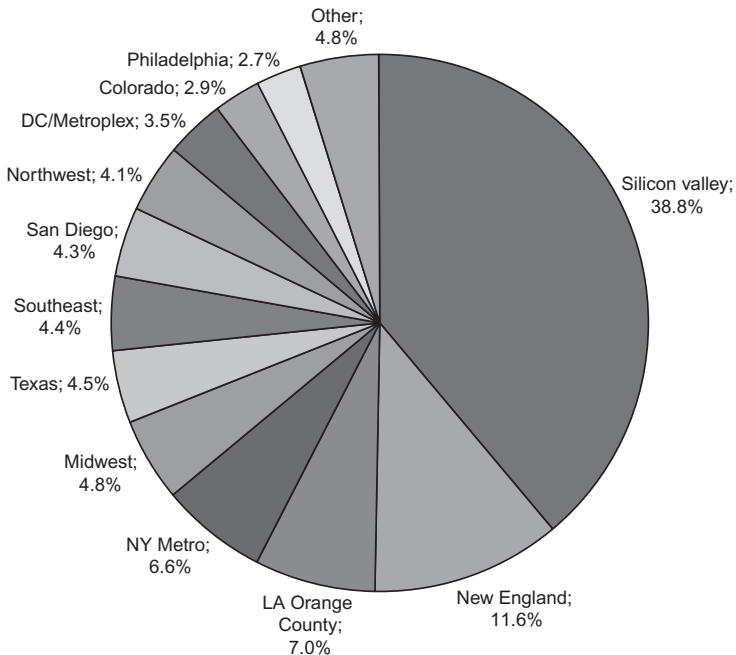
EXHIBIT 1-8**REGIONAL DISTRIBUTION OF VC INVESTMENT**

SOURCE: 2009 NVCA Yearbook.

difficult to find hard numbers to document this trend, such outsourcing is a common topic of conversation among VCs.

SUMMARY

Venture capitalists (VCs) primarily invest in young, high-technology companies that have a capacity for rapid growth. VCs are a type of financial intermediary that perform three main functions, which are (1) screening potential investments and deciding on companies to invest in, (2) monitoring these companies and providing value-added services for them, and (3) exiting their investments in these companies by selling their stake to public markets or to another buyer. Venture capital is a form of private equity, which is an investment that cannot be traded in public markets. Without the information flow and liquidity of public markets, VC investing offers greater opportunities for both huge gains and terrible losses.

The modern VC industry effectively began in 1946 and grew slowly for its first 35 years. Beginning in the early 1980s, new sources of capital from pension funds led to

rapid growth. This period of rapid growth leveled off in the mid-1980s and resumed in the mid-1990s, culminating in a boom and crash at the turn of the century. The United States is the world leader in VC, with about 40 percent of the worldwide investment and industry-leading practices. Within the United States, information technology and health care are the dominant sectors for VC investment, and Silicon Valley and the area around Boston, Massachusetts, garner roughly half of all the domestic venture capital.

KEY TERMS

Venture capital (VC) and venture capitalists (VCs)	Alternative investments	Hedge funds
Screen	Private equity	Term sheet
Monitor	Strategic investing	Due diligence
Exit	Corporate venture capital	Management fees
Financial intermediary	Preboom, boom, postboom periods	Carried interest
Limited partnership, limited partner, general partner	Early-stage, mid-stage (expansion), late-stage	Seed stage, Startup stage
Portfolio companies	Mezzanine	Financing Round, First round (Series A), Second round (Series B)
Small Business Investment Companies (SBICs)	Growth capital	
Initial public offering (IPO)	Leveraged buyouts (LBOs)	
Angel investors = angels	Distress investing= special situations	

REFERENCES

- Coase, Ronald, 1937, "The Nature of the Firm", *Economica*.
- Fenn, George, Nellie Liang, and Stephen Prowse, 1998, "The Private Equity Market: An Overview", *Financial Markets, Institutions & Instruments* 6(4).
- National Venture Capital Association, *The NVCA Yearbooks*, various years.

CHAPTER 2

VC PLAYERS

THIS CHAPTER introduces the key players in the VC industry. In Section 2.1, we discuss the relationships among VC firms, VC funds, and the VCs who work at them. In Section 2.2, we provide statistics on the investors in VC funds and discuss the importance of various investor types. Section 2.3 analyzes the contractual structure and compensation arrangements between VCs and their investors.

2.1 FIRMS AND FUNDS

About 80 percent of the organized VC market is controlled by independent **VC firms**. VC firms are small organizations, averaging about 10 professionals, who serve as the **general partner (GP)** for **VC funds**. A VC fund is a limited partnership with a finite lifetime (usually 10 years plus optional extensions of a few years). The **limited partners (LPs)** of VC funds are mostly institutional investors, such as pension funds, university endowments, and large corporations. When a fund is first **raised**, the LPs promise to provide a certain amount of capital, which will be provided either on a set schedule or at the discretion of the GP. These periodic capital provisions are known as **capital calls**, **drawdowns**, or **takedowns**. The total amount of capital promised by the LPs over the lifetime of the fund is called the **committed capital** of the fund.¹ Once the GP has raised the full amount of committed capital and is ready to start investing, we say that the fund has been **closed**. The typical fund will invest in portfolio companies and draw down capital over its first five years. These years are known as the **investment period** or **commitment period**. After the investment period is over, the VC can only make **follow-on investments** in current portfolio companies. A successful VC firm will raise a new fund every few years so that there is always at least one fund in the investment period at all times.

Most VC firms specialize their funds by stage, industry, and/or geography. For example, an **early-stage fund** would make initial investments in early-stage companies, with some capital reserved to make follow-on investments in these companies in their later stages. A **late-stage fund** would typically avoid all early-stage companies,

¹Typically, about 1% of the committed capital is provided by the GP itself. Throughout this textbook, we will ignore this small GP contribution and pretend as if all committed capital is coming from the LPs.

focusing on expansion and later-stage investments. Most VC firms keep the same stage focus for all their funds, but some will change focus over time or mix the two strategies at once in a **multistage fund**. A few firms raise separate early-stage and late-stage funds for overlapping periods and assign different professionals to each fund.

There is a wide dispersion in the levels of industry focus, with many generalists (a fund that is willing to invest in both IT and health care is effectively a generalist) and others with a relatively narrow focus on sectors like energy or financial services. As for geographic focus, it is important to recognize that much of the activity experienced by VCs is local, and as a result the location of the VC's office will usually be highly correlated with the location of most of their portfolio companies. Not surprisingly, the geography of VC offices is very similar to the geography of VC investment shown in Exhibit 1-8. Because funds tend to be geographically focused wherever their offices are, the main way to attain reliable geographic diversity is to have multiple offices.

Throughout this book, we will use a few prototype VC funds as example investors. Because the compensation structures and partnership agreements of VCs are an important driver of their investment incentives, it is useful to write down some key terms from these agreements for our prototype funds. We do this in the appendices to this chapter: Appendix 2.A shows some key terms for EarlyBird Ventures Fund I, which is a \$100M initial fund raised for an early-stage investor; Appendix 2.B shows some key terms for Talltree Ventures IV, the \$250M fourth fund raised by a multistage firm; and Appendix 2.C shows some key terms for Owl Ventures IX, a \$500M ninth fund raised by a late-stage firm with a stellar reputation and excellent track record. We will refer to these appendices several times in this chapter and later on in the text.

Exhibit 2-1 gives a timeline for several funds for one of our prototype VC firms, EarlyBird Ventures (EBV).² A firm will usually number its successive funds, so EarlyBird Ventures I is known to be the first fund raised by EBV, EarlyBird Ventures II was the second fund, and so on. In this example, EBV raises its first fund, EBV I, in 1994 with \$100M in committed capital. (Think of EBV I as the fund described in Appendix 2.A.) In future years, the performance of EBV I will be compared to other funds raised in 1994; in industry parlance, all such funds will have 1994 as their **vintage year**. This borrowed terminology from the wine industry is appropriate: just as the weather conditions of certain years are better for growing grapes, the economic conditions of certain years are better for growing companies. By comparing the performance of EBV I with other funds of the same vintage year, future investors can make a fair evaluation of EBV's performance as a GP.³

²All of our prototype funds are fictitious. Any resemblance to real funds, living or dead, are purely coincidental. In case some readers are wondering, we were not aware at the time of writing this textbook that there exists an actual early technology investment firm called Earlybird in Germany.

³However, please note that some firms keep us on our toes by giving their funds a completely different name from their firm name.

EXHIBIT 2-1*EARLYBIRD VENTURES TIMELINE*

Fund Name	Vintage Year	Committed Capital
Early Bird Ventures I	1994	\$100 M
Early Bird Ventures II	1998	\$250 M
Early Bird Ventures III	2000	\$1B
Early Bird Ventures IV	2005	\$300 M
Early Bird Ventures V	2009	\$300 M

By 1998, most of EBV I has been invested. We assume here that EBV I look good relative to other funds with a 1994 vintage year, so it is able to raise a larger fund, EBV II, in 1998. It invests this fund rapidly in the boom years of 1999 and 2000 and returns to raise an even larger fund, EBV III, of \$1 billion in 2000. By 2000, in addition to EBV III, it has two funds, EBV I and II, which are no longer making any new investments but still have some investments outstanding. When the market loses steam, it invests this fund slowly and with much less success than its earlier funds. Nevertheless, its earlier reputation allows the firm to return to the market, somewhat chastened, and raise a \$300M fund, EBV IV, in 2005. By this point, it has closed out all its investments from EBV I and is still trying to exit a few investments from EBV II. As for EBV III, most of the portfolio companies have gone out of business, but it still has modest hopes for some of the survivors. Four years later, in 2009, EBV raises another \$300M fund, EBV V, which is a respectable size given the generally difficult fundraising conditions in the market. EBV I and II are fully liquidated by then; EBV III is almost mature, but many of its portfolio companies are still illiquid.

The experience of EBV is typical for top VC firms since the mid-1990s. Great success for investments at the beginning of the boom, combined with seemingly endless opportunities, led many firms to raise “megafunds” in 1999 and 2000. Whereas billion dollar funds were unheard of before, they became almost commonplace during this time period. With few exceptions, these funds performed terribly, and the surviving firms have returned to raise much smaller funds in recent years.

We can gain a more detailed picture of these trends by looking at some data from the National Venture Capital Association. Exhibit 2-2 gives its estimates on the total number of firms, funds, and VC professionals since 1980.

This data echoes the industry cycles discussed in Chapter 1. Between 1997 and 2001, there was a doubling or near doubling of the total number of VC funds, the total number of VC firms, and the size (capital divided by funds or firms) of these VC funds and VC firms. The size of the industry hit a plateau in 2001 and stayed steady between 2002 and 2006. The industry size started to decline in 2007, and between

EXHIBIT 2-2*VC INDUSTRY SIZE SINCE 1980*

Year	New Funds	New Committed Capital (\$B)	Total Funds	Total Firms	Total Committed Capital (\$B)	Total Principals (Estimate)	Principals Per Firm
1980	52	2.0	129	92	4.1	1,435	15.6
1981	75	1.5	188	127	6.1	1,805	14.2
1982	87	1.7	248	162	7.8	2,138	13.2
1983	143	3.9	355	208	11.4	2,600	12.5
1984	116	3.0	459	260	14.6	3,224	12.4
1985	121	4.0	541	297	17.9	3,641	12.3
1986	103	3.8	603	332	21.5	4,038	12.2
1987	116	4.4	681	362	24.2	4,368	12.1
1988	104	4.4	715	377	25.5	4,550	12.1
1989	105	4.9	746	392	28.6	4,770	12.2
1990	87	3.2	734	393	29.2	4,834	12.3
1991	42	2.0	660	373	27.8	4,588	12.3
1992	80	5.2	620	365	28.4	4,563	12.5
1993	88	3.9	625	376	29.8	4,675	12.4
1994	140	8.9	651	389	34.7	4,824	12.4
1995	172	9.9	707	429	40.6	5,320	12.4
1996	162	11.8	773	469	48.9	5,769	12.3
1997	244	19.8	903	548	63.7	6,753	12.3
1998	288	29.7	1,085	624	92	7,550	12.1
1999	451	55.8	1,394	752	145.3	9,123	12.1
2000	653	105.0	1,737	881	225.2	10,684	12.1
2001	321	39.1	1,883	943	253.1	11,340	12.0
2002	206	9.3	1,852	938	253.1	11,186	11.9
2003	163	11.6	1,800	968	254.2	11,112	11.5
2004	219	19.8	1,823	1,003	262.9	10,896	10.9
2005	235	28.7	1,778	1,024	271.4	10,680	10.4
2006	241	31.8	1,722	1,027	278.1	10,260	10.0
2007	247	35.4	1,593	1,019	258.3	8,892	8.7
2008	210	27.9	1,366	882	197.3	7,497	8.5

SOURCE: 2008 and 2009 NVCA Yearbooks.

2007 and 2008 the capital under management fell 24 percent, while the number of firms and the number of principals declined by 13 percent and 16 percent, respectively. The contraction occurred because large funds raised in 2000 were largely rolled out of the industry's managed capital and were replaced by much smaller funds

raised in more recent years. Many firms that raised funds at the height of the bubble are winding down their portfolios and exiting the industry, which also contributes to the decline in the number of firms and principals. This trend is likely to continue for some time to come. Note also that, even with two years of sharp declines, the capital under management is still higher than the 1999 level.

In most years, the total number of funds is about twice as large as the number of firms, indicating that the average firm has two funds alive at any given time. Because of differences in the data collection methods and sample selection, the committed-capital amounts in Exhibit 2-2 are not directly comparable to the investment totals given in Exhibits 1-3 and 1-4. Nevertheless, the general trends are very similar.

One striking aspect of these numbers is that there has been a steady rise in the size of the capital managed per firm and per principal up until 2006–2007, while the number of principals per firm itself held steady at around 12 between the mid 1980s and 2002 and even declined to 8.5 by 2008. Thus, the main trend has been a gradual scaling up of the dollar amount managed per personnel, while the VC firms themselves stayed relatively lean as organizations.

Relative to other investment and professional service firms, VC firms are quite top-heavy and rarely show much of a pyramid structure. Although some VCs entered the industry directly out of school, most came to VC as a second career and entered the profession at a fairly senior level, so there are not as many junior people floating around. Although many people would like to know the best way to prepare for a VC career, there is no “typical” path. Nevertheless, the analysis of hand-collected data on 125 partners from 15 VC firms in Wieland (2009) offers some interesting insights.

In this sample, 60 percent of VC partners hold a bachelor’s, master’s, or doctorate degree in science or engineering. Particularly common is a bachelor’s degree in engineering, which 44 percent of the VCs hold. While 25 percent of VCs hold a master’s degree and 9 percent hold a Ph.D. in engineering or science, the most common postgraduate degree held by VCs are MBA degrees—62 percent hold them. A significant minority—16 percent—also hold a bachelor’s degree in business or economics. As for their professional experience, most of the work experience of individual VCs comes in the form of having worked in the IT or health care sector (78%), having startup experience as either entrepreneur (37%) or managing executive at a startup firm (32%), holding experience as line manager at a listed firm (38%), having worked as industrial engineer (31%) or professional scientist (5%), having worked for another VC firm as investment professional (32%), and holding experience working as strategy consultant (23%) or in finance (14%).⁴ Although an advanced degree is not a necessary requirement, the most notable exceptions are second-career VCs whose first career was as a successful entrepreneur. Indeed, most VCs are in their second career because few jobs are available to new graduates. These first careers might be decades long and consist of top management experience, or they might be

⁴Zarutskie (2009) studies educational and professional backgrounds of first-time VC funds and report similar educational backgrounds: 39% of individual VCs hold a degree in either engineering or science and 58% hold an MBA.

just a few years long, consisting of a few years of experience at a consulting firm or at an investment bank. Consulting and investment banking are not particularly good ways to prepare for a VC career; it is just that many top MBA graduates start there, so that is where the talent is. Many VCs will say that the best preparation for a VC career is to combine technical expertise with industry experience, particularly if that experience is at a startup firm. Many VC hopefuls are understandably reluctant to follow this advice, because the VC industry has cyclical and somewhat fickle preferences about exactly what kind of technical experience is useful, and an unlucky choice of specialization can render a candidate's expertise to be superfluous.

As for the career progression, it does not have many levels. The top level is “partner”, with modifiers in front of that title to indicate experience, past success, and compensation level (e.g., “Managing General Partner” or “Senior Partner”). Although some professionals begin their VC careers as partners—either by raising their own fund or by joining another fund after a very successful first career—most VCs have to work their way up. There are essentially two tracks to make partner. One track, typically followed by younger professionals with a few years of pre-VC experience, is to start as a junior VC with a title like associate, senior associate, or principal. These professionals are not expected to lead transactions or sit on boards in their first few years, but rather spend most of their time screening investments, performing due diligence, and generally helping out the partners. They are expected to learn the business as apprentices, and if they are successful, their responsibilities will be gradually increased. Depending on their past experience, the time path to partnership can vary tremendously. With good timing and good performance, some junior professionals can make partner in as little as two years. At the other extreme, some firms do not treat these junior positions as being on the partner track, sending even their most talented associates back out into the world to gain more experience. Similarly, some firms employ recent college graduates as analysts, with tasks similar to other junior VCs. Although these positions are generally not considered to be on the partner track, analysts who go on to get advanced degrees have great positioning to land a partner-track job in the future.

The second track, typically followed by successful entrepreneurs or senior managers with many years of experience, is to enter with the title of venture partner. This title does not mean that the new VC is a partner in the sense of sharing the profits, but rather it is a way to bring in someone trying out VC as a second career without subjecting them to the same grind or title as a junior professional. Venture partners would typically be expected to take a lead role on investments and to use their industry contacts to bring in new business right from the beginning. In this respect, venture partner is very much a provisional position, with many candidates finding out that the business is not really for them. With one or two successful investments, a venture partner can expect to be admitted into a true partner role. Indeed, venture partners are often paid only small salaries—the idea being that if they are successful, they will quickly earn a partnership.

GPs receive their income from two sources—management fees and carried interest—and these sources must supply all the compensation for the VCs. Base salaries

EXHIBIT 2-3**VC COMPENSATION (IN \$ THOUSANDS)**

Title	2008				2009			
	Salary	Bonus	Carry	Total	Salary	Bonus	Carry	Total
Managing GP	688	633	192	1,513	700	350	101	1,151
Senior Partner	595	350	155	1,100	600	200	50	850
Partner	375	150	35	560	350	130	20	500
Principal/VP	240	78	2	320	206	75	6	287
Senior Associate	155	46	0	201	156	44	1	201
Associate	105	33	0	138	105	35	0	140
Analyst	101	15	0	116	100	10	0	110
Venture Partner	250	0	43	293	185	40	12	237

NOTE: 2008 data are April 1, 2008, salaries and bonus and carry earned in 2007. 2009 data are April 1, 2009, salaries and bonus and carry earned in 2008. The figures are based on annual compensation surveys of VC professionals and samples are not matched across years.

SOURCE: Mike Holt, Founder and Managing Director of Holt Private Equity Consultants and coauthor of *Private Equity Analyst—Holt Compensation Survey*.

can be paid from management fees, and the biggest slice of variable pay comes from the carry. In most funds, the total carry percentage will be divided in advance, with partners knowing what share of the overall carry they are due to receive. Exhibit 2-3 shows compensation levels for salary, bonus, and carried interest for several different job titles. These figures are from the annual *Private Equity Analyst-Holt Compensation Survey*, which in 2008 received data from 46 independent venture capital firms for 16 job titles. Note that salaries are as of April 1st of the survey year, and bonus and carry are earned the year before. Thus, these compensation levels reflect fund performance in the year prior to payment.

The levels are shown for 2008 and for 2009, so one can see the large role played by market conditions. While the bonus levels are largely unchanged, bonus and carry declined in 2009 due to difficult economic times and tough exit conditions for VC-backed companies.

2.2 THE LIMITED PARTNERS

As mentioned in Chapter 1, the first major burst of VC activity was driven by the entry of pension funds as limited partners. Since 1980, pension plans—including those of government entities, private companies, and nonprofit organizations—have provided 44 percent of the committed capital in the VC industry. In addition to pension funds, several other investor groups have played an important role in the

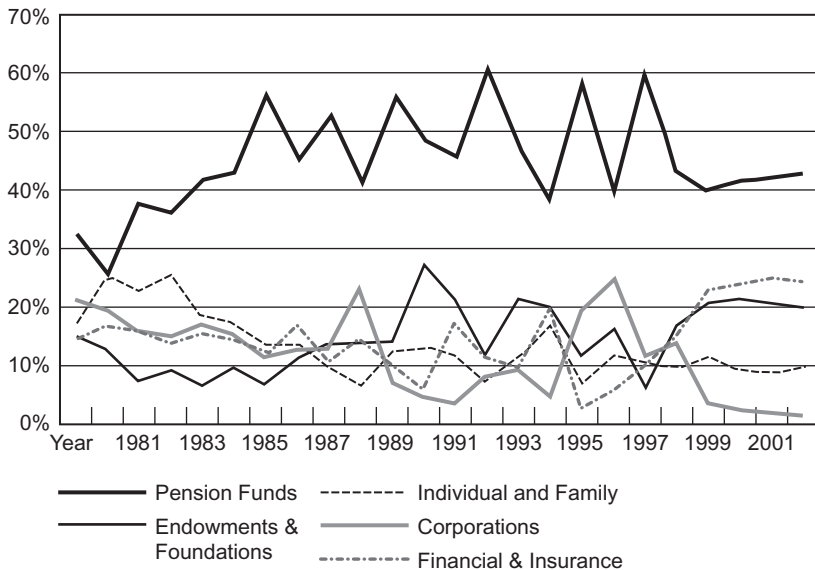
EXHIBIT 2-4*COMMITTED CAPITAL BY LIMITED PARTNER TYPE*

SOURCE: National Venture Capital Association Yearbooks.

development of VC. Exhibit 2-4 shows the fraction of newly committed capital from these groups.⁵

After pension funds, the next largest investor class is financial institutions, which includes commercial banks, investment banks, and insurance companies. Taken together, this group has provided about 18 percent of the committed capital since 1980. Endowments and foundations are next with 17 percent of the total. This group is dominated by large private universities and charitable foundations. In addition to their large supply of capital, these organizations are also the most successful of the investor classes, with returns that far exceed those of the other investors.⁶ Part of the reason for their success is that they have been active and consistent investors since the earliest partnerships were formed in the late 1960s and early 1970s. However, evidence also shows that access to these older funds

⁵NVCA stopped reporting this type of data in recent years, but it appears that the fractions among the groups have not changed significantly. In 2004, the last year the data is publicly available, the breakdown was pension funds (42%), financial and insurance (25%), Endowments and foundations (21%), Individual and family (10%), and Corporations (2%).

⁶Lerner, Schoar, and Wongsunwai (2007) document this performance.

explains only part of their superior returns, and that the endowments have in fact also done very well with their recent partnerships.

Since 1980, individuals and families have contributed about 11 percent of total committed capital, with this fraction falling slightly in recent years. As compared to other investment classes, this participation by individuals is low. Part of the reason for this low participation is that the long horizon of VC investment is comparatively more palatable to institutions than it is to individuals.

Finally, with only 9 percent of the total commitments since 1980, corporations have played a relatively small role as limited partners as compared to the important role of their corporate pension plans. Note also that corporate participation is more variable than it is for other investors, and the importance of corporate LPs has fallen dramatically in recent years. This type of indirect corporate investment as an LP should not be confused with direct corporate investment in portfolio companies, a practice that is known as corporate venture capital. Direct corporate investment is not included in Exhibit 2-4, unless the corporation is included as an LP in its own finite-life corporate VC fund. Because most corporate VC funds are not organized as finite-life limited partnerships, the majority of direct corporate investment is not included in this exhibit.

Exhibit 2-4 defines the fund flow by the ultimate source of capital, but in some cases additional intermediaries stand between the capital provider and the VC. One group of intermediaries deserves special mention: the **fund-of-funds (FOF)**. An FOF is typically organized as a limited partnership, with many of the same rules as other private equity funds, except that, instead of investing directly in companies, the FOF invests in other private-equity funds. For example, FLAG Venture Management is a firm that invests exclusively in other VC firms through FOFs. These FOFs can be quite large: the 2000 Flag Venture Partners Fund IV has committed capital of \$650M; other boom-time FOFs raised multibillion dollar funds. FOFs appeal mostly to wealthy individuals and small institutions that are not large enough to support a diversified portfolio of LP commitments. By pooling their resources in a FOF, a group of smaller investors can gain access to a diversified portfolio of funds and take advantage of the contacts and skills of the specialized FOF intermediary. During the boom period, FOFs intermediated about 5 percent of all commitments to VC funds. FOF firms act as both a GP (to their investors) and an LP (to the funds they invest in). As a GP, they also charge management fees and (sometimes) carried interest, although these charges are always considerably lower than those charged by direct investment firms.

It is important to note that LPs are not just investors, but also really are partners in the fund. Although the day-to-day involvement of LPs is limited by law (otherwise they can lose their limited-liability status), certain LPs are prized as long-run partners, because they have the industry experience and patience to ride out industry cycles and stick with their GPs. Such LPs make the fundraising task much easier for GPs, yielding time savings that can be used to help portfolio companies and to find new investments.

For this reason, it is no accident that endowments and foundations held their positions in the top VC funds even as other LPs were beating down the door. It is

true that during the boom many top GPs did raise their compensation; but it should be noted that they did not raise it to market-clearing levels, instead choosing to keep the same long-term LPs and exclude some newer money. In particular, families and corporations are seen—perhaps justly—as fickle investors and are often shunned by top GPs. In recent years, there has also been pressure on public pension funds and public universities to reveal information about the performance of VCs in their portfolio. A few of these LPs have been forced to reveal performance information, and this disclosure is the source of some of the data analyzed in later chapters. For a variety of reasons, most VCs abhor any kind of public disclosure, so a few of the top GPs have started to bar public LPs from their funds.

2.3 VC PARTNERSHIP AGREEMENTS

Before we are able to understand VC investment decisions, we must first have a working knowledge of VC partnerships. The VC firm serves as the GP of the partnership and is compensated by management fees (discussed in Section 2.3.1) and carried interest (discussed in Section 2.3.2). This compensation structure creates some differences between the incentives of the GP and the LPs, and many partnership agreements include several restrictive covenants to mitigate these differences (discussed in Section 2.3.3). Metrick and Yasuda (2010) analyze terms of fund partnership agreements for 94 VC funds and 144 buyout funds, which they obtained from a large, anonymous LP (the “Investor”); all statistics in Sections 2.3.1 and 2.3.2 are derived from this paper, and we will refer to this data as the “Investor” data.

2.3.1 Management Fees

VC investing is a long-run business, and investors must often wait many years before enjoying any return of capital. Nevertheless, the expenses of VC investing start immediately: salaries must be paid, the lights must stay on, and due diligence must be performed. Thus, a baseline **management fee** is necessary. The typical arrangement is for limited partners to start paying a set percentage of committed capital every year, most commonly 2.0 percent. Sometimes this fee remains constant for the full 10-year life of the fund, but in most cases the fee drops somewhat after the five-year investment period is over.

For any given VC fund, we define the *lifetime fees* as the sum of the annual management fees for the life of that fund. We define the *investment capital* of the fund as being equal to the committed capital of the fund minus the lifetime fees. For example, Appendix 2.A shows that EBV is a \$100M fund with a 10-year life and an annual management fee of 2 percent for all 10 years. Thus, the fund has lifetime fees of \$20M ($= 2\% * \$100M * 10$ years) and investment capital of \$80M ($= \$100M - \$20M$). As is typical, in this case the lifetime fees are a nontrivial fraction of committed capital. EBV will need to earn a 25 percent lifetime return on its investments (\$20M on \$80M investment capital) just to earn back the fees and get to breakeven for its investors.

Our next example uses a more complex fee schedule.

EXAMPLE 2.1

Owl Ventures has raised their \$500M fund, Owl Ventures IX, with terms as given in Appendix 2.C. The management fees given in this appendix are as follows.

Management Fees All management fees are computed based on committed capital. These fees are 2 percent in years 1 and 2, 2.25 percent in years 3 and 4, 2 percent in year 5, 1.75 percent in year 6, 1.50 percent in year 7, 1.25 percent in year 8, 1 percent in year 9, and 0.75 percent in year 10. These fees will be paid quarterly, with equal installments within each year.

Problem Given this description, what are the lifetime fees and investment capital for this fund?

Solution This example uses a fee schedule that starts at 2 percent, and then increases to 2.25 percent in years 3 and 4 before falling by 0.25 percent in each subsequent year. Such “increasing then decreasing” schedules are not unusual, with the logic that fund expenses often reach their maximum in the middle years of the investment period. To compute the lifetime fees, we just add up the fees in each year. Thus,

$$\begin{aligned} \text{Lifetime fees} &= \text{committed capital} * (0.02 + 0.02 + 0.0225 + 0.0225 + 0.02 + 0.0175 \\ &\quad + 0.015 + 0.0125 + 0.01 + 0.0075) \\ &= \text{committed capital} * 0.1675 = \$500\text{M} * 0.1675 = \$83.75\text{M} \end{aligned} \tag{2.1}$$

Then,

$$\begin{aligned} \text{Investment capital} &= \text{committed capital} - \text{lifetime fees} = \$500\text{M} - \$83.75\text{M} \\ &= \$416.25\text{M} \end{aligned} \tag{2.2}$$

This example follows the industry’s standard practice of computing management fees on committed capital. At first glance, this method might seem strange, because other parts of the money management industry have management fees that are computed based on the market value of the portfolio. Why are VC funds different?

There are several reasons. First, if management fees were to be based on portfolio values, then these fees would be low in the first few years (before all the capital was invested), and the VCs might be unable to cover their fixed costs. Second, management fees based on portfolio value would create an incentive for VCs to invest quickly—and this would result in an inevitable sacrifice in quality. Third, because “market” values for the portfolio are hard to calculate for nontraded companies, the level of fees would be somewhat arbitrary.

Although the computation of management fees on committed capital is the most standard arrangement, there are other methods. To understand these other

methods, we introduce a few new definitions. First, **realized investments** are those investments that have been exited or those in companies that have been shut down, and **unrealized investments** are those investments that have not yet been exited in companies that still exist. Next, we define the **cost basis** of an investment as being equal to the dollar amount of the original investment. Finally, we define **invested capital** as the cost basis for the investment capital of the fund that has already been deployed, and **net invested capital** is equal to invested capital minus the cost basis of realized and written-off investments. It is this final definition that is most important for alternative fee structures, for it is common (about 43% of VC funds in the Investor data employ this rule) to see the management fee base change from committed to net invested capital *after* the five-year investment period is over. This hybrid system minimizes the incentive for firms to overinvest in early years, because the fee is still fixed for that time period. Also, because it relies on the cost basis of the investments, it does not require the estimation of market values. In Exercise 2.2, at the end of this chapter, you are asked to solve for the lifetime fees for a fund that uses this hybrid system.

There are two other points worth mentioning. First, although management fees cover most operating expenses, they do not usually cover all of them, and the LPs will still find that some of their investment capital is going to uses other than investments. These other operating expenses charged to the fund might include the organizational costs of setting up the fund, costs of unconsummated transactions, and certain kinds of professional service expenses. Second, our calculations assumed that exit proceeds cannot be reinvested into new portfolio companies. In theory, however, most contracts allow GPs limited reinvestment rights, subject to certain requirements being met. (The most common requirement would be that the original investment was exited quickly, such as within one year.) In practice, these requirements are stringent enough that significant reinvestment is rare. When reinvestment does occur, the sum of investment capital and lifetime fees would be greater than committed capital. However, because reinvestment does not incur any additional management fees, the economics of the reinvestment decision are a bit different from the economics of the original investment. We will address this possibility in Exercise 10.1 in Chapter 10.

2.3.2 Carried Interest

The other form of VC compensation is the **carried interest**, often referred to simply as the **carry**. Carried interest enables GPs to participate in the profits of the fund, and historically it has provided the largest portion of GP compensation. The basic idea is simple: if the investors commit \$100 million to the fund, and total exit proceeds are \$200 million, then the total profit is $\$200\text{M} - \$100\text{M} = \$100\text{M}$. If such is the case, then a GP with 20 percent carried interest would receive \$20 million of this profit. Indeed, this simple example tells a lot of what we need to know about carried interest. Nevertheless, there are many variations of this basic story, and these variations are often important and contentious points of

negotiation. Variations occur in the percentage level of the carried interest, the **carried interest basis** (= **carry basis**), the timing of the carried interest, **priority returns**, and **clawbacks**. These terms are defined in the following paragraphs.

The most important variation concerns the percentage level of carried interest. The vast majority of all VC firms receive a 20 percent carry. The Investor data indicates that 95 percent of VC funds had a 20 percent carry, and this percentage was equally high if not higher in the past.⁷ Indeed, 20 percent is the focal point for the entire private equity industry and for many other partnership structures in the investment industry. There is no consensus on the origins of 20 percent as the focal point for risk-capital profit sharing; some industry analysts point to practices in the oil and gas industry earlier in the 20th century, and others trace the roots back to Venetian merchants in the late Middle Ages.⁸ An 80–20 split even appears in the book of Genesis.⁹

Despite these historical ties, a few successful VCs have managed to buck the trend, particularly for partnerships raised during the boom period. The *Private Equity Analyst* reports that over two dozen GPs of VC funds receive carried interest of 25 or 30 percent.¹⁰ Some of these high-charging VCs will be discussed in Chapter 5, along with some of their famous investments and the astronomical returns they have earned. The remainder of the non-20 percent crowd earns a carry between 20 and 25 percent, or receives carry on a sliding scale, with 20 percent earned at first, and some higher number (typically 25%) if certain performance targets are met.

There is also variation in the carried interest basis, which is the threshold that must be exceeded before the GPs can claim a profit. The majority of firms compute profits as the difference between exit proceeds and committed capital. Committed capital is used as the basis by 94 percent of VC funds (and 83% of the buyout funds) in the Investor data, and this has become more of an industry standard over time. The other 6 percent of funds have the more GP-friendly basis of investment capital, which enables profits to be defined without consideration for fees. For a profitable fund with 20 percent carried interest, \$100M in committed capital, \$20M in lifetime fees, and \$80 million in investment capital, the \$20M basis difference between committed and investment capital would yield a difference in $\$20M * 0.20 = \$4M$ in carried interest over the life of the fund.

⁷See Metrick and Yasuda (2010) and Gompers and Lerner (1999). Most commentators believe that the percentage will be heading up again as terms become more LP friendly in the postboom period.

⁸See Metrick and Yasuda (2010) and also Kaplan (1999).

⁹Gen. 47:23-24: “Joseph said to the people, ‘Now that I have bought you and your land today for Pharaoh, here is seed for you so you can plant the ground. But when the crop comes in, give a fifth of it to Pharaoh. The other four-fifths you may keep as seed for the fields and as food for yourselves and your households and your children.’” If you read the rest of this Genesis chapter, you will see that Joseph was acting more as a distress investor than as a VC.

¹⁰*Private Equity Analyst*, September 1999.

EXAMPLE 2.2

A VC firm is considering two different structures for its new \$100 M fund. Both structures would have management fees of 2.5 percent per year (on committed capital) for all 10 years. Under Structure I, the fund would receive a 25 percent carry with a basis of all committed capital. Under Structure II, the fund would receive a 20 percent carry with a basis of all investment capital.

Problems

- (a) Suppose that total exit proceeds from all investments are \$150M over the entire life of the fund. How much carried interest would be earned under each of these two structures?
 (b) For what amount of exit proceeds would these two structures yield the same amount of carried interest?

Solutions

(a) Under Structure I, the GPs would receive 25 percent of the profits, where profits are defined as the proceeds above committed capital. Therefore, the carried interest under Structure I would be $0.25 * (150 - 100) = \$12.5 \text{ M}$. Under Structure II, the GPs would receive 20 percent of the profits, where profits are defined as the proceeds above investment capital. Given a 2.5 percent management fee for all 10 years, the lifetime fees are $2.5\% * 100 \text{ M} * 10 \text{ years} = \25 M , so investment capital is $\$100 \text{ M} - \$25 \text{ M} = \$75 \text{ M}$. Therefore, the carried interest under Structure II would be $0.20 * (150 - 75) = \$15 \text{ M}$.

(b) Let Z be defined as the total proceeds from all investments. Then, using the solution to part (a), we can see that the formulas for carried interest under Structures I and II are

$$\text{Total carried interest under Structure I} = 0.25 * (Z - 100) \quad (2.3)$$

and

$$\text{Total carried interest under Structure II} = 0.20 * (Z - 75) \quad (2.4)$$

We next solve for the Z that equates the carried interest under both structures:

$$0.25 * (Z - 100) = 0.20 * (Z - 75) \rightarrow 0.05 * Z = 10 \rightarrow Z = 200 \quad (2.5)$$

When total exit proceeds = $Z = 200$, then both structures would provide $0.25 * (200 - 100) = 0.20 * (200 - 75) = \25 M in carried interest. ■

The level and basis of carried interest are the main determinants for the total dollar amount of GP carried interest. These terms determine how the “pie” of proceeds is split between the GPs and the LPs. In addition, there are also several possible methods for the *timing* of carried interest. Although these methods do not usually affect the share of the total pie earned by the GP, they do affect how quickly that pie can be eaten. Because a basic tenet of finance is that money now is worth more than money later, GPs prefer methods that enable them to receive their carried interest portion as soon as possible.

The most LP-friendly method is to require that the whole basis be returned to LPs before any carried interest is paid. This method is used by about 25 percent of the funds in the Investor data. To see how timing matters, imagine that this method was in place for Example 2.2. In that example, we considered two possible structures for carried interest: Structure I with 25 percent carry and a basis of committed capital, and Structure II with 20 percent carry and a basis of investment capital. In part (b) of that example, we found that total exit proceeds of \$200M would lead to \$25M of carried interest under both of the proposed structures, with the remaining \$175M going to LPs. Although the \$200M pie is shared the same in both cases, the timing is not. Under structure I, the LPs receive their whole basis of \$100M before all proceeds above \$100M are split 75/25. Under structure II, the LPs also receive their whole basis (only \$75M in this case) before all proceeds above \$75M are split 80/20. Thus, GPs get their first dollar more quickly under structure II, and at any time in the distribution of \$200M of total proceeds, structure II will always have paid at least as much carried interest as structure I.

To understand the alternative methods of carry timing, we make use of the definition of invested capital (introduced in Section 2.3.1) and the related concept of **contributed capital**, with the latter being defined as the portion of committed capital that has already been transferred from the LPs to the GPs. Thus, contributed capital is equal to invested capital plus any management fees paid to date. Analogous to net invested capital, **net contributed capital** is equal to contributed capital minus the cost basis of any realized and written-off investments. According to the Investor data, another 75 percent of VC funds allow some form of early carry distribution. One such method only requires the return of either invested capital or contributed capital before any carried interest can be earned. Clearly, this timing method is more GP-friendly than requiring the return of the whole basis. Another method, which lies somewhere between the “return the whole basis” and “return only the invested/contributed capital” methods, requires the return of invested or contributed capital plus priority returns. This is fairly common and is found in about 45 percent of VC funds in the Investor data.

Priority returns—also called **preferred returns** or **hurdle returns**—are another factor affecting the timing of carried interest. With a priority return, the GP promises some preset rate of return to the LPs before the GPs can collect any carry. The Investor data indicates that 45 percent of VCs promise some kind of priority return. Among these funds, 8 percent (per year) return is the most common, with 71 percent of all funds with priority returns choosing 8 percent; others range from 5 percent to 10 percent. Priority returns are relatively rare in funds that focus on early-stage investing, and relatively common in funds that focus on late-stage investing. It is important to note, however, that the priority return usually affects the timing and not the total amount of carried interest. Most priority returns also have a **catch-up provision**, which provides the GPs with a greater share of the profits once the priority return has been paid. With a catch-up, the GP receives this greater share until the preset carry percentage has been reached.

As an illustration of priority returns with a catch-up, consider a \$100M fund with a carry percentage of 20 percent, a carry basis of all committed capital, a priority return of 8 percent, and a 100 percent catch-up. We'll keep things simple and imagine that all committed capital is drawn down on the first day of the fund, and that there are total exit proceeds of \$120M, with \$108M of these proceeds coming exactly one year after the first investment, \$2M coming one year later, and \$10M coming the year after that. Under these rules, all \$108M of the original proceeds would go to the LPs. This distribution satisfies the 8 percent hurdle rate requirement for the \$100M in committed capital. One year later, the catch-up provision implies that the whole \$2M would go to the GPs; after that distribution they would have received 20 percent (\$2M) out of the total \$10M in profits. For the final distribution, the \$10M would be split \$8M for the LPs and \$2M for the GPs.

Beyond this simple example, the calculations quickly become unwieldy to handle without a spreadsheet. The key takeaway is that even with a priority return, the GPs still receive the same fraction of the profits as long as the fund is sufficiently profitable. In this example, the fund made \$20M of profits (\$120M of proceeds on \$100M of committed capital), and the GPs received 20 percent (\$4M) of these profits. If, however, the fund had only earned \$8M or less of profits over this time period, then all these profits would have gone to the LPs.

In all but two of all funds with a priority return, there is some catch-up provision for the GPs. In the two exceptions, there is no catch-up, and thus the GP only earns carried interest on the portion of profits *above* the priority return. The absence of a catch-up affects the share of the pie for the GP, not just the timing of that share. In the preceding example, having no catch-up would have meant that the GP would have received only $0.20 * (\$120M - \$108M) = \$2.4M$ of total carried interest.

Finally, some funds require the return of only a portion of contributed (or invested) capital. For example, one common method is to require the return of the cost basis of all realized investments, plus all management fees to date and any **write downs** (partial losses) known to exist among the unrealized investments. In most cases, this method is combined with a so-called fair-value test. This test requires that the estimated values of remaining portfolio investments exceed a preset percent (e.g., 120%) of the cost basis of these investments. The fair-value test is found in 14 percent of the Investor data.

The early payment of carried interest can cause complications if the fund starts off strong but weakens later in life. For example, suppose that a \$100M fund has a 20 percent carried interest with a basis of all committed capital, but allows carried interest to be paid as long as contributed capital has been returned. Then, consider what happens if the fund is three years into its life, contributed capital is \$50M, and it receives \$60M as the proceeds from its first exit. Given the carried interest rules, the fund would return the first \$50M to its LPs, and the remaining \$10M would be split as \$8M for the LPs and \$2M for the GPs. Now, fast forward ahead to the end of the fund seven years later, and assume that there were no more exits. Contributed capital is now the full \$100M of committed capital, but the LPs have only received back the \$58M from the first and only exit. According to the rules of carried interest basis,

the LPs are entitled to all the exit proceeds up to \$100M. This means they need some way to get the carried interest back from the GPs.

This refund of carried interest is accomplished with a contractual provision evocatively known as a clawback. There are a variety of ways that clawbacks can be designed. In practice, however, this implementation can be complicated by many factors—for example, what if the GPs do not have the money when it comes time to pay?—so LPs often insist (and receive) contractual guarantees to be paid back from the individual GPs. The contract also needs to specify whether the clawback will be net or gross of taxes that the GPs have already paid. Clawbacks become even more of an issue when there is a priority return—it is easy to imagine how the priority return might be exceeded in early years but missed in later years. The details here are too messy for a simple numerical example, so we will use a spreadsheet example to demonstrate. This exercise also allows us to see how management fees and carried interest are computed in a more realistic setup.

EXAMPLE 2.3

Owl Ventures has raised their \$500M fund, Owl Ventures III, with terms as given in Appendix C of this chapter. The terms for carried interest and for the general partner clawback are

Distributions Distributions in respect of any partnership investment will be made in the following order of priority:

- (i) 100% to the limited partners until they have received an amount equal to their contributed capital:
- (ii) 75% to the limited partners and 25% to the general partners.

General Partner Clawback Obligation Upon the liquidation of the fund, the general partner will be required to restore funds to the partnership to the extent that it has received cumulative distributions in excess of amounts otherwise distributable pursuant to the distribution formula set forth above, applied on an aggregate basis covering all partnership investments, but in no event more than the cumulative distributions received by the general partner solely in respect of its carried interest.

Problem Construct an example of fund performance where the clawback provision would be triggered. In this example, compute the carried interest paid in each year and show the total amount that must be paid back by the GPs on the liquidation of the firm.

Solution Cutting through the legal language, these terms mean that Owl is getting 25 percent carried interest, the carry basis is committed capital, the timing method uses contributed capital, and there is a clawback at the end of the fund if too much carry has been paid. Exhibit 2-5 shows the spreadsheet output for an example with the clawback provision triggered. ■

In this example, we assume that the investment capital is distributed evenly in each of the first five years. The returns in year 1 are fantastic, with investments tripling in value and exited at the end of year 2. These realizations can be seen in the

EXHIBIT 2-5*HYPOTHETICAL CLAWBACK EXAMPLE FOR OWL VENTURES*

Year	1	2	3	4	5	6	7	8	9	10	close
Investments	83.3	83.3	83.3	83.3	83.3	0.0	0.0	0.0	0.0	0.0	0.0
Estimated portfolio value	83.3	333.3	124.9	139.4	146.0	43.8	13.1	3.9	1.2	0.4	0.1
Distributions	0.0	250.0	12.5	13.9	58.4	17.5	5.3	1.6	0.5	0.1	0.1
Cumulative distributions	0.0	250.0	262.5	276.4	334.8	352.4	357.6	359.2	359.7	359.8	359.9
Distributions to GPs	0.0	15.9	0.0	0.0	0.0	0.0	0.0	0.0	0.0	0.0	0.0
Cumulative distributions to GPs	0.0	15.9	15.9	15.9	15.9	15.9	15.9	15.9	15.9	15.9	15.9
Distributions to LPs	0.0	234.1	12.5	13.9	58.4	17.5	5.3	1.6	0.5	0.1	0.1
Cumulative distributions to LPs	0.0	234.1	246.6	260.6	319	336.5	341.7	343.3	343.8	343.9	344
Port value after capital returned	83.3	83.3	112.4	125.5	87.6	26.3	7.9	2.4	0.7	0.2	0.0
Management fee	10.0	10.0	11.3	11.3	10.0	8.8	7.5	6.3	5.0	3.8	0.0
Contributed capital	93.3	186.5	281.0	375.5	468.8	477.5	485.0	491.3	496.3	500.0	500.0
Invested capital	83.3	166.5	249.8	333.0	416.3	416.3	416.3	416.3	416.3	416.3	416.3
Clawback											15.9

row labeled “distributions” in Exhibit 2-5 and are equal to \$250M in year 2. Because only \$186.5M has been contributed by this time (see the “contributed capital” row for year 2), the GPs are entitled to 25 percent carried interest on the “profits” of \$250M less \$186.5M. This carried interest, shown in the “distributions to GPs” row, is equal to \$15.9M.

Following this great year, the investments perform terribly. The spreadsheet assumes that all investments lose half their value each year, and later distributions are low to reflect this poor performance. The formula in the spreadsheet has 10 percent of portfolio value being distributed in years 3 and 4, with 40 percent (of whatever remains in each year) being distributed in the remaining years. There are no further distributions to GPs during the remaining life of the fund.

Upon liquidation of the fund after year 10, we see that contributed capital has reached the committed capital level of \$500M, but that the cumulative distribution to the LPs is only \$344.0M. The clawback provision is thus triggered, and the GPs are obligated to return all \$20.9M of carried interest. In practice, it probably would have been clear much earlier to all parties that the clawback would be necessary—and to

EXHIBIT 2-6**RESTRICTIVE COVENANTS FOR VC FUNDS**

Description	% of Contracts
<i>Covenants relating to the management of the fund:</i>	
Restrictions on size of investment in any one firm	77.8
Restrictions on use of debt by partnership	95.6
Restrictions on coinvestment by organization's earlier or later funds	62.2
Restrictions on reinvestment of partnership's capital gains	35.6
<i>Covenants relating to the activities of the general partners:</i>	
Restrictions on coinvestment by general partners	77.8
Restrictions on sale of partnership interests by general partners	51.1
Restrictions on fund-raising by general partners	84.4
Restrictions on other actions by general partners	13.3
Restrictions on addition of general partners	26.7
<i>Covenants relating to the types of investment:</i>	
Restrictions on investments in other venture funds	62.2
Restrictions on investment in public securities	66.7
Restrictions on investments in leveraged buyouts	60.0
Restrictions on investments in foreign securities	44.4
Restrictions on investments in other asset classes	31.1
<i>Total number of partnership agreements in sample</i>	45
<i>Average number of covenant classes</i>	7.9
<i>Average number of covenant classes (weighted by fund size)</i>	8.4

SOURCE: Gompers and Lerner (1996).

solve this problem, the GPs could give the money back earlier or just reduce the management fees to zero for the last few years.

2.3.3 Restrictive Covenants

A VC fund is a long-term commitment. LPs tie up capital with no promise of a return and little control over the investment activities of the GP. Although the compensation of the GPs does go some distance toward aligning the incentives of all parties, several potential problems still exist. Over time, LPs have used a variety of **restrictive covenants** in an attempt to mitigate these problems.

Gompers and Lerner (1996) wrote the only academic study of restrictive covenants. Exhibit 2-6 reproduces part of a table from their analysis. They divide covenants into three broad categories: (1) restrictions on management of the fund, (2) restrictions on the activities of the GP, and (3) restrictions on the types of investment.

Examples from the first broad category can be seen in each of the sample agreements in the appendices to this chapter. For example, EBV and Talltree both have

restrictions for the maximum percentage of the fund to be invested in any one company. Exhibit 2-6 shows that similar restrictions were in place in 78 percent of all sample funds. Why would LPs insist on this restriction? An obvious answer to this question is “to put a limit on risk”, but this answer is unsatisfying. The typical investor in VC funds is a large institutional investor who is allocating only a small portfolio fraction to any particular VC fund; the difference between 25 percent or 50 percent of that allocation going to one specific company would barely affect the risk exposure for their broad portfolio. Instead, the main justification for investment limits is related to the incentives of the GPs, specifically the incentives induced by carried interest.

To illustrate the incentive problem, consider the fictitious case of Derby Ventures. The GP of Derby Ventures makes “investments” by placing bets on horses at a racetrack. This GP has an excellent track record from past bets, and his LPs expect him to make dozens of small bets so that the law of large numbers allows his superior skill to show through. The LPs expect this behavior, but it is not written into the partnership agreement. Now assume that besides being very knowledgeable about horses, this GP is also a savvy gambler. He realizes that his superior knowledge would probably be able to produce 20 percent returns on capital over the next year, giving him a few percentage points in carried interest, but perhaps not enough to make it worth his while to quit his regular job as a professor. Alternatively, he can put all his money on one horse, perhaps a ten-to-one “long shot”. If the horse wins, then the carried interest earned in one day would be enormous. If the horse loses—well, he can just go back to teaching his classes.

This example captures the main incentive problem for carried interest: it provides an upside to the GP without the corresponding downside. In option-pricing language, the GPs effectively hold a **call option** on the fund portfolio. Readers familiar with options will know that call options are more valuable when the underlying security has higher volatility. Thus GPs, as holder of the carried interest “call option”, have an incentive to increase volatility by betting a lot on one horse, or investing a lot in one company. (For readers unfamiliar with options, fear not: we will beat that horse to death starting in Chapter 13.)

The same insight can help us understand the common restriction against funds taking on debt (96 percent of sample funds). By taking on debt, a fund can amplify the returns on its portfolio, an amplification that increases risk and, correspondingly, increases the value of the carried-interest call option. LPs can rein in these adverse incentives through the use of covenants, but a formal restriction is not always necessary. An alternative approach is to rely on the GPs’ unwillingness to risk their “reputational capital”. For GPs with a long history and lucrative future—as we assume exists for Owl Ventures, now on their ninth fund—it may no longer be necessary to formally restrict their risk-taking behavior. If Derby Ventures fails, its GP can just go back to teaching. If Owl Ventures fails, then a valuable franchise has been lost.

With 62 percent of sample funds, restrictions on coinvestment with earlier or later funds by the same partnership are also common. LPs may decide to restrict such coinvestment to avoid one fund propping up the performance of another. This can be

of particular concern around the time that a GP is fundraising for a new fund. For example, suppose that EBV is trying to raise EBV III, and it is three years into its investment period on Fund II and seven years into the life of Fund I. Now, when it goes on the fund-raising trail, potential LPs will scrutinize the performance of Fund I, but not expect much of the still young Fund II. If Fund II can help Fund I by giving some new money to an otherwise failing company, then the interim returns of Fund I would be helped, at the expense of Fund II's investors.

Our second category of covenants is one that involves restrictions on the activities of the GP. In general, the covenants in this class are designed to ensure that the GP's attention stays focused on the whole portfolio of fund investments. For example, restrictions on coinvestment by general partners (78 percent of sample funds) might seem to be counterproductive—shouldn't LPs be happy to see GPs with their own money at stake? The problem here is that GPs may focus excessively on the few investments with a personal stake while ignoring the other investments. In this case, the GPs may use the fund simply as an opportunity to cherry-pick a few great investments for themselves. One way to restrict this practice is for LPs to insist that any personal investments by GPs be proportional across all fund investments.

Another way to keep the GPs' attention is to restrict them from raising another fund before they have invested the present one (84 percent of sample funds). This is of particular concern for debut funds like EBV, where the GPs may want to make a quick return to the market to raise larger funds and achieve critical mass for the management fee.

The third category of covenants includes restrictions designed to keep GPs focused on the type of investing that they have been hired to do. LPs do not like to see a GP who was hired to be a VC suddenly turn into an investor in LBOs, public equities, distressed debt, or other VC funds. This motivation to switch focus can be surprisingly strong during times of market upheaval. For example, venture performance was poor and LBOs were hot in the mid-1980s. Many VCs wanted to try their hand at this new activity, but the skill set was quite different, and anecdotal evidence suggests that VCs' performance in LBOs was terrible. A similar motivation occurred in the postboom period. As with the other categories of covenants, a strong reputation and franchise value can reduce the need for formal covenants. However, here even some of the most famous names in private equity can be tempted to lose their focus, as was seen many times during the boom and postboom periods.

SUMMARY

The VC fund, organized as a limited partnership, is the main vehicle for VC investing. The general partner (GP) of a VC fund is a VC firm, and the limited partners (LPs) are usually institutional investors, with pension funds supplying just under half of the total committed capital in the industry. In the postboom period, there were about 900 active VC firms and 1,800 active VC funds.

GPs are compensated with management fees and carried interest. Management fees are usually about 2.0 percent per year, calculated on the basis of committed capital. Carried interest—the profit participation—is most commonly set at 20 percent of all fund profits. This compensation structure is designed to help align the incentives of GPs and LPs. To get a better alignment of incentives, LPs often restrict GP behavior with covenants written into the partnership agreement.

KEY TERMS

VC firm	Raised, closed	Contributed capital, net
General partner (GP)	Vintage year	contributed capital
VC fund	Fund-of-funds (FOF)	Priority returns
Limited partner (LP)	Management fees	= Preferred returns
Capital call	<i>Lifetime fees</i>	= Hurdle returns
= Drawdown	<i>Investment capital</i>	Realized returns, unrealized
= Takedown	Invested capital, net	returns
Committed capital	invested capital	Catch-up provision
Investment period	Carried interest	Clawback
= Commitment period	= Carry	Restrictive covenants
Follow-on investments	Carried interest basis	Call option
Early-stage fund, late-stage	= Carry basis	
fund, multistage fund		

REFERENCES

- Gompers, Paul A. and Joshua Lerner, 1996, “The Use of Covenants: An Empirical Analysis of Venture Partnership Agreements”, *Journal of Law and Economics* 39(2), 463–498.
- Gompers, Paul A. and Joshua Lerner, 1999, “An analysis of compensation in the U.S. venture capital partnership”, *Journal of Financial Economics* 51, 3–44.
- Kaplan, Steven N., 1999, “Accel VII”, Unpublished case study, available online at <http://gsbwww.uchicago.edu/fac/steven.kaplan/teaching/accel7.pdf>.
- Lerner, Joshua, Antoinette Schoar, and Wan Wong, 2007, “Smart Institutions, Foolish Choices? The Limited Partner Performance Puzzle”, *Journal of Finance* 62(2), 731–764.
- Metrick, Andrew and Ayako Yasuda, 2010, “The Economics of Private Equity Funds”, *Review of Financial Studies* 23, 2303–2341.
- Venture Economics, *National Venture Capital Association Yearbook*, various years.

EXERCISES

2.1 Suppose that a \$200M VC fund has a management fee of 2.5 percent per year for the first five years, with a reduction of 0.25 percent (25 basis points) in each year thereafter. All fees are paid on committed capital, and the fund has a 10-year life. What are the lifetime fees and investment capital for this fund?

2.2 (This is a little bit tricky.) Suppose that a \$1B VC fund has fees of 2.0 percent per year in all years, with these fees paid on committed capital in the first five years and on *net invested* capital for years 6 through 10. You can assume the fund is fully invested by the beginning of year 6, then realizes 20 percent of its investment capital in each of the following five years. What are the lifetime fees and investment capital for this fund? (Make assumptions for any information that you think is still missing from the problem.)

2.3 A VC firm is considering two different structures for its new \$250M fund. Both structures would have management fees of 2 percent per year (on committed capital) for all 10 years. Under Structure I, the fund would receive an X percent carry with a basis of all committed capital. Under Structure II, the fund would receive a Y percent carry with a basis of all investment capital. For a given amount of (total) exit proceeds = \$Z, solve for the amount of carried interest under both structures.

2.4 Talltree Ventures has raised their \$250M fund, Talltree Ventures IV, with terms as given in Appendix 2.B of this chapter. Construct an example of fund performance where the clawback provision would be triggered. In this example, compute the carried interest paid in each year, and show the total amount that must be paid back by the GPs upon the liquidation of the fund.

APPENDICES: KEY TERMS AND CONDITIONS FOR THREE VC FUNDS

These appendices give excerpts from the private placement memoranda for three (fictional) VC funds: EarlyBird Ventures I (EBV I) [Appendix 2.A], Talltree Ventures IV [Appendix 2.B], and Owl Ventures IX [Appendix 2.C]. We will refer to these appendices throughout the book. All these excerpts are derived from a more complete memorandum given in Kaplan (1999).

Appendix 2.A: EarlyBird Ventures I

Fund Size \$100 million

Term Following the tenth anniversary of the initial closing, the term of the partnership will expire on December 31st unless extended for up to two consecutive one-year periods at the discretion of the general partner. This is to permit orderly dissolution, and no management fees will be charged during any such extension.

Commitment Period Following the fifth anniversary of the initial closing, all partners will be released from any further obligation with respect to their unfunded commitments on December 31st, except to the extent necessary to cover expenses and obligations of the partnership (including management fees) in an aggregate amount not to exceed unfunded commitments.

Management Fees The annual contributions will equal 2 percent of committed capital for the first 10 years of the fund. These contributions will be paid quarterly.

Distributions Distributions in respect of any partnership investment will be made in the following order of priority:

- (i) 100 percent to the limited partners until they have received an amount equal to their contributed capital.
- (ii) 80 percent to the limited partners and 20 percent to the general partners.

Diversification and Investment Limits The Fund may not invest more than 25 percent of aggregate commitments in any single portfolio company.

Appendix 2.B: Talltree Ventures IV

Fund Size \$250 million

Term Following the tenth anniversary of the initial closing, the term of the partnership will expire on December 31st, unless it is extended for up to two consecutive one-year periods at the discretion of the general partner. This is to permit orderly dissolution, and no management fees will be charged during any such extension.

Commitment Period Following the fifth anniversary of the initial closing, all partners will be released from any further obligation with respect to their unfunded commitments on December 31st except to the extent necessary to cover expenses and obligations of the partnership (including management fees) in an aggregate amount not to exceed unfunded commitments.

Management Fees The annual contributions will equal 2 percent of committed capital for the first 10 years of the fund. These contributions will be paid quarterly.

Distributions Distributions in respect of any partnership investment will be made in the following order of priority:

- (i) 100 percent to the limited partners until they have received an amount equal to their contributed capital, plus a priority return equal to 8 percent (compounded annually).
- (ii) 100 percent to the general partner until the general partner has received catch-up distributions equal to 20 percent of the sum of such distributions and the preference distributions in part (i).
- (iii) 80 percent to the limited partners and 20 percent to the general partner.

General Partner Clawback Obligation Upon liquidation of the fund, the general partner will be required to restore funds to the partnership to the extent that it has received cumulative distributions in excess of amounts otherwise distributable

pursuant to the distribution formula set forth above, applied on an aggregate basis covering all partnership investments, but in no event more than the cumulative distributions received by the general partner solely in respect of its carried interest.

Diversification and Investment Limits The fund may not invest more than 20 percent of aggregate commitments in any single portfolio company.

Appendix 2.C: Owl Ventures IX

Fund Size \$500 million

Term Following the 10th anniversary of the initial closing, the term of the partnership will expire on December 31st unless extended for up to two consecutive one-year periods at the discretion of the general partner. This is to permit orderly dissolution, and no management fees will be charged during any such extension.

Commitment Period Following the fifth anniversary of the initial closing, all partners will be released from any further obligation with respect to their unfunded commitments on December 31st except to the extent necessary to cover expenses and obligations of the partnership (including management fees) in an aggregate amount not to exceed unfunded commitments.

Management Fees All management fees are computed based on committed capital. These fees are 2 percent in years 1 and 2, 2.25 percent in years 3 and 4, 2 percent in year 5, 1.75 percent in year 6, 1.50 percent in year 7, 1.25 percent in year 8, 1 percent in year 9, and 0.75 percent in year 10. These fees will be paid quarterly, with equal installments within each year.

Distributions Distributions in respect of any partnership investment will be made in the following order of priority:

- (i) 100 percent to the limited partners until they have received an amount equal to their contributed capital.
- (ii) 75 percent to the limited partners and 25 percent to the general partners.

General Partner Clawback Obligation Upon the liquidation of the fund, the general partner will be required to restore funds to the partnership to the extent that it has received cumulative distributions in excess of amounts otherwise distributable pursuant to the distribution formula set forth above, applied on an aggregate basis covering all partnership investments, but in no event more than the cumulative distributions received by the general partner solely in respect of its carried interest.

VC RETURNS

VCS SPEND their time very differently from mutual-fund managers, but ultimately both groups are measured by their investment returns. If you open the business section of the newspaper, you can readily see information about mutual-fund returns, but one must search hard to find any information about VC returns. Even when such returns are revealed, they are often reported in ways that are not comparable to standard benchmarks.

In this chapter, we learn how VC returns are measured and take our first glimpse into the returns data. In Section 3.1, we analyze two main sources of industry level returns and compare these returns with public market benchmarks. In Section 3.2, we show how to compute returns at the fund level and discuss several new sources of fund level data.

3.1 INDUSTRY RETURNS

In this section, we analyze the returns for the entire VC industry. We begin with some definitions.

3.1.1 Definitions

A **periodic return** is defined as

$$\text{Periodic return} = R_t = (P_t + D_t)/P_{t-1} - 1 \quad (3.1)$$

where R_t is the return for period t , P_t is the value (price) of the portfolio at the end of period t , D_t is the dividends (distributions) earned by the portfolio during period t , and P_{t-1} is the value (price) of the portfolio at the end of period $t - 1$. The time period t can be any length, and the return would correspondingly be a “monthly return”, “quarterly return”, “annual return”, or likewise. For multi-period returns, we multiply the periodic returns to arrive at the **compound return**:

$$\text{Compound return} = (1 + R_1) * (1 + R_2) * \dots * (1 + R_N) - 1 \quad (3.2)$$

Because we will often be interested in returns at the annual time horizon, we can translate T years of multi-period returns into **annualized returns** as follows:

$$\text{Annualized return} = (1 + \text{compound return})^{(1/T)} - 1 \quad (3.3)$$

For managed portfolios, returns can be expressed either as **gross returns** (before subtracting fees and carried interest) or as **net returns** (after subtracting fees and carried interest).

EXAMPLE 3.1

The Largeco pension plan has invested in dozens of VC funds. The director of the pension plan is preparing his annual report to the Largeco board of directors. Summary information for Largeco's VC portfolio is given in Exhibit 3-1:

EXHIBIT 3-1

LARGEKO PENSION PLAN, VC PORTFOLIO

Year	2004	2005	2006	2007	2008
Beginning Value	4,000	5,950	7,090	9,267	3,884
New Investments	2,000	1,000	1,000	1,000	1,000
Ending Value (before distributions)	7,200	8,340	10,517	5,134	7,814
Distributions to LPs	1,000	1,000	1,000	1,000	1,000
Distributions to GPs	250	250	250	250	250
Management Fees	100	100	100	100	100

Problem The board has asked for a five-year report of net returns and gross returns by year, plus the compound returns and annualized returns for all five years. You can assume that all new investments and management fees are paid at the beginning of the year, and all distributions were paid at the end of the year.

Solution The gross returns are calculated by comparing the value at the beginning of each year with the value at the end of each year. (Note that the beginning value in year t is equal to the ending value in year $t - 1$ minus distributions to LPs and GPs. The management fee is paid separately by the LPs.) Thus, gross returns are $7,200/(4,000 + 2,000) - 1 = 20$ percent for 2004, $8,340/(5,950 + 1,000) - 1 = 20$ percent for 2005, and so on. For net returns, we must subtract the distributions to GPs (carried interest) from the numerator and add the management fees to the denominator: $(7,200 - 250)/(4,000 + 2,000 + 100) - 1 = 13.9$ percent for 2004, $(8,340 - 250)/(5,950 + 1,000 + 100) - 1 = 14.8$ percent for 2005, and so on. The answers for all years are given in Exhibit 3-2.

EXHIBIT 3-2*LARGE CO PENSION PLAN, VC PORTFOLIO*

Year	2004	2005	2006	2007	2008
Net Return	13.9%	14.8%	25.4%	-52.9%	51.8%
Gross Return	20.0%	20.0%	30.0%	-50.0%	60.0%

The compound returns are as follows:

$$\text{Gross compound return} = 1.20 * 1.20 * 1.30 * 0.50 * 1.60 - 1 = 49.8\% \quad (3.4)$$

and

$$\text{Net compound return} = 1.139 * 1.148 * 1.254 * 0.471 * 1.518 - 1 = 17.2\% \quad (3.5)$$

The gross annualized return is $1.498^{(1/5)} - 1 = 8.4$ percent, and the net annualized return is $1.172^{(1/5)} - 1 = 3.2$ percent. ■

It will prove useful to give one final set of return definitions. Returns that have been earned in the past are known as **realized returns** or **historical returns**. Returns that are forecast for the future are known as **expected returns**. We could use the modifier of “realized” or “expected” in front of any of the other return definitions in this chapter. In a well-behaved universe, we would find that average realized returns would be equal to expected returns for all assets. Our universe is not so well behaved, which is why so many advertisements tell us that “past performance is no guarantee of future returns”.

3.1.2 A Gross-Return Index

Given current data limitations, a gross-return index is best created from the bottom up. To construct a bottom-up index, we build a database of all VC investments, do our best to update the values of these investments over time (including distributions), and then track the value of the whole set of investments, thus creating a rolling portfolio for the whole VC industry. This is a herculean task, but luckily all the work has already been done by Susan Woodward and her company, Sand Hill Econometrics (SHE).¹

SHE began by combining the databases of the two main industry trackers, VentureSource (a division of Dow Jones) and Venture Economics (a division of Thomson Financial). From here, SHE added information from other industry

¹Construction of the Sand Hill Index is described in Hall and Woodward (2003).

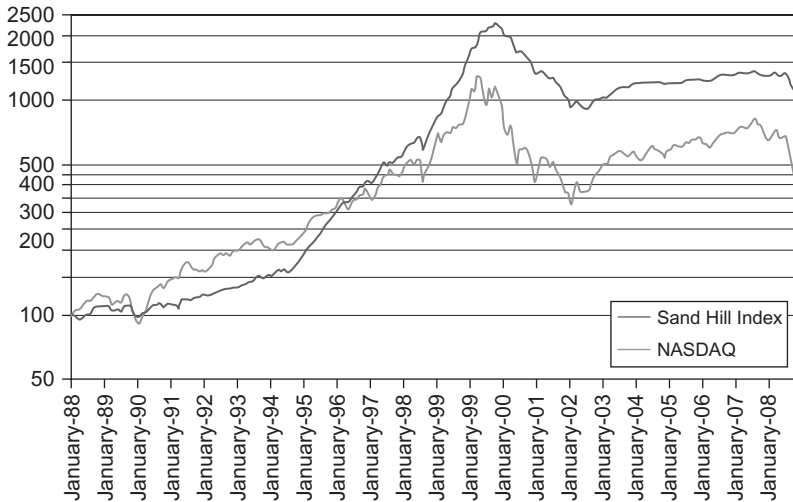
EXHIBIT 3-3**SAND HILL INDEX[®] VERSUS NASDAQ**

NOTE: The two indices are both normalized to be 100 in December 1988. The normalized indices are presented in log scale.

SOURCES: Sand Hill Econometrics (SHE), the Center for Research in Security Prices (CRSP).

sources, from its own base of consulting clients (LPs in VC funds), and from exhaustive searching of Web resources. The final database includes over 17,000 companies and more than 60,000 financing rounds. It also allows for monthly updating. The resulting Sand Hill Index[®] is plotted in Exhibit 3-3, using the available sample period through December 2008.² For comparison, we have also plotted an index for the NASDAQ stock market. The two indices are both normalized to be 100 in December 1988, the month the Sand Hill Econometrics Venture Index started. The normalized indices are presented in log scale.

Since the inception of the SHE index, the index reached a peak of 2,302 in August 2000, fell to a postboom low of 915 in February 2003, and recovered to 1,364 by October 2007. Meanwhile, the NASDAQ index peaked at its all-time high at 1,306 in February 2000, fell to a postboom low of 328 in September 2002, and reached its post-bubble high at 827 in October 2007. Since October 2007, the SHE index slid, largely in tandem with the NASDAQ, amid the financial crisis that

²Sand Hill Econometrics discontinued the index in December 2008 after it reached a licensing agreement with Dow Jones. A new index called the DowJones Index of Venture Capital (comprising VentureSource and Sand Hill Econometrics' proprietary data) will be launched in 2010.

unfolded in 2008. In December 2008 (the last month the index was calculated), it stood at 1,110, while the NASDAQ was at 456. The annualized return over the 20-year life of the index is 12.8 percent. In comparison, the NASDAQ index—a value-weighted index of all NASDAQ stocks, including dividends—had the annualized return over the same 20-year time period of 7.9 percent. Although the Sand Hill Index[®] is more than double the NASDAQ index by the end of the sample period, the former only passes the latter in June 1996, close to the beginning of the boom period.

3.1.3 A Net-Return Index

The Sand Hill Index[®] is built from a database of portfolio companies. An alternative approach is to build a database of funds and combine the returns of these funds to form an overall industry index. This has been attempted by several groups, the most comprehensive of which is the Cambridge Associates U.S. Venture Capital Index[®], which includes more than 75 percent of the dollars raised by VC funds since 1981.³ Cambridge Associates (CA), an investment consultant to endowments, foundations, and wealthy families, serves as a **gatekeeper** for potential LPs. It essentially acts as a paid service that puts CA between the LP and GP for both the initiation and management of the partnership relationship. This function gives CA access to information, which it has astutely chosen to aggregate and analyze.

To construct its index, CA starts with the quarterly reports that GPs provide to LPs. These reports give “current” valuations for the unrealized portfolio companies and also summarize the cash flows in and out of the fund.⁴ CA then aggregates the total value (realized and unrealized) from each fund in each quarter. By combining these totals across quarters, it is able to compute an aggregate return and build an index. Note that CA is using cash flows to LPs as the basic unit. Because these cash flows include management fees (as negative cash flows) and carried interest (as a reduction of the positive cash flows from realized investments), the CA index is based on net returns and, in principle, should be lower than the corresponding gross return index constructed by SHE.

The quarterly CA index is available from the first quarter of 1981 through the last quarter of 2008. To facilitate comparisons with the Sand Hill Index[®], we set the CA index value to 100 for the fourth quarter of 1988. Exhibit 3-4 plots the CA Index versus the NASDAQ index (also normalized to be 100 in the fourth quarter of 1988) in log scale.

³The Cambridge Associates data can be freely downloaded from <https://www.cambridgeassociates.com/pdf/Venture%20Capital%20Index.pdf>.

⁴We put “current” between quotes because the valuations are often quite old. In Chapter 4, we discuss this valuation practice and its implications for performance measurement and for the estimation of the cost of venture capital.

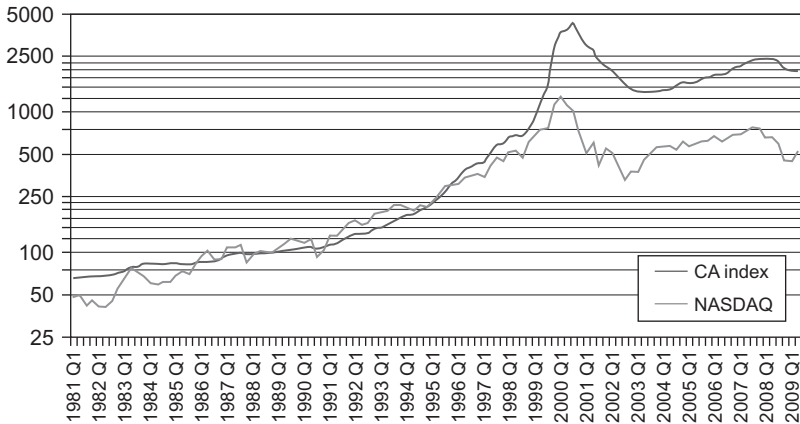
EXHIBIT 3-4**CA INDEX[®] VERSUS NASDAQ**

NOTE: The two indices are both normalized to be 100 in the fourth quarter of 1988, to make it comparable to the Sand Hill Econometrics Venture Index, which started in December 1988. The normalized indices are presented in log scale.

SOURCES: Cambridge Associates (CA), the Center for Research in Security Prices (CRSP).

The exhibit demonstrates that the CA index has the highest amplitude of all three series, reaching a maximum of 4,300 in the third quarter of 2000, a postboom low of 1,386 in the first quarter of 2003, and recovering to its postbubble high of 2,412 in the fourth quarter of 2007. Since then it went down, as expected, and stood at 2,022 in the fourth quarter of 2008. For the complete, nearly 28-year sample period of 1981 to 2008, the CA index earned an annualized return of 13.0 percent versus a 9.0 percent return for the NASDAQ. During the 20-year subperiod from 1988 to 2008—when we also have data for the Sand Hill Index[®]—the CA index earned annualized returns of 16.2 percent versus 12.8 percent for the Sand Hill Index[®] and 7.9 percent for the NASDAQ.

The relationship between the Sand Hill Index[®] and the CA Index seems backward: the net-return index (CA)—which is computed after fees and carried interest are subtracted out—should be lower than the gross-return index (SHE). However, here the opposite is true, with the CA index exceeding the Sand Hill Index[®] by 3.4 percentage points over the common subperiod.

Clearly, something is wrong with at least one of these indices. In fact, both indices have some weaknesses; but when taken together, they can provide us with upper and lower bounds for VC performance. First, consider the CA index. CA adds to its database in several ways. One way is by tracking funds for which a CA client is a current LP. This form of adding data does not induce any bias. However, CA does not have clients in every first-time fund. Suppose that ABC Fund I does not include any

CA clients as LPs. If ABC Fund I performs poorly, it is unlikely there will ever be an ABC Fund II, and CA will never get to see the returns from Fund I. On the other hand, if Fund I is successful, then it is more likely that ABC will be able to raise Fund II. If ABC solicits a CA client for Fund II, then CA will request information on the performance of Fund I, and then add it to its database. This method of data collection induces a **survivor bias**—“survivors” have a better chance of showing up in the data, and this bias causes an overestimate of industry returns. Thus, we think of the CA index as representing an *upper bound on the net returns to VC*.

Next, consider the Sand Hill Index[®]. In principle, this index could also suffer from survivor bias, because we might think that SHE is more likely to learn of the existence of companies only if they have been successful. Furthermore, additional biases are possible because valuation information might be missing for nonrandom reasons (e.g., if the portfolio companies performed poorly). In practice, SHE has been able to significantly limit these biases through the combination of several databases and the use of sophisticated statistical techniques designed to handle missing data. It also has made arduous efforts to track down the exit status of companies which existing databases list as “private” long after they were first funded, thus tackling the “zombie company” problem. It is, however, likely that this index is a bit conservative (bias would be too strong a word here) in the way it computes VC returns. To understand how conservatism could occur, we must go a little deeper into the SHE methodology.

Each month, SHE takes a snapshot of all portfolio companies for all VCs. As discussed earlier, there are several challenges in estimating the value of nontraded companies, and SHE handles these problems with several careful methods. Because VCs do not own 100 percent of these companies, the next step is to estimate the value of the VCs’ portion of each company. This is tricky—indeed, the calculations to do this estimation will take up the six chapters of Part III in this book—and the task is made more difficult because SHE does not have access to the details of each transaction. Thus, it is necessary to make an assumption about the form of VC ownership, and SHE assumes that VCs have proportional (common-stock) ownership of these firms. This assumption is conservative, because virtually all VCs own some form of preferred stock, which has valuation advantages over common stock. A discussion of these advantages will be introduced in Chapter 9 and extensively analyzed in Part III. For now, it will suffice to say that if SHE were to have assumed some form of preferred stock, then the returns on the Sand Hill Index[®] would have been a little bit higher. Thus, the Sand Hill Index[®] provides us with a *lower bound on the gross returns to VC*.

Taken together, the returns data gives us an upper bound for net returns (the CA index), and a lower bound for gross returns (the Sand Hill Index[®]). How far apart are these bounds? The CA Index had an annualized return of 16.2 percent from the end of 1988 to the end of 2008; the Sand Hill Index[®] had a return of 12.8 percent over the same time period. If we make a back-of-the-envelope estimate of management fees costs of about 2 percent and carried-interest costs of about 2 percent, then we get a total of 4 percent for fees and carry, yielding an estimated

net return of $12.8 - 4.0 = 8.8$ percent for the Sand Hill Index[®]. This means that the difference between the upper and lower bounds for VC net returns from 1989 to 2008 is $16.2 - 8.8 = 7.4$ percent.

At first glance, these returns demonstrate some advantage for VC over the most comparable index. Of course, this is not the end of the story, because we have not said anything about the relative *risk* of VC versus the NASDAQ; but at this point, a detailed discussion of risk would take us too far off topic. In Chapter 4, we analyze the risk of VC in the context of estimating the cost of capital for VC investments. With that background, we will then be able to analyze the risk-adjusted performance of VC based on the CA and SHE indices. For now, it will suffice to say that this analysis finds that both the net risk-adjusted return (upper bound, from CA) and gross risk-adjusted return (lower bound, from SHE) are very close to zero.

3.2 FUND RETURNS

In Chapter 4, we will show that the upper bound is zero for the net risk-adjusted returns to the VC industry. If this is true, then investment in VC only makes sense if one can identify managers that consistently outperform the rest of the industry. Luckily for LPs, there is some evidence that such consistent outperformance does exist. To understand the sources of such performance, we must first learn how fund level returns are measured.

3.2.1 Definitions

The industry returns calculated in Section 3.1 started with periodic returns for each month (Sand Hill) or quarter (CA), and then multiplied these returns to arrive at a compound return for the whole time period. This is a standard procedure for computing asset returns. It is used for stocks, bonds, and bank deposits, as well as for the return measurements of mutual funds, hedge funds, and other portfolio managers. Although this calculation is reasonable for the whole VC industry, it does not seem reasonable when applied to a single VC fund. The main problem is that VC funds may have vastly different amounts of capital invested in different years of the fund, and it can be misleading to treat all these years equally when computing returns.

To illustrate this problem, imagine that you are an LP in the ABC fund. Suppose that you have committed \$11M to the fund. For simplicity, assume fees and carry are both zero (so gross returns are equal to net returns). On January 1, 2007, ABC calls \$1M of your investment. On December 31, 2007, it exits this investment and returns \$2M to you. On January 1, 2008, it calls the remaining \$10M for another investment. On December 31, 2008, it exits this second investment for \$6M. Given these facts, what is your annualized return from investing in ABC?

If we follow the same steps as in Section 3.1, then we would calculate the return for 2007 as $(2/1) - 1 = 100$ percent, and for 2008 as $(6/10) - 1 = -40$ percent. The compound returns would then be $(1 + 1) * (1 - 0.4) - 1 = 20$ percent,

and the annualized returns would be $(1.2)^{(1/2)} - 1 = 9.5$ percent. Although this is mathematically correct, it is economically misleading. After all, if we ignore the timing of these cash flows, we can see that you gave ABC a total of \$11M when it really only returned $\$2M + \$6M = \$8M$ to you. It just does not seem right to credit them with a positive return of 9.5 percent.

The problem is that annualized returns weigh each year equally in the calculation. To get an answer consistent with our intuition, we need to compute an **internal rate of return (IRR)**, which effectively weighs each *dollar* equally. To compute the IRR, we start with the whole stream of cash flows. In this case, we have a negative cash flow of \$1M on January 1, 2007 (the original investment); a positive cash flow of \$2M on December 31, 2007; a negative cash flow of \$10M on January 1, 2008; and then a positive cash flow of \$6M on December 31, 2008 (the final value of the portfolio). To simplify our calculations, we combine the cash flows on December 31, 2007 and January 1, 2008 to obtain a single negative cash flow of \$8M for the end of 2007.

We are now ready to move on and answer the following question. Suppose that the negative cash flows were the deposits in a bank, and the positive cash flow was the final bank balance. If such is the case, then what interest rate must this bank be paying on deposits?

Under this logic, a bank paying an interest rate equal to the IRR would give us $1M * (1 + IRR)^2$ for a two-year deposit of \$1M, and $8M * (1 + IRR)$ for a one-year deposit of \$8M. If we have \$6M total from these deposits, then the IRR is the solution to

$$6M = 1M * (1 + IRR)^2 + 8M * (1 + IRR) \quad (3.6)$$

We can solve this quadratic equation to obtain a feasible annual $IRR = -31$ percent. This negative return seems more consistent with the idea that ABC lost money overall than the answer given by our previous procedure.

For cash flow streams more complex than this example, we would use a computer to calculate the IRR. The IRR plays an important role in VC performance reporting, but it is not a panacea—and careful observers must be aware of several weaknesses in the IRR measure. First, one should never forget that the IRR cannot be directly compared to periodic returns. In the example we just solved, the annualized returns were about 9.5 percent, whereas the IRR was negative 31 percent. Although not all differences will be this extreme, such differences are not uncommon. Because most of the investment world speaks in terms of annualized returns, it is tempting to compare these returns to IRRs. This temptation should be avoided.

Second, some standard practices of IRR calculation can lead to confusion. Typically, VC funds will compute a monthly or quarterly IRR from all its cash flows, and then annualize this periodic IRR using Equation (3.3). However, in times of high returns, an annualized version of a monthly or quarterly IRR will be misleading, because this exercise implicitly assumes reinvestment even when such reinvestment has explicitly *not* occurred. For example, consider a \$1M investment that returns \$80,000 every month for one year and then returns \$1M at the end of the year. This cash flow stream has a monthly IRR of 8 percent. So far, so good—the investment has

clearly returned 8 percent in every month. However, if we annualize this IRR to $(1.08)^{12} - 1$, we get an annualized IRR of 151 percent, which is similar to assuming that all the distributions were reinvested (none were!) and also earned 8 percent per month. A true “annual IRR” of 151 percent should be leaving the investor with $\$1M * (1 + 1.51) = \$2.51M$ at the end of the year, but the investment strategy followed here would not do that without some extra help from excellent outside investments.

A third weakness of standard IRR reporting is that it does not usually make a distinction between realized and unrealized investments. For VC funds that still have unrealized investments, the IRR takes the value of these unrealized investments and treats them as a positive cash flow in the final period. If a significant component of the portfolio is unrealized, then the IRR calculation will essentially just reflect the subjective valuation of these unrealized investments. In general, the IRR becomes more informative as the fund realizes more investments.

For this last reason, the IRR is particularly misleading in the first few years of a fund. Remember that management fees are usually based on committed capital; so LPs of a \$100M fund with 2 percent annual fees would be paying out \$2M in fees each year and would have \$80M left for investment capital. Suppose the fund invests \$20M of this investment capital in the first year. Because one year is rarely long enough to have any exits, it is possible that all this investment capital would still be kept on the books at cost. The fund would then appear to have earned no gross returns while still collecting \$2M in fees. An IRR calculation from these cash flows is going to give a negative return. If these investments turn out well in the long run, then the fund will look fine by the time of these exits. In the early years, however, it will appear to charge very high fees compared to invested capital (\$2M on \$20M of investments = 10 percent in this case) and with little appreciation of the assets. Even for funds that eventually have high IRRs, a plot of the fund IRR over time will be negative for the first few years, and then increase rapidly in the later years. The shape of this plot, shown in Exhibit 3-5, is called a **J-curve** or a **hockey stick**.

The IRR is an answer to the question, “How well did you do with my money while you had it?” Many investors would like to get the answer to a different question, which asks, “Overall, how much money did you make for me?” The IRR’s inability to answer this second question is a final weakness. For example, consider the following two funds. Fund ABC takes a \$1M investment at the beginning of year 1 and then returns \$2M at the end of year 1. Fund XYZ takes a \$1M investment at the beginning of year 1 and then returns \$32M at the end of year 5. Both funds have an (annual) IRR of 100 percent. Clearly, however, assuming a normal investment and inflation environment, fund XYZ will be preferred by all investors. It would be nice to have a measure of this superior performance. The VC industry indeed has such a measure, which goes by many names—**value multiple**, **investment multiple**, **realization ratio**, **absolute return**, **multiple of money**, **times money**. They all mean the same thing: “For every dollar I gave you, how much did I get back?” Each of these expressions can be divided into realized and unrealized investments. For instance, a value multiple is the sum of the **realized value multiple** and **unrealized value multiple**.

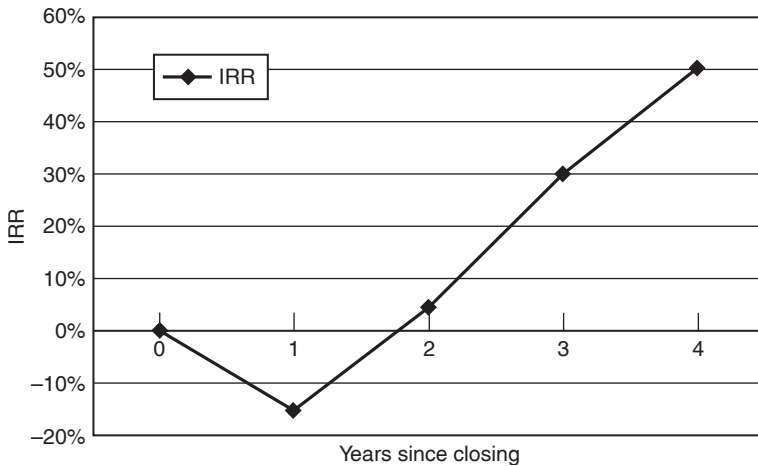
EXHIBIT 3-5*THE J-CURVE/HOCKEY STICK PATTERN OF RETURNS***EXAMPLE 3.2**

The \$200M ABC Fund is seven years into its 10-year life. Its annual investments, fees, distributions, and portfolio value are given in Exhibit 3-6.

EXHIBIT 3-6*CASH FLOWS FOR THE ABC FUND*

	Year 1	Year 2	Year 3	Year 4	Year 5	Year 6	Year 7
Investments	20.0	30.0	40.0	40.0	30.0	0.0	0.0
Portfolio value	20.0	56.0	112.8	186.6	188.1	195.7	203.5
Total distributions	0.0	0.0	0.0	65.0	37.6	39.1	40.7
Carried interest	0.0	0.0	0.0	0.0	0.0	0.0	0.0
Distributions to LPs	0.0	0.0	0.0	65.0	37.6	39.1	40.7
Cumulative distributions to LPs	0.0	0.0	0.0	65.0	102.6	141.8	182.5
Port value after capital returned	20.0	56.0	112.8	121.6	150.5	156.5	162.8
Management fee	4.0	4.0	4.0	4.0	4.0	4.0	4.0

NOTE: All entries are in \$millions.

Problem Compute the IRR, value multiple, realized value multiple, and unrealized value multiple for ABC at the end of year 7.

Solution To compute the IRR, we first need to aggregate the investments, fees, and distributions into a single cash flow to LPs as

$$\begin{aligned} \text{Cash Flow to LPs} &= \text{Distributions to LPs} - \text{new investments} \\ &\quad - \text{management fees} \end{aligned} \quad (3.7)$$

These cash flows are $-\$24\text{M}$ for year 1, $-\$34\text{M}$ for year 2, $-\$44\text{M}$ for year 3, $\$21\text{M}$ for year 4, $\$3.6\text{M}$ for year 5, $\$35.1\text{M}$ for year 6, and $\$36.7\text{M}$ for year 7. The portfolio value at the end of year 7 is $\$162.8\text{M}$. This value is counted as a positive cash flow for the IRR calculation. We can use a spreadsheet or calculator to compute the IRR of this cash flow stream as 23.8 percent.

The value multiple is as follows:

$$\begin{aligned} \text{Value Multiple} &= (\text{Total Distributions to LPs [all years]} \\ &\quad + \text{value of unrealized investments}) / (\text{Invested Capital} \\ &\quad + \text{Management Fees}) \end{aligned} \quad (3.8)$$

Total distributions to LPs through year 7 are $\$182.5\text{M}$. The value of unrealized investments = the portfolio value after year 7 = $\$162.8\text{M}$. Invested capital is the sum of new investments over all years = $\$160\text{M}$. The total management fees through year 7 = $\$28\text{M}$. Thus, the value multiple = $(\$182.5\text{M} + \$162.8\text{M}) / (\$160\text{M} + \$28\text{M}) = 1.84$.

The realized value multiple is as follows:

$$\begin{aligned} \text{Realized Value Multiple} &= (\text{Total Distributions to LPs [all years]} \\ &\quad / (\text{Invested Capital} + \text{Management Fees}) \\ &= \$182.5\text{M} / (\$160\text{M} + \$28\text{M}) = 0.97 \end{aligned} \quad (3.9)$$

The unrealized value multiple is as follows:

$$\begin{aligned} \text{Unrealized Value Multiple} &= (\text{Value of unrealized investments}) \\ &\quad / (\text{Invested Capital} + \text{Management Fees}) \\ &= \$162.8\text{M} / (\$160\text{M} + \$28\text{M}) = 0.87 \end{aligned} \quad (3.10)$$

Most LPs compute value multiples on a net basis, with fees and carry already subtracted; if you read “value multiple” in this book or in the trade press, you can assume that it refers to a net value multiple. In some cases, firms may report value multiples on a gross basis, perhaps because the GP team wants to discuss a performance record for a time period when they were not explicitly charging fees or carry. This can occur when the GPs’ prior investing experience took place outside the standard partnership structure. For many GP teams raising their first fund, such experience may represent the only evidence of their past performance. This **gross value multiple (GVM)** is computed as follows:

$$\begin{aligned} \text{GVM} &= (\text{Total distributions to LPs [all years]} \\ &\quad + \text{value of unrealized investments} \\ &\quad + \text{carried interest}) / \text{invested capital} \end{aligned} \quad (3.11)$$

Gross value multiples are also helpful for quickly communicating the raw investment performance of a GP and for calculating shortcut estimates for carried interest. Also, we can go back and forth between GVMs and value multiples by making a few extra calculations. For example, consider a fully invested fund at the end of its life, so investment capital = invested capital, and all investments have been realized. Then, we can rewrite Equation (3.11) as follows:

$$\text{GVM} = \text{total distributions}/\text{investment capital} \quad (3.12)$$

where total distributions include both carried interest plus all LP distributions. We can then compute its carried interest as

$$\begin{aligned} \text{Carried interest} &= \text{carry}\% * (\text{total distributions} - \text{carry basis}) \\ &= \text{carry}\% * (\text{GVM} * \text{investment capital} - \text{carry basis}) \end{aligned} \quad (3.13)$$

where *carry%* represents the percentage level of carried interest and the carry basis is either committed capital or investment capital as specified by the fund partnership agreement. We can now express the (net) value multiple of a completed fund by rewriting Equation 3.(3.8) in terms of the GVM and other inputs as follows:

$$\begin{aligned} \text{Value multiple} &= (\text{total distributions to LPs})/(\text{investment capital} \\ &\quad + \text{management fees}) \\ &= (\text{total distributions} - \text{carried interest})/\text{committed capital} \quad (3.14) \\ &= [\text{GVM} * \text{investment capital} - \text{carry}\% * (\text{GVM} \\ &\quad * \text{investment capital} - \text{carry basis})]/\text{committed capital}. \end{aligned}$$

Finally, there is one more definition that will be useful in later chapters. For many of our valuation analyses, we will need to estimate the fraction of the investment that we expect to be paid to the GP as carried interest. For a completed fund, we define this *GP%* as

$$\begin{aligned} \text{GP}\% &= \text{carried interest}/\text{total distributions} = \text{carry}\% * \\ &\quad (\text{GVM} * \text{investment capital} - \text{carry basis})/ \\ &\quad (\text{GVM} * \text{investment capital}). \end{aligned} \quad (3.15)$$

Note that *GP%* will never be higher than *carry%*, because *carry%* is paid on all profits, whereas *GP%* is a percentage of total distributions. Since profits will always be lower than total distributions, *GP%* will always be lower than *carry%*. Also, remember that *carry%* is a contractual number in the partnership agreement, whereas *GP%* is an estimated percentage that depends on the eventual GVM of the fund.

The following example allows us to practice with these definitions.

EXAMPLE 3.3

XYZ Partners is raising their first fund, XYZ Partners Fund I, with \$100M in committed capital, annual management fees of 2 percent, carried interest of 20 percent, and a carried interest basis of committed capital. The four individuals on the XYZ team have previously managed the captive VC portfolio for the Goldenbucks family. During the 10 years of managing the Goldenbucks' VC portfolio, the partners did not charge management fees or carried interest, and they achieved a GVM of 2.5.

Problem

- (a) Suppose that XYZ Fund I earns the same GVM as the partners earned for Goldenbucks. What would be the value multiple for the fund?
 (b) What would be the GP% of the fund?

Solution

(a) To see how this formula would translate into XYZ Fund I, we must make adjustments for management fees and carried interest. For a \$100M fund with 2 percent annual fees, lifetime fees would be \$20M, and investment capital would be \$80M. Then, we can substitute these quantities and $GVM = 2.5$ into Equation (3.14) to obtain the following:

$$\begin{aligned} \text{Value multiple} &= (2.5 * \$80M) - 0.20 * ((2.5 * \$80M) - \$100M) / \$100M \\ &= [\$200M - 0.20 * (\$100M)] / \$100M = 1.8. \end{aligned} \quad (3.16)$$

(b) From Equation (3.15), we can compute the GP% as

$$\begin{aligned} \text{GP\%} &= 0.20 * (2.5 * \$80M - \$100M) / (2.5 * \$80M) \\ &= \$20M / \$200M = 0.10. \end{aligned} \quad (3.17)$$

**3.2.2 Evidence**

LPs get access to fund level return data through their own databases or through gatekeepers. Well-known gatekeepers include Cambridge Associates (who release the aggregate VC index discussed in Section 3.2), Hamilton Lane Advisors, State Street (who launched its own venture capital and related private equity indices in 2007), and Pacific Corporate Group. For those of us outside the LP community, data is harder to find.

The longest-standing source of fund level return data is Venture Economics (VE). Both GPs and LPs report returns to VE under a strict rule of secrecy, in which VE promises not to disclose any identifying information about specific funds. Although VE does not provide information about specific funds, its summary data has been an industry standard since the 1980s. The publicly available source for this data is its annual publication, *Investment Benchmarks Report (IBR)*. In each year of the *IBR*, VE gives summary statistics for the vintage year. VE claims to have data on 25 percent of all funds, and overrepresentation of the largest funds allows this 25 percent to cover over 50 percent of all industry dollars.

EXHIBIT 3-7

VE MEDIANS AND TOP-QUARTILE BY VINTAGE YEAR

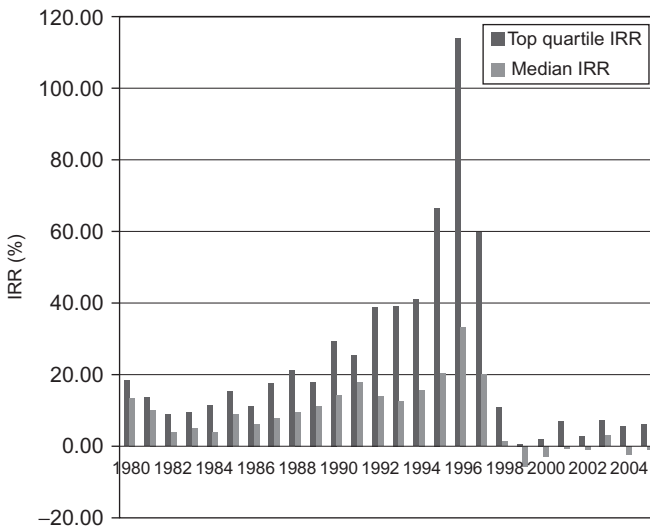

SOURCE: Thomson VentureXpert.

Each annual *IBR* dedicates several pages to each vintage year, with summary information about IRRs and value multiples during the complete evolution of that vintage year. Perhaps its most closely watched statistics are the cutoffs for the median and **top-quartile fund** for each vintage year. Because VE is the only public provider of this information, these cutoffs have become the de facto benchmarks. Because it is very difficult to measure risk for individual funds, the dominant performance measures in the industry are these vintage year comparisons. Exhibit 3-7 displays the median IRR and top-quartile IRRs for all vintages since 1980.

The *IBR* data shows that median performance peaked for vintage year 1996, and that the mid-1990s were extremely fortunate years to be raising VC funds. The median IRRs of funds raised in 2004 and 2005 are still negative—that is expected and consistent with the J-curve—whereas the poor median performance of 1999 and 2000 funds after a decade cannot be attributed to the J-curve and seems likely to be with us for good.

Although the detailed VE data is not available to the public, subsets of the data have been released to academic researchers. These subsets are cleansed of identifying information, but do include codes that allow researchers to link funds from the same GP without actually knowing who that GP is. Kaplan and Schoar (2005) use this data to answer the crucial question posed at the beginning of this section, which asks, “Is GP performance persistent across funds?” Using several measures of performance, the authors find that the answer is a clear “yes”. For example, let N = the sequence

number for funds of a specific GP. Kaplan and Schoar found that the IRR of Fund N is a significant predictor for the IRR of Fund $N + 1$ and for the IRR of Fund $N + 2$, and the authors also demonstrate that their results are robust to using other measures of fund performance and to several differences in fund style.

In recent years, some new data sources on fund level returns have appeared. This appearance was driven mostly by media requests to public LPs under the Freedom of Information Act (FOIA). Public LPs, such as public-pension funds and the endowments of public universities, fought hard to avoid disclosing the returns on their private equity portfolios, but ultimately some disclosure was required. FOIA requests uncovered the returns of several large and experienced LPs, including the University of California, California Public Employee Retirement System (CALPERS), the University of Michigan, and the University of Texas. These disclosures gave the public its first look at the performance of some of the most famous names in VC.

These FOIA disclosures inspired a new entrant into the VC performance market. Private Equity International (PEI) began by gathering all the information from FOIA requests and then combining this information with proprietary data from LPs and GPs. They now offer several products to the general public, including an annual publication, *The Private Equity Performance Monitor (PEPM)*. This publication gives performance data for hundreds of funds; we will discuss this evidence extensively in our listing of the “best VC funds” in Chapter 5.

To give you just a flavor of the data, Exhibit 3-8 shows the returns and multiples of Kleiner, Perkins, Caufield, & Byers (KPCB), taken from the disclosures of the University of California and included in the 2005 PEPM.

Exhibit 3-8 shows why KPCB is so famous. By comparing these results to the benchmarks in Exhibit 3-7, we can see that every fund from 1980 through 1996 was above the median IRR. Truly spectacular results were obtained by KPCB VII (1994 vintage) and KPCB VIII (1996 vintage), which achieved value multiples of 32.0 and 17.0, respectively. Furthermore, the 1999 vintage KPCB IX fund, which had a net IRR of -23.3 percent as of March 2004 and thus looked like the firm’s first “loser”, turned out to be the very best of hundreds of funds raised that year. Why? Because KPCB IX had about 20M shares of Google, which went public on August 19, 2004, and regulatory filings show that these shares were distributed at about \$200 per share. Assuming that about 14M of these shares went to LPs (KPCB has a 30 percent carried interest), that would mean about \$2.8 billion was distributed to LPs. Thus, even if KPCB gets no other realizations from the entire fund, they would still give their investors a value multiple of at least 5 ($<2800/500$) from fund IX.⁵

⁵While we cannot officially verify our assertion that KPCB IX was a homerun fund, we take comfort from the disclosure that another famous fund that invested in Google, Sequoia Capital III, has a value multiple of 14.84 and a net IRR of 106% as of September 2007 (2008 Private Equity Performance Monitor). This \$250M fund reported a value multiple of 0.44 as of March 2004, prior to the Google IPO; thus an increase of 14.4X (14.84-0.4) in the value multiple was likely due to the Google exit. The back-of-the-envelope calculation using 30% carry and 20M shares distributed at \$200 per share yields 11.2X (2800/250) incremental contribution of Sequoia’s Google investment to its fund performance. The numbers (14.4 and 11.2) roughly match, and if anything tells us that our assumptions *understate* the true exit value of the Google investment for its VC backers.

EXHIBIT 3-8*KLEINER PERKINS CAUFIELD & BYERS FUNDS*

Fund	Vintage Year	Committed Capital (\$M)	Net IRR	Value Multiple	Date Reported
II	1980	65	50.6%	4.3	Mar-04
III	1982	150	10.2%	1.7	Dec-04
IV	1986	150	11.0%	1.8	Dec-04
V	1989	150	35.7%	4.0	Dec-04
VI	1992	173	39.2%	3.3	Mar-04
VII	1994	225 ¹	121.7%	32.0	Mar-04
VIII	1996	299	286.6%	17.0	Mar-04
IX	1999	550	-23.3%	See text	Mar-04
X	2000	625	-17.5%	0.6	Mar-04
XI	2004	400	NA	NA	NA
XII	2006	600	NA	NA	NA
XIII	2008	700	NA	NA	NA

¹Only \$170M of Fund VII was drawn down.

NOTE: There have been no publicly available updates of KPCB funds since December 2004.

SOURCE: Dow Jones LP Galante, 2005 Private Equity Performance Monitor.

SUMMARY

VC is a form of private equity, and for many years the returns to VC funds have indeed been very private. In recent years, however, several new data sources have been made available so that it is now possible to do some analysis of industry level and fund level returns. In this chapter, we analyzed two sources of industry level returns: the Cambridge Associates VC Index[®] (providing an upper bound for the net returns to the industry) and the Sand Hill Index[®] (providing a lower bound for the gross returns to the industry). Although both of these indices have superior performance to the NASDAQ, the risk-adjusted returns (to be studied in detail in Chapter 4) are close to zero. Although the industry as a whole does not offer superior risk-adjusted performance, the evidence on fund level returns suggests that top firms can consistently outperform their peers. To analyze fund level performance, it is necessary to use different measures of returns from the methods used at the industry level. The two main measures of fund level returns are the IRR and the value multiple, the latter also known by many other names. Fund level data is available in summary form from Venture Economics and in detailed form from Private Equity Intelligence.

KEY TERMS

Periodic return	Internal rate of return (IRR)	Realized value multiple,
Compound return	J-curve	unrealized value multiple
Annualized return	= hockey stick	Gross value multiple
Gross return	Value multiple	= gross investment
Net return	= investment multiple	multiple, etc.
Realized return	= realization ratio	Carry%
= historical return	= absolute return	GP%
Expected return	= multiple of money	Top-quartile fund
Gatekeeper	= times money	
Survivor bias		

REFERENCES

- Hall, Robert E., and Susan Woodward, 2003, "Benchmarking the Returns to Venture", National Bureau of Economic Research working paper #10202.
- Kaplan, Steven N., and Antoinette Schoar, 2005, "Private Equity Performance: Returns, Persistence, and Capital Flows", *Journal of Finance* 60(4), 1791–1824.
- Private Equity Intelligence, *The 2005 Private Equity Performance Monitor*.
- Private Equity Intelligence, *The 2008 Private Equity Performance Monitor*.

EXERCISES

3.1 The Bigco pension plan has invested in dozens of VC funds. The director of the pension plan is preparing his annual report to the Bigco board of directors. Summary information for Bigco's VC portfolio is given in Exhibit 3-9.

The board has asked for a five-year report of net returns and gross returns by year, plus the compound returns and annualized returns for all five years. You can assume that all new investments and management fees were paid for at the beginning of the year, and all distributions were paid at the end of the year.

3.2 Consider the case of XYZ Partners from Example 3.3. Now, instead of using a GVM of 2.5 (as in the example), assume that this GVM is unknown and equal to K .

- For any given K , solve for the carried interest, value multiple, and GP%.
- How large must K be for the value multiple to be greater than 3?
- How would your answer to parts (a) and (b) change if the carry basis were equal to investment capital? (In the original example, the carry basis is equal to committed capital.)

3.3 True, False, or Uncertain: If both EBV and Owl have the same GVM, then the value multiple of Owl will be lower than the value multiple of EBV. (See Appendices 2.A and 2.C for more information on EBV and Owl.)

EXHIBIT 3-9*BIGCO PENSION PLAN, VC PORTFOLIO*

Year	2010	2011	2012	2013	2014
Beginning value	10,000	10,300	13,105	5,563	6,332
New investments	2,000	2,000	2,000	2,000	2,000
Ending value (before distributions)	13,800	16,605	9,063	9,832	12,498
Distributions to LPs	3,000	3,000	3,000	3,000	3,000
Distributions to GPs	500	500	500	500	500
Management fees	200	200	200	200	200

3.4 The \$600M XYZ Fund has completed its 10-year life. Its annual investments, fees, distributions, and portfolio value are given in Exhibit 3-10.

EXHIBIT 3-10*CASH FLOWS FOR THE XYZ FUND*

	Year 1	Year 2	Year 3	Year 4	Year 5	Year 6	Year 7	Year 8	Year 9	Year 10
Investments	50.0	100.0	100.0	150.0	100.0	0.0	0.0	0.0	0.0	0.0
Portfolio value	50.0	167.5	326.1	387.8	353.5	381.8	412.3	445.3	480.9	519.4
Carried interest	0.0	0.0	0.0	0.0	0.0	0.0	15.9	17.8	19.2	103.9
Distributions to LPs	0.0	0.0	150.0	200.0	70.7	76.4	66.6	71.2	76.9	415.5
Cumulative distributions to LPs	0.0	0.0	150.0	350.0	420.7	497.1	563.6	634.9	711.8	1127.3
Port value after capital returned	50.0	167.5	176.1	187.8	282.8	305.4	329.8	356.2	384.7	0.0
Management fee	10.0	10.0	10.0	10.0	10.0	10.0	10.0	10.0	10.0	10.0

- (a) Compute the value multiple, realized value multiple, unrealized value multiple, and IRR for XYZ after *every year* of its life.
- (b) Are these returns an example of the J-curve, or are they an exception?

THE COST OF CAPITAL FOR VC

VCS SHOULD make an investment if the expected return on the investment is higher than the cost of capital. We dedicated part of Chapter 3 to an empirical analysis of the returns to VC investment. In this chapter, we empirically analyze the other side of this equation: the cost of capital. The main driver of the cost of capital is the trade-off between risk and return. This analysis of the risk-return trade-off is probably the biggest research topic in financial economics. This chapter provides an introduction to this important topic, with a focus on the implications for the cost of *venture* capital.

In Section 4.1 we introduce the **capital asset pricing model (CAPM)**. More than 40 years after its first development, the CAPM remains a workhorse model for computing the cost of capital. Although the CAPM is widely used, it remains poorly understood by many practitioners. Indeed, the ideas behind the model are often counterintuitive, and many people just apply the formulas without knowing why. In Section 4.2 we tell an economic fairy tale to discuss the CAPM intuition without all the mathematical details. This same intuition can be applied to more complicated **multifactor models** of the cost of capital. In Section 4.3 we introduce some multifactor models to directly estimate the cost of venture capital.

4.1 THE CAPITAL ASSET PRICING MODEL

Consider two investments: The first investment is a manufacturer of cardboard boxes (Boxco), an item always in some demand because of its use in transporting goods around the world. Although the fortunes of this company rise and fall with the economy, the peaks and valleys are not very extreme. As a first approximation, the earnings of the company are proportional to world GDP, and world GDP rarely moves by more than a few percentage points in any given year. Next, consider an investment in a drug company, currently searching for the cure to some rare disease (Drugco). The research for this disease has made some progress, but still there is only a 20 percent chance that the drug will succeed, and we won't know about this success for a few years. If it does succeed, then the company will have the exclusive

right to market the drug for about 10 years, and it would expect to plow back some of these earnings into similar R&D efforts in the future. If the drug does not succeed, then the company will go out of business and be worth nothing. Neither the success of the project nor the profits from this (or future) projects are at all related to the state of the world economy. Now, consider two related questions. First, which of these two companies is “riskier”? Second, which of these companies will have a higher cost of capital?

If we equate risk with the statistical measure of **variance**, then Drugco is riskier.¹ There is an 80 percent chance of complete failure, and even success on the first drug does not guarantee success for the future. Boxco, on the other hand, does not have a high variance. A wary reader might suspect a trick, and of course there is one. The performance of Drugco is not related to the global economy. If we split the ownership of Drugco into thousands of little pieces (shares of stock), and if we find thousands of companies similar to Drugco, then a portfolio of such investments would be well diversified and could actually have close to a zero variance. Thus, in this example, Drugco has only **idiosyncratic risk**, also called **diversifiable risk**. On the other hand, Boxco, despite having a relatively low variance, is perfectly correlated with the economy. If we break Boxco into thousands of pieces and find thousands of similar companies, we will still be left with the same variance in our portfolio.

If we accept this discussion of risk, then which of these two companies will have a higher cost of capital? The classic model used to answer this question is the **Capital Asset Pricing Model (CAPM)**:

$$r_i = R_i = R_f + \beta(R_m - R_f) \quad (4.1)$$

where r_i is the cost of capital for asset i , R_i is the expected return for asset i , R_f represents the risk-free rate for borrowing and lending, R_m is the return on the whole **market portfolio**, and β (pronounced “beta”) is the level of risk for asset i . The difference $(R_m - R_f)$ is called the **market premium**. For this model to hold, the financial market needs to be in equilibrium, so that the cost of capital for any investment is equal to the expected return on that investment. Thus, for the remainder of this discussion, we refer interchangeably to the “cost of capital” and “expected return”. Although this might be a boring world to be an investor—because all assets would trade at “fair” value—it is a very useful world if we are trying to understand the trade-off between risk and return.

In our well-behaved equilibrium world, the CAPM applies to individual companies like Drugco or Boxco, but asset i could also represent many other things. For example:

1. Specific capital projects within companies, such as a factory to manufacture boxes or drugs;

¹If you are unfamiliar with the definition of *variance*, then you are going to be very confused by this chapter. Sorry.

2. An entire industry or asset class, such as “all drug companies”, “small stocks”, or “venture capital”;
3. The portfolio of a specific investment manager, such as a mutual fund or a venture capital fund.

The key idea of the CAPM is that beta reflects the **covariance** of an asset’s returns with the returns on the overall market. The higher the beta, the higher the expected return. Beta risk is also called **market risk**, **nondiversifiable risk**, or **systematic risk**. The mathematics and intuition behind the CAPM implies that beta risk is the only kind of risk that affects the expected return of an asset. As discussed earlier for the Drugco example, risks that are uncorrelated with the market are called diversifiable risk or idiosyncratic risk, and such risks are not compensated by any extra return.

To make the CAPM operational, we need some way to estimate the variables of (4.1). For R_i , we can use the realized returns on asset i . For R_m , we can use the realized returns on a portfolio of all publicly traded stocks. For R_f , we can use the realized returns on short-term U.S. treasury bills. (Recall from Chapter 3 that realized returns are the same thing as historical returns.) Then, using these realized returns, the statistical method of **least-squares regression** can be used to estimate beta. The standard approach is to modify Equation (4.1) to

$$R_{it} - R_{ft} = \alpha + \beta(R_{mt} - R_{ft}) + e_{it} \quad (4.2)$$

where β , R_{it} , R_{mt} , and R_{ft} are defined similarly to Equation (4.1)—except that in (4.1) the return variables represented expected returns, whereas in (4.2) they represent realized returns for period t . The new elements in (4.2) are α (pronounced “alpha”), the regression constant; and e_{it} , the regression error term.²

Once we have estimated Equation (4.2), we can use the results to compute a cost of capital for asset i . The cost of capital is still given by Equation (4.1). To actually compute this cost, we can substitute the regression estimate of beta into (4.1), but we still need estimates for the risk-free rate, R_f , and for the market premium ($R_m - R_f$). For R_f , most analysts recommend using the current treasury yield for a horizon that matches the expected holding period of the investment. Thus, an investment with a five-year horizon would use the yield on the five-year treasury bond. In this chapter we use a risk-free rate of 4 percent. For ($R_m - R_f$), one possibility is to use the realized market premium over some historical period in some country or set of countries. For example, from 1926 to 2008, the average market premium in the United States was approximately 7 percent.³ Also, Welch (2000) finds that 7 percent is the average market premium forecast by a sample of 226 academic financial economists. Based on these two pieces of evidence, we will use 7 percent as our estimated premium in this book. Readers with strong views about the premium should certainly experiment with other numbers.

²An excellent introduction to regression techniques is Kennedy (2003). This book includes discussions at several levels of technical detail and succeeds admirably on every level.

³Ibbotson Associates (2009).

With these estimates for the risk-free rate and the market premium, we can compute the cost of capital as follows:

$$r_i = 0.04 + \hat{\beta} * 0.07 \quad (4.3)$$

where $\hat{\beta}$ is the regression estimate for beta. Thus, with a beta of 1, the typical stock would have an 11 percent cost of capital.

By allowing the possibility of a regression constant (alpha) in Equation (4.2), we are permitting realized returns on asset i to be higher than its cost of capital, because the cost of capital is still given by the expected return of Equation (4.1). If asset i is a managed asset such as a mutual fund or a VC fund, then alpha can be interpreted as an **abnormal return**: if alpha is positive, then the manager has earned a return higher than the cost of capital—a “positive abnormal return”; if alpha is negative, then the manager has earned a return lower than the cost of capital—a “negative abnormal return”. This interpretation of alpha as abnormal returns means that we can use the regression in Equation (4.2) to measure the investment performance of an asset class or asset manager. For this reason, Equation (4.2) is sometimes called a **performance evaluation regression**.

EXAMPLE 4.1

The Largeco pension fund aggregates its entire portfolio every month across all asset classes and computes its net returns, R_i . Exhibit 4-1 displays these monthly returns for one year, along with the market returns and the risk-free treasury bill rates for those months.

EXHIBIT 4-1

LARGECO RETURNS

Month	R_i	R_m	R_f
January	1.51%	2.24%	0.07%
February	1.34%	1.49%	0.06%
March	-0.39%	-1.16%	0.09%
April	-2.45%	-2.50%	0.08%
May	1.74%	1.35%	0.06%
June	2.33%	2.08%	0.08%
July	-3.81%	-3.87%	0.10%
August	0.32%	0.16%	0.11%
September	2.25%	1.95%	0.11%
October	2.01%	1.67%	0.11%
November	3.76%	4.68%	0.15%
December	2.43%	3.36%	0.16%

Problem Use Equations (4.1) and (4.2) to estimate the beta, alpha, and cost of capital for the Largeco portfolio. How do you evaluate its investment performance?

Solution Before estimating the regression, we subtract R_f , the risk-free rate given in the last column, from both the R_i and the R_m columns. We can then estimate Equation (4.2) using a spreadsheet or other statistical package. The estimates are beta = 0.88 and (monthly) alpha = 0.07 percent. The alpha estimate is not statistically significant, but it does indicate a positive abnormal performance of 0.07 percent per month, which we can translate into an annualized alpha of approximately 0.8 percent. To compute the cost of capital for the Largeco portfolio, we combine our estimate of beta = 0.88 with a market premium of 7 percent and risk-free rate of 4 percent:

$$r_i = 0.04 + 0.88 * 0.07 = 10.16 \text{ percent} \quad (4.4)$$

By using Equation (4.2) and allowing for the possibility of abnormal returns, we are engaging in some seemingly paradoxical mental gymnastics. Equation (4.1) requires that abnormal returns are zero *in the future*; that is, the cost of capital must be exactly equal to the expected return, because there is no alpha in Equation (4.1). However, once we estimate a nonzero alpha in Equation (4.2), we are willing to allow some abnormal returns *in the past*. Presence of a nonzero alpha or abnormal returns does not contradict Equation (4.1), however, as long as Equation (4.1) holds *on average* across all assets. Among financial economists, it is a bit of a cottage industry to devise statistical tests to measure whether Equation (4.1) does indeed hold “on average”. Overall, the CAPM held up very well in the 1970s; but anomalous evidence started to accumulate in the 1980s, and by the 1990s most researchers came to believe that the model needed some extensions. Nevertheless, all these extensions are based on the same underlying concepts. In Section 4.2, we provide some intuition for these concepts; and in Section 4.3, we develop the extended models and apply them to the estimation of the cost of venture capital.

4.2 BETA AND THE BANANA BIRDS

To gain more intuition about the CAPM, let’s lose all touch with reality and enter the fantasy world of finance professors. Imagine that our entire world is populated by 100 people, all of whom live on their own island. Travel and trade between islands is easy and free. Each island has 100 banana trees; these trees will last forever, and no other trees can ever be planted. Bananas are all that anybody consumes or ever wants to consume. On average, every year, a tree will produce 200 bananas, so that the whole world produces 200 bananas * 100 trees * 100 islands = 2M bananas per year. There is no limit on how many bananas a person can eat. Although never completely sated, each additional banana provides a little less happiness than the last one: the 100th banana of the month does not bring as much pleasure as the 99th. Bananas cannot be stored (they go brown fast, as we know), so everything produced by the trees must be eaten each year.

Of course, the world is not a total paradise—there is some risk. One risk comes from a flock of wild banana birds that settle down onto half the islands every year, and proceed to eat all the bananas on those islands (while they are still green) so that the trees on that island produce no ripe bananas for the entire year. These banana birds seem to choose their islands randomly, with each island having a 50 percent chance in each year. Thus, the overall number of ripe bananas available to all the islanders is $50\% * 2M = 1M$, with the other 1M (green) bananas consumed by the birds.

The bird risk is serious, because without any bananas for the year, the islander will be very hungry. (Being hardy folk, islanders can survive without eating for many years, but they are not happy about it.) For each individual islander, bird risk has a high variance: the expected number of bananas is 100 per tree, but this represents a 50 percent chance of getting 200 bananas per tree and a 50 percent chance of getting zero bananas per tree. How does this bird risk affect the happiness of the islanders? We assumed at the beginning of this story that the 100th banana does not provide as much happiness as the 99th banana, giving us a “banana utility” function shaped like Exhibit 4-2. An islander with a 50 percent chance at 20,000 bananas and 50 percent chance at 0 bananas would have an expected utility lying at point B, the midpoint of line AD. She would be better off if she could get to point C, which is the utility of getting 10,000 bananas for sure. All islanders feel this way, so they try to construct some diversification strategy to get there.

EXHIBIT 4-2

BANANA UTILITY WITH BIRD RISK

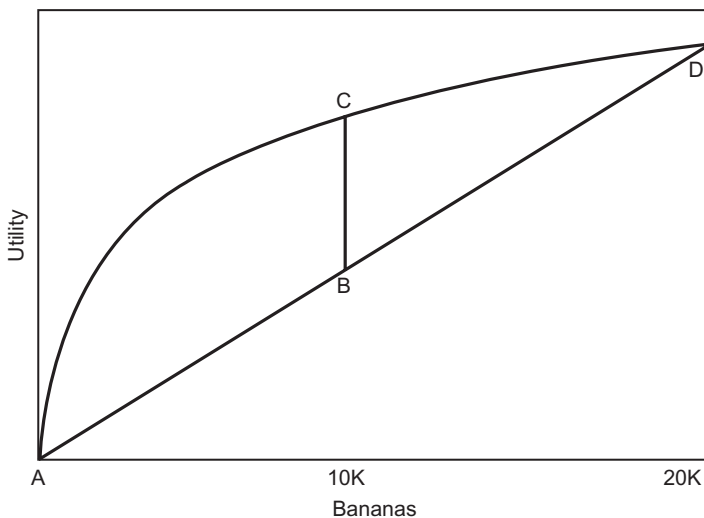

One islander hits upon a solution: she takes all her trees and forms a company and then sells shares in her company to all the other islanders. Each tree on her island has an expected production of 100 ripe bananas, so the total expected production of her island company is $100 * 100 = 10,000$ bananas. She divides up 100 shares in her company (1 percent of her company = one tree for each share), keeps one share for herself, and offers the other 99 shares to the other islanders. She sets the price of a share to be one tree; that is, any other islander can buy 1 percent of her Banana Company by giving up the future rights to one tree from his own island.

How does this deal look for the other islanders? First, *note that the expected return of the deal is zero*; each islander expects to get back exactly what she puts in. By investing one tree from her own island (expected production = 100 ripe bananas), each islander receives in return 1 percent (= one tree) of another island (expected production = 100 ripe bananas). Second, note that the deal will be useful diversification for the buyer: before the deal, she had a 50 percent chance of getting 20,000 bananas for the year, but also a 50 percent chance of losing everything to the birds and getting zero. After the deal, the buyer has reduced the chance of getting zero, with an offsetting reduction in the chance of getting 20,000. A graphical illustration of this change is shown in Exhibit 4-3. The diversification effectively moves the extreme outcomes toward the center (from points A and D toward points A' and D'). The new expected utility lies at B', the midpoint of A'D'. Because B' is higher than B, the buyer has succeeded in increasing her expected utility.

EXHIBIT 4-3

BANANA UTILITY AFTER DIVERSIFICATION

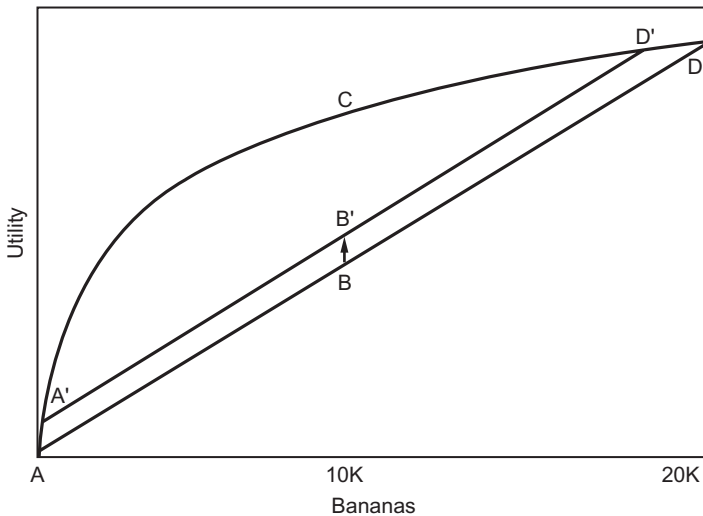

Once one islander gets the idea, all the others can follow. Each islander is driven by the narrow pursuit of her own diversification. Before long, every islander has sold shares in her island to every other islander. With each purchase, the buying islander moves her expected utility line further up, until the extreme points have converged on point C. When the process is complete, every islander will own one tree on every island, and they will all be perfectly diversified, with a known consumption of 10,000 bananas, independent of which islands the banana birds land on. This is the way things work in a well-functioning financial system. The risk of birds landing on an island is idiosyncratic risk, also called a diversifiable risk: if everyone tries to run away from this risk, they can successfully do so.

Next, let's consider a different kind of risk: the weather. Consider again our banana economy where each banana tree is expected to grow 100 bananas per year, and now assume that there are no birds to worry about. In this example, the total of 100 is the average of two possibilities: In a sunny year (50 percent chance), the trees grow 150 bananas each. In a rainy year (50 percent chance), they only grow 50 bananas each. Thus, each island would grow $100 \text{ trees} \times 150 \text{ bananas} = 15,000$ bananas in a sunny year and $100 \times 50 = 5,000$ bananas in a rainy year.

How does this weather risk affect the happiness of the islanders? Recall the banana-utility function (Exhibit 4-4). An islander with a 50 percent chance at 15,000 bananas (sunny year) and a 50 percent chance at 5,000 bananas (rainy year)

EXHIBIT 4-4

BANANA UTILITY WITH WEATHER RISK

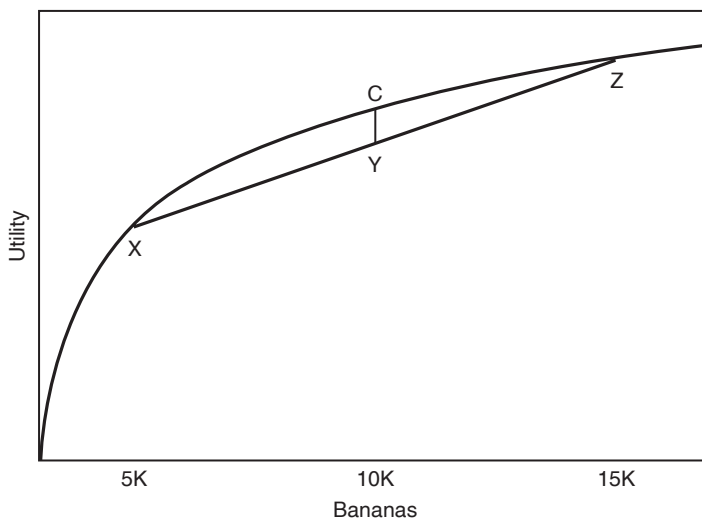

would have an expected utility lying at point Y, the midpoint of line XZ. As in the case of bird risk, the islanders would like to diversify this risk and get to point C, which gives them 10,000 bananas for sure.

Diversification worked for bird risk, but it does not work here. The fundamental difference is that here, the total production in the world is affected by the weather. For the population as a whole, there is no way that the islanders can run away from the weather: if the weather is rainy, then the combined banana consumption in the whole world will still only be $5K * 100 = 500K$, no matter how they eventually share the bananas. For example, if the islanders try the same trick that worked for the bird risk—each islander owns one tree on every island—then it will have no effect on anyone’s banana consumption.

Despite the overall constraint, individual islanders will still have an incentive to diversify. Imagine that an islander offers a contract to give up 100 bananas when it is sunny in return for 100 bananas when it is rainy. Would anyone take the other side of this deal? As in the bird example, the expected return is zero: Because each outcome has a 50 percent chance, the expected value of the trade is zero bananas. Here, however, we are asking someone to give up 100 bananas when they feel relatively hungry (the rainy year) in return for 100 bananas when they feel relatively sated (the sunny year). That is not a fair trade, and nobody is going to take it. That 5,000th banana is worth more than the 15,000th; thus it will be necessary for the first islander to offer better terms.

Suppose that some “hardy islanders” are a little less bothered than other “hungry islanders” when they must go without bananas. Then, while all islanders are assumed to have a banana utility function shaped something like Exhibit 4-4, the relative slopes of these utility functions would differ between hardy and hungry types. In this case, there will be some trades in the banana tree market, with hardy islanders giving up some bananas in rainy years in return for extra bananas in the sunny years. Although we would need more information about the precise utility functions to say exactly what prices will clear this market, we can be confident that an even trade of bananas is not going to do it. Using only the information we have so far, we know that the hardy islanders would demand a positive expected return to do any trades from sunny to rainy. This is a feature of market risk, also called nondiversifiable risk. For example, suppose the hardy and hungry islanders could agree to a trade of one tree in the sunny season (= 150 bananas) for one tree in the rainy season (= 50 bananas). In this case, the hardy islanders would be trading an expected value of $50 * 50\% = 25$ bananas to get an expected value of $150 * 50\% = 75$ bananas, for an expected return of $75/25 - 1 = 200\%$.

The reasoning used earlier can be extended to any additional risk in this banana economy. If this risk is diversifiable, then islanders as a group will be able to run away from it, and nobody would earn any additional return by agreeing to bear it. On the other hand, if the risk is nondiversifiable, then the whole economy will not be able to run away from it, and anyone who agrees to bear it will demand an extra return.

These conclusions are not driven by the *variance of the underlying risk*. Indeed, the bird risk has a higher variance than the weather risk, as can be seen by

comparing Exhibits 4-2 and 4-4. Instead, the *main driver of financial risk is covariance*. With weather risk, the output of each tree perfectly covaries with the output of the entire economy. Anyone who takes on the risk of another tree is committing to eat fewer bananas precisely when she (and everyone else) is hungry. If you don't pay someone an extra return to accept this risk from you, then she will not accept it. This is the intuition behind measuring risk with the CAPM beta.

4.3 ESTIMATING THE COST OF CAPITAL FOR VC

Now, we travel back from our fantasy world of banana birds and return to the slightly more real world of VC. What do you think is the beta of a typical VC investment? A typical public stock will have a beta of one—do you think the beta on VC will be higher or lower than one? Usually, most people think of VC as being very “risky”, but this natural intuition tends to be driven by variance, not by covariance. Because much of VC risk is diversifiable across many different investments—for example, the risk that various new technologies will actually “work”—it would be premature to conclude that the beta risk of VC is higher than it is for public equity.

To evaluate the performance of the whole VC industry, we estimate the regression in Equation (4.2) for both the Sand Hill Index[®] and the CA Index. In the first case, we use monthly data for all the variables; in the second case, we use quarterly data. The results are summarized in Exhibit 4-5, with alphas converted to annualized percentage points in both cases.

The results of the standard CAPM model suggest that VC is less risky than the market ($\beta < 1$) and that it earns abnormal returns ($\alpha > 0$), although this alpha is only significant in the Sand Hill regression. The alphas are economically large, giving us an estimated lower bound for abnormal gross returns (Sand Hill) of 5.7 percent points per year and an estimated upper bound for abnormal net returns of 6.1 percent per year (CA). If these numbers are correct, then they should

EXHIBIT 4-5

CAPM ESTIMATIONS FOR VC INDICES

Coefficient	Sand Hill Index (monthly)	CA Index (quarterly)
Alpha (in % per year)	4.92***	6.10
Market beta	0.76***	0.56***
Adjusted R-squared	0.72	0.19
Sample period	Jan. 1989 to Dec. 2008 (240 monthly observations)	1981:q2 to 2008:q4 (111 quarterly observations)

NOTE: ***, **, and * indicate statistical significance at the 1, 5, and 10% level, respectively.

have investors flocking to the asset class, but unfortunately for VCs, there are three problems for the interpretation of these results: (1) **style adjustments**, (2) **liquidity risk**, and (3) **stale values**. These problems are discussed and analyzed later. The solutions to these problems induce large changes in estimated betas and alphas.

Problem #1: Style Adjustments

In our regression in Equation (4.2), we estimated the market premium ($R_m - R_f$) using historical data on a **market portfolio** comprised of stocks traded in the United States. In theory, the market portfolio should include all risky assets, traded or untraded, everywhere in the world. Thus, this ideal market portfolio would include the stocks, real estate, private equity, human capital, precious metals, banana trees, and everything else we could think of—from every country in the world. Clearly, it is not possible to collect all this data. In Chapter 3, we saw just how difficult it was to collect this data for VC in the United States—and that is one of the easy categories! The difficulties of properly measuring the market portfolio make it very difficult to test the CAPM because it is not possible to test the model with the properly measured market premium. This critique, originally posed by Roll (1977), was one of several early attacks on the underpinnings of the CAPM.

As part of the ongoing debate on the relevance of the CAPM, financial economists developed several theoretical models designed to more fully capture all possible risks. Most of these models used logic similar to our banana economy, where what people really care about are *undiversifiable risks to their consumption*. The market portfolio, however measured, is likely to represent only some of that risk. At the same time as these theoretical developments, empirical researchers were demonstrating that the CAPM cannot adequately explain the returns of various investing styles, such as “small stocks” or “value stocks”. In effect, the abnormal returns of these styles are too big to be explained by chance, so we can no longer say that Equation (4.1) holds on average. By the early 1990s, we had empirical and theoretical objections to the CAPM, but no good model to replace it.

Two researchers, Eugene Fama and Ken French, stepped into this breach with a new empirical approach, and their **Fama-French model (FFM)** is now widely used for estimating the cost of capital.

$$R_{it} - R_{ft} = \alpha + \beta * (R_{mt} - R_{ft}) + \beta^{\text{size}} * \text{SIZE}_t + \beta^{\text{value}} * \text{VALUE}_t + e_{it} \quad (4.5)$$

where α , β , R_{mt} , R_{ft} , and e_{it} are defined as in Equation (4.2), SIZE_t and VALUE_t are the returns to portfolios of stocks designed to be highly correlated with their respective investing styles, and β^{size} and β^{value} are the regression coefficients on these returns. These portfolios are called **factors**, so the FFM is a three-factor model—a market factor, a size factor, and a value factor—and the betas are known as **factor loadings**. The market factor, first used in the CAPM model, is computed as the difference between the return on the market (R_m) and the return on treasury debt. In effect, this is a zero-cost portfolio balanced between a 100 percent **long** position

in stocks and a 100 percent **short** position in bonds. The other factors are also computed as the returns to **zero-cost long-short portfolios**. The SIZE factor has a long position in small-company stocks and a short position in large-company stocks. The VALUE factor has a long position in “value” stocks (stocks with a high ratio of book equity to market value) and a short position in “growth” stocks (stocks with a low ratio of book equity to market value).⁴

To use the results of Equation (4.5) to compute the cost of capital, we need forecasts for the expected returns to the SIZE and VALUE factors. Over the 1926–2008 period, small stocks outperformed large stocks, and the SIZE factor had an average return of 3 percent per year. In the last 30 years, however, this size premium has dropped by about one-third, with an average return of 2 percent per year in the 1979–2008 period. Based on this evidence, some researchers argue that the return premium for small stocks has permanently changed. In this book, we will weigh this recent evidence a bit more heavily than the older evidence and use a forecast of 2.5 percent for the size factor.

The VALUE factor earned an average return of about 4 percent per year over the 1926–2009 period, and this return dropped to about 3 percent over the 1979–2009 subperiod. Thus, we will use 3.5 percent as our VALUE forecast in this book. Interestingly, the VALUE factor has fairly wide swings over some short time periods. At the height of the boom period, technology growth stocks performed very well: in the five-year period from January 1995 to December 1999, VALUE had a negative return of 9 percent per year, including a return of negative 33.4 percent in 1999. Conversely, in the five years from January 2000 through December 2004, VALUE earned a positive return of 13 percent per year. Big difference!

With these forecasts in hand, we can compute a FFM version of the cost of capital as follows:

$$r_i = 0.04 + \hat{\beta} * 0.07 + \hat{\beta}^{\text{size}} * 0.025 + \hat{\beta}^{\text{value}} * 0.035 \quad (4.6)$$

where $\hat{\beta}$, $\hat{\beta}^{\text{size}}$, and $\hat{\beta}^{\text{value}}$ are the estimated factor loadings on the market, size, and value factors, respectively. The “typical” stock would have a factor loading of one on the market factor, and zero on the other two factors, so the typical cost of capital would be 11 percent, just as in the CAPM. For some stocks, however, the FFM can give a very different estimate from the CAPM.

If we only need the cost of capital for a public company, then we might stop right here. The choice of using the CAPM or the FFM often comes down to data availability and time constraints. CAPM betas are available from many standard library sources, and in recent years can even be found for free on Yahoo! Finance

⁴The original reference for this model, with details on the exact construction of the factors, is Fama and French (1993). A nontechnical discussion of the development of the Fama-French model is Fama and French (2004). The Fama-French size and value factors, called “SMB” and “HML” in the finance literature, can be downloaded from Ken French’s website at http://mba.tuck.dartmouth.edu/pages/faculty/ken.french/data_library.html.

(<http://finance.yahoo.com>). The long tradition of using CAPM betas on Wall Street means that many firms have spreadsheets with built-in beta calculations. One must work a bit harder to get Fama-French betas, but it is getting easier over time. For practitioners who want to avoid having to estimate Equation (4.5) themselves, the betas can now be obtained from several commercial sources.

Problem #2: Liquidity Risk

The Fama-French model is now almost 20 years old, and many challengers have arrived in that time. For venture capital applications, the most important innovation is the measurement of liquidity risk developed by Pastor and Stambaugh (2003). Many practitioners feel that venture capital should earn a higher return because the investments are illiquid. The **Pastor-Stambaugh model (PSM)** allows us to estimate this premium using data on VC returns by adding a liquidity factor to the FFM. Like the value and size factors of the FFM, the liquidity factor is based on the returns to a zero-cost long-short portfolio—in this case, a portfolio that holds “low-liquidity” stocks and sells short “high-liquidity” stocks.⁵ The idea is that the returns to this portfolio will reflect the returns that investors require to hold illiquid securities. The mathematical representation of the PSM is as follows:

$$R_{it} - R_{ft} = \alpha + \beta * (R_{mt} - R_{ft}) + \beta^{\text{size}} * \text{SIZE}_t + \beta^{\text{value}} * \text{VALUE}_t + \beta^{\text{liq}} * \text{LIQ}_t + e_{it} \quad (4.7)$$

where LIQ is the new liquidity factor, β^{liq} is its factor loading, and all other variables are defined as in Equation (4.5). Thus, this version of the PSM is a four-factor model. The PSM is a young model, and it has not yet penetrated into practice to the same degree as the FFM. Nevertheless, it is invaluable for our goal of estimating an illiquidity premium for the cost of venture capital. To obtain a cost of capital from this model, we need a forecast for the liquidity factor. The available data to compute this factor only goes back to 1968. In the 1968–2008 period, the average return to the liquidity factor was 5 percent per year, and we use an expected return forecast of 5 percent for LIQ.

With the results of estimating Equation (4.7) and forecasts for the expected returns to the factors, we can use the PSM to estimate a cost of capital as

$$r_i = 0.04 + \hat{\beta} * 0.07 + \hat{\beta}^{\text{size}} * 0.025 + \hat{\beta}^{\text{value}} * 0.035 + \hat{\beta}^{\text{liq}} * 0.05 \quad (4.8)$$

where $\hat{\beta}^{\text{liq}}$ is the estimated factor loading on the liquidity factor, and the other variables are defined as in Equation (4.6). As in the case of the FFM, the “typical” stock would have a factor loading of one on the market factor and zero on the other factors, so the typical cost of capital would still be 11 percent.

⁵The liquidity factor data can be downloaded from Lubos Pastor’s website at http://faculty.chicagobooth.edu/lubos.pastor/research/liq_data_1962_2008.txt.

Problem #3: Stale Values

The CA index relies on the quarterly reports made by the GPs. In these reports, GPs include an estimate of the values for unrealized investments. As mentioned earlier, these estimates are often based on very old information, leading to the phenomenon of stale values. Indeed, many GPs simply report all valuations based on the most recent round of financing, even if a company's outlook had changed significantly since that time. During a rising market, this practice is considered to be conservative; but in the postboom period, some LPs began to complain that these old valuations significantly overstated the value of the portfolios and made it difficult for LPs to properly assess their holdings. In either case, it is clear that such valuations will not reflect the current market values of the companies.

Stale values cause problems when we estimate the regression models as in Equations (4.2), (4.5), or (4.7). In particular, our beta estimates will be downward biased, because the stale prices will not reflect the full current impact of the market on the value of VC companies. (For example, if the “true beta” in the CAPM is equal to one, but only half the companies have updated values, then we will estimate a beta of only 0.5.) If the beta estimates are downward biased, then all the unexplained returns are “credited” to alpha, which would then be upward biased in most cases.

These potential biases are particularly severe for the CA index. The Sand Hill Index[®] uses several statistical adjustments to reduce the stale value problem, but even these methods cannot completely eliminate it. To adjust our regressions for stale values, we include past values on the right-hand side of the regressions: two years of past values for the market factor, and one year of past values for the other three factors. The PSM regression equation with these past values (shown here for the monthly return regression using Sand Hill Index[®] returns), called “lags”, is as follows:

$$R_{vc,t} - R_{ft} = \sum_{s=0}^{23} \beta_s * (R_{m,t-s} - R_{f,t-s}) + \sum_{s=0}^{11} \beta_s^{size} * SIZE_{t-s} + \sum_{s=0}^{11} \beta_s^{value} * VALUE_{t-s} + \sum_{s=0}^{11} \beta_s^{liq} * LIQ_{t-s} \quad (4.9)$$

This equation can be estimated using the same techniques as in Exhibit 4-5, where the effective VC beta on the market is now defined as

$$\beta = \sum_{s=0}^{23} \beta_s \quad (4.10)$$

with equivalent definitions for the other factor loadings, except they are summed over 12 months instead of 24 (for CA Index returns, we sum over eight quarters for the market premium factor and over four quarters for the other factors). Thus, the cost of capital is still given by Equation (4.7).

With these definitions in hand, we are prepared to estimate the cost of venture capital using the PSM (Exhibit 4-6).

EXHIBIT 4-6**PASTOR-STAMBAUGH MODEL ESTIMATION FOR VC INDICES**

Coefficient	Sand Hill Index (monthly)	CA Index (quarterly)
Alpha (in % per year)	-2.11	0.13
Market beta	1.63***	2.04***
Size beta	-0.09	1.04***
Value beta	-0.68***	-1.46***
Liquidity beta	0.26**	0.15
Adjusted R ²	0.83	0.55
Sample period	Jan. 1989 to Dec. 2008 (240 monthly observations)	1981:q2 to 2008:q4 (111 quarterly observations)

NOTE: ***, **, and * indicate statistical significance at the 1, 5, and 10% level, respectively.

Our first use of these results is to estimate a cost of venture capital. Substituting these beta estimates into Equation (4.8) for the SHE index yields the following:

$$r_i = 0.04 + 1.63 * 0.07 - 0.09 * 0.025 - 0.68 * 0.035 + 0.26 * 0.05 = 14.1\% \quad (4.11)$$

Similarly, substituting the beta estimates for the CA index yields this:

$$\begin{aligned} r_i &= 0.04 + 2.04 * 0.07 + 1.04 * 0.025 - 1.46 * 0.035 + 0.15 * 0.05 \\ &= 16.6\% \end{aligned} \quad (4.12)$$

In this book we take the midpoint of the two estimates and round off this cost of capital for VC to 15 percent. Note that the illiquidity premium is $0.26 * 0.05$ or $0.15 * 0.05$, which is approximately equal to 1 percent using either estimate.

Our second use of these results is to evaluate the performance of the VC industry. With all adjustments taken into account, the alphas for both CA and SHE are not significantly different from zero. Recall from Chapter 3 that CA represents an upper bound on the net returns to VC, and SHE represents a lower bound on the gross returns. Thus, these results suggest a point estimate of +13 basis points and -6.11 percent (-2.11% -4%) for the upper and lower bound of net abnormal returns.

SUMMARY

Investors cannot do their job without first estimating their cost of capital. In general, the cost of capital depends on the nondiversifiable risk of an investment. The classic model of nondiversifiable risk is the capital asset pricing model (CAPM), which relates the cost of capital to the market (beta) risk of an investment. In recent years financial economists have

extended the CAPM to include other forms of nondiversifiable risk, including factors related to company size, value/growth status, and liquidity. When estimating the cost of venture capital, we need to take these additional factors into account, as well as make adjustments for the slow-moving values in VC portfolios. With these modifications, we estimate a cost of venture capital of 15 percent. We can also use the same models to evaluate the performance (alpha) of the VC industry. We estimate that the upper bound for the net alpha and the lower bound for the gross alpha are both very close to zero.

KEY TERMS

Capital asset pricing model (CAPM)	Market portfolio	Performance-evaluation regression
Multifactor models, Fama-French Model (FFM), Pastor-Stambaugh Model (PSM)	Beta (β), alpha (α)	Style adjustments
Variance, covariance	Market premium, market portfolio	Liquidity risk
Idiosyncratic risk = diversifiable risk	Market risk = nondiversifiable risk = systematic risk	Stale values
	Least-squares regression	Factor loadings
	Abnormal return	Long position, short position, zero-cost long-short portfolio

REFERENCES

- Fama, Eugene, and Kenneth French, 1993, "Common Risk Factors in the Returns on Stocks and Bonds", *Journal of Financial Economics* 33(1), 3–56.
- Fama, Eugene, and Kenneth French, 2004, "The Capital-Asset-Pricing-Model: Theory and Evidence", *Journal of Financial Economics* 18(3), 25–46.
- Ibbotson Associates, 2009, *Stocks, Bonds, Bills, and Inflation*, Ibbotson Associates, Chicago.
- Kennedy, Peter, 2003, *A Guide to Econometrics*, 5th Edition, MIT Press, Cambridge.
- Pastor, Lubos and Robert Stambaugh, 2003, "Liquidity Risk and Expected Stock Returns", *Journal of Political Economy* 111(3), 642–685.
- Roll, Richard, 1977, "A Critique of the Asset Pricing Theory's Tests. Part I: On Past and Potential Testability of the Theory", *Journal of Financial Economics* 4(2), 129–176.
- Welch, Ivo, 2000, "Views of Financial Economists on the Equity Premium and on Professional Controversies", *Journal of Business* 73(4), 501–538.

EXERCISES

4.1 The Largeco pension fund aggregates its entire portfolio every month across all asset classes and computes its net returns, R_t . Exhibit 4-7 displays these monthly returns for one year, along with the market returns and the risk-free treasury bill rates for those months. Use Equations (4.1) and (4.2) to estimate the beta, alpha, and cost of capital for the Largeco portfolio. How do you evaluate its investment performance?

4.2 True, False, or Uncertain: Early stage venture capital should earn a higher expected return than later-stage venture capital, because early stage ventures have a higher failure rate than later-stage ventures.

4.3 Consider the following three companies:

- (i) Gasco owns and operates a chain of gas stations in the northeast United States.
- (ii) Fuelco is a prerevenue company that is attempting to develop new fuel cell technologies to replace the internal combustion engine.
- (iii) Combco combines the operations of Gasco and Fuelco.

Use qualitative reasoning to order the cost of capital for these three companies from lowest to highest. (There is more than one reasonable way to answer this question, but there are also wrong ways to answer.)

EXHIBIT 4-7

LARGECO RETURNS

Month	R_t	R_m	R_f
January	1.51%	2.24%	0.07%
February	1.34%	1.49%	0.06%
March	-0.39%	-1.16%	0.09%
April	-2.45%	-2.50%	0.08%
May	1.74%	1.35%	0.06%
June	2.33%	2.08%	0.08%
July	-3.81%	-3.87%	0.10%
August	0.32%	0.16%	0.11%
September	2.25%	1.95%	0.11%
October	2.01%	1.67%	0.11%
November	3.76%	4.68%	0.15%
December	2.43%	3.36%	0.16%

4.4 Largeco pension plan begins investing in VC funds in 2006. They commit to a few new funds every year. They compute returns to their VC portfolio by adding the cash flows they receive and the reported company values from all their funds. In 2016, the Chief Investment Officer of Largco (you!) asks for a report on Largco's VC performance over the prior 10 years. The head of the VC team estimates the following CAPM regression:

$$R_t - R_{ft} = \alpha + \beta(R_{mt} - R_{ft}) + e_{it},$$

where R_t is the realized quarterly return on the VC portfolio, R_{ft} represents the risk-free rate for borrowing and lending, R_{mt} is the realized return on the market portfolio, β (beta) is the

regression slope coefficient, α (alpha) is the regression intercept, and e_{it} is the regression error term. All variables are measured quarterly with time periods given by t . The regression produces statistically significant estimates of $\beta = 0.75$ and $\alpha = 7.50$ (annualized), with an R^2 of 0.32. Members of your staff—Albert, Bonnie, Chris, Dave, and Ellen—raise several concerns with these results. As the Chief Investment Officer, you must evaluate these concerns. Which ones (if any) are valid? Which ones (if any) are invalid? For the valid concerns, is there any possible fix?

- (a) Al thinks that the estimated alpha is too high because of survivor bias.
- (b) Bonnie thinks that the estimated beta is too low because of a stale value problem.
- (c) Chris thinks that this model does not properly adjust for the high probability of failure for VC investments.
- (d) Dave thinks that this model does not properly adjust for the illiquidity of VC investments.
- (e) Ellen thinks something else is wrong, but she can't put her finger on it.

THE BEST VCS

IN THIS CHAPTER we discuss specific VC firms and their activities in more detail. The notion that a VC firm's reputation can play a direct role in its future success is an important theme of this chapter. The empirical support for this notion is developed in Hsu (2004), who uses a sample of startup companies that received multiple offers from VCs. Then, using a simple measure of VC reputation, he finds that high-reputation VCs are more likely to have their offers accepted than are low-reputation VCs. Furthermore, high-reputation VCs pay between 10 and 14 percent *less* for shares than do low-reputation VCs. Thus, even if reputation is worth nothing else, it enables VCs to get cheaper prices and more acceptances for their offers.

Section 5.1 discusses some basic economics of venture capital firms, using a simple model of supply and demand to gain insight into the key drivers of VC performance and reputation. Section 5.2 provides a subjective listing of 15 “top-tier” VC firms. This list provides an opportunity to discuss the history, performance, and strategies of some top VC firms. In Section 5.3, we discuss how VC skills and reputation can add value for its portfolio firms through monitoring activities: board representation, corporate governance, human resources, matchmaking, and strategy. These value-added activities of high-reputation VCs provide one justification for the willingness of portfolio companies to accept lower prices from these firms, as found by Hsu (2004).

5.1 THE ECONOMICS OF VC

In Chapter 3, we discussed evidence of performance persistence among VCs. In general, performance in one fund helps predict performance in subsequent funds raised by the same firm. Because LPs recognize this relationship, they react to good performance in Fund X by increasing their demand for Fund X + 1. An increase in demand can be met by some combination of an increase in price (carried interest and management fees) and quantity (size of the fund). It is interesting, however, that VCs rarely raise prices or quantities to a level that clears the market; there is almost always excess demand to get into funds raised by successful firms. There are two main reasons for this phenomenon: one from the “supply side” and one from the “demand side”.

First, we analyze the supply side. Exhibit 5-1 gives an abstract representation of the typical dilemma facing a VC. The X -axis represents the total amount of investment made by a VC for any given time period. To decide on whether to make an investment, the VC compares the expected **return on investment (ROI)** with the appropriate cost of capital for VC (r). As a conceptual device, we imagine that the VC has ordered his investment ideas from best to worst, which ensures that the ROI curve is downward sloping. Furthermore, the VC's time is limited; so with each additional investment, he has less time to devote to each of the others, which also counts against the ROI of each new project. From the evidence of Chapter 4, we assume that the cost of capital (r) is constant, equal to 15 percent for all possible projects; therefore, r can be represented by a straight line. At the optimal investment I^* , the ROI will be exactly equal to r . Although this marginal investment does not earn any **economic profits**, the earlier investments do, with the total economic profits given by the region above r and below the ROI curve. Another way to compute these profits is by calculating the **return on capital (R)**, which is defined as the average ROI of all investments. At the optimal investment level, I^* , we have $R = R^*$. In the language of microeconomics, ROI is a marginal benefit, R is an average benefit, r is a marginal cost, and economic profits are given by the product of $(R^* - r)$ and I^* . For any given model used to estimate r , the difference between R and r will be the alpha for the manager.

Under the representation in Exhibit 5-1, the optimal portfolio size for any VC is driven by the height and slope of the ROI line with respect to the cost of capital. VC investing is hard, and we are sure that if we took a random person off the street, his entire ROI line would lie below the cost of capital, suggesting that this person has absolutely no ability to make profits on any investments. Some moderately talented individuals might get one good idea a year, so I^* would be a few million dollars, with all other investments earning negative economic profits. In all likelihood, such individuals would not earn enough money to be professional VCs and would be better off plying their trade in another profession. The evidence of Chapter 3 suggests that there are a few people with consistent top performance and I^* high enough to support a lucrative career as a VC. Nevertheless, even these VCs recognize that most of what they do is not scalable, and there are limits on the total number of investments that they can make. The numbers from Chapter 2 (Exhibit 2-2) give estimates of \$197B for the total committed capital in the industry, as managed by an estimated 7,497 VC professionals. This means that the industry is managing about \$26M per investment professional (with just a couple of exceptions). Even the most famous VC funds—listed in Exhibit 5-2—usually only manage about \$50M to \$100M per professional. A pyramid-like structure, with junior VCs doing the work with companies and overseen by a senior VC, has never been a successful VC model.

Thus, to increase the size of a fund, a firm would need to hire more senior professionals. If these professionals do not have the same quality as the incumbent members of the firm, then the overall fund returns will suffer. Even if high-quality professionals are hired, there are still organizational constraints of the VC model: Because most firms allow partners to share in the majority of carried interest from all deals, a large organization will tend to weaken the incentives for individual partners. Thus, firms are understandably reluctant to increase fund sizes by very much. One apparent exception to

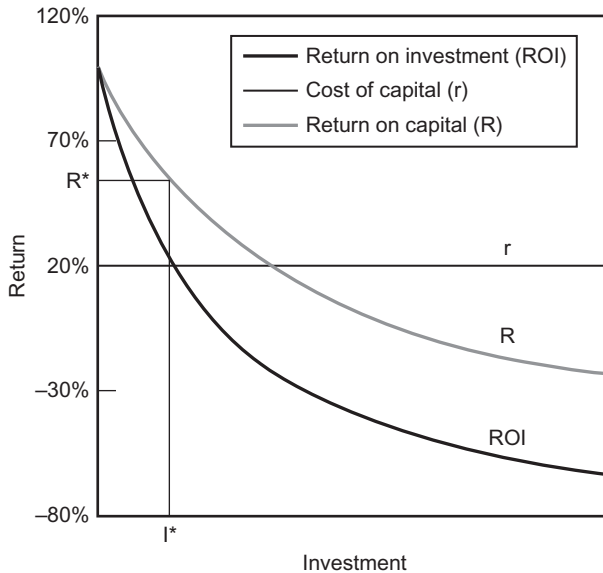
EXHIBIT 5-1**RETURNS AND INVESTMENT**

this reluctance occurred during the boom period, when capital per partner increased by a factor of five at many firms. The exception can be understood as a natural reaction to increased investment sizes for each portfolio company combined with shorter holding periods. In the postboom period, fund sizes have returned closer to historical levels.

This supply-side reasoning can explain why firms do not increase fund sizes to clear the market, but it cannot explain why they do not increase prices (carried interest) to do so. To explain the failure of prices to clear the market, we need a demand-side explanation. Of course, some firms do raise their carried interest—at the height of the boom a few dozen VCs had increased carried interest on new funds to 25 or even 30 percent—but even these firms do not raise carried interest as much as they could have. For example, Accel Partners raised carried interest to 30 percent in 1999 for its \$500M Accel VII fund, but still managed to raise the fund in a few months and to leave many LPs desiring a higher stake.¹

As a market leader, Kleiner Perkins Caufield & Byers was also at a 30 percent carry and barely had to lift the phone to raise its most recent fund. Surely it could have raised its carried interest to 35% and still raised the same size fund. The main

¹See Kaplan (1999) for a discussion of this Accel fundraising process.

reason to avoid doing this is to preserve the long-run value of its franchise. Suppose it did raise carried interest to 35 percent. At this price, the firm would lose some of its LPs. (If it didn't lose any, then it should raise the carry even more, right?) These LPs would be replaced by others who had been clamoring for a place. But now, fundraising is not so easy anymore. The KPCB partners might have to travel around a bit and sell themselves. This takes time away from working with their portfolio companies. Furthermore, the firm's mix of LPs would be different, and some of the long-serving LPs would be gone. The new LPs, lacking the long-standing relationship, are less likely to remain loyal if the firm has a poor performing fund. If that occurs, the firm would need to take even more time to raise its next fund. The KPCB partners probably decided that this extra time—and the risk to investor loyalty—was worth more than the extra return from raising the carried interest on one fund.²

5.2 THE BEST VCS: A SUBJECTIVE LIST

In this section, we select the top 15 VC firms in the world, using our own arbitrary and subjective criteria. We do this because it gives us a good chance to discuss the various strategies employed by the best firms in the world and to provide a springboard for discussing the value of a VC reputation in the rest of the book. Of course, other market watchers will have different opinions, but this is our book, so we get our list. The 15 firms divide naturally into two groups. The six firms in Group A were the easiest to select, for reasons that will be described later. These firms represent our selection as the top six in the world, and we do not think that this grouping will be very controversial. The nine firms in Group B were more difficult to select, and many other firms could reasonably have been included.

We begin with a few definitions. Although industry participants frequently refer to **top-tier firms**, it is never clear exactly who belongs in this group. In this book, when we use the expression *top-tier firm*, we will always be referring to the 15 firms on this list. Furthermore, when we refer to a **star fund**, we mean a specific VC fund with at least \$50M in committed capital and a value multiple of five or greater. A **superstar fund** must have committed capital of at least \$50M and a value multiple of 10 or greater. It would be ideal if we could also use IRR as part of this definition; but data on IRRs are less complete than are data on value multiples, so we rely only on the latter for the achievement of star and superstar status. (Remember that the use of **bold italics** means that these definitions are special to this book, and are not industry-standard terms.)

²Yet another benefit of not clearing the market might be to keep the emergency option of raising annex funds in times of severe market busts. Both in the aftermath of the dot.com bubble and in 2009, a number of top-tier VC (and buyout) firms (including KPCB) raised annex funds from existing and new investors to ensure sufficient capital to feed their existing portfolio companies while the market recovered.

A few comments on the criteria used for selection:

1. In the last several years, the industry publication *Private Equity Analyst* has reported on firms that have been able to raise their carried interest to 30 percent. The publication identifies eight such VC firms, including all six firms from Group A. A seventh firm, New Enterprise Associates, is included in Group B. The eighth firm, Bain Capital, charged a 30 percent carry on a VC fund, but had earned its reputation (and an earlier 30 percent carry) primarily as an LBO firm.
2. *The Private Equity Performance Monitor*, a new industry publication first discussed in Chapter 3, allows us to observe the performance for 1,193 VC funds. From this sample of funds, 63 (about 5 percent) have achieved at least star status. Of these 63 stars, 18 had committed capital of less than \$50M, so we drop them.³ Of the remaining 45 stars, 14 have achieved superstar status. Only six firms have achieved a superstar fund with at least \$100M in size *plus* another star (or better) fund. These are the six firms in Group A. (Not coincidentally, this represents six of the eight firms with a confirmed 30 percent carry.)
3. Items (1) and (2) make it easy to identify the top six firms for Group A. To identify the nine firms in Group B, the primary driver was consistency of top-quartile and top-half performance, presence of star funds (if any), combined with information on carried interest percentage (when available), history of innovative VC strategy, and our own subjective view of their reputation in the industry.

Exhibit 5-2 gives the rankings, along with a few key facts about each firm. We follow the exhibit with a short discussion of each firm. We will then use these firms as a reference as we discuss VC activities and competitive advantage in Section 5.3. Note that four of the top-tier firms, including three from Group A, are located in Menlo Park, California, right in the heart of Silicon Valley. Menlo Park is the center of the VC universe, with about 60 VC firms, more than 80% of which—including all eight on our list—have their offices on one street: **Sand Hill Road**. This curious agglomeration of VC activity demonstrates a phenomenon that economists call “local network effects”, where firms in the same industry co-locate to take advantage of (and thus add to) the benefits of that local human capital and other shared resources. Although many Silicon Valley startups are riding the outsourcing wave for some of their corporate functions, it is telling that the top-management function usually remains in Silicon Valley, and many of the most successful investors remain on one street in Menlo Park. Not only has this part of VC resisted globalization, but so far it has also resisted Americanization (most VC remains in small pockets of the United States instead of spreading to cheaper

³Prevalence of small funds among star funds is expected, and in most cases these are the VC firms’ first funds that had a home run or two. It is much harder for firms to repeat the >5X returns with subsequent larger funds.

EXHIBIT 5-2*TOP-TIER VENTURE CAPITALISTS*

Group	Name	Location	Founded	\$ under management
A	Accel Partners	Palo Alto, CA	1983	\$6.0B
	Benchmark Capital	Menlo Park, CA	1985	\$2.9B
	Charles River Ventures	Waltham, MA	1970	\$2.4B
	Kleiner Perkins Caufield and Byers	Menlo Park, CA	1972	\$3.3B
	Matrix Partners	Waltham, MA	1982	\$4.1B
	Sequoia Capital	Menlo Park, CA	1971	\$4.0B
B	Battery Ventures	Wellesley, MA	1983	\$3.2B
	Doll Capital Management (DCM)	Menlo Park, CA	1996	\$2.0B
	Draper Fisher Jurvetson	Menlo Park, CA	1986	\$4.4B
	Institutional Venture Partners	Menlo Park, CA	1974	\$2.2B
	InterWest Partners	Menlo Park, CA	1979	\$2.8B
	Menlo Ventures	Menlo Park, CA	1976	\$4.0B
	New Enterprise Associates	Baltimore, MD	1978	\$10.7B
	Summit Partners	Boston, MA	1984	\$11.2B
Technology Crossover Ventures	Palo Alto, CA	1995	\$7.7B	

NOTE: Firms are listed alphabetically within each group.

SOURCE: *Dow Jones LP Source Galante*, Firm websites.

places in the country), Californization (California VC is overrepresented in Silicon Valley), and even Menlo Parkization (Sand Hill Road rents must be among the highest in the city—why don't more VCs move?). This demonstrates that local network effects remain an important brake on the geographic homogenization of economic activity.

In a cross-country echo of the local network effects on Sand Hill Road, we see that two of the firms on the list are located in Waltham, Massachusetts, which lies within the second-largest VC agglomeration in the world: the Route 128 corridor around Boston. These two firms, Matrix Partners and Charles River Ventures, are not only in the same town and street (Winter Street—the Sand Hill Road of the east), but also in the same building (1000 Winter Street). All told, there are 16 VC firms in the small town of Waltham, with 13 of them on Winter Street—and six of them at the same 1000 address. Battery Ventures, another top-tier VC, is only minutes away in the neighboring town of Wellesley.

There is an important caveat to doing this exercise: as is well known among industry participants, no one did spectacularly well after 2000, and even the Group A funds, if they don't perform in the next five years, could be in big trouble. Also, there is not a lot of data since five years ago to update the list; so the ranking is still largely

based on the performance from the 1990s and the inferences made from the fact that these funds are still easily raising funds from LPs (who know the true performance).

Now, let's go to the list. We begin with the Group A firms, in alphabetical order.

Group A

Accel Partners is a firm that rode the boom, had a bumpy ride in the postboom period, and seems to have survived with its stellar reputation bruised but alive. In business since 1983, it has raised 10 general funds; the most recent, Accel X, closed with \$520M in 2007. In addition to these general funds, Accel was the first major VC to raise a dedicated "Internet fund", with the \$20M Accel Internet Fund I raised in 1996 and three subsequent Internet funds raised over the next four years. Accel has also been an innovator in other ways, with geographic expansion (the \$500M Accel Europe fund raised in 2001, second European fund raised with \$450M in 2005, and the \$60M Accel India Venture Fund raised in 2008), and a unique partnership with the most famous name in LBO investing—Kohlberg Kravis Roberts & Co., with whom it raised the joint Accel-KKR fund, with \$500M in 2000, and two subsequent funds in 2006 and 2008 at \$400M and \$600M, respectively.⁴

Accel's first star fund was the \$135M Accel IV raised in 1993, and it sealed its reputation with the superstar \$150M Accel V fund raised in 1996.⁵ By the time of the \$500M Accel VII fund raised in 1999, it had joined the elite with a 30 percent carry. The firm hit rough times with its 2001 Accel VIII fund. Originally, this fund had \$1.6B in committed capital. In the postboom period, it became apparent to Accel and to many other GPs that the available opportunities were insufficient to sustain these boomtime megafunds, and it subsequently reduced the size of this fund to \$680M, but not before some controversial attempts to extend its investment period on the full amount. The LP community appears to have forgiven this episode, however, because it effortlessly raised Accel IX with a 30 percent carry and almost certainly kept its carry level for Accel X, judging from the LP demand. As of March 2007, Accel VIII has returned 37 percent of committed capital and has a net IRR of 2.6 percent, which puts it in the second quartile of its vintage year peers. Its best-known recent investment is Facebook, which it has yet to exit as of the writing of this book.

Benchmark Capital is the new kid on the block among the Group A firms. Its first fund, the \$113M Benchmark Capital Partners Fund raised in 1995, had a spectacular investment in eBay, which netted the fund (LPs + GPs) \$2.5B on a \$5M investment. eBay was not the only successful exit for this fund, as the fund is reported to have earned a value multiple of 42X, giving it the highest reported

⁴Unless otherwise noted, all citations to fund sizes, vintage years, and carried interest levels, are drawn from Dow Jones Financial Information Services.

⁵Unless otherwise noted, all performance data and citations to star funds or superstar funds are derived from data from *The 2005 and 2008 Private Equity Performance Monitor*.

multiple of all time. Benchmark II, a \$250M fund raised in 1997, reached star status to give the partners two great successes in a row. With this performance, it was able to raise its carried interest to a flat 30 percent by the time of the \$1.1B Benchmark IV fund in 1999. (Its previous funds had used a performance-based sliding scale for the carry.) Like several other top-tier firms, Benchmark has expanded internationally, with a \$500M Europe fund raised in 2000 and a \$260M Israel fund raised in 2002. After successfully raising three Europe funds, Benchmark Europe was spun off in 2007 and changed its name to Balderton Capital; Benchmark Israel raised its second fund (\$250M) in 2005. As of March 2007, the 1999 Benchmark IV has returned 41 percent and has a net IRR of 0.2 percent, putting it in the second quartile among its vintage year peers. The LPs have stayed loyal in return, and the \$400M Benchmark V fund was raised in 2004, followed by its latest, the \$500M Benchmark VI raised in 2008. Its notable recent exits include OpenTable, which went public in May 2009 and traded up 72% on its first day of trading.

Charles River Ventures is one of the two Group A firms from 1000 Winter Street in Waltham. The firm also maintains a smaller office on Sand Hill Road, giving it a presence in both VC centers. Like many of the other top-tier firms, it had solid performance for many years, performed spectacularly in the boom, faltered in the postboom period, and has regained its focus and reduced the size of its most recent fund. Its first star was the \$85M 1995 Charles River VII fund. It gained superstar status with its \$100M 1997 VIII fund. Following this fund, it was able to raise its carried interest to 30 percent, a level it has maintained ever since, most recently with its \$320M Charles River XIV fund raised in 2009. As of December 2006, its 2000 fund (CRV XI) has a net IRR of 0.9 percent, which puts it in the second quartile of the 2000 vintage funds.

Charles River runs a seed program called QuickStart, which it launched in 2006 after recognizing that advances in technology had enabled Internet startups to operate with much less cash than traditionally required. In this program, Charles River invests \$250K in the form of a loan to a promising new startup. Startups accepting loans give Charles River the right to join a first-round syndicate, with the loan converting to equity at that point.

Our next fund, **Kleiner Perkins Caufield & Byers (KPCB)** was first discussed in Chapter 3, where we saw evidence of two superstar funds (the \$225M KPCB VII and the \$299M VIII), and we deduced that KPCB IX, a \$550M fund raised in 1999, defied the gravity of the worst vintage year in VC history and reached star status with its Google exit. Perhaps even more impressive than these returns is the list of famous KPCB investments: AOL, Amazon.com, Compaq, Electronic Arts, Genentech, Google, Idec, Intuit, Juniper Networks, Netscape, Sun, and Symantec. It is a “who’s who” of successful technology businesses, reaching across industry lines to leaders in life science, software, hardware, communications, and the Internet. This performance has been sustained through multiple generations of firm leadership and seems in no danger of abating. That said, it is a bit troubling that KPCB’s most recent funds’ (KPCB X – KPCB XIII) performances are not publicly available as of the writing of this book.

KPCB has recently made big bets in two directions: Asia and green technology. It closed the \$360M China Fund in 2007 and now has two satellite offices in Beijing and Shanghai. It also raised the Green Growth Fund in 2008, which targets large clean-technology companies.

Matrix Partners shares a building in Waltham with Charles River Ventures and also maintains a smaller office on Sand Hill Road. Matrix had four straight top-quartile funds from 1985 to 1997, including one star and two superstar funds: the \$80M 1990 Matrix III fund (star), the \$125M 1995 Matrix IV fund (superstar), and the \$200M 1997 Matrix V fund (superstar). Indeed, Matrix came very close to having two funds with value multiples above 20 (double-superstar?), which has not even been accomplished by its famous peers from Sand Hill Road. Its investment record includes several famous names and spans across software, hardware, and communications, including Apple Computer, Veritas, and Sycamore Networks. Its 2000 Matrix VI has returned only 12 percent of committed capital and has little chance of ever breaking even, as the remaining portfolio is held at 54 percent of fund size. In contrast, its 2002 fund (Matrix VII) is doing much better, and has a net IRR of 12.4 percent, putting it in the top quartile among its peers. In addition to its latest general fund, the \$450M (plus \$150M optional fund) Matrix IX, raised in 2009, it also raised a China fund and an India fund in 2008 and 2006, respectively, thus making inroads to two more fast-growing markets.

Sequoia Capital is certainly KPCB's strongest competition for the title of "most famous VC firm in the world". Its investment list is almost as impressive as KPCB's—Apple, Cisco, Google, Electronic Arts, Symantec, Yahoo, YouTube—missing only the life sciences breadth of its neighbor on Sand Hill Road. Note also the overlap in investments between these two top firms. This is the most salient example of the pervasive **syndication** of investments among firms of similar rank. In a VC syndicate, a **lead investor** takes primary responsibility for the investment, usually making the largest investment and taking the board seat. (In some cases, such as the Google investment, this role can be shared by co-leads.) The other investors take smaller stakes and may or may not get a board seat. Syndication helps to spread risk and gain the benefits of larger networks. The prevalence of syndication varies over time, often depending on the relative supply of capital. In the preboom period, syndication was the norm. During the boom, it was comparatively rare.

Sequoia's performance has been remarkable. It is the only firm in the world with four confirmed star funds (three of which were superstars): The \$64M 1989 Sequoia V fund (star), the \$100M 1993 Sequoia VI fund (superstar), the \$150M 1996 Sequoia VII fund (superstar), and the \$250M 1998 Sequoia VIII (superstar). No other firm, not even KPCB, can match that record. KPCB's main claim for the top spot is that it has earned similar returns with funds about twice the size.

Group B

Battery Ventures is our third firm from the Route 128 corridor around Boston. Relatively young for firms on this list (founded in 1983), Battery made up for lost

time with six top-quartile funds in its first six attempts, including the star \$200M 1997 Battery Ventures IV. It charged a 25 percent carry on its seventh and eighth funds (raised in 2004 and 2008). Reflecting the tough economic conditions of 2009–2010, for its latest fundraising efforts for its ninth fund, targeted at \$750M, Battery plans to use a performance-based sliding scale, charging a base carry of 20 percent, which will climb to 30 percent once it returns three times capital to LPs. Battery has a broad focus—both by stage and industry—and has made headlines by teaming up with the Blackstone Group, a major LBO firm, on several deals.

DCM (Doll Capital Management) is the youngest firm in this list of top-tier VCs—it was founded only in 1996. Though there are many other firms with much longer track records, we pick this firm for two reasons. One is its relatively strong track record in the non-U.S. markets, notably Asia, where we have seen the fastest growth in recent years. It has had offices in Menlo Park, CA, and Beijing, China, and recently opened a satellite office in Tokyo as well. While many U.S. VC firms have recently started investing in China, few can claim exits yet; in contrast, DCM invested in the region as early as 2000, and has had a string of successful exits. Its notable Asia investment exits include 51job (NASDAQ IPO in 2004), VanceInfo (NYSE IPO in 2007), and Fortinet (NASDAQ IPO in 2009). Its notable domestic U.S. investment exits include Foundry Networks (1999 IPO), About.com (1999 IPO; then acquired by New York Times; its Japanese affiliate also went public on JASDAQ), and Neutral Tandem (NASDAQ IPO in 2007). According to the *Wall Street Journal*, Fortinet was one of the best-performing VC-backed IPOs in 2009.

Another reason is the premium carry it charges. According to Private Equity Analyst, its fifth fund (the 2006 \$505M DCM V) and its latest fund (DCM VI, which is being raised amid the toughest economic conditions in decades) charge a 25 percent carry. We interpret this to be an indication of LPs' enthusiasm about the firm's international reach and recent successes.

Draper Fisher Jurvetson (DFJ) is an innovative firm that has experimented with several different organizational forms and strategies. Its inclusion on this list was a difficult decision, because not much performance information is available. The \$50M 1995 DFJ III fund reached star status, but we know very little about its 11 subsequent funds, save for the 1999 DFJ ePlanet Ventures (returned 136 percent and is in the top quartile as of March 2007) and the 2000 DFJ VII (in the second quartile as of September 2007). We include DFJ as a top-tier firm because of its string of notable successful investments in companies including Skype, AthenaHealth, and Baidu, and because of its reputation as market leaders in extending its VC brand. The DFJ "affiliate network" includes 17 firms across 13 locations on three continents. Many of these firms are cobranded with the DFJ name, such as Draper Triangle Ventures (Pennsylvania and Ohio), DFJ DragonFund (China), and DFJ VTB Aurora (Russia).

It charged above-market carried interest of 25 percent from 1999 to 2007. In its current efforts to raise the \$250M DFJ X, it is offering a performance-based sliding scale, charging a 20 percent base carry until the fund returns 2.5 times the committed capital, at which point GPs will catch up to 25 percent.

Institutional Venture Partners would have made the Group B list in the first edition of this book, were it not for some uncertainty about its future given significant personnel turnover at the time. The firm has apparently weathered the transition well, and including it in the Group B list this time was an easy decision for us, given its remarkable track record. It is a consistent performer with seven out of its eight funds from 1985 to 2004 in the top half category. Three of them are in the top quartile, including the 1994 \$141M Institutional Venture Partners VI and the 1996 \$187M Fund VII, which were both star funds.

It has two offices, one in Menlo Park (on, you guessed it, Sand Hill Road) and another north of San Francisco in Mill Valley, CA. It invests in late-stage private technology companies in communications and wireless technology, enterprise IT, and Internet and digital media. Its famous investments include TiVo, Juniper Networks, Netflix, MySQL, and more recently Twitter.

InterWest Partners is an early-stage VC firm founded in 1979. It is another consistent performer, with six out of its seven funds from 1985 to 2005 in the top half category. Three of them are in the top quartile. Commensurate with its long history (its first fund was raised in 1980), it boasts a long list of successful exits, with more than 60 IPOs and nearly 60 upside acquisitions. Its early successes include Silicon Graphics and Copper Mountain Inc., and its investments are about evenly split between life sciences and IT areas. Its investments on the IT side are fairly concentrated in the San Francisco Bay Area, while its life science investments—which are often originated in university research centers and in collaborations with biopharmaceutical companies—are geographically more diverse, with locations as varied as the Rocky Mountain states, San Diego, Northeast, and Florida.

Aside from the public record about its performance, another deciding factor for including the firm on our list was its carried interest level; according to the *Wall Street Journal*, it has charged 25 percent carry in the last decade.

Menlo Ventures, together with InterWest Partners, were honorable mentions in the first edition of this book. Menlo Ventures is an IT shop, meaning it does not make any investments in life science firms, while it is open to investing in early to late-stage rounds. It has one star fund, which is the 1988 \$111M Menlo Ventures IV; in addition, its 1997 \$253M Menlo Ventures VII was almost a star fund, with 4.8X value multiple and a net IRR of 135.6 percent as of September 2007. Its 2001 \$1.5B Menlo Ventures IX has a net IRR of 5.4 percent as of September 2007, which puts it in the second quartile category. It invested in earlier Internet and communications companies such as Hotmail, Infoseek, and UUNET, and more recently had successes with Acme Packet (2006 IPO) and Cavium Networks (2007 IPO). Its slogan, “Big Ideas. Realized”, is quintessential Silicon Valley VC, and the firm states it only targets “large” emerging markets that can support a \$100M-per-year revenue after achieving realistic market shares. Likewise, it has so far stuck to its U.S.-centric model, with its focus on U.S.-headquartered companies only.

New Enterprise Associates (NEA) holds the distinction of raising the largest dedicated VC fund in history. Unlike most other megafunds of the boom period, its \$2.3B 2000 NEA X fund was never reduced, and current performance places it

among the top-quartile performers for its vintage. It later raised two more \$2B+ funds, NEA XII (\$2.5B, closed in 2006), and XIII (\$2.5B, just closed as of January 2010). NEA's history includes a remarkable six top-quartile performers, including star status for the \$230M 1993 NEA VI fund. Its famous investments include Silicon Graphics and Immunex, and it has maintained a strong record across all parts of the information technology and life sciences sectors, with a recent third focus on energy investments. Though it still maintains its operations in Baltimore, most of its investment professionals are located in either Silicon Valley or Chevy Chase, MD, in the metropolitan DC area.

Like many of its peers, NEA has made efforts to globalize. In 2007, it contributed \$30M from its twelfth fund to \$189M NEA-IndoUS Funds, which will invest in early-stage IT companies in India. It has also made direct late-stage and growth equity investments in companies outside of the United States using its core fund. As a result, its twelfth fund investments consist of about 84 percent North America, 7 percent China, 4 percent India, and 5 percent the rest of the world. NEA is the only firm in Group B to have obtained a 30 percent carry, but it has done so while effectively reducing its management fee percentage. Although this demonstrates a commendable willingness to accept nearly exclusively performance-based compensation, it also suggests slightly less pricing power than is enjoyed by Group A firms.

Summit Partners follows a resource-intensive, but very successful, strategy. To generate investment opportunities, Summit has developed a proprietary database of small to midsize companies. To maintain this database, Summit employs a relatively large number of junior professionals to periodically communicate with representative firms. Like many other firms, Summit also maintains a significant presence at technology industry events; but unlike most other firms, it takes a systematic approach to its data gathering at these events, constantly adding to and refining its database. The resulting database is the envy of the industry and often allows Summit to obtain the holy grail of all private equity investors: **proprietary deal flow**. Although some of its investments could be classified as mezzanine or even buyout, the majority remains at the late-stage VC and growth equity level. Its main competitor in this strategy is TA Associates, but TA's strategy tilts toward somewhat larger investments and is typically not classified as a VC. The competition and ties between these firms are quite extensive: Summit was founded when some TA professionals broke away and formed a new firm.

Summit's performance has been remarkably consistent. All seven core funds raised since its 1984 founding have IRRs above the median for their vintage years, and five of these seven are in the top quartile, with the \$610 million 1995 Summit Ventures IV fund achieving star status. Its consistent performance allows it to charge a 25 percent carried interest. It raised a \$1B European growth equity fund in 2008, which is its first non-U.S. fund.

Technology Crossover Ventures (TCV) is true to its name, engaging in **crossover investing** that spans late-stage VC and young public companies. This eclectic strategy has served TCV well, with five straight top-half funds from 1995 to 2004. Its \$1.7B 2000 TCV IV returned 79 percent of its capital, has a net IRR of

4.4 percent as of September 2007, and is in the second quartile among its vintage year peers. It wrapped its largest-ever \$3B TCV VII in 2007. It previously was reported to be charging 30 percent for its fifth fund, raised in 2004, but whether it continued to charge a premium carry for its latest fund could not be confirmed as of the writing of this book.

Unlike many of its peers, TCV has stuck it out with its focus on U.S. domestic deals—especially those away from the crowded hubs of Menlo Park, CA, and Waltham, MA. Its portfolio company locations range from Suwanee, GA, to Melville, NY, as well as Palo Alto and Boston.

This completes our list. Many other highly respected firms could reasonably have displaced some firms in Group B. In alphabetical order, these “honorable mention” firms include Columbia Capital (Alexandria, VA), Lightspeed Venture Partners (Menlo Park, CA), Mayfield Fund (Menlo Park, CA), Mohr Davidow Ventures (Menlo Park), North Bridge Venture Partners (Waltham, MA), Polaris Venture Partners (Waltham, MA), Sierra Ventures (Menlo Park, CA), TL Ventures (Wayne, PA), Trinity Ventures (Menlo Park, CA), US Venture Partners (Menlo Park, CA), and VantagePoint Ventures (San Bruno, CA). Three more firms, Bessemer Venture Partners (Wellesley Hills, MA), Greylock Partners (Waltham, MA), and Venrock Associates (NY, NY), have high-profile reputations but do not have sufficient information in the public domain about past performance or carried interest, so it is not possible to judge whether they belong in the top tier.

5.3 VC VALUE ADDED AND THE MONITORING OF PORTFOLIO FIRMS

After studying the list of top-tier VCs, it is natural to wonder how they got there. What value-added activities do VCs perform, and how does one acquire the skills to do them well? In Chapter 1, we categorized VC activities into three groups: investing, monitoring, and exiting. In each of these three groups, there is a potential for VCs to add value. The investing and exiting groups include many activities that require financial analysis; Parts II, III, and IV of this book cover these activities in detail. In contrast, the monitoring of portfolio firms, although certainly a crucial area for VC value added, does not lend itself well to quantitative analysis. Thus, we restrict our discussion to a brief summary of five main monitoring activities, with references to the relevant academic literature. In many of these activities, it is the VC reputation itself that provides a main source of added value.

Board Representation A seat on the board of directors is a key mechanism for VC monitoring. With a position on the board, a VC has explicit power to participate in and influence corporate activities. The level of board representation can be a highly contentious negotiation. VCs often want multiple board seats, whereas entrepreneurs are understandably reluctant to cede much control. In early round investments, a lead investor will virtually always get at least one board seat

and other members of a syndicate will often get seats as well. In later rounds, board seats are not universal, and some investors will settle for board observer status, which does not have voting rights.

A VC spends a substantial fraction of his time as a board member. Many of the other monitoring activities are accomplished in the context of the board role. Notwithstanding the importance of this role and an enormous academic interest in studying the workings of corporate boards, we still know very little about how an individual person can become an effective board member. For obvious reasons, researchers are rarely invited into boardrooms, so most of what we do know about boards comes from quantitative studies of the relationship between company performance and various board characteristics.

This academic literature is mostly focused on board structure in public companies, rather than the dynamics within the boardroom. Some of the findings have some interest for VCs. For example, Yermack (1996) finds an inverse relationship between firm market value (per dollar of book assets) and board size. Although the causality of this finding is hotly debated, it is consistent with a tendency for VCs to favor small boards, sometimes at the cost of offending members of the management team who expected to be included. In a more cautionary result for VCs, Fich and Shivdasani (2006) find that public companies with “busy boards”—those where a majority of outside directors hold three or more directorships—have inferior performance to other companies for a variety of measures. The relevance of this finding for VCs is uncertain, because the outside directors of public companies, unlike VCs, usually do not consider their directorships to be their full-time job. Nevertheless, the results suggest that board member effectiveness cannot be scaled indefinitely.

In a related study, Tian and Wang (2010) develop a measure of VCs’ failure tolerance and find that IPO firms backed by more failure-tolerant VCs are significantly more innovative, even long after VCs exit the IPO firms. Their measure of failure tolerance is a function of how many rounds (and how long) VCs invested in a firm before its ultimate failure. Since new rounds of financing typically require board approvals, this measure reflects existing VCs’ exercise of their voting powers as board members. The persistence suggests that VCs’ attitudes toward failure have likely been internalized by the startup firms and become part of the firm’s culture.

Corporate Governance Corporate governance rules define the power-sharing relationship between shareholders and managers. In recent years, a large body of academic research has demonstrated the relationship between corporate governance rules and corporate performance. The best time to set good rules is while a company is still small and before it goes public. VCs can and do have significant input into this process. Hochberg (2005) studies the first proxy statements filed by public firms to determine the influence of VC-backing on various corporate governance rules. She finds that VC-backed companies are (1) less likely to engage in aggressive accounting prior to their IPO, (2) more likely to have independent boards and board subcommittees, and (3) more likely to separate the role of chairman and CEO. Although it is always difficult to prove causality in

these kinds of studies, the analysis does show that these governance differences do not occur in the presence of large, non-VC shareholders.

Human Resources VCs also spend a large fraction of their time working on human resource issues at their portfolio companies. This work requires the same set of skills used to evaluate management during the investment phase, plus the ability to recruit new managers and replace underperforming ones. In all these activities, a VC's reputation can make a huge difference, and the name of a VC investor is often invoked as a reason to join a company. (We have heard many MBA students, when describing their prior experience at a startup, say the name of the top-tier VC that invested in the company even before they said the name and business of the company!) Hellmann and Puri (2002) studied the human resource practices for a sample of VC-backed and non-VC-backed companies in Silicon Valley. They found that VC backing accelerates the hiring of senior executives (such as a VP of marketing), the adoption of stock option plans, and the turnover of the CEO. As in the Hochberg study, it is difficult to prove causality, but the authors do a good job of trying. One notable finding is that CEO turnover often occurs long after the original VC financing, suggesting that the financing and the turnover were separate events. Furthermore, the authors find that the replaced CEOs often stay with the company in another capacity. This last result suggests that the VCs managed to keep the skills of a founder-CEO while simultaneously getting a more experienced CEO to run a larger company.

Matchmaking VCs will often use their contacts and reputation to make introductions that can lead to new partnerships, customers, and suppliers. As in the human resource function, the reputation of the VC can often lead to relationships that would not otherwise be possible. One straightforward method is for VCs to make connections among their past and current portfolio companies. Academic research on the efficacy of VC matchmaking suggests that VCs do indeed facilitate alliances among their portfolio firms (Lindsey 2008). In this case, a potential portfolio company should care about the average quality of the other companies in the VC's portfolio, because these companies are more likely to be potential partners.

Strategy As advisors to the CEO, VCs have the opportunity to participate in strategic decisions. This opportunity must be used wisely, as many generalist VCs are not qualified to give strategic advice across all sectors. Indeed, it is in the area of strategy that it makes the most sense for individual VCs to focus on a specific sector so that they can build the knowledge and experience to add value. For VC firms as whole, the focus on one or two industries can enable the entire organization to participate as specialists in strategic discussions with the firm.

It would be silly to cite any academic literature here. "Strategy" is a large academic subject unto itself, and to do it justice would require at least a separate book and certainly a different author. What we can say here is that there is no existing academic evidence on the strategic contribution of VCs to the success of their portfolio companies. To the extent that the VCs can make such contributions, they can certainly be an important source of value added.

SUMMARY

A VC's reputation is a valuable asset. A high-reputation VC is more likely to have its term sheets accepted and can pay lower prices for shares than do low-reputation VCs. Top-tier VCs earn their reputations with superior investment performance, and many of these top-tier firms raise their carried interest to 25 or even 30 percent. Nevertheless, there is excess demand by potential LPs to invest in such top-tier VCs, even at these higher prices. VCs allow this excess demand so that they can maintain long-run relationships with LPs, minimize the time needed for fundraising, and maximize the chance of maintaining their high reputation. This reputation is valuable not only for striking better deals with portfolio companies, but also for increasing the value added to these companies. This value is added through monitoring activities such as board membership, corporate governance, human resources, matchmaking, and strategy.

KEY TERMS

Return on investment (ROI)	<i>Star fund</i>	Lead investor
Return on capital (<i>R</i>)	<i>Superstar fund</i>	Proprietary deal flow
Cost of capital (<i>r</i>)	Sand Hill Road	Crossover investing
Top-tier firm	Syndication	

REFERENCES

- Asset Alternatives, 2005, *Galante's Venture Capital & Private Equity Directory*. Asset Alternatives, Private Equity Analyst, *various issues*.
- Fich, Eliezer and Anil Shivdasani, 2006, "Are Busy Boards Effective Monitors?" *Journal of Finance* 61(2), 689–724.
- Hellmann, Thomas, and Manju Puri, 2002, "Venture Capital and Professionalization of Start-up Firms", *Journal of Finance* 57(1), 167–197.
- Hochberg, Yael V., 2005, "Venture Capital and Corporate Governance in the Newly Public Firm", working paper available at <http://www.kellogg.northwestern.edu/faculty/hochberg/html/>.
- Hsu, David H., 2004, "What Do Entrepreneurs Pay for Venture Capital Affiliation?" *Journal of Finance* 59(4), 1805–1844.
- Kaplan, Steven N., 1999, "Accel VII", Unpublished case study, available online at <http://faculty.chicagobooth.edu/steven.kaplan/teaching/accel7.pdf>.
- Lindsey, Laura, 2008, "Blurring Firm Boundaries: The Role of Venture Capital in Strategic Alliances", *Journal of Finance* 63(3), 1137–1168.
- Private Equity Intelligence, 2005, *Private Equity Performance Monitor*.
- Private Equity Intelligence, 2008, *Private Equity Performance Monitor*.
- Tian, Xuan, and Tracy Wang, 2010, "Tolerance for Failure and Corporate Innovation", available at http://papers.ssrn.com/sol3/papers.cfm?abstract_id=1399707.
- Yermack, David, 1996, "Higher Market Valuation of Companies with a Smaller Board of Directors", *Journal of Financial Economics* 40(2), 185–212.

CHAPTER 6

VC AROUND THE WORLD

THE MODERN VC industry was born in the United States, but the rest of the world is catching up. Although the United States still comprises about one-half of the worldwide VC investment, markets are starting to mature in Europe—especially the United Kingdom—and in Asia, with exciting developments in the emerging economies of India and China. Nevertheless, many countries in continental Europe, Latin America, and Africa continue to lag behind the rest of the world in VC activity, both in absolute terms and relative to GDP. In Section 6.1, we document the global distribution of VC activity and discuss several reasons why this pattern exists. In Section 6.2, we extend our risk-and-return analysis of Chapter 4 to an international setting and suggest several approaches for the estimation of the cost of capital for international VC.

6.1 THE GLOBAL DISTRIBUTION OF VC INVESTING

To study the global pattern of VC investing, we face a challenge in defining a consistent set of data across different types of economies. Currently, the best available data is compiled by the global accounting firm PricewaterhouseCoopers in their *Global Private Equity Report* (GPER). The GPER combines data from the Money-Tree survey in the United States (first seen in Chapter 1) with similar data from separate surveys of Europe, Asia, and a few countries in Africa, Latin America, and Oceania. Because the data is pulled from disparate sources, they have varying levels of reliability and comparability. All the surveys attempt to measure private equity investment activity, but the categorization of private equity into “venture capital”, “buyout”, and other classes are not always consistent. Rather than attempt to standardize these definitions, the GPER uses its consistent industry definitions to divide private equity into “high technology” and “low technology”, with the former group likely to contain mostly venture capital, and the latter group mostly buyout. Exhibit 6-1 shows the historical pattern of global high-technology private equity investment.

The exhibit shows that worldwide investment displays the same boom and postboom pattern as found in the United States. (This should not be too surprising, as the United States represented most of worldwide investment during the boom,

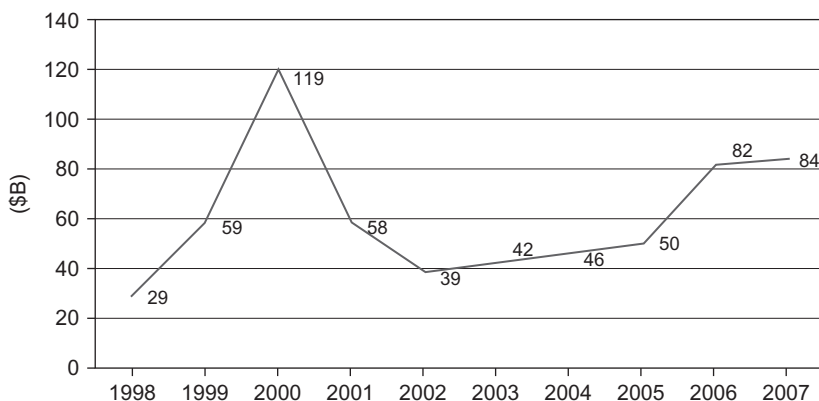
EXHIBIT 6-1**GLOBAL HIGH-TECH PRIVATE-EQUITY INVESTMENT (IN \$BILLIONS)**

SOURCE: PriceWaterhouseCoopers Global Private Equity Report 2008.

and about half during the postboom.) Investment grew in the 1990s and peaked in 2000. It has started to grow again—this time the bulk of the growth coming from outside the U.S., with \$84B of investment in 2008. Exhibit 6-2 shows the national distribution of high-technology private equity in that year.

With \$35.49B, the United States had about 40 percent of the global total of \$84B and about 60 percent more than all Western Europe combined.¹ Furthermore, the United Kingdom, with less than one-quarter of European GDP, has almost half the high-tech private equity investment. Still, the gap between the United States and Europe is at an all-time low, with the difference larger in prior years. The Asia-Pacific region (which includes Australia and New Zealand) has grown the fastest in recent years, and its total investment amount is now for the first time almost equal to that in Western Europe. A note of caution is warranted in interpreting these numbers, however: On the one hand, the numbers are likely inflated by high-tech buyout transactions in developed countries such as Australia and Japan. On the other hand, they likely miss low-tech VC activities, notably in China.²

On a GDP-adjusted basis, Israel, Sweden, and United Kingdom have consistently exhibited high investment intensity over the years, with Israel's exceeding

¹The entries in the table do not sum to \$84B because some continents are not included in the table.

²Reflecting this gap, in 2008 new commitments to Chinese VC funds exceeded \$8B (GEM Global Report 2009).

EXHIBIT 6-2*THE GLOBAL DISTRIBUTION OF HIGH-TECH PRIVATE EQUITY IN 2007, SELECTED COUNTRIES, IN \$BILLIONS*

North America	World Rank		Asia	
USA	35.49	(1)	India	5.17 (3)
Canada	1.18	(15)	Korea	3.18 (4)
NA Total	36.67		Singapore	2.89 (6)
			New Zealand	2.13 (9)
Western Europe	World Rank		Japan	1.93 (10)
UK	10.5	(2)	China	1.41 (11)
France	3.11	(5)	Hong Kong	1.24 (12)
Sweden	2.52	(7)	Australia	1.07 (16)
Germany	2.18	(8)	Asia-Pacific	19.02
Spain	1.20	(14)	Total (top 20 only)	
Netherlands	1.03	(17)		
Switzerland	0.71	(18)		
Denmark	0.64	(19)	Middle East & Africa	
Finland	0.59	(20)	Israel	1.20 (13)
W. Europe Total (top 20 only)	22.48			

SOURCE: PriceWaterhouseCoopers, Global Private Equity Report 2008.

even that of the United States. In Asia, Japan is far behind the United States and the United Kingdom in investment intensity when adjusted for GDP, whereas Korea shows a much higher intensity in recent years.

Why is it that VC activity in continental Europe and Asia has historically lagged behind that of the United States and the United Kingdom? And what has changed in the recent years? Industry experts have been thinking about this question for many years and have proposed many possible reasons. Next, we will discuss five of the main explanations.

Reason #1—Exits Without a doubt, the most important driver of VC investment is the existence of a lucrative market to exit these investments. Among VC practitioners, the absence of such a market is often the first explanation as to why VC activity is lower in some countries than in others. The most profitable exits are achieved through initial public offerings (IPOs). If the IPO market is not active, then VCs are forced to exit through sales to large companies. Although such sales

can sometimes be lucrative, such high-value sales only occur when companies have the outside opportunity of an IPO.

Exhibit 6-3 shows the ratio of capital raised by IPOs (in \$thousands) to GDP (in \$millions) for a select group of countries over the 1996–2000 time period.

EXHIBIT 6-3

RATIO OF CAPITAL RAISED IN IPOs (IN \$THOUSANDS) TO GDP (IN \$MILLIONS), 1996 TO 2000

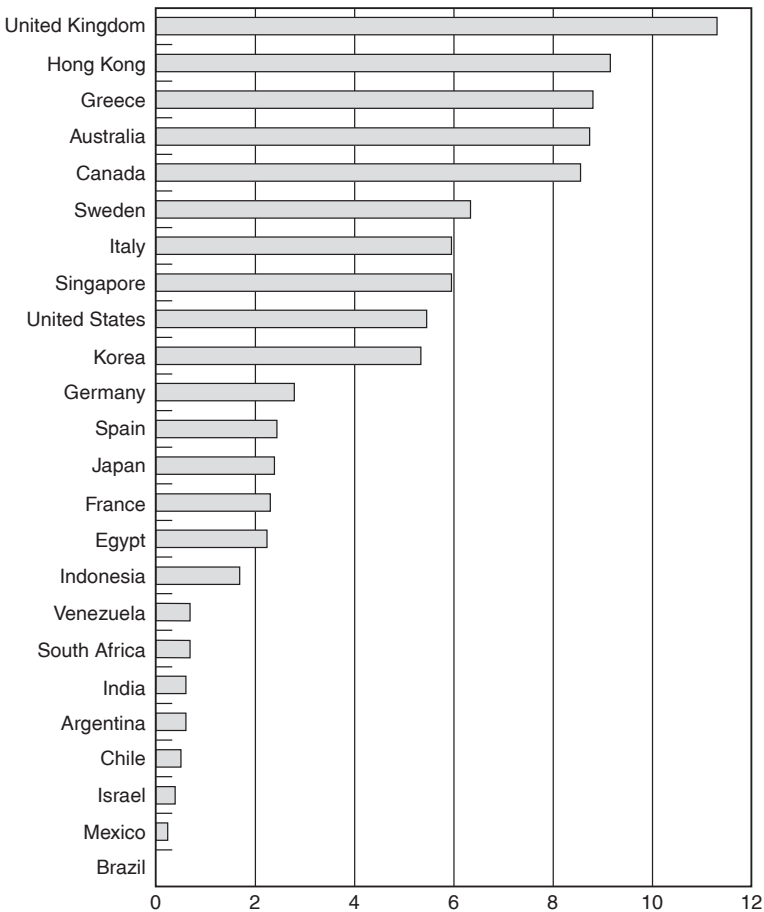

SOURCE: Djankov et al. (2008).

There are two main themes in this exhibit. First, the ratio of IPOs to GDP is relatively low in “low-income” countries. These countries, with low GDP to begin with, also have low levels of financial development relative to GDP. Note, for example, the almost nonexistent IPO levels in many Latin American countries. The second theme is that many of the countries with high VC activity also have high IPO activity. (The low IPO total for Israel is misleading, as it does not include the large number of Israeli IPOs sold in the United Kingdom and the United States.)

It is natural to wonder whether the IPO markets induce more VC activity, or vice versa. There is substantial evidence that the causation indeed runs from vibrant IPO markets to higher VC activity. In the United States, the historical record demonstrates a persistent pattern of hot IPO markets leading VCs to raise and invest more capital. The first such pattern occurred in the late 1960s, when an excellent IPO market led to successful exits for the first wave of VC limited partnerships, leading to a record number of VC funds raised in the following years. The next example came in 1979–1980, driven by regulatory changes that allowed pension funds to invest in small companies for the first time. This pattern repeated itself in the mid 1990s, leading up to the massive IPO boom of 1999–2000, which was followed quickly by record-breaking fundraising by VCs.

This, then, partly explains the rapid growth of high-tech private equity investment activities in Asia, following strong recent IPO market performances of Chinese firms (including those based in Taiwan or Hong Kong) either listing locally or directly accessing the U.S. stock markets. In fact, after Israel, Chinese companies are the second group of foreign firms who have successfully tapped the U.S. IPO markets in the recent years. India, in the meantime, has also enjoyed booming domestic equity markets, which have buoyed the high-tech private equity activities there.

Reason #2—The Entrepreneurial Ecosystem If you are an entrepreneur and you could start your company anywhere, where would you go? For the sake of answering this question, assume that you can speak all languages and live anywhere that you want. Faced with this problem, many entrepreneurs would think about the ease of setting up their business, finding capital and qualified employees, and generally avoiding all hassles so they could focus on their business. Venture capitalists refer to this set of requirements as an **entrepreneurial ecosystem**. In a well-functioning ecosystem, you do not need to train your bankers, lawyers, or accountants to structure a high-growth business; you do not need to look far to find qualified scientists, engineers, and experienced managers; you do not need to spend hours dealing with (or bribing) government officials. Also, it’s nice if your friends and neighbors don’t think that you’re crazy just because you’re starting your own business.

Taken together, these requirements seem almost tautological: It is good to start a business where many other people have started a business. (In other words, “we do it this way because it has always been done this way”.) We discussed a similar phenomenon in previous chapters, when we learned of VC clusters within the United States in Silicon Valley and around Boston.

Although it is difficult to identify cause and effect for most aspects of the entrepreneurial ecosystem, there are some illuminating data points. One interesting

project (Djankov et al., 2002) analyzed the direct and indirect costs of starting a company in 85 different countries. For each country, the authors counted the number of regulatory procedures necessary to start a company. These procedures include activities necessary in most countries such as checking the uniqueness of the company's name, filing a certificate of incorporation, and opening a bank account. There are also less common procedures such as proving that the company's officers do not have a criminal record, designating a bondsman, and publishing a notice with the business's location. After counting the procedures in each country, the authors estimated the number of business days needed to complete all procedures. Exhibit 6-4 shows their results for a selected group of countries.

As in the IPO/GDP ratio shown in Exhibit 6-3, we see that Canada, Australia, the United States, and the United Kingdom all perform well by this measure. In each of those countries, the authors estimate that it takes between two and four business days to comply with regulations to open a business. In contrast, the corresponding estimates are 26 days in Japan, 42 days in Germany, 53 days in France, and 62 days in Italy. Many emerging economies raise even higher hurdles, with estimates of 92 days in China, 104 days in Venezuela, and 149 days in Mozambique.

Although this evidence does not prove a relationship between entry costs and entrepreneurial activity, it is hard to imagine that high costs of entry are conducive to start-up activity. If it takes 10 times as long to start a company in continental Europe than it does in its EU neighbor of the United Kingdom, one can imagine where entrepreneurs would prefer to locate. With even small differences at one point in the chain, local network effects can amplify the location incentives, so that the entrepreneurial ecosystem moves to one place and stays there.

Reason #3—Law and Corporate Governance Emerging economies in Asia, Latin America, and Africa have relatively cheap labor supplies and often underserved local markets. Such conditions would seem ripe for high-growth business opportunities. We have already spoken about the high costs of entry and the difficulty of exiting such investments, but these barriers may have been overcome were it not for concerns about law, corporate governance, and the enforcement of contracts. Although these issues are of secondary importance in developed countries, they loom large everywhere else.

The relationship between legal systems and financial development has been a subject of great academic interest and progress in the last 10 years. Some recent work on this topic by Simon Djankov, Rafael LaPorta, Florencio Lopez-de-Silanes, and Andrei Shleifer (DLLS, for short) provides striking evidence about the relationship between law and finance. In their paper, the authors worked with lawyers to quantify the legal protections against **self-dealing** behavior in 102 different countries. Self-dealing, also called **tunneling** or **investor expropriation**, is a major concern of VCs in all countries. As defined by DLLS, self-dealing occurs when “those who control a corporation, whether they are managers, controlling shareholders, or both, can use their power to divert corporate wealth to themselves, without sharing it with other investors” (Djankov et al., 2008, p. 1).

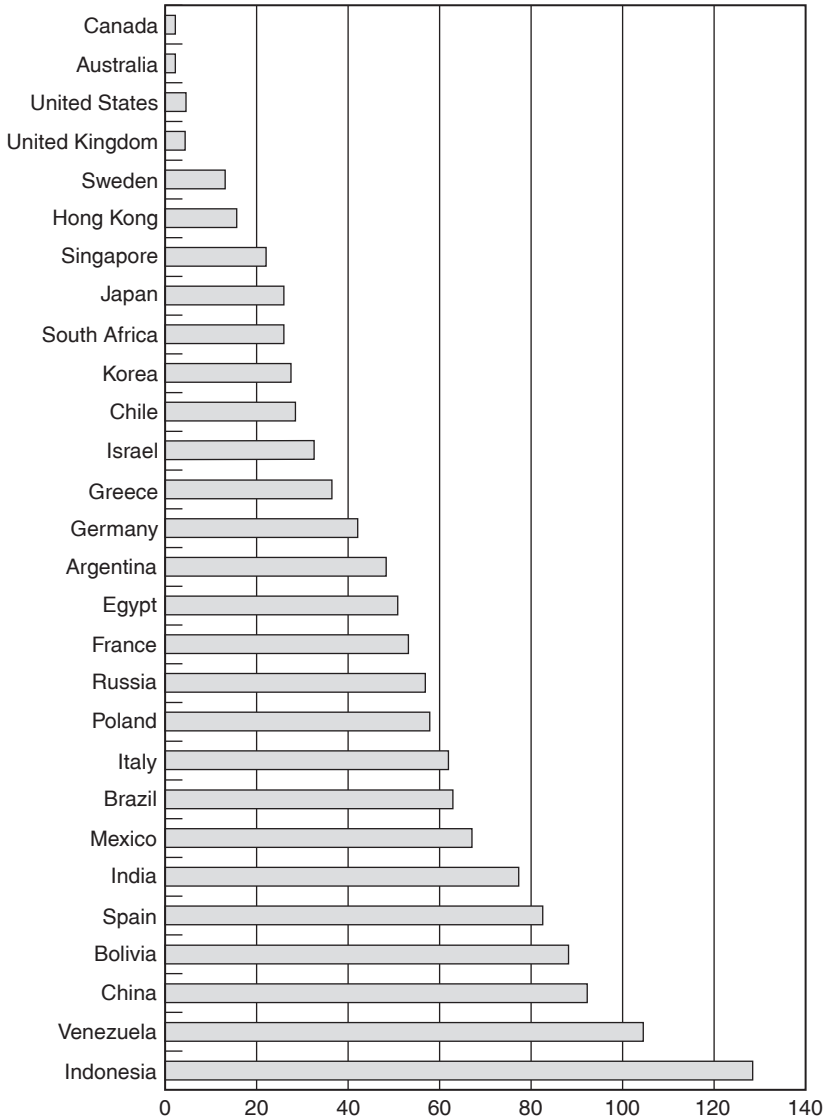
EXHIBIT 6-4*TIME TO START A BUSINESS, IN DAYS*

SOURCE: Djankov et al. (2002).

The authors considered the following prototypical self-dealing transaction: Mr. James owns 90 percent of Company A (“Seller”) and 60 percent of Company B (“Buyer”). Buyer proposes to purchase some assets from Seller. Because Mr. James controls (>50 percent ownership) both companies, he can make this transaction happen. Because Mr. James owns more of the Seller than he does of the Buyer, he has an incentive for the Buyer to overpay for the Seller’s assets. What protections do the *minority investors* in the Buyer have against this transaction?

The authors considered several different classes of protections. First, what details of the transaction must be disclosed to minority investors? Second, what rights do minority (disinterested) investors have to approve the transaction? Third, what rights do minority investors have to sue Mr. James after the transaction goes through? For each class of protections, the authors gathered data for a variety of different legal rights. They combined all these rights into an index of self-dealing. The index goes from 0 (no protections for minority investors) to 1 (maximum protection). Exhibit 6-5 gives this index for a selection of the 102 countries analyzed in the paper.

It should come as no surprise that law-and-order Singapore tops the list, with a maximum score of 1.00. Once again, we see above-average scores by the English-speaking quartet of Canada, Australia, the United States, and the United Kingdom. With a score of 0.85, France also lies above this average, but many of its continental European neighbors do not: Germany at 0.28, Spain at 0.37, and Italy at 0.39. Among developing nations in the bottom GDP quartile, the average score is 0.43, with Latin American countries often having the lowest scores.

The table also has some surprises: for example, China’s score of 0.78 and Indonesia’s score of 0.68 would seem contrary to venture capitalists’ governance concerns in these two large countries. It is important to remember, however, that this self-dealing index *does not attempt to measure whether the self-dealing laws are actually enforced*. Rather, the index purports to measure whether the self-dealing laws exist at all. Thus, we can think of the index as measuring Mr. James’s ability to “steal without breaking the law”.

The main conclusion of the DLLS research is that the index of self-dealing is correlated with many measures of financial development. For example, the authors find that the ratio of total stock market capitalization to GDP is strongly related to all the major components of the self-dealing index. Also, comparison of the highest and lowest countries in Exhibits 6-3, 6-4, and 6-5 will uncover many similarities. Our focus on the English-speaking countries of Canada, Australia, the United States, and the United Kingdom was no accident: In addition to the English language, all four of those countries also share legal origins of English common law.³ In the DLLS research, the 21 countries with English common-law systems—including Singapore, India, Israel, Hong Kong, and South Africa from Exhibit 6-5—have an average self-dealing index of 0.67. Outside these 21 countries, all other nations in the DLLS study

³Common-law systems derive a significant amount of their rules from custom and judicial precedent. In contrast, civil-law systems rely more heavily on legislatures to write laws.

EXHIBIT 6-5

INDEX OF PROTECTIONS AGAINST SELF-DEALING (HIGHER = MORE PROTECTIONS)

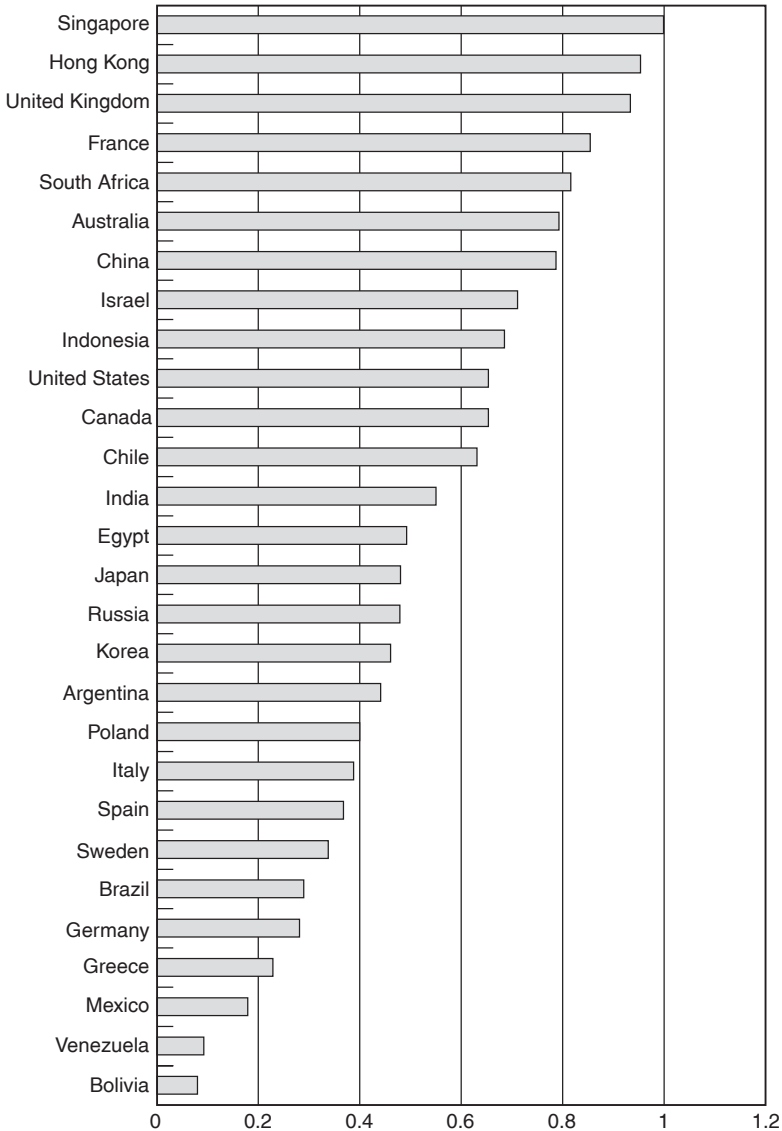

SOURCE: Djankov et al. (2008).

can trace their legal origins to the civil codes of ancient Rome. Such civil codes tend to provide less protection to minority investors, and the average self-dealing index in these civil-law countries is 0.37.

Reason #4—Country Risk In emerging markets, many investors are concerned about national-level political and economic risks: corporate assets can be directly seized, capital controls can keep foreign investors from repatriating profits or proceeds of a sale, and financial crises can lead to political and social upheaval. In any of these cases, a VC can lose virtually all his investment, even if the business was performing well. Collectively, these concerns are called **country risk**.

Economists have been trying to quantify country risk for many years. Unfortunately for investors, there is no standard way to do this. Every country—and every investment within that country—carries a unique set of risks. Companies with a high level of tangible assets have a greater risk of asset seizures than do human-capital-intensive businesses, and companies related to national interests can run into difficulties even in developed countries. The problem is so difficult that many firms have carved out a business as “country risk calculators”, performing estimates for any given project—and charging a tidy sum to do it. The only component of country risk that lends itself to an easy estimate is the risk of a government default on its foreign debt. This risk can be measured using the sovereign spread, usually defined as the difference in yield between dollar-denominated government debt and U.S. government debt of the same duration. For example, suppose that 10-year Mexican debt, with interest and principal paid in dollars, has a current yield of 8 percent. If 10-year U.S. government bonds have a yield of 5 percent, then the sovereign spread for Mexico would be $8 - 5 = 3$ percent. Exhibit 6-6 shows the sovereign spread for 12 developing countries that have dollar-denominated government debt.

The exhibit shows that most Latin American countries have sovereign spreads between 1 and 3 percent. Like all reported bond yields, these are not expected returns, but instead represent the yield-to-maturity on the assumption that all principal and interest is actually paid back. Thus, the spread represents the additional amount that must be paid to compensate investors for the risk that some of these payments will not be made. Indeed, if the beta for a bond is zero, then the expected return on the bond would be the same as the risk-free rate, with the entire sovereign spread needed to compensate for expected losses. We discuss these issues further in Section 6.2. In any case, the sovereign spread can represent only one component of country risk—the component that is correlated with government default—and cannot measure risks that exist even when the government itself pays back its debt. Overall, these different forms of country risk make many VCs wary of investment in emerging markets.

Reason #5—Cultural Differences When all else fails, we can always blame “cultural differences” for the global pattern of VC activity. Many observers have posited that differences in attitudes toward risk, the stigma of failure,

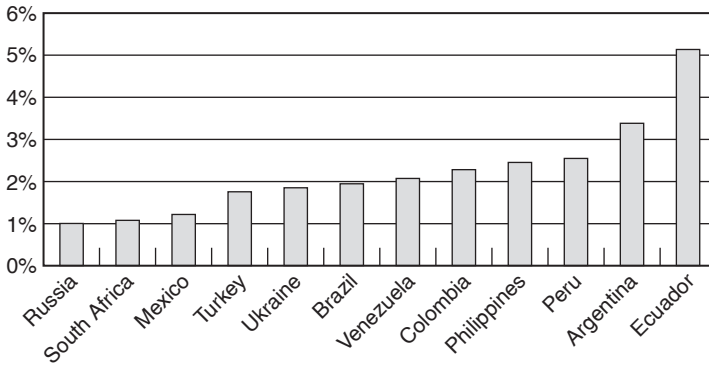
EXHIBIT 6-6**SOVEREIGN SPREAD OF DOLLAR-DENOMINATED BONDS**

SOURCE: Financial Times, April 7, 2006.

individual expression, and self-confidence may explain the patterns of entrepreneurship across countries. Because VCs cannot invest unless entrepreneurs are willing to start companies, a dearth of the latter can stifle a VC industry. For hard evidence on the relationship between entrepreneurship and cultural attitudes, we turn to the *Global Entrepreneurship Monitor*, a project managed at Babson College. This project documents the entrepreneurship landscape across many countries, using individual questionnaires as the key survey instrument. Researchers perform thousands of face-to-face and telephone interviews to measure the extent of entrepreneurial activity and estimate the determinants of individual participation.⁴ Detailed analysis by Arenius and Minniti (2005) and Koellinger et al. (2007) has demonstrated the important role of cultural factors and personal attitudes on an individual's decision to become an entrepreneur, with wide differences across countries. Exhibit 6-7 illustrates some of these differences. In this exhibit from Koellinger et al. (2007), we see the percentage of respondents in 18 countries who answered "yes" to the question: "Do you have the knowledge, skill, and experience to start a new business?"

The most striking entries in the table are the extraordinary self-confidence levels of New Zealanders and the extraordinary lack of self-confidence among

⁴For a full description of the results and methodology, see *The 2009 Global Entrepreneurship Monitor 2009 Global Report*, online at http://www3.babson.edu/ESHIP/research-publications/upload/GEM_2009_Global_Report.pdf.

EXHIBIT 6-7

ENTREPRENEURIAL SELF-CONFIDENCE IN 18 COUNTRIES

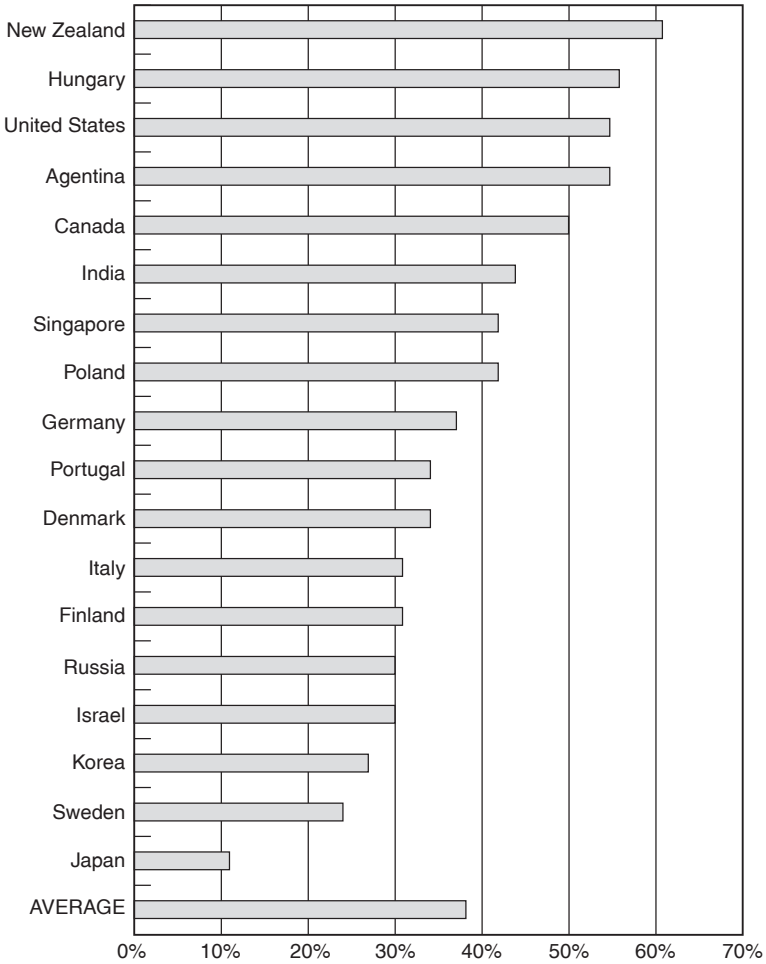

SOURCE: Koellinger et al. (2007).

the Japanese. In general, we see that many English-speaking countries are above average (38 percent), and most continental European countries are below average. The authors find a strong correlation between self-confidence and entrepreneurship across these 18 countries. Anecdotally, we can see this relationship by comparing

the fraction of entrepreneurs in New Zealand—the second-highest in the sample at 22.5 percent—and Japan—the third-lowest in the sample at 8.3 percent. Note that these differences in entrepreneurship, although large, are considerably smaller than the differences in self-confidence that are reported in Exhibit 6-7. Thus, it is not just the entrepreneurs who are answering “yes” to the survey question.

Of course, it is possible that residents of all countries have the same underlying levels of self-confidence and differ only in the cultural acceptability of *admitting* such self-confidence to an interviewer. Even in this case, however, such cultural differences could affect the willingness of individuals to become entrepreneurs. After all, starting a company is a fairly public way to state one’s self-confidence.

The Global Entrepreneurship Monitor has followed up by including a wide variety of cultural and attitudinal questions in their annual entrepreneurship surveys. We cannot do justice to the richness of the results they report, given the limited space here, but one interesting indicator that varies quite considerably across “innovation-driven” (= developed) countries, according to their report, is whether the respondents feel that successful entrepreneurs receive a high status in their society. The percentage of respondents who answer “yes” is 73 percent and 75 percent in the United Kingdom and the United States, respectively, while it is only 49 percent and 50 percent in Belgium and Japan, respectively. Not coincidentally, these latter countries also scored quite low on the question, “Do you perceive entrepreneurship as a good career choice?” Forty-six percent in Belgium and 28 percent in Japan said “yes”.⁵

6.2 THE COST OF CAPITAL FOR INTERNATIONAL VC

In Chapter 4, we estimated the cost of capital for VC in the United States as 15 percent per year. Should this estimate be different for VC investments in other countries? To gain insight into this question, we need to step into the thorny issues involved in estimating the cost of capital for international investments. This is a broad and important topic, and we will not be able to do it full justice here. Instead, we take a three-step whirlwind tour of the key concepts. In Section 6.2.1 we introduce a baseline model for the international cost of capital. This model is similar to the CAPM, but is extended to consider global investments. The key assumption of this model is that international capital markets are fully **integrated**, so that there is a single worldwide price of risk. In Section 6.2.2 we discuss several objections and extensions to this baseline model to account for currency risk, country risk, style factors, and the possibility of **segmented markets**. In Section 6.2.3 we suggest a method to estimate the cost of international VC.

⁵GEM (2009).

6.2.1 Baseline Model: The Global CAPM

In Chapter 4, we introduced the CAPM as our first model of risk and return:

$$r_i = R_i = R_f + \beta(R_m - R_f) \quad (6.1)$$

where r_i is the cost of capital for asset i , R_i is the expected return for asset i , R_f represents the risk-free rate for borrowing and lending, R_m is the return on the whole market portfolio, and β (beta) is the level of risk for asset i . In implementations of this model in the United States, the market premium is typically estimated on a market portfolio of U.S. stocks. This implementation should properly be called a **domestic CAPM**. As first discussed in Chapter 4, the proper theoretical interpretation of the CAPM requires that this market portfolio must comprise all assets, traded and untraded, from everywhere in the world. Although such universal coverage is not possible, it is relatively easy to construct the market portfolio as a value-weighted portfolio of all traded equities in all world markets. With a market premium, $(R_m - R_f)$, defined as the expected premium on all global stocks, then we can define Equation (6.1) as the **global CAPM**.

In the global CAPM, the betas are driven by correlations between asset i and the global market portfolio. If the financial markets of the world are perfectly integrated, so that all investors are diversifying among all assets in all countries, then the global CAPM is a more appropriate model than any domestic CAPM. Historically, most U.S.-based investors relied on a domestic CAPM because of limitations on data for global returns. These days, with global returns easily available, U.S. investors rely on the domestic CAPM either because of inertia or because of a belief that markets are not perfectly integrated. We discuss the integration issue further in Section 6.2.2.

For now, we maintain the assumption of perfectly integrated markets, and we analyze the expected return of investments made outside the United States. To estimate the model, we need a time series of returns for the global market premium, for risk-free rates, and for asset i . The historical premium on global stocks is between 6 and 7 percent. For consistency with our earlier analysis in the United States, we will use an expected global premium of 7 percent. For now, we will measure risk-free rates with U.S. government bonds, leaving a discussion of currency risk for Section 6.2.2. Last, we need a time-series of returns for VC. Now, we have a major problem because we have no international equivalents for either the Cambridge Associates or the Sand Hill Econometrics data in the United States. Furthermore, even if such time series did exist, the small size of the VC markets in most countries would render these returns to be highly unreliable as predictors of future performance.

Luckily for us, this problem is quite common in other settings, and analysts have devised a procedure for making estimates when data is sparse. For example, consider the investment decision of Telco, a multinational telecommunications company based in the United States and considering a \$100M investment in a telecom services project in Brazil. To estimate the cost of capital for this

investment, Telco would like to know the average global beta for a telecom company in Brazil. Although data on global returns is readily available from many sources, data on individual companies in emerging markets is somewhat harder to obtain. Furthermore, there may not be very many publicly traded telecom companies in Brazil. In an extreme case, there might be no publicly traded companies in a country that belong to the same industry.

For this example, Telco can use a three-step procedure to estimate the beta of their investment. The key assumption behind this procedure is that the **domestic beta** of a telecom industry is identical across all countries: that is, the beta of a telecom company in Brazil relative to the Brazilian stock market is the same as the beta of a telecom investment in the United States relative to the U.S. market. In the first step of the procedure, Telco estimates the domestic beta for a similar telecom investment in the United States; we refer to this estimate as β_d . We can obtain this estimate by regressing the historical returns for the telecom industry in the United States on the market premium in the United States. Next, Telco estimates the **country beta** for the whole Brazilian equity market; we refer to this estimate as β_c . We make this estimate by regressing the historical returns for the Brazilian stock market on the returns on global market premium. Finally, using the assumption that domestic betas for telecom are the same across all countries, we have

$$\begin{aligned}
 \beta_d &= \text{beta of U.S. telecom investment relative to the U.S. stock market} \\
 &= \text{beta of the Brazilian telecom investment relative to the Brazilian} \\
 &\quad \text{market; and} \\
 \beta_c &= \text{beta of the Brazilian market relative to the global market} \\
 \rightarrow \beta_d * \beta_c &= \text{beta of the Brazilian telecom investment relative to the} \\
 &\quad \text{global market}
 \end{aligned}
 \tag{6.2}$$

The Excel file *betas.xls* simplifies this procedure by providing a wide range of domestic betas (for industries in the United States) and country betas.⁶ In the *industry* worksheet of the *betas* spreadsheet, we can see that the beta for the telecom industry in the United States is 1.43. In the *countries* worksheet, we can see that the country beta for Brazil is 1.46. Thus, the estimated beta for Telco's investment in Brazil is $1.43 * 1.46 = 2.08$.

EXAMPLE 6.1

Bankco, a multinational financial services company based in the United States, is considering a consumer-banking investment in Thailand.

⁶The industry beta data are from Professor Damodaran's website; the country beta data are from Reyent (2009), at <http://seekingalpha.com/article/110434-calculating-country-risk-observed-by-betas>.

Problems

- (a) Use the *betas.xls* file to estimate the beta for this investment.
- (b) With a risk-free rate of 4 percent and a global risk premium of 7 percent, what is the estimated cost of capital for this investment?

Solution

(a) In the industry worksheet of *betas*, we can look up the beta for the banking industry in the United States as 0.71. In the *countries* worksheet, we can look up the country beta for Thailand as 0.50. Thus, the estimated beta for Bankco's investment in Thailand is $0.71 * 0.50 = 0.36$.

(b) By substituting a global beta of 0.36, a risk-free rate of 4 percent, and a global risk premium of 7 percent into the global CAPM of Equation (6.1), we obtain a cost of capital of

$$R_i = 0.04 + 0.36 * (0.07) = 6.5\% \quad (6.3)$$

■

6.2.2 Objective and Extensions to the Global CAPM

Most objections to the global CAPM are rooted in the belief that the estimated discount rates are “too low”. Example 6-1 provides a typical illustration: the estimated cost of capital is 6.5 percent, lower than the cost of capital would be for an equivalent investment in the United States. This lower estimate occurs because the country beta for Thailand is less than 1. Many analysts are bothered by this, because Thailand “seems” to be much riskier than the United States. Indeed, the volatility of the Thai market is almost twice the volatility of the U.S. market. However, it is important to remember that beta is driven by covariance, not variance. The correlation of the Thai market with the world market is relatively low: From the perspective of a globally diversified investor, most of the variance in Thailand is idiosyncratic.

Thailand is not unique. Many developing countries have country betas less than 1. Exhibit 6-8 shows the volatilities (expressed as a ratio to U.S. market volatility) and country betas (relative to the global market premium) for select economies. The exhibit shows that many of these markets have country betas below 1, with both Thailand and India close to 0.5. Do we really think that these countries should have a lower cost of capital than the United States? For many analysts, this result is simply too counterintuitive to accept, and several extensions have been proposed to this baseline model. Next, we will discuss four of these extensions.

Extension #1—Style Adjustments In Chapter 4 we learned that many economists no longer consider the CAPM to be the best model of expected returns, with multifactor models such as the Fama-French model (which extends the CAPM to include size and value/growth factors) and the Pastor-Stambaugh model (which extends the Fama-French model to include a liquidity factor) doing a better job of

EXHIBIT 6-8*COUNTRY BETAS AND VOLATILITY RATIOS, SELECTED COUNTRIES*

Country	Country Beta	Volatility Ratio
Brazil	1.46	2.35
Finland	1.29	2.26
Mexico	1.23	1.75
Sweden	1.21	1.17
South Africa	0.91	1.67
Poland	0.84	1.82
Israel	0.78	1.54
China	0.68	1.91
India	0.57	1.80
Thailand	0.50	1.86
Japan	0.46	1.43
Egypt	0.16	1.78

NOTE: Calculated based on daily index stock returns from 1998 to 2008.

SOURCE: <http://seekingalpha.com/article/110434-calculating-country-risk-observed-by-betas>.

explaining the pattern of realized returns in the United States. The international evidence for these models is also compelling, and thus it is probably wise to extend the global CAPM to include these additional factors. In Section 6.2.3, we provide a suggested method for doing this for the estimation of the cost of capital for international VC. Nevertheless, the low correlation of the Thai market with the global premium will still be the main driver of low expected returns for all Thai investments. Thus, multifactor models, although sensible, do not solve the main concern that some of these cost-of-capital estimates are “too low”.

Extension #2—Currency Risk The global CAPM ignores differences in currency across countries. If a U.S.-based investor makes an investment in Thailand, then revenues from domestic sales will come in Thai currency. If the U.S. company needs to pay its own investors back in dollars, then they can either hedge the foreign exchange risk or absorb it—in either case, the potential costs may be large.

To handle currency risk in the context of a factor model, we must ask ourselves whether such risks are diversifiable. If so, then there is no reason that such risks should affect expected returns. There is a long history of academic literature on this question, well beyond the scope of this chapter.⁷ The incredibly concise

⁷For a longer discussion of this literature, see Solnik and McLeavey (2004), Chapter 4, or Bodnar, Dumas, and Marston (2004).

summary of this literature is that, in the long run, currency risks probably have an expected return of 0, because gains for one currency are exactly offset by losses for another. In the context of our banana economy of Chapter 4, it should not matter if some people quote banana prices in euros while others do so in dollars, because these currency differences have no effect on the overall production of bananas and thus have no effect on the average level of hunger in the economy. In the short run, however, it is possible that this long-run relationship breaks down. In our banana economy, this can occur if, for example, the dollar-currency islanders are more risk-averse than the euro-currency islanders. In this scenario, the two groups may bear different amounts of risk in equilibrium, so short-run shocks to the weather affect the hunger (and currencies) of the two groups disproportionately.

In practice, analysts adjust for short-run differences in currency risk by adding currency factors to the right-hand side of Equation (6.1). These currency factors are typically constructed as a historical premium for holding any given currency, perhaps adjusted for short-run differences in expectations. Solnik and McLeavey (2004) give an example of such a model. For the applications in this book, we take the long-run view that the average risk premium is 0, so there is no adjustment to the cost of capital.

Extension #3—Country Risk In Section 6.2 we discussed “country risk” as one reason that investors avoid VC in emerging markets. To quantify this country risk, Exhibit 6-6 displayed the sovereign spread for several developing countries. It is common practice on Wall Street for analysts to add this sovereign spread as an additional term on the right-hand side of Equation (6.1). In that case, an augmented version of the global CAPM is the risk-free rate (from U.S. bonds), plus beta times the global market premium, plus the sovereign spread. The idea behind this augmentation is that the sovereign spread, which represents the risk of government default on its foreign debt, might also be the best available proxy for the country risk in private investments.

Unfortunately, there are serious problems with this augmented model. The first problem is straightforward: there is no reason to equate the risk of government default with the risk of private project failure. The second problem is deeper and concerns the difference between a government bond yield and an expected return. As we first discussed in Section 6.1, the sovereign spread represents the additional yield under the assumption that all interest and principal payments are actually made. This yield is not an expected return, because it assumes no default. It is entirely possible that *expected return* on Thai bonds is the same as the *expected return* on U.S. bonds. In an equilibrium model like the CAPM, expected returns are equated with discount rates and the cost of capital. By adding the sovereign spread to the global CAPM, we can no longer claim to be estimating expected returns, discount rates, or the cost of capital.

To illustrate this second problem, assume that we knew that the probability of a government default was exactly 10 percent per year, and all private companies

would go bankrupt in the case of a government default. Furthermore, assume that this default is independent of the global equity market. Now, in this case, the sovereign spread would reflect the yield in the 90 percent of the cases without default. The spread would be positive to compensate investors for the negative 100 percent return in the case of default. Nevertheless, the expected return on government debt would be equal to the risk-free rate because, by assumption, default is uncorrelated with the global market premium.

In this example, the correct way to handle the 10 percent default probability is not in the discount rate, but in the expected cash flows. Indeed, this kind of problem occurs for every VC investment, foreign or domestic. In Chapter 7, we will show that a substantial fraction of all VC investments provide no returns to the investors. In Chapter 10, we will show that this “probability of success” does not affect the expected return, but rather should be used as a separate input into the valuation decision.

Extension #4—Segmented Markets So far, we have described three possible extensions to the global CAPM, but we have argued that none of these three extensions are likely to explain why estimates seem “too low”. Extension #4 drops the assumption of perfect integration of international financial market. Without this assumption, we can sometimes estimate a much higher cost of capital.

To see how this works, consider the opposite extreme to perfectly integrated markets: perfectly segmented markets. Under this extreme assumption, investors are only permitted to invest in their own countries. Then, there would be no such thing as the global CAPM. Instead, we would have a different domestic CAPM for every country. For each country, we would estimate a version of Equation (6.1) using the market premium from that country. Of course, in this world of perfect segmentation, it would not make any sense to consider an investment by a U.S. investor in Thailand—we have assumed that this is impossible. Thus, analysts sometimes consider a hybrid CAPM, shown in Equation (6.4), which allows for separate betas and market premia for the global and domestic markets.

$$r_i = R_i = R_f + \beta_1(R_g - R_f) + \beta_2(R_d - R_f) \quad (6.4)$$

where r_i , R_i , and R_f are defined as in Equation (6.1), R_g is the return on the global market portfolio, R_d is the return on the domestic market portfolio corresponding to the country of investment i , and β_1 and β_2 are the betas on the global premium and domestic premium, respectively. Equation (6.4) can generate a high cost of capital because some countries have very high historical premia. Nevertheless, the hybrid CAPM rests on shaky theoretical foundations. It is very difficult to write down a rigorous model of “partially segmented” markets that would give rise to Equation (6.4). Furthermore, most limited partners in VC funds are large institutions with the capability of investing anywhere in the world. Thus, although a hybrid CAPM might satisfy a craving to obtain a higher estimate for the cost of capital, this satisfaction would come with some sacrifice to logical consistency.

6.2.3 A Global Multifactor Model for Venture Capital

So, with all these possible extensions, how should an honest analyst estimate the cost of capital for international VC? In this book, we suggest an approach that is internally consistent with the domestic estimate done in Chapter 4. The starting point is the Pastor-Stambaugh model (PSM) cost-of-capital estimate for the United States. In Chapter 4, we introduced the PSM model as

$$R_{it} - R_{ft} = \alpha + \beta * (R_{mt} - R_{ft}) + \beta^{\text{size}} * \text{SIZE}_t + \beta^{\text{value}} * \text{VALUE}_t + \beta^{\text{liq}} * \text{LIQ}_t + e_{it} \quad (6.5)$$

where α , β , R_{mt} , R_{ft} , and e_{it} are defined similarly as in Equation (6.1), SIZE_t , VALUE_t , and LIQ_t are the factor premia for their respective investing styles, and β^{size} , β^{value} , and β^{liq} are the regression coefficients on these factors. In Chapter 4, we discussed the historical evidence for each of these factor premia and suggested estimates of 7 percent (for the market), 2.5 percent (for size), 3.5 percent (for value), and 5 percent (for liquidity). We then estimated Equation (6.5) for the Sand Hill Econometrics index and Cambridge Associates index (each with lags) and obtained estimated coefficients, as shown in Exhibit 4-6. By substituting these coefficients and premia into Equation (6.5), we obtain a cost-of-capital equation of 15 percent.

Now, to estimate the cost of capital for VC in a country other than the United States, we multiply all the PSM betas— β , β^{size} , β^{value} , and β^{liq} from Equation (6.5)—by the country beta, β_c , from the *betas.xls* file. Using the rounded estimate of 15 percent and subtracting the historic average risk-free rate of 4 percent, we obtain 11 percent for the sum of all factor loadings times the historic average factor returns ($\beta * 0.07 + \beta^{\text{size}} * 0.025 + \beta^{\text{value}} * 0.035 + \beta^{\text{liq}} * 0.05$). Thus, for an investment in Thailand, we would multiply all factor loadings by 0.50 (see *betas.xls*), so we have:

$$r_i(\text{Thailand}) = 0.04 + 0.50 * (0.15 - 0.04) = 9.5\% \quad (6.7)$$

Some readers might see this estimate, 5.5 percent lower than the corresponding estimate in the United States, and express disbelief. Remember, however, that we must not confuse a higher probability of failure with a higher cost of capital. If you believe that investments in Thailand have a higher probability of outright failure than do similar investments in the United States, then you can take account of this higher probability in a different part of your valuation calculation. In Chapter 10, we show exactly how such probabilities can be incorporated into an investment decision, *separate* from the cost of capital.

EXAMPLE 6.2

EBV is considering an investment in South Africa.

Problem What is the cost of VC for this investment?

Solution We can see in the *betas.xls* spreadsheet (and in Exhibit 6-8), that the country beta for South Africa is 0.91. Thus, the cost of VC for a South African investment can be estimated by

$$r_i(\text{SouthAfrica}) = 0.04 + 0.91 * (0.15 - 0.04) = 14.01\% \quad (6.8)$$

SUMMARY

VC is a worldwide industry, but some countries have been more successful than others in developing a thriving culture of entrepreneurship and VC investment. The United States continues to lead the world with about half of all high-tech private equity investment—and a ratio of investment to GDP nearly double that of Western Europe. Within Western Europe, nearly half of all investment is concentrated in the United Kingdom. We discussed five factors that help drive VC activity in a country. First, the IPO markets should be active to provide the possibility of high-value exits. Second, there should be an entrepreneurial ecosystem that eases the tasks of setting up new companies and recruiting necessary talent. Third, the legal system should protect minority investors from self-dealing by owners and managers. Fourth, the level of political risk should not be so high as to scare VCs away. Fifth, the culture should be supportive of entrepreneurs starting (and sometimes failing) in their ventures.

In Chapter 4, we estimated the cost of capital for VC in the United States to be 15 percent. This estimation is different in every country. In theory, the main driver of these differences is the country beta, which measures the extent to which a country's asset markets are correlated with the global market. Multifactor models like the Pastor-Stambaugh model can be combined with country betas to provide an estimate of the cost of capital for VC for any country.

KEY TERMS

Entrepreneurial ecosystem	Country risk	Country beta
Self-dealing	Global CAPM, global beta	Integrated markets,
= tunneling	Domestic CAPM, domestic	segmented markets
= investor expropriation	beta	

REFERENCES

- Arenius, Pia, and Maria Minniti, 2005, "Perceptual Variables and Nascent Entrepreneurship", *Small Business Economics* 24(3), 233–247.
- Bodnar, Gordon, Bernard Dumas, and Richard Marston, 2004, "Cross-Border Valuation: The International Cost of Equity Capital", in *The INSEAD-Wharton Alliance on Globalizing: Strategies for*

- Building Successful Global Businesses*, R. Gunther, H. Gatignon, and J. Kimberly, eds., Cambridge University Press, New York.
- Djankov, Simon, Rafael LaPorta, Florencio Lopez-de-Silanes, and Andrei Shleifer, 2002, “The Regulation of Entry”, *Quarterly Journal of Economics* 117(1), 1–37.
- Djankov, Simon, Rafael LaPorta, Florencio Lopez-de-Silanes, and Andrei Shleifer, 2008, “The Law and Economics of Self-Dealing”, *Journal of Financial Economics* 88(3), 430–465.
- Global Entrepreneurship Monitor 2009 Global Report, http://www3.babson.edu/ESHIP/research-publications/upload/GEM_2009_Global_Report.pdf.
- Koellinger, Phillip, Maria Minniti, and Christian Schade, 2007, “I Think I Can, I Think I Can: Overconfidence and Entrepreneurial Behavior”, *Journal of Economic Psychology* 28(4), 502–527.
- PricewaterhouseCoopers, *Global Private Equity Report 2008*, http://www.pwc.com/en_GX/investment-management-real-estate/pdf/2008_global_private_equity_report.pdf.
- Reyent, Suna, 2009, “Calculating Country Risk Observed by Betas”, <http://seekingalpha.com/article/110434-calculating-country-risk-observed-by-betas>.
- Solnik, Bruno and Dennis W. McLeavy, 2004, *International Investments*, 5th Edition, Addison-Wesley, Reading, MA.

EXERCISES

- 6.1** *True, False, or Uncertain:* Private equity is a substitute for public equity (i.e., if a country has a relatively active public-equity market, then private-equity activity will be relatively low).
- 6.2** *True, False, or Uncertain:* Countries with common-law based legal systems have relatively weak protections against investor expropriation.
- 6.3** Softco, a multinational software company based in the United States, is considering an investment to produce and sell business software in Mexico. Use the *betas.xls* file to estimate the beta for this investment.
- 6.4** Talltree is considering an investment in India. What is the cost of VC for this investment?

PART **//**

TOTAL VALUATION

This page intentionally left blank

THE ANALYSIS OF VC INVESTMENTS

I**N THIS CHAPTER** we introduce the main topic for Parts II and III of this book: the analysis of VC investments. In the past decade, the data on VC investments has become much more complete. In Section 7.1 we study this data and provide key statistics about the distribution of returns to individual VC investments. In Section 7.2 we turn our attention from data to methodology, and we sketch the key steps in the investment decision-making process.

7.1 VC INVESTMENTS: THE HISTORICAL EVIDENCE

For a long time the VC industry existed in a data vacuum. VCs invested billions of dollars in startup companies with little more than intuition and rules of thumb to guide them. Ten years ago there was no way to reliably answer basic questions like, “What fraction of all VC investments goes out of business?” and, “What fraction of VC investments eventually has IPOs?” To make decisions without this information is like playing poker without knowing how many aces and kings are in the deck. Yes, you can do it, but it makes the luck factor loom even larger.

The good news is that this data vacuum has been steadily filling over the past 10 years. The first entrant on the scene was VentureExpert, a product of Venture Economics (a unit of Thomson Financial), soon to be followed by VentureSource, a product of Dow Jones. Venture Economics, the producers of much of the data used in Chapters 1 and 2, began its data collection in the 1970s but did not track much data on valuations until recent years. VentureSource (formerly VentureOne) has always been much more comprehensive with valuation data, but its industry coverage was not very broad until the early 1990s. The next leap forward came from Sand Hill Econometrics (SHE), whom we first met in Chapter 3 through its VC return index. SHE initially combined data from Venture Economics and VentureSource, added some information from some newer providers, and performed some detailed investigations of its own. The SHE

database is state of the art and serves as the basis for the statistics presented in this chapter.¹

To build a VC database requires three main steps. First, one must learn about investments as they occur. Second, one must track these investments over time. Third, one must get accurate information about exits. At each of these steps, it is not enough to know that an event occurred; one must also get valuation data. Without valuation data, it is impossible to compute the returns to the VC investors. At each step, there are challenges. For example, if you miss some companies at their initial investment, but then pick them up later if they make it to a second or third round, then you run the danger of introducing survivor bias into the data. (We first saw survivor bias in Chapter 3, when discussing the Cambridge Associates return index.) Furthermore, even if you gather all information about the rounds of investment, it is still a big challenge to find out when companies have gone out of business. Neither VCs nor their companies are eager to publicize their failures, and SHE expends considerable effort to track these down. Finally, the valuation data for exits is not always available. IPO exits are always available, and large-value acquisitions are virtually always disclosed. Nevertheless, in a significant fraction of small acquisitions, the purchase price is never disclosed.

For any investment, there are four possible outcomes at any point: (1) exited through an IPO (IPO), (2) exited through an acquisition (ACQ), (3) out of business before any exit (DEF, for “defunct”), and (4) still a private company in a VC’s portfolio (PRI). Exhibit 7-1 shows the likelihood for these outcomes as a function of time since the first round of VC investment, using data from all VC-backed companies in the SHE database that received their first financing before 2001.

The exhibit shows that by five years after the initial investment, 12.7 percent of all companies have had an IPO, 24.1 percent have been acquired, 26.1 percent are defunct (out of business), and 37.1 percent are still private. By 10 years after the initial investment, the respective percentages are 15.4 percent for IPO, 35.5 percent for an acquisition, 33.4 percent for defunct, and 15.7 percent for still private.

The largest remaining unresolved issue is the identification of out-of-business dates. Even with SHE’s efforts, 16 percent of all companies are listed as “still private” 10 years after their initial investment, and only about one-third are listed as defunct. Because VC funds ordinarily must exit all their investments within 10 years, the still-private percentage seems too high. It is likely that the vast majority of these companies has either gone out of business or been “acquired” for some nominal price.² SHE has chosen a reasonable and conservative path of listing these companies as “still private” when no other information is available. An alternative assumption would be that these companies have gone out of business,

¹Sand Hill Econometrics entered into a licensing agreement with Dow Jones (the provider of VentureSource) in 2009. As a result, it stopped using Venture Economics as a raw data source. The results presented in this chapter are based on the new version of their database, which excludes data from Venture Economics.

²VentureSource has two separate categories for asset acquisitions (where a company is liquidated and sells some of its assets, such as computers, ergonomic chairs, foosball tables, etc.) and other acquisitions. When a deal is classified as an asset acquisition by VentureSource, Sand Hill classifies it as “defunct”. That said, it is possible that some asset acquisitions are classified as “acquired” with an undisclosed price.

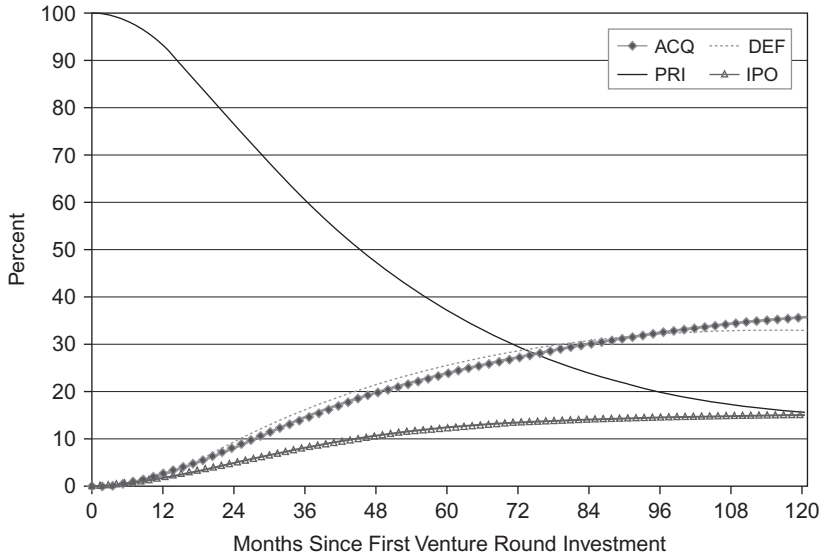
EXHIBIT 7-1**PORTFOLIO COMPANY STATUS OVER TIME: FIRST ROUND INVESTMENTS**

SOURCE: Sand Hill Econometrics.

with the exit rate (over the previous 10 years) assumed to be the same as that for the companies with known out-of-business dates. Exhibit 7-2 is an analogue to Exhibit 7-1, but now with this more aggressive assumption:

In Exhibit 7-2, the IPO and acquisition percentages are the same as in Exhibit 7-1, but the still-private and out-of-business lines are different. In Exhibit 7-2, by assumption, no companies are still private after 10 years, with the defunct percentage increasing to 49.1 percent.

Both of the prior exhibits show that about 51 percent of all VC investments end in an IPO or an acquisition, but this does not mean that all these investments could be labeled as “successes”. For the original (early stage) investors, an IPO is almost always a profitable exit, but we cannot say the same thing about all acquisitions. Exhibit 7-3 shows the likelihood for various ranges of gross value multiples (GVMs) for both IPOs and acquisitions.³

The exhibit shows that 53.6 percent of all IPO exits yield value multiples in excess of five times the original investment (the five highest categories) and 3.3 percent yield

³Because the SHE data is before fees and carry, the value multiples are “gross” and not “net”.

EXHIBIT 7-2

PORTFOLIO COMPANY STATUS OVER TIME, ASSUMING NO PRIVATE COMPANIES AFTER 10 YEARS, ALL FIRST-ROUND INVESTMENTS

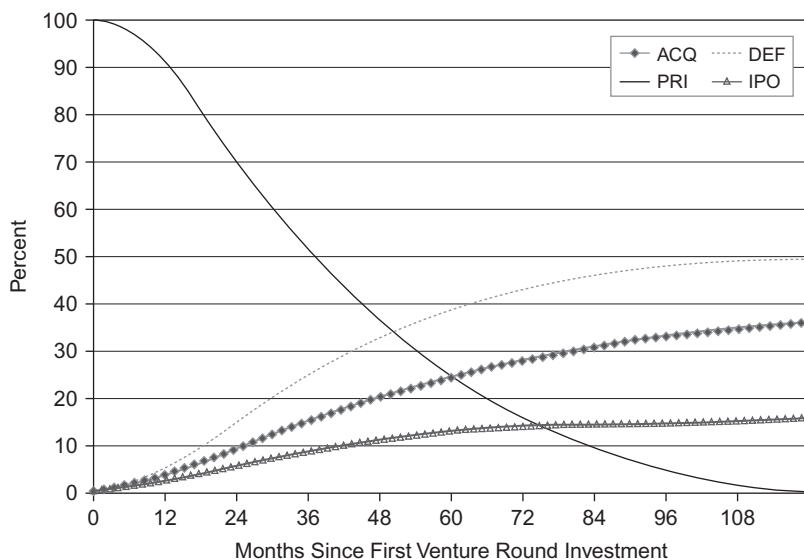

SOURCE: Sand Hill Econometrics.

multiples in excess of *50 times* the original investment (the two highest categories). It is important to note, however, that these multiples represent only the time period from the initial investment by the VC to the IPO date. Because VCs usually do not distribute stocks to their LPs for at least six months after the IPO, the actual returns to LPs will differ from those in the SHE database. This six-month return is unlikely to change the big picture of Exhibit 7-3, but it can make a huge difference for specific investments. For example, the most successful VC investment of all time is Benchmark Capital \$6.7M investment in eBay. At the time of the eBay IPO in September 1998, eBay's stock was priced at \$18 per share. The first trade on September 24 occurred at \$54 per share, and the Benchmark investment was valued at \$416M. By the time Benchmark started to distribute this stock to its LPs six months later, eBay had risen to a (split-adjusted) price above \$600 per share, and the value of the overall stake (GPs + LPs) was \$5.1B.⁴

⁴These figures are cited in Stross (2000), p. 216, who had the good timing to be writing a book about Benchmark Capital and following the firm from the inside while the eBay investment was happening.

EXHIBIT 7-3***GVMs FOR FIRST-ROUND INVESTMENTS: IPOs AND ACQUISITIONS***

Value Multiple	IPO	ACQ
<0.25	0.7%	15.1%
0.25 to <0.50	1.6%	9.3%
0.50 to <1.00	3.9%	13.6%
1.00 to <1.50	6.5%	10.7%
1.50 to <2.00	6.6%	8.2%
2 to <3	12.1%	10.8%
3 to <5	15.0%	11.4%
5 to <10	24.3%	11.4%
10 to <20	15.6%	5.6%
20 to <50	10.5%	3.0%
50 to <100	2.4%	0.6%
>= 100	0.8%	0.3%

NOTE: Data includes all first-round investments with known exit values.

SOURCE: Sand Hill Econometrics.

Exhibit 7-3 also shows that the multiples for acquisitions are much lower. First, note that 37.9 percent of all acquisitions result in a loss (the three lowest categories). This number is likely to be significantly understated because we are missing the acquisition price for about one-third of all acquisitions, and these missing values are almost surely tilted toward lower-return cases. (As mentioned earlier, missing acquisition values often indicate a going-out-of-business sale. In contrast, we always know the value of the IPO exit.) Among the cases where we do know the acquisition value, 20.9 percent yield multiples of five times or greater, and 0.9 percent yield multiples of 50 times or greater.

We turn next to an analysis of all first-round investments, including defunct companies. As in Exhibit 7-2, we assume that all private, unexited companies are defunct after 10 years.⁵ For exited companies for which we are missing the exit value, we impute exit values based on observable investment characteristics such as amount raised to date, time elapsed since last round, last known value if there is one, whether acquirer was public or private, and whether the deal was for stock or cash. Exhibit 7-4 shows the wide distribution of multiples for first-round investments. Once we include

⁵Some of these “still private” companies (as many as one in five) eventually do exit, so to the extent that we force all of them to have a multiple of 0, our results are conservative.

EXHIBIT 7-4*GVMs FOR ALL FIRST-ROUND INVESTMENTS*

Value Multiple	Percentage
0	49.10%
>0 to <0.25	10.68%
0.25 to <0.50	7.69%
0.50 to <1.00	6.74%
1.00 to <1.50	3.53%
1.50 to <2.00	2.62%
2 to <3	3.65%
3 to <5	3.99%
5 to <10	5.66%
10 to <20	3.41%
20 to <50	2.24%
50 to <100	0.49%
>= 100	0.19%

NOTE: These return distributions are estimated using the information on Exhibits 7-2 and 7-3, with some additional assumptions (described in the text) to handle missing exit values. The “still private” companies after 10 years are assumed to have failed.

SOURCE: Sand Hill Econometrics.

our conservative assumptions for “still private” companies and for the returns in acquisitions with unknown prices, we find that 74.22 percent of all first-round investments lead to a negative return (value multiple below 1). On the other end of the spectrum, 12.0 percent of all first-round investments yield multiples of 5 or greater, and 0.7 percent yield multiples of 50 or greater.

One caveat to this exercise is that, given the end of the sample period at the end of 2000, the results are disproportionately influenced by the record number of investments made in the tech bubble years of 1999 and 2000. According to the 2009 NVCA Yearbook, out of 9,052 early stage investments during 1990–2000, 4,553 (about 50% of all deals) were made in 1999 and 2000. It is all too well-known that many of these investments, made at the height of the market exuberance about Internet stocks, should never have been made—and subsequently failed. In a sense these were anomaly years of VC investing, probably never to be repeated. If we excluded these two anomaly years from the analysis, the results would have probably looked a lot different, with a lower percentage of failures and near failures, and a higher percentage of exits at multiples of 5 or higher. It will be interesting to update these figures in five years, when we have more information about final outcomes of investments made post-2000.

EXHIBIT 7-5

PORTFOLIO COMPANY STATUS OVER TIME, ASSUMING NO PRIVATE COMPANIES AFTER TEN YEARS, ALL SECOND-ROUND INVESTMENTS

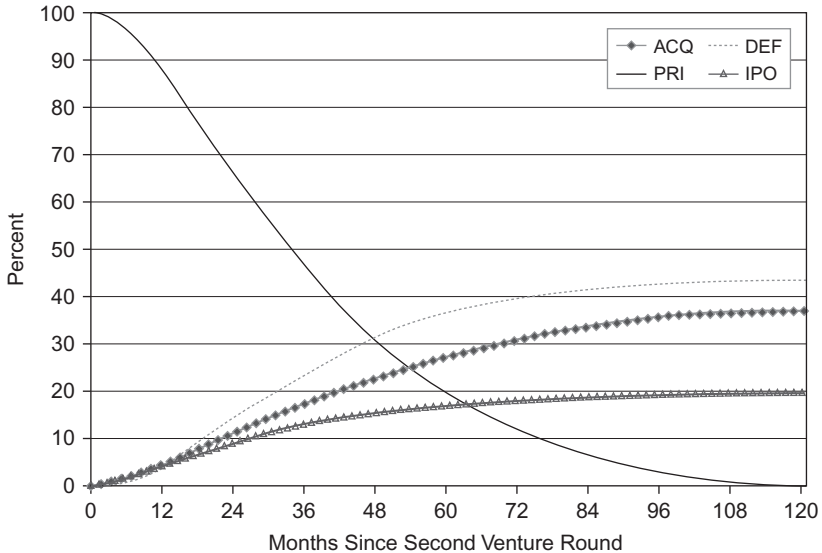

SOURCE: Sand Hill Econometrics.

Exhibit 7-5 uses second-round investments and repeats the survival analysis of Exhibit 7-2. As in Exhibit 7-2, we assume that all companies reported as “still private” after 10 years by SHE have actually gone out of business at the same rate as those companies observed to be defunct.

After five years, 27.3 percent of second-round investments have been acquired, 16.9 percent have had an IPO, 36.3 percent are defunct, and 19.5 percent are still private. After 10 years, 37.3 percent have been acquired, 19.3 percent have had an IPO, 43.4 percent are defunct, and, by assumption, none are still private. By comparing these percentages to their analogues in Exhibit 7-2, we can start to see some differences between first-round and second-round investments. For the second-round investments, IPO and ACQ percentages are both higher in all periods, and the DEF and PRI percentages are lower in all periods (until 10 years, when PRI is 0 for both.) These differences make sense because later-round investments should have demonstrated a greater capacity for survival than first-round investments. Because these higher survival probabilities are well understood by all parties, they will be factored into the share prices, and hence we cannot infer anything about

GVMs or returns from Exhibit 7-5. Instead, we must repeat the analysis of first-round investments and look directly at the GVMs. Exhibit 7-6 displays ranges of GVMs for second-round investments with IPO or acquisition exits.

By comparing Exhibits 7-6 and 7-3, we can see that the frequency of very high returns is significantly reduced in second rounds. For first-round investments, 3.3 percent of all IPOs led to GVMs of 50 or greater. For second rounds, only 0.6 percent of IPOs led to such extreme outcomes. Similarly, while more than half (53.6%) of all IPOs had GVMs of 5 or greater for first-round investments, the portion of IPOs with GVMs of 5 or greater is just over one-third (36.6%) for second-round investments. Of course, GVMs do not tell the whole story, as they make no allowance for differences in average holding periods. Exhibits 7-5 and 7-2 demonstrated that average holding periods are shorter (fewer private firms at each point) for second-round investments than for first-round investments. This shortening of holding periods would tend to make GVMs look less extreme for second-round investments, even if there were no difference in annualized returns. Nevertheless, the overall pattern of more extreme returns for first-round investments still holds, even if we focus on annualized returns. Exhibit 7-7 gives the GVMs for all second-round investments.

By comparing Exhibits 7-4 and 7-7, we can see that extreme multiples are less frequent for second-round investments compared to the first-round investments. This

EXHIBIT 7-6

GVMs FOR SECOND-ROUND INVESTMENTS: IPOs AND ACQUISITIONS

Value Multiple	IPO	ACQ
<0.25	0.8%	20.2%
0.25 to <0.50	1.1%	11.2%
0.50 to <1.00	6.4%	14.5%
1.00 to <1.50	9.9%	9.0%
1.50 to <2.00	9.9%	8.9%
2 to <3	15.4%	10.2%
3 to <5	19.8%	13.1%
5 to <10	22.0%	8.3%
10 to <20	10.4%	3.0%
20 to <50	3.6%	1.1%
50 to <100	0.5%	0.3%
>= 100	0.1%	0.1%

NOTE: Data includes all second-round investments with known exit values.

SOURCE: Sand Hill Econometrics.

EXHIBIT 7-7*GVMs FOR ALL SECOND-ROUND INVESTMENTS*

Value Multiple	Percentage
0	46.56%
>0 to <0.25	13.34%
0.25 to <0.50	7.95%
0.50 to <1.00	6.54%
1.00 to <1.50	3.69%
1.50 to <2.00	3.31%
2 to <3	4.39%
3 to <5	5.46%
5 to <10	5.35%
10 to <20	2.43%
20 to <50	0.82%
50 to <100	0.14%
>= 100	0.03%

NOTE: These return distributions are estimated using the information on Exhibits 7-5 and 7-6, with some additional assumptions to handle missing exit values. The “still private” companies after 10 years are assumed to have failed.

SOURCE: Sand Hill Econometrics.

result is consistent with our findings about IPOs and acquisitions discussed for the previous exhibit. Among all second-round investments, 0.2 percent had GVMs of 50 or greater, compared to 0.7 percent among all first-round investments. This lower frequency for great investments is somewhat counterbalanced by a lower frequency for write-offs, which occur for 46.6 percent of second-round investments compared to 49.1 percent of first-round investments.

Exhibit 7-8 uses third-round investments and repeats the survival analysis of Exhibits 7-2 and 7-5. As in those previous exhibits, we assume that all companies reported as “still private” after 10 years have actually gone out of business at the same rate as those companies observed to be defunct. After five years, 27.10 percent of third-round investments have been acquired, 19.90 percent have had an IPO, 36.97 percent are defunct, and 16.03 percent are still private. After 10 years, 34.73 percent have been acquired, 21.99 percent have had an IPO, 43.28 percent are defunct, and, by assumption, none are still private. As compared to second-round (Exhibit 7-5) investments, we see that failure rates for third round investments are slightly higher than those for second round investments in the initial months following investments, while after 10 years they are both at about 43%. As for IPO

EXHIBIT 7-8

PORTFOLIO COMPANY STATUS OVER TIME, ASSUMING NO PRIVATE COMPANIES AFTER 10 YEARS, ALL THIRD-ROUND INVESTMENTS

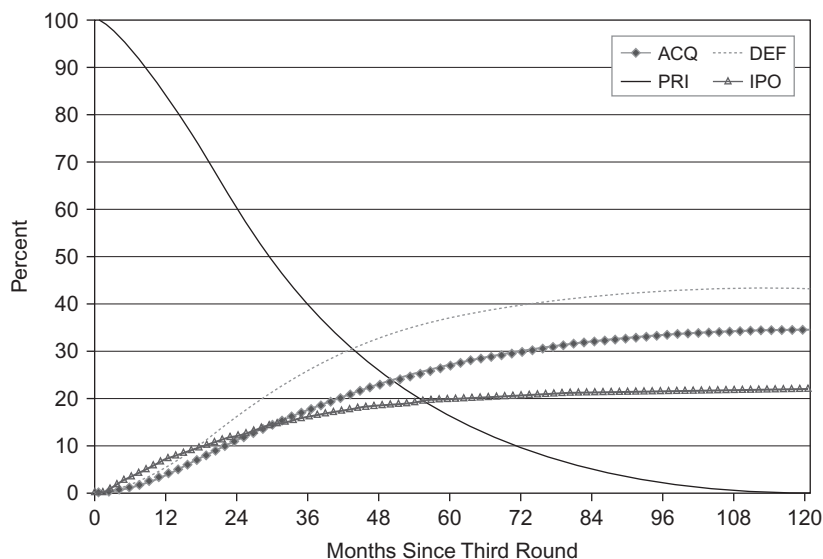

SOURCE: Sand Hill Econometrics.

versus ACQ outcomes, third-round investments have slightly higher IPO rates and lower ACQ rates than second-round investments.

Exhibit 7-9 reports GVMs for IPOs and acquisitions for all investments made in the third rounds.⁶ The evidence of Exhibit 7-9 continues the pattern of later rounds showing less extreme GVMs than earlier rounds. Only 0.1 percent of IPOs have GVMs of 50 or greater, and only 20.3 percent have GVMs of 5 or greater. In comparison, 3.3 percent of first-round investments had GVMs of 50 or greater, and 53.6 percent were 5 or greater. Although some of these differences can be ascribed to shorter holding periods of third-round investments, the difference still remains if we examine annualized returns. These patterns are reinforced when we examine the returns to all third-round investments.

Among third-round investments, only 44.7 percent are writeoffs, as compared to 46.6 percent of second rounds and 49.1 percent of first rounds. On the high end, only 5.6 percent had a value multiple of 5 or greater, compared to 8.8 percent above this threshold

⁶Analysis of fourth-round investments shows that they are similar to third-round investments, with an even higher concentration of multiples in the range of above 0 and below 5.

EXHIBIT 7-9***GVMs FOR THIRD-ROUND INVESTMENTS: IPOs AND ACQUISITIONS***

Value Multiple	IPO	ACQ
<0.25	0.5%	21.6%
0.25 to <0.50	1.4%	13.2%
0.50 to <1.00	8.2%	15.2%
1.00 to <1.50	14.1%	10.2%
1.50 to <2.00	13.0%	8.7%
2 to <3	19.2%	11.3%
3 to <5	23.5%	11.1%
5 to <10	14.5%	6.6%
10 to <20	4.6%	1.2%
20 to <50	1.1%	0.9%
50 to <100	0.1%	0.1%
>= 100	0.0%	0.0%

NOTE: Data includes all third-round investments with known exit values.

SOURCE: Sand Hill Econometrics.

in the second round and 12.0 percent in the first round. The relatively low frequency on the extremes means that 49.7 percent of all third-round investments had multiples in the range above 0 and below 5, compared to 44.7 percent of second rounds and 38.9 percent of first rounds. It is in this middle range above 0 and below 5 that the return advantage of preferred stock becomes apparent. The GVMs in this chapter are all based on the baseline SHE assumption that all investments are made in common stock. These exhibits would look different if we made more realistic assumptions about the security types in each round. We discuss and value these differences in Part III of the book.

The evidence from Exhibits 7-1 and 7-2 shows that IPO exits occurred for about 15.4 percent of all first-round investments made before 2001, and these investments were often quite profitable for the investors. As mentioned before, it is important to note that these results are disproportionately influenced by the unprecedented number of investments made during the 1999–2000 boom period. So in several more years, when more investments from the post-2000 period are included in the completed-investment sample, would the IPO exit rate start increasing again? This does not seem likely, at least not in the immediate future. The reason is that while the number of VC investments has declined to a more sustainable level in the post-2000 period, the number of VC-backed IPOs has plummeted even more drastically. Exhibit 7-11 shows this trend.

In particular, the exhibit shows the 10-year, rolling-window averages for the number of new VC investments and the number of VC-backed IPOs. For 1990, for example, the average number of new VC investments for the previous 10 years

EXHIBIT 7-10**GVMs FOR ALL THIRD-ROUND INVESTMENTS**

Value Multiple	Percentage
0	44.71%
>0 to <0.25	13.54%
0.25 to <0.50	7.88%
0.50 to <1.00	6.92%
1.00 to <1.50	4.94%
1.50 to <2.00	4.11%
2 to <3	5.73%
3 to <5	6.57%
5 to <10	3.98%
10 to <20	1.14%
20 to <50	0.43%
50 to <100	0.05%
>= 100	0.00%

NOTE: These return distributions are estimated using the information on Exhibits 7-8 and 7-9, with some additional assumptions to handle missing exit values. The “still private” companies after 10 years are assumed to have failed.

SOURCE: Sand Hill Econometrics.

(1981–1990) is 508, and the average number of VC-backed IPOs in the previous 10 years is 95. The ratio of the two numbers (shown on the right-hand axis in %) is a back-of-the-envelope measure of the IPO rate of VC investments. In the first half of the 1990s, as the number of VC financings stayed low and the IPO market boomed, this ratio climbed up and peaked at 31 percent in 1994. Near the end of the decade, however, the number of VC financings ballooned much faster than the number of VC-backed IPOs, and the ratio rapidly started to decline. By 2000, the ratio of the two 10-year average numbers is down to 16 percent, which is almost exactly the same as the IPO rate in Exhibit 7-2 (15%).

Post-2000, the number of investments declined—but never declined to the level last seen in the early 1990s. Even in 2009, at the depth of the recession, 725 new financings took place, compared to just 417 in 1994. Meanwhile, the number of VC-backed IPOs continued to stagnate at the level last seen in the late 1980s—less than 50 a year on average—throughout the first decade of the new century. Thus, the ratio of the 10-year averages of IPOs and new VC financing keeps going down, and as of 2009, it is just 5 percent—that is, on average there were only 67 IPOs for 1,260 investments per year.

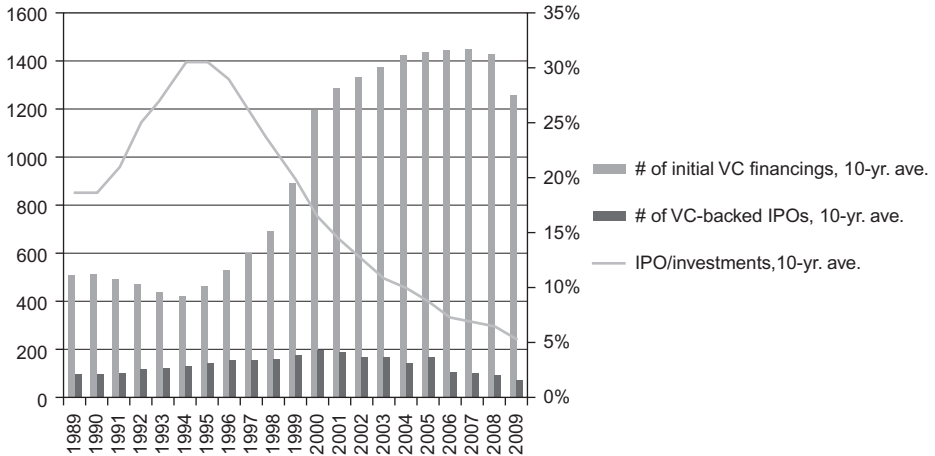
EXHIBIT 7-11**10-YEAR AVERAGE VC FINANCINGS AND IPO EXITS, BY ENDING YEAR**

SOURCE: 2009 NVCA Yearbook, press releases on NVCA website.

For this rate to start going back up again, one or both of two things needs to happen. First, there will have to be more VC-backed IPOs and more IPOs in general. Second, the number of VC financings will need to go down further. While some argue precisely both of these things need to take place for the VC model to start working again, others assert that VC investments need not rely on IPO exits alone. It will be interesting to revisit this data in several years and find out if the patterns of VC investment exits evolve further away from IPOs or return to the long-term historical levels of IPO rates.

7.2 THE INVESTMENT PROCESS

In Chapter 1, we listed several stages a potential VC investment goes through before any money changes hands. These stages included **screening**, the **term sheet**, **due diligence**, and **closing**. Exhibit 7-12 gives an example of the number of investments that reach each stage of this process for a “typical” VC:⁷

⁷There is no academic research to back up Exhibit 7-12. These numbers are estimates gleaned from conversations with VCs and researchers.

EXHIBIT 7-12*THE INVESTMENT PROCESS*

Screening	[100–1,000]
Preliminary Due Diligence	[10]
Term Sheet	[3]
Final Due Diligence	[2]
Closing	[1]

The first entry in the exhibit has a wide range, from 100 to 1,000, because the first screening stage is somewhat amorphously defined. If we include every business idea ever seen by the VC, then the number would be closer to 1,000. If we include only those ideas that receive any formal attention, then the number would be closer to 100. In any case, the odds are long to reach the next stage. The exhibit shows that for every 100 to 1,000 opportunities that cross a VC's desk, only about 10 will reach the more intensive screening stage that we are calling "preliminary due diligence". Of these 10, about 3 will justify a **term sheet**. Term sheets are preliminary contracts designed as a starting point for the more detailed negotiations required for the contract. In Chapter 8 we cover term sheets in detail.

The acceptance of a term sheet by the entrepreneur leads to a more complete due diligence and contract negotiation. There are many ways that an agreement can break down between the term sheet and the final investment. Although hard data are difficult to find, some VCs report that only about half of all accepted term sheets lead to an investment. Thus, the typical VC would need to screen at least 100 companies to make one investment.

As we move down Exhibit 7-12, each successive stage takes progressively more work. The exact process for each stage varies considerably across firms. There is no consensus on the best practices for each stage, and it is doubtful that such a consensus will ever occur. Nevertheless, a few themes are apparent. First, the existence of a formal process is highly correlated with the size of the VC firm. Firms with just a few partners are likely to make decisions as a group, with all partners somewhat informed and involved in all stages of due diligence and in the investment decision. For midsize firms larger than five or six partners, this group decision making becomes unwieldy, and we are more likely to see a deal driven by one or two partners, with the full partnership investing on the basis of a written memo and an oral presentation by the lead partner for the deal. Such midsize firms often attempt to make their investment decisions at regularly scheduled weekly meetings, where all partners try to participate in person or by telephone. For the larger firms, regular meetings of the entire partnership are not feasible, and commitment decisions are usually made by a committee of senior partners. If there is an investment committee, then a written memo becomes an important way for

other principals to communicate with the committee. Also, large firms are the only place where we find a significant number of junior VCs who do not take the lead on investments, but whose main role is to screen potential investments, perform due diligence, and take on various other detail work.

A big component of VC success is the quality of prospects at the screening stage, also called the **deal flow**. The generation of high-quality deal flow, also called “**sourcing**”, is a major challenge and takes a big chunk of VC time and energy. The VCs use a variety of sourcing strategies. In general, the better the reputation of the VC firm, the better the deal flow, and the less work the VCs have to do to get it. In our discussion of Summit Partners in Chapter 5, we mentioned how its extensive database of private companies often provides it with **proprietary deal flow**, the holy grail of all private equity investors. Other top-tier VCs will often garner proprietary deal flow through the sheer force of their reputation, as entrepreneurs will want the famous VC brand attached to their company. These top-tier VCs receive most of their deal flow either from repeat entrepreneurs or as direct referrals from close contacts. Younger and less-prestigious firms also rely on direct referrals—often from professional service providers such as accountants, lawyers, and consultants—but also must be more proactive about attending trade shows, accessing third-party databases, and even cold-calling new firms.

Once the deal flow is generated, VCs must perform the initial screen. Although some investments may be screened through informal conversation or from third-party information sources, the majority of investments are screened using a **business plan** prepared by the entrepreneur. The business plan gives a summary of all crucial information about the company; it includes a detailed description of the strategic plan for the company, the current and potential competitors, and the background of the management team. Although financial projections are also included, the detail in these projections varies widely. For early stage companies, the projections usually focus on the uses of funds; for later-stage companies, the projections should be more complete financial statements. In general, the VCs (correctly) take all such forecasts with a grain of salt.

Many academics have studied the screening phase, but lack of access to a broad database prevents any strong quantitative conclusions. These studies, in addition to published interviews with famous VCs, do allow for some qualitative conclusions about the most important elements of the initial screen. These two elements also remain the key focus of the next phases of diligence. We will call them the **market test** and the **management test**. They can both be phrased as questions:

1. Does this venture have a large and addressable market? (Market test)
2. Does the current management have the capabilities to make this business work? (Management test)

The market test focuses on whether the company could conceivably lead to a large exit. For most VCs, a “large” market is one that could sustain a public company, with a plausible valuation of several hundred million dollars within about

five years. A company developing a novel drug to treat breast cancer is going after a big market; a company developing a novel drug to treat a disease with only 1,000 sufferers worldwide is not. An “addressable” market is one that can conceivably be entered by a new company. If a company has a new operating system for personal computers, the potential market is certainly large, but it is quite unlikely that the product will make any progress against the Microsoft juggernaut.

The market test requires both art and science. The science component is most important when you are looking at a business with established markets (e.g., breast cancer), even if the product is novel (e.g., a new drug). The market test is much more of an art when the VC is evaluating new markets, either because there are currently no products in that space, or because the products in that space have not yet found any path to profitability. eBay is an example of a company that addressed a completely new market. Many VCs scoffed at eBay when it first began, and it is hard to blame them.⁸ Even Benchmark Capital, the eventual investor, did not invest until the company was already profitable, although one must still admire its ability to spot the huge market potential that eventually led to a return of nearly 1,000 times the VC investment. Yahoo! and Netscape are other examples of such new markets from the early Internet era. On the health care side, the investment in Genentech, the first company based on the new science of DNA replication, also required high artistry of market vision.

Google is an example of a company that addressed an existing market, but one without a clear path to profitability. In 1999, at the time of Google’s first (and only) round of institutional VC investment, Internet search was already old news. All the major Internet portals had search technology, and search was viewed as something of a commodity tool on these portals, and not one that could garner huge profit by itself. The bet on Google was essentially a bet that its superior search technology would eventually lead to a shift in consumer practices, allowing a pure search site to develop its own revenue stream. This kind of investment requires business vision that is certainly more art than science, and more than one famous VC has publicly admitted that his vision failed in this case.⁹

⁸Bessemer Venture Partners, a VC firm with many famous successes, humorously admits their oversights on the website of their “antiportfolio”: <http://www.bvp.com/port/anti.asp>. In honest moments, many other VCs would sympathize with Bessemer’s reaction to eBay: “Stamps? Coins? Comic books? You’ve GOT to be kidding.” Just as good was the reaction of a Bessemer partner upon learning that the student founders of Google were renting the garage (yes, the garage) of a college friend: “Students? A new search engine? How can I get out of this house without going anywhere near your garage?”

⁹See the previous footnote for Bessemer Venture Partner’s admission. A second admission comes from Tim Draper of Draper Fisher Jurvetson, one of our top-tier firms from Chapter 5. The April 2005 issue of the *Venture Capital Journal* summarizes an interview Draper gave to the *San Francisco Chronicle*, in which he says he passed on Google because his firm had already backed “some 20 other companies featuring search engine technology.” The same article also states that another top VC admitted—off the record—to passing on Google.

Both eBay and Google—the two most successful VC investments of all time—demonstrate the importance of both sourcing and the initial screen for the long-term competitive advantage of VCs. In both cases, the opportunities were only made available to some of the top VCs; “no-name” firms never got the chance to demonstrate their investing vision. Nevertheless, in both cases some of these top VCs passed on the opportunity, because the large, addressable market was not at all obvious.

The evaluation of the management team—the management test—is most qualitative part of screening and due diligence. Many VCs argue that the evaluation of people is the most important part of their job and believe that success or failure is driven primarily by the strength of the management team. In evaluating the management of a start-up company, the VC must form a judgment about both the individuals and the team. In evaluating individuals, VCs carefully study the backgrounds and personalities to determine whether the individual has the ability to carry out her assigned role in the company. The easy cases occur when the individual has previous experience in a similar role, which is the main reason that repeat entrepreneurs are the most prized—particularly the successful ones. Besides the obvious resume analysis, VCs must use their judgment to decide whether specific individuals have the right temperament to thrive in an entrepreneurial company. Although many studies have attempted to analyze the characteristics of successful entrepreneurs, it is fair to say that there is no clear consensus. Instead, VCs must rely on intuition and experience.

In the evaluation of the entire management team, VCs must make sure that all the key functions are covered, and that the team dynamics allow all the managers to play to their strengths. For example, a visionary CEO can act as a great motivator and salesman for the company, but such CEOs will usually need a strong manager to handle the details. It is ideal if both roles can coexist, but many times the visionary will be unwilling to yield operational control, or the detail manager will be unable to work with a visionary CEO. In many cases VCs may feel that management teams have most of the necessary skills but lack one crucial component. This missing piece could be in some specific function such as sales or finance, or it could lie in the CEO position. Indeed, many startups are lead by a visionary and filled with talent in science and engineering, but lack any managers with entrepreneurial business experience. In this case, the VC must be able to judge whether this preexisting team will be able to work with newly recruited players, perhaps drawn from the VC’s own Rolodex.

The focus on strong management is virtually universal among VCs. An oft-spoken mantra at VC conferences is, “I would rather invest in strong management with an average business plan than in average management with a strong business plan”. This notion is supported by the claims that it is easier for a great management team to switch into a new line of business than it is for an average management team to execute a good idea. Indeed, claims like this are spoken so often that one might expect mountains of evidence to support them, but in fact the evidence that does exist points in the opposite direction. Kaplan, Sensoy, and Stromberg (2005) studied 49 successful

VC investments from their early business plans (birth) through their IPOs (exit). They discovered, to much surprise, that core business lines are remarkably stable from birth to exit. On the other hand, management changes are quite common. These results, the only rigorous evidence that exists on this question, suggest that conventional wisdom is wrong.

Screening is a crucial step, and poor performance here can ruin the best deal flow. There are a variety of approaches to this step. Some firms hire junior professionals to handle much of this task, while the senior VCs focus on later stages of the investment decision and on the active monitoring of the portfolio companies. The advantage of this division of labor is that much more time can be dedicated to the initial screen; the disadvantage is that inexperienced VCs might not do the job as well. Other firms eschew the use of junior professionals completely, and all screening is handled by experienced VCs. One can find these firms on both ends of the reputation spectrum, from low-reputation firms, who do not have sufficient deal flow and management fees to justify hiring junior VCs, to high-reputation firms, who rely mostly on referrals from a superior network, thus getting some of the initial screening for free.

Investments that make it through the screening phase are then subjected to a preliminary level of **due diligence**. The screening phase is about identifying opportunities that meet the market test and the management test; it is a phase dominated by optimism and happy thoughts. In contrast, due diligence is all about hard questions and thinking about what can go wrong. The first part of this due diligence is the meeting of VCs with the company management. This **pitch meeting** is a famous touchstone of the VC-entrepreneur relationship. For many companies, the process ends right there. The pitch meeting is an ideal place to see if an investment meets the management test, and successful VCs often have a well-developed sixth sense for sizing up managerial capabilities.

For companies that pass the pitch meeting, the next phase of due diligence can take many forms. Exhibit 7-12 breaks up the due diligence steps into a pre-term-sheet step (preliminary diligence) and a post-term-sheet step (final diligence). The fraction of diligence done before the term sheet varies across firms, and even across deals within the same firm. In general, the more competitive the deal, the quicker the firm will want to deliver a term sheet, and the more of the diligence that will be left until afterward. Many term sheets include a period of exclusivity, giving the VC some time to complete diligence while the company is restricted from negotiating with other potential investors. In recent years, with less competition and more wary investors, there has been an increase in the level of diligence done prior to the term sheet.

Given this variation in the level of diligence in each of these steps, it is not possible to say what steps belong in the preliminary part and what steps belong in the final part, so we will just treat both together. Overall, in due diligence the VC aims to check every part of the company's story. This is an important part of the investing process, but one for which we have little hard evidence or academic research. Thus, given the quantitative focus of this book, it is beyond our scope to

treat due diligence in detail.¹⁰ Instead we briefly discuss 12 main topics for a due diligence investigation: management, market, customers, product, technology, competition, projections, channels, partners, money, transaction terms, and a final catchall category of “terrible things”. The first two topics—management and market—are the two most important, just as they were in the screening phase.

Management

The management test was a key hurdle for the screening stage, and it remains (with the market test) the most important part of due diligence. At the screening stage, the management test was about upside, asking whether the present management team appeared to have the capabilities to execute the company’s business plan. These questions become much more detailed at the due-diligence stage, with careful evaluations of weaknesses on the management team. Often, these evaluations will lead to VC demands that seasoned executives be hired to fill new roles such as CFO or VP of marketing. This process is only the first step in hands-on recruiting and management support that VCs provide to their portfolio companies.

In addition to the continued evaluation of managerial capabilities, the due-diligence stage also includes a detailed level of management vetting. At some firms, the process is just as rigorous as an FBI background check, with job histories, educational backgrounds, and even personal relationships checked. This vetting function is often outsourced to specialized agencies.

Market

At the screening stage, the market test required large, addressable markets. In the due-diligence phase, the first impressions of such markets must be carefully analyzed. What might have been a quick and dirty estimate now must be backed up by hard data. Many of the remaining items on this list cover some component of market due diligence. When all these items are put together, the VC should critically examine his initial impressions of the overall market and convince himself (and his partners) that a large, addressable market exists.

Customers

Who are (or will be) the customers for this company? Does the company rely on just a few key customers? If so, the stability of these relationships must be assessed. Some VCs will even tag along on a sales call to judge the reaction of potential customers and to simultaneously evaluate the sales capabilities of the company.

¹⁰ Readers interested in a more detailed treatment of due diligence should consult Camp (2002) and Gladstone and Gladstone (2004).

Product

If the product is already available, how good is it? For certain kinds of products, the VC can try it out himself. If this is not practical, then at least he can speak with potential customers to understand the advantages and disadvantages of the product. In some cases, it is useful to conduct focus groups and surveys. (This last item is often outsourced.)

Technology

In evaluating technology, it is almost always necessary to consult experts in the field, and access to the right experts is crucial for VCs. One benefit of high reputation for a VC is the ability to attract a high-quality set of scientific advisors for formal and informal consultations. In addition to the scientific evaluation of the technology, it is also crucial to perform diligence on the legal protection provided by patents or trade secrets. The best time to find out that a company's technology infringes on someone else's patent is *before* you make an investment.

Competition

Who is the competition? How will the portfolio company build a sustainable competitive advantage to compete in this market? Note: If a company claims it has no competitors or potential competitors, then it is probably wrong. Virtually all products developed for large, addressable markets will have competition. Underestimating the competition is a red flag about managerial capabilities.

Projections

All business plans have projections, and of course they are always grossly inflated.¹¹ Although such inflation is expected, it is still important that management understands *how* it will grow. If management projects revenue growth of 100 percent over the next year, then at the very least it should have a sales force, manufacturing plan, and other costs that are consistent with such an increase. Of course, VCs will make their own projections, but management projections are still a great window to make sure that the managers really understand their business.

Channels

How does the product actually get sold? A focus on sales channels forces the VC to understand all the players in the business, both upstream and downstream. In

¹¹One VC at a top-tier firm confided a humorous anecdote about one of his firm's portfolio companies. This particular company received an award from a national magazine as the "fastest growing private company for the last three years". Nevertheless, even over this time period the company did not achieve the management projections from its business plan.

principle, channel analysis should be an important component of the customer and projection categories (see earlier discussion). Many potential markets are characterized by standards battles, powerful wholesale players, and relationship-driven sales at several points in the value chain. Indeed, the analysis of channels is the most important step in understanding whether a large market is indeed “addressable.”

Partners

Many startup companies are particularly reliant on a few partners. We use the term “partners” loosely here to mean anything from key suppliers, development partners, and firms with any kind of cooperative agreement. VCs should certainly speak with any partners and confirm that the relationships are healthy and stable. A high-reputation VC can be particularly influential in attracting and retaining partners, a strategy that has particular value in businesses where potential partners and customers need to see some evidence of credibility.

Money

How has the company been financed up to this point? How well does it take care of its cash? What exactly does it intend to do with the investment? VCs should insist on a high level of financial controls (hence the common requirement to add a CFO) and should make sure they understand the cash situation of their portfolio companies at all times. Many startups begin on shoestring budget and do not have the discipline to handle the large new sums from a VC investment. Furthermore, this analysis must include a reasonable estimate of the total amount of financing that would be required to reach a successful exit. It is not uncommon for VCs to find investments that meet the market and management tests but nevertheless are not viable investments, because their cash needs are so great. The classic example here is in early stage drug development. To bring a drug through the approval process has become such an expensive proposition that only a few early stage companies can qualify for VC financing. Companies with high cash needs are said to have a high **burn rate**, meaning that they “burn through cash at a high rate”. The burn rate can also be used to calculate how long a company can last between rounds of investment.

Transaction Terms

Although VCs should certainly rely on lawyers for the careful checking of legal language in the final contracts, there is still work for VCs to do in crafting economic terms specific to each transaction. Many of these terms will be introduced in Chapter 8 and then discussed in Part III of the book. Transaction terms are a due-diligence subject, because it is the information uncovered by due diligence that should lead VCs to ask for (or, in some cases, demand) certain terms in the final contract. Furthermore, the negotiation of these specific terms will often provide insights into specific concerns and private information of management.

Terrible Things

Lots of terrible things can be lurking in the shadows ready to pounce on an unsuspecting investor. This category encompasses “legal” due diligence (is there an active or potential lawsuit against the company? Are the firms’ incorporation documents in good order? And so on.). It also includes environmental due diligence (is the property on a toxic site? Don’t laugh that one off.). Finally, this category is also a good catchall for anything else that might seem fishy and require more digging.

As mentioned earlier, some of this due diligence would be completed before a term sheet is offered, and some would be completed afterward. Frequently, the final due diligence will uncover issues that require amending some elements of the term sheet. Almost always, such amendments improve the terms for the VCs at the expense of the company. Nevertheless, VCs should resist the temptation to use this post-due-diligence negotiation as a way to extract extra concessions from their portfolio companies. Tough negotiation during a period of exclusivity can breed ill will that lasts for the remainder of the VC’s association with the company. If a poor relationship begins at this stage, it is often difficult for the VC to add value later. Furthermore, the entrepreneurial community is small enough that bad reputations can be quickly built, and good reputations can be quickly lost.

Following the acceptance of the term sheet by both parties, the completion of due diligence, and the negotiation and signing of the final contract, the transaction closes, often with an anticlimactic wire transfer.

SUMMARY

Before making an investment, a VC must assess the probability of success and potential returns. The historical evidence can provide a useful benchmark. The extensive database built by Sand Hill Econometrics tells us that 23.3 percent of all first-round investments eventually had an IPO. This percentage rises to 28.2 percent for second-round investments and 30.3 percent for third-round investments. The lower percentage of IPOs in earlier rounds is counterbalanced by higher returns for these IPOs. Overall, 19.1 percent of all first-round investments earn a value multiple of five or more, whereas 43.7 percent return nothing. For second-round investments, we estimate that 13.7 percent earn a value multiple of five or more, and 38.8 percent return nothing. For later-round investments, the corresponding percentages are 7.4 percent and 33.7 percent.

Once VCs make an initial screening of an investment, they proceed to a more detailed level of due diligence. The most important parts of both screening and due diligence are the assessments of the potential market (“Is it large and addressable?”) and the quality of management (“Is it good enough to execute the business plan?”). These major questions are supplemented by analyses in 10 major areas: customers, product, technology, competition, projections, channels, partners, money, transaction terms, and terrible things.

KEY TERMS

Screening	Deal flow, sourcing, pro-	<i>The management test</i>
Term sheet	prietary deal flow	Pitch meeting
Due diligence	Business plan	Burn rate
Closing	<i>The market test</i>	

REFERENCES

- Camp, Justin J., 2002, *Venture Capital Due Diligence*, Wiley, New York.
- Gladstone, David, and Laura Gladstone, 2004, *Venture Capital Investing*, Prentice Hall, Upper Saddle River, New Jersey.
- Kaplan, Steven N., Berk Sensoy, and Per Stromberg, 2009, "Should Investors Bet on the Jockey or the Horse? Evidence from the Evolution of Firms from Early Business Plans to Public Companies", *Journal of Finance* 64(1), 75–115.
- Stross, Randall E., 2000, *eBoys*, Crown Publishers, New York.
- Venture Capital Journal, 2005, April.

TERM SHEETS

IN THIS CHAPTER, we step through a sample **term sheet** for a \$5M investment. This sample term sheet is a simplified version of the Model Term Sheet produced by the National Venture Capital Association (NVCA) and is available in the most up-to-date version on its website.¹ The complete Model Term Sheet, as last updated April 2009, is given in Appendix A at the back of this book.

A VC typically signals its intention to invest by offering a term sheet to the potential portfolio company. The company responds by signing the term sheet, rejecting it completely, or negotiating changes to some of the provisions. If the parties can agree on a term sheet, then it is signed, and the VC proceeds to a detailed level of due diligence, usually with a period of exclusivity spelled out in the term sheet. Term sheets can be thought of as starting points for a good-faith negotiation. Although few term sheet provisions have binding consequences if they are not followed, the document still serves as an anchor for all future negotiations between the parties.

Term sheets are broken into sections, with each section providing a summary for a longer legal document that will be executed at closing. In Section 8.1 we give the basic opening information of our sample term sheet, including the size of the investment, the parties involved, and the proposed capitalization for the company. In Section 8.2 we discuss the **Charter** section of the term sheet, which includes many of the most hotly negotiated provisions. In Section 8.3 we cover the **Investor Rights Agreement**, a relatively long and technical section of the term sheet. Finally, Section 8.4 covers the remaining portions of the term sheet under the label of “Other Items”.

In most sections of this chapter, we begin with a verbatim reproduction of a section in the term sheet. This is followed by a discussion of several (but not all) of the provisions. During this discussion, we often reference the survey findings from the sixth Edition of the *Dow Jones Venture Capital Deal Terms Report*, which is referred to as the “*Dow Jones Report*”. This report gives the findings from a recent survey of completed deals while allowing us to see the relative popularity of different provisions.

¹Check http://www.nvca.org/index.php?option=com_content&view=article&id=108&Itemid=136 for the most recent version.

This chapter contains a good deal of legal jargon and technical terminology. However, to master the concepts of VC, there is no escaping some of this detail—but it is helpful to remember the big picture. VCs are usually minority investors in high-risk businesses, and the investment they provide is at the mercy of a small number of managers. VC contracts are designed to protect this investment from expropriation, which can occur either through negligence (low effort by managers) or malice (stealing or self-dealing). Thus the big picture is that a term sheet describes the basic structure of a transaction and provides a set of protections against expropriation.

8.1 THE BASICS

The search for VC funding is time-consuming and economically costly. These costs make it inefficient for companies to constantly be looking for new investors. Instead, as first discussed in Chapter 1, VCs make lumpy investments organized into sequential **rounds**. A first-round investment is designated as **Series A**, a second-round investment as **Series B**, and so on. The sample term sheet that follows describes a Series A investment.

TERM SHEET FOR SERIES A PREFERRED STOCK FINANCING OF Newco Inc. January 1, 2010

This Term Sheet summarizes the principal terms of the Series A Preferred Stock Financing of [_____], Inc., a [Delaware] corporation (the “**Company**”). In consideration of the time and expense devoted and to be devoted by the Investors with respect to this investment, the No Shop/Confidentiality [and Counsel and Expenses] provisions of this Term Sheet shall be binding obligations of the Company, whether or not the financing is consummated. No other legally binding obligations will be created until definitive agreements are executed and delivered by all parties. This Term Sheet is not a commitment to invest, and is conditioned on the completion of due diligence, legal review, and documentation that is satisfactory to the Investors. This Term Sheet shall be governed in all respects by the laws of the [State of Delaware], and does not constitute an offer to sell or a solicitation of an offer to buy securities in any state where the offer or sale is not permitted.

Offering Terms

Closing Date: As soon as practicable following the Company’s acceptance of this Term Sheet and satisfaction of the Conditions to Closing (the “*Closing*”).

Investors: Early Bird Ventures I (“*EBV*”): 5,000,000 shares (33.33%), \$5,000,000

Amount Raised: \$5,000,000

Price Per Share: \$1 per share (based on the capitalization of the Company set forth below) (the “*Original Purchase Price*”).

(Continued)

Pre-Money Valuation: The Original Purchase Price is based upon a fully-diluted pre-money valuation of \$10,000,000 and a fully-diluted post-money valuation of \$15,000,000 (including an employee pool representing 15% of the fully-diluted post-money capitalization).

Capitalization: The Company's capital structure before and after the Closing is set forth below:

Security	Pre-Financing		Post-Financing	
	# of Shares	%	# of Shares	%
Common—Founders	7,750,000	77.5	7,750,000	51.7
Common—Employee Stock Pool	2,250,000	22.5	2,250,000	15.0
Issued	300,000	3.0	300,000	2.0
Unissued	1,950,000	19.5	1,950,000	13.0
Series A Preferred	0	0.0	5,000,000	33.3
Total	10,000,000	100	15,000,000	100

8.1.1 Investors

This section of the term sheet lists all investors, the dollar amount of their investment (which we will call the *\$investment*), and the number of shares they receive for this amount. In this case, the investment implies ownership of 33.33 percent of the company on a **fully diluted basis** (which assumes that all preferred stock is converted and that all options are exercised). The details of the **fully diluted share count** are given in the **capitalization table** immediately preceding this paragraph. We refer to the 33.33 percent represented by the Series A as the *proposed ownership percentage*, a number that will play an important role in our analysis.

In this term sheet, all of the \$investment is paid at one time. In some cases, the \$investment is spread across multiple payments, known as **tranches**, which may be contingent on the firm reaching some prespecified milestones, such as the development of a working prototype for a product, the first major customer, or some specific level of sales. The *Dow Jones Report* tells us that about 19 percent of all rounds had such tranches in the July 2007–June 2008 period, with this frequency higher in first rounds (Series A) than in later rounds. Anecdotal evidence suggests that such tranching is more common in weak VC markets (such as the postboom) than it is in strong markets (such as the boom period).² Most analysis in this book is appropriate only for one-time investments without additional tranches. The analysis of tranced investments requires specific modeling of each milestone.

²Consistent with this view, the rounds with tranches were 16.5% of total in the July 2006–June 2007 period, according to the *Dow Jones Report*.

The real-options analysis of Chapter 21 can provide some direction for this modeling, but in general it is not possible to build a general framework that can handle all possible cases.

8.1.2 Price Per Share

The price per share, also called the **original purchase price (OPP)**, serves as the basis for many other calculations in VC transactions. In this example, the OPP is straight forward to compute, because there is only one type of security, and it has a set number of shares. However, in cases with multiple security types, the OPP computation can be more arbitrary. We will give an example of such a computation in Chapter 9.

In this book, we will also use the term *aggregate purchase price (APP)* to refer to the price paid for all shares of a security, where $APP = OPP * \text{shares purchased}$. When there is only one security type, the APP is equal to \$investment. When there are multiple security types, then the exact division of \$investment into the APP for each security is important.

8.1.3 Pre-Money and Post-Money Valuation

Pre-money valuation and **post-money valuation** are heavily used terms in the VC industry. In principle, post-money valuation is an analogue to market capitalization for public companies. To compute (equity) market capitalization for a public company, we multiply the price per share times the number of shares outstanding. Post-money valuation is calculated the same way:

$$\text{Post-money valuation} = \text{price per share} * \text{fully diluted share count.} \quad (8.1)$$

For our example, this calculation gives us $\$1 * 15M = \$15M$. An alternative way to calculate post-money valuation is as follows:

$$\text{Post-money valuation} = \$\text{investment} / \text{proposed ownership percentage.} \quad (8.2)$$

This method also gives us \$15M, this time as $\$5M / 0.3333$. Equations (8.1) and (8.2) are completely equivalent and are used interchangeably in practice.

Pre-money valuation is the market capitalization of the company before the VC investment. We can compute it by simply subtracting the investment from the post-money valuation:

$$\text{Pre-money valuation} = \text{post-money valuation} - \$\text{investment.} \quad (8.3)$$

For our example, we get a pre-money valuation of $\$15M - \$5M = \$10M$. An alternative method to compute the pre-money valuation is to multiply the price per share by the pretransaction shares outstanding:

$$\begin{aligned} \text{Pre-money valuation} \\ = \text{price per share} * \text{pretransaction (fully diluted) share count.} \end{aligned} \quad (8.4)$$

The pretransaction share count of 10M includes everything except the VC shares. We can observe this share count in the first set of columns in the capitalization table. Like equation (8.3), this alternative calculation gives us a pre-money valuation of $\$1 * 10M = \$10M$.³

In many VC transactions, the pre-money and post-money valuations are the key terms discussed by the parties. Although these terms are certainly useful for quickly communicating some basic aspects of a transaction, it is important to note that they can be misleading about certain details. Specifically, the analogy to market capitalization breaks down once we acknowledge that preferred stock (which VCs usually buy) can be quite different from common stock (which founders usually own). Because the post-money and pre-money calculations do not distinguish between preferred and common stock, the results of these calculations do not necessarily reflect anything about the market value of the company. To accurately compute the implied market value of a company, we will need the option-pricing tools developed in Part III of this book. Once these tools have been developed, we dedicate all of Chapter 17 to this computation.

8.1.4 Capitalization

The final part of this introductory section is the capitalization table. In addition to the categories used here, a capitalization table might also include shares owned by previous investors (including angel investors and VCs from earlier rounds) or additional security types purchased in this round. Some possible security types will be discussed at length in Chapter 9. For now, we will note without comment that, in contrast to the **common stock** held by founders and employees, VCs typically purchase some form of **preferred stock**.

The capitalization table will always include a section for the employee stock pool, which contains shares set aside as incentive compensation for employees. The employees are usually issued call options on common stock, and the stock pool is used to provide shares on the exercise of these options. Because VC-backed companies rely heavily on options for compensation, VCs typically insist that the expected option compensation be included in the capitalization table at the time of financing. In our example, we include a pool that represents 15 percent of the fully diluted share count. This choice is consistent with historical industry practice according to the *Dow Jones Report*, though there seems to be a downward trend in the most recent two survey years (2007 and 2008). Also note that this number is lower for later rounds, as they have more shares issued to investors. Fifteen percent has become a focal point for stock pools and is both the median and mode in the *Dow Jones Report*.

³Equation (8.4) can yield an incorrect answer for pre-money valuation in cases where antidilution protections have been triggered. Chapter 9 gives an example and a discussion of this point. For safety, an analyst can always use Equation (8.3) to compute pre-money valuation.

8.2 THE CHARTER

The Charter, also known as the **Certificate of Incorporation**, is a public document filed with the state in which the company is incorporated. In the majority of VC transactions, this state is Delaware, which has the best-developed and best-understood corporate law. Among other things, the Charter establishes the rights, preferences, privileges, and restrictions of each class and series of the company's stock.

Charter

Dividends: Dividends will be paid on the Series A Preferred on an as-converted basis when, as, and if paid on the Common Stock.

Liquidation Preference: In the event of any liquidation, dissolution, or winding up of the Company, the proceeds shall be paid as follows:

First pay one times the Original Purchase Price on each share of Series A Preferred. The balance of any proceeds shall be distributed to holders of Common Stock.

A merger or consolidation (other than one in which stockholders of the Company own a majority by voting power of the outstanding shares of the surviving or acquiring corporation) and a sale, lease, transfer, or other disposition of all or substantially all of the assets of the Company will be treated as a liquidation event (a “*Deemed Liquidation Event*”), thereby triggering payment of the liquidation preferences described above. [Investors’ entitlement to their liquidation preference shall not be abrogated or diminished in the event part of consideration is subject to escrow in connection with a Deemed Liquidation Event.]

Voting Rights: The Series A Preferred Stock shall vote together with the Common Stock on an as-converted basis, and not as a separate class, except (i) the Series A Preferred as a class shall be entitled to elect two members of the Board (the “*Series A Directors*”), and (ii) as required by law. The Company’s Certificate of Incorporation will provide that the number of authorized shares of Common Stock may be increased or decreased with the approval of a majority of the Preferred and Common Stock, voting together as a single class, and without a separate class vote by the Common Stock.

Protective Provisions: So long as any shares of Series A Preferred are outstanding, in addition to any other vote or approval required under the Company’s Charter or By-laws, the Company will not, without the written consent of the holders of at least 50% of the Company’s Series A Preferred, either directly or by amendment, merger, consolidation, or otherwise: (i) liquidate, dissolve, or wind-up the affairs of the Company, or effect any Deemed Liquidation Event; (ii) amend, alter, or repeal any provision of the Certificate of Incorporation or Bylaws; (iii) create or authorize the creation of or issue any other security convertible into or exercisable for any equity

(Continued)

security, having rights, preferences, or privileges senior to or on parity with the Series A Preferred, or increase the authorized number of shares of Series A Preferred; (iv) reclassify, alter, or amend any existing security that is junior to or on parity with the Series A Preferred, if such reclassification, alteration, or amendment would render such other security senior to or on parity with the Series A Preferred; (v) purchase or redeem or pay any dividend on any capital stock prior to the Series A Preferred; or (vi) create or authorize the creation of any debt security; (vii) create or hold capital stock in any subsidiary that is not a wholly owned subsidiary, or dispose of any subsidiary stock or all or substantially all of any subsidiary assets; or (viii) increase or decrease the size of the Board of Directors.

*Optional
Conversion:*

The Series A Preferred initially converts 1:1 to Common Stock at any time at option of holder, subject to adjustments for stock dividends, splits, combinations, and similar events and as described below under “Anti-dilution Provisions”.

*Anti-dilution
Provisions:*

In the event that the Company issues additional securities at a purchase price less than the current Series A Preferred conversion price, such conversion price shall be reduced to the price at which the new shares are issued.

The following issuances shall not trigger anti-dilution adjustment:

(i) securities issuable upon conversion of any of the Series A Preferred, or as a dividend or distribution on the Series A Preferred; (ii) securities issued upon the conversion of any debenture, warrant, option, or other convertible security; (iii) Common Stock issuable upon a stock split, stock dividend, or any subdivision of shares of Common Stock; and (iv) shares of Common Stock (or options to purchase such shares of Common Stock) issued or issuable to employees or directors of, or consultants to, the Company pursuant to any plan approved by the Company’s Board of Directors.

*Mandatory
Conversion:*

Each share of Series A Preferred will automatically be converted into Common Stock at the then-applicable conversion rate (i) in the event of the closing of an underwritten public offering with a price of 5 times the Original Purchase Price (subject to adjustments for stock dividends, splits, combinations and similar events) and net proceeds to the Company of not less than \$15,000,000 (a “*Qualified Public Offering*” = “*QPO*”), or (ii) upon the written consent of the holders of 75% of the Series A Preferred.

*Redemption
Rights:*

The Series A Preferred shall be redeemable from funds legally available for distribution at the option of holders of at least 50% of the Series A Preferred commencing any time after the fifth anniversary of the Closing at a price equal to the Original Purchase Price plus all accrued but unpaid dividends. Redemption shall occur in three equal annual portions. Upon a redemption request from the holders of the required percentage of the Series A Preferred, all Series A Preferred shares shall be redeemed (except for any Series A holders who affirmatively optout).

8.2.1 Dividends

In public companies, preferred stock is usually issued with the promise of cash dividends. However, preferred stock in VC transactions rarely promises cash dividends, because portfolio companies are usually cash poor, and these dividends would accelerate the need for more financing. Instead, some term sheets—like our example—will give a **dividend preference** to preferred stock, meaning that you cannot pay any dividends to common stock unless you first pay dividends to the preferred. This is essentially a way to prevent the management of the company from sneaking cash out to common shareholders. Alternatively, the preferred stock might receive **accrued cash dividends** to be paid in cash only upon a deemed liquidation event (see the *Liquidation Preference* topic of the Charter for a definition).

Finally, the preferred stock might receive **stock dividends**, which adds the total holdings of preferred. Such stock is called **payment-in-kind (“PIK”)** preferred. Dividend rights may be **cumulative** or **noncumulative**—the difference being that cumulative dividends accrue even if not paid, whereas noncumulative dividends only accrue during the final period before they are paid. Cumulative dividends can accrue by **simple interest** (the same flat percentage every year on the OPP) or by **compound interest** (which includes dividends paid on previous dividends.) Overall, dividends may be either for cash (accrued cash dividends) or stock (PIK dividends), each type of dividends may be cumulative or noncumulative, and cumulative dividends may be by simple or compound interest. See the NVCA model term sheet in Appendix A for the example language for several of these cases.

8.2.2 Liquidation Preference

When a company is sold, merged, or shut down—a **deemed liquidation event**—the proceeds are distributed to bondholders, preferred stockholders, and common stockholders, in that order. A **liquidation preference** tells an investor where she stands in the capital structure hierarchy. In our example, there is no debt and only one round of VC investment, so the Series A preferred is getting the first dollar from any liquidation. When there have been multiple rounds of investment, it is common for the latest-round investors to get their money back first. Thus, Series D investors would have liquidation preference to Series C investors, Series C investors would be preferred relative to Series B, and so on. An alternative to this ordering, known as “*pari passu*”, is for all (or some) preferred investors to be paid back at the same time. The *Dow Jones Report* finds that about two-thirds of deals give the latest-round investors priority over all other (earlier) classes of preferred stock.

In some cases, investors insist on liquidation preferences in excess of their original investment. For example, a **2X** or **3X** liquidation preference requires that the investor be paid back double or triple, respectively, their original investment before any of the other (junior) equity claims are paid off. In the term sheet, we would write a 2X liquidation preference by replacing the second section of the liquidation preference section with “First pay *two* times the Original Purchase Price”. The *Dow*

Jones Report finds that about one-quarter of all deals contain an **excess liquidation preference**, with about 70 percent of these preferences being 2X or less.

8.2.3 Voting Rights and Other Protective Provisions

As discussed earlier, most of what we see in term sheets can be understood as VCs (the minority shareholders) protecting themselves from expropriation by the majority shareholders. Several of these methods of protection are contained in the voting rights and protective provisions part of the term sheet. In our example, the Series A investors are guaranteed two spots on the board and are also given the power to block some corporate actions with a separate vote. In the Investor Rights Agreement part of the term sheet (addressed in Section 8.3), we are told that the board will contain five members in total, with two members selected by Series A, two by the founders, and one that is acceptable to all parties. Thus in our example, EBV will control approximately half of the board while only having one-third of the fully diluted shares. Such shared control is typical following Series A investments, including more than half of all cases in the *Dow Jones Report*. In contrast, after receiving Series B and later rounds of VC financing, boards of ventures are increasingly controlled collectively by the investors.

The *Dow Jones Report* finds that about three-quarters of all deals contain some form of **antidilution protection**. In principle, these provisions protect investors' stakes if future investments are done at a lower price per share; such investments are known in the industry as a **down round**. The details of antidilution provisions can quickly get quite messy; we will cover this topic in detail in Chapter 9.

8.2.4 Mandatory Conversion

Convertible preferred stock usually converts to common stock at the discretion of the investor. Some events, however, may trigger an automatic conversion, such as a **qualified public offering (QPO)**, which is a public offering that meets certain thresholds (for example, dollars raised or price per share). In our example, the QPO would require an offering of at least \$15M and a price per share of five times the OPP = \$5 per share.

8.2.5 Redemption Rights

For situations other than liquidation, **redemption rights** give conditions under which investors can demand that the company **redeem** (pay back) their initial investment. Examples of such conditions include a prespecified length of time or failure to meet certain milestones. In our example, these rights would commence five years after the original investment—but in practice, redemption rights are rarely exercised, in part because the legal status of preferred stock as “equity” restricts the power of preferred holders to demand repayment of their investment. Although the language of redemption rights tries to get around these restrictions—for example, “the Series

A Preferred shall be redeemable from funds legally available for distribution”—the reality is that redemption rights don’t provide much leverage unless the company is cash rich and can easily pay the investors back.

8.3 INVESTOR RIGHTS AGREEMENT

Investor Rights Agreement

Registration Rights:

Registrable Securities: All shares of Common Stock issuable upon conversion of the Series A Preferred and any other Common Stock held by the Investors will be deemed “*Registrable Securities*”.

Demand Registration: Upon earliest of (i) five years after the Closing; or (ii) six months following an initial public offering (“IPO”), persons holding 25% of the Registrable Securities may request one (consummated) registration by the Company of their shares. The aggregate offering price for such registration may not be less than \$10 million. A registration will count for this purpose only if (i) all Registrable Securities requested to be registered are registered and (ii) it is closed, or withdrawn at the request of the Investors (other than as a result of a material adverse change to the Company).

Registration on Form S-3: The holders of 10% of the Registrable Securities will have the right to require the Company to register on Form S-3, if available for use by the Company, Registrable Securities for an aggregate offering price of at least \$1 million. There will be no limit on the aggregate number of such Form S-3 registrations, provided that there are no more than two per year.

Piggyback Registration: The holders of Registrable Securities will be entitled to “piggyback” registration rights on all registration statements of the Company, subject to the right, however, of the Company and its underwriters to reduce the number of shares proposed to be registered to a minimum of 30% on a pro rata basis and to complete reduction on an IPO at the underwriter’s discretion. In all events, the shares to be registered by holders of Registrable Securities will be reduced only after all other stockholders’ shares are reduced.

Expenses: The registration expenses (exclusive of stock transfer taxes, underwriting discounts, and commissions) will be borne by the Company. The Company will also pay the reasonable fees and expenses.

Lockup: Investors shall agree in connection with the IPO, if requested by the managing underwriter, not to sell or transfer any shares of

(Continued)

Common Stock of the Company for a period of up to 180 days following the IPO subject to extension to facilitate compliance with FINRA rule (provided all directors and officers of the Company and 5% stockholders agree to the same lockup). Such lockup agreement shall provide that any discretionary waiver or termination of the restrictions of such agreements by the Company or representatives of the underwriters shall apply to Investors, prorata, based on the number of shares held.

Management and Information Rights:

A Management Rights letter from the Company, in a form reasonably acceptable to the Major Investors, will be delivered prior to Closing to each Investor that requests one.

Any Major Investor will be granted access to Company facilities and personnel during normal business hours and with reasonable advance notification. The Company will deliver to the Investor (i) annual and quarterly financial statements, and other information as determined by the Board; (ii) thirty days prior to the end of each fiscal year, a comprehensive operating budget forecasting the Company's revenues, expenses, and cash position on a month-to-month basis for the upcoming fiscal year; and (iii) promptly following the end of each quarter an up-to-date capitalization table. A "Major Investor" means any Investor who purchases at least \$1 million of Series A Preferred.

Right to Maintain Proportionate Ownership:

All Major Investors shall have a pro rata right, based on their percentage equity ownership in the Company (assuming the conversion of all outstanding Preferred Stock into Common Stock and the exercise of all options outstanding under the Company's stock plans), to participate in subsequent issuances of equity securities of the Company (excluding those issuances listed at the end of the "Anti-dilution Provisions" section of this Term Sheet). In addition, should any Major Investor choose not to purchase its full pro rata share, the remaining Major Investors shall have the right to purchase the remaining pro rata shares.

Matters Requiring Investor Director Approval:

So long as the holders of Series A Preferred are entitled to elect a Series A Director, the Company will not, without Board approval, which approval must include the affirmative vote of 100% of the Series A Director(s):

(i) make any loan or advance to, or own any stock or other securities of, any subsidiary or other corporation, partnership, or other entity, unless it is wholly owned by the Company; (ii) make any loan or advance to any person, including any employee or director, except advances and similar expenditures in the ordinary course of business or under the terms of a employee stock or option plan approved by the Board of Directors; (iii) guarantee any indebtedness except for trade accounts of the Company or any subsidiary arising in the ordinary course of business; (iv) make any investment inconsistent with any investment policy approved

by the Board; (v) incur any aggregate indebtedness in excess of \$1 million that is not already included in a Board-approved budget, other than trade credit incurred in the ordinary course of business; (vi) enter into or be a party to any transaction with any director, officer, or employee of the Company or any “associate” (as defined in Rule 12b-2 promulgated under the Exchange Act) of any such person except transactions resulting in payments to or by the Company in an amount less than \$60,000 per year [or transactions made in the ordinary course of business and pursuant to reasonable requirements of the Company’s business and upon fair and reasonable terms that are approved by a majority of the Board of Directors]; (vii) hire, fire, or change the compensation of the executive officers, including approving any option plans; (viii) change the principal business of the Company, enter new lines of business, or exit the current line of business; or (ix) sell, transfer, license, pledge, or encumber technology or intellectual property, other than licenses granted in the ordinary course of business; or (x) enter into any corporate strategic relationship involving the payment contribution or assignment by the Company or to the Company of assets greater than \$100,000.00.

Non-Competition and Non-Solicitation and Agreements:

Each Founder and key employee will enter into a one-year non-competition and non-solicitation agreement in a form reasonably acceptable to the Investors.

Non-Disclosure and Developments Agreement:

Each current and former Founder, employee, and consultant will enter into a non-disclosure and proprietary rights assignment agreement in a form reasonably acceptable to the Investors.

Board Matters:

Each non-employee director shall be entitled in such person’s discretion to be a member of any Board committee.

The Board of Directors shall meet at least quarterly, unless otherwise agreed by a vote of the majority of Directors.

The Company will bind D&O insurance with a carrier and in an amount satisfactory to the Board of Directors. Company shall agree that its indemnification obligations to Series A Directors are primary, and obligations of affiliated Investors are secondary. In the event the Company merges with another entity and is not the surviving corporation, or transfers all of its assets, proper provisions shall be made so that successors of the Company assume Company’s obligations with respect to indemnification of Directors.

Employee Stock Options:

All employee options to vest as follows: 25% after one year, with remaining vesting monthly over next 36 months.

Key Person Insurance:

Company to acquire life insurance on Founders in an amount satisfactory to the Board. Proceeds payable to the Company.

8.3.1 Registration Rights

Stock purchased in private transactions is **restricted**. This means that the stock cannot be sold in a public offering. To lose this restriction, a transaction must be **registered**. **Registration** means filing legal documents and disclosing data about the firm to the SEC. This is a costly activity that firms like to avoid.

Even if no other shares are being sold, **demand registration rights** allow investors to force the company to register a transaction for their shares. Term sheets spell out exactly how often such rights can be exercised and for how many shares. **S-3 registration rights** are weaker than demand rights, because they are only useful if the company is already reporting to the SEC. **Piggyback registration rights** are even weaker than S-3 rights; they allow investors to go along with a registered transaction already being prepared for other shares. These are much less costly to a company than demand rights.

Rule 144 is an exception to the registration rules, allowing shares to be sold to the public after they have been held for a certain period of time (as long as the company has some other public shares or follows filing requirements with the SEC). As of 2010, the rule allows unlimited sales by non-insiders of otherwise restricted stock after it has been held for at least one year; such sales can often be made by LPs after **in-kind distributions** of stock by the GP. In addition, the rule allows for unlimited sales by non-insiders after the stock has been held for at least six months but less than one year, as long as adequate current information about the Company is publicly available. In contrast, sales by insiders (such as GPs who sit on the board of the Company) are subject to additional volume and filing restrictions. **Rule 144A** is another exception that allows resale of stock or debt to **Qualified Institutional Buyers (QIBs)** outside the registration process; QIBs are institutions with more than \$100 million in investment assets under management. All insider stock tends to be subject to an additional **lockup**—often 180 days—after an IPO. This lockup is contractually imposed by the underwriter and is independent of the SEC restrictions.

8.3.2 Matters Requiring Investor-Director Approval

This category of investor rights attempts to give minority investors protection against a laundry list of possible expropriation by managers and other investors. The standardized list in the Newco termsheet contains 10 items. While these lists can run much longer, the danger of a very long list is that the company will be hamstrung in its ability to operate the business. Overall, VCs must walk a fine line between protecting their investment and encouraging corporate growth.

8.3.3 Employee Stock Options

When key employees are hired, they are typically given shares or options to buy shares in the company as part of their compensation. If such shares are promised, they are usually earned over time, or **vested**. **Step vesting** often occurs at annual,

quarterly, or monthly increments, usually over periods of three to five years. **Cliff vesting** takes place all at one time. Some contracts—like this Newco termsheet—use step vesting for part of the shares and cliff vesting for the rest. In this case, we see cliff vesting of 25 percent after one year, with monthly step vesting for the next 36 months. Vesting is sometimes also used for founders' shares at the time of the first venture capital investment, meaning that a founder who previously “owned” the whole company must now temporarily hand back his ownership stake and stay for a few years before he gets it back.

8.4 OTHER ITEMS

Stock Purchase Agreement

<i>Representations and Warranties:</i>	Standard representations and warranties by the Company.
<i>Conditions to Closing:</i>	Standard conditions to Closing, which shall include, among other things, satisfactory completion of financial and legal due diligence, qualification of the shares under applicable Blue Sky laws, the filing of a Certificate of Incorporation establishing the rights and preferences of the Series A Preferred, and an opinion of counsel to the Company.
<i>Counsel and Expenses:</i>	Investor counsel to draft closing documents. Company to pay all legal and administrative costs of the financing at Closing, including reasonable fees and expenses of Investor counsel.

Right of First Refusal/Co-Sale Agreement and Voting Agreement

<i>Right of first Refusal/ Right of Co-Sale (Take-me-Along):</i>	Company first and Investors second (to the extent assigned by the Board of Directors) have a right of first refusal with respect to any shares of capital stock of the Company proposed to be sold by Founders and employees holding greater than 1% of Company Common Stock (assuming conversion of Preferred Stock and whether then held or subject to the exercise of options), with a right of oversubscription for Investors of shares unsubscribed by the other Investors. Before any such person may sell Common Stock, he will give the Investors an opportunity to participate in such sale on a basis proportionate to the amount of securities held by the seller and those held by the participating Investors.
<i>Lockup:</i>	Founders will not transfer, hedge, or otherwise dispose of any capital stock following an IPO for a period specified by the Company and the managing underwriter (not to exceed 180 days).

(Continued)

Board of Directors: At the initial Closing, the Board shall consist of five members comprised of (i) Joe Veese, as a representative designated by EBV, (ii) Jane Vencap as a representative designated by EBV, (iii) Jim Goodfriend as a representative designated by the Founders, (iv) Neel Onterpraynoor, the Chief Executive Officer of the Company, and (v) one person who is not employed by the Company and who is mutually acceptable to the Founders and Investors.

Other Matters

Founders' Stock: All Founders to own stock outright, subject to Company's right to buyback at cost. Buyback right for 50% for first 12 months after Closing; thereafter, right lapses in equal monthly increments over following 36 months.

No Shop/Confidentiality: The Company agrees to work in good faith expeditiously towards a closing. The Company and the Founders agree that they will not, for a period of six weeks from the date these terms are accepted, take any action to solicit, initiate, encourage, or assist the submission of any proposal, negotiation, or offer from any person or entity other than the Investors relating to the sale or issuance, of any of the capital stock of the Company or the acquisition, sale, lease, license, or other disposition of the Company, or any material part of the stock or assets of the Company, and shall notify the Investors promptly of any inquiries by any third parties in regards to the foregoing. The Company will not disclose the terms of this Term Sheet to any person other than officers, members of the Board of Directors, the Company's accountants and attorneys, and other potential Investors acceptable to EBV, as lead Investor, without the written consent of the Investors.

Expiration: This Term Sheet expires on January 8, 2010 if not accepted by the Company by that date.

8.4.1 Rights and Restrictions

Investors want key personnel in their portfolio firms to have financial incentives to stay and work hard. They also want to prevent founders from exiting in "sweet-heart" transactions. To achieve these goals, **transfer restrictions** may be placed on a founder's (or an investor's) shares. Such restrictions may prevent all sales of founders' stock without express permission from later investors, or may allow later investors to participate in such sales (called **take-me-along** or **tag-along rights**), or be offered the shares before anyone else (**right of first offer**), or have the option to participate at the price that has been offered by other parties (**right of first refusal**). Another type of transfer provision not seen in this term sheet is a **drag-along right**, which provides a selling investor with the ability to force other investors to sell their stakes at the same price. Drag-along rights can be useful for investors who need to force a sale of the whole firm.

8.4.2 Founders' Stock

The buyback right on founders' stock is usually valid only when founders have been dismissed from the firm "for cause". The definition of "for cause" is often a sticking point in the final negotiations. Note that this buyback right means that founder shares are effectively vested at a similar rate to employee options. Although this might seem unfair—after all, the founders may have been committed to the firm for many years already—the founders are often so crucial to the company that the VC needs to make sure that they have strong incentives to stick around.

SUMMARY

The term sheet is a preliminary agreement used to anchor the key contractual provisions for a VC investment. The term sheet begins with the basic information of the investment and includes a summary for many of the contractual documents needed for the final closing. Most term sheet provisions can be understood as attempts by minority shareholders (VCs) to protect themselves from expropriation by managers and majority shareholders. For valuation purposes, the most important portion of the term sheet is the information about investment size, price per share, and security type. Most VC securities are preferred stock: the rights of these preferred shares are described in the company's Charter. Additional restrictions on corporate activities and the reporting requirements to the investors are described in the Investor Rights Agreement.

KEY TERMS

Term Sheet, Charter, Investor Rights Agreement	Deemed liquidation event	Restricted stock
Expropriation	Dividend preference	Registration rights, demand registration rights, S-3 registration rights, piggyback registration rights
Rounds	Stock dividends = payment-in-kind (PIK) dividends	Rule 144, Rule 144A
Series A investment	Accrued cash dividend	In-kind distributions
<i>Investment</i>	Cumulative dividends, noncumulative dividends	Qualified Institutional Buyers (QIBs)
Original purchase price (OPP), <i>Aggregate purchase price (APP)</i>	Simple interest, compound interest	Lockup
Fully diluted basis, fully diluted share count	Liquidation preference, 2X (3X, 4X, etc.) excess liquidation preference	Step vesting, cliff vesting
Capitalization table	Down round	Transfer restrictions, take-me-along = tag-along, right of first offer, right of first refusal, drag-along
<i>Proposed ownership percentage</i>	Qualified public offering (QPO)	
Tranche	Redemption rights	
Pre-money valuation, post-money valuation		

REFERENCES

Dow Jones, 2009, *Deal Terms Report*, 6th Edition, Jersey City, NJ.

National Venture Capital Association, 2009, *Model Term Sheet*, available at http://www.nvca.org/index.php?option=com_content&view=article&id=108&Itemid=136.

EXERCISES

8.1 True, False, or Uncertain: After a portfolio company has an IPO, the VCs are free to sell their stock in this company in the public market.

8.2 EBV is considering a \$6M Series A investment for 6M shares of CP at \$1 per share. The proposed capitalization table for Newco is as follows:

EXHIBIT 8-1

CAPITALIZATION TABLE FOR NEWCO

Security	Prefinancing		Postfinancing	
	# of Shares	%	# of Shares	%
Common—Founders	15,000,000	83.3	15,000,000	62.5
Common—Employee Stock Pool	3,000,000	16.7	3,000,000	12.5
Issued	600,000	3.3	600,000	2.5
Unissued	2,400,000	13.4	2,400,000	10.0
Series A Preferred	0	0.0	6,000,000	25.0
Total	18,000,000	100	24,000,000	100

- What are the OPP and APP for the Series A?
- What is the fully diluted share count?
- What is the proposed ownership percentage?
- What is the post-money valuation?
- What is the pre-money valuation?

PREFERRED STOCK

IN THE UNITED STATES, VCs almost always use preferred stock in their transactions. This preferred stock comes in many flavors. In Section 9.1 of this chapter, we analyze the main types of preferred stock and learn how to graphically represent them. Most types of preferred stock are convertible into common stock, either at the discretion of the investor (voluntary conversion) or when some preset threshold is reached (automatic conversion). These conversion conditions are sometimes adjusted due to antidilution protections, as first mentioned in Chapter 8. In Section 9.2 of this chapter, we provide mathematical formulas and examples to illustrate the impact of antidilution protections.

9.1 TYPES OF PREFERRED STOCK

In public markets, the vast majority of equity investments are made with common stock. However, for VC transactions in the United States, nearly all the investments are made with preferred stock. The key characteristic of preferred stock is that it has a liquidation preference to common stock. This is seen in the Newco charter of Chapter 8, where the preferred stock has a liquidation preference (for \$5M APP) and an optional conversion (for 5M shares, representing one-third of the fully diluted share count). These two features define the Series A Newco stock as **convertible preferred (CP)**. With CP, EBV must decide at the time of exit whether to redeem (and receive all proceeds up to \$5M, but nothing else) or to convert to 5M shares and receive one-third of all proceeds.

The key step here is the determination of the *conversion condition*, an inequality defining the level of proceeds where conversion is more valuable than redemption. We call this level the *conversion point*. The conversion point for a Series A investment is written as W_A . We will need to make this calculation numerous times in the chapters to follow, thus it will be useful to go through the procedure carefully this first time.

If EBV chooses to convert, then this conversion would give it 5M shares. Because the founders have 10M shares, this would give EBV one-third of the firm.

For total exit proceeds = \$W, we have

$$\text{CP (conversion value)} = 1/3 * \$W. \quad (9.1)$$

For proceeds $\$W$, if EBV chooses to redeem the CP, it would receive

$$\text{CP (redemption value)} = \text{Min}(\$5\text{M}, \$W). \quad (9.2)$$

To make the conversion decision, EBV compares the value of Equations (9.1) and (9.2) for any given W . The conversion condition holds when Equation (9.1) is greater than Equation (9.2). This condition is illustrated in Exhibit 9-1.

The dotted line in Exhibit 9-1 represents conversion (Equation 9.1). The solid line in Exhibit 9-1 represents redemption (Equation 9.2). EBV's choice between conversion and redemption can be made by answering the question, "Do I want to be on the dotted line or the solid line?" For low values of W , the solid line is above the dotted line, so the investor is better off redeeming for cash—but for high values of W , the dotted line is above the solid line, so the investor is better off converting to common shares. The conversion point occurs when conversion and redemption are equal, which is found at the intersection of the two lines. The conversion condition holds for all W above that point.

$$\text{Conversion Condition: } 1/3 * W > 5 \rightarrow W_A = 15 \quad (9.3)$$

If the proceeds of the liquidation are $\$15\text{M}$, then EBV will receive $\$5$ million for either redeeming or converting. Below $\$15$ million, EBV is better off redeeming. Above $\$15$ million, it is better off converting. Exhibit 9-2 redraws Exhibit 9-1 to reflect this conversion condition and include only the higher of the two lines in Exhibit 9-1.

EXHIBIT 9-1

CONVERSION CONDITION FOR CP

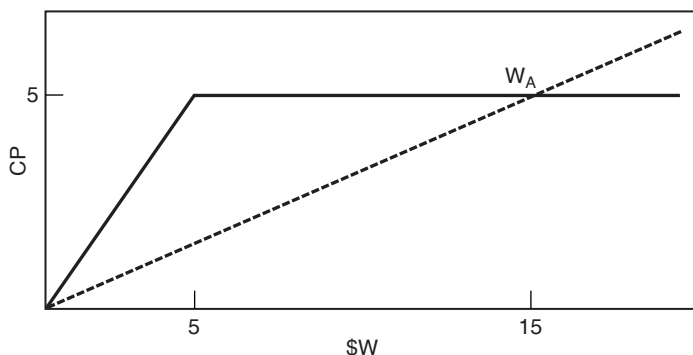

We refer to Exhibit 9-2 as an *exit diagram* because it plots the value of a security against the value of the whole firm at the time of the exit of the investment.

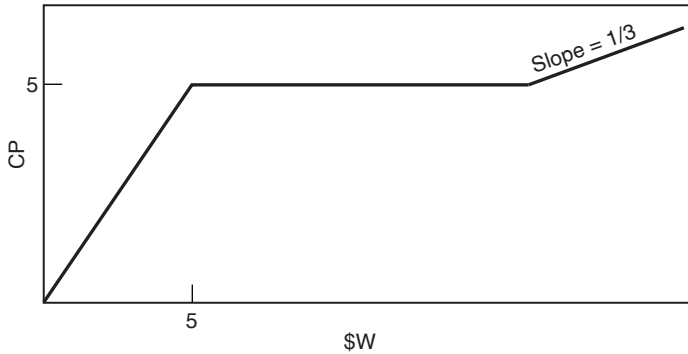
EXHIBIT 9-2*EXIT DIAGRAM FOR CP*

We will use exit diagrams extensively when we do valuation of preferred stock in Part III.

CP is not the only flavor of preferred stock. **Redeemable preferred (RP)** stock has the same liquidation preference as given in the Newco charter, but omits the conversion features. Thus RP offers no possibility of conversion—and thus no upside. Although a VC would never accept RP by itself, some transactions will combine RP with common stock or with CP.

The Model Term Sheet (Appendix A) gives three alternatives for the liquidation preference. The Newco charter from Chapter 8 uses Alternative 1, which is called CP.

Alternative 1

In the event of any liquidation, dissolution, or winding up of the Company, the proceeds shall be paid as follows:

First pay one times the Original Purchase Price on each share of Series A Preferred. The balance of any proceeds shall be distributed to holders of Common Stock.

A merger or consolidation (other than one in which stockholders of the Company own a majority by voting power of the outstanding shares of the surviving or acquiring corporation) and a sale, lease, transfer, or other disposition of all or substantially all of the assets of the Company will be treated as a liquidation event (a “Deemed Liquidation Event”), thereby triggering payment of the liquidation preferences described above.

The language of Alternative 2 leads to a security called **participating convertible preferred (PCP)**. The text of Alternative 2, which follows, would replace the second paragraph of Alternative 1 from the preceding.

Alternative 2

First pay one times the Original Purchase Price on each share of Series A Preferred. Thereafter, the Series A Preferred participates with the Common Stock on an as-converted basis.

By itself, this language implies that the PCP holders would get back the OPP and then also receive any additional proceeds that would have been garnered if it had also converted to common stock. In this respect, we could say that PCP is like having RP plus common stock. It is important to remember, however, that this liquidation preference only applies in the case of a deemed liquidation event. If the PCP is converted—perhaps because of a mandatory conversion—then it becomes just like common stock.

The language of Alternative 3 in the Model Term Sheet is very similar to Alternative 2, except that there is a cap on the liquidation preference. Thus we refer to this security as **participating convertible preferred with cap (PCPC)**. The text of Alternative 3 is given as follows:

Alternative 3

First pay one times the Original Purchase Price on each share of Series A Preferred. Thereafter, Series A Preferred participates with Common Stock on an as-converted basis until the holders of Series A Preferred receive an aggregate of [_____] times the Original Purchase Price

The cap is driven by filling in the blank space in the last sentence. The language in these alternatives determines whether the security is common stock, RP, CP, PCP, or PCPC. In practice, it is much easier to refer to securities with these acronyms than to write out the liquidation preference; therefore, we will follow that practice in this book.

To illustrate the differences among these different flavors of preferred stock, we draw exit diagrams for each of them in Example 9.1.

EXAMPLE 9.1

EBV is considering a \$5M Series A investment in Newco. The founders and employees of Newco have claims on 10M shares of common (including the stock pool). Thus, we are adopting the same setup as in the Newco charter in Chapter 8. Now, however, in addition to the CP structure considered there, EBV is considering six alternative structures for their investment:

Structure I: 5M shares of common

Structure II: RP (\$5M APP)

Structure III: RP + 5M shares of common

Structure IV: PCP with participation as if 5M shares of common

Structure V: PCPC with participation as if 5M shares of common, with liquidation return capped at four times OPP

Structure VI: RP (\$4M APP) + 5M shares of CP (\$1M APP)

Structures IV and V have mandatory conversion upon a QPO, where a QPO is any offering of at least \$5 per common share and \$15M of proceeds. For the purpose of solving this problem, assume that *any exit* above \$5 per share will qualify as a QPO (i.e., acquisitions for at least \$5 per common share would also be considered to be QPOs).

Problems

- (a) Draw an exit diagram for each structure.
 (b) Compare the five structures for exit proceeds of \$3M, \$8M, \$32M, \$72M, and \$96M. Also include a comparison for the original CP structure from the Newco charter.

Solutions

(a) *Structure I* is for 5M shares of common, that there would be 15M shares total (10M for founders and 5M for EBV.) Thus, under this structure EBV would get exactly one-third of all proceeds for any exit, with an exit diagram as shown in Exhibit 9-3.

As mentioned earlier, it is rare for a VC in the United States to accept common stock by itself. Outside the United States, this is not unusual.

Structure II would never happen anywhere in the world: no VCs would limit their upside completely by taking only RP. We include this case only as a building block for the other structures. With only RP, EBV would receive all proceeds up to \$5M, and then nothing after that. This implies an exit diagram as shown in Exhibit 9-4.

Structure III is the combination of Structures I and II, but we cannot just add the lines in Exhibits 9-3 and 9-4, because when RP and common coexist, the RP must be paid back first. This raises the question: how much of the \$5M investment was used to buy the RP, and how much was used to buy the common? Although the allocation of value between RP and common is arbitrary, it does determine the payoff to the Series A as a whole. In different cases, the allocation of purchase price can determine conversion rates and antidilution protections. We will return to these issues in Part III. For now, we assume that the whole

EXHIBIT 9-3

EXIT DIAGRAM FOR COMMON STOCK

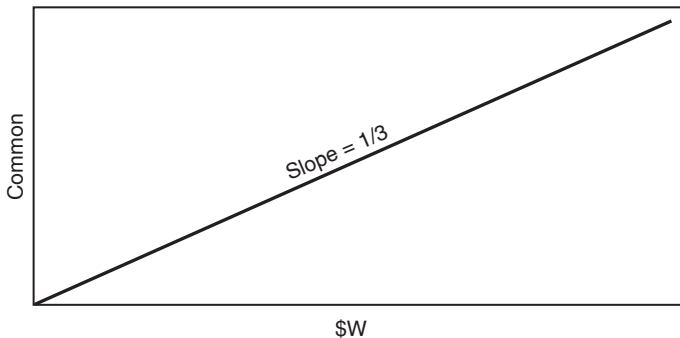
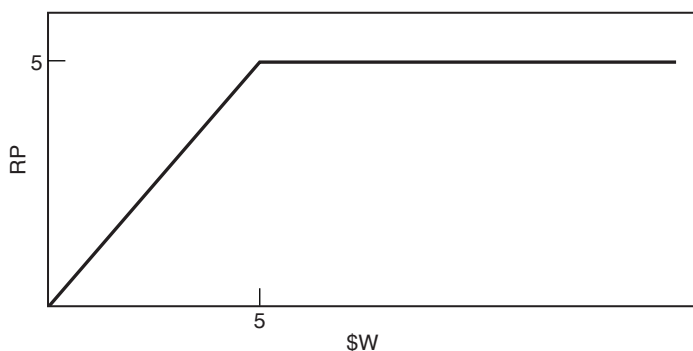

EXHIBIT 9-4

EXIT DIAGRAM FOR RP



\$5M purchase price is allocated to the RP ($APP = \$5M$), with the common “free”. This assumption eases comparisons of Structure III with the other structures. With this assumption, under Structure III, EBV would receive all proceeds until \$5M, and then one-third of whatever is left over. This gives us an exit diagram as shown in Exhibit 9-5.

Structure IV is a hybrid of Structures I and III with a cutoff at the QPO threshold. For exits below the QPO threshold, Structure IV looks like the RP plus common of Structure III, because EBV would be allowed to both redeem (for \$5M) and to participate in the upside as though it also had 5M of common stock. Above the QPO threshold, there would be automatic conversion, thus making the PCP look like the common stock of Structure I. The participation threshold here is five times the original investment, which occurs when the Series A is worth at least \$25M:

$$\frac{1}{3} * W = \$25M \rightarrow W = \$75M = \text{QPO threshold} \quad (9.4)$$

This implies an exit diagram as shown in Exhibit 9-6. Note that Exhibit 9-6 is just a hybrid of Exhibit 9-5 (below the $W = \$75M$ threshold) and Exhibit 9-3 (above the $W = \$75M$ threshold). At the $W = \$75M$ threshold, at the instant before conversion, this structure has a total value of $\$5M + \frac{1}{3} * (\$75M - \$5M) = \$28 \frac{1}{3}M$. Immediately after conversion, the value drops to \$25M. Hence, the diagram shows a drop of $\$28 \frac{1}{3}M - \$25M = \$10 \frac{1}{3}M$.

Structure V may seem similar to Structure IV, but in fact they are quite different. For Structure IV, automatic conversion occurs at the QPO of \$5 per share, which implies that $W_A = \$75M$. Although this automatic conversion might still be binding for Structure V, it is also possible that EBV would *choose* to convert the PCPC for a lower value of W . To analyze this voluntary conversion decision, we set up a conversion condition using a redemption value equal to the PCPC cap at four times the APP ($= \$20M$). We can visualize this conversion decision as an analogue of Exhibit 9-1.

We can write the corresponding conversion condition as

$$\text{(Voluntary) Conversion Condition: } \frac{1}{3} * W > 20 \rightarrow W_A = 60 \quad (9.5)$$

EXHIBIT 9-5

EXIT DIAGRAM FOR RP + COMMON

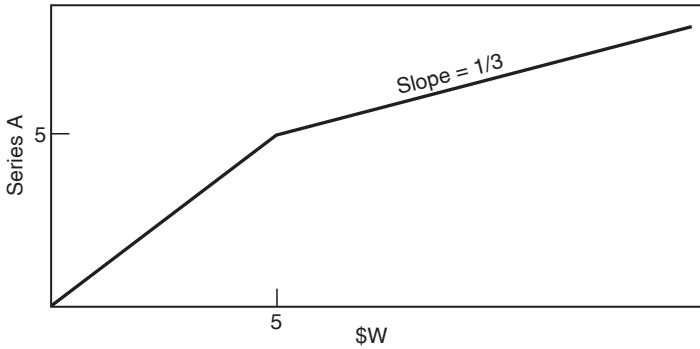
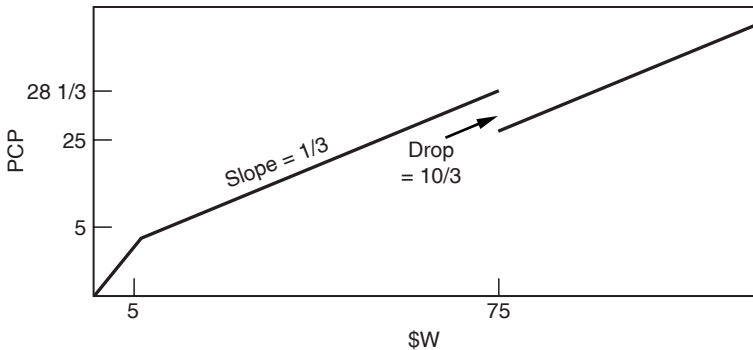

EXHIBIT 9-6

EXIT DIAGRAM FOR PCP



Because voluntary conversion would occur at $W = \$60M$, the automatic conversion at $\$75M$ is a redundant and nonbinding constraint.

For PCPC, the last step is to determine the level of proceeds W where the redemption value is capped, which we refer to as the *cap point*, and write as $W_A(\text{cap})$. At any exit above $\$5M$, Structure V would receive back the APP (= $\$5M$) plus one-third of any remaining proceeds. The cap occurs when this total reaches four times APP = $\$20M$:

$$\frac{1}{3} * (W - 5M) + 5M = 20M \rightarrow W_A(\text{cap}) = \$50M \tag{9.6}$$

EXHIBIT 9-7

VOLUNTARY CONVERSION FOR THE PCPC

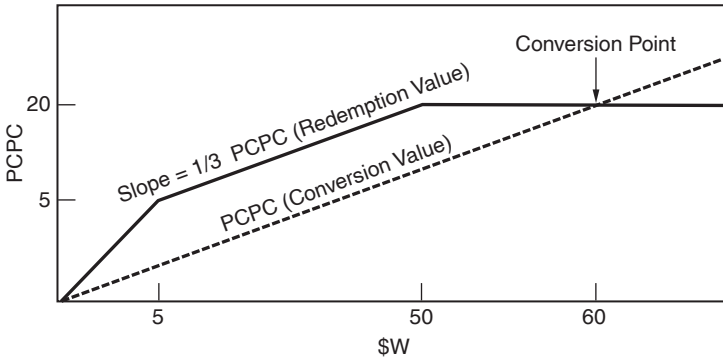
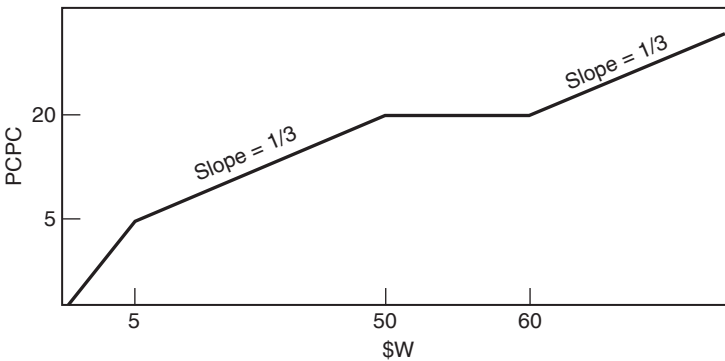

EXHIBIT 9-8

EXIT DIAGRAM FOR PCPC



The careful reader may have noticed this cap point labeled on the Y-axis of Exhibit 9-7. For exit proceeds above the cap at $W = \$50M$, the value line is flat until the conversion point at $W = \$60M$. Exhibit 9-8 gives the exit diagram.

In this example, the computation of the QPO threshold for PCP and PCPC is relatively straightforward. The computation becomes more complex when there are multiple rounds of investment. Readers do not have to worry about this until Chapter 16, but should consider themselves warned in advance!

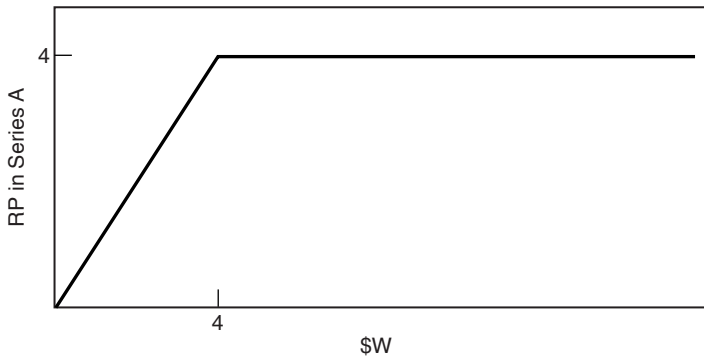
EXHIBIT 9-9**EXIT DIAGRAM FOR THE SERIES A RP**

Structure VI combines features of *Structure II* (RP) with the baseline CP from the Newco term sheet. In this example, there are two types of preferred stock, CP and RP, and there is no statement about which version would be paid first in a liquidation (term sheets often omit such information). Because EBV owns all of both the CP and the RP, this liquidity preference between the two is not relevant for the aggregate value of the Series A; for simplicity of exposition, we treat the RP as superior to the CP.

To draw the exit diagram, we will first draw the RP and CP separately. Because we have assumed that the RP has a liquidation preference to the CP, we can draw the exit diagram for the RP as shown in Exhibit 9-9.

Next, we look at the CP. The CP here is similar to the CP in baseline case, with some added twists. First, because the RP is paid first, the CP has no value unless the proceeds are above \$4M. Second, because the APP of the 5M shares is only \$1M, the conversion condition will come sooner. This conversion condition is as follows:

$$\frac{1}{3} * (W - 4) > 1 \rightarrow W_A = 7. \quad (9.7)$$

Next, the exit diagram for the CP is shown in Exhibit 9-10.

The exit diagram for *Structure VI* is the combination of Exhibits 9-9 and 9-10.

(b) We next solve for the exit value of each structure for all six structures plus the original CP structure from the Newco charter in Chapter 8. We use the following cases: \$3M, \$8M, \$32M, \$72M, and \$96M. Using the diagrams and reasoning from part (a) and Exhibit 9-2, we have the results shown in Exhibit 9-12.

Structure I always receives one-third of all proceeds. *Structure II* gets all proceeds up to \$5M but nothing more. *Structure III* does at least as well as other structures in all cases, receiving all proceeds up to \$5M and then one-third of everything that is left over. *Structure IV* and *Structure V* are identical except for the $W = 72$ case, where *Structure IV* (PCP) still looks like *Structure III* (RP + common), but *Structure V* has converted and looks like

EXHIBIT 9-10

EXIT DIAGRAM FOR THE SERIES A CP

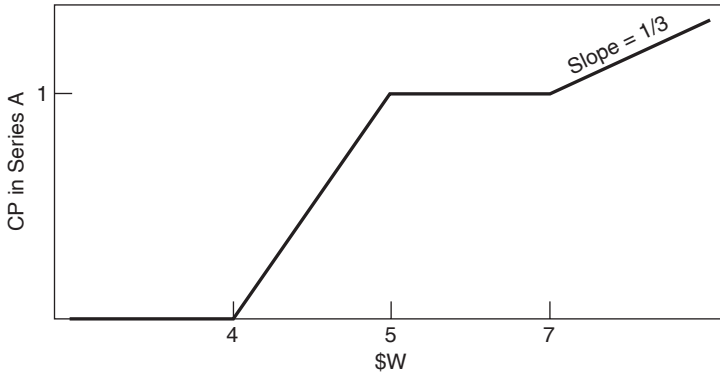
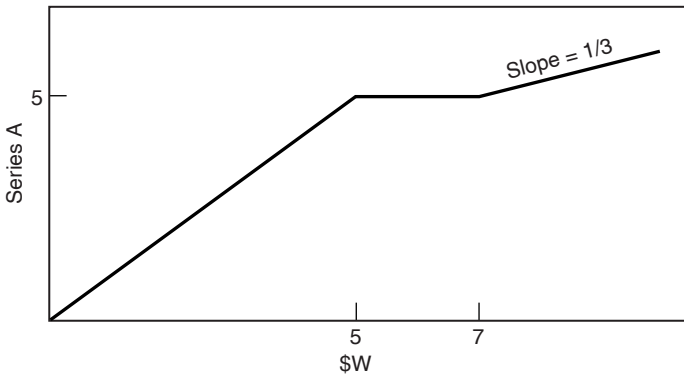

EXHIBIT 9-11

EXIT DIAGRAM FOR RP + CP



Structure I. At first glance, one might think that Structure VI would provide a higher payoff than the RP + common combination of Structure III, but the exhibit shows this is not the case. The reason is that once the CP converts, there is only \$4M of APP paid for the RP (not \$5M as in Structure III). Finally, the *original CP structure* from the charter is a hybrid

EXHIBIT 9-12**EXIT PROCEEDS UNDER ALL STRUCTURES**

		Structure						(charter)
		I	II	III	IV	V	VI	CP
	$W = 3$	1	3	3	3	3	3	3
	$W = 8$	2.7	5	6	6	6	5.3	5
Exit	$W = 32$	10.7	5	14	14	14	13.3	10.7
	$W = 72$	24	5	27.3	27.3	24	26.7	24
	$W = 96$	32	5	35.3	32	32	34.7	32

between structures I and II: it looks like Structure II (RP) for $W = 3$ and $W = 8$, but looks like Structure I (common stock) in all other cases. ■

9.2 ANTIDILUTION PROVISIONS

The Newco charter of Chapter 8 gave EBV a form of antidilution protection that applies in the case of a down round. The two forms of antidilution protection are **full-ratchet** and **weighted-average**. The language in the Newco term sheet of Chapter 8 is

In the event that the Company issues additional securities at a purchase price less than the current Series A Preferred conversion price, such conversion price shall be reduced to the price at which the new shares are issued.

This language corresponds with full-ratchet protection, which the *Dow Jones Report* finds for 20 percent of all deals that have any antidilution protection. With full-ratchet adjustment, the Series A **adjusted conversion price** would be set to the lowest conversion price of any later stock sale, and the **adjusted conversion rate** would then be calculated as OPP divided by adjusted conversion price. To illustrate how this would work, consider our Series A round of \$5 million of convertible preferred stock at an OPP of \$1 per share. Now, assume that one year later there is a Series B round for \$5 million with a price of \$0.50 per share, for 10M shares. Given full-ratchet protection, the Series B price of \$0.50 would cause an adjusted conversion price of \$0.50 for Series A. The adjusted conversion rate of the Series A stock would then be $\$1/\$0.50 = 2$. In fact, this same calculation would occur even if the down round were only for a *single share*.

Alternatively, in a weighted-average antidilution protection, the Series A investors would obtain an adjusted conversion price that depends on the size of the current and past rounds. The exact adjustments depend on whether the formula is

broad-base or **narrow-base**. The NVCA model term sheet in Appendix A gives the formula for the broad-base weighted average as

$$CP_2 = \text{adjusted conversion price} = CP_1 * (A + B)/(A + C) \quad (9.8)$$

where

CP_2 = Series A Conversion Price in effect immediately after new issue

CP_1 = Series A Conversion Price in effect immediately prior to new issue

A = Number of shares of Common Stock deemed to be outstanding immediately prior to new issue (includes all shares of outstanding common stock, all shares of outstanding preferred stock on an as-converted basis, and all outstanding options on an as-exercised basis; does not include any convertible securities from this round of financing)

B = Aggregate consideration received by the Corporation with respect to the new issue divided by CP_1

C = Number of shares of stock issued in the subject transaction

For our example, we have $CP_1 = \$1$, $A = 15M$, $B = \$5M/\$1 = 5M$, and $C = 10M$. Thus, we have

$$CP_2 \text{ (broad base)} = \$1 * (15M + 5M)/(15M + 10M) = \$0.80 \quad (9.9)$$

In a narrow-base weighted-average formula, everything is the same except for the definition of A :

A (narrow-base) = Number of shares of Common Stock deemed to be outstanding immediately prior to new issue (including all shares of outstanding preferred stock on an as-converted basis, but *excluding* all shares of outstanding common stock and all outstanding options on an as-exercised basis; does not include any convertible securities from this round of financing).

With this change, the narrow-base case for our example gives $A = 5M$, so

$$CP_2 \text{ (narrow base)} = \$1 * (5M + 5M)/(5M + 10M) = \$0.67 \quad (9.10)$$

The *Dow Jones Report* tells us that a weighted-average formula is used in 80 percent of all antidilution provisions; of these weighted-average cases, broad-based formulas are common, and narrow-based formulas are rarely used.

EXAMPLE 9.2

Suppose EBV makes a \$6M Series A investment in Newco for 1M shares at \$6 per share. One year later, Newco has fallen on hard times and receives a \$6M Series B financing from Talltree for 6M shares at \$1 per share. The founders and the stock pool have claims on 3M shares of common stock. Going forward, for brevity we will use the term “employees” to mean “founders and the stock pool”.

Problems

Consider the following cases:

Case I: Series A has no antidilution protection.

Case II: Series A has full-ratchet antidilution protection.

Case III: Series A has broad-base weighted-average antidilution protection.

Case IV: Series A has narrow-base weighted-average antidilution protection.

For each of these cases, what percentage of Newco (fully diluted) would be controlled by EBV following the Series B investment? What would be the post-money and pre-money valuations?

Solutions *Case I:* Without any antidilution protection, EBV has 1M shares out of a fully diluted share count of 1M + 6M (Series B) + 3M employees = 10M. Thus, they would control 10 percent. The Series B investors paid \$1 per share, so the post-money valuation would be 10M * \$1 = \$10M, and the pre-money valuation would be \$10M - \$6M = \$4M.

Case II: With full-ratchet antidilution protection, the Series A adjusted conversion price would become \$1 (the price of the Series B), and EBV would control 6M shares of a fully diluted share count of 6M + 6M + 3M = 15M for 40 percent. The postmoney valuation would be 15M * \$1 = \$15M, and the premoney valuation would be \$15M - \$6M = \$9M.

Case III: With broad-base weighted-average antidilution protection, we can use Equation (9.8) to compute the adjusted conversion price. Using the definitions for this equation, we have $A = 1M + 3M = 4M$, $B = \$6M/\$6 = 1M$, and $C = 6M$. Substituting into (9.8) yields

$$CP_2 (\text{broad base}) = \$6 * (4M + 1M)/(4M + 6M) = \$3. \quad (9.11)$$

Therefore, EBV would control \$6M/ \$3 = 2M shares of a total of 2M + 6M + 3M = 11M for 22.2 percent of the company. The postmoney valuation would be 11M * \$1 = \$11M, and the premoney valuation would be \$11M - \$6M = \$5M.

Case IV: With narrow-base, weighted-average antidilution protection, we must adjust our definition of A in Equation (9.8) to omit the 3M shares held by employees, so $A = 1M$. We then substitute this new A into Equation (9.8) to obtain

$$CP_2 (\text{narrow base}) = \$6 * (1M + 1M)/(1M + 6M) = \$1.71. \quad (9.12)$$

With this conversion price, EBV obtains approximately 6M/\$1.71 = 3.5M shares, yielding it 28 percent of the 3.5M + 6M + 3M = 12.5M total shares. The postmoney valuation would be 12.5M * \$1 = \$12.5M, and the premoney valuation would be \$12.5M - \$6M = \$6.5M. ■

In the cases with antidilution protection, if we were to build a cap table, the number of premoney shares is ambiguous. Some VCs might write the table with the premoney shares given before the antidilution correction, while others would write these shares after the correction. Either way is reasonable. However, it would definitely be incorrect in Cases II, III, and IV to compute the premoney valuation as \$1 * 6M premoney shares = \$6M. In these cases, the only correct way to compute premoney valuation is postmoney valuation minus \$investment, as shown in the solution.

REALITY CHECK: Antidilution protection provides more protection on paper than in practice. According to an earlier edition of the *Dow Jones Report* (where they ask this question), VCs are forced to waive their antidilution protection in about 64 percent of the applicable down rounds. Furthermore, it is likely that in the remaining 36 percent of cases, the protections do not work nearly as strongly as the contractual language would suggest. What is going on here?

Basically, antidilution protections are useful only when the protected party is willing to walk away from the deal. If a company is performing poorly and a VC wants to liquidate but the majority shareholders want to do another round of financing, then the antidilution protection can prove useful. In the majority of cases, however, the VC wants the new financing and has little leverage to maintain the protections. If a company needs financing to survive, and the real value of the company has fallen since the previous round, then most new investors will insist that the previous investors waive their antidilution rights. Additionally, triggering the protection would further dilute the incentives of founders and employees, which the VC also has to take into account.

Consider the full-ratchet case (Case II) from Example 9.2. If this provision is allowed to stand, then the new investor (Talltree) would receive only 40 percent of Newco for its \$6M. If Talltree expects to get 60 percent of the firm for its \$6M and EBV refuses to waive its antidilution rights, then Talltree can simply walk away. Thus, the antidilution rights do give EBV a seat at the negotiation table, and it may be able to extract some value—perhaps a small adjustment to its conversion price—but antidilution rights are simply one of many bargaining chips that EBV can use to try to get a better deal.

SUMMARY

VCs use preferred stock in most transactions. There are four main types of preferred stock. Redeemable preferred (RP) stock is a bondlike security that is senior to common stock but cannot be converted to common stock. No VC would ever accept RP by itself, but would instead combine it with common stock or another type of preferred stock. Convertible preferred (CP) stock provides the same downside protection as RP with the additional option of converting to common stock. Participating convertible preferred (PCP) stock provides its holder with a combination of the downside protection of RP and the upside potential of CP, with the caveat that the redeemable rights go away upon a qualified public offering. Sometimes the liquidation return to PCP is capped at some preset multiple of the purchase price: We refer to such securities as participating convertible preferred with cap (PCPC) stock.

VCs often receive antidilution protection on their preferred stock. Such protection provides the holder with the right to adjust the conversion price of their preferred in the event of a down round. In theory, such protection gives a VC claims on additional shares in the event of a down round. In practice, investors in struggling companies are usually forced to give up these rights to secure a new round of investment. Nevertheless, it is important to learn how these protections work, if only to know the relative bargaining positions for various investors.

KEY TERMS

<i>Conversion condition,</i> <i>Conversion point</i> = W_A	Participating convertible preferred with cap (PCPC)	Adjusted conversion price, adjusted conversion rate
Common stock, preferred stock	<i>Cap point</i> = W_A (<i>cap</i>)	Broad-base formula, narrow-base formula
Convertible preferred (CP)	Exit diagram	
Redeemable preferred (RP)	Full-ratchet antidilution,	
Participating convertible preferred (PCP)	weighted-average antidilution	

REFERENCE

Dow Jones, 2009, *Venture Capital Deal Terms Report*, 6th Edition, Dow Jones, Jersey City, NJ.

EXERCISES

9.1 Suppose that it is one year after EBV's investment in Newco (using the CP structure from Exercise 8.2), and Talltree makes a Series B investment for 6M shares of Newco at \$0.2 per share. Following the Series B investment, what percentage of Newco (fully diluted) would be controlled by EBV? Consider the following cases:

- Case I: Series A has no antidilution protection.
- Case II: Series A has full-ratchet antidilution protection.
- Case III: Series A has broad-base weighted-average antidilution protection.
- Case IV: Series A has narrow-base weighted-average antidilution protection.

9.2 Suppose that EBV decides to consider six possible structures for the Series A stock in Exercise 8.2:

- Structure I: The original structure considered in Exercise 8.2: 6M shares of CP.
- Structure II: 6M shares of common.
- Structure III: RP + 6M shares of common.
- Structure IV: PCP with participation as-if 6M shares of common.
- Structure V: PCPC with participation as-if 6M shares of common, with liquidation return capped at 5 times OPP.
- Structure VI: RP (\$4M APP) + 5M shares of CP (\$2M APP).

Structures IV and V have mandatory conversion upon a QPO, where a QPO is any offering of at least \$5 per common share and \$15M of proceeds. For the purpose of solving this problem, assume that *any exit* above \$5 per share will qualify as a QPO (i.e., acquisitions for at least \$5 per common share would also be considered to be QPOs).

Draw an exit diagram for each structure.

THE VC METHOD

THIS CHAPTER INTRODUCES concepts and mechanics for the VC method, the most common valuation strategy used by venture capitalists. What we call “the VC method” refers to a wide range of different implementations, all of which share four common elements. These four elements are discussed in Section 10.1. In Section 10.2 we discuss and illustrate one specific implementation, which we call the *standard VC method*. This standard method does not account for management fees or carried interest, so in Section 10.3 we introduce a *modified VC method* to handle these costs.

10.1 THE VC METHOD: INTRODUCTION

There are many different ways to implement the VC method. All these implementations share four main elements, and the main differences among implementations are the exact set of steps and ordering of steps. These four main elements are as follows:

1. An estimate of an **exit valuation** for the company. The exit valuation is forward-looking and represents the expected value of the company at the time of a **successful exit**, where a successful exit is considered to be an IPO or equivalent valued sale. This part of the VC method is discussed in Section 10.1.1, with more detail in Chapters 11 and 12.
2. An estimate of the VC’s **target multiple of money** in a successful exit. Such multiples may be stated directly (“we look for investments that can earn 5 times our money in five years”) or may be built up from an annual **target return** for the IRR of a successful exit. This part of the VC method is discussed in Section 10.1.2 and is based in part on the analysis from Chapter 4.
3. An estimate of the **expected retention percentage** between the current investment and a successful exit. New shares must be issued when the current investment plus the future cash flows of the company are insufficient to fund the growth necessary for a successful exit. Although the current VC may participate in the future rounds of investment, we still want to know

about the reduction to the proposed ownership percentage for the current investment. For the purposes of the VC method, we view each round as a stand-alone investment. Retention is discussed in Section 10.1.3.

4. The investment recommendation, where the **required investment** is compared to the proposed ownership percentage of the **total valuation**. Total valuation is defined as the exit valuation, multiplied by the expected retention percentage and divided by the target multiple of money. In most implementations of the VC method, the investor does not explicitly account for management fees and carried interest when making the investment recommendation. An example of this standard approach is given in Section 10.2. In Section 10.3, we show how to modify the standard method to include management fees and carried interest.

10.1.1 Exit Valuation

A wide range of techniques is employed for the estimation of exit value. In each case, the focus is on the value of company at the time of a successful exit. The reason to focus on a successful exit is obvious—that is where the vast majority of the profits will be made. The definition of a successful exit is less obvious. It is perhaps easiest to talk about what a successful exit does *not* mean. It does not mean “everything went perfectly, growth hit the entrepreneur’s most optimistic projections, and we are all going to be rich beyond our wildest dreams”. It would be wrong to focus attention on such rare outcomes, because a lot of the expected value of the company is contained in more modest successes—and because by ignoring such cases, we would not end up with a good estimate for the total valuation. Conversely, successful exit does not mean “anything except liquidation”. Many VC-backed companies end up being acquired with very little money going to the shareholders. A central idea of the VC method is to ignore these lesser payoffs and focus attention on the places where the payoffs are significant.

What does “successful exit” mean? The best working definition is probably “an IPO or competitive sale”, where a competitive sale means “we could have done an IPO, but the sale was better”. For companies where an IPO is unrealistic from the outset—perhaps because the potential market is more limited—then a competitive sale should mean “acquisition with more than one interested party, in a situation where we did not have to sell”. In general, we are trying to work through the case where the business has achieved some major milestones.

Once we have a notion of success in mind, we need to estimate the value of the company conditional on this success. The two main approaches are **relative valuation** and **absolute valuation**. In relative valuation, we find a set of current companies that are comparable to our company at the time of its (hypothetical) successful exit. Comparability is usually established based on similarities in industry and growth potential. We then compute various valuation ratios for these companies, usually based on multiples of market value to some accounting measure. There is no hard rule

about the best multiple to use—choices are usually governed by industry standards, where the guiding principle is to use multiples that are the most consistent across companies. Relative valuation methods are covered in Chapter 12.

Although relative valuation uses the market's opinion of comparable companies to value the baseline company, absolute valuation reflects the analyst's opinion by using a discounted cash flow (DCF) model. This DCF analysis can use a variety of specific techniques, but the underlying idea is to determine the value of the company by forecasting future cash flows and discounting them back at some appropriate discount rate. Absolute valuation methods are neither better nor worse than relative valuation methods; both have their strengths and weaknesses, and careful analysts should do both. Although we will focus (in Chapter 11) on the use of DCF models for exit valuation, they can also be used as the main method of total valuation, particularly for later-stage investments.

In addition to the two main methods of relative valuation and absolute valuation, a third shortcut method may be used to obtain quick inputs for the VC method. In this shortcut—which we use in the following examples—the analyst simply uses the average valuation for successful exits in the same industry. For example, for an investment in the telecommunications industry, suppose that IPOs in the previous few years have had an average valuation of \$300M. Then the analyst could assume \$300M as the exit valuation, and the main valuation task becomes to estimate the probability of an IPO.

10.1.2 Target Returns

Exit valuations are estimates of company value at some time in the future. To convert this value to today's dollars, we need an appropriate discount rate, which we call the target return. In Chapter 4, we showed how to estimate the cost of VC by using historical data and a factor model regression. It is important to note, however, that the target return is not the same thing as the cost of VC. Our estimate of 15 percent for the cost of VC is appropriate for the *typical* VC investment. When VCs discuss target returns, they are referring to *successful* investments. In a VC method valuation, only the successful cases are considered, with unsuccessful failure cases given an effective value of 0. Let p represent the probability of success. Then, the expected value at exit is

$$\text{Expected value at exit} = \text{exit valuation} * p. \quad (10.1)$$

If this exit is expected in T years with no further rounds of investment, then the present discounted value for this exit is

$$\text{Present discounted value of exit} = \text{exit valuation} * p / (1 + r_{vc})^T \quad (10.2)$$

where r_{vc} is the cost of venture capital. In Equation 10.2, the expression $p / (1 + r_{vc})^T$ represents the effective discount factor for the exit valuation; we call the inverse of this discount factor the target multiple of money and denote it as M . We can also

convert the target multiple of money to an annual target return, which is implicitly computed as:

$$p/(1 + r_{vc})^T = 1/M = 1/(1 + \text{Target Return})^T \quad (10.3)$$

Exhibit 10-1 shows output from the worksheet, *TARGET*, from the *VC_method.xls* spreadsheet. The worksheet uses Equations (10.2) and (10.3) to relate inputs for the cost of venture capital into a matrix of outputs relating the target return and target multiple of money with the probability of success and the time to successful exit. For example, if time to exit is five years and the probability of a successful exit is 20 percent, then we can look in the corresponding cell and find a target multiple of money of 10.1 (calculated from Equation (10.2)), and a target return of 59 percent per year (calculated from Equation (10.3)).

It might seem as though all these steps require significant guesswork. Although guesses are certainly required, there are many ways to provide structure for these guesses using personal experience and historical data. In the exercises at the end of this chapter, you are asked to use the data from Chapter 7 to evaluate some specific probability assumptions. More generally, however, the estimate of p is where a VC must use his experience and judgment. What appears to be a wild guess to the untrained eye can in fact be the exercise of hard-won intuition. For

EXHIBIT 10-1

TARGET RETURNS AND TARGET MULTIPLES OF MONEY

Cost of capital for VC 15.0%

Table of "Target Return" (top cell) and "Target Multiple-of-Money" [M] (bottom cell)

		Probability of successful exit (p)						
		10.0%	20.0%	25.0%	30.0%	35.0%	40.0%	50.0%
Years To Exit = T	2	264%	157%	130%	110%	94%	82%	63%
		13.2	6.6	5.3	4.4	3.8	3.3	2.6
	3	148%	97%	83%	72%	63%	56%	45%
		15.2	7.6	6.1	5.1	4.3	3.8	3.0
	4	105%	72%	63%	55%	50%	45%	37%
		17.5	8.7	7.0	5.8	5.0	4.4	3.5
	5	82%	59%	52%	46%	42%	38%	32%
		20.1	10.1	8.0	6.7	5.7	5.0	4.0
	6	69%	50%	45%	41%	37%	34%	29%
		23.1	11.6	9.3	7.7	6.6	5.8	4.6
	7	60%	45%	40%	37%	34%	31%	27%
		26.6	13.3	10.6	8.9	7.6	6.7	5.3

example, many basketball players can correctly assess whether their shots will go in the basket from the instant the shot leaves their hands. (And for shots that miss, they have a pretty good idea of where the rebound will go.) Talented scientists are adept at judging the success probability of an untried experiment. Champion poker players can estimate not only the mathematical odds of receiving any given card (that part is easy) but also whether other players are bluffing. All these skills combine some natural intuition with “data”, where the data may be drawn from daily experience or from past experiments.

10.1.3 Expected Retention

In the valuation of mature companies, a DCF analysis usually includes positive cash flows before the terminal date. In the VC method, the opposite is true: we must usually account for negative cash flows, which then require further rounds of investment and a reduction in the ownership percentage for previous investors. For example, if a VC purchases 5M of Newco’s 20M shares in a Series A investment, then a 5M Series B round will reduce the Series A stake from 25 percent to 20 percent. In that case, we would say that the Series A investors have a **retention percentage** of $0.20/0.25 = 80$ percent. Even if the same VC participates by purchasing 1.25M shares of the Series B—thus maintaining a 25 percent stake over the two rounds—the impact on the 5M share Series A investment remains the same. If we expect all future rounds to be made at a fair market price, then the identity of the Series B investor is irrelevant to the Series A investment decision, and it is necessary to account for future reductions when analyzing the Series A investment.

The mathematics of retention is straightforward, but the underlying assumptions—as always—require some educated guesswork. We start with the number of shares outstanding after the current round of investment. This share total should include all founders’ shares (including those not yet vested) and all employee options (including those not yet issued or vested). The reason to include nonvested and even nonissued options and shares is that we are focused on the valuation at a successful exit, and all these shares will certainly be issued, vested, and valuable at such a time. Here we follow the same rule as used for pre-money valuation (Chapter 8) and include the option pool in the computation of current shares outstanding.

The next step is to estimate the number of shares necessary to achieve a successful exit. This estimate should include all new shares issued at an IPO, assuming that a post-IPO valuation is used as a successful exit. The ratio of current shares to final (new + current) shares becomes our estimate of the expected retention. This estimation can be done by appealing to past experience, data on successful exits, and formal modeling.

We can make a first approximation for retention percentages by examining data in the Sand Hill Econometrics database. When we analyze the experience for all IPOs—a simple measure of “success”—we find that the average retention

for all first-round investments was about 50 percent, meaning that for every 10 percent of the company owned by a first-round investor, an average of 5 percent of the company was still owned by that investor after the IPO. Using the same data, we also find a retention percentage of about 60 percent for second-round investments, 67 percent for third-round investments, and 70 percent for investments in the fourth round or later. In this chapter, we will use these estimated percentages as our retention estimates. In practice, a VC can use specialized knowledge to adjust these averages for differences in industry, company stage, and market conditions.

10.1.4 The Investment Recommendation

The final step in any VC method is to make an investment recommendation. The investment recommendation is always based on a comparison of the investor's costs to his benefits. In the standard VC method (Section 10.2), the investor's costs are just the dollars invested, referred to simply as the required investment. To figure the investor's benefits (the value of his stake in the company), we first need to calculate the total valuation of the company. This total valuation is effectively the present discounted value of the exit valuation, with an additional adjustment for the retention percentage.

The total valuation gives us a valuation for the whole firm today, but of course the investor does not own the whole firm. Instead, we need to know the **partial valuation** for the fraction of the company claimed by the investor. In Part III we develop option-pricing tools that allow us to compute this partial valuation for a range of possible securities and contractual provisions. In this part of the book, we focus our attention on total valuation and make a simple approximation that partial valuation is equal to total valuation multiplied by the proposed ownership percentage. In the standard VC method (Section 10.2), the investment recommendation is based on a comparison of investor costs (the required investment) with investor benefits (partial valuation). In the modified VC method (Section 10.3), we first add management fees to the investor's costs and then subtract expected carried interest from the investor's benefits before making the investment recommendation.

We refer to this final element in the VC method as an "investment recommendation" rather than "investment decision" to emphasize that the calculations are best used as an input into decision making, and not as a final answer. Valuation is not an exact science even in the best of conditions; therefore we do not want to rely too heavily on the conclusions. Nevertheless, the investment recommendation step is a crucial reality check, and it should not be ignored. Great investments often look great from all angles, whereas poor investments will give themselves away somewhere. The prudent investor must be alert to the warning signs. A complete VC method provides outputs based on a range of possible input values so that the investor can understand the sensitivity of the recommendations to different assumptions.

10.2 THE STANDARD VC METHOD

In this section we discuss the most common VC method, which we call the **standard VC method**. There are many different ways this standard method can be implemented—our version is just one example. After we do an example using this method, we will discuss several possible variations that can be seen in practice. For all examples in this chapter, we will assume that the VC is purchasing convertible preferred stock, and all statements about ownership percentages will be under the assumption that all preferred stock has been converted to common shares.

Our standard VC method has eight steps:

Step 1: What is the required investment today? ($= \$I$)

Step 2: What is the exit valuation for this company? ($\$ \textit{exit valuation}$)

Step 3: What is the target multiple of money on our investment? (M)

Step 4: What is the expected retention percentage? ($\textit{retention}$)

Step 5: Estimate the total valuation for the company today:

$$\textit{Total valuation} = \$ \textit{exit valuation} * \textit{retention} / M \quad (10.4)$$

Step 6: What is the proposed ownership percentage today? ($\textit{proposed \%}$)

Step 7: Estimate the partial valuation for this investment:

$$\textit{Partial valuation} = \textit{proposed \%} * \textit{total valuation}. \quad (10.5)$$

Step 8: Investment Recommendation: Compare partial valuation to required investment.

EXAMPLE 10.1

EBV is considering a \$6M Series A investment in Newco. EBV proposes to structure the investment as 5M shares of convertible preferred stock. The founders of Newco, who will continue with the firm, currently hold 10M shares of common stock. Thus, following the Series A investment, Newco will have 10M common shares outstanding and would have 15M shares outstanding upon conversion of the CP. EBV estimates a 30 percent probability for a successful exit, with an expected exit time in five years.

Problem What is your investment recommendation?

Solution To answer this question, we perform each step of the standard VC method:

Step 1: The required investment $= \$I = \$6M$.

Step 2: For the exit valuation, we will just do a basic estimate for this example. Let's suppose that the 30 percent success probability refers to an IPO exit, and that the average IPO exit in Newco's industry is at a valuation of \$300M. For now, we will use \$300M as

our estimate of the exit valuation. (In Chapters 11 and 12, we study exit valuations in more detail.)

Step 3: With a cost of venture capital of 15 percent (as found in Chapter 4), a successful exit probability of 30 percent, and a successful exit time of five years, we can calculate the required multiple of money as

$$\text{Required multiple of money} = M = (1 + r_{vc})^T/p = 1.15^5/0.30 = 6.7. \quad (10.6)$$

Step 4: For expected retention, we use 50 percent, the average estimate from the SHE database for successful first rounds.

Step 5: Using the answers to Steps 2 to 4, we can estimate the total valuation as

$$\begin{aligned} \text{Total valuation} &= \text{exit valuation} * \text{retention}/M \\ &= \$300\text{M} * 0.50/6.7 = \$22.39\text{M}. \end{aligned} \quad (10.7)$$

Step 6: The proposed ownership percentage today is $5\text{M}/15\text{M} = 33.3\%$.

Step 7: The partial valuation is

$$\begin{aligned} \text{Partial valuation} &= \text{proposed \%} * \text{total valuation} \\ &= 0.333 * \$22.39\text{M} = \$7.46\text{M} \end{aligned} \quad (10.8)$$

Step 8: Because partial valuation (\$7.46M) is greater than the required investment (\$6M), the investment recommendation is positive. ■

This section has discussed one specific implementation of the VC method. There are many other ways that practitioners combine the four main elements of Section 10.1 into a VC method of valuation. In general, the main differences among implementations are in the ordering of the steps. For example, one popular implementation of the VC method is to leave the computation of the proposed ownership percentage until the last step.¹ This proposed ownership percentage then becomes a cutoff value for a good investment. Another variation is to leave the exit valuation until the last step—then the VC method produces a cutoff exit valuation for a good investment. All these alternative implementations will lead to the same investment recommendations if the same inputs are used.

10.3 THE MODIFIED VC METHOD

The modified VC method differs from the standard method in the explicit recognition of the costs of VC investing: management fees and carried interest. As discussed earlier in Section 10.1.2, the standard approach assumes (implicitly) that such costs are included in the target multiple of money. This assumption is not ideal

¹Lerner (2002) demonstrates an example of this implementation.

for two reasons. First, it mixes costs into the valuation step so that the total valuation may not be the same across different investors, even if these investors have the same expectations and value-added for the company. Second, it makes it difficult to be precise about target rates, because many different concepts are being included in one number. In this section we explain the mechanics for some simple adjustments for fees and carried interest.

In Chapter 2, we defined the lifetime fees as the sum of the annual management fees for the life of that fund, then the investment capital of the fund as equal to the committed capital of the fund minus the lifetime fees. For EBV, Appendix 2.A tells us that the fund has \$100M of committed capital, with 2 percent fees charged on this capital in each year. This implies lifetime fees of \$20M and investment capital of \$80M. Next, we add another definition: the **LP cost** of an investment represents the gross cost (including fees) of an investment to the LPs of the fund. We compute the LP cost for any investment as

$$\text{LP cost} = (\text{committed capital}/\text{investment capital}) * \$I \quad (10.9)$$

Thus, for the example of EBV, committed capital is \$100M and investment capital is \$80M, so the LP cost is $(100/80 * \$6M) = \$7.5M$. The idea behind this calculation is for the GPs to explicitly consider the true cost of each investment. Because a \$6M investment represents 7.5 percent of the \$80M of investment capital, the GP is effectively “spending” 7.5 percent of the lifetime fees on this investment as well. After all, if the GP fails to find enough good investments, he can always release the LPs from their commitments and proportionally reduce the management fees of the fund. In the postboom period, many VC firms did exactly that.

Some VCs object to the modeling of LP cost in this way. Often it seems that this objection is based on a belief that the management fees should be considered as “reasonable compensation” for the GP’s time and effort, and the GP should not make different investments just because of these fees. It is important to emphasize that our model of LP cost does not mean anything about the “reasonableness” of management fees. Rather, it just puts GPs on par with any other honest agent who is providing a service. For example, consumers frequently must decide whether to repair a broken item or to buy a new one. The cost of repairing that item is an important input into this decision; to estimate the cost of repair, one should certainly include the labor costs as one component. From an economic perspective, these labor costs are no different than the management fees paid to a GP.

A second modification to the standard VC method is a deduction for carried interest. The partial valuation of the investment does not belong entirely to the limited partners. If the overall VC fund is profitable, some of the proceeds from the investment will belong to the GPs of the VC fund, and the remainder will go to the LPs. Thus, in this step, we divide the partial valuation into two components, the **GP valuation** (= expected carried interest) and the **LP valuation** (= partial valuation – GP valuation). Then the investment recommendation is made by comparing LP valuation to LP cost.

Conceptually, it is straightforward to think of the GP valuation as representing the component of partial valuation that belongs to the GP. Mechanically, it is not so easy to estimate this component. The main problem is that carried interest in any one investment will depend on the profits (and losses) of all other investments made by the fund. Because some of these fund investments have not been made yet, it is not possible to get an exact solution for this problem. Instead, we attempt only a rough approximation for an entire fund, using the (expected) gross value multiple (GVM) of the fund as the key input. As first defined in Chapter 3 (Equation (3.15)), the GP% for a completed fund is

$$\begin{aligned} \text{GP\%} &= \text{carried interest} / \text{total distributions} \\ &= \text{Carry\%} * (\text{GVM} * \text{Investment Capital} - \text{Carry Basis}) \\ &\quad / (\text{GVM} * \text{Investment Capital}) \end{aligned} \quad (10.10)$$

To make Equation (10.10) operational for living funds, we replace the GVM in the equation with our best guess for the GVM for the fund. We call this guess the “expected” GVM. If an analyst has special information about any specific fund, then he can use this information in estimating the expected GVM for that fund. For the general cases studied in this book, we will use an expected GVM of 2.5, which is the approximate GVM found for the full set of investments in the SHE database. This GVM tends to differ by round (as shown in the exhibits in Chapter 7), but to keep things simple we will ignore these differences and just use 2.5 for all examples in this chapter.

The formula for GP% tells us what part of any investment effectively “belongs” to the GP. We can then use this GP% to estimate the GP valuation for any specific investment as

$$\text{GP valuation} = \text{GP\%} * \text{partial valuation} \quad (10.11)$$

and the LP valuation as

$$\begin{aligned} \text{LP valuation} &= \text{Partial valuation} - \text{GP valuation} \\ &= (1 - \text{GP\%}) * \text{partial valuation} \end{aligned} \quad (10.12)$$

With these definitions, we are ready to list the 11 steps in the modified VC method. The first 7 steps are the same as in the standard VC method. Steps 8, 9, and 10 are new steps where we calculate LP cost, GP valuation, and LP valuation, respectively. Step 11 is a revised version of the investment recommendation step.

Modified VC Method: 11 Steps

- Step 1:** What is the required investment today? ($= \$I$)
- Step 2:** What is the exit valuation for this company? ($\$ \text{exit valuation}$)
- Step 3:** What is the target multiple of money on our investment? (M)
- Step 4:** What is the expected retention percentage? (retention)

Step 5: Estimate the total valuation for the company today:

$$\text{Total valuation} = \$ \text{ exit valuation} * \text{retention}/M$$

Step 6: What is the proposed ownership percentage today? (*proposed %*)

Step 7: Estimate the partial valuation for this investment:

$$\text{Partial valuation} = \text{proposed \%} * \text{total valuation}$$

Step 8: Estimate the LP cost for the investment:

$$\text{LP cost} = (\text{committed capital}/\text{investment capital}) * \$I$$

Step 9: What is the expected GP% for this investment?

$$\text{GP\%} = \text{Carry\%} * (\text{GVM} * \text{Investment Capital} - \text{Carry Basis}) / (\text{GVM} * \text{Investment Capital})$$

Step 10: Estimate the LP valuation from this investment:

$$\text{LP valuation} = (1 - \text{GP\%}) * \text{partial valuation}$$

Step 11: Investment Recommendation: Compare LP valuation to LP cost.

EXAMPLE 10.2

Assume the same setup as Example 10.1, except now we will also perform the new Steps 8, 9, and 10 before making an investment recommendation in Step 11.

Problem What is your investment recommendation?

Solution Our starting points are the answers to Steps (1) through (7) in Example 10.1. Picking up where we left off, we go to Step 8 in the modified VC method:

Step 8: As discussed earlier, annual fees of 2% for 10 years imply lifetime fees of \$20M and investment capital of \$80M for this \$100M fund. Thus, we can compute the LP cost as

$$\text{LP Cost} = (100/80) * \$6M = \$7.5M \quad (10.13)$$

Step 9: Using a baseline estimate of 2.5 for the GVM, we have

$$\text{GP\%} = 0.20 * (2.5 * 80 - 100) / (2.5 * 80) = 0.10 \quad (10.14)$$

EXHIBIT 10-2**VC METHOD SPREADSHEET**

Standard and Modified VC Method	
Required Investment	\$6.00
Exit Valuation	\$300.00
Target Multiple of Money	6.7
Expected Retention	50.00%
Proposed Ownership Percentage	33.33%
Committed Capital	\$100
Lifetime Fees	\$20
Carry%	20.00%
Expected Gross Value Multiple	2.5
GP%	10.00%
Total Valuation	\$22.39
Partial Valuation	\$7.46
LP Cost	\$7.50
GP Valuation	\$0.75
LP Valuation	\$6.71
Standard VC Method Recommendation	Invest
Modified VC Method Recommendation	Do Not Invest

NOTE: All \$ in millions.

Step 10: In Example 10.1, we estimated a partial valuation of \$7.46M. Thus, the LP valuation is

$$\text{LP valuation} = (1 - 0.10) * 7.46\text{M} = \$6.71\text{M}. \quad (10.15)$$

Step 11: The investment recommendation is based on the comparison between LP valuation (\$6.71M) and LP cost (\$7.5M). We can see that the modifications made a big difference: The cost side went up by \$1.5M and the benefits (to LPs) fell by \$0.75M. Together, these two changes alter our baseline recommendation. Exhibit 10-2 shows the output for the *VC METHOD* worksheet, with results for both the standard and modified VC method for this example.

We should never rely on a single set of assumptions. In particular, the investment recommendation will often be sensitive to assumptions about the exit valuation and the success probability. A sensitivity analysis for these assumptions is given in Exhibit 10-3.

EXHIBIT 10-3**SENSITIVITY ANALYSIS**

Sensitivity of LP Valuation
(LP Cost = \$7.5M for all cases)
Positive investment recommendations given in **bold**

		probability of success (p)		
		0.2	0.3	0.4
	200	2.98	4.47	5.97
Exit valuation	300	4.47	6.71	8.95
	400	5.97	8.95	11.93

Let's do one more example of the modified method, this time from the beginning. ■

EXAMPLE 10.3

Assume that EBV invested in Newco at the terms in Example 10.1, and it is now one year later. Talltree is considering an \$8M Series B investment in Newco. Talltree proposes to structure the investment as 5M shares of CP. The employees of Newco have claims on 10M shares of common stock, and the previous venture investors (EBV) hold 5M shares of Series A CP. Thus, following the Series B investment, Newco will have 10M common shares outstanding and would have 20M shares outstanding upon conversion of all the CP. Talltree estimates a 50 percent probability for a successful exit, with an expected exit time in four years. The \$250M Talltree fund has annual fees of 2 percent for each of its 10 years of life and earns 20 percent carried interest on all profits.

Problem What is your investment recommendation?

Solution To answer this question, we perform each step of the modified VC method:

Step 1: The required investment = $SI = \$8M$.

Step 2: We will use the same basic approach as we did in Example 10.1 and use \$300M as our estimate of the exit valuation.

Step 3: With a cost of venture capital of 15%, a successful exit probability of 50%, and a successful exit time of 4 years, we can calculate the required multiple of money as

$$\text{Required multiple of money} = M = 1.154/0.50 = 3.5 \quad (10.16)$$

Step 4: For this example, we assume the sample average from the Sand Hill Econometrics data set for second round investments: $retention = 60\%$.

Step 5: Using the answers to Steps 2 to 4, we can estimate the total valuation as

$$\text{Total valuation} = \$300M * 0.60/3.5 = \$51.43M \quad (10.17)$$

Step 6: The proposed ownership percentage today is $5M / 20M = 25\%$

Step 7: The partial valuation is

$$\text{Partial valuation} = 51.43 * 0.25 = \$12.86M \quad (10.18)$$

Step 8: Annual fees of 2% for 10 years imply lifetime fees of \$50M for this \$250M fund. Thus, the investment capital is $\$250M - \$50M = \$200M$, and we can compute the LP cost as

$$\text{LP Cost} = (250/200) * \$8M = \$10M. \quad (10.19)$$

Step 9: Using a baseline estimate of 2.5 for the GVM, we have

$$GP\% = 0.20 * (2.5 * 200 - 250)/(2.5 * 200) = 0.10 \quad (10.20)$$

Step 10: The LP valuation is

$$\text{LP valuation} = (1 - 0.10) * 12.86M = \$11.58M. \quad (10.21)$$

Step 11: The investment recommendation is based on the comparison between LP valuation (\$11.58M) and LP cost (\$10.00M). Thus, the baseline recommendation is to invest. A sensitivity analysis for this recommendation is given in Exhibit 10-4.

EXHIBIT 10-4

SENSITIVITY ANALYSIS

Sensitivity of LP Valuation

(LP Cost = \$10 M for all cases)

Positive investment recommendations given in **bold**

		probability of success		
		0.4	0.5	0.6
Exit Valuation	200	6.17	7.72	9.26
	300	9.26	11.58	13.89
	400	12.35	15.44	18.52



SUMMARY

The VC method is the most popular valuation technique used by practicing venture capitalists. The key elements of this technique are (1) focusing on the value of the company at the time of a successful exit, (2) using of a high target return reflecting the significant probability of failure, (3) accounting for a reduction in the current ownership percentage because of later rounds of investment, and (4) an investment recommendation. There are many ways that these elements can be combined—the actual implementation of the VC method is often a matter of taste. In this chapter, we showed two possibilities. The standard VC method is an example of the most popular approach; the modified VC method adjusts the standard method to explicitly account for management fees and carried interest.

KEY TERMS

Exit valuation	Required investment	<i>LP cost</i>
Successful exit	<i>Total valuation</i>	<i>Partial valuation</i>
Target multiple of money, Target return	Relative valuation, Absolute valuation	<i>GP valuation</i> <i>LP valuation</i>
Expected retention percentage	<i>Standard VC method</i> <i>Modified VC method</i>	

REFERENCES

Lerner, Josh and John Willinge, 2002, *A Note on Valuation in Private Equity Settings*, HBS Background Note 297–050.

EXERCISES

10.1 Suppose that the following four funds—all with committed capital of \$100M—have combined to form a syndicate to invest in Newco:

- (I) ABC Fund, management fees of 2.5 percent per year of committed capital for all 10 years.
- (II) DEF Fund, management fees of 2.5 percent per year for the first 5 years, then decreasing by 25 basis points per year in each year from 6 to 10. All fees calculated based on committed capital.
- (III) UVW fund, management fees of 2.0 percent per year. During the first 5 years of the fund, these fees are charged based on committed capital. Beginning in year 6, the fees are charged based on net invested capital. UVW expects to be fully invested by the beginning of year 6, and also to have realized 25 percent of all investment capital by this time. In each of the subsequent 5 years, UVW expects to realize about 15 percent of all investment capital.
- (IV) XYZ fund, management fees of 2.0 percent per year of committed capital for all 10 years. The XYZ fund expects to make all exits very quickly and to reinvest capital back into new investments. The total amount of investments is limited to \$100M.

(a) Suppose that each fund in the syndicate invests \$5M in Newco. What is the LP cost for each fund?

(b) It is possible that all four funds could agree on all the assumptions to the VC method, but still disagree about the wisdom of making this investment. Explain the economic logic behind this possibility.

10.2 EBV is considering a \$5M Series A investment in Newco. EBV proposes to structure the investment as 6M shares of convertible preferred stock. The employees of Newco have claims on 10M shares of common stock. Thus, following the Series A investment, Newco will have 10M common shares outstanding and would have 16M shares outstanding on conversion of the CP. EBV estimates a 25 percent probability for a successful exit, with an expected exit time in 5 years and an exit valuation of \$500M. The \$100M EBV fund has annual fees of 2 percent for each of its 10 years of life and earns 20 percent carried interest on all profits.

(a) What is your investment recommendation for EBV? (Show all steps.)

(b) How sensitive is this recommendation to different assumptions about the exit valuation and the probability of success?

(c) Given the evidence described in Chapter 7, do you think that 25 percent is an aggressive assumption about the probability of success for a first-round investment?

10.3 Assume that EBV invested in Newco at the terms in Exercise 10.2, and it is now one year later. Talltree is considering a \$10M Series B investment in Newco. Talltree proposes to structure the investment as 8M shares of convertible preferred stock. The employees of Newco have claims on 10M shares of common stock, and the previous venture investors (EBV) hold 6M shares of Series A convertible preferred. Thus, following the Series B investment, Newco will have 10M common shares outstanding, and would have 24M shares outstanding on conversion of the CP. Talltree estimates a 40 percent probability for a successful exit, with an expected exit time in 4 years and an exit valuation of \$500M. The \$250M Talltree fund has annual fees of 2 percent for each of its 10 years of life and earns 20 percent carried interest on all profits.

(a) What is your investment recommendation for Talltree? (Show all steps.)

(b) How sensitive is this recommendation to different assumptions about the exit valuation and the probability of success?

(c) Given the evidence described in Chapter 7, do you think that 40 percent is an aggressive assumption about the probability of success for a second-round investment?

10.4 Assume that EBV and Talltree invested in Newco at the terms in Exercises 10.2 and 10.3, and it is now one year later. Owl is considering a \$20M Series C investment in Newco. Talltree proposes to structure the investment as 12M shares of convertible preferred stock. The employees of Newco have claims on 10M shares of common stock, and the previous venture investors hold 6M shares of Series A convertible preferred (EBV) and 8M shares of Series B Convertible Preferred (Talltree). Thus, following the Series C investment, Newco will have 10M common shares outstanding and would have 36M shares outstanding on conversion of the CP. Owl estimates a 50 percent probability for a successful exit, with an

expected exit time in three years, and an exit valuation of \$500M. The \$500M Owl fund has fees as given in Appendix 2.C in Chapter 2.

- (a) What is your investment recommendation for Owl? (Show all steps.)
- (b) How sensitive is this recommendation to different assumptions about the exit valuation and the probability of success?
- (c) Given the evidence described in Chapter 7, do you think that 50 percent is an aggressive assumption about the probability of success for a third-round investment?

DCF ANALYSIS OF GROWTH COMPANIES

THE EXIT VALUE is the most important input into the VC method. How should we estimate this value? There are two types of approaches: discounted cash flow (DCF) analysis (absolute valuation) and comparables analysis (relative valuation). The key idea of absolute valuation is to “make up your own mind” about the company. You can use all kinds of evidence to inform your decision, but ultimately you must take a stand on the various inputs necessary to value the business at a successful exit.

In Section 11.1, we provide a framework for our DCF analysis, breaking down the valuation problem into three distinct periods in the life cycle of a company: the venture period (which ends with the exit), a rapid-growth period (which immediately follows the exit), and a stable-growth period. Cash flow analysis is introduced in Section 11.2 with an explanation of the key formulas and an example DCF calculation. In Section 11.3, we focus on the transition from rapid to stable growth and the estimation of the value of the company at the time of this transition. This value, which we call a “graduation value”, is of particular importance for growth companies. In Section 11.4, we do a full DCF model for two companies and demonstrate how to use market data to inform the key drivers of the model. Many of the examples in this chapter use data from the *DCF.xls* spreadsheet included with the book.

The topics covered in Chapters 11 and 12 are worthy of an entire book. With these two chapters, we focus on key valuation concepts and their application to young growth companies. The general topics of absolute and relative valuation are covered in more depth in many other books, two of which stand out. The first, *Valuation* (Koller et al., 2005), is the most recent valuation book from McKinsey and Company. This book takes a managerial view toward valuation and value creation and develops the useful framework for the valuation of growth discussed in Section 11.3. The second book, *The Dark Side of Valuation* (Damodaran, 2009), is a specialized treatment of the valuation of growth companies (and other hard-to-value assets), written by a finance professor who is a prolific author of valuation

books. Professor Damodaran's website, <http://pages.stern.nyu.edu/~adamodar/>, is an excellent source for current data that can be used as inputs and comparisons for valuation problems.

11.1 DCF ANALYSIS: CONCEPTS

VC-backed companies go through many stages of development. In earlier chapters, we focused on the stages corresponding to rounds of VC investment; all these stages effectively occur during the “childhood” of a company. We refer to this childhood as the *venture period*. For a successful VC-backed company, an IPO exit marks the beginning of its adolescence, with a *rapid-growth period* still to come. Usually, it is only after many more years that the company will reach maturity and settle down to a *stable-growth period*. Exhibit 11-1 gives a schematic example of these periods, with some appropriate milestones. One of these milestones, which we call *graduation*, marks the transition from the rapid-growth period to the stable-growth period.

At time zero—the initial VC investment—we need to estimate an exit value for the end of the venture period. The venture period is T years long, where T typically varies between three and seven years. The exit value will be based on forecasts for the rapid-growth and stable-growth periods. Thus, in estimating the exit value, we are imagining the company T years into the future and trying to

EXHIBIT 11-1

PHASES OF GROWTH

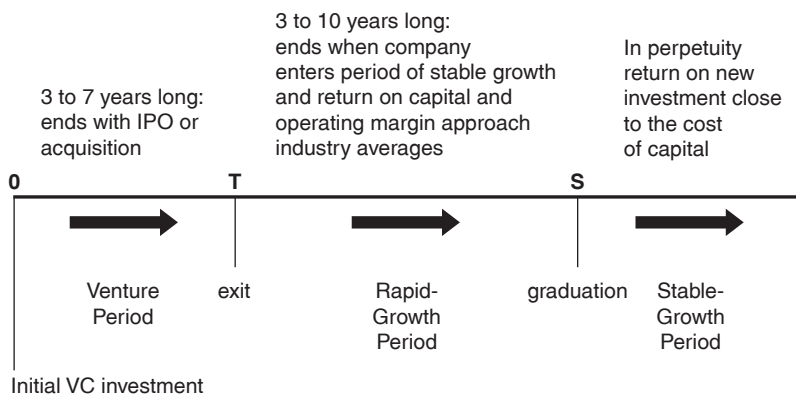

figure out how long rapid growth will be sustained from that point. Although this may seem to be a daunting exercise, even a cursory treatment can provide useful insights into the determinants of long-run success for the business and can also help investors to better understand the dynamics of a company's industry.

How can we estimate the typical length of a rapid-growth period? We can get some hints by looking at historical data. Exhibit 11-2 compares the revenue growth of newly listed public companies to that of their respective industries in the years following their IPOs.

The key variable in Exhibit 11-2 is the industry-adjusted revenue growth rate. To obtain this rate, we start by computing the revenue growth rate for each industry. Then, for each firm, we subtract the appropriate industry rate from the firm's growth rate.¹ We compute the "years since IPO" as the total number of years since the company first appeared in the S&P database, a comprehensive source of all firms that filed financial statements with the SEC. The middle line of Exhibit 11-2 shows the median industry-adjusted growth rate, the top line gives the 75th percentile, and the bottom line gives the 25th percentile. In the first full year after their IPO, firms

EXHIBIT 11-2

*REVENUE GROWTH COMPARED TO INDUSTRY AVERAGES,
PLOTTED AS A FUNCTION OF "YEARS SINCE IPO"*

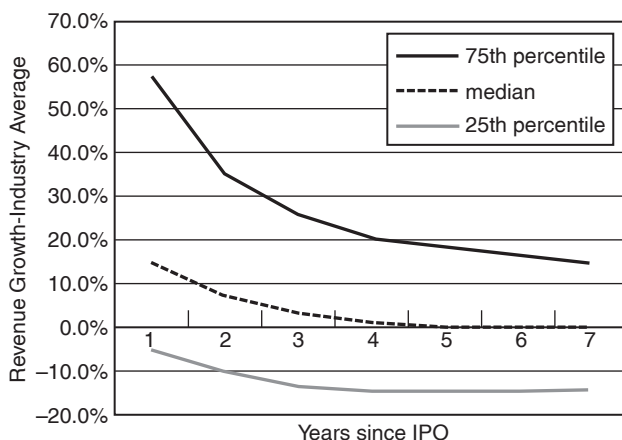

SOURCE: Wharton Research Data Systems (WRDS), S&P Compustat.

¹Industries are defined by the first three digits of the Standard Industrial Classification (SIC) code. These codes can be viewed at http://www.osha.gov/pls/imis/sic_manual.html.

grow much faster than their industry: in year 1, the median industry-adjusted growth rate is 14.7 percent, and the 75th percentile is 57.1 percent. By the fifth year after the IPO, however, this median is almost exactly 0; thus, as measured by revenue growth, we can say that the typical firm reaches “maturity” within five years after the IPO. Also, although some firms continue to grow faster than their industry average beyond year 5, the overall distribution of industry-adjusted growth rates is nearly symmetric around zero. This symmetry demonstrates that the five-year-old public firms are fairly representative of their industries.

Revenue growth at the industry average is not the only signal that a company has entered a stable-growth period. A good analyst should also consider the company’s return on capital (R) and operating margins. During the rapid-growth phase, we would expect a company to be earning R above the cost of capital (r), even if these returns are not expected to be realized until several years in the future. Furthermore, the rapid-growth phase is often characterized by operating margins lower than industry averages, as companies scale up their production and price aggressively to gain market share. In the stable-growth phase, both R and operating margins should settle down to industry averages.

11.2 DCF ANALYSIS: MECHANICS

DCF analysis is the gold standard of valuation. If done properly with accurate inputs—a big “if”—a DCF model will produce the “correct” valuation of a firm. For this reason, most investment bankers, financial analysts, and academics make DCF analysis a centerpiece of their valuation work. Although there are many different types of DCF models, the simple capital structure of most VC portfolio companies renders moot many of these differences, so we will be able to concentrate on the key concepts common to all types.

All DCF models have two key inputs: Discount rates (the “D” part) and cash flows (the “CF” part). Discount rates for venture capital were discussed at length in Chapter 4. In this chapter, we need discount rates for public companies, so the cost of venture capital is not directly applicable. There are several options for estimating discount rates for public companies. The simplest option—used in this chapter—is to just use the average cost of capital for the company’s industry. The *Industry Statistics* worksheet of the *DCF.xls* spreadsheet provides this data for 100 different industries. A more complex alternative is to use a smaller group of comparable companies. This alternative will be discussed in Chapter 12.

We focus most of this section on the computation of cash flow. The concept of cash flow is designed to pierce the accounting veil used for financial reporting and taxes so that we are left with the cash that is actually generated by the business. Also, we want to compute the cash flows generated by all the assets of the firm, irrespective of the types of claims (equity, debt, preferred stock), on those assets.

To do this, we abstract from the actual capital structure and assume that the firm is all-equity financed. Indeed, the assumption of all-equity financing is very reasonable for VC-backed companies. Exhibit 11-3 shows the mean and median percentage of debt in the capital structure of VC-backed companies in each of the 15 years subsequent to their IPOs. For each firm, we compute the **enterprise value** as the market value of equity plus the book value of debt and then compute the percentage of debt in this enterprise value:

EXHIBIT 11-3

LEVERAGE OF VC-BACKED FIRMS

Years Since IPO	Mean	Median
0	4.7%	1.2%
1	4.0%	1.9%
2	5.7%	2.8%
3	6.8%	3.8%
4	7.2%	3.9%
5	8.1%	4.4%
6	8.2%	5.1%
7	11.1%	6.0%
8	8.7%	5.6%
9	10.6%	6.2%
10	11.0%	6.0%
11	11.8%	6.4%
12	12.4%	8.9%
13	11.0%	7.8%
14	7.7%	4.8%
15	11.0%	6.4%

SOURCE: Michael Roberts, Wharton.

We see from these data that even 15 years after their IPOs, VC-backed firms still have only a mean debt percentage of 11.0 and a median percentage of 6.4. During the rapid-growth phase in the first few years after the IPOs of these firms, their percentages are even lower. Thus, we conclude that the simplifying assumption of all-equity financing is close to the truth for the vast majority of VC-backed firms.

Throughout our analysis, we analyze only **operating** assets, income, and expenses. Nonoperating assets would include excess cash, marketable securities, or

anything else that is unrelated to the revenue-producing business of the company. Nonoperating assets can comprise a significant fraction of the asset base of mature companies, and disentangling operating from nonoperating assets can require deep analysis of accounting statements. In this instance, we are fortunate to be analyzing companies with short histories, so both the capital structure and asset base are relatively simple, and we can focus our attention on the operating side of the business.

For a company with only operating assets, the standard definition of cash flow is

$$CF = EBIT(1 - t) + \text{depreciation} + \text{amortization} \\ - \text{capital expenditures} - \Delta NWC \quad (11.1)$$

where

CF = cash flow,

EBIT = earnings before interest and taxes,

t = the corporate tax rate, and

$\Delta NWC = \Delta$ net working capital = Δ net current assets – Δ net current liabilities.

Let's examine each of the terms in Equation (11.1). The first term, EBIT, is the accounting measure that forms the base for all cash flow calculations. For an all-equity firm without nonoperating income or expenses, EBIT is equivalent to pretax net income. In this case, $EBIT(1 - t)$ represents the total after-tax income that is produced by all the assets of the firm. This is an accounting measure of income that includes some noncash expenses and also excludes some cash expenditures. The included noncash expenses are depreciation and amortization, which reduce EBIT on the income statement but do not require any direct cash outlays by the firm. Thus, we add both these items back in Equation (11.1). In contrast, capital expenditures—investments by the company in plant and equipment—are not treated as an expense on the income statement, but do require a cash outlay. Thus, we subtract capital expenditures in Equation (11.1). For growing firms, it will usually be the case that capital expenditures exceed depreciation. The remaining item is ΔNWC , the change in net working capital. As a business grows, its working capital needs will usually grow as well. If working capital goes up, then some extra cash must be kept in the business, and this will reduce cash flow. Thus, we subtract ΔNWC in Equation (11.1).

Using Equation (11.1), cash flow calculations are straightforward for past years, when all the inputs are easily available. In DCF valuation, however, we need inputs for future years; therefore it is necessary to make forecasts, most often for the next five or ten years. This is not as difficult as it sounds because many of the forecasts will be driven by a few common assumptions. We will demonstrate how this works in Section 11.3. For now, we focus on the mechanics of Equation (11.1), with a few additional simplifications. First, because we have already assumed an all-equity firm, there will be no interest expense, and $EBIT(1 - t)$ will just be equal to **earnings (E)**. Second, we assume that amortization—which is most often related to

the acquisition of assets from other companies—is zero. Finally, we define **net investment (NI)** as

$$NI = \text{capital expenditures} + \Delta NWC - \text{depreciation.} \quad (11.2)$$

For some applications, it is helpful to write NI as a fraction of earnings, with this fraction known as the **investment rate (IR)**:

$$NI = IR * E. \quad (11.3)$$

Some authors refer to the investment rate as the plowback ratio (because it is the fraction of earnings that is “plowed back” into investment) or the reinvestment rate.

By substituting Equation (11.2) and Equation (11.3) into Equation (11.1), we can rewrite cash flow as

$$CF = E - NI = E - IR * E = (1 - IR) * E. \quad (11.4)$$

To complete a DCF calculation, we add the discounted values for each annual cash flow. In principle, one must estimate cash flows for every year until the end of time. At this point, the timing of Exhibit 11-1 comes to rescue us. At graduation, instead of building a model with forecasts for each year, we exploit the assumptions of stable growth and compute graduation value as a perpetuity: the NPV of a perpetual income stream with a constant growth rate and constant discount rate. The present value of a perpetuity with an initial annual payment (starting in one year) of X growing at rate g and discounted at rate r is

$$\text{NPV of perpetuity} = X/(r - g). \quad (11.5)$$

Thus, the graduation value in our DCF can be written as

$$\text{Graduation Value} = GV = CF_{S+1}/(r - g) - E_s * (g/R(\text{new}))^2. \quad (11.6)$$

With these quantities and definitions, we can compute the NPV of the firm as

$$\text{NPV of firm at exit} = \frac{CF_{T+1}}{1+r} + \frac{CF_{T+2}}{(1+r)^2} + \dots + \frac{CF_{T+n}}{(1+r)^n} + \dots + \frac{CF_S + GV}{(1+r)^{S-T}} \quad (11.7)$$

where CF_n is the cash flow in year n . Note that we will use both the growth rate g and the discount rate r in real terms—that is, they are nominal rates minus the inflation rate. The model is thus invariant to inflation, because it uses real forecasts and real discount rates. Equation (11.7) implicitly assumes that all cash flows occur

²Note that the second term in Equation (11.6) is a necessary adjustment to make the model invariant to changes in g when the firm’s investment return (in the stable growth period) equals exactly its cost of capital.

at the end of the year. Because it is more realistic to assume that annual cash flows are spread evenly through the year, many analysts perform a **midyear correction** on Equation (11.7) by bringing every cash flow forward by six months. Mathematically, this correction is done by multiplying the answer from Equation (11.7) by the square root of $(1 + r)$. We will use this correction on all the computations in this chapter.

EXAMPLE 11.1

The projections for Newco's rapid-growth period are given in Exhibit 11-4. The nominal discount rate is 11 percent, the stable nominal growth rate is 5 percent, and the inflation rate is 3 percent. Thus the real discount rate and stable growth rate are 8 percent and 2 percent, respectively. We will express everything in real dollars.

Problems

- Compute the NI in each period.
- Compute CF in each period.
- Compute the graduation value.
- Compute the NPV of Newco.
- Do a sensitivity analysis of this NPV using (real) stable growth rates of 0 percent and 4 percent.

Solutions (a) and (b) The computations for NI and CF are given in Exhibit 11-5 and are discussed below.

Several assumptions have been made to reach these forecasts. In Section 11.3, we discuss these assumptions at length; for now, we take these forecasts as given and just work through the computations of cash flow and NPV. The graduation revenue and margin (year 7)

EXHIBIT 11-4

NEWCO CASH FLOW FORECASTS

Year	0	1	2	3	4	5	6	7	8
Revenue	80.0	127.4	175.2	224.7	276.1	332.7	395.6	462.5	471.7
Operating Margin	10.0%	10.7%	11.4%	12.1%	12.9%	13.6%	14.3%	15.0%	15.0%
EBIT	8.0	13.6	20.0	27.3	35.5	45.2	56.5	69.4	70.8
Taxes	3.2	5.5	8.0	10.9	14.2	18.1	22.6	27.7	28.3
E	4.8	8.2	12.0	16.4	21.3	27.1	33.9	41.6	42.5
Depreciation	5.0	7.8	10.6	13.3	16.1	18.9	21.7	24.5	27.3
Gross Investment (Capex + Net New WC)	32.8	35.6	38.4	41.2	44.0	46.7	49.5	52.3	37.9

EXHIBIT 11-5

NI AND CF CALCULATIONS

NI	27.8	27.8	27.8	27.8	27.8	27.8	27.8	27.8	10.6
Cash Flow	-23.0	-19.6	-15.8	-11.5	-6.5	-0.7	6.1	13.8	31.8

are \$462.5M and 15 percent, respectively, and rapid growth rates (matched to historical average of high growth firms) have been assumed between exit and graduation. To achieve this growth, gross investment increases each year, but as can be seen in Exhibit 11-5, the NI is constant across years. Then, to compute the cash flow, we can use Equation (11.1) for each year.

(c) The graduation value will be a large part of the value of Newco. Using the assumption of 2 percent annual growth and a stable operating margin of 15 percent, the year 8 forecasts give an estimated revenue of \$471.7M, EBIT of \$70.8M, and earnings of \$42.5M. The tricky part here is the forecast of NI. Although we can estimate depreciation using some fraction of the capital base, the gross investment estimate is not so straightforward. It might seem logical to forecast NI growth of 2 percent from year 7 to year 8, but this forecast would be a mistake. NI is needed to fund growth. During the rapid-growth period, the investment rate is almost always higher than it will be during the stable growth phase. To correctly forecast the investment rate necessary for stable growth, we need some assumption about the return on new investment. In these forecasts there is an assumption lurking behind the scenes; this assumption will be discussed in Section 11.3.

Once we have a forecast for NI in year 8, we can calculate the CF in year 8 as \$31.8M. Then we can use a growth rate of 2 percent in Equation (11.6) to compute GV as

$$GV = 31.8 / (0.08 - 0.02) - 41.6 * (0.02 / 0.08) = \$520.3M. \quad (11.8)$$

(d) To compute the NPV, we use Equation (11.7), with a discount rate of 8 percent, GV as given by Equation (11.8), and annual cash flows as given Exhibit 11-5. This yields an NPV of \$279.85M.

(e) To perform a sensitivity analysis using different growth rates, it is tempting to just substitute these different rates into Equation (11.6). For example, for a growth rate of 3 percent, we would have

$$GV = 31.8 / (0.08 - 0.00) - 41.6 * (0.00 / 0.08) = \$398M, \quad (11.9)$$

and for a growth rate of 7 percent we would have

$$GV = 31.8 / (0.08 - 0.04) - 41.6 * (0.04 / 0.08) = \$775.2M. \quad (11.10)$$

With these estimates of GV, the NPV would change significantly. Note, however, that neither of these estimates takes into account any change in investment during the stable growth period. As discussed earlier in part (c), growth is supported by new investment, and different levels of growth require different investment rates. Thus, the GVs given in Equations (11.9) and (11.10) *are not correct*. To see why this is true, we need to do a little more work, which we do in Section 11.3. ■

11.3 GRADUATION VALUE

Equations (11.9) and (11.10) demonstrate that GV can be very sensitive to the specific assumption about growth rates—especially if we are not careful about adjusting for the correct level of investment. Indeed, this sensitivity is often criticized as the main shortcoming of DCF models, particularly for VC transactions. To deal with this sensitivity, some analysts use valuation ratios from comparable companies to estimate graduation values. *This book strongly recommends against using comparable companies to compute graduation values in DCF models.* In Chapter 12, we use comparable companies to estimate exit values as an exercise in relative valuation. There is nothing wrong with using comparables for relative valuation. In this chapter, however, we are attempting an absolute valuation using a DCF. The whole point of a DCF model is to make up your own mind about the valuation of the company. By using valuation information from comparable companies, you will never form your own opinion, and you will be missing the opportunity for valuable insight into your investment.

To gain this insight, we begin by analyzing the determinants of growth. Considering some time period N , where Newco invests NI and earns a return on this new capital of R . Thus, the new investment provides incremental earnings of $NI * R$. If we assume that the period N earnings can be sustained indefinitely without any new investment (i.e., by simply replacing the old capital as it depreciates), then earnings in period $N + 1$ can be written as

$$E_{N+1} = E_N + NI * R. \quad (11.11)$$

So the growth rate g is given by

$$g = (E_{N+1} - E_N)/E_N = (NI * R)/E_N = IR * R. \quad (11.12)$$

Thus, growth is the product of the investment rate (IR) with the return on capital (R). Holding R constant, if a company wants to increase growth, then it must increase its investment rate. An increase in the investment rate, however, will decrease cash flow ($= (1 - IR) * E$), so there will always be a tradeoff. If the investment NI earns a return of R every year in perpetuity, then the NPV of this investment will be $NI * R/r$. With this equation, it is easy to see that the NPV of this new investment will be positive if and only if R is greater than r . In other words, new investment will only increase the value of a company when the return on capital is greater than the discount rate.

We can gain further insight into the NPV of growth by substituting Equations (11.4) and (11.12) into Equation (11.6) to obtain the following:

$$GV = (1 - IR) * E / (r - (IR * R)). \quad (11.13)$$

Note that if $R = r$, then Equation (11.13) reduces to $GV = E/r$, so that graduation value is independent of the investment rate and growth. By using Equation (11.12), one can also rewrite Equation (11.13) in terms of g instead of IR :

$$GV = (1 - g/R) * E/(r - g). \quad (11.14)$$

Koller, Goedhart, and Wessels (2005) refer to Equation (11.14) as “the Zen of corporate finance”, and we agree with them that it is an equation worthy of some contemplation. In particular, Equations (11.13) and (11.14) remind us that a company cannot control both g and IR at the same time, and one cannot become attached to any particular level of growth without recognizing that current cash flow will suffer. Indeed, the relationship between g and IR is even deeper than suggested by Equations (11.13) and (11.14), because the return on capital should also be a function of IR .

Exhibit 11-6 is similar to Exhibit 5-1. The optimal NI^* occurs when the (marginal) return on investment (ROI) is equal to r . By increasing NI further, the company could increase growth, but only at the cost of reduction in R . Similarly, the company could increase R by cutting back on NI , but this would reduce growth.

To make Exhibit 11-6 operational, we need some intuition on how to estimate NI^* and R^* . In general, ROI can only exceed r for investments where the company has some **competitive advantage** (e.g., a patent on a key piece of technology, a period of market exclusivity on a drug, or a powerful brand name). Most forms of competitive advantage can be sustained only as long as there are **barriers to entry**.

EXHIBIT 11-6

RETURN ON CAPITAL AS A FUNCTION OF NI

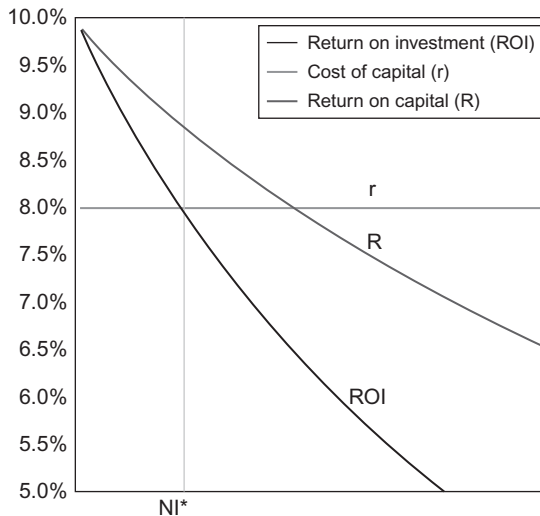

Without barriers to entry, other companies will enter the market and put downward pressure on ROI. In Section 11.4, we propose a baseline DCF model where R is set to r for all levels of NI . Then, from this starting point, the analyst can experiment with various levels of $R^* > r$.

To illustrate a more complete model, we return to the Newco forecasts from Example 11.1. The forecasts in this example were generated from a small-scale model of growth, as shown in Exhibit 11-7. In building this model, we make a distinction between capital in place at the time of graduation—“old capital”—and capital created by new investments after graduation—“new capital”. The returns to old capital are given by $R(\text{old})$, and the returns to new capital are given by $R(\text{new})$. Unless otherwise noted, all general comments about return on capital refer to $R(\text{new})$.

The inputs to the model are given in bold type. These inputs then drive the cashflow calculations in each year of the model (Exhibit 11-4), with graduation values implied by the graduation inputs, and intermediate values pinned down by

EXHIBIT 11-7

MODEL ASSUMPTIONS FOR EXAMPLE 11.1

	Exit (T)	Graduation (S)
Years until Graduation (S-T)		7
Expected Inflation	3.0%	
Industry Growth (average, nominal)	5.0%	
Extra Growth (above 75th percentile)	0.0%	
Revenue	80.0	462.5
Operating Margin	10.0%	15.0%
Tax Rate	40.0%	40.0%
Assets	50.0	244.8
Stable Growth (nominal)		5.0%
Stable Growth (real)		2.0%
Discount Rate (nominal)	11.0%	11.0%
Discount Rate (real)	8.0%	8.0%
R(old) (nominal)		20.0%
R(old) (real)		17.0%
R(new) (real)		8.0%
IR		25.0%
Depreciation % of Assets	10.0%	
NPV	\$279.85	
GV	\$520.27	

matching the firm's revenue growth rates to those of newly-public, rapid-growth companies in the respective industry. Note that several entries in the table for the graduation period are not given in bold: revenue, assets, and IR (as well as the inflation-adjusted values for r , g , and $R(\text{old})$). These entries are all determined by other inputs: the graduation revenue is determined by the exit year revenue and rapid-growth assumptions; the graduation assets are determined by the graduation earnings combined with $R(\text{old})$; and the IR is determined by the assumptions about growth and $R(\text{new})$. This model is given in the *Example 11.1* worksheet of the *DCF* spreadsheet, and readers are encouraged to experiment with the inputs. This spreadsheet also contains the investment function worksheet that was used to generate Exhibit 11-6 (see "exhibit 11.6" tab). By using this function, readers can input the correct level of R (average return on capital) for any corresponding level of g or IR.

11.4 DCF ANALYSIS: THE REALITY-CHECK MODEL

With this background, we are prepared to sketch a baseline DCF model that can be used as a starting point for exit valuation. We call this model the *reality-check DCF model*.

11.4.1 Baseline Assumptions for the Reality-Check DCF

(I) On the exit date:

- (a) Revenue is forecast for the average success case.
- (b) Other accounting ratios (*not* valuation ratios) are estimated using comparable companies or rule-of-thumb estimates.
- (c) The discount rate is estimated from industry averages or comparable companies (see Chapter 12).

(II) On the graduation date:

- (a) The stable nominal growth rate is equal to expected inflation; thus, the real growth rate is zero.
- (b) The return on new capital— $R(\text{new})$ —is equal to the cost of capital (r).
- (c) The return on old capital— $R(\text{old})$ —is equal to the industry-average return on capital (ROC).
- (d) The operating margin is equal to the industry average.
- (e) The cost of capital (r) is equal to the industry average cost of capital.

(III) During the rapid-growth period:

- (a) The length of the rapid-growth period is between five and seven years.
- (b) Average revenue growth is set to the 75th percentile of growth for new IPO firms in the same industry in respective years and is constructed

from data contained in *Growth* and *Industry Statistics* worksheets of the *DCF* spreadsheet. Thus, as a baseline assumption, extra growth (above 75th percentile) in Cell B8 is set to 0%.

- (c) Margins, tax rates, and the cost-of-capital all change in equal increments across years so that exit values reach graduation values in the graduation year.

These assumptions should be considered as a starting point of analysis; they are not intended to be definitive. For example, Assumption II(b)—that the return on new capital is equal to the cost of capital—would only be consistent with optimal investment behavior if the ROI line in Exhibit 11-6 was identical to the cost of capital line. This is clearly an extreme assumption, which can be relaxed as the analyst experiments with different inputs necessary to produce any given valuation. Then, once this experimentation is complete, the analyst can ask whether these relaxed assumptions are reasonable. For example, we can assume that $R(\text{new})$ is greater than the cost of capital. This modified assumption could reflect an adjustment from the base case based on an investment function like Exhibit 11-6.

The next two examples illustrate the application of the reality-check model.

EXAMPLE 11.2

EBV is considering an investment in Semico, an early-stage semiconductor company. If Semico can execute on its business plan, then EBV estimates it would be five years until a successful exit, when Semico would have about \$50M in revenue, a 10 percent operating margin, a tax rate of 40 percent, and approximately \$50M in capital (= assets). Subsequent to a successful exit, EBV believes that Semico could enjoy seven more years of rapid growth.

Problem To make the transaction work, EBV believes that the exit value must be at least \$300M. How does this compare with the reality-check DCF? How much must the baseline assumptions change to jeopardize this valuation?

Solutions To get the inputs of the model, we consult the *industry statistics* worksheet in *DCF.xls*. The semiconductor industry is listed in row 86 of this worksheet, which gives us inputs of $R(\text{old}) = 28.67\%$, operating margin = 27.73%, and $r = 15.55\%$. Also, the worksheet gives the average revenue growth in the industry as 8.70 percent. To find the 75th percentile for rapid growth, we look in the *Growth* worksheet of *DCF.xls* and find the respective annual growth rate and adjust for the industry and for the inflation. For example, the 75th percentile rapid growth phase is $57.20\% + 8.70\% - 3.0\% = 62.9\%$.³

Exhibit 11-8 summarizes the results of the reality-check model. The exhibit shows a baseline reality-check estimate of \$206.70M for the NPV. The problem asks us to test

³Another way to relax the baseline assumptions here is to play with extra growth above the 75th percentile. You can experiment with adding an extra 5 percent, say, by entering the value in Cell B8 of the worksheet. This cell is set to zero as a baseline assumption.

EXHIBIT 11-8**REALITY-CHECK DCF MODEL FOR SEMICO**

	Exit (T)	Graduation (S)
Years until Graduation (S-T)		7
Expected Inflation	3.0%	
Industry Growth (average, nominal)	8.7%	
Extra Growth (above 75th percentile)	0.0%	
Revenue	50.0	353.0
Operating Margin	10.0%	27.7%
Tax Rate	40.0%	40.0%
Assets	50.0	228.8
Stable Growth (nominal)		3.0%
Stable Growth (real)		0.0%
Discount Rate (nominal)	15.5%	15.5%
Discount Rate (real)	12.5%	12.5%
R(old) (nominal)		28.7%
R(old) (real)		25.7%
R(new) (real)		12.5%
IR		23.9%
Depreciation % of Assets	10.0%	
NPV (with mid-year corrections)	\$206.70	
GV	\$468.06	

the sensitivity of this estimate to changes in the inputs and to see what changes would be necessary to obtain an NPV of \$300M. If we experiment with different inputs, we can quickly see that the model is not sensitive to the stable growth (g) assumptions as long as $R(\text{new}) = r$. This is due to the second term in the Graduation Value formula, which essentially “charges” the firm extra NI in year S for additional growth in year $S+1$. So any increase in g (which increases future CF) is exactly offset by a decline in current CF. If $R(\text{new}) > r$, then increase g will result in a larger GV and thus also larger NPV. For example, with $g = 10\%$ and $R(\text{new}) = 20\%$, GV increases by \$247.79M, and NPV rises to \$321.63. These would be very aggressive assumptions because it would imply a perpetual return on capital near the same rate as the return earned in the rapid growth phase.⁴

⁴If $R(\text{new}) < r$, however, increasing g actually has a negative effect on NPV. Why? Because $IR = g/R(\text{new})$, excessive investments when return on investments is low would hurt CF at $S+1$, and thus GV shrinks. This is akin to setting $NI > NI^*$ in Exhibit 11-6.

Similarly, we could get the NPV to almost \$300M (\$295.87M) by adding extra 10 percent to the rapid-growth rates from year 1 to year 7 (by entering “10%” to cell B8). Although this change might seem arbitrary, we can anchor ourselves in the industry data to see just how extreme this assumption would be. Furthermore, an extra 10 percent growth rate implies that graduation revenue would be \$589.3M, or 70 percent higher than the baseline level. To decide whether this level is reasonable, we need to rethink our assumptions about market size, pricing, and market penetration. Of course, we do not have enough data about Semico to make informed judgments, so all we can do here is experiment with numbers. Next, we consider a more concrete example. ■

EXAMPLE 11.3

For the 12 months ended on September 30, 2009, Amgen, a publicly traded biotechnology company (NASDAQ: AMGN), had \$14.6B in revenue, an operating margin of 38.31 percent, and \$29.6B in assets (net of goodwill). Amgen’s enterprise value (on January 30, 2010) was approximately \$55B. It had no significant net debt or interest costs.

Problem Perform a reality-check DCF for Amgen. What assumptions would be necessary to justify Amgen’s current valuation?

Solutions To apply the reality-check DCF, we need to make some forecasts for Amgen’s stable growth period. In the *industry statistics* worksheet, Amgen could be included in two different industries, “biotechnology” and “drugs”, because the company enjoys both the high growth potential of the biotech industry and the high current profitability of drug companies.

The *industry data* worksheet shows more favorable averages for the drug industry, so we give Amgen the benefit of the doubt and use these estimates: $r = 11.55$ percent, $R(\text{old}) = 22.57$ percent, and $\text{margin} = 30.15$ percent.⁵ In the past five years, Amgen has enjoyed growth of about 14 percent per year; for the next five years, the consensus analysts’ forecast is 9 percent per year.⁶ For our baseline model, we extend these forecasts for a seven-year rapid growth period at 9 percent per year. As in all baseline reality-check models, we assume only inflationary growth ($(\text{real})g = 0$ percent, in this case) and $R(\text{new}) = r$. Using these assumptions, the reality-check DCF is summarized in Exhibit 11-9. The NPV computed there, \$56.09B, is almost exactly the actual market value. It turns out that no additional assumptions are necessary to justify Amgen’s current market valuation. Exhibit 11-10 shows the sensitivity of this NPV to some changes in the baseline assumptions.

⁵Under current accounting rules, R&D is treated as an expense and not as a capital expenditure. Although this accounting treatment does not affect cash flow calculations, it can lead to misleading calculations about return on capital. For a detailed study of value creation, it makes more sense to treat R&D the same way as other capital expenditures. This correction is beyond the scope of our treatment of DCF models. Please see Koller et al. (2005) for a discussion.

⁶Source: Yahoo Finance, <http://finance.yahoo.com/q/ae?s=AMGN>, January 30, 2010.

EXHIBIT 11-9**REALITY-CHECK DCF FOR AMGEN**

	Exit (T)	Graduation (S)
Years until Graduation (S-T)		7
Expected Inflation	3.0%	
Analysts' Estimate (consensus, nominal)	9.0%	
Analysts' Estimate (consensus, real)	6.0%	
Revenue	15.6	23.4
Operating Margin	38.3%	30.1%
Tax Rate	40.0%	40.0%
Assets	29.6	21.7
Stable Growth (nominal)		3.0%
Stable Growth (real)		0.0%
Discount Rate (nominal)	11.5%	11.5%
Discount Rate (real)	8.5%	8.5%
R(old) (nominal)		22.6%
R(old) (real)		19.6%
R(new) (real)		8.5%
IR		0.0%
Depreciation % of Assets	10.0%	
NPV	\$56.09	
GV	\$49.58	

Exhibit 11-10 shows a series of changes that would either positively or negatively affect NPV. Moving down the rows in Exhibit 11-10 shows the combined impact of all changes above and including that row. If we assume that Amgen maintains the 14 percent nominal growth rate for the next seven years, its NPV will go up to \$64.97B; further assuming that $R(\text{new}) = 20$ percent (second row) and $g = 5$ percent (third row) raises the NPV further to \$72.59B. Finally, assuming that the operating margin perpetually stays at 38.3 percent pushes up the NPV to \$82.93B. These together are very aggressive assumptions indeed, and do not look very sustainable.

Now what changes to our baseline assumptions could lower the NPV? Recall that we used industry estimates of the drug industry, since they were more favorable than those of the biotechnology industry. If the operating margin matches that for the biotechnology industry (26.9 percent), the NPV declines to \$53.61B; increasing the cost of capital (r) to 12.3 percent lowers NPV to \$49.93B; decreasing the return on old capital to 14.8 percent further pushes NPV down to \$40.41B; finally, assuming a very conservative growth rate of 5 percent for the next seven years lowers the NPV to \$38.15B.

EXHIBIT 11-10**NPV OF AMGEN UNDER DIFFERENT ASSUMPTIONS**

Positive Changes to NPV			
	rapid growth (real)	11.0%	\$64.97
and	R(new)	20.0%	\$64.97
and	g	5.0%	\$72.59
and	operating margin	38%	\$82.93
Negative Changes to NPV			
	operating margin	26.9%	\$53.61
and	Cost of capital	12.3%	\$49.93
and	R(old)	14.8%	\$40.41
and	rapid growth (real)	5%	\$38.15

NOTE: All dollars in billions.

Of course, an infinite number of combinations could obtain this result, but Exhibit 11-10 gives the flavor of what is necessary. Based on these calculations, it appears that Amgen can justify its January 2010 valuation. ■

SUMMARY

The exit value is the most important input in a VC valuation. To estimate exit values, we have two main methods: absolute valuation (in this chapter) and relative valuation (in Chapter 12). All types of absolute valuation can be reduced to some form of discounted cash flow (DCF) analysis. To perform a DCF analysis for a venture-backed company, we divide the company's life cycle into three parts: the venture period (while the company is still being funded by VCs), the rapid-growth period (which immediately follows the VC exit), and the stable-growth period (when growth, margins, and return on capital have settled down to industry averages). Our reality-check DCF model uses inputs from the beginning of the rapid-growth and stable-growth periods to determine the key cash flows and then computes the NPV of these cash flows using industry average cost of capital.

KEY TERMS

Absolute valuation, relative valuation	<i>Venture period</i>	Operating assets
Discounted cash flow (DCF) analysis	<i>Rapid-growth period</i>	Cash Flow (CF)
	<i>Graduation</i>	Earnings before interest and taxes (EBIT)
	<i>Stable-growth period</i>	

Earnings = Net Income	Perpetuity	<i>Reality-check DCF</i>
Net investment (NI)	<i>Graduation value</i>	
Investment rate (IR)	Midyear correction	
= plowback ratio	Competitive advantage,	
= reinvestment rate	barriers to entry	

REFERENCES

Damodaran, Aswath, 2009, *The Dark Side of Valuation*, Prentice Hall, Upper Saddle River, NJ.
 Koller, Tim, Marc Goedhart, and David Wessels, 2005, *Valuation: Measuring and Managing the Value of Companies*, Wiley, Hoboken, NJ.

EXERCISES

11.1 EBV is considering an investment in Softco, an early-stage software company. If Softco can execute on its business plan, then EBV estimates it would be five years until a successful exit, when Softco would have about \$75M in revenue, a 20 percent operating margin, a tax rate of 40 percent, and approximately \$75M in capital. Subsequent to a successful exit, EBV believes that Softco could enjoy seven more years of rapid growth. To make the transaction work, EBV believes that the exit value must be at least \$400M. How does this compare with the reality-check DCF? How much must the baseline assumptions change to justify this valuation?

11.2 *True, False, or Uncertain:* Firm value is maximized when the return on capital is exactly equal to the cost of capital.

11.3 *True, False, or Uncertain:* If two firms have exactly the same balance sheet and income statement on their respective graduation dates, then the firm with the higher growth rate will also have the higher graduation value.

11.4 Perform a reality-check DCF for a publicly traded company of your choice.

COMPARABLES ANALYSIS

IN THIS CHAPTER we analyze exit values using **comparables analysis**, sometimes abbreviated as **comps** and also known as **multiples analysis**, **method of multiples**, and **relative valuation**. In the DCF analysis of Chapter 11, we valued a company based on its cash flow and discount rates. DCF analysis is a form of absolute valuation because it does not use information from relative values of similar companies. In contrast, in comparables analysis the main idea is to get the market's opinion about a company. To do this we first identify a set of similar companies, and then we analyze a variety of valuation ratios for these companies. We then use other market information to choose among and combine these various ratios to arrive at our estimate of the exit valuation.

Suppose we are trying to estimate an exit valuation for Newco. After some reflection, we estimate that a success case for Newco would be \$50M of revenue in six years. We also observe that the public companies in Newco's industry have enterprise valuations of about 5 times revenue. By applying this same multiple to Newco, we estimate an exit valuation of \$250M. That is a quick-and-dirty example of comparables analysis. In many cases, VCs will not take this analysis any further. Sometimes this quick analysis is justified, because a bundle of uncertainties prevents any additional accuracy. In other cases, however, a careful analysis that combines DCF and comparables can yield insights into valuation anomalies. In this section we learn the steps necessary to perform a more careful comparables analysis. These steps expand on the quick-and-dirty analysis in two ways:

1. The choice of valuation measures (Section 12.1)
2. The choice of comparable companies (Section 12.2)

Among VCs, comparables analysis is by far the most popular method of exit valuation. There is some empirical support for this popularity, as IPO valuation seems to be driven more by comparables than by DCF analysis. Nevertheless, a prudent investor should perform both DCF analysis (absolute valuation) and comparables analysis (relative valuation) before making any investment decision. In other words, form your own opinion, and then test it against the market.

It is important to remember that the valuation methods studied in Chapters 11 and 12 are only providing an analytical framework. By itself, this framework does not answer the most difficult questions of valuation; for example, how do we forecast “success case” revenue at exit? In the quick-and-dirty example given above, we used a success-case revenue of \$50M for Newco. Where does this estimate come from? It does not come from financial analysis, but rather from more general business analysis that must occur during due diligence and investment screening. There is no magic formula for making these estimates—if there were such a formula, then venture capital would be an easy profession.

12.1 INTRODUCTION TO COMPARABLES ANALYSIS

Suppose that we have been asked to estimate an exit valuation for Newco, the same company analyzed in Example 11.1. In a successful exit, we estimate that the company will have about 100 employees and generate \$80M in revenue, \$8M in EBIT, \$13M in **EBITDA** (= **earnings before interest, taxes, depreciation, and amortization**), \$4.8M in earnings, and have \$50M in book value of equity. We use the same financial estimates here as we did for the starting point of our DCF model. If we attempt to value this company using the tools of DCF analysis, we would begin at the exit date and forecast the cash flows, estimate a cost of capital, and then compute an NPV for the company. Alternatively, we could ignore our own opinion and look at how the public market values some similar companies today.

Exhibit 12-1 gives summary financial and market data for four comparable companies in Newco’s industry. For now, we will ignore the question of how we identified these specific companies, leaving that topic for Section 12.2. To form a valuation multiple we need both numerators and denominators. The two numerators most often used in comparables analysis are **enterprise value (EV)** and **equity market capitalization** (= **market cap** or **equity market value**). The former measures the market value of all the securities of the company, whereas the latter measures the market value of just the common stock. Next, we need some denominators. The most intuitive denominators are proxies for cash flow. Indeed, all multiples have some deep connection to a cash flow ratio, even if the connection is not apparent. In the end, however, all that really matters is that investors perceive some usefulness in a multiple. If a multiple is perceived as useful, then it can be predictive for the valuation of a comparable company.

For the analysis and exercises in this chapter, we will use six different multiples:

1. **EV/EBIT**: EV is the total market value of all securities of the company, including common stock, long-term debt, preferred stock, and so on.

EXHIBIT 12-1*SUMMARY FINANCIAL INFORMATION FOR NEWCO COMPARABLES*

	ABC	DEF	GHI	JKL
Revenue	80	70	40	55
EBIT	30	5	10	10
EBITDA	50	10	20	20
Net income	17	3	4	6
LTD	10	0	20	10
BV of equity	100	20	50	50
Market cap (Price)	300	280	150	200
EV	310	280	170	210
Employees	300	120	200	50

In practice, most of EV for public companies is in common stock and long-term debt. The denominator, EBIT, is often viewed as proportional to a steady-state cash flow measure, in which case the EV/EBIT ratio has an intuitive interpretation as the ratio of firm value to cash flow.

2. **EV/EBITDA:** This is another popular measure, particularly among leveraged-buyout investors. Like EBIT, some analysts view EBITDA as a cash flow measure. Although this is true in the short run (where capital expenditures to replace depreciated equipment can be delayed), it is definitely not true in the long run. Nevertheless, even if EV/EBITDA does not have the same cash flow interpretation as EV/EBIT, it can be particularly useful for evaluating industries that have wide variation in their depreciation practices.
3. **EV/Revenue:** This is the multiple used in the quick-and-dirty analysis in the introduction to this chapter. At first glance, this multiple appears completely divorced from any cash flow rationale because no measure of profitability is included in the denominator. Nevertheless, this measure often provides the most useful valuation ratio, particularly for high-growth industries favored by VCs. In these industries, many companies have negative EBIT and EBITDA, thus making it impossible to form reasonable multiples for those measures. Because revenue is never negative, the EV/Revenue multiple is always available.
4. **Price/Earnings:** The ratio of price to earnings, “P/E”, is probably the most widely known valuation measure. In this context, “price” refers to the price of a single share of stock, and “earnings” refers to earnings per share. With company level data, we can compute the P/E ratio by dividing net income (= earnings) into market cap. Because earnings accrue only to shareholders

(not bondholders), the P/E numerator uses only the market cap, not the whole enterprise value.

5. **Price/Book:** This measure is also popular among Wall Street professionals. As with the P/E ratio, it is often referred to by the share level term of “price”, which is then divided by book value per share. With company level data, we can compute the P/B ratio by dividing book value of common equity into market cap. As in the case of the P/E ratio, the P/B numerator uses only the market cap, not the whole enterprise value. An enterprise level equivalent of P/B would divide the book value of all assets into the EV. This enterprise measure is popular among academics, but has not caught on much with practitioners. The P/B ratio is motivated not by cash flow, but also by breakup value. The idea here is that—if we believe the accounting statements—a P/B ratio below 1 would indicate that the equity holders would be best off by selling the company, repaying the debt, and pocketing the difference.
6. **EV/Employees:** Like the EV/Revenue ratio, the EV/Employees ratio would appear to have no clear connection to either cash flow or breakup value. As will be seen below, a connection can indeed be established, but the best reason to follow this ratio is that it can provide surprising insights in some cases. Essentially, the logic is that the number of employees is the fastest-moving measure of potential firm size, so even if all other accounting-based ratios are lagging, the EV/Employee ratio might still provide some insight. Furthermore, like the EV/Revenue ratio, the EV/Employee ratio will never be negative.

Although we focus attention on these six ratios, there is virtually no limit on the ratios that are used in practice. In general, when forming a ratio, one starts with a denominator of interest and then applies either EV or equity market value as the numerator. One cannot use these numerators interchangeably—for any given denominator, only one of these numerators would be correct. If the denominator is an enterprise level quantity (e.g., EBIT, EBITDA, revenue, or employees), then EV is the correct numerator. If the denominator represents some quantity that only accrues to equity holders (e.g., earnings or book value of equity), then equity market value is the correct numerator.

EXAMPLE 12.1

Problem Given the information on comparables in Exhibit 12-1, what is your best estimate for the relative valuation of Newco?

Solution Exhibit 12-2 gives these valuation multiples for our four comparable companies, along with the average and median for each multiple:¹

¹In a sample of four companies, the median is the average of the two middle estimates.

EXHIBIT 12-2*VALUATION MULTIPLES*

Multiples	ABC	DEF	GHI	JKL	Average	Median
EV/EBIT	10.3	56.0	17.0	21.0	26.1	19.0
EV/EBITDA	6.2	28.0	8.5	10.5	13.3	9.5
EV/Revenue	3.9	4.0	4.3	3.8	4.0	3.9
Price/Book	3.0	14.0	3.0	4.0	6.0	3.5
Price/Earnings	17.6	93.3	37.5	33.3	45.5	35.4
EV/Employees	1.0	2.3	0.9	4.2	2.1	1.7

EXHIBIT 12-3*IMPLIED VALUATIONS FOR NEWCO USING COMPARABLES*

Multiples	ABC	DEF	GHI	JKL	Average	Median
EV/EBIT	83	448	136	168	199.6	152.0
EV/EBITDA	81	364	111	137	172.9	123.5
EV/Revenue	310	320	340	305	318.9	315.0
Price/Book	150	700	150	200	300.0	175.0
Price/Earnings	85	448	180	160	218.2	170.0
EV/Employees	155	350	128	630	315.6	252.5

For each multiple and each comparable company, we can compute a comparable valuation for Newco. For example, our exit revenue estimate (from Chapter 11) is \$80M. Then, using the ABC EV/Revenue multiple of $310/80 = 3.88$, we can compute a comparable valuation of $3.88 * \$80M = \$310M$ for Newco. Using the same procedure, we provide the complete set of comparable valuations in Exhibit 12-3.

OVERALL AVERAGE = \$254.2M

Notice that the medians are never larger than the averages. This is a typical situation for these multiples, as outliers on the high end can easily skew the averages. For this reason, some analysts prefer to use the median values when making their final estimates. Other methods to reduce the influence of outliers is to compute the **geometric mean** (multiply the ratios for all N firms and then take the N th root (e.g., if there are two comparable companies with EV/EBIT of 12 and 3, then the geometric mean is the square root of $12 * 3$ and is equal to 6) or the **harmonic mean** (take the reciprocal of the mean of the reciprocals, e.g., if there are two comparable companies with EV/EBIT of 12 and 3, then the harmonic mean is 1 divided by the arithmetic average of $1/12$ and $1/3$, and is equal to 4.8).

To decide on our best estimate, we need to go beyond a simple analysis of the averages. Although the individual implied valuations are all over the map—a high-estimate comparable valuation of \$700M using the price/book of DEF, down to a low-estimate comparable

valuation of \$81M for the EV/EBITDA ratio of ABC—the average comparable valuations are quite stable across different ratios. Nevertheless, the range of average estimates does vary from a high of 318.9 for EV/Revenue to a low of 172.9 for EV/EBITDA. Although it would be prudent to check both the high and low in any sensitivity analysis, one could make a strong argument that the EV/Revenue estimate is the most realistic. The main support for this argument is the relative variation of these valuation ratios. We don't need any fancy math to see that the EV/Revenue ratio provides by far the most consistent valuations across the different comparable companies. The stability of the EV/Revenue ratio can be seen by inspecting the columns of Exhibit 12-3, and simple statistics can confirm this casual inference. The standard deviations of each row in Exhibit 12-3 are, in order, \$163M, \$129M, \$15M, \$268M, \$159M, and \$232M. The EV/Revenue comparable has the lowest standard deviation by far. Even if we were to eliminate all the data from DEF—the company that appears to provide the most anomalous valuations—it still appears that EV/Revenue provides the most stable answer.

In summary, if we need to pick one number for an exit valuation, the EV/Revenue comparable of \$318.9M is the most defensible. One can make an argument for adjusting this number slightly to reflect the lower comparable valuations from the other ratios, but choosing the overall average of \$254.2M seems too conservative. ■

Exhibits 12-1 and 12-2 use historical data. Many academics and practitioners argue that valuation ratios are more accurate when using forecast data. For example, instead of using EBIT or earnings from the most recent fiscal year, the analyst would substitute forecasts for the next fiscal year or even for the following fiscal year. The evidence for the superiority of forecasts is compelling, but in this book we still recommend using the historical estimates as a baseline case. Why? Because the main purpose of comparables analysis is to get the market's opinion about valuation. Once we introduce forecasts into this analysis, we run the risk of conflating expert predictions with the market's opinion. Indeed, many forecasters logically take market prices into account when making their forecasts, and companies with high multiples for historical earnings are given higher forecasts for future earnings.

We made a similar argument in Chapter 11 against the use of comparable company multiples to estimate the graduation value in DCF models. If an analyst uses forecast multiples in the comparables analysis and then uses similar multiples as the graduation value in a DCF, then it is possible that lots of work has been done on two models based on the same set of information. There is nothing wrong with using forecasts in a comparables analysis as an additional check on your work, but you should not rely exclusively on these forecasts.

12.2 CHOOSING COMPARABLE COMPANIES

To choose comparable companies, it is important to first understand the connection between comparables analysis and DCF analysis. Most valuation ratios have some connection to DCF formulas. Consider a firm in a zero-inflation environment with

steady-state growth. Then, the present discounted enterprise value of this firm would be

$$EV = CF/r - g = CF/(r - R * IR), \quad (12.1)$$

where g is the perpetual growth rate of cash flows, r is the discount rate, IR is the investment rate, R is the return on (new) capital, and CF is cash flow in the next period. Equation (12.1) is similar to Equation (11.6), the graduation value for a DCF model. Next, consider the basic cash flow formula from Chapter 11:

$$CF = (1 - IR) * E = (1 - IR) * (1 - t) * EBIT, \quad (12.2)$$

since $(1 - t) * EBIT = E$ for all-equity firms.

Substituting Equation (12.2) into Equation (12.1) and dividing both sides by E (or $EBIT$) yields

$$EV/E = \text{Market Cap}/E = P/E = (1 - IR)/(r - R * IR), \quad (12.3)$$

or,

$$EV/EBIT = (1 - t) * (1 - IR)/(r - R * IR). \quad (12.4)$$

We can continue this approach by substituting $EBIT = \text{Revenue} * \text{Margin}$ into Equation (12.4) and rearranging terms to yield

$$EV/\text{Revenue} = \text{margin} * (1 - t) * (1 - IR)/(r - R * IR). \quad (12.5)$$

Then we can disaggregate revenue to be $\text{Employees} * \text{Revenue per employee}$, substitute into Equation (12.5), and rearrange to yield

$$\begin{aligned} EV/\text{Employees} &= \text{Revenue per employee} * \text{Margin} \\ &* (1 - t) * (1 - IR)/(r - R * IR). \end{aligned} \quad (12.6)$$

Thus, to find comparable companies for P/E or EBIT ratios, we must search for companies with similar steady-state levels for investment opportunities (for R and IR), discount rates, and (for EBIT) tax rates. If current operating margins are not yet at their steady levels, then we might be better off using an EV/Revenue margin and identifying comparable companies with stable operating margins. Finally, if revenue is not yet at its steady state (but employees are), then we can use Equation (12.6). Overall, these equations provide some guidance to analysts as they search for comparable firms. The analysis suggests that we look to firms in the same industry, facing similar investment opportunities, with similar long-run margins and productivity.

EXAMPLE 12.2

EBV is considering an investment in Semico, an early-stage semiconductor company. (This is the same company analyzed in Example 11.2.) If Semico can execute on its business plan, then EBV estimates it would be five years until a successful exit. At that time Semico would

have about \$50M in revenue, 150 employees, a 10 percent operating margin, a tax rate of 40 percent, and approximately \$50M in capital (= assets). Semico's business is to design and manufacture analog and mixed-signal integrated circuits (ICs) for the servers, storage systems, game consoles, and networking and communication markets. It also plans to expand into providing customized manufacturing services to customers that outsource manufacturing but not the design function. It expects to sell its product predominantly to electronic equipment manufacturers.

Problems

- (a) Identify comparable companies for Semico.
- (b) Use accounting and market information from these companies to estimate a relative valuation for Semico.

Solutions

(a) To identify comparable companies, we begin by screening similar-sized companies in Semico's industry. Our goal is to find the subset of such companies that are the closest match for Semico using the variables in Equations (12.3) through (12.6). Many possible databases can be used for this exercise. A VC with experience in semiconductors might have access to specialized industry databases. Even without such access, the experienced VC would not need to start fresh for the analysis, as he would likely be able to make an educated guess about the identity of the most comparable companies. Because we are starting from relative ignorance, we will need to cast a wide net in our search.

At the time of this writing, the Yahoo! Finance portal is an excellent (and free) source of all the necessary data. Using the "Stock Screener" tool,² we restrict our search to the "Semiconductors: Integrated Circuits" industry, which is the closest match to the description of Semico. The problem states that our success case revenue estimate is \$100M. Because we want companies with similar investment opportunities (which will then imply IR and R), we don't want to stray too far from this size, so we look for companies in this industry that have between \$25M and \$125M in projected revenue. Using the most recent four quarters of data (at the time of this analysis, this data usually goes through September 30, 2009), the stock screener finds 13 such companies. Note that we have chosen to screen by revenue rather than other accounting variables—we do this because revenue will be the best measure of firm size, and firm size is probably our best measure of investment opportunities. Enterprise value, which would also be a measure of firm size, would be an *incorrect* way to screen for comparable companies. If we were to use EV (or market cap) to choose comparable companies, then we would be implicitly placing restrictions on the valuation ratios.

Once we have identified these 13 candidates, we need to study the descriptions of these businesses to find those most comparable to Semico. Once again, we are guided by the variables in Equations (12.3) to (12.6). To find companies with similar investment opportunities (IR and R), we want companies facing the most similar economic environments—ideally, companies selling to original equipment manufacturers for ultimate sale into consumer and home office markets. The underlying growth (or decline) of these channels and markets would then have a similar impact on Semico and its comparable companies. Next,

²<http://screen.yahoo.com/stocks.html>.

EXHIBIT 12-4**SUMMARY FINANCIAL INFORMATION FOR SEMICO COMPARABLES**

	Supertex	PLX	Volterra	Semico Exit Estimates
Revenue	61.17	82.83	104.94	50
EBIT	5.02	-80.04	5.61	5
EBITDA	5.55	-5.88	18.19	10
Net income	4.91	-18.80	10.94	3
LTD	0.00	0.86	0.00	0
BV of equity	179.12	69.32	83.50	50
Market cap (Price)	317.32	180.25	503.03	??
EV	235.10	128.41	406.92	??
Employees	352	N/A	N/A	150

SOURCE: Yahoo! Finance, January 2010.

we want as much as possible to match companies based on stable operating margins and revenue per employee. To do this, we look for companies at a similar point in the supply chain. In general, companies at similar points in the supply chain (e.g., manufacturer, wholesaler, or retailer) have similar margins and productivity measures.

After studying the list of 13 companies, we find three that satisfy our criteria for the closest matches.³ These companies are: PLX Technology Inc. (NASDAQ GM: PLXT), Supertex Inc. (NASDAQ GS: SUPX), and Volterra Semiconductor Corporation (NASDAQ GS: VLTR). Summary financial information for these companies is given in Exhibit 12-4.

(b) This information is much messier than the fantasy case of Example 12.1. One of the three companies has negative EBIT, EBITDA, and earnings. Furthermore, we note that the EVs are *lower* than the market caps for all of the three companies (i.e., these companies have more cash than debt) so net debt is negative. Based on this data, we construct valuation multiples and display them in Exhibit 12-5.

The negative multiples in Exhibit 12-5 are problematic. Consider what happens to the multiple as a company moves from a positive EBIT, to zero, to negative. As EBIT falls close to zero, the EV/EBIT multiple rises to infinity, only to change abruptly to a large (absolute) negative number as EBIT turns negative. As mentioned in Section 12.1, these negative multiples are a common occurrence for growth companies, hence the reliance on the more robust multiples of EV/Revenue, Price/Book, and even EV/Employees (though, in this case, the number of employees is available for only one of the three companies). Exhibit 12-6 gives the implied valuations for these multiples.

Overall Average : \$204.6 Overall Median : \$193.9

³For readers who would like to try this analysis on their own, the list of 13 companies is given in Appendix 12.A.

EXHIBIT 12-5*VALUATION MULTIPLES*

Multiples	Supertex	PLX	Volterra	Average	Median
EV/EBIT	46.9	(1.6)	72.6	59.7	NA
EV/EBITDA	42.4	(21.8)	22.4	32.4	NA
EV/Revenue	3.8	1.6	3.9	3.1	3.8
Price/Book	1.8	2.6	6.0	3.5	2.6
Price/Earnings	64.6	(9.6)	46.0	55.3	NA
EV/Employees	0.7	NA	NA	NA	NA

EXHIBIT 12-6*IMPLIED VALUATIONS FOR SEMICO USING COMPARABLES*

Multiples	Supertex	PLX	Volterra	Average	Median
EV/EBIT	234.4	NA	362.9	298.6	NA
EV/EBITDA	423.6	NA	223.7	323.7	NA
EV/Revenue	192.2	77.5	193.9	154.5	192.2
Price/Book	88.6	130.0	301.2	173.3	130.0
Price/Earnings	193.9	NA	137.9	165.9	NA
EV/Employees	100.2	NA	NA	NA	NA

To put these valuations in perspective, recall from Example 11.2 that the reality-check DCF provided a baseline estimate of \$206.7M. Thus, both the average and median comparables are fairly close to the DCF valuation, while the estimates have a wide range. Overall, the EV/Revenue, Price/Book, and Price/Earnings multiples provide lower estimates than EV/EBIT and EV/EBITDA multiples. EV/Employees (usually a reliable multiple because of its relative stability across similar companies) is of little use in this example, because we do not have the data for two of the three companies.

To go beyond this analysis, we would need to take an even closer look at these comparable companies and try to decide whether any of them provides a particularly close match to the success case of Semico. This example does not provide enough information about Semico to allow for this analysis, and it would be rare for this additional precision to be available in a real-world investment. ■

Example 12.2 is typical for this kind of analysis. With negative EBIT, EBITDA, and earnings, and non-availability of employee figures, we are forced to rely on revenue and book multiples. Luckily, these multiples provide similar answers, but we are still left with a significant range of valuation multiples. If, as in Example 11.2, EBV requires an exit valuation of \$300M to justify the investment,

then this analysis suggests noninvestment unless EBV believes Semico to have prospects significantly better than these companies.

We must end this section with one big caveat: comparables analysis is dangerous for VC investors—so be careful! One obvious problem is that an excessive reliance on comparables analysis can make a VC prone to market fads, with current valuation ratios taken as long-run predictions. Alas, valuation ratios can change dramatically in five years. Indeed, when the first edition of this book was published four years ago, the comp valuations tended to be much higher than the reality-check DCF model valuation, reflecting the market conditions. Today, in 2010, the general pattern is the opposite. In addition, Equations (12.3) to (12.6) all emphasize the importance of finding comparable companies with similar investment opportunities, but the time difference between the current investment and a successful exit means that we need to identify public companies *today* that have investment opportunities similar to those available for our portfolio company *at exit*. In the rapidly changing markets frequented by VCs, this exercise requires a heroic leap of faith. Many VCs rely exclusively on comparables analysis—this reliance is very dangerous! Although the companies in Exhibit 12-4 may be in the same business as Semico, the growth prospects for this business are likely to be very different today from five years down the road. Of course, these challenges are a main reason that VC investing is so difficult in the first place.

12.3 USING COMPARABLE COMPANIES TO ESTIMATE THE COST OF CAPITAL

In Chapter 11, we used the industry-average cost of capital in our DCF calculations. Although an industry average makes sense for companies in the stable-growth phase, it may be an underestimate for companies in the rapid-growth phase. In general, the cost of capital will tend to fall as a company gets older. Thus, for some applications we might want to estimate the cost of capital at exit by using comparable companies. This estimation requires five steps:

1. Identify a set of comparable companies (as in Example 12.2).
2. Estimate a performance evaluation regression (as in Chapter 4) for each of these companies.
3. Compute the **unlevered betas** for these companies (described below).
4. Compute the average of these unlevered betas.
5. Use the corresponding cost of capital formula (as in Chapter 4) to estimate the cost of capital.

Of these five steps, only step (3) is completely new. In our discussion in Chapter 4, we did not distinguish between unlevered betas and **levered betas**, but instead referred to all factor loadings simply as “betas”. In Chapter 11, we also did not consider this distinction, as we were analyzing all-equity firms. Here, however, we must consider the

possibility that some of the comparable firms will have some debt in their capital structures, and thus the estimated betas will reflect both the “unlevered” cost of equity and the “leverage” costs of debt. In computing the proper cost of capital for exit valuations, it is necessary to unlever these betas. We illustrate this procedure in Example 12.3. In this example, we use the CAPM (as in Chapter 4) as our model for the cost of capital. Following the example, we discuss how the computations can be adjusted for multifactor cases such as the Fama-French model or the Pastor-Stambaugh model.

EXAMPLE 12.2

EBV is considering an investment in Newco—the same company from Examples 11.1 and 12.1. Newco’s comparable companies are given in Exhibit 12.1. In addition to the information given in that exhibit, EBV estimates that the CAPM betas for these companies are 1.5 for ABC, 1.0 for DEF, 2.0 for GHI, and 2.0 for JKL.

Problem Use these comparable companies to estimate a discount rate (cost of capital) for Newco.

Solutions Step 1 is provided for us in Exhibit 12-1, and Step 2 (the CAPM betas) is given by assumption. If we did not have this assumption, then we could use data on realized returns to estimate betas as in Chapter 4. Because these regressions use realized stock returns, they provide estimates of levered betas, also called **equity betas**. For an all-equity company (or industry), leverage is zero and the levered beta is the same thing as the unlevered beta. If there are other assets in the capital structure, then the levered beta will be different from the unlevered beta. Because our DCF analysis assumes an all-equity company, we may need to unlever the betas of the comparable companies. This unlevering procedure is the task of Step 3.

In theory, the unlevering process is very complex. The exact formulas for unlevering depend on the analyst’s assumption about each company’s capital structure policy, and these formulas can vary across companies and even across time for the same company. Luckily for us, our focus on high-growth companies means that most of the comparable companies will have little or no debt. (Indeed, if a comparable company does have a lot of debt, then perhaps we should rethink whether that company is truly “comparable.”) When debt is small, it does not matter very much which formula is used, so we choose the simplest one. Also, we assume that the debt—and any other component of the capital structure—has a beta of zero. In that case, the relationship between unlevered beta and levered beta can be written as

$$\beta_u = \frac{MC}{EV} * \beta_l \quad (12.7)$$

where β_u is the unlevered (CAPM) beta, β_l is the levered beta, MC is the market capitalization of equity, and EV is the enterprise value.⁴

⁴As discussed earlier, this is only one possible variant of the unlevering formula. Specifically, this variant applies when tax shields are discounted at the unlevered cost of equity, and when all other parts of the capital structure have betas of zero. To read about other variants of this formula, and to learn the conditions under which they are applicable, see Holthausen and Zmijewski (2010).

Using Equation (12.7), we can compute the unlevered betas for the comparable companies. Exhibit 12-1 shows that DEF has no debt, so its $\beta_u = \beta_l = 1.0$. For ABC, we have $MC = 300$ and $EV = 310$, so $\beta_u = 300/310 * 1.5 = 1.45$. For GHI, we have $MC = 150$ and $EV = 170$, so $\beta_u = 150/170 * 2.0 = 1.76$. For JKL we have $MC = 200$ and $EV = 210$, so $\beta_u = 200/210 * 2.0 = 1.90$.

Once we have computed the unlevered betas for all the comparable companies, we move to Step 4 of the procedure and calculate the average of these betas as $(1.0 + 1.45 + 1.76 + 1.90)/4 = 1.53$. Then, for Step 5, we follow the same procedure as in Chapter 4 and use a risk-free rate of 4 percent and an estimated market premium of 7 percent to estimate the cost of capital as

$$r = 0.04 + 1.53 * 0.07 = 14.71 \text{ percent.} \quad (12.8)$$

In Example 12.3, we used the CAPM to estimate the cost of capital. If we want to use a multifactor model such as the FFM or PSM, then all we need to do is compute a separate version of Equation (12.7) for each of the factor loadings, and then substitute the average of these loadings into the appropriate cost of capital equation, analogous to Equation (12.8).

Because the unlevering step takes account of the difference between MC and EV , how should we handle cases like Example 12.2, where companies have excess cash and negative net debt? In theory, there is no difference in the way we handle companies with negative debt. Using Equation (12.7), these companies will typically have unlevered betas *higher* than their levered betas. In practice, we need to take special care that the excess cash situation existed during the estimation period for beta. If the excess cash is a temporary phenomenon, then the estimated betas may not require any adjustment.

SUMMARY

In this chapter, we showed how to perform a relative valuation analysis using comparable companies. The first step in this analysis is to choose comparable companies. To find these companies, we look at all companies in the same industry with revenue close to the forecast successful-exit case. We then choose the subset of these companies with the closest match for predicted investment opportunities, operating margins, and discount rates. Once these companies have been chosen, we compute valuation multiples using a variety of measures and then examine the implied valuations for each company and multiple. Although all multiples provide some information, we pay particular attention to the multiples that provide the most stable estimates (lowest standard deviation) across companies. Comparable companies can also be used to estimate the cost of capital used in DCF analysis. To make these estimates, it is sometimes necessary to unlever the beta estimates for the comparable companies.

KEY TERMS

Comparables analysis = multiples analysis = method of multiples = relative valuation	Enterprise value (EV) Earnings before interest, taxes, depreciation, and amortization (EBITDA)	Geometric mean, harmonic mean Unlevered betas, levered betas
Market capitalization = market cap = equity market value		

REFERENCES

Holthausen, Robert W., and Mark E., Zmijewski, 2010, *Corporate Valuation: Theory, Practice, and Evidence*, forthcoming.

EXERCISES

12.1 Softco, the company valued in Exercise 11.1, is expected to have the following business at exit:

Softco provides business process integration software and services for corporations across a broad range of enterprise markets. Its main product is the Softco business process integration software platform together with packaged applications and content, where it expects to derive 75 percent of its revenue. In addition, the company expects to earn the remainder of its revenue from mainframe outsourcing and midrange systems management.

Use whatever resources you want to identify at least two comparable companies for Softco and to estimate a relative valuation.

12.2 Consider the following “denominators” suggested as part of a comparables analysis:

- (a) Number of unique visitors to a website
- (b) Number of patents held by the company
- (c) Level of dividends paid to common shareholders
- (d) Number of demo software programs downloaded per month

For each of these four denominators, choose the numerator that is most appropriate for doing comparables analysis.

12.3 *True, False, or Uncertain:* The harmonic mean will always provide a lower valuation than the geometric mean, which in turn will always provide a lower valuation than the median.

12.4 *True, False, or Uncertain:* The levered beta for a company is always greater than or equal to the unlevered beta for the same company.

APPENDIX 12.A: POTENTIAL COMPARABLES FOR SEMICO

(Includes all companies in Yahoo! Finance, in the Semiconductors: Integrated Circuits industry, with between \$25M and \$125M in revenue for the 12 months ending closest to September 30, 2009. All these companies traded on the NASDAQ as of January 2010, unless otherwise noted below.)

EXHIBIT 12-A

POTENTIAL COMPARABLES FOR SEMICO

API	ADVANCED PHOT A	(Amex)
WYNX.OB	WAYTRONX INC	(OTC BB)
AXTI	AXT Inc	
SATC	SatCon Technology Corporation	
TXCC	TranSwitch Corporation	
PXLW	Pixelworks, Inc.	
SUPX	Supertex, Inc.	
TUNE	Microtune, Inc.	
PLXT	PLX Technology, Inc.	
VLTR	Volterra Semiconductor Corporation	
EXAR	Exar Corporation	
OIIM	O2Micro International Limited	
PSEM	Pericom Semiconductor Corporation	

PARTIAL VALUATION

This page intentionally left blank

OPTION PRICING

PART III PRESENTS an investment framework that demonstrates how **option pricing** concepts can be efficiently incorporated into VCs' investment decisions.

This chapter provides the crucial building blocks for this framework. Option pricing theory and technology have made considerable progress in the last 35 years, and we are now at a point where most of the complicated mathematical tasks can be automated. Indeed, the main purpose of the model accompanying this book is to provide the automation so that these powerful tools can be used in a fast-moving VC transaction. Nevertheless, to apply these tools properly it is necessary to have at least some exposure to the underlying equations. The exposition in this chapter focuses on the intuition behind these equations with minimum technical detail. Readers interested in these technical details—or in a more comprehensive survey of option pricing—are encouraged to look at Hull (2008).

Throughout Part III, we will make many references to the *VCV* model. Links to updated versions of this model, with documentation, are available at <http://VCVtools.com>. Appendix B of this textbook provides brief descriptions for all the spreadsheets and models used in this book, with particular attention to *VCV*. Nevertheless, readers are encouraged to refer to the most recent version of the model maintained on the websites, as updates and patches are likely.

In Section 13.1 we discuss European options: options that can only be exercised on a preset expiration date.¹ In Section 13.2 we demonstrate how to value a European option using replication techniques. These techniques—with some extra mathematics—form the basis of the famous Black-Scholes equation. In Section 13.3, we examine this equation—derived under the assumption of liquid markets—and discuss its applicability to illiquid private companies. In Section 13.4, we discuss American options, which can be exercised on many possible dates, and in

¹The definitions of European options, their exercises, and expiration dates will be provided in Section 13.1. Other option pricing terms used in this introduction are given in the corresponding sections of the chapter.

Section 13.5 we discuss random-expiration options, where the expiration date is unknown to the option holder. Such random-expiration options are typical for VC, where exit dates for investments are unknown. In Section 13.6 we show how to translate exit diagrams (as first introduced in Chapter 9) as a portfolio of options. In Section 13.7 we reinterpret carried interest as a call option held by GPs on the value of all fund investments.

13.1 EUROPEAN OPTIONS

Financial options are **derivative assets**, with their value derived from an **underlying asset**. The prototypical financial option is the **European call**, which gives the holder the right to buy an underlying asset at a preset **strike price** on an **expiration date**.

For example, consider a European call option to purchase a share of Bigco stock (the underlying asset) in exactly one year for a strike price of \$100 per share. If Bigco is worth less than \$100 per share on the expiration date, then the option holder will choose not to exercise, and the option will expire worthless. If Bigco is worth more than \$100 per share on the expiration date, then the option holder would exercise the option, pay \$100, and earn a profit equal to the difference between the stock price and \$100.

Exhibit 13-1 shows the value of the option as a function of the value of Bigco on the expiration date. We see from the exhibit that there is a direct relationship between the value of the call option and the underlying Bigco stock. We refer to

EXHIBIT 13-1

CALL OPTION

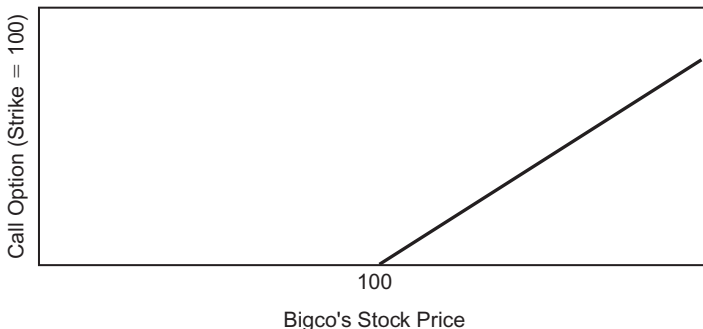

Exhibit 13-1 as an **expiration diagram**—a concept related to the exit diagrams studied in Chapter 9. In an expiration diagram, the date of expiration is known with certainty. In an exit diagram, the date of exit is unknown and random. In Section 13.6, we demonstrate the relationship between these two types of diagrams; for now, we focus on the expiration type.

We can write an equation corresponding to Exhibit 13-1 as

$$\begin{aligned} \text{Value of Call with Strike of 100 on its expiration date} \\ = C_1(100;1) = \text{Max}(V_1 - 100, 0), \end{aligned} \quad (13.1)$$

where V_1 is the value of Bigco on the expiration date. The value of the call option will either be zero (if V_1 is less than or equal to 100) or it will be the difference between V_1 and 100 (if V_1 is greater than 100). We use the operator Max (for “maximum”) to capture this relationship.

In general, the expiration value of a call option with strike price X and expiration date T is written as

$$C_T(X;T) = \text{Max}(V_T - X, 0). \quad (13.2)$$

Another standard option is the **European put**, which gives the holder the right to sell an underlying asset at a preset strike price on an expiration date. For example, consider a European put option to sell one share of Bigco stock (the underlying asset) in exactly one year for a strike price of \$100 per share. On the expiration date, if Bigco is worth more than \$100 per share, then the option holder will choose not to exercise, and the option will expire worthless. If Bigco is worth less than \$100 on the expiration date, then the option holder would exercise the option, receive \$100 of proceeds, and earn a profit equal to the difference between the stock price and \$100. The expiration diagram for this put option is as shown in Exhibit 13-2.

The corresponding equation is

$$\begin{aligned} \text{Value of Put with Strike of 100 on its expiration date} \\ = P_1(100;1) = \text{Max}(100 - V_1, 0). \end{aligned} \quad (13.3)$$

The general equation for the expiration value of a European put option with a strike of X and an expiration of T is

$$P_T(X;T) = \text{Max}(X - V_T, 0). \quad (13.4)$$

Although call options (and their variations) are frequently included in VC transactions, the explicit use of put options is rare, except for their almost standard inclusion as part of the VC’s redemption rights. Recall from Chapter 8 that redemption rights give the investor the option to resell shares back to the firm after some prespecified time period (usually five to seven years) or upon some triggering event. This type of option is a put option, because the strike price is the resale price. Notwithstanding this theoretical interpretation, it is very difficult to exercise this redemption right in practical situations, so we will not attempt to value it.

EXHIBIT 13-2*PUT OPTION***13.2 PRICING OPTIONS USING A REPLICATING PORTFOLIO**

The expiration diagrams show the value of an option on the expiration date, T . Although it is helpful to solve for this date T value (C_T), we also want to know the current (*date 0*) value of the option (C_0).

EXAMPLE 13.1

Suppose that Bigco is currently trading for \$100 per share. We are offered a European call option to purchase one share with an expiration date in one year. We know that on the expiration date Bigco stock will sell for either \$120 per share (a “good day”) or for \$80 per share (a “bad day”). No other prices are possible. The stock will not pay any dividends during the year. Risk-free interest rates are zero, so a bond can be purchased (or sold) for a face value of \$100 and have a certain payoff of \$100 in one year. Stocks, bonds, and options can all be bought or sold, long and short, without any transaction costs.

Problem What is the value of the call option today?

Solution This problem may appear to be impossible on first glance: although we know that there are two possible prices for the stock in one year, we are not told the probabilities of these two prices. It would seem that the answer must depend on these probabilities, but surprisingly it does not. This is the strange reality of option pricing. Instead of using probabilities, we solve for the option price by building a **replicating portfolio** (a combination of the stock and the bond that yields the same exact payoffs as the call option).

First, we draw some pictures. For an example with only two possible outcomes, we can dispense with expiration diagrams and use simple diagrams instead. Because the bond is riskless, it is worth \$100 on both a good day and a bad day.

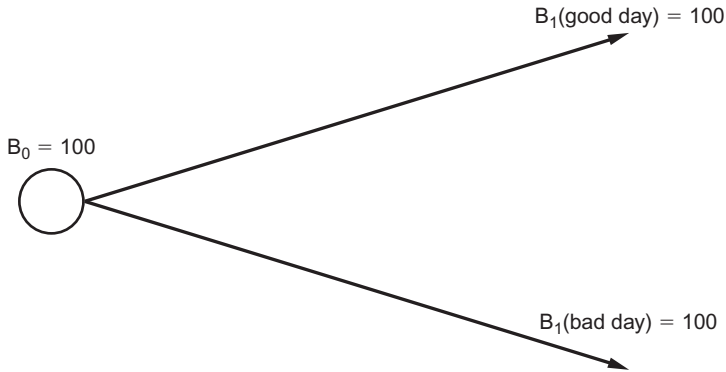
EXHIBIT 13-3*BOND VALUES ON GOOD DAY AND BAD DAY*

The stock is worth \$120 on a good day and \$80 on a bad day:

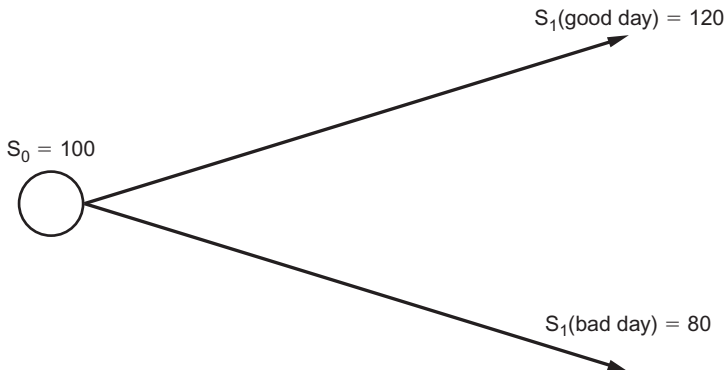
EXHIBIT 13-4*STOCK VALUES ON GOOD DAY AND BAD DAY*

When the stock is worth \$120, the call option would be exercised for a profit of $C_1(\text{good day}) = \$120 - \$100 = \$20$. When the stock is worth \$80, the call option would not be exercised, $C_1(\text{bad day}) = 0$.

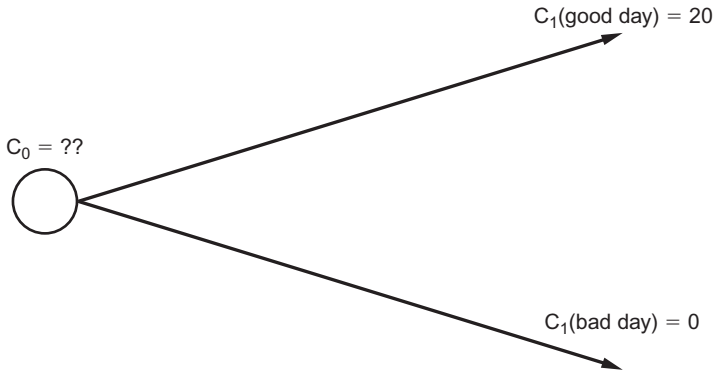
EXHIBIT 13-5*OPTION VALUES ON GOOD DAY AND BAD DAY*

We summarize these outcomes with the equation

$$C_1(100;1) = \text{Max}(S_1 - 100, 0). \quad (13.5)$$

Next, we use some algebra to find the combination of stocks and bonds that provides exactly the same payoff as the option on both possible days. We write an equation for each outcome, good or bad, that takes the form

$$\begin{aligned} \text{Option Value at Expiration (good day or bad day)} \\ = (\text{Shares of Stock}) * (\text{Stock Value}) + (\text{Shares of Bond}) * (\text{Bond Value}). \end{aligned} \quad (13.6)$$

Denoting shares of stock as y and shares of the bond as z , we write the equations as

$$C_1(\text{good day}) = 20 = 120y + 100z, \quad (13.7)$$

and

$$C_1(\text{bad day}) = 0 = 80y + 100z. \quad (13.8)$$

Equations (13.7) and (13.8) give us two equations and two unknowns (y and z), which we can then solve to find that $y = 0.5$ and $z = -0.4$. To check and interpret this solution, we return to the logic of replication: if we purchase 0.5 shares of the stock and sell (“purchase a negative amount”) 0.4 shares of the bond, then we exactly replicate the payoffs to the call option. On a good day, 0.5 shares of stock are worth $\$120/2 = \60 , and 0.4 shares of the bond, $\$40$, needs to be paid back. That transaction will net $\$60 - \$40 = \$20$, the same amount that the call option is worth on the good day. On a bad day, 0.5 shares of stock are worth $\$80/2 = \40 , which is exactly the amount needed to pay back 0.4 shares of the bond. This strategy nets $\$40 - \$40 = \$0$ on the bad day, the same amount as the call option.

These calculations should convince you that the call option provides exactly the same payoffs as 0.5 shares of stock minus 0.4 shares of the bond. Thus, we should expect

that the value of the call option, at time 0, must be exactly the same as the cost of this combination:

$$C_0 = 0.5 * S_0 - 0.4 * B_0. \quad (13.9)$$

Equation (13.9) is an option-pricing formula: it expresses the value of the option today (C_0) in terms of the observable market prices of the underlying stock (S_0) and bond (B_0). We can substitute these prices to find the dollar value of the option as

$$C_0 = 0.5 * 100 - 0.4 * 100 = \$10. \quad (13.10)$$

Thus, the value of the call option today is \$10. ■

Upon first seeing this answer, many people express disbelief. Our solution made no use of any probabilities for the outcomes, nor did we use beta or any other risk measure. How can it be possible to compute the value of the option without accounting for risk?

It is possible because risk should already be incorporated into the stock price. The underlying probabilities of good and bad days, and the correlation of the stock with these good and bad days, should be the main determinant of the stock price. Because we have already shown that the option is effectively just a combination of the stock and bond, there is no additional information to be considered.

Option pricing solutions like this rely on arbitrage. *Arbitrage* is the act of simultaneously buying and selling the same set of cash flows for different prices. In our example, with no transaction costs, let's see how arbitrage would work to keep the price of the option at \$10.

First, suppose that someone was willing to buy the option for \$11. We could arbitrage this buyer by selling her an option for \$11 and then replicating the option payoffs by purchasing 0.5 shares of stock and selling 0.4 shares of the bond. As we showed earlier, this replication strategy costs \$10 and gives the same payoffs as the option on both good and bad days. Thus, today we will pocket the difference (\$11 - \$10 = \$1), and tomorrow we will break even for sure. With this strategy, we could earn \$1 on every option without taking on any risk. We will continue to sell options until the price is driven down to \$10.

The same reasoning in reverse demonstrates that the price cannot be less than \$10. For example, suppose that someone is willing to sell the option for \$9. We could then arbitrage this seller by buying the option from him for \$9 and then replicating this (short) option by selling 0.5 shares of stock and buying 0.4 shares of the bond. This replication strategy will put \$10 in our pocket today, enough to pay \$9 for the option and earn a \$1 profit. As before, the whole transaction will wash out tomorrow. Again, we would be happy to do this transaction until there is nobody left willing to sell the option for less than \$10.

In this example, the interest rate was set to zero for computational convenience. The intuition for the solution is the same for any interest rate. To see this is true, pick some arbitrary riskless rate, r , replace $B_0 = 100$ in Exhibit 13-3 with $B_0 = 100/(1 + r)$ and then work through the same calculations as we used in the example.

13.3 THE BLACK-SCHOLES SOLUTION

Example 13.1 assumes only one discrete point where the stock price could change and only two possible outcomes for this price. This is a great simplification. In principle, the same replication strategy can be used for any number of price changes. In Chapter 22, we will show how to build and solve binomial trees for any finite number of price changes. Things become particularly interesting when we take this process to the limit and allow prices to change continuously. In this case, it is no longer feasible to write a diagram for the infinity of possible outcomes, but the insight of Black and Scholes is that a solution can still be obtained by combining a replication strategy with some clever math. The technical details of their solution are given in option pricing textbooks such as Hull (2008). For our purposes here, it suffices to sketch the assumptions, give the famous formula, and then discuss the intuition behind it.

The Black-Scholes solution requires two sets of assumptions. The first set of assumptions relates to “perfect markets”—markets that are open all the time, allow assets to be traded in any quantity, have no taxes or transaction costs, and have no remaining arbitrage possibilities. All these perfect-market assumptions are necessary to obtain a unique price for the option. The second set of assumptions includes technical restrictions on the statistical properties of stock and bond returns; these restrictions can be relaxed, if necessary, for more general option pricing solutions.

It is obvious that the assumption of perfect markets does not even hold for actively traded public stocks. Thus, it is natural to be skeptical of its relevance for the private markets of VCs. In the “reality check” discussion later, we discuss the implications of these assumptions for private markets. For now, let us suspend our skepticism and assume that the assumptions hold.

Under these assumptions, the Black-Scholes formula for the value of a European call option is

$$C_0 = N(d_1)S_0 - N(d_2)Xe^{-rT}, \quad (13.11)$$

where $N(\cdot)$ is the Normal distribution function and

$$d_1 = [\ln(S_0/X) + (r + \sigma^2/2)T]/(\sigma\sqrt{T}), \quad (13.12)$$

$$d_2 = [\ln(S_0/X) + (r - \sigma^2/2)T]/(\sigma\sqrt{T}) = d_1 - \sigma\sqrt{T}, \quad (13.13)$$

where

- T = years until the expiration date,
- σ = the annual volatility of returns, and
- r = the annual riskless rate.

All stock returns and interest rates in the Black-Scholes framework are expressed as **continuously compounded returns**, also known as **log returns**, because these returns can be calculated as natural log of one plus the periodic return: $\log \text{ return} = \ln(1 + \text{periodic return})$.

The Black-Scholes formula may look complex, but is almost an exact analogue of the simple solution for Example 13.1 given in Equation (13.9). The first terms in these two equations are $0.5 * S_0$ for Equation (13.9) and $N(d_1)S_0$ for Equation (13.11). In both cases, this is a number between 0 and 1 ($N(d_1)$ is the normal distribution function, so it will always give us a probability, which must be a number between 0 and 1) multiplied by the current stock price.

The interpretation of this multiplier is the answer to the question “How much stock would I have to purchase today to replicate the option position?” In Example 13.1, the option could either be worth \$20 (on a good day) or \$0 (on a bad day). The stock could be worth \$120 (on a good day) or \$80 (on a bad day). Thus, the option has a spread of \$20 between good and bad days, and the stock has a spread of \$40 between good and bad days. This means that after we finish the algebra exercise for replication, we end up with one-half of a share of stock ($\$40 \text{ spread} * 1/2$) needed to replicate the \$20 spread for the option. In the Black-Scholes case, the math is more complicated but the idea is the same: after plugging in the inputs to obtain $N(d_1)$, we obtain the fraction of stock needed to replicate a single option.

Next, consider the second term in Equations (13.9) and (13.11). These terms are $0.4B_0$ and $N(d_2)Xe^{-rT}$, respectively. Again, these terms are analogues of each other. The Xe^{-rT} term in Equation (13.10) represents the present discounted value of the strike price. In Example 13.1, we used a riskless bond with a payoff (or strike price) of $B_1 = \$100$. Given this, B_0 turns out to be the price of this bond in period 1, which is also the same thing as the present discounted value of the strike price.

How about $N(d_2)$? This is a number between 0 and 1 that can almost (but not exactly) be thought of as “the probability that we will exercise the option”. Then, the whole term $N(d_2)Xe^{-rT}$ can be interpreted as “the probability that we will exercise the option multiplied by the amount of money that we will need for the strike price if we do actually exercise”. In Equation (13.11), the 0.4 multiplier in front of B_0 serves the same purpose. Of course we have not solved for any actual probabilities, but it is helpful to interpret the multipliers in this way, because it allows us to see the role that they are playing in the more complex Black-Scholes formula.

We are now ready to apply the Black-Scholes formula in an example. In this and all future examples, we will assume that all the Black-Scholes assumptions hold.

EXAMPLE 13.2

Suppose that Bigco is currently trading for \$100 per share. We are offered a European call option to purchase one share with an expiration date in five years. We know that the volatility of Bigco’s stock is 90 percent per year, and that the stock will not pay any dividends during the year. The riskless interest rate is 5 percent.

Problem What is the value of the call option today?

EXHIBIT 13-6*EUROPEAN CALL*

European Call	
Stock Price	100
Strike Price	100
Volatility (%)	90
Risk Free Rate (%)	5
Time to Expiration	5
Call Option Value	72.38

Solution Because Black and Scholes have done all the hard work for us, the solution here is just a matter of plugging numbers into the Black-Scholes formula. We have $r = 5\%$, $\sigma = 90\%$, $X = 100$, $S_0 = 100$, and $T = 5$. We can also use the *European Call Option Calculator* at VCVtools.com to calculate the answer as \$72.38. Output from this Calculator is shown in Exhibit 13-6. ■

REALITY CHECK: Is the Black-Scholes solution reasonable for private companies? The solution requires several assumptions about perfect markets. These include assumptions that markets are open for trading at all times, that there are no taxes or transactions costs, and that there are no remaining arbitrage possibilities. Furthermore, there are additional assumptions about stock and bond returns, including the assumption that the logarithm of stock returns has a normal distribution. Many of these assumptions do not even hold for stocks traded on the New York Stock Exchange, so they will definitely not hold for unlisted private companies. Research has shown that when the perfect market assumptions are dropped, there are many possible option prices that can hold in equilibrium, and without lots of additional information, it is not possible to predict what the exact solution will be. Given these concerns, how should we interpret the Black-Scholes solution for private companies?

Before answering this question, it is important to remember the reason why we do option valuation for private companies in the first place. For public companies, option pricing is often a serious and exact business, because mistakes can lead to arbitrage possibilities for other traders—and those on the wrong side of arbitrage trades can lose money in a hurry. However, the VC problem is different. Here, our goal is to break a complex transaction down into digestible parts to provide guidance to an investor about the relative merits of different deal structures. Having an exact answer would be ideal but it is not crucial. We can live with an approximate answer, as long as the approximation is *unbiased*. An unbiased approximation is sometimes too high and sometimes too low, but the average error

is zero. An unbiased approximation can aid decision making, whereas a biased approximation would be misleading. Thus, the key question is: “Is the Black-Scholes solution an unbiased approximation for private companies?” Concerns about bias fall into two main groups: (1) the need for a “nontradability discount” on the option and (2) the understatement of volatility when using lognormal returns. We address these two concerns next.

Some people argue that there should be a nontradability discount subtracted from the option price. This argument asserts that because standard options can be traded and hedged, and because no investor would prefer to have a restriction on trading, the standard options as priced by Black-Scholes should be worth more than a nontradable option. This argument seems compelling, but we would argue that, for private companies, it is the nontradable options that can be approximately priced by Black-Scholes, whereas the tradable options would be biased. Why? Because the underlying asset here is itself not traded, and any discount for nontradability should already be built into the value of this asset. (Recall the discussion of the liquidity factor in Chapter 4.)

The second main concern about bias comes from the assumption of lognormal returns. The argument is this: “VC investments do not have returns like public companies. Instead, a VC investment often returns absolutely nothing, and occasionally returns a huge amount. This binary type of outcome is not consistent with a lognormal distribution”. There are two responses to this concern. First, it is not true that VC returns are binary. We saw in Chapter 7 that many VC outcomes end up somewhere in the middle. Second, *periodic returns* that are often very low (and only sometimes very high) are consistent with lognormality—and in fact, this is exactly what lognormal returns do look like. Exhibit 13-7 gives an example

EXHIBIT 13-7

FIVE-YEAR COMPOUND RETURNS FOR A LOGNORMAL DISTRIBUTION

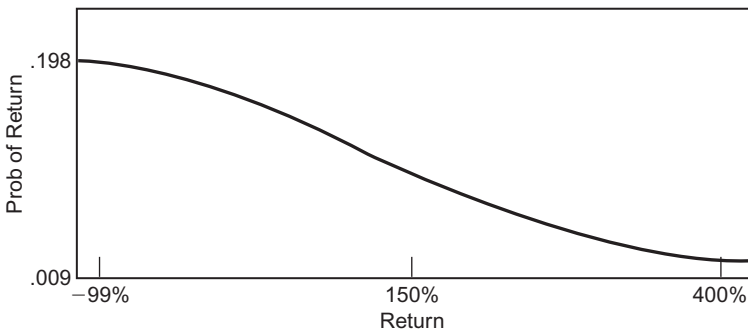

distribution of five-year compound periodic returns using a lognormal distribution with an annual standard deviation of 90 percent.

This exhibit does not appear to be a bell curve; the low outcomes are much more prevalent than the high outcomes, and the high outcomes can be very high. The objection here is usually caused by confusion about the difference between normal distributions (which look like a bell curve when drawn in periodic returns) and lognormal distributions (which look like a bell curve if drawn in log returns, but look like Exhibit 13-7 if drawn in periodic returns.)

This discussion does not attempt to exhaust the possible objections and responses to the use of the Black-Scholes formula to value options on private companies, and no doubt this debate will continue. Nevertheless, it does not yet appear that there is any clear bias in the use of Black-Scholes for these applications, so we will make use of it in the examples in this book.

13.4 AMERICAN OPTIONS

Thus far, we have worked with European options, where exercise is restricted to the expiration date. However, most VC options in practice are **American options**, which allow for exercise at any time until the expiration date. For example, an American call option gives the holder the right to buy an underlying asset at a preset strike price on *or before* an expiration date, and an American put option gives the holder the right to sell an underlying asset at a preset strike price on *or before* an expiration date.

In discussing these options, it is useful to introduce a few more definitions. First, if the strike price is higher than the current stock price, then a call option is **out of the money**. Similarly, if the strike price is lower than the current stock price, then a call option is **in the money**. If the strike price is equal to the current price, then a call option is **at the money**. For put options, we reverse the out of the money and in the money definitions: puts are out of the money when the strike price is below the current price and are in the money when the strike price is above the current price. The at the money definition is the same for puts and calls.

For stocks with no dividends, and for diversified investors without immediate risk management or liquidity concerns, an American call is equivalent to a European call. This is because it is never optimal under these conditions to exercise an American call early. To see why, consider what might occur before expiration. First, if the option is out of the money or at the money, then the investor should certainly not exercise early, because she might as well just buy the (cheaper) stock instead. Second, if the option is in the money, the investor can continue to earn interest on the cash needed for the strike price while still effectively enjoying any price appreciation by waiting to exercise until the expiration date. In this case, waiting has the extra benefit that, if the stock price falls below the exercise price before expiration, the investor will be especially happy that she did not exercise. In these aspects American calls are equivalent to European calls; thus we can use the

same Black-Scholes formula to price both of them. Note that this argument does not apply if the stock pays dividends, because the investor would forego these dividends in exchange for waiting to exercise.

The same logic does not work for put options, because there are some cases where exercising early can be optimal. The reason here is that stock prices cannot fall below zero, so if the price gets very close to zero, it can make sense to exercise a put early and collect the proceeds. Unfortunately, there is no analytical solution leading to a single equation to price American puts, and numerical methods must be used. Lucky for us, put pricing is much less important than call pricing for VC transactions.

13.5 RANDOM-EXPIRATION OPTIONS

Up to this point, all the options we have discussed have had a fixed expiration date. This date might be the only possible time for exercise (European options) or the last possible time (American options), but in either case there is some end point. In VC transactions there are often some special conditions that supersede these rules. For example, as we will show in Chapter 14, convertible preferred stock can be modeled as a bond plus an embedded call option. However, unlike standard call options, this embedded option will have a forced exercise in the case of an IPO or sale of the company, and would expire worthless if the company goes out of business. In general, many liquidity events for the underlying company will force a contemporaneous expiration of the embedded option, and in this situation the investor will face an immediate exercise decision.

The possibility of forced expiration adds another complication to option pricing, but under some reasonable assumptions, it can be handled without much difficulty. For example, take a case where an option has a 50 percent chance of forced expiration in exactly 5 years, with the remaining 50 percent being the chance of forced expiration in exactly 10 years. If this is the case, then we can think of this complex option as the combination of two standard European options: a 50 percent chance of a European call option with expiration in five years plus a 50 percent chance of a European call option with expiration in ten years. Because both of these European call options can be valued using the Black-Scholes formula, then under the assumptions, the combination option can be priced as the expected value of the two standard call options.

The same logic can be used when the option has any number of dates for its possible forced expiration. Suppose that the company's board of directors sits down every month and considers whether the time has come to sell the company, have an IPO, or shut down. If each month is equally probable for exit over a 10-year period, then any options on this company would have 120 possible expiration dates, each with a $1/120$ chance of happening, and the option could be priced at the expected value of 120 European call options with expirations of 1 month, 2 months, and so on, all the way up to 10 years. This calculation is easy for a computer, because all

we need is to repeat the same Black-Scholes formula 120 times with a different input for the expiration date. If we take this process to the limit, then the option would have a continuous-time probability of forced expiration, an infinite number of possible expiration dates, and the expected value of the option would be calculated as an integral of the probability of expiration for any given date multiplied by the Black-Scholes value of the call option with that expiration.

These options with unknown expiration are important for VC valuation problems, so we will develop some new terminology for them. We define a **random-expiration (RE) option** to have a continuous-time probability, q , of forced expiration. This forced expiration is random and is uncorrelated with the performance of the firm or the overall market. RE options do not have fixed expiration dates, but for any q we can compute an expected holding period, H . Conveniently, the math works so that $H = 1/q$. Because “expected holding periods” are more intuitive objects than are “continuous-time probabilities”, we will work through the book with the former. Appendix 13.A gives more details for the derivation of the pricing formula for RE options.

The numerical valuation of RE call options is hard for humans, but easy for a computer; and a template for valuation is available at VCVtools.com (*Random Expiration Call Option Calculator*). The only difference in the inputs between a standard European call and a RE call is that the former gives a time to expiration, T , whereas the latter gives an expected holding period H . The following example is identical to Example 13.2 except for the portion in italics.

EXAMPLE 13.3

Suppose that Bigco is currently trading for \$100 per share. We are offered a *random-expiration* call option to purchase one share with *an expected holding period of five years*. We know that the volatility of Bigco’s stock is 90 percent per year, and that the stock will not pay any dividends during the year. The riskless interest rate is 5 percent.

EXHIBIT 13-8

RANDOM-EXPIRATION CALL

Random Expiration Call	
Stock price	100
Strike price	100
Volatility (%)	90
Risk Free Rate (%)	5
Expected Holding period	5
Call Option Value	60.70

Problem What is the value of the RE call option today?

Solution As in the previous example, the computer does the hard work. We have $r = 5\%$, $\sigma = 90\%$, $X = 100$, $S_0 = 100$, and $H = 5$. The *Random Expiration Call Option Calculator* at VCVtools.com calculates the answer as \$60.70, as shown in Exhibit 13-8. ■

13.6 READING EXIT DIAGRAMS

VCS must often analyze investments with complex payoff structures. In these structures, VCs do not receive explicit call options, but rather have options embedded into other securities, such as convertible preferred stock. Because VCs can make many different rounds of investment, their exit payoffs can look quite complicated, and it can seem at first glance that no sense can be made of the investment. However, we will see that it is often possible to translate these complex investments into a portfolio of options with different strike prices. To do this, we draw exit diagrams where the x -axis shows the value of the whole company, and the y -axis gives the fraction of the company represented by a specific investment. These are exit diagrams, not expiration diagrams, because the date of exit (= expiration of the options) is unknown. Under the assumption that this unknown exit date follows the statistical distribution discussed in Section 13.5, we can read the exit diagrams as a portfolio of random-expiration options.

For example, suppose that EBV invests in Newco across several venture rounds. Exhibit 13-9 represents the value of EBV's investment as a function of the proceeds (\$W) from selling the whole company.

EXHIBIT 13-9

EXIT DIAGRAM FOR EBV'S STAKE IN NEWCO

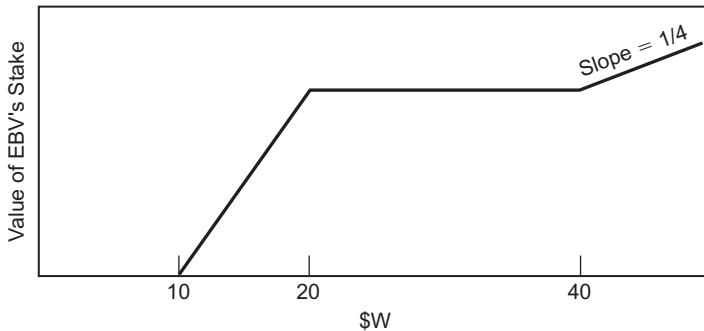

In all exit diagrams in this book, we label the x -axis for all inflection points. We also label all slopes, except for slopes of zero or one, which will always be left unlabeled. As the figure shows, EBV does not receive anything unless there are proceeds of at least \$10M. Between \$10M and \$20M, EBV receives all the proceeds, but it receives none of the proceeds between \$20M and \$40M, and it receives one-quarter of all proceeds above \$40M. It turns out that it is relatively straightforward to interpret this exit diagram into a portfolio of options, which we call an *exit equation*. We call this process *reading the exit diagram*. To do so, we start at the origin of the diagram and read from left to right. At every point that the slope changes, we add (or subtract) a fraction of a call option, with strike price equal to the corresponding point on the x -axis, and the fraction equal to the change in slope at that point.

The first slope change occurs at \$10M, where the slope goes from 0 to 1. We write this as the purchase of a full call option with a strike price of 10: $C(10)$. At \$20M, the slope falls by one, represented by the sale of a full call option: $-C(20)$. Finally, at \$40M, the slope rises to one-quarter: $1/4 C(40)$. Putting this all together yields

$$\text{Exit equation} = C(10) - C(20) + 1/4 * C(40). \quad (13.14)$$

Equation (13.14) is the output of reading Exhibit 13-9 as a portfolio of (random-expiration) call options. Note that we have not put time subscripts on the value of the call options in Equation (13.14). This is because there is no need for time subscripts on the call option values, for even though we use exit diagrams for the reading, the equation holds at all times. In most applications, we will value the options at time zero.

EXAMPLE 13.4

Suppose that Talltree invests in Newco across several venture rounds. After one of these rounds of investments, Talltree draws an exit diagram as shown in Exhibit 13-10.

EXHIBIT 13-10

EXIT DIAGRAM FOR TALLTREE'S STAKE IN NEWCO

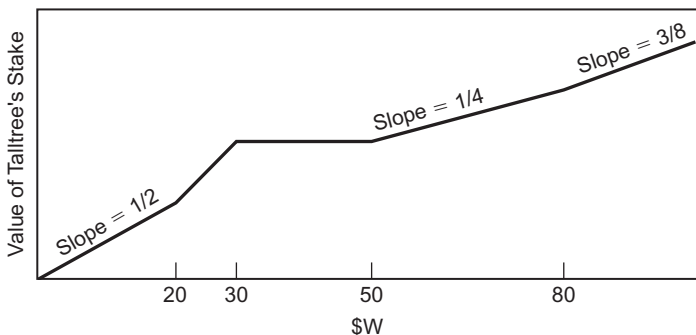

Problem What is the exit equation corresponding to this exhibit?

Solution To answer the question, we read the exit diagram. Talltree will receive one-half of the first \$20M in exit proceeds, all the next \$10M (up to \$30M total), none of the next \$20M (up to \$50M total), one-quarter of the next \$30M (up to \$80M total), and three-eighths of everything after that. In this example, we start with a slope of one-half beginning at the origin. This gives us half of a call option with a strike price of 0: $1/2 C(0)$. A call option with strike price of zero is the same thing as owning the asset outright, so we can also write $1/2 C(0) = 1/2V$, where V is the value of the whole company. At \$20M the slope rises to one, an increase of $1/2$ of a unit: $1/2 C(20)$. At \$30M the slope falls to zero, a reduction of one unit: $-C(30)$. At \$50M the slope rises to one-quarter: $1/4 C(50)$. At \$80M the slope rises to $3/8$, an increase of $1/8$: $1/8 C(80)$. Putting this all together yields

$$\text{Exit equation} = 1/2 * V + 1/2 * C(20) - C(30) + 1/4 * C(50) + 1/8 * C(80). \quad (13.15)$$

13.7 CARRIED INTEREST AS AN OPTION

In Chapter 3, we showed how to estimate the carried interest for a fund by using an estimate for the gross investment multiple combined with knowledge about lifetime fees and the carry%. This approach gave us a simple formula for GP% (Equation (3.15)), which we later used in the modified VC method of Chapter 10. With our new option-pricing tools, we might be tempted to do something fancier. For example, if a GP has 20 percent carried interest with a committed capital basis, then we can draw an exit diagram for carried interest as shown in Exhibit 13-11.

EXHIBIT 13-11

EXIT DIAGRAM FOR CARRIED INTEREST

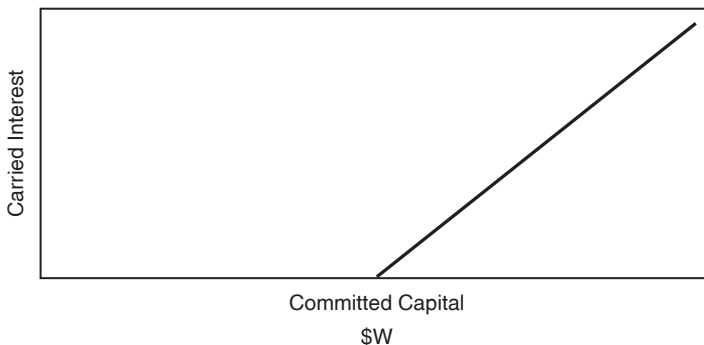

We can read this diagram as

$$\text{Carried Interest} = 1/5 * C(\text{Committed Capital}). \quad (13.16)$$

The underlying asset of this call option is the “portfolio of all fund investments”. For a fund with only one investment, this call option would be easy to compute, because we could use the volatility of that one investment as an input for a single random-expiration option. In general, however, the problem is more complicated because there are multiple investments, each with a different exit date. Furthermore, if the GP loses money on one investment, it will need to make up these losses on other investments before any carried interest is earned.

To a first approximation, these complexities can be modeled by changing the volatility of the underlying option in Equation (13.16). At one extreme, we have the case mentioned earlier: a VC makes only one investment (or many investments, all perfectly correlated). In that case, the volatility of the underlying portfolio would be the same as the volatility of a specific investment. At the other extreme, we can imagine that a single VC fund makes hundreds of investments, with these investments correlated only through their betas in some factor model. In that case, the volatility of the whole portfolio would be approximately the same as the volatility of the underlying factors, as multiplied by their betas. Because a portfolio with hundreds of investments gains the benefit of diversification, the volatility estimate for such a portfolio would be much lower than the corresponding estimate for a single investment. With a lower volatility estimate, we would obtain a correspondingly lower option value in Equation (13.16).

In reality, the volatility of the VC’s portfolio is likely to be somewhere between these two extremes. A typical VC fund makes dozens of investments (not hundreds), and these investments are more correlated than would be implied by factor models. To find the appropriate volatility for this complex portfolio, we will need to use mathematical tools beyond the scope of this textbook. Furthermore, to accurately capture all the variations of carried interest, we need to set up a model that allows for separate treatment of each investment in the fund’s portfolio. In an academic paper, Metrick and Yasuda (2010) perform this exercise and estimate GP % for a wide variety of fee and carry structures. The good news is that these estimates show that the simple formula of Equation (3.15) does a good job of approximating the GP% for the most common carry structures. Thus, for this book, we will use this simple formula in all applications.

SUMMARY

Options often appear in VC transactions, and it is important for investors to learn to spot these options and to obtain approximate values for them. The fundamental option-pricing formula is the Black-Scholes equation. The intuition for this equation comes from building a replicating portfolio from the underlying stock and a riskless bond. By modifying the Black-Scholes formula to account for random expiration, we can make it more applicable to VC

investments. Although the assumptions of the Black-Scholes approach do not hold for private companies, the Black-Scholes solution still seems to be an unbiased approximation for the value of options in these companies.

KEY TERMS

Derivative assets, underlying assets	Replicating portfolio	At the money
Financial options	Black-Scholes formula	Random-expiration (RE) option
European call, European put	Continuously-compounded returns	Expected holding period
Strike price	= log returns	Reading the exit diagram
Expiration date	American option	Exit equation
Expiration diagram	Out of the money	
European put	In the money	

REFERENCES

- Black, Fischer, and Myron Scholes, 1973, "The Pricing of Options and Corporate Liabilities", *Journal of Political Economy* 81(3), 637–654.
- Hull, John, 2008, *Options, Futures, and Other Derivatives*, 7th Edition, Prentice Hall, Upper Saddle River, NJ.
- Metrick, Andrew, and Ayako Yasuda, 2010, "The Economics of Private Equity Funds", *Review of Financial Studies* 23, 2302-2341.

EXERCISES

13.1 Suppose that Bigco is currently trading for \$100 per share. We know that in one year Bigco stock will sell for either \$150 per share ("good day") or for \$75 per share ("bad day"). No other prices are possible, and the stock does not pay any dividends. The riskless interest rate is 5 percent, so a bond worth B_1 next year sells for $B_0 = B_1 / (1 + r)$ today. Stocks, bonds, and options can all be bought or sold, long and short, without any transaction costs.

- What is the value of a European call option with a strike price of \$100 and expiration in one year?
- What is the value of a European put option with a strike price of \$100 and expiration in one year?

13.2 Suppose that Bigco is currently trading for \$100 per share. The stock has an annual volatility of 90 percent and does not pay any dividends. The riskless interest rate is 5 percent.

- What is the value of a European call option with a strike price of \$100 and expiration in 10 years?
- What is the value of a RE call option with a strike price of \$100 and an expected holding period of 10 years?

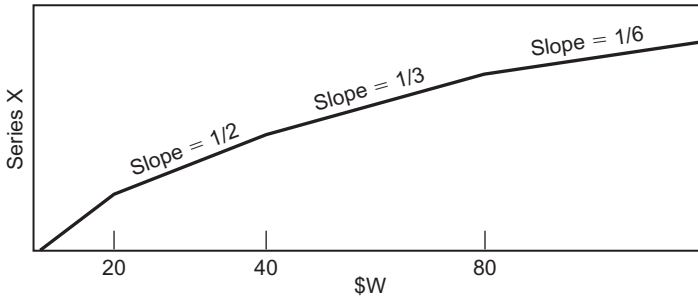
EXHIBIT 13-12**EXIT DIAGRAM FOR OWL'S STAKE IN NEWCO**

13.3 True, False, or Uncertain: Other things equal, an increase in the volatility of the underlying asset will increase the value of call options on that asset.

13.4 Suppose that Owl invests in Newco across several venture rounds. After one of these rounds of investments, Owl draws an exit diagram as shown in Exhibit 13-12.

- What is the portfolio of options corresponding to this exhibit?
- Suppose the founders of Newco own one-half of everything not owned by Owl. What is the portfolio of options corresponding to the founder's ownership?

APPENDIX 13.A

RE OPTIONS: TECHNICAL DETAILS

For RE options, the probability q works much like the continuous compounding of a discount rate. The probability that an option remains alive (does not yet have a forced expiration) on any given date T can be calculated as e^{-qT} , which can be interpreted as a discount factor at T . A plot of this probability for various levels of q is shown in Exhibit 13-13.

To determine the probability of a forced expiration at any time T , we multiply the instantaneous probability of expiration, q , by the probability the option is still alive at that time, e^{-qT} , yielding a probability of qe^{-qT} , which is also the probability distribution function for the exponential distribution. Then, the value of a RE call option is

$$\text{Value of RE call option} = \int_0^{\infty} [SN(d_1) - Xe^{-rT}N(d_2)]qe^{-qT}dT, \quad (13.17)$$

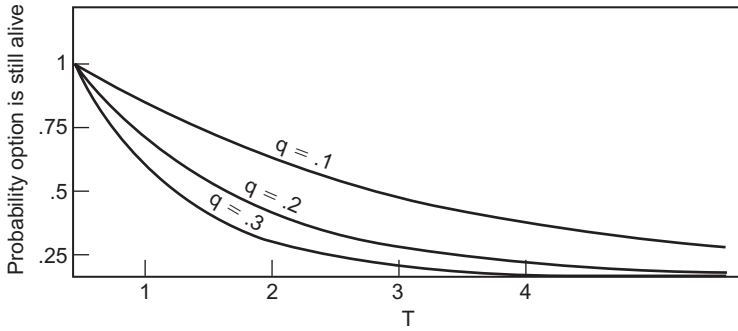
EXHIBIT 13-13*SURVIVAL PLOT FOR RE OPTION*

where the first part of the integrand is defined as in the Black-Scholes formula of Equation (13.11). This integral is solved numerically in the *Random Expiration Call Option Calculator*. Because qe^{-qT} is the probability distribution function for the exponential distribution, we know the mean of this distribution is $1/q$ (the expected holding period). We write this mean value throughout the book as H .

THE VALUATION OF PREFERRED STOCK

ALMOST ALL VC investments include some form of preferred stock. In Chapter 9 we introduced four types of preferred stock: redeemable preferred (RP), convertible preferred (CP), participating convertible preferred (PCP), and participating convertible preferred with cap (PCPC). In Chapter 9 we also demonstrated how to draw exit diagrams for all these types of preferred stock. With the introduction of option-pricing methods in Chapter 13, we are now ready to estimate the partial valuation of preferred stock structures. In this chapter we learn how to value Series A investments with RP and CP structures. We will leave the valuation of later rounds for Chapter 15 and the valuation of PCP and PCPC for Chapter 16. In all these chapters, we make heavy use of term sheet definitions first introduced in Chapters 8 and 9. If your memory of these earlier chapters is hazy, now would be a good time to review.

We begin our analysis in Section 14.1 with a discussion of base-case option pricing assumptions for interest rates, expected holding periods, and volatility. In Section 14.2 we use these assumptions to analyze a Series A structure of RP and common stock. This is the most basic of all structures, and it allows us to introduce some new steps for making investment recommendations. The first step in this valuation is to determine the **redemption value (RV)** of the RP. For RP without dividends or excess liquidation preferences, RV is the same as the aggregate purchase price (APP). Once we have determined the RV, we can draw an exit diagram for the structure and then read this diagram to obtain an exit equation. Then we adjust this exit equation for carried interest to obtain an **LP valuation equation**. At this point, if we already have an estimate for the total valuation, then we can use this estimate in the VCV model to compute the LP valuation. Alternatively, if we do not have an estimate for the total valuation, then we can use the VCV model to compute the **breakeven valuation** that equates LP valuation and LP cost. This breakeven valuation can then be used to inform our investment decision.

In Section 14.3, we show how to extend the analysis for excess liquidation preferences (which make RV greater than APP), and in Section 14.4 we do the same for dividends (which make RV change over time.) In Section 14.5, we analyze CP, and in Section 14.6 we extend the CP analysis for excess liquidation preferences and dividends. Once these building blocks are in place, we can do partial valuations for structures that combine RP and CP (Section 14.7). We can also compare investments with different structures (Section 14.8).

14.1 BASE-CASE OPTION-PRICING ASSUMPTIONS

Before solving any examples, it is helpful to define some *base-case option-pricing assumptions*. Unless otherwise noted, for Series A investments we will assume a riskless interest rate (r) of 5 percent, an expected holding period (H) of 5 years, and a volatility (σ) of 90 percent. For Series B investments we adjust the expected holding period to be 4 years; for Series C and beyond we adjust it to be 3 years. Of these assumptions, the riskless interest rate is the easiest to establish. Although we use 5 percent for the option-pricing examples in Parts III and IV of this book, readers should adjust this number to reflect the prevailing riskless (treasury) interest rate at any time. For the expected holding periods, we rely on (approximate) averages from the Sand Hill Econometrics database, as seen in Exhibits 7-2, 7-5, and 7-8.

The most difficult input is the volatility. For publicly traded stocks, analysts can estimate volatility by looking at historical returns. Of course, this estimation is not possible for nontraded private companies. Instead, we rely on a clever technique developed by Cochrane (2005). In this article, the author begins with a CAPM model of expected (log) returns, similar to Equation (4.2). He then uses the *VentureSource* database to estimate the parameters of Equation (4.2) for the typical VC-backed company. In Chapter 4, we applied this approach to the analysis of returns for the entire VC industry. To extend this analysis to specific companies, we have a sample-selection problem: we only observe returns for a company upon some financing or liquidation event. To solve this problem, Cochrane simultaneously estimated thresholds for IPOs and bankruptcy liquidations. With these thresholds in place, the parameters of the CAPM equation can be estimated, and these parameters then imply means and standard deviations for returns.

Cochrane's procedure can be compared to a physics experiment, where a researcher attempts to infer the motion of particles in a room by using data about how often these particles strike the walls of the room. Using these methods, Cochrane estimates an annualized volatility (standard deviation of continuously compounded returns) of 89 percent. We round this up to 90 percent for the examples in this book. Although he also attempts to estimate different volatilities for different industries and for different rounds of investment, these differences are

usually not statistically significant, so we use the same estimate for all examples. Readers who want to make use of these differences are encouraged to look at Cochrane's article.

14.2 RP VALUATION

In the early years of the VC industry, it was popular for investors to receive both RP and common stock. This combination is useful because the investors are paid back in the event of a deemed liquidation event, but also have upside potential. Since the 1980s, this structure has been rarely used, but it remains a useful building block for understanding the valuation of more popular structures.

In a transaction with RP and common stock, the contract must specify what portion of the investment is being allocated to the RP and what portion is being allocated to the common stock. This allocation is explicit in the APP used for the redemption of the RP. Although this allocation might seem arbitrary, it does matter for valuation, because the RV of the RP is driven by its APP.

EXAMPLE 14.1

Suppose EBV is considering a \$6M Series A investment in Newco. EBV proposes to structure the investment as 5M shares of common stock plus RP with an APP of \$5M. (We will refer to this basket of RP plus common as "the Series A".) EBV estimates the total valuation of Newco at \$18M, and the employees of Newco have claims on 10M shares of common stock. Following the Series A investment, Newco will have 15M common shares outstanding.

Problems

- Compute the LP cost for this investment.
- Solve for the LP valuation equation for this investment.
- Suppose that total valuation is \$18M. What is the LP valuation?
- Find the breakeven valuation for the investment under base-case assumptions.
- Perform a sensitivity analysis for this breakeven valuation.

Solutions

- From Chapter 10, the formula for LP cost is

$$\text{LP cost} = (\text{committed capital}/\text{investment capital}) * \$I. \quad (14.1)$$

From Appendix 2.A, we can compute that lifetime fees are \$20M, so investment capital is \$100M - \$20M = \$80M, and LP cost is = (100/80) * \$6M = \$7.5M.

EBV receives the first \$5M in proceeds for the RP. Following this redemption, EBV owns one-third of the common stock (5M out of 15M shares). Thus, the exit diagram for the Series A is as shown in Exhibit 14-1.

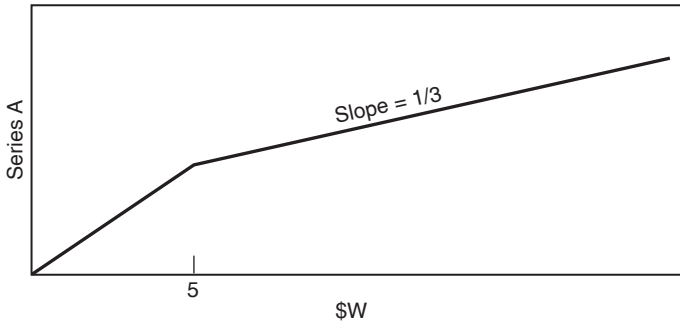
EXHIBIT 14-1**EXIT DIAGRAM FOR THE SERIES A**

We can read this exit diagram as

$$\text{Partial valuation of Series A} = V - 2/3 * C(5). \quad (14.2)$$

To solve for LP valuation, we must subtract carried interest from Equation (14.2). Following the same procedures as in the modified VC method of Chapter 10, we estimate LP and GP valuation as

$$\text{LP valuation} = \text{partial valuation} - \text{GP valuation}, \quad (14.3)$$

where

$$\text{GP valuation} = \text{GP}\% * \text{partial valuation}. \quad (14.4)$$

As in Chapter 10, we estimate GP% using an expected GVM of 2.5 and the formula

$$\text{GP}\% = \text{Carry}\% * (\text{GVM} * \text{Investment Capital} - \text{Carry Basis}) / (\text{GVM} * \text{Investment Capital}). \quad (14.5)$$

For EBV, we have a GP% of $0.20 * (2.5 * 80 - 100) / (2.5 * 80) = 0.10$, which implies an LP valuation equation of

$$\text{LP Valuation} = 0.9 * [V - 2/3 * C(5)]. \quad (14.6)$$

(c) Equation (14.6) expresses the LP valuation of the Series A as a portfolio of options. These options can be valued using techniques similar to those described in Chapter 13. For example, the *FLEX* Calculator at VCVtools.com enables the simultaneous valuation of several options. The user inputs each component of Equation (14.6), and the calculator values these components and adds them together. Using this calculator with base-case option-pricing assumptions and a total valuation assumption of \$18M, we can compute a partial valuation of \$7.92M, of which the LP valuation is \$7.13M and the GP valuation is \$0.79M.

For most of the examples used in this textbook, the *FLEX* Calculator will not be necessary, and we can use built-in valuation functions in the *AUTO* Calculator at VCVtools.com. In the *AUTO* Calculator, users need only to input the properties of the preferred stock and

do not need to solve for the LP valuation equation. The Calculator does this solution automatically and also calculates the specific LP valuation for any set of option-pricing assumptions. Readers are referred to Appendix B for the documentation of *AUTO* and *FLEX*.

(d) The breakeven valuation is the total valuation such that LP valuation = LP cost. In this example, we are solving for the total valuation (V) such that

$$0.9 * [V - 2/3 * C(5)] = \$7.5M. \quad (14.7)$$

Because V is contained in this equation and *also* appears indirectly as the underlying asset in $C(5)$, we must use iterative methods to solve for V . This iterative process is automated in the *AUTO* Calculator, where the breakeven valuation is given as standard output. Under base-case assumptions, the breakeven valuation is \$19.19M. Thus, if EBV believes that the total valuation is \$19.19M or greater, then the model would produce a positive investment recommendation.

Although it may be tempting to minimize work and just use the *AUTO* Calculator to answer these questions, readers are encouraged to experiment with the *FLEX* Calculator to better understand the workings of the model. At some point, every VC will be faced by a complex problem that does not fit into the preprogrammed functions in *AUTO*; when that happens—as in Chapter 18—he will need to understand how to use *FLEX*.

(e) As a general rule, the common stock acts like a call option in transactions with RP. The value of the common stock also increases when volatility or expected holding period increases. Because the Series A holds all the RP and only a portion of the common stock, increases in the common stock—at the expense of the RP—will tend to reduce the partial valuation of the Series A. We can see this effect if we experiment with different option-pricing assumptions. Other things equal, a volatility of 120 percent implies a breakeven valuation of \$20.39M, which is \$1.2M higher than the breakeven valuation under base-case assumptions (i.e., to obtain a positive investment recommendation, EBV would require a higher total valuation by \$1.2M). Similarly, if we use all base-case assumptions but set the expected holding period to be seven years, then the breakeven valuation becomes \$20.01M, which is \$0.82M higher than the base case.

Although increases in volatility or in the expected holding period will tend to increase the breakeven valuation, reductions in these inputs will tend to reduce it. For example, if we start from the base case but change volatility to 60 percent, then the breakeven valuation becomes \$17.90M. Similarly, if we start from the base case but change the expected holding period to be three years, then the breakeven valuation becomes \$17.99M. Exhibit 14-2 displays several combinations of these changes. ■

EXHIBIT 14-2

SENSITIVITY ANALYSIS FOR BREAKEVEN VALUATION

		Volatility		
		60	90	120
Expected	3	16.93	17.99	19.10
Holding	5	17.90	19.19	20.39
Period	7	18.63	20.01	21.18

14.3 EXCESS LIQUIDATION PREFERENCES

As first discussed in Chapter 8, a liquidation preference provides superiority in capital structure in the event that the firm is sold or shut down. Preferred stock has a liquidation preference to common stock, and some classes of preferred stock can be contractually given a liquidation preference to other classes of preferred stock. Excess liquidations preferences of 2X or 3X can provide additional value. For example, suppose a company has 10M shares of common stock and RP with \$10M APP, where the RP has a 2X liquidation preference and thus an RV of \$20M. If the company is then sold, the first \$20M of proceeds (two times the original \$10M) will go to the RP holders, and the remainder will be split among the common shareholders.

EXAMPLE 14.2

Suppose EBV is considering a \$6M Series A investment in Newco. EBV proposes to structure the investment as 5M shares of common stock plus RP with an APP of \$5M. (We will refer to this basket of RP plus common as “the Series A”.) EBV estimates the total valuation of Newco as \$18M, and the employees of Newco have claims on 10M shares of common stock. Following the Series A investment, Newco will have 15M common shares outstanding. This is the same setup as in Example 14.1, except that now we also add a 2X excess liquidation preference on the RP.

Problems

- Compute the LP cost for this investment.
- Solve for the LP valuation equation for this investment.
- Suppose that total valuation is \$18M. What is the LP valuation?
- Find the breakeven valuation for the investment under base-case assumptions.
- Perform a sensitivity analysis for this breakeven valuation.

Solutions

- The LP cost is the same as in Example 14.1 and is equal to \$7.5M.
- With a 2X liquidation preference, the RV is $2 * APP = \$10M$, so EBV receives the first \$10M in proceeds for the RP. Following this redemption, EBV owns one-third of the common stock (5M out of 15M shares). Thus, the exit diagram for the Series A is the same as in Example 14.1, except that the slope does not change until $W = \$10M$.

We can read the exit diagram in Exhibit 14-3 as

$$\text{Partial Valuation of Series A} = V - 2/3 * C(10). \quad (14.8)$$

With $GP\% = 0.10$ (the same as in Example 14.1), we have

$$\text{LP Valuation} = 0.9 * [V - 2/3 * C(10)]. \quad (14.9)$$

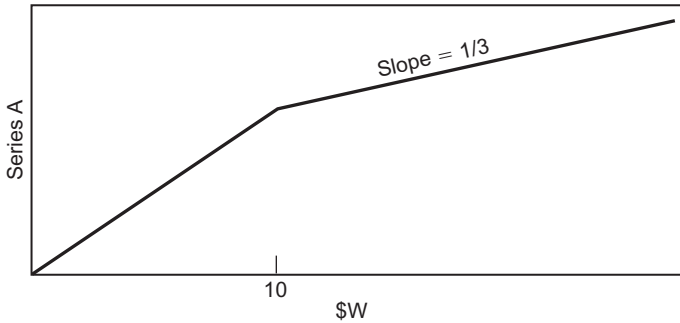
EXHIBIT 14-3*EXIT DIAGRAM FOR THE SERIES A*

(c) Using base-case assumptions with a total valuation of \$18M, we can use the *AUTO* or *FLEX* Calculators to compute LP valuation as \$8.34M. Thus, in contrast to the base case in part (c) of Example 14.1, this computation implies a positive investment recommendation (LP valuation > LP cost).

(d) The *VCV* model gives a breakeven valuation of \$15.64M (i.e., for total valuations above this cutoff, there is a positive investment recommendation).

(e) The option-pricing assumptions have the same effects as in Example 14.1. Increases in volatility or expected holding period would decrease the LP valuation and, thus, increase the breakeven valuation. Exhibit 14-4 demonstrates the sensitivity of the breakeven valuation to changes in the volatility of the expected holding period. ■

EXHIBIT 14-4*SENSITIVITY ANALYSIS FOR BREAKEVEN VALUATION*

		Volatility		
		60	90	120
Expected	3	11.78	13.77	15.59
Holding	5	13.30	15.64	17.58
Period	7	14.47	16.93	18.84

Reality Check: The preceding analysis assumed that liquidation preferences are honored in all outcomes, but it can be a lot messier in reality. In many cases, investors in down rounds of financing will insist that all prior liquidation preferences be wiped out. Thus, we may be overstating the valuation of the liquidation preferences as well as the preferred stock itself.

This is a valid objection that can be addressed in several ways. First, analysts should recognize that the option-pricing valuation of liquidation preferences is essentially providing an upper bound for their value. It would be nice to compute exactly how close this bound is to the “true value”, but given current data and methods, it is not possible to do so. Second, one should not interpret the preceding objection to mean that liquidation preferences are worth nothing. In most successful investments, there are no down rounds, so liquidation preferences can be paid without objection. Even in down rounds, the preferences do provide prior investors with some protections in the form of additional leverage in the negotiation, thus functioning as yet another bargaining chip that investors can put on the table.

14.4 DIVIDENDS

As first discussed in Chapter 8, preferred stock can include a cumulative dividend. This dividend does not pay in cash; instead, it adds to the RV of the preferred and is paid on exit. These dividends can either be a constant amount paid on the APP (simple interest) or can compound on past dividends (compound interest). Including dividends in our analysis is more complex than the inclusion of a liquidation preference because the RV is changing over time. For RP, it does not matter whether the dividend is an accrued cash dividend (= liquidation dividend) or a stock dividend (= PIK dividend). In Example 14.3 we analyze the former case.

EXAMPLE 14.3

Suppose EBV is considering a \$6M Series A investment in Newco. EBV proposes to structure the investment as 5M shares of common stock plus RP with an APP of \$5M. (We will refer to this basket of RP plus common as “the Series A”.) EBV estimates the total valuation of Newco as \$18M, and the employees of Newco have claims on 10M shares of common stock. Following the Series A investment, Newco will have 15M common shares outstanding. This is the same setup as in Example 14.1, except now we also add a cumulative simple dividend of 1 percent per month on the RP, to be paid only if dividends are paid to the common stock or on the liquidation of the company.

Problems

- (a) Compute the LP cost for this investment.
- (b) Solve for the LP valuation equation for this investment.

- (c) Suppose that total valuation is \$18M. What is the LP valuation?
- (d) Find the breakeven valuation for the investment under base-case assumptions.
- (e) Perform a sensitivity analysis for this breakeven valuation.

Solutions

(a) The LP cost is the same as in Example 14.1 and is equal to \$7.5M.

(b) For computational convenience, it is simplest to express the dividend rate as a continuous annual rate, which is approximately equal to 12% (=1.00% * 12) of the APP. Let T equal the time, in years, between investment and exit for proceeds of \$ W . Given this case, the RV of the RP at time T is equal to $RV(T) = \$5M(1 + 0.12T)$ and the exit diagram for the Series A is¹ shown in Exhibit 14-5.

The corresponding exit equation for the Series A is

$$\text{Partial valuation of the Series A} = V - 2/3 * C(RV(T)). \tag{14.10}$$

As in the previous examples, GP% is 0.1, so we can write the LP valuation equation thus:

$$\text{LP valuation of the Series A} = 0.9 * [V - 2/3 * C(RV(T))]. \tag{14.11}$$

EXHIBIT 14-5

EXIT DIAGRAM FOR THE SERIES A

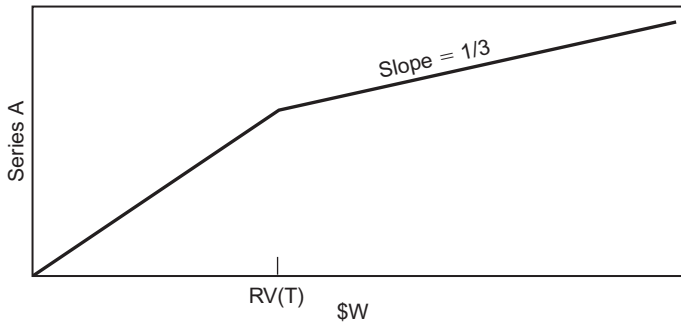

¹For compound dividends of 12 percent, the corresponding formula would be $RV(T) = \$5M * e^{0.12T}$.

EXHIBIT 14-6**SENSITIVITY ANALYSIS FOR BREAKEVEN VALUATION**

		Volatility		
		60	90	120
Expected	3	14.59	16.14	17.61
Holding	5	14.77	16.82	18.52
Period	7	14.97	17.34	19.16

(c) Although these equations are more complex than the analogues from Examples 14.1 and 14.2, it is not a problem for the all-powerful computer. The strike prices for the call options change over time, but because the RE option already requires us to effectively compute a separate Black-Scholes formula at every point in time, the computer doesn't care if the strike price is different in each of these formulas. Using base-case assumptions with a total valuation of \$18M, we can use the *AUTO* Calculator to compute the LP valuation as \$7.89M.

(d) The *VCV* model gives a breakeven valuation of \$16.82M.

(e) The option-pricing assumptions have the same effects as in Examples 14.1 and 14.2. Increases in volatility or expected holding period would decrease the LP valuation and, thus, increase the breakeven valuation. Exhibit 14-6 demonstrates the sensitivity of the breakeven valuation to changes in the volatility of the expected holding period.

14.5 CP VALUATION

As first discussed in Chapter 9, the key step in the valuation of CP is the determination of the conversion condition, an inequality defining the level of proceeds where conversion is more valuable than redemption. We call this level of proceeds the conversion point, and we write the conversion point for a Series A investment as W_A .

The conversion condition is calculated in the partial valuation step. In other respects, the valuation of CP is similar to that for RP and common.

EXAMPLE 14.4

Suppose EBV is considering a \$6M Series A investment in Newco. EBV proposes to structure the investment as 5M shares of convertible preferred stock (CP). The employees of Newco have claims on 10M shares of common stock. Following the Series A investment,

Newco will have 10M common shares outstanding and would have 15M shares outstanding on conversion of the CP.

Problems

- (a) Compute the LP cost for this investment.
- (b) Solve for the LP valuation equation for this investment.
- (c) Find the breakeven valuation for the investment under base-case assumptions.
- (d) Perform a sensitivity analysis for this breakeven valuation.

Solutions

- (a) The LP cost is the same as in Example 14.1 and is equal to \$7.5M.
- (b) We can calculate the conversion condition as

$$1/3 * W > 6 \rightarrow W_A = 18. \tag{14.12}$$

If the proceeds of the liquidation are exactly \$18M, then the investor will receive \$6M for either redeeming or converting. However, if the proceeds are below \$18M, he is better off redeeming. Above \$18M the investor is better off converting. Exhibit 14-7 gives the exit diagram:

EXHIBIT 14-7
EXIT DIAGRAM FOR THE SERIES A

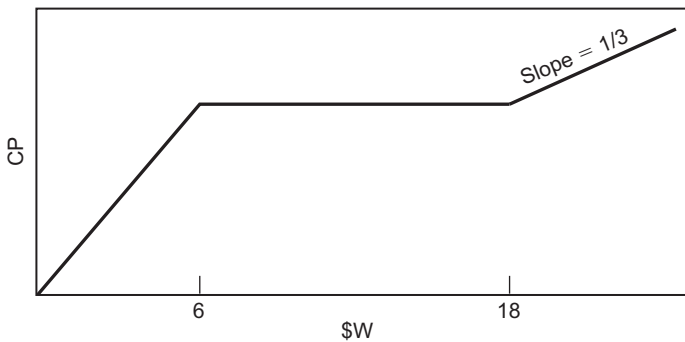

We can read this exit diagram as

$$\text{Partial valuation of Series A} = V - C(6) + 1/3 * C(18). \tag{14.13}$$

Thus, the LP valuation is

$$\text{LP valuation of Series A} = 0.9 * [V - C(6) + 1/3 * C(18)]. \tag{14.14}$$

- (c) With base-case assumptions, we can use the VCV model to solve for a breakeven valuation of \$22.38M.

(d) EXHIBIT 14-8***SENSITIVITY ANALYSIS FOR BREAKEVEN VALUATION***

		Volatility		
		60	90	120
Expected	3	22.50	22.03	22.18
Holding	5	22.47	22.38	22.73
Period	7	22.59	22.68	23.09

Note that these option-pricing sensitivities are smaller than those found for RP structures. The reason for this difference is that CP is harmed less than RP from increases in volatility and holding period because there is no redemption value at extreme levels. In the limit, as either of these inputs approaches infinity, CP looks just like common stock. Indeed, it is possible for an increase in expected holding period (or volatility) to lead to a *decrease* in the breakeven valuation. This can only happen when these inputs start at low levels, as we see when volatility is at 60 percent, and the expected holding period increases from three to five years. To see how this is possible, consider an extreme case where expected holding period (or volatility) is zero. Then the CP would convert for sure for any total valuation above 18M, and thus would be worth exactly the same as the common stock. CP only has some advantage if there is at least some chance that the redemption feature will be used, which requires at least some volatility. For “too much” volatility, the redemption feature becomes relatively worthless (because most redemptions are for close to zero), and the value of the CP once again is close to common stock.

14.6 CP WITH EXCESS LIQUIDATION PREFERENCES OR DIVIDENDS

Earlier in this chapter we gave extended examples for liquidation preferences and cumulative dividends for an RP investment. We will not repeat those whole examples here, but instead will focus only on the parts of the valuation problem that differ from Example 14.4. As in the earlier example, we analyze accrued cash dividends, leaving the more complex analysis of stock dividends for Chapter 15.

EXAMPLE 14.5

Suppose EBV is considering a \$6M Series A investment in Newco. EBV proposes to structure the investment as 5M shares of convertible preferred stock (CP). The employees of

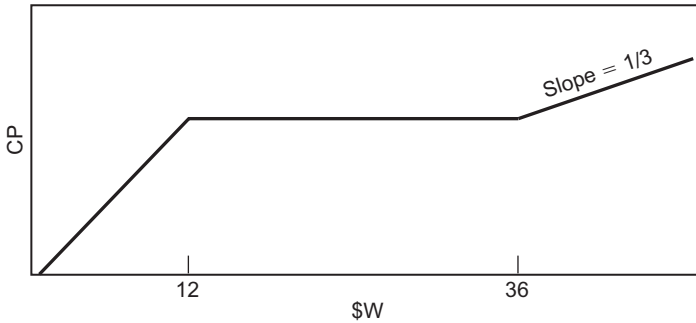
EXHIBIT 14-9**EXIT DIAGRAM FOR SERIES A**

Newco have claims on 10M shares of common stock. Following the Series A investment, Newco will have 10M common shares outstanding and would have 15M shares outstanding on conversion of the CP. This is the same setup as in Example 14.4, except that we now add a 2X liquidation preference on the CP.

Problems

- Find the LP valuation equation for this investment.
- Solve for the breakeven valuation of this investment.

Solutions

(a) The crucial difference between this example and the previous one is that the RV of the CP is now $2 * \$6M = \$12M$. Thus, the new conversion condition is

$$\frac{1}{3} * W > 12 \rightarrow W_A = 36. \quad (14.15)$$

The exit diagram for the CP with a 2X liquidation preference is shown in Exhibit 14-9

We can read Exhibit 14-9 as

$$\text{Partial valuation of the CP} = V - C(12) + \frac{1}{3} * C(36). \quad (14.16)$$

Thus, the LP valuation is

$$\text{LP valuation of the CP} = 0.9 * [V - C(12) + \frac{1}{3} * C(36)]. \quad (14.17)$$

(b) We can use base-case option-pricing assumptions in the VCV model to solve for the breakeven valuation as \$17.67M.



EXAMPLE 14.6

Suppose EBV is considering a \$6M Series A investment in Newco. EBV proposes to structure the investment as 5M shares of convertible preferred stock (CP). The employees of Newco have claims on 10M shares of common stock. Following the Series A investment, Newco will have 10M common shares outstanding and would have 15M shares outstanding on conversion of the CP. This is the same setup as in Example 14.4, except that we now add a cumulative simple dividend of 1 percent per month. This dividend will be paid only if dividends are paid to the common stock or upon the liquidation of the company.

Problems

- (a) Find the LP valuation equation for this investment.
 (b) Solve for the breakeven valuation of this investment.

Solutions

(a) We use the same approach to dividends here as we did in Example 14.3, using a continuous approximation for the dividends and obtaining a redemption value of

$$RV(T) = \$6M * (1 + 0.12T). \quad (14.18)$$

The conversion condition is

$$1/3 * W > RV(T) \rightarrow W > 3 * RV(T), \quad (14.19)$$

which implies an exit diagram as shown in Exhibit 14-10.

This exit diagram looks exactly like Exhibits 14-8 and 14-9, except that the conversion point is at $3 * RV(T) = \$18M * (1 + 0.12T)$. We can read this diagram as

$$\text{Partial valuation of the CP} = V - C(RV(T)) + 1/3 * C(3 * RV(T)). \quad (14.20)$$

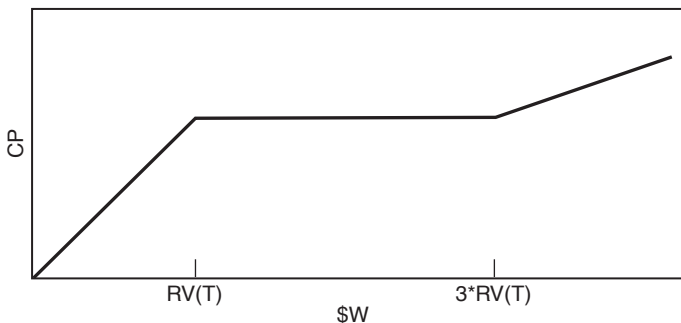
EXHIBIT 14-10**EXIT DIAGRAM FOR SERIES A**

So the LP valuation equation is

$$\text{LP valuation of the CP} = 0.9 * [V - C(RV(T)) + 1/3 * C(3 * RV(T))]. \quad (14.21)$$

(b) The VCV model gives a breakeven valuation of \$19.54M. ■

14.7 COMBINING RP AND CP

In Examples 14.1, 14.2, and 14.3, EBV received a combination of RP and common stock in the Series A investment. A similar payoff structure can be obtained through the combination of RP and CP.

EXAMPLE 14.7

Suppose EBV is considering a \$10M Series A investment in Newco. EBV proposes to structure the investment as 5M shares of CP (\$6M APP) plus RP (\$4M APP). The employees of Newco have claims on 10M shares of common stock. Following the Series A investment, Newco will have 10M common shares outstanding and would have 15M shares outstanding on conversion of the CP.

Problems

- Find the LP valuation equation for this investment.
- Solve for the breakeven valuation of this investment.

Solutions

(a) In this example, there are two types of preferred stock, CP and RP, and there is no statement about which version would be paid first in a liquidation. This structure is very similar to the RP + CP structure that was analyzed as part of Example 9.1. Because EBV owns all of both the CP and the RP, this liquidity preference between the two is not relevant for the aggregate value of the Series A; following Example 9.1, we treat the RP as superior to the CP.

To estimate the partial valuation, we first examine the RP component. Because we have assumed that the RP has a liquidation preference to the CP, we can draw the exit diagram for the RP as Exhibit 14-11.

We can read Exhibit 14-11 as

$$\text{RP in Series A} = V - C(4). \quad (14.22)$$

The CP here is similar to the CP in Example 14.4, except that the CP has no value unless the proceeds are above \$4M. The conversion condition for this CP is

$$1/3 * (W - 4) > 6 \rightarrow W_A = 22. \quad (14.23)$$

To draw an exit diagram for the CP, it is as though we take Exhibit 14-7 and shift the line \$4M to the right:

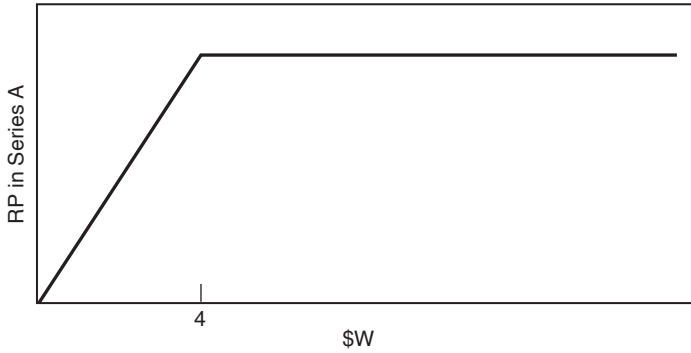
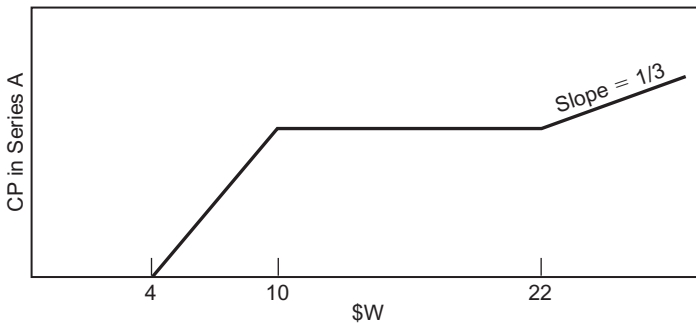
EXHIBIT 14-11*EXIT DIAGRAM FOR SERIES A, RP***EXHIBIT 14-12***EXIT DIAGRAM FOR SERIES A*

We can read Exhibit 14-12 as

$$\text{CP in Series A} = C(4) - C(10) + 1/3 * C(22). \quad (14.24)$$

Then, the partial value of Series A is RP + CP:

$$\text{Partial valuation of Series A} = V - C(10) + 1/3 * C(22). \quad (14.25)$$

and the LP valuation is

$$\text{LP valuation of Series A} = 0.9 * [V - C(10) + 1/3 * C(22)]. \quad (14.26)$$

(b) The LP cost is $\$10M * (100/80) = \$12.5M$. The *AUTO* Calculator solves for a breakeven valuation of $\$34.90M$, where LP valuation = LP cost. ■

14.8 COMPARING RP AND CP

Now that we have done examples with both RP and CP, we are prepared to analyze comparisons between these two structures and the implications of these comparisons for deal structure negotiation.

EXAMPLE 14.8

Suppose that EBV makes an initial offer to Newco as given in Example 14.1, with the offer providing $\$6M$ for RP ($APP = \$5M$) as well as 5M shares of common stock. The only difference here is that we assume that the total valuation of the company is $\$25M$. The entrepreneurs counteroffer with a CP structure. In principle, EBV is not opposed to a CP structure, but they would like to get the same expected value as they would under the RP structure. Thus, they are considering two possibilities for their $\$6M$ investment:

- Structure 1 = RP($\$5M$ APP) + 5M shares of common stock($\$1M$ APP);
- Structure 2 = Z shares of CP($\$6M$ APP)

Problem For what number of shares Z should EBV be indifferent between Structures 1 and 2?

Solution We will answer this question from the perspective of a limited partner in EBV, so the key comparison will be between the LP valuations of the two possible structures. Our goal is to solve for the unknown quantity of shares Z, which would equate the LP valuations of the two structures. We have already solved for the LP valuation of Structure 1 in Example 14.1. That valuation was given in Equation (14.6). Using the VCV model, we can compute the LP valuation as $\$9.32M$ (when the total valuation is $\$25M$).

In Example 14.4 we did most of the work to solve for the LP valuation in Structure 2. The only difference here is that instead of receiving 5M shares on conversion (one-third of the firm), EBV would receive Z shares. These Z shares will convert to a fraction of the firm equal to

$$\text{CP fraction} = Z/(10 + Z). \quad (14.27)$$

We can then write the general conversion condition as

$$Z/(10 + Z) * W > 6 \rightarrow W_A = 6 * (10 + Z)/Z. \quad (14.28)$$

This conversion condition implies an exit diagram for the CP as shown in Exhibit 14-13.

We can read Exhibit 14-13 as

$$\text{Partial valuation (Structure 2)} = V - C(6) + Z/(10 + Z) * C(6 * (10 + Z)/Z), \quad (14.29)$$

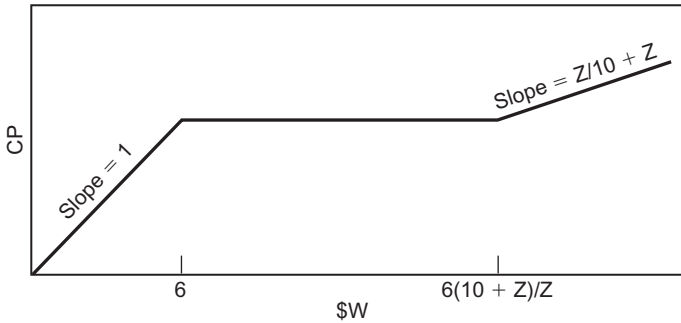
EXHIBIT 14-13**EXIT DIAGRAM FOR SERIES A, STRUCTURE 2**

so we have

$$\begin{aligned} \text{LP valuation (Structure 2)} &= 0.9 * [V - C(6) + Z/(10 + Z) \\ &\quad * C(6 * (10 + Z)/Z)]. \end{aligned} \quad (14.30)$$

Now we are ready to answer the initial question: What value of Z will equate the LP valuations for Structure 1 and Structure 2? This can be answered through trial and error by trying different values for Z , solving for the implied values for the CP fraction and the conversion point, and then using the VCV model to compute the LP valuation with these inputs. We can continue this process by trial and error until we obtain an LP valuation answer of \$9.32M, which is the value we found for Structure 1. It is useful to try this brute-force approach a few times to get a feel for how the valuations change when Z changes. Using this method, we can obtain a solution of $Z = 6.29\text{M}$, yielding a CP fraction of 38.6 percent and a conversion point of \$15.39M. ■

SUMMARY

Venture capitalists typically receive preferred stock for their investments. In one structure, redeemable preferred stock (RP) is combined with common stock to provide both downside protection and upside potential. This combination of securities can be valued using option-pricing techniques. Sometimes the RP component includes additional liquidation preferences that provide the holder with an additional return on a sale or liquidation. Cumulative dividends can also provide the same benefit, and both of these enhancements can be priced using small modifications to our standard techniques.

Convertible preferred (CP) stock is the most prevalent security in VC transactions. CP is a hybrid between RP and common stock, acting like the former when proceeds are low and like the latter when proceeds are high. CP can be valued as a bond plus an embedded call option. The key step in CP valuation is to determine the conversion condition (the level of exit proceeds necessary to induce the CP holder to convert rather than to redeem the stock). Once we have mastered the valuation techniques for CP, we can compare transactions with different types of preferred stock (RP or CP) or with combinations of preferred stock (RP plus CP).

KEY TERMS

Redemption value (RV)

*LP valuation equation**Breakeven valuation*

REFERENCES

Cochrane, John, 2005, "The Risk and Return of Venture Capital", *Journal of Financial Economics* 75(1), 3–52.

EXERCISES

14.1 Suppose EBV is considering a \$5M Series A investment in Newco. EBV proposes to structure the investment as RP with APP of \$4M plus 5M shares of common stock. (We refer to this basket of RP plus common as "Series A".) The employees of Newco have claims on 15M shares of common stock. Following the Series A investment, Newco will have 20M common shares outstanding.

- (a) Compute the LP cost for this investment.
- (b) Solve for the LP valuation equation for this investment.
- (c) Suppose that total valuation is \$30M. What is the LP valuation?
- (d) Find the breakeven valuation for the investment under base-case assumptions.
- (e) Perform a sensitivity analysis for this breakeven valuation.

14.2 Same setup as Exercise 14.1, except that now EBV is considering two additional structures:

Alternative I: A 2X liquidation preference on the RP; or

Alternative II: A cumulative compound dividend of 0.75 percent per month, to be paid only if dividends are paid to the common stock or on the liquidation of the company.

- (a) Find the LP valuation equation for both alternatives.
- (b) Compute the LP valuation for both alternatives under the assumption that total valuation = \$30M. Which alternative should EBV prefer?
- (c) Perform a sensitivity analysis of this preference.

14.3 Suppose EBV is considering a \$5M Series A investment in Newco. EBV proposes to structure the investment as 5M shares of CP. The employees of Newco have claims on 15M shares of common stock. Following the Series A investment, Newco will have 15M common shares outstanding, with another 5M shares on conversion of the Series A.

- (a) Compute the LP cost for this investment.
- (b) Solve for the LP valuation equation for this investment.
- (c) Suppose that total valuation is \$30M. What is the LP valuation?
- (d) Find the breakeven valuation for the investment under base-case assumptions.
- (e) Perform a sensitivity analysis for this breakeven valuation.

14.4 Same setup as Exercise 14.3, except that now EBV is considering two additional structures:

Alternative I: A 2X liquidation preference on the CP; or

Alternative II: A cumulative compound dividend of 0.75 percent per month, to be paid only if dividends are paid to the common stock or on the liquidation of the company.

- (a) Find the LP valuation equation for both alternatives.
- (b) Compute the LP valuation for both alternatives under the assumption that total valuation = \$30M. Which alternative should EBV prefer?
- (c) Perform a sensitivity analysis of this preference.

LATER-ROUND INVESTMENTS

THUS FAR WE have analyzed preferred structures only for Series A (first-round) investments. Although Series A is the simplest setting for learning partial valuation techniques, it is also the least applicable. This is because Series A investments are made in early stage companies, often without any revenue, where it is difficult to perform total valuations. Thus, the partial valuations—which require additional assumptions—are even less reliable.

For more mature companies, valuation analysis can be more precise. In later-round investments, companies often have revenues and sometimes have profits, so there is a stronger basis for the estimation of total valuations. In addition, the path to exit can be clearer, so it is easier to estimate exit values and future dilution. Finally, the required investments often are larger, and the possible investment structures are more complex, so there is a greater importance of getting the numbers right. For these reasons, it is important that we extend our methods to later rounds. In this chapter, we show how to extend our investment framework to Series B and beyond. We will do three examples: Series B (Section 15.1), Series C (Section 15.2), and then, as an example of a very late round, Series F (Section 15.3).

15.1 SERIES B

EXAMPLE 15.1

Talltree is considering a \$12M Series B investment in Newco. Two possible structures are being considered. Structure 1 is 5M shares of common plus RP with \$10M APP and a 2X liquidation preference. Structure 2 is 10M shares of CP. The other investors are the employees, who have claims on 10M shares of common, and the Series A investors, EBV, who have 10M shares of CP with \$6M APP. In both of these structures, Series B has a liquidation preference to Series A. Both Talltree and EBV receive carried interest of 20 percent and charge management fees of 2 percent per year for all 10 years (as shown in the appendices to Chapter 2).

Problems

- (a) What is the LP valuation equation and breakeven valuation for Structure 1?
 (b) What is the LP valuation equation and breakeven valuation for Structure 2?
 (c) Plot the LP valuation for both structures for a range of possible total valuations. For what total valuation should Talltree be indifferent between the two structures?

Solutions (a) The first step is to compute LP cost. Talltree's partnership agreement has the same fee schedule as EBV. On the \$250M Talltree fund, this implies lifetime fees of \$50M and investment capital of \$200M. Thus, the LP cost for a \$12M investment is

$$\text{LP cost} = (\$250\text{M}/\$200\text{M}) * 12\text{M} = \$15\text{M}. \quad (15.1)$$

Next, we estimate partial valuation under Structure 1. With an APP of \$10M on the RP and a 2X liquidation preference, Talltree would receive the first \$20M of the proceeds from any liquidation. After the first \$20M, the next \$6M would go to EBV to cover the RV = APP of their Series A CP. Beyond this point (\$26M), things get trickier. The next dollar of proceeds beyond \$26M would be shared by the common stockholders, but how many shares of common stock are outstanding? The founders have 10M, Talltree has 5M, and because EBV has not yet converted, they have 0. Thus, Talltree has one-third of the outstanding shares, and the founders have two-thirds. These fractions hold unless the proceeds are high enough for EBV to convert, at which point there would be 25M shares outstanding and Talltree would have 5/25. This means that we cannot draw an exit diagram for Talltree until we solve for EBV's conversion point.

To determine EBV's optimal conversion point, we use the same inequality discussed for the conversion of CP in Chapters 9 and 14. On the left-hand side of the inequality, we put the amount earned by EBV if they choose to convert. Under conversion, EBV would have 10M shares, for $10/25 (=2/5)$ of the total shares outstanding. They would then be entitled to two-fifths of the proceeds after \$20M had been paid back to Talltree: $2/5 * (W - 20)$. On the right-hand side of the inequality, we put the amount earned by EBV if they choose to redeem: \$6M. We then solve for the level of proceeds, \$W, that leads to conversion.

Series A conversion condition:

$$2/5 * (W - 20) > 6 \rightarrow W_A = \$35. \quad (15.2)$$

This inequality completes the picture for all parties. For proceeds of \$35M or more, EBV converts and owns 2/5 of the outstanding shares, Talltree owns 5/25 (=1/5), and the founders own the remaining two-fifths. With this final piece, we are prepared to draw an exit diagram for the Series B.

Exhibit 15-1 shows Talltree receiving the first \$20M of proceeds to pay for their 2X liquidation preference, nothing of the next \$6M, one-third of the next \$9M (until $W = \$35\text{M}$), and then one-fifth thereafter. We can read this diagram as

$$\begin{aligned} \text{Partial valuation of Series B (Structure 1)} = & V - C(20) + 1/3 * C(26) \\ & - 2/15 * C(35). \end{aligned} \quad (15.3)$$

Because Talltree has carried interest of 20 percent (see Appendix 2.B), the computation of GP% (when the expected gross value multiple is 2.5) gives the same answer as it did for EBV (=0.10) and we have

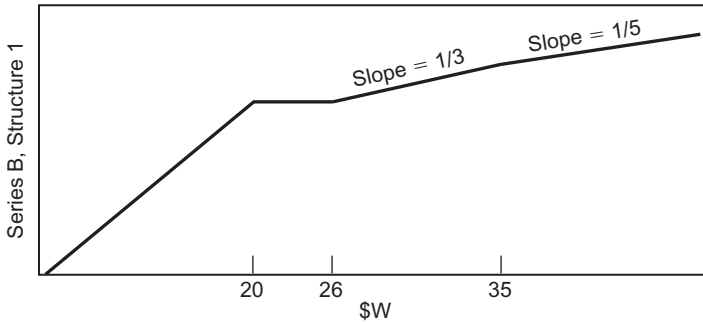
EXHIBIT 15-1**EXIT DIAGRAM FOR SERIES B, STRUCTURE 1**

$$\begin{aligned} \text{LP valuation of Series B (Structure 1)} &= 0.9 * [V - C(20) \\ &+ 1/3 * C(26) - 2/15 * C(35)]. \end{aligned} \quad (15.4)$$

Using the VCV model, we can compute the breakeven valuation as \$39.32.

(b) We begin again with the LP cost, which is \$15M, the same as in part (a). Next, we need to compute the partial valuation for Structure 2. For low levels of proceeds, the exit diagram is easy to draw. Talltree receives the first \$12M of proceeds to cover redemption of Series B, and EBV receives the next \$6M of proceeds to cover redemption of Series A. Proceeds above \$18M are shared by the common stock holders, but how many of these shares are outstanding?

Both Series A and Series B are CP. The first step in this case—and in all cases with more than one round of CP—is to determine the order of conversion. This step is tricky, because each investor's conversion decision depends on whether the other investor has already converted.

To determine the order of conversion, we first compute the conversion point for each investor under the assumption that the other investor has *not* converted. Consider Talltree's decision. Assume that proceeds are above \$18M, because no investor would convert before the APPs have been paid back at \$18M. After that point, if EBV does not convert the Series A, then Talltree could either receive \$12M for redemption or $1/2 * (W - 6M)$ for conversion. (After conversion, Talltree would have 10M shares, and the employees would have 10M shares, while \$6M would be paid to redeem the Series A.) Thus, if EBV does not convert, Talltree's conversion condition would be

Series B conversion condition—Series A not converted:

$$1/2 * (W - 6M) > 12M \rightarrow W_B = \$30M. \quad (15.5)$$

For EBV, if Talltree does not convert the Series B, then EBV would receive \$6M if they redeem the Series A, and $1/2 * (W - 12)$ if they convert. This implies a conversion condition of

Series A conversion condition—Series B not converted:

$$1/2 * (W - 12M) > 6M \rightarrow W_A = \$24M. \quad (15.6)$$

A comparison of Equations (15.5) and (15.6) shows that EBV (Series A) would convert “first”, with a conversion point of $W_A = \$24M$.

Now that we know that Series A converts first, we revisit Talltree’s conversion decision. Equation (15.5) is no longer relevant, because it was derived under the assumption that the Series A did not convert. If the Series A does convert, then the Series B is still worth \$12M on redemption. If the Series B converts, however, it would be worth $1/3 * W$, because 10M shares would now be one-third of the total. This implies a new conversion condition of *Series B conversion condition—Series A converted*:

$$1/3 * W > 12M \rightarrow W_B = \$36M. \quad (15.7)$$

With the conversions solved, we are ready to draw an exit diagram for the Series B under Structure 2:

EXHIBIT 15-2

EXIT DIAGRAM FOR SERIES B, STRUCTURE 2

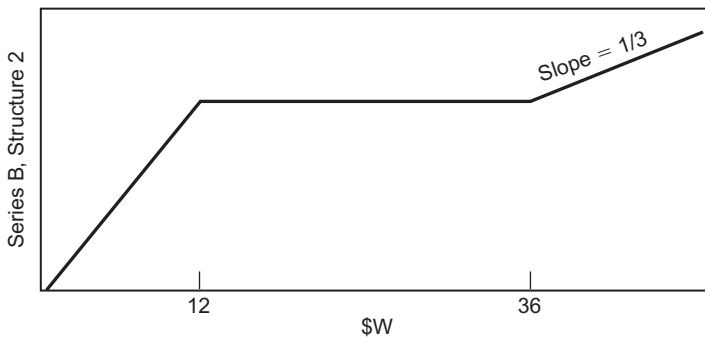

This exhibit shows that Talltree receives everything from the first \$12M. After that, they will receive nothing until they convert for one-third of the common stock at \$36M. The corresponding exit equation for Exhibit 15-2 is

$$\text{Partial valuation of the Series B (Structure 2)} = V - C(12) + 1/3 * C(36). \quad (15.8)$$

The LP valuation equation is

$$\text{LP valuation of the Series B(Structure 2)} = 0.9 * [V - C(12) + 1/3 * C(36)]. \quad (15.9)$$

Using the VCV model, we can compute the breakeven valuation as \$44.36M.

(c) Now, for each LP valuation Equations [(15.4) and (15.9)], we can use the VCV model and base-case option pricing assumptions to compute an LP valuation for any given level of total valuation. Because this is a Series B investment, our base-case assumption is an expected holding period of four years. Exhibit 15-3 plots LP valuation for each structure. The crossing point occurs at a total valuation of \$61.25M, where both structures yield LP valuations of

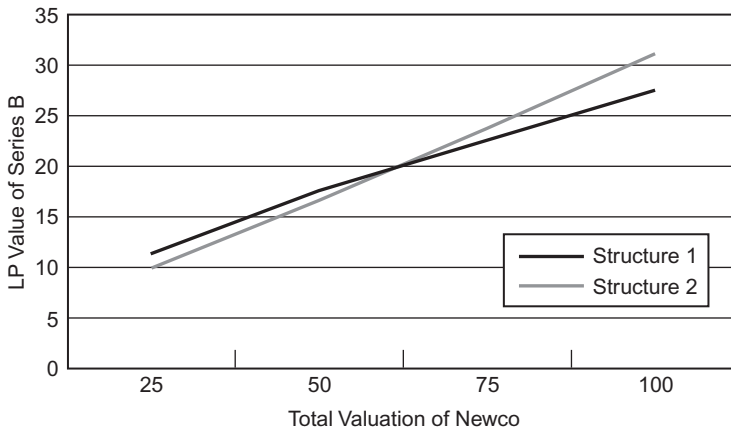
EXHIBIT 15-3*LP VALUATION OF SERIES B, STRUCTURES 1 AND 2*

\$19.80M. That is, for a total valuation below \$61.25M, Talltree should prefer Structure 1; for a total valuation above \$61.25M, Talltree should prefer Structure 2. ■

After analyzing Series B structures, many students wonder why we don't try to account for later investments when we first analyze the Series A. Put another way, why is it all right to just ignore future rounds when we draw exit diagrams? Because these future rounds will change the exit diagrams of the earlier rounds, how can these early round diagrams be correct?

To answer these questions, it is helpful to put ourselves in the shoes of a Series A investor like EBV. At the time of a Series A investment in Newco, EBV fully expects more investments to be made. Although other investors may lead these later rounds, EBV may invest in these rounds as well. In either case, as an investor in the company, EBV has the incentive to drive the best possible bargain for the company in later rounds. Indeed, the board of directors of Newco has a legal duty to get the best deal. If the VC market is competitive—and all evidence says that it is—then these later-round investments should be priced at “fair” levels. In this case, even through the Series A exit diagrams will change, they should change in a way that preserves the pre-transaction value of the Series A stake. We can draw an analogy here to the DCF analysis of Chapter 11. There, if some future investment earns exactly the cost of capital, this investment has no effect on valuation today. It is the same thing here: if future rounds are sold at a fair price that reflects the cost of venture capital, then these rounds have no effect on the valuation of any stake today.

15.2 A CONVERSION SHORTCUT

To determine the conversion order in Structure 2 of Example 15.1, we derived a conversion condition for each investor under the assumption that the other investor did not convert. When there are only two investors, this does not take much time. However, this procedure can become unwieldy when there are three or more investors; because in addition to determining which investor converts first, we must then repeat the process to determine which investor converts second, third, and so on.

Luckily, a shortcut greatly simplifies the task of determining conversion order. Recall the first conversion condition tried for the Series B in Example 15.1:

Series B conversion condition—Series A not converted:

$$1/2 * (W - 6M) > 12M \rightarrow W_B = \$30M. \quad (15.5)$$

This condition means that if EBV does not convert the Series A, then Talltree would convert the Series B as long as total proceeds are at least \$30M. Now, let's interpret this equation another way. If, for proceeds of \$30M, Talltree decides to convert and EBV does not, then there would be 20M total shares outstanding, and the total amount available for the common stock holders would be $\$30M - \$6M = \$24M$, because \$6M would be needed to pay back EBV when they redeem the Series A. Thus, the value of each common share would be $\$24M/20M = \1.20 per share. This means that, in this case, we can say that Talltree will convert if they receive at least \$1.20 per share.

The \$1.20 number is the *redemption value per share (RVPS)* of the CP: the RVPS of preferred stock is equal to the total redemption value of the preferred divided by the number of common shares received on conversion. In this case, the CP has 12M APP and could convert to 10M shares, $\$12M/10M = \1.20 per share. We will get the same RVPS of \$1.20 no matter how many other investors have already converted. To illustrate this point, consider Equation (15.7), the conversion condition for the Series B when the Series A has already converted:

Series B conversion condition—Series A converted:

$$1/3 * W > 12M \rightarrow W_B = \$36M. \quad (15.7)$$

With Series A already converted, there will be 30M shares outstanding on conversion of Series B. Thus, \$36M available to the common stock holders is equivalent to an RVPS of $\$36M/30M = \1.20 per share.

It is also helpful to review Equation (15.6), EBV's conversion condition for the Series A in the case where the Series B has not converted:

Series A conversion condition—Series B not converted:

$$1/2 * (W - 12M) > 6 \rightarrow W_A = \$24M. \quad (15.6)$$

For proceeds of \$24M, if Series A converts and Series B does not, then there would be 20M total shares outstanding, and the total amount available for the common stock holders would be $\$24M - \$12M = \$12M$, because \$12M would be needed to

pay back Talltree when they redeem the Series A. Thus, the value of each common share would be $\$12\text{M}/20\text{M} = \0.60 per share. It is easy to verify that this number is exactly the same as the RVPS of the Series A ($\$6\text{M}/10\text{M} = \0.60).

For Structure 2 in Example 15.1, we found that the Series A converted before the Series B. We also find that the Series A has a lower redemption value per share than does the Series B ($\$0.60$ versus $\$1.20$). These two results are logically connected through the *conversion-order shortcut*: the order of CP investors by their RVPS, from lowest to highest. The investors will convert in the order of their RVPS (i.e., the lowest RVPS will convert first, the second-lowest RVPS will convert second, and so on, and the highest RVPS will convert last). To demonstrate the application of this shortcut, we do an example of a Series C investment.

15.3 SERIES C

In computing valuations for Series C, we follow the same steps as for Series B. The analysis is more complicated because of the large range of possible structures across three rounds. Despite this added complexity, the building blocks of any partial valuation analysis remain the same no matter how many rounds of investment have already occurred.

EXAMPLE 15.2

Begin with the same setup as in Example 15.1. Assume that Talltree chose Structure 2 and invested $\$12\text{M}$ in a Series B round for CP. It is now one year later, and Owl is considering a $\$10\text{M}$ Series C investment in Newco. Structure 1 is 5M shares of common plus RP with $\$8\text{M}$ APP and a 3X liquidation preference. Structure 2 is 10M shares of CP. The other investors are (1) the employees, who have claims on 10M shares of common, (2) the Series A investors, EBV, who have 10M shares of CP for $\$6\text{M}$ APP, and (3) the Series B investors, Talltree, who have 10M shares of CP for $\$12\text{M}$ APP. In both structures, Series C has a liquidation preference to Series B, which in turn has a liquidation preference to Series A. Neither of the previous investors is covered by antidilution protection. As shown in Chapter 2, the $\$500\text{M}$ Owl fund has a 25 percent carry and $\$83.75\text{M}$ in lifetime fees.

Problems

- What is the LP valuation equation and breakeven valuation for Structure 1?
- What is the LP valuation equation and breakeven valuation for Structure 2?
- Plot the LP valuation for both structures for a range of possible total valuations. For what total valuation should Owl be indifferent between the two structures?

Solutions (a) The first step is to compute LP cost. The $\$500\text{M}$ Owl fund has lifetime fees of $\$83.75\text{M}$ and investment capital of $\$416.25\text{M}$. Thus, the LP cost is

$$\text{LP cost} = (500/416.25) * 10\text{M} = \$12\text{M}. \quad (15.10)$$

Next, we estimate partial valuation under Structure 1. With an APP of \$8M on the RP and a 3X liquidation preference, Owl would receive the first \$24M of the proceeds from any liquidation. After the first \$24M, the next \$12M would go to Talltree to cover the RV of their Series B CP, and the next \$6M would go to EBV for RV of the Series A CP. Beyond this point (\$42M), we have to figure out the order of conversion for Series A and Series B. In the previous section, we computed the RVPS for the Series B as \$1.20 per share and for the Series A as \$0.60 per share. The Series A is lower, so it converts first.

When EBV converts the Series A, they will own two-fifths (10M/25M) of the remaining proceeds ($W - 36M$). We obtain their conversion condition by comparing this value to the \$6M RV for redemption. Thus, EBV converts the Series A when

Series A conversion condition—Series B not converted:

$$2/5 * (W - 36M) > 6M \rightarrow W_A = \$51M. \quad (15.11)$$

Once EBV converts, then Talltree would own two-sevenths (10M/35M) of the remaining proceeds ($W - 24M$) when they convert, or \$12M if they redeem. Thus, Talltree's conversion condition is

Series B conversion condition—Series A converted:

$$2/7 * (W - 24M) > 12M \rightarrow W_B = 66M. \quad (15.12)$$

With this information, we are prepared to draw an exit diagram for Series C (Structure 1), as shown in Exhibit 15-4.

EXHIBIT 15-4

EXIT DIAGRAM FOR SERIES C, STRUCTURE 1

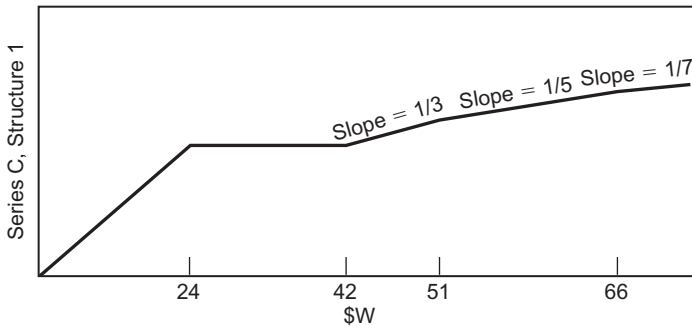

For the Series C, Owl gets all of the first \$24M in proceeds, nothing for the next \$18M while Series A and B are being paid back, and then one-third of all proceeds (because they will own 5M out of 15M shares of common) until the Series A is converted at $W = \$51M$. For proceeds between \$51M and \$66M, Owl owns one-fifth of the common stock (5M/25M). After the Series B is converted at $W = \$66M$, Owl owns one-seventh of the common (5M/35M). We can read Exhibit 15-4 as

$$\begin{aligned} \text{Partial valuation of Series C (Structure 1)} = V - C(24) + 1/3 * C(42) \\ - 2/15 * C(51) - 2/35 * C(66). \end{aligned} \quad (15.13)$$

Owl has carried interest of 25 percent, which is higher than the industry-standard 20 percent carried interest charged by EBV and Talltree. With an expected gross value multiple of 2.5, Owl has GP% of $0.25 * (2.5 * 416.25 - 500) / (2.5 * 416.25) = 0.13$. Thus, the GPs receive an expectation of 13 percent of the partial valuation, and the LPs receive an expectation of 87 percent.

$$\begin{aligned} \text{LP valuation of Series C (Structure 1)} = 0.87 * [V - C(24) + 1/3 * C(42) \\ - 2/15 * C(51) - 2/35 * C(66)]. \end{aligned} \quad (15.14)$$

Using the VCV model, we can compute the breakeven valuation as \$25.32.

(b) For Structure 2, we have the same LP cost as in Structure 1: \$12M. To complete the next step, the partial valuation of the Series C, we must first determine the conversion order. Things look more difficult than in earlier examples because we now have three different rounds of CP, but we can apply the conversion-order shortcut to keep things from getting too messy. We already know the RVPS for Series A and B to be \$0.60 and \$1.20, respectively. For Series C, we can compute the RVPS as $\$10M/10M = \1.00 per share. Thus, the conversion order is Series A, then Series C, then Series B. With this ordering determined, we can compute each conversion point.

EBV (Series A) converts first. Series B and C have not yet converted. When EBV converts, they receive 10M shares and get half ($10M/20M$) of all proceeds after the Series B and C have been redeemed ($W - 22M$). To obtain their conversion condition we compare this value to the redemption proceeds of \$6M:

Series A conversion condition—B and C not converted:

$$1/2 * (W - 22) > 6 \rightarrow W_A = \$34M. \quad (15.15)$$

Next to convert is Owl (Series C). Series A has converted and Series B has not. When Owl converts, they receive 10M shares, the founders will have 10M shares, and EBV will have 10M shares, for a total of 30M shares outstanding. Thus, Owl will receive $10M/30M =$ one-third of any proceeds after the Series B has been redeemed ($W - 12M$). To obtain their conversion condition, we compare this value to the redemption proceeds of \$10M:

Series C conversion condition—A converted, B not converted:

$$1/3 * (W - 12) > 10 \rightarrow W_c = \$42M. \quad (15.16)$$

Series A and C have already converted, so last to convert is Talltree (Series B). Upon conversion, Talltree receives 10M shares for a total of 40M shares outstanding. Thus, Talltree would be entitled to one-fourth of the total proceeds, $\$W$, because there are no other preferred shares outstanding to be redeemed before the common stock. A redemption value of \$12M implies a conversion condition of

Series B conversion condition—Both A and C already converted:

$$1/4 * W > 12 \rightarrow W_B = \$48M. \quad (15.17)$$

We are now ready to draw an exit diagram for the Series C. As holders of the Series C, Owl would receive the first \$10M of proceeds, and then would not receive anything else until they choose to convert at $W = \$42M$. Upon conversion, Owl would own one-third of the

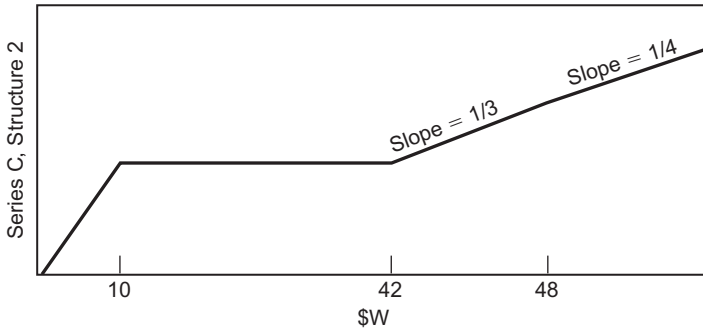
EXHIBIT 15-5**EXIT DIAGRAM FOR SERIES C, STRUCTURE 2**

common. When Talltree converts the Series B at $W = \$48M$, Owl would then own $10M/40M = 1/4$ of the common.

We can read Exhibit 15-5 as

$$\begin{aligned} \text{Partial valuation of Series C (Structure 2)} = & V - C(10) + 1/3 * C(42) \\ & - 1/12 * C(48). \end{aligned} \quad (15.18)$$

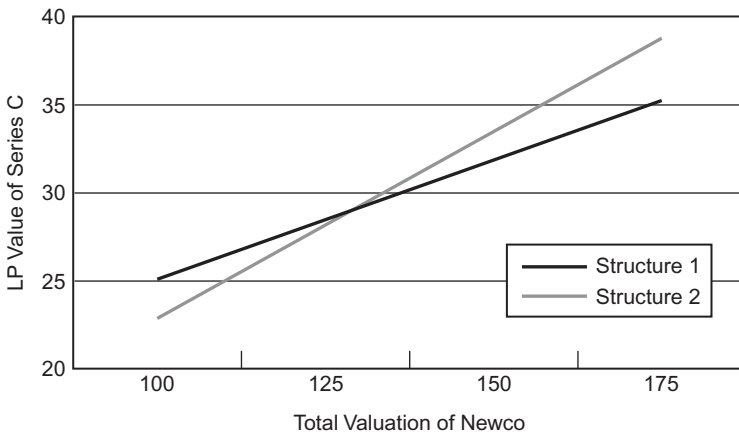
EXHIBIT 15-6**LP VALUATION OF SERIES C, STRUCTURES 1 AND 2**

Then, the LP valuation equation is

$$\text{LP valuation of Series C (Structure 2)} = 0.87 * [V - C(10) + 1/3 * C(42) - 1/12 * C(48)]. \quad (15.19)$$

Using the VCV model, we can compute the breakeven valuation as \$47.37.

(c) Now, for each LP valuation Equation (15.14) and (15.19), we can use the VCV model and base-case option-pricing assumptions to compute an LP valuation for any given level of total valuation. Because this is a Series C investment, our base-case assumption is an expected holding period of three years. Exhibit 15-6 plots LP valuation for each structure.

The crossing point occurs at a total valuation of \$130.5M, where both structures yield LP valuations of \$29.28M. That is, for a total valuation below \$130.5M, Owl should prefer Structure 1; for a total valuation above \$130.5M, Owl should prefer Structure 2. ■

15.4 DIVIDENDS IN LATER ROUNDS

Many VC investors receive dividends on their preferred shares. In Chapter 14 we showed how to incorporate accrued cash dividends into the valuation of Series A investments. For later-round investments, we must carefully analyze how dividends can affect the conversion order and conversion conditions for each round. In Section 15.4.1., we show how to do this for accrued cash dividends. In Section 15.4.2, we consider the case of stock dividends (= PIK dividends).

15.4.1 Accrued Cash Dividends

EXAMPLE 15.3

We begin with the same setup as in Example 15.2. We assume that Owl chose Structure 2: a \$10M investment for 10M shares of CP (APP = \$10M). The other investors are (1) the employees, who have claims on 10M shares of common; (2) the Series A investors, EBV, who have 10M shares of CP for \$6M APP; and (3) the Series B investors, Talltree, who have 10M shares of CP for \$12M APP. Series C has a liquidation preference to Series B, which in turn has a liquidation preference to Series A. The new wrinkle we introduce here is that all preferred investors—Series A, B, and C—have cumulative accrued cash dividends of 1.00% per month, to be paid only on a deemed liquidation event.

Problem Find the conversion order and conversion conditions for all investors.

Solution We first solve for the conversion order. First, let T be the time elapsed since the latest round (Series C in this example). We differentiate this from T_X , the time elapsed since the time Series X took place. In this case, Series A was two years ago and Series B was one year ago, so $T_A = T + 2$, $T_B = T + 1$, and $T_C = T$.

To obtain the RVPS for each series, we can write the RV at time T as

$$RV_X(T) = RV_X(\text{at issue of Series } X) * (1 + 0.12T_X) \quad (15.20)$$

where the subscript “X” represents Series A, B, or C. Then, the RVPS for each Series will also be a function of T and can be written as

$$\begin{aligned} RVPS_A(T) &= (1 + 0.12T_A) * \$6M/10M = (1 + 0.12 * (T + 2)) * \$0.6 \\ &= \$0.74 + 0.072 T \end{aligned} \quad (15.21)$$

$$\begin{aligned} RVPS_B(T) &= (1 + 0.12T_B) * \$12M/10M = (1 + 0.12 * (T + 1)) * \$1.2 \\ &= \$1.34 + 0.144 T \end{aligned} \quad (15.22)$$

$$RVPS_C(T) = (1 + 0.12T) * \$10M/10M = (1 + 0.12T) * \$1.0 = \$1 + 0.12 T \quad (15.23)$$

The first term (e.g., \$0.74 for Series A) for each series represents the amount of RVPS that it gets if they had a liquidation event today (the day of Series C investment). Note that this is greater than RVPS at the time of original investments for Series A and B, because they have accumulated dividends for two years and one year, respectively. The conversion order when $T = 0$ is therefore $A \rightarrow C \rightarrow B$. The second term represents how RVPS grows for each series over time as a function of T . Note that A has the lowest slope and B has the highest slope. Thus, the original conversion order will always be preserved.

The conversion conditions are

Series A conversion condition:

$$\begin{aligned} 1/2 * [W - RV_B(T) - RV_C(T)] > RV_A(T) \rightarrow W_A = 2 * RV_A(T) \\ + RV_B(T) + RV_C(T) \end{aligned} \quad (15.24)$$

Series C conversion condition:

$$1/3 * [W - RV_B(T)] > RV_C(T) \rightarrow W_C = 3 * RV_C(T) + RV_B(T) \quad (15.25)$$

Series B conversion condition:

$$1/4 * W > RV_B(T) \rightarrow W_B = 4 * RV_B(T). \quad (15.26)$$

If we wanted to take next logical step in this solution, we could draw an exit diagram for the Series C. This diagram would be identical to Exhibit 15-5, except that the relevant conversion points would be a function of T and use Equations (15.25) and (15.26). These conversion points would then serve as strike prices for the underlying random-expiration options. As in the dividend examples of Chapter 14, the VCV model can handle these changing strike prices without any difficulty.

The valuation gets trickier if the dividends vary across the different series. For example, consider the same setup as Example 15.3, except that Series A has cumulative accrued cash dividends of 2 percent per month, to be paid only on a deemed liquidation event, Series B has no dividends, and Series C has cumulative accrued cash dividends of 1.00% per month. How could we find the conversion order now? The RV would a function of T for Series A and Series C, but not for Series B. Then, the RVPS for each Series would be

$$\begin{aligned} RVPS_A(T) &= (1 + 0.24T_A) * \$0.6 = (1 + 0.12 * (T + 2)) * \$0.6 \\ &= \$0.888 + 0.144T \end{aligned} \quad (15.27)$$

$$RVPS_B(T) = \$1.2 \quad (15.28)$$

$$RVPS_C(T) = (1 + 0.12T) * \$1.0 = \$1 + 0.12T \quad (15.29)$$



Now, because these RVPS for each series change with time at differing rates, the conversion order will *not* be constant over time. At $T = 0$, RVPS for Series A–C are \$0.888, \$1.20, and \$1.00, so we have the same conversion order as in the Example 15.3: A, C, B. But note that Series A has the highest slope (0.144) and Series B has the lowest (0). Thus, RVPS for A and C will eventually surpass that for B as time passes, and moreover RVPS for A will eventually overtake that for C. Specifically, when $T > 1.67$, the Series C RVPS would be above \$1.20, so B would convert before C. When $T > 2.17$, the Series A RVPS would be above \$1.20, so B would convert before A. Finally, when $T > 4.67$, the Series A RVPS would be above the Series C RVPS, so C would convert before A. From this point forward, the conversion order would be B, C, A—a complete reversal of the order when $T = 0$. With conversion order changing, we would need different exit diagrams and exit equations for different ranges of T . At this point, it is no longer very helpful to draw these diagrams, but the VCV model can still compute the valuations.

15.4.2 PIK Dividends

PIK (payment-in-kind) dividends are paid in stock. Each PIK dividend adds to the number of shares held by the investor, which will increase both the RV of the shares (using the same OPP as the investment) and the fraction of the company to be owned on conversion. These two changes combine to make the conversion conditions and exit diagrams a bit more complex than they are for accrued cash dividends.

EXAMPLE 15.4

We begin with the same setup as in Example 15.3. Owl invests \$10M in Series C for 10M shares of CP (APP = \$10M). The other investors are (1) the employees, who have claims on 10M shares of common; (2) the Series A investors, EBV, who have 10M shares of CP for \$6M APP; and (3) the Series B investors, Talltree, who have 10M shares of CP for \$12M APP. The Series C has a liquidation preference to Series B, which in turn has a liquidation preference to Series A. The difference between this case and Example 15.3 is in the dividends: here, all preferred investors—Series A, B, and C—have cumulative PIK dividends of 1 percent per month.

Problem Find the conversion order and conversion conditions for all investors.

Solution We first solve for the conversion order. As in Example 15.3, we can write the RVPS for each Series “X” as

$$RV_X(T) = RV_X(\text{at issue of Series } X) * (1 + 0.12T_X). \quad (15.30)$$

Unlike Example 15.3, in this case we must also take account of a change in the number of shares, which are also growing (through PIK dividends) at a rate of 0.12 per year. The good news is that the increase in the number of shares will exactly cancel out the increase in RV, so that the RVPS for each series will *not* be a function of T :

$$\text{Series A } RVPS(T) = (1 + 0.12T_A) * \$6M / [(1 + 0.12T_A) * 10M] = \$0.60 \quad (15.31)$$

$$\text{Series B } RVPS(T) = (1 + 0.12T_B) * \$12M / [(1 + 0.12T_B) * 10M] = \$1.20 \quad (15.32)$$

$$\text{Series C } RVPS(T) = (1 + 0.12T) * \$10M / [(1 + 0.12T) * 10M] = \$1.00. \quad (15.33)$$

Because these are the same RVPS found in Example 15.2, the conversion order will not be affected and will always be A, C, B. The conversion conditions will change, however, because ownership fractions (slopes) will change over time, as will the RVs. Denote the fraction of the firm to be held on conversion by Series X as $F_X(T)$. Then, we can write the conversion conditions as

Series A conversion condition:

$$\begin{aligned} F_A(T) * [W - RV_B(T) - RV_C(T)] &> RV_A(T) \rightarrow \\ W_A &= RV_A(T) / F_A(T) + RV_B(T) + RV_C(T), \end{aligned} \quad (15.34)$$

Series C conversion condition:

$$F_C(T) * [W - RV_B(T)] > RV_C(T) \rightarrow W_C = RV_C(T) / F_C(T) + RV_B(T), \quad (15.35)$$

Series B conversion condition:

$$F_B(T) * W > RV_B(T) \rightarrow W_B = RV_B(T) / F_B(T). \quad (15.36)$$

■

If we were to take this solution to the next logical step, we could draw an exit diagram for the Series C. This diagram would be identical to Exhibit 15-5, except now the conversion points and the slopes would be a function of T and use Equations (15.35), and (15.36). These conversion points then serve as strike prices for the underlying random-expiration options, with the fractions of these options determined by the time-varying slopes. Again, although this might look difficult to solve, the VCV model does not mind. As in the earlier example, things get messier if the investors have different PIK dividends, or if there is a mixture of PIK dividends with accrued cash dividends. Although these complex structures do not yield helpful exit diagrams, we can still use the VCV model to value them.

15.5 BEYOND SERIES C

From a theoretical perspective, there is nothing new in later round transactions. We can follow the same steps as used to compute LP valuation in Series A, B, and C. In this section, we review these steps in the context of a Series F round.

EXAMPLE 15.5

Begin with the same setup as in Example 15.2. Assume that Owl chose Structure 2 and invested \$10M in a Series C round for CP. Following Series C, there were three more rounds of investment, each for CP, and each made by a separate VC. The details of all rounds are given below. Liquidation preferences are in reverse order of investment, with F before E before D, and so on. Assume that Series D, E, and F investors all have committed capital of \$100M investment capital of \$80M and carried interest of 20 percent. None of the investors have any dividends.

- Series A: \$6M for 10M shares (EBV)
- Series B: \$12M for 10M shares (Talltree)
- Series C: \$10M for 10M shares (Owl)
- Series D: \$10M for 10M shares (2X liquidation preference) (Series D investors)
- Series E: \$10M for 10M shares (3X liquidation preference) (Series E investors)
- Series F: \$25M for 10M shares (Series F investors)

Problems

- (a) What is the conversion order for these investors?
- (b) What is formula for the partial valuation of the Series A?
- (c) Suppose that the total valuation is \$100M. Use the VCV model to compute the LP valuation for each series.

Solution

(a) For a company with six rounds of investment, we are very happy to have the conversion-order shortcut. To compute the RVPS for Series D and E, we must not forget the excess liquidation preferences, which imply redemption values of \$20M for Series D and \$30M for Series E. Otherwise, the calculations are similar to those in earlier examples. The RVPS for each Series is

$$\text{Series A : } \$6\text{M}/10\text{M} = \$0.60 \quad (15.37)$$

$$\text{Series B : } \$12\text{M}/10\text{M} = \$1.20 \quad (15.38)$$

$$\text{Series C : } \$10\text{M}/10\text{M} = \$1.00 \quad (15.39)$$

$$\text{Series D : } \$20\text{M}/10\text{M} = \$2.00 \quad (15.40)$$

$$\text{Series E : } \$30\text{M}/10\text{M} = \$3.00 \quad (15.41)$$

$$\text{Series F : } \$25\text{M}/10\text{M} = \$2.50 \quad (15.42)$$

This implies an order of conversion of A, C, B, D, F, E.

(b) Series A converts first, so as each series converts after it, EBV's share of the common stock changes. Because the founders own 10M shares and all series also convert to 10M shares, EBV's share will be one-half upon conversion and then will fall to one-third, one-fourth, one-fifth, one-sixth, and one-seventh with each successive conversion. This will lead to an exit diagram with many slope changes. To determine the points of these slope changes, we must compute the conversion conditions for each series. For each series Z, the conversion condition is computed as

(Fraction of firm owned by Series Z on conversion)

$$\begin{aligned} & * (\$W - \text{total redemption value for all series that convert after Series Z}) \\ & > \text{total redemption value for Series Z.} \end{aligned} \quad (15.43)$$

These conversion conditions are given following for each series, in the conversion order as determined by the RVPS:

$$\text{Series A conversion condition : } 1/2 * (W - 97) > 6 \rightarrow W_A = \$109 \text{ M} \quad (15.44)$$

Series C conversion condition : $1/3 * (W - 87) > 10 \rightarrow W_C = \117 M (15.45)

Series B conversion condition : $1/4 * (W - 75) > 12 \rightarrow W_B = \123 M (15.46)

Series D conversion condition : $1/5 * (W - 55) > 20 \rightarrow W_D = \155 M (15.47)

Series F conversion condition : $1/6 * (W - 30) > 25 \rightarrow W_F = \180 M (15.48)

Series E conversion condition : $1/7 * W > 30 \rightarrow W_E = \210 M (15.49)

Under these conditions, the exit diagram for Series A is as shown in Exhibit 15-7.

EXHIBIT 15-7

EXIT DIAGRAM FOR SERIES A, AFTER SERIES F

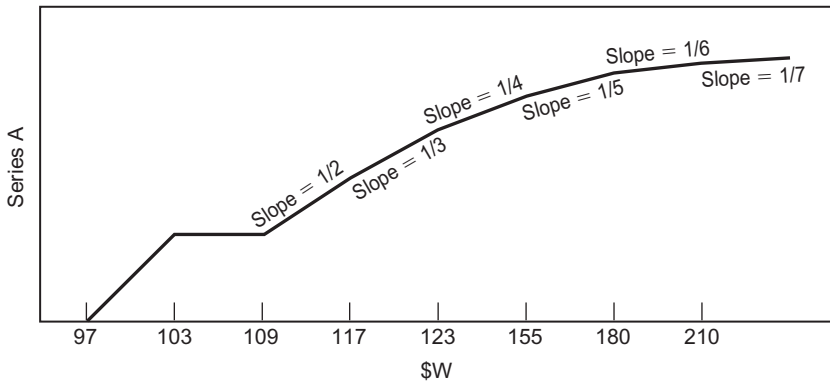

EXHIBIT 15-8

LP VALUATIONS FROM AUTO CALCULATOR

	A	B	C	D	E	F	Founders
Security Type	CP	CP	CP	CP	CP	CP	C
Investment (\$M)	\$6.00	\$12.00	\$10.00	\$10.00	\$10.00	\$25.00	
Shares (M)	10	10	10	10	10	10	10
Liquidation Pref (X)	1	1	1	2	3	1	
APP (\$M)	\$6.00	\$12.00	\$10.00	\$10.00	\$10.00	\$25.00	
LP Cost (\$M)	\$7.50	\$15.00	\$12.01	\$12.50	\$12.50	\$31.25	
Partial Valuation (\$M)	\$10.07	\$10.79	\$11.04	\$14.07	\$20.77	\$23.33	
GP Valuation (\$M)	\$1.01	\$1.08	\$1.43	\$1.41	\$2.08	\$2.33	
LP Valuation (\$M)	\$9.06	\$9.71	\$9.60	\$12.66	\$18.69	\$21.00	

We can read Exhibit 15-7 to obtain the partial valuation of the Series A as follows.

Partial valuation of the Series A

$$= C(97) - C(103) + 1/2 * C(109) - 1/6 * C(117) - 1/12 * C(123) - 1/20 * C(155) - 1/30 * C(180) - 1/42 * C(210). \quad (15.50)$$

(c) The LP valuations for all series are given in the (partial) output from the VCV model in Exhibit 15-8. ■

SUMMARY

Later-round investments provide the most important and interesting environment for our valuation techniques. To extend our analysis to these later rounds, it is necessary to first determine the conversion order for the various classes of preferred stock. In this chapter, we learned how to do this by using the redemption value per share (RVPS) for each class. Once the conversion order is established, we can compute the conversion conditions for each class and then use these conditions to draw and read exit diagrams. Dividends can introduce complications for the drawing of exit diagrams, but these complications are easily handled by the VCV model.

KEY TERMS

Redemption Value per Share (RVPS) *Conversion-order shortcut*

EXERCISES

15.1 Consider the following four CP investors:

- (1) Series A: \$5M APP (and 2X liquidation preference) or converts to 5M shares;
- (2) Series B: \$10M APP or converts to 8M shares;
- (3) Series C: \$10M APP or converts to 5M shares;
- (4) Series D: \$5M APP or converts to 10M shares.

In addition to these investors, the founders hold 10M shares of common.

- (a) Find the conversion order for these investors.
- (b) Find the conversion conditions for these investors.
- (c) Draw and read the exit diagrams following the Series D investment.
- (d) Assume that total valuation is \$50M. Compute the LP valuation for each series.

15.2 Using the same setup as Example 15.1, compute the LP valuation equation for the Series A investors (EBV) under Structures 1 and 2 for Series B. For the same range of total

valuations considered in Exhibit 15-3, which structure would EBV prefer that Talltree choose?

15.3 Using the same setup as Example 15.2,

- (a) Compute the LP valuation for the Series B investors (Talltree) under Structures 1 and 2 for Series C. For the same range of total valuations considered in Exhibit 15-6, which structure would Talltree prefer that Owl choose?
- (b) Compute the LP valuation for the Series A investors (EBV) under Structures 1 and 2 for Series C. For the same range of total valuations considered in Exhibit 15-6, which structure would EBV prefer that Owl choose?

15.4 Draw the exit diagrams for Series B-F for Example 15.5.

PARTICIPATING CONVERTIBLE PREFERRED STOCK

AS FIRST SEEN in Chapter 9, participating convertible preferred stock (PCP) is a hybrid between an RP plus common structure and a plain common-stock structure. In a PCP transaction, the investor is allowed to redeem his stock and also to “participate” in the proceeds paid to the common stock as though he had converted. If the proceeds of any exit reach some preset threshold, then the redemption component of the PCP goes away, and the investor is forced to convert all the shares to common. Thus, above this threshold, PCP is just like common stock. Typically, such thresholds will be stated as a “qualified IPO” or as a “qualified IPO or sale”, with a specific numerical share price. Sometimes, the threshold may be set explicitly as a 5X or 10X return, or as a compounded annualized return so that the threshold changes with the length of the holding period. Furthermore, there may be an upper limit on the liquidation return, giving rise to the participating convertible preferred with cap (PCPC) structure.

Although simpler CP structures are the norm in rising markets, PCP structures become more popular in falling markets. For example, during the VC downturn in the postboom period, PCP structures became very popular, as did many other investor-favorable terms such as liquidation preferences and antidilution rights.¹ In general, in falling markets entrepreneurs are often slow to accept the lower value in their companies, and VCs employ a variety of structures—including PCP—to maximize as-converted per-share prices while still receiving enough value to justify the investment.

The definition of PCP used here is historically accurate, but some VCs use “PCP” to mean the same thing as “RP + common”. For this usage, we can just think of the PCP threshold as being set to infinity, thus making it equivalent to RP + common. In this chapter, we use the more flexible definition of PCP that allows

¹See Kaplan and Stromberg (2003) and Asset Alternatives (2005).

for a finite threshold. To solve for the partial valuation of PCP structures, we include binary options in the valuation equations. These binary options are introduced in Section 16.1. Section 16.2 demonstrates an investment recommendation for a Series A PCP investment, Section 16.3 does the same for a PCPC structure, and Section 16.4 shows how to extend the analysis to later rounds.

16.1 BINARY OPTIONS

To value PCP, we first need to discuss the valuation of binary options. Binary options pay some fixed amount (K) if the stock price (S) is above the exercise price (X) on the expiration date (T). Thus, an exit diagram for a binary option looks like Exhibit 16-1.

The formula for the pricing of binary options looks similar to the second part of the Black-Scholes formula $= K * e^{-rT} * N(d_2)$, where $N(d_2)$ is defined the same way as in Equation (13.13).

In our applications, we will use random-expiration binary calls. Like the random expiration calls introduced in Chapter 13, we can price an RE binary call by integrating a regular binary call over time. The formula for an RE binary call, which we write as $K * BC(X)$, is

$$K * BC(X) = \int_0^{\infty} Ke^{-rT} N(d_2) * qe^{-qT} dT \quad (16.1)$$

where $q = 1/H$ is the continuous-time probability of expiration, and H is the expected holding period.

EXHIBIT 16-1

EXIT DIAGRAM FOR A BINARY OPTION

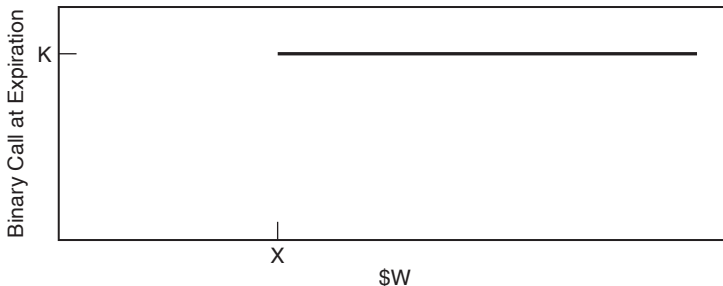

EXAMPLE 16.1

Suppose EBV makes a Series A investment in Newco and simultaneously offers the employees a bonus pool of \$5M on any exit where firm value exceeds \$200M. Currently, the firm value of Newco is \$40M, and base-case option-pricing assumptions apply.

Problem What is the current value of this bonus incentive?

Solution Under the assumption that the exit date remains independent of the firm value, then we can value this incentive as an RE binary call, with K set to \$5M. The *FLEX* Calculator can be used for this computation. We find a value of \$0.12M. ■

16.2 THE VALUATION OF PCP**EXAMPLE 16.2**

Suppose that EBV is considering a \$6M Series A investment in Newco. EBV proposes to structure the investment as 5M shares of PCP, with a threshold five times APP (= \$6 per common share upon conversion). The employees of Newco hold 10M shares of common stock. Thus, following the Series A investment, Newco will have 10M common shares outstanding and would have 15M shares outstanding on conversion of the PCP.

Problems

- (a) Solve for the LP cost for this investment.
- (b) Solve for the LP valuation equation for this investment.
- (c) Find the breakeven valuation for the investment under base-case assumptions.
- (d) Perform a sensitivity analysis for this breakeven valuation.

Solutions

(a) As we have now seen many times in previous chapters, the LP cost for EBV on a \$6M investment is $(100/80) * \$6M = \$7.5M$.

(b) The threshold requires a price of \$6 per share (as converted). This implies value of $15M * \$6 = \$90M$ for the whole firm. Below the threshold, PCP looks like RP plus common. EBV receives the first \$6M in proceeds for the RP. Following this redemption, EBV owns one-third of the common stock (5M out of 15M shares).

The only difference between PCP and RP + common is that there is a drop in value at the threshold. Below the threshold, the Series A would receive \$6M for redemption plus one-third of the remaining proceeds: $1/3 * (W - 6)$. At $W = 90$, this total value is

$$\text{Value of PCP at } W = 90(\text{before drop}) = 6 + 1/3 * (90 - 6) = \$34M. \quad (16.2)$$

Immediately above the threshold, the Series A would no longer receive any redemption value and would instead be forced to convert and to receive exactly one-third of the

proceeds. At $W = 90$, this share would be worth $1/3 * 90 = \$30M$. Thus, there is a $34M - 30M = \$4M$ drop at the threshold.

We are now prepared to draw the exit diagram for the Series A, as in Exhibit 16-2.

EXHIBIT 16-2

EXIT DIAGRAM FOR THE SERIES A PCP

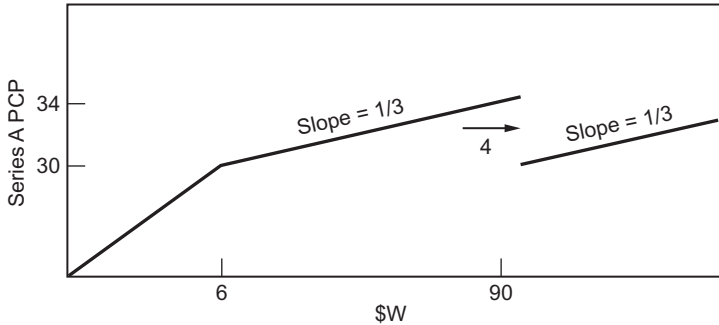

We can read this diagram as

$$\text{Partial valuation of Series A} = V - 2/3 * C(6) - 4 * BC(90). \quad (16.3)$$

With our now-standard estimate of $GP\% = 0.10$ for EBV, we have

$$\text{LP valuation of Series A} = 0.9 * (V - 2/3 * C(6) - 4 * BC(90)). \quad (16.4)$$

(c) We can use the VCV model to compute the breakeven valuation as \$18.60M.

(d) Exhibit 16-3 shows the sensitivity of the breakeven valuation to various assumptions for volatility and the expected holding period.

EXHIBIT 16-3

SENSITIVITY ANALYSIS FOR BREAKEVEN VALUATION

		Volatility		
		60%	90%	120%
Expected	3	15.73	17.14	18.49
Holding	5	16.96	18.60	19.98
Period (years)	7	17.90	19.57	20.89

These sensitivities are similar to those in the RP + common structure analyzed in Example 14.1. The only thing that keeps PCP from being identical to an RP + common structure is the inclusion of the threshold, priced as a binary option in Equation (16.3).

For a total valuation of \$20M and base-case option-pricing assumptions, the value of this binary option, $4 * BC(90)$, is about \$0.11M. Whereas standard options increase in value when volatility increases, binary options do the reverse. For higher levels of volatility, the value of the binary option decreases, and the PCP structure converges to an RP + common structure. Indeed, as volatility goes to infinity, all structures will look the same as plain common stock. Readers are encouraged to experiment with the *FLEX* Calculator to confirm these relationships. ■

16.3 THE VALUATION OF PCPC

PCPC structures include a cap for the liquidation return. In most cases, this cap is low enough so that conversion occurs by choice at or below the QPO. When conversion is by choice and occurs at levels below the QPO, the exit diagram will be smooth, and no binary options need be included in the exit equation. The following example illustrates this case.

EXAMPLE 16.3

Suppose EBV is considering a \$6M Series A investment in Newco. EBV proposes to structure the investment as 5M shares of PCPC, with a threshold at five times APP (= \$6 per common share on conversion). Furthermore, the liquidation value of the PCPC is capped at four times the APP (= \$24M). The employees of Newco hold 10M shares of common stock. Thus, following the Series A investment, Newco will have 10M common shares outstanding and would have 15M shares outstanding on conversion of the PCP. (Note that this is the same setup as Example 16.2, with the additional cap at four times APP.)

Problems

- Solve for the LP cost for this investment.
- Solve for the LP valuation equation for this investment.
- Find the breakeven valuation for the investment under base-case assumptions.

Solutions

- As in Example 16.2, the LP cost is \$7.5M.
- With PCPC, EBV faces a similar decision—redeem or convert—as it would with plain CP. When we first analyzed PCPC structures in Chapter 9, we demonstrated that the first step is to check whether conversion will be mandatory (at the QPO) or voluntary (using a conversion condition). In this case, mandatory conversion would occur at \$6 per share. With 15M shares outstanding, this QPO would occur when $W = 15M * \$6 = \$90M$.

The (voluntary) conversion condition for the PCPC is

$$1/3 * W > 24 \rightarrow W_A = 72. \quad (16.5)$$

Because Equation (16.5) yields a conversion point (\$72M) lower than the mandatory QPO conversion (\$90M), the latter is a redundant and nonbinding constraint: only the voluntary conversion will matter.

Our next step is to determine the cap point. Because EBV receives the first \$6M plus one-third of the remaining proceeds, the 4X (= \$24M) cap point is

$$6 + 1/3(W - 6) = 24 \rightarrow W_A(\text{cap}) = 60M. \quad (16.6)$$

Using this conversion condition and cap, we can draw the exit diagram as in Exhibit 16-4.

EXHIBIT 16-4

EXIT DIAGRAM FOR SERIES A PCPC

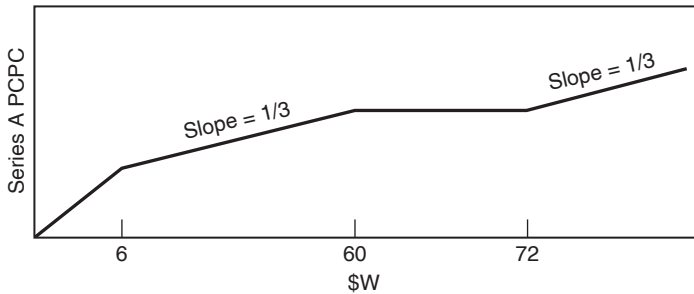

We can read Exhibit 16-4 as

$$\text{Partial valuation of Series A} = V - 2/3 * C(6) - 1/3 * C(60) + 1/3 * C(72). \quad (16.7)$$

Thus, the LP valuation equation for EBV is

$$\text{LP valuation of Series A} = 0.9 * [V - 2/3 * C(6) - 1/3 * C(60) + 1/3 * C(72)]. \quad (16.8)$$

(c) We can use the VCV model to compute the breakeven valuation as \$18.75M. This is only \$0.15M more than the cutoff without the cap found in Example 16.2. ■

For some applications, it is helpful to express the conversion condition in per-share terms. Once we do this, we can insert the PCPC into a conversion order. Although that is not necessary for a Series A investment, it can be useful in later rounds. In Example 16.3, we could do this by computing

$$\text{RVPS of Series A PCPC (at cap)} = \$24M/5M = \$4.80 \text{ per share}. \quad (16.9)$$

Similarly, we could express the per-share value of the common stock at the cap by subtracting the APP from the cap and dividing by the number of common shares:

$$\text{Per-share cap} = (\$24\text{M} - \$6\text{M})/5\text{M} = \$3.60 \text{ per share.} \quad (16.10)$$

In words, Equation (16.10) means “the Series A PCPC hits its liquidation cap when the value of common stock is \$3.60 per share”.

Notice that we were able to solve Example 16.3 without using binary options because voluntary conversion at ($W = 72\text{M}$) occurred before the QPO (at \$90M, as computed in Example 16.2). If, instead, mandatory conversion at the QPO occurred at a lower point than voluntary conversion, then binary options will be included. In those cases, we still must find the cap point because it is possible (but unusual) for the cap to occur at a point below the QPO. In Example 16.3, this could only occur if the cap was between 5 and 5.67 times APP. For example, with a cap of 5.5 times APP, the liquidation return would be capped at $5.5 * 6\text{M} = \$33\text{M}$. The RVPS for voluntary conversion would be at $\$33\text{M}/5\text{M} = \6.60 per share, which is higher than the QPO threshold. Then, the QPO threshold would be the binding constraint. Nevertheless, we would also have a cap point at

$$33 = 6 + 1/3 * (W - 6) \rightarrow W_A(\text{cap}) = 87. \quad (16.11)$$

Thus, at $W = 87$, the exit line would go flat until the QPO at $W = 90$, when it would drop in value from \$33M (the cap) to \$30M (after conversion).

16.4 SERIES B AND BEYOND

To value PCP in later rounds, we follow the same steps as shown in Chapter 15. If there are multiple rounds of PCP, then one must be careful to consider the implications of different QPO thresholds.

EXAMPLE 16.4

Suppose EBV made the transaction as described in Example 16.2. It is now one year later, and Talltree is considering a \$12M Series B investment in Newco. Talltree is considering two possible structures for the Series B. In Structure 1, Talltree would receive RP (\$10M APP) plus 5M shares of common stock. In Structure 2, Talltree would receive 5M shares of PCP with a threshold of \$12 per share. The founders of Newco, who will continue with the firm, currently hold 10M shares of common stock, and EBV holds 5M shares of PCP (as-if converted). Talltree has carried interest of 20 percent, committed capital of \$250M, and lifetime fees of \$50M.

Problems

- Compute the LP cost for the Series B.
- What is the LP valuation equation and breakeven valuation for Structure 1?
- What is the LP valuation equation and breakeven valuation for Structure 2?

(d) Plot the LP valuation for both structures for a range of total valuations. For what total valuation should Talltree be indifferent between the two structures?

Solutions

(a) Because Talltree has committed capital of \$250M and lifetime fees of \$50M, its investment capital is \$200M and we can compute LP cost as

$$LP\ cost = (250/200) * \$12M = \$15M. \tag{16.12}$$

(b) To compute LP valuation, we first draw an exit diagram for the Series B. With the RP + common structure, Talltree would receive the first \$10M of proceeds to redeem the RP, and EBV (Series A) would receive the next \$6M to redeem the PCP. Following these redemptions, there would be 20M shares of common stock, with 5M held by Talltree. Thus, Talltree would receive one-fourth of the proceeds beyond \$16M. The only complication occurs on a QPO, when EBV must return \$6M to the firm. This Series A threshold is set at \$6 per common share. With 20M common shares and a \$10M redemption for the Series B, total proceeds at this QPO must be at least $20M * \$6 + \$10M = \$130M$. Because the \$6M windfall will be shared by all common holders, it provides a jump of $\$6M * 1/4 = \$1.5M$ for the Series B.

We can draw the exit diagram for the Series B, Structure 1 as in Exhibit 16-5.

EXHIBIT 16-5

EXIT DIAGRAM FOR SERIES B, STRUCTURE 1

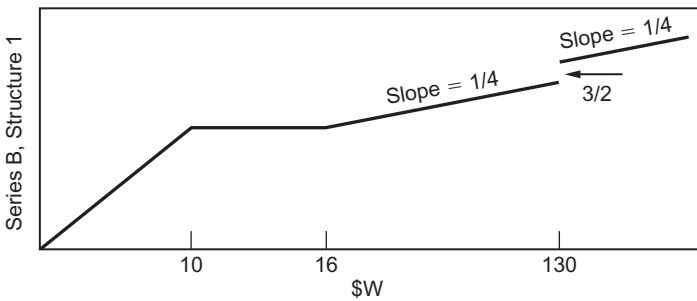

We can read Exhibit 16-5 as

$$\begin{aligned} \text{Partial valuation of Series B (Structure 1)} \\ = V - C(10) + 1/4 * C(16) + 3/2 * BC(130). \end{aligned} \tag{16.13}$$

The LP valuation equation is

$$\begin{aligned} LP\ \text{valuation of Series B (Structure 1)} = 0.9 * [V - C(10) + 1/4 * C(16) \\ + 3/2 * BC(130)]. \end{aligned} \tag{16.14}$$

We can use the VCV model to compute the breakeven valuation as \$49.63M.

(c) To compute LP valuation, we first draw an exit diagram for the PCP. For the Series B, a qualified IPO or sale requires a price of \$12 per share (as-if converted). This implies a value of $20M * \$12 = \$240M$ for the whole firm. We refer to \$240M as the “Series B threshold”. Below the Series B threshold, Structure 2 looks similar to Structure 1, except that that RV of the Series B is \$12M here, as compared to \$10M in Structure 1. This yields a \$2M difference in the strike price of all the options (as compared to Structure 1), including a change in the Series A threshold from \$130M in Structure 1 to \$132M in Structure 2. The other difference between Structures 1 and 2 is that there is a drop in value above the Series B threshold. Below the Series B threshold, the Series B PCP would receive \$12M for redemption plus one-fourth of the remaining proceeds: $1/4 * (W - 12)$. At $W = 240$, this total value is

$$\begin{aligned} \text{Value of Structure 2 at } W = 240 \text{ (before drop)} &= 12 + 1/4 * (240 - 12) \\ &= 69M. \end{aligned} \tag{16.15}$$

Immediately above the Series B threshold, the PCP would no longer receive any redemption value and would instead be forced to convert and to receive exactly one-fourth of the proceeds.

At $W = 240$, this share would be worth $1/4 * 240 = \$60M$. Thus, there is a $69M - 60M = \$9M$ drop at the threshold.

We are now prepared to draw the exit diagram for the Series B, Structure 2 (Exhibit 16-6).

EXHIBIT 16-6

EXIT DIAGRAM FOR SERIES B, STRUCTURE 2

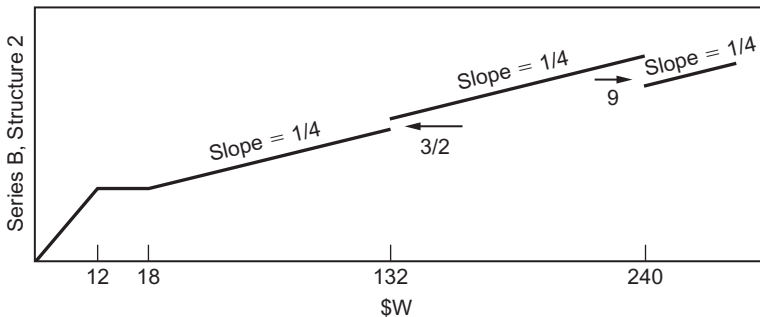

We can read Exhibit 16-6 as

$$\begin{aligned} \text{Partial Valuation of Series B (Structure 2)} \\ = V - C(12) + 1/4 * C(18) + 3/2 * BC(132) - 9 * BC(240). \end{aligned} \tag{16.16}$$

This implies an LP valuation equation of

$$\begin{aligned} \text{LP valuation of Series B (Structure 2)} \\ = 0.9 * [V - C(12) + 1/4 * C(18) + 3/2 * BC(132) - 9 * BC(240)]. \end{aligned} \tag{16.17}$$

EXHIBIT 16-7

LP VALUATION AND COST OF SERIES B, STRUCTURES 1 & 2

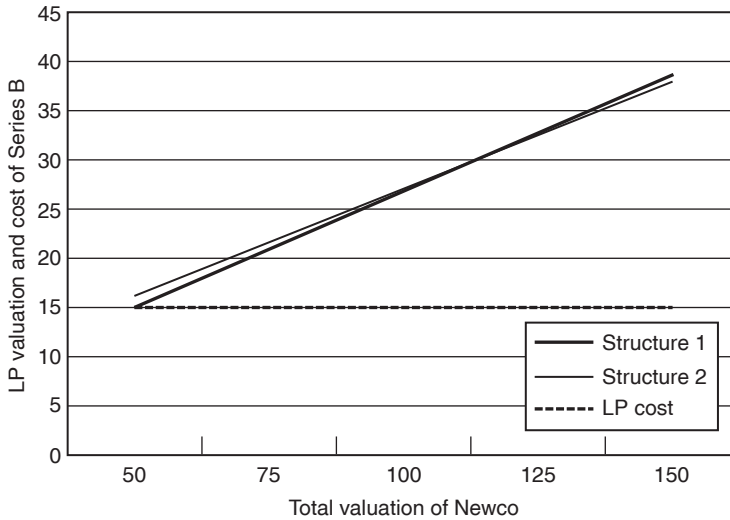

We can use the VCV model to compute the breakeven valuation as \$47.11M.

(d) Exhibit 16-7 shows the sensitivity of LP valuation to different total valuations. Notice that the values of the two structures are very similar.

We begin the sensitivity diagram for a total valuation close to the cutoff level for both structures. Above this level, although it is difficult to tell the two lines apart, the numbers indicate the Structure 2 has a slightly higher LP valuation than Structure 1 for virtually all the range. It is not until the very end—for total valuations close to \$148M, that Structure 1 has a slight advantage. This situation is ideal for the VC because he can confidently accept whichever of these structures is more preferred by the entrepreneur.

This example illustrates a general rule that can be used in analyzing all PCP structures. Any Series X PCP that hits its threshold will return the RV of that Series X ($= RV_X$) to be split among all the common stock holders. If the holder of a Series Y holds some fraction y of the common stock, then the Series Y will receive a one-time jump of $y * RV_X$ at the Series X threshold. For Series X itself, there will be a drop of RV_X , but this drop will be reduced by the increase of $x * RV_X$, where x is the fraction of the common stock held by Series X. Thus, the total drop for Series X at the Series X threshold will be equal to $(1 - x) * RV_X$.

We next consider a multiround example with both PCP and PCPC along with several rounds of CP. To solve this example, we must merge the conversion order

shortcut of Chapter 15 (using RVPS) with the complexities of participation thresholds and caps.

EXAMPLE 16.5

Talltree is considering a \$20M Series F investment in Newco for 10M shares of PCP with a QPO threshold of \$6 per share. The details of the prior rounds are

- Series A: 10M shares of CP (\$6M APP)
- Series B: 10M shares of CP (\$10M APP)
- Series C: 10M shares of CP (\$4M APP and a 3X liquidation preference)
- Series D: 10M shares of PCPC (\$10M APP), with liquidation return capped at 3X APP and a QPO at \$5 per share.
- Series E: 10M shares of CP (\$10M APP).

These venture investors all have 20 percent carried interest, \$250M in committed capital, and \$50M in lifetime fees. None of these investors are covered by any antidilution protections. In the event of a liquidation, the preferred stock is redeemed in reverse order of investment (i.e., the Series F has a preference to the Series E, which has a preference to the Series D, and so on). In addition to these investors, the employees have claims on 20M shares of common stock.

Problems

- (a) Draw and read the exit diagram for the Series D PCPC.
- (b) Compute the breakeven valuation for the Series F under base-case assumptions.

Solutions

- (a) First, we find the conversion order for the CP. In order of the RVPS of the CP, we have

- Series A: $\$6M/10M = \0.60
- Series B: $\$10M/10M = \1.00
- Series C: $\$12M/10M = \1.20
- Series E: $\$10M/10M = \1.00 .

We next add the PCP and PCPC to the ordering. For the Series F PCP, automatic conversion occurs at a QPO of \$6 per share. Because the highest RVPS is \$1.20 per share, this threshold is higher than all conversion points for the CP.

For the Series D PCPC, we first determine if conversion is voluntary or automatic. Voluntary conversion occurs at the RVPS, with the cap used as the redemption value. Automatic conversion occurs at the QPO of \$5. This yields a Series D conversion at the lesser of the voluntary conversion at $\$30M/10M = \3.00 or the automatic conversion at the QPO = \$5.00.

Thus, the QPO threshold is redundant, and conversion will occur voluntarily at \$3 per share, after all the CP has converted (the highest RVPS is \$1.20 per share), but before the Series F PCP at \$6 per share.

Finally, we compute the cap point. To make comparisons with the conversion order, it is helpful to compute this point on a per-share basis. When the PCPC is liquidated, the holders receive \$10M for the liquidation, plus value from the common stock of $10M \times$ per-share value. The cap is reached when

$$\text{Series D cap point} = W_D(\text{cap}) = \$10M + 10M * \text{per-share cap} = \$30M. \quad (16.18)$$

Solving for the per-share cap yields

$$(\$30M - \$10M)/10M = \text{per-share cap} = \$2.00. \quad (16.19)$$

Thus, the cap will be reached after all the CP has converted, because \$2.00 is higher than the RVPS for each CP series. Taken together, these calculations imply a conversion and cap order of A (\$0.60), B and E together (\$1.00), C (\$1.20), D (cap) (\$2.00), D (conversion) (\$3.00), and F (\$6.00).

When Series A converts, there will be 50M shares outstanding: 20M from the employees, 10M each from Series D and Series F (as-if conversion), and the 10M for Series A.

Thus, we can compute the Series A conversion conditions as

$$\text{Series A conversion condition} : 1/5 * (W - 62) > 6 \rightarrow W_A = \$92M. \quad (16.20)$$

Series B and E convert at the same time, followed by Series C:

$$\text{Series B conversion condition} : 1/7 * (W - 42) > 10 \rightarrow W_B = \$112M, \quad (16.21)$$

$$\text{Series E conversion condition} : 1/7 * (W - 42) > 10 \rightarrow W_E = \$112M, \quad (16.22)$$

$$\text{Series C conversion condition} : 1/8 * (W - 30) > 12 \rightarrow W_C = \$126M. \quad (16.23)$$

Next in order is the Series D cap, followed by the Series D voluntary conversion.

$$\text{Series D cap} : 10 + 1/8 * (W - 30) = 30 \rightarrow W_D(\text{cap}) = \$190M, \quad (16.24)$$

$$\text{Series D conversion condition} : 1/8 * (W - 20) > 30 \rightarrow W_D = \$260M. \quad (16.25)$$

EXHIBIT 16-8

EXIT DIAGRAM FOR THE SERIES D

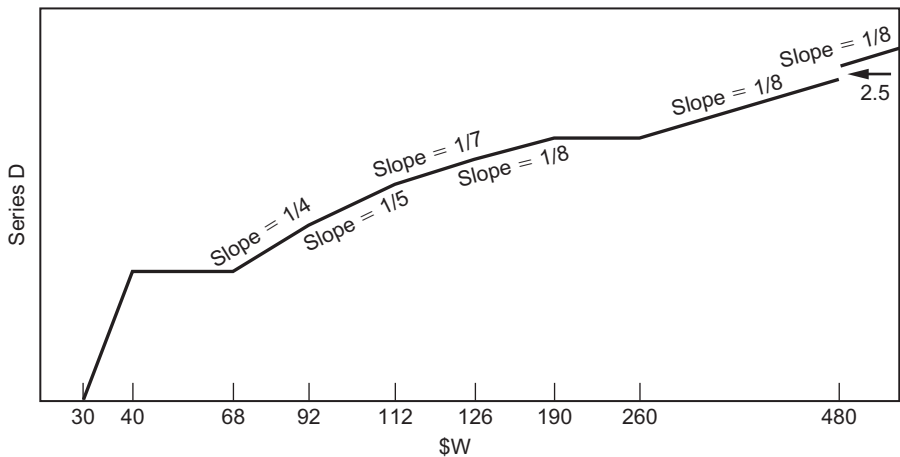

For the PCP, the QPO of \$6 per share occurs at

$$\text{Series F conversion condition (QPO): } 80M * \$6 = W_F = \$480M. \quad (16.26)$$

At this QPO, Series F will return \$20M to the other shareholders and recapture $1/8 * \$20M = \$2.5M$ for themselves, for a net drop of $\$20M - \$2.5M = \$17.5M$. With these calculations in hand, we are almost ready to draw the exit diagram for the Series D. Because Series D is paid after Series E and F, they receive no proceeds until $W = \$30M$, then they receive the next \$10M, and then nothing until the common stock begins to pay off after all liquidations are complete at $W = \$68M$. From that point, Series D has as-if claims on 10M shares for one-fourth of the proceeds (employees have 20M shares and Series F has 10M as-if shares). This fraction then falls off as other series convert. At $W = \$190M$, the Series D line goes flat, only increase again after voluntary conversion at $W = \$260$. Finally, at $W = \$480M$, the Series D investors receive \$2.5M from the returned redemption value of the Series F. We can read this diagram as

$$\begin{aligned} \text{Partial valuation of the Series D} \\ = C(30) - C(40) + 1/4 * C(68) - 1/20 * C(92) - 2/35 * C(112) \\ - 1/56 * C(126) - 1/8 * C(190) + 1/8 * C(260) + 2.5 * BC(480). \end{aligned} \quad (16.27)$$

(b) Note that over the range of $190 < W < 260$, the PCPC is capped so the exit line is flat. Over this flat range for the Series D, all the other common stock holders will receive proceeds as if the Series D shares did not exist, so their slopes will increase. This can be seen in the exit diagram for the Series F in Exhibit 16-9.

EXHIBIT 16-9

EXIT DIAGRAM FOR THE SERIES F

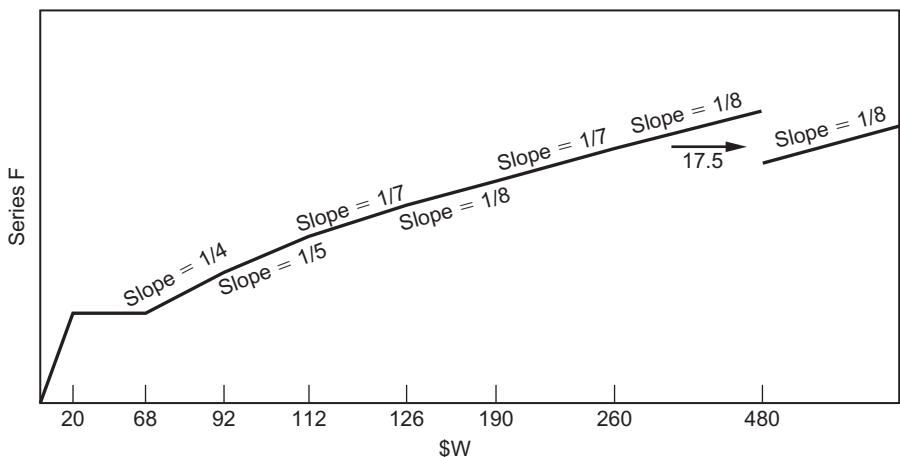

We can read this diagram as

Partial valuation of the Series F

$$= V - C(20) + 1/4 * C(68) - 1/20 * C(92) - 2/35 * C(112) - 1/56 * C(126) \quad (16.28) \\ + 1/56 * C(190) - 1/56 * C(260) - 17.5 * BC(480).$$

The LP valuation of the Series F is 90 percent of Equation (16.28). The LP cost is $(250/200) * \$20M = \$25M$. Finally, we can use the VCV model to compute the breakeven valuation under base-case assumptions as \$132.81M. ■

SUMMARY

Participating convertible preferred stock (PCP) is frequently used in VC transactions. PCP is similar to structures that combine RP and common stock, with the main difference that the RP component disappears for exits above some preset threshold. PCPC is a further refinement of PCP, where there is a cap on the liquidation return. PCP can be valued by including binary call options at the threshold points. For transactions where the threshold is far away from the current valuation, there is little difference between PCP structures and RP plus common structures. For transactions where the cap is close to the threshold, there is little difference between PCPC and PCP.

KEY TERMS

Binary call option

Random-Expiration

binary call option (BC(X))

REFERENCES

Asset Alternatives, 2005, *Deal Terms Report*, 2nd Edition, Dow Jones, Jersey City, NJ.

Kaplan, Steven N., and Per Stromberg, 2003, "Financial Contracting Theory Meets the Real World: Evidence from Venture Capital Contracts", *Review of Economic Studies*, April, 281–316.

EXERCISES

16.1 *True, False, or Uncertain:* Other things equal, the value of a binary call option decreases as volatility increases.

16.2 Suppose EBV is considering a \$5M Series A investment in Newco. EBV proposes to structure the investment as 5M shares of PCP with a threshold at \$3 per share. The employees of Newco have claims on 15M shares of common stock. Thus, following the Series A

investment, Newco will have 15M common shares outstanding, with another 5M shares on conversion of the Series A.

- (a) Compute the LP cost for this investment.
- (b) Solve for the LP valuation equation for this investment.
- (c) Find the breakeven valuation for the investment under base-case assumptions.
- (d) Perform a sensitivity analysis for this breakeven valuation.

16.3 Consider the same setup as in Example 16.4, except that now there is an additional possibility, Structure 3, where Talltree would receive 6M shares of CP with \$12M APP.

- (a) Perform a sensitivity analysis for the LP valuation of Structure 3 versus Structure 2 as a function of total valuation.
- (b) Suppose that total valuation is \$100M. For what number of shares, Z , in Structure 3, should Talltree be indifferent between Structures 2 and 3?

16.4 Consider the following four investors in Newco:

Series A: CP: \$5M APP (and 2X liquidation preference) or converts to 5M shares

Series B: RP: \$10M APP plus 5M shares of common

Series C: PCP: \$10M APP and as-if conversion to 5M shares, with a threshold at \$10 per share

Series D: PCP: \$20M APP and converts to 5M shares, with a threshold at \$15 per share

In addition to these investors, the employees have claims on 10M shares of common. All four VC investors have 20 percent carry, committed capital of \$250M, and lifetime fees of \$50M. Following the Series D investment, all investors agree that the total valuation of the firm is \$100M. Base-case option-pricing assumptions apply.

- (a) Find the LP valuation equation for each Series.
- (b) Compute the LP valuation for each Series.

IMPLIED VALUATION

IN CHAPTER 8, we showed how to calculate post-money valuation, which is typically interpreted as “the market value of the company implied by the purchase price in the current round”. For example, if a VC pays \$5M to purchase CP that would convert to one-third of the common stock, then the post-money valuation would be \$15M. From the post-money valuation, we can then compute the pre-money valuation as the difference between the post-money valuation and the new investment, which in this case would be \$10M.

These simple calculations, although useful for the quick communication of some critical terms, do not in fact provide an accurate **market valuation** for the company. The problem is that these calculations do not account for the special features of preferred stock, and instead treat all investments as though they were common stock. Furthermore, standard post-money valuation calculations ignore the extra costs of management fees and carried interest. In Chapters 13 through 16 we developed a framework for the valuation of preferred stock. As part of this framework, we computed the breakeven valuation necessary to equate LP valuation and LP cost. In this chapter, we reinterpret the breakeven valuation as the *implied post-valuation* (IV_{post}) of the company based on the actual transaction structure. This implied post-valuation can then be used to estimate the market valuation—which we call the *implied valuation*—for any investor’s stake.

Section 17.1 discusses the relationship between IV_{post} and post-money valuation and argues that the former is a more accurate measurement of market value. This additional accuracy is useful for three reasons. First, strong voices in the LP community are demanding more accurate interim valuation of companies from their GPs. Because many of these valuations are inferred from recent transactions, it is better to use implied post-valuation than post-money valuation. An application to interim valuation is given in Section 17.2. Second, implied valuations may also be necessary in contractual disputes, particularly those focused on the definition of a down round. Section 17.3 shows how the concept of implied valuation can be used to adjudicate such disputes. Third, recent changes in tax and accounting standards have forced companies to set values for their common shares for the reporting of executive compensation. The methods introduced in

this chapter can be used to provide a rigorous method for estimating the “implied” market value of this common stock, and can provide an input into the valuation of executive stock options.

At this point in the book, we have introduced many different terms with “valuation” as part of their name. In Section 17.4 we review these different terms and provide some tips on their correct usage.

17.1 POST-MONEY VALUATION REVISITED

The post-money valuation of private companies is often interpreted analogously to the enterprise value of public companies. For public companies, enterprise value is computed by adding the market values of all outstanding securities of the company: common stock, preferred stock, and long-term debt. For many public companies, it is possible to observe market values for all these securities, so the computation is easy. For other companies, analysts must use nonmarket information to estimate market values for nontraded components of the capital structure. In any case, no analyst would ever assume that all the securities are equivalent to common stock, and then just use common stock prices for everything. Nevertheless, this is exactly what we do for private companies when we calculate post-money valuation. If a VC pays \$5M for CP that would convert to one-third of the common stock, then we can only interpret post-money valuation as an enterprise value if we think that each share of CP has the same value as each share of common. As we know from the previous chapters, this is not correct.

To compute a more accurate version of enterprise value for VC-backed companies, we use information from the most recent transaction to estimate the market prices for each security in the capital structure. For example, consider the value components for Newco after a Series A investment by EBV. Exhibit 17-1 gives a general depiction of the division of value among the LPs of EBV, the GPs of EBV, and the employees of Newco. The partial valuation of the Series A is the GP valuation plus the LP valuation. We learned in Chapter 14 how to find the values of any of these components, assuming that we knew the value of the whole pie (total valuation). Here we want to answer a different question: Assuming that EBV paid a fair price for its stake, what is the implied market value for the whole pie? We write this implied market value as IV_{post} . Then, using IV_{post} as the total valuation, we can use three steps to solve for the implied valuation of any other shareholders: (1) draw their exit diagram, (2) read their exit diagram into an exit equation, and (3) solve their exit equation using IV_{post} as the total valuation input in the VCV model. In many applications, we can use shortcuts to make this procedure go much faster. Before describing these shortcuts, we do one example the hard way.

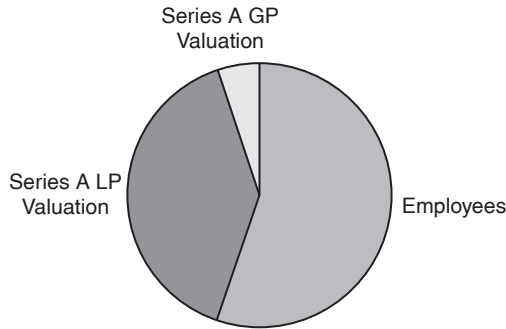
EXHIBIT 17-1**VALUE DIVISION AFTER SERIES A INVESTMENT****EXAMPLE 17.1**

Newco has 10 million shares of common stock outstanding. The founder-employees claim 8M of these shares, and angel investors own the other 2M, which they bought for \$1 per share a year ago. Newco management believes that the time is right for a major expansion. The expansion will require several million dollars over the following two years, but preliminary conversations with VCs have reached an impasse over valuation and dilution of the current owners. The founders are concerned about control and are thus reluctant to sell more than 6M shares because doing so would leave them with less than 50 percent of the business.

Furthermore, the founders also believe that the company has performed well over the last year and should not have to drop from the \$10M post-money valuation after the angel investment (\$1 per share and 10M shares outstanding). Other VCs have disagreed, believing that the angel investors overpaid, because although the company is profitable, the upside is limited. After many failed negotiations with other VCs, Newco finally seems close to a deal with EBV. EBV has offered \$6M for RP (\$5M APP) plus 6M shares of common stock. Base-case option-pricing assumptions apply.

Problems Assuming this transaction goes through,

- What are the pre- and post-money valuations for Newco?
- What is the implied valuation of Newco ($= IV_{post}$)?
- What is the implied valuation of the GP stake in Newco?
- What is the implied valuation of the angel shares? Has this value fallen since their purchase one year ago?
- What is the implied valuation of the employee shares?

Solutions

(a) EBV is investing \$6M for three-eighths of the common stock of Newco (6M/16M), so the post-money valuation is $\$6M / (3/8) = \$16M$. The pre-money valuation is $\$16 - \$6 = \$10M$.

(b) To find the implied valuation of Newco, we must first compute the formulas for the LP cost and valuation. Because EBV has \$100M of committed capital and \$80M of investment capital, the LP cost is $(100/80) * \$6M = \$7.5M$. The exit diagram for the Series A is given by Exhibit 17-2.

EXHIBIT 17-2
EXIT DIAGRAM FOR THE SERIES A

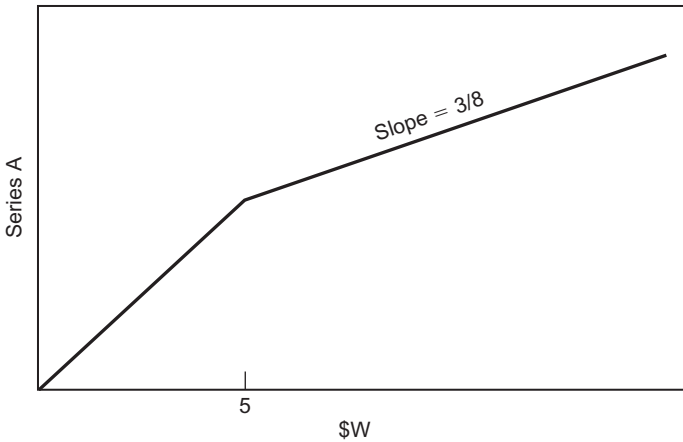

We can read this diagram as

$$\text{Partial valuation of the Series A} = V - 5/8 * C(5). \tag{17.1}$$

Thus, the LP valuation is

$$\text{LP valuation} = 0.9 * [V - 5/8 * C(5)]. \tag{17.2}$$

Because EBV has “paid” LP cost for this stake, the implied valuation of Newco will be the V in Equation (17.2) that equates LP valuation and LP cost:

$$\$7.5M = 0.9 * [IV_{\text{post}} - 5/8 * C(5)]. \tag{17.3}$$

This is exactly the same procedure we use to find the breakeven valuation. Thus, we can use the VCV model to compute $IV_{\text{post}} = \text{breakeven valuation} = \$17.46M$.

(c) The GP valuation is

$$\text{GP valuation} = \text{Partial valuation} - \text{LP valuation} = 0.1 * [V - 5/8 * C(5)]. \quad (17.4)$$

Using a total valuation = $IV_{post} = \$17.46\text{M}$, we can use VCV to compute the implied valuation of GP stake as $\$0.83\text{M}$. Note that we could also just use a shortcut to compute the GP valuation as $(0.1/0.9) * \text{LP valuation}$, where LP valuation = LP cost = $\$7.50\text{M}$.

(d) To find the implied valuation of the angel shares, we solve for the partial valuation of the angel shares and then use IV_{post} as the total valuation. Because the angels own 2M shares out of 16M total, the exit diagram for these shares is shown in Exhibit 17-3.

EXHIBIT 17-3

EXIT DIAGRAM FOR THE ANGEL SHARES

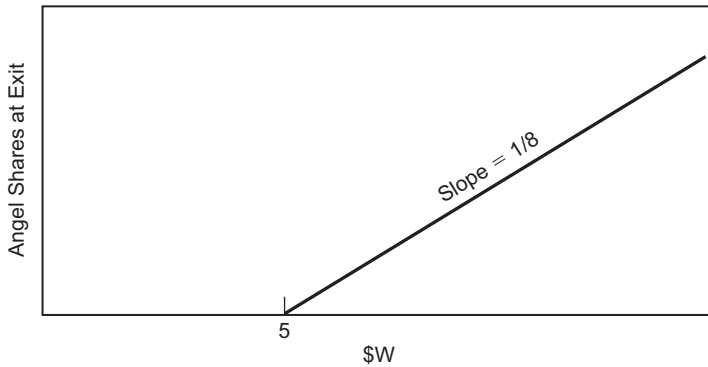

We can read this diagram as

$$\text{Partial valuation of the angel shares} = 1/8 * C(5). \quad (17.5)$$

Using a total valuation = $IV_{post} = \$17.46\text{M}$, we can use VCV to compute the implied valuation of the angel shares as $\$1.83\text{M}$. Because the angels purchased 2M shares for $\$2\text{M}$ one year ago, this implied valuation represents a decrease in the value of the shares.

(e) To find the implied valuation of the employee shares, we follow the same procedure as in part (d). Because the employees have claims on 8M out of 16M shares, their exit diagram is shown in Exhibit 17-4.

We can read this diagram as

$$\text{Partial valuation of the employees' shares} = 1/2 * C(5). \quad (17.6)$$

Using a total valuation = $IV_{post} = \$17.46\text{M}$, we can use VCV to compute the implied valuation of the employee shares as $\$7.30\text{M}$.

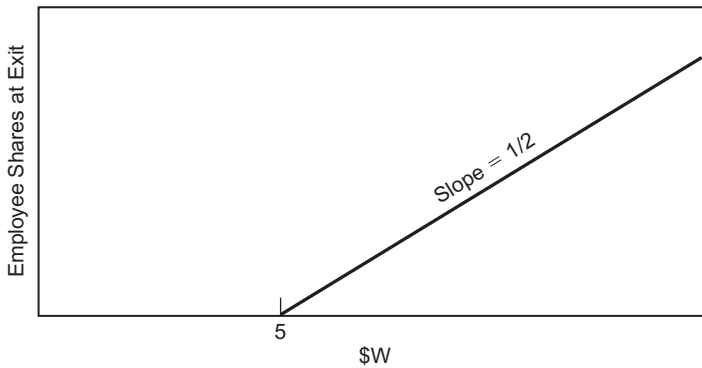
EXHIBIT 17-4**EXIT DIAGRAM FOR THE EMPLOYEES' SHARES**

After completing this example, it is easy to verify that the whole pie is the sum of the slices: $IV_{post} = \$7.50M + \$0.83M + \$1.83M + \$7.30M = \$17.46M$. Given that the whole must be the sum of the parts, we could have solved steps (c) through (e) without using the VCV model—that is, we could solve these parts using two additional equations: (1) GP valuation = $0.1/0.9 * LP$ valuation; and (2) IV of employee shares = $4 * IV$ of angel shares.

17.2 MEASUREMENT OF PORTFOLIO VALUE

In the United States, there is no binding rule for the interim valuation of VC investments. In practice, many GPs report all investments at cost for the quarterly reporting to LPs unless there has been a new round of (outside) investment. However, this practice has come under considerable criticism from the LP community in the past few years, with most of the criticism focused on the stale values reported between rounds of financing. The updates based on the actual financing events have garnered much less attention, as these events would appear to place a “market” value on the companies. These market values, however, are usually based on the post-money valuations, which, as we have seen, can be quite misleading as measures of market value.

Although post-money valuation remains an important concept for quickly communicating the basics of a transaction, it is simply not an appropriate market

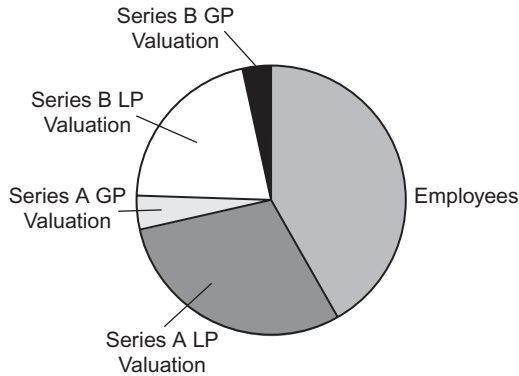
EXHIBIT 17-5**VALUE DIVISION AFTER SERIES B INVESTMENT**

valuation measure for an honest analyst. Instead, the best estimate is the implied valuation of the LP stake. Exhibit 17-5 displays the components of total value following a Series B investment.

If we set the Series B LP valuation = Series B LP cost, then we can use *VCV* to solve for the breakeven valuation = IV_{post} . Then we can follow the same procedure as in Example 17.1 to compute the implied valuations for any other slice of the pie. With all these new pieces floating around, it is helpful to introduce some new terminology: after a Series Y investment, the **implied LP valuation** for the Series X investment ($X \leq Y$) is the LP valuation for the Series X investment, where the total valuation used for the calculation is set equal to the implied valuation (IV_{post}) after Series Y. Similarly, the **implied GP valuation** for the Series X investment ($X \leq Y$) is the GP valuation for the Series X investment, where the total valuation used for the calculation is set equal to the implied valuation (IV_{post}) after Series Y. Finally, the **implied partial valuation** for the Series X investment ($X \leq Y$) is the partial valuation for the Series X investment, where the total valuation used for the calculation is set equal to the implied valuation (IV_{post}) after Series Y. We can also write the implied partial valuation for Series X as implied LP valuation + implied GP valuation.

With these definitions in hand, we can also define IV_{pre} , the **implied pre-valuation**, as representing the part of IV_{post} that is owned by the previous investors. For a Series Y investment, we can write IV_{pre} as

$$\begin{aligned} IV_{pre} &= IV_{post} - \text{Series Y implied partial valuation} \\ &= IV_{post} - \text{Series Y implied LP valuation} - \text{Series Y implied GP valuation} \end{aligned}$$

$$\begin{aligned}
 &= IV_{post} - \text{Series Y LP cost} - \text{Series Y implied GP valuation} \\
 &= IV_{post} - \text{Series Y LP cost} - (\text{GP}\% / (1 - \text{GP}\%)) * \text{Series Y LP cost} \\
 &= IV_{post} - \text{Series Y LP cost} / (1 - \text{GP}\%). \tag{17.7}
 \end{aligned}$$

We could also build IV_{pre} from the bottom up. Suppose there has just been a Series C investment. In this scenario,

$$\begin{aligned}
 IV_{pre} &= \text{Series A implied partial valuation} + \text{Series B implied partial valuation} \\
 &\quad + \text{Employee stock implied partial valuation}. \tag{17.8}
 \end{aligned}$$

Let's do another example.

EXAMPLE 17.2

Same setup as in Example 17.1, but now it is one year later, and Newco needs another infusion of capital. Talltree is considering a \$10M Series B investment for 8M shares of CP. The option-pricing assumptions remain the same as in Example 17.1, except that now we assume an expected holding period of four years. Talltree has 20 percent carried interest, \$250M of committed capital, and \$50M of lifetime fees.

Problems

- (a) After this round with Talltree, what are the pre- and post-money valuations for Newco?
- (b) What are IV_{post} and IV_{pre} ?
- (c) After this round by Talltree, what is the Series A implied LP valuation?

Solutions

(a) If Talltree pays \$10M to purchase 8M shares, they would be purchasing 1/3 of the 24M common shares outstanding (as-converted), making the post-money valuation $\$10M / (1/3) = \$30M$. Thus, the pre-money valuation is $\$30M - \$10M = \$20M$.

(b) To compute the implied valuations, we must first compute the formulas for the LP cost and valuation. LP cost is $(250 / (250 - 50)) * \$10M = \$12.5M$. Next, we need to find the conversion condition for Talltree. Because the Series B is the only CP in the capital structure, we do not need to worry about conversion order. Talltree would receive $1/3 * (W - 5)$ if it converts (the \$5M is needed to redeem the Series A RP), and \$10M if it redeems. Thus, Talltree's conversion condition for the Series B is

$$1/3 * (W - 5) > 10 \rightarrow W_B = \$35M. \tag{17.9}$$

The exit diagram for the Series B is given in Exhibit 17-6. We can read this diagram as

$$\text{Partial valuation of the Series B} = V - C(10) + 1/3 * C(35). \tag{17.10}$$

Thus, the LP valuation is

$$\text{LP valuation} = 0.9 * (V - C(10) + 1/3 * C(35)). \tag{17.11}$$

EXHIBIT 17-6

EXIT DIAGRAM FOR SERIES B

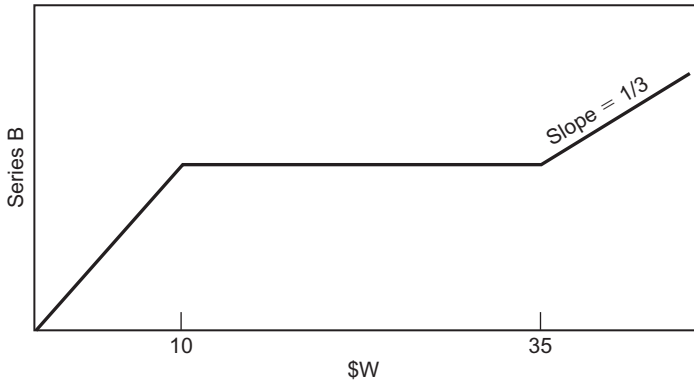

Now, the final step is to compute the implied post-valuation (= breakeven valuation). We set LP cost = LP valuation and solve for IV_{post} :

$$\$12.5\text{M} = (0.9) * (IV_{post} - C(10) + 1/3 * C(35)). \quad (17.12)$$

The VCV model yields a breakeven valuation = $IV_{post} = \$38.48\text{M}$. To solve for IV_{pre} , we use Equation (17.7):

$$\begin{aligned} IV_{pre} &= IV_{post} - \text{Series B LP Cost}/(1 - \text{GP}\%) \\ &= \$38.48\text{M} - \$12.5\text{M}/0.9 = \$24.59\text{M}. \end{aligned} \quad (17.13)$$

(c) The easy way to find the implied LP valuation for Series A is to substitute a total valuation of $\$38.48\text{M}$ into the *AUTO* Calculator, and then just look at the answer for the LP valuation of Series A. Here we will do this calculation the hard way, by finding the equation for this LP valuation and then solving this equation in the *FLEX* Calculator. We begin by drawing the exit diagram for the Series A (Exhibit 17-7).

We can read this diagram as

$$\text{Partial valuation of the Series A (after Series B)} = C(10) - 5/8 C(15) - 1/8 * C(35). \quad (17.14)$$

This makes the LP valuation

$$\text{LP valuation (Series A after Series B)} = 0.9 * (C(10) - 5/8 C(15) - 1/8 * C(35)). \quad (17.15)$$

Using a total valuation = IV_{post} , we can use the *FLEX* Calculator to calculate this implied LP valuation as $\$9.70$.

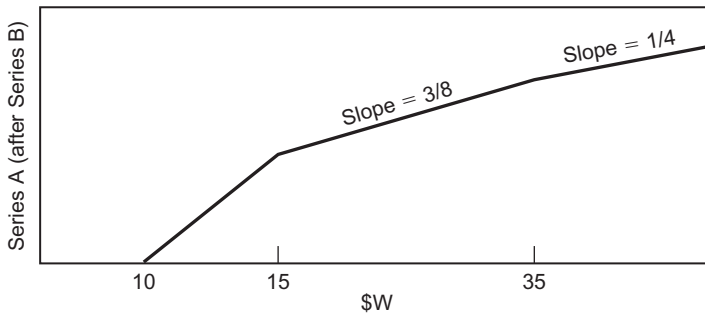
EXHIBIT 17-7*EXIT DIAGRAM FOR SERIES A (AFTER SERIES B)***17.3 DOWN ROUNDS?**

Another important application of implied valuation occurs in the identification of down rounds. Although it can sometimes be in the economic or emotional interest for some parties to pretend that a down round has not occurred, there are other times when the determination of a down round is crucial for negotiation or contractual reasons.

EXAMPLE 17.3

Consider the setup given in Example 17.2. It is now one year later, and Newco needs another infusion of capital. Owl is considering a \$12M Series C investment for RP, with APP of \$2M, with a 5X liquidation preference and 8M shares of common. The option-pricing assumptions remain the same as in Example 17.1, except that now the expected holding period is three years. Owl has carried interest of 25 percent, committed capital of \$500M, and lifetime fees of \$83.75M.

Talltree, the Series B investor, is covered by full-ratchet antidilution protection. The other investors (particularly the founders and EBV) are denying that this is a down round and claim that the antidilution protection does not apply. They have two arguments. First, they claim that the RP should be ignored in these calculations, and thus \$12M is being paid for 8M shares of common, a higher price than paid by Talltree for their CP. Second, they say that if Talltree insists on counting the RP, it should only count for \$2M (its APP), with the other \$10M allocated to the common. Even in this case, they claim that the price is the same as paid by Talltree. Talltree, in its defense, believes that these arguments greatly understate

the value of the RP component, and that the implied valuation of the Series B shares will be lower than its original LP cost. Owl wants the issue resolved before it invests.

Problems

- (a) After this round with Owl, what are the pre- and post-money valuations for Newco?
 (b) What are IV_{post} and IV_{pre} ?
 (c) Is Talltree correct in their assertion that the investment by Owl lowers the implied valuation of the Series B below its original LP cost?

Solutions

(a) If Owl pays \$12M to purchase 8M common shares (ignoring the RP component), it would be purchasing one-fourth of the of 32M common shares outstanding (as-converted). This makes the post-money valuation $\$12M / (1/4) = \$48M$, and the pre-money valuation is $\$48M - \$12M = \$36M$.

(b) To compute the implied valuations, we must first compute the formulas for the LP cost and valuation. LP cost is $500 / (500 - 83.75) * \$12M = \$14.4M$. Next, we need to find the conversion condition for the Series B, which is still the only CP in the capital structure. Talltree would receive $1/4 * (W - 15)$ if it converts (\$5M to redeem the Series A RP and \$10M to redeem the Series C RP), and \$10M if it redeems. Thus, Talltree's conversion condition for the Series B is

$$1/4 * (W - 15) > 10 \rightarrow W_B = \$55M. \quad (17.16)$$

With this information about Series B conversion, we are ready to draw the exit diagram for the Series C as shown in Exhibit 17-8.

EXHIBIT 17-8

EXIT DIAGRAM FOR THE SERIES C

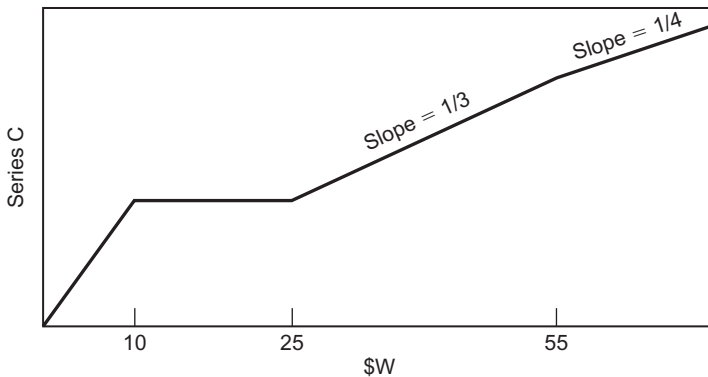

We can read this diagram as

$$\text{Partial valuation of the Series C} = V - C(10) + 1/3 * C(25) - 1/12 * C(55). \quad (17.17)$$

The terms of the Owl fund differ from those of EBV and Talltree. With an expected gross value multiple of 2.5, Owl has GP% of $0.25 * (2.5 * 416.25 - 500) / (2.5 * 416.25) = 0.13$.

Thus, the LP valuation is

$$\begin{aligned} \text{LP valuation of the Series C} &= 0.87 * (V - C(10) + 1/3 * C(25) \\ &\quad - 1/12 * C(55)). \end{aligned} \quad (17.18)$$

Now, the final step is to compute the implied post-valuation, we set LP cost = LP valuation and solve for IV_{post} .

$$\$14.4\text{M} = 0.87 * (IV_{post} - C(10) + 1/3 * C(25) - 1/12 * C(55)). \quad (17.19)$$

We can use the VCV model to solve for a breakeven valuation = $IV_{post} = \$49.19\text{M}$. Then, we have

$$IV_{pre} = 49.19 - 14.40 / 0.87 = \$32.64\text{M}. \quad (17.20)$$

(c) To determine if there has been a down round, we need to compute the implied LP valuation for Series B (after Series C) and compare it to the dollars invested by Talltree in Series B. Again, the easy way is to read the answer out of *AUTO* Calculator. To do this the hard way, we first find the formula for the LP valuation. Note that this formula will be slightly different from what we found in Example 17.2, because now there is a new investor (Series C) in the capital structure. The LP cost for the Series B is \$12.5M (same as in Example 17.2). The new exit diagram for the Series B is shown in Exhibit 17-9.

EXHIBIT 17-9

EXIT DIAGRAM FOR THE SERIES B (AFTER SERIES C)

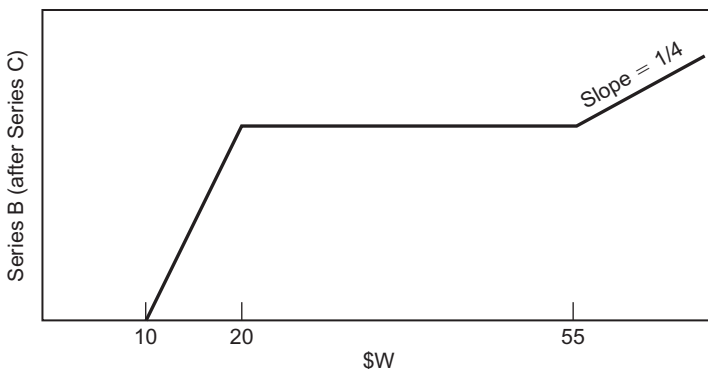

We can read this diagram as

$$\begin{aligned} \text{Partial valuation of the Series B (after Series C)} \\ = C(10) - C(20) + 1/4 * C(55). \end{aligned} \quad (17.21)$$

The LP valuation is

$$\text{LP valuation (Series B after Series C)} = 0.9 * (C(10) - C(20) + 1/4 * C(55)). \quad (17.22)$$

We can solve for the implied LP valuation in the *FLEX* Calculator by substituting in total valuation = $IV_{post} = 49.19$. This yields an answer of \$10.53M.

The final step is to compare this implied LP valuation (\$10.53M) to the “price” = LP cost originally paid for these Series B shares (\$12.50M). As the latter is higher than the former, we conclude that Talltree is correct in its claim that the Series C is a down round. ■

REALITY CHECK: Although this example gives Talltree some ammunition in a debate about down rounds, in most real-world transactions the contractual provisions are worded tightly enough so that the legal definition of “down round” may have nothing to do with the actual economic values computed by implied valuation. For example, if a down round is explicitly considered as a “lower conversion price”, then the economic value of all other features may be irrelevant from a legal perspective. Furthermore, even if all parties were willing to agree that a down round occurred in Example 17.3, it is not clear how antidilution adjustments would be computed, because such adjustments usually rely on preset formulas that can only take account of conversion prices. In practical situations, down-round computations such as Example 17.3 are more likely to show up in cases where contracts have not been carefully drafted.

17.4 HOW TO AVOID VALUATION CONFUSION

We have been throwing so many valuation terms around that some readers may be confused. This short section is intended to review some of the most important valuation definitions. In this section, we use **bold** type for valuation terms, and ***bold italic*** for valuation terms that are not standard industry usage.

When we “do a valuation” or “value a company”, this is usually referring to our own opinion about what something is worth. We arrive at this valuation using DCF, comparables, VC method, or some other valuation technique. You can think of this as your ***personal valuation*** of the company. The ***total valuation*** computed in the VC method is an example of a personal valuation.

Personal valuation has nothing to do with the actual **market valuation** implied by a transaction. In fact, the whole challenge of being a successful investor is to find companies where your personal valuation is higher than the market valuation (and to be right about it!). Instead, the structure of the actual transaction implies a specific

market valuation. The industry-standard approach to the computation of market valuation is to pretend that the whole purchase price was for common stock, and then divide this purchase price by the fraction of the company that has been purchased. This definition of the market valuation is called **post-money valuation**. Post-money valuation is sometimes a fair approximation for market valuation (such as when convertible stock is purchased in a high-volatility venture) and sometimes a bad approximation (such as when common stock is combined with redeemable preferred stock in a low-volatility venture). In many cases, it is often helpful for a careful investor or owner to compute a more accurate measure of the market valuation, which we call the *implied post-valuation* and write as IV_{post} . We compute the implied post-valuation by first finding the *LP valuation* and then recursively solving for the total valuation that equates LP valuation and LP cost.

Important points to remember:

1. Do not use your personal valuation when you mean market valuation. If somebody asks about the post-money valuation of a company, don't ever look at your models for the answer. Absolute and relative valuation models cannot answer this question.
2. Do not use market valuation when you should be using your personal valuation. If you doing a *partial valuation* of your stake in a company, the correct "stock price" to put into option-pricing models is your personal valuation of the whole company (= total valuation), not the market valuation.
3. It's fine to use post-money valuation if you want to communicate with people, but don't forget that, as a proxy for the market valuation of the company, it is often misleading or just plain wrong. When it is important to know what price is really being implied by the transaction, you should compute the implied valuation.

SUMMARY

Pre-money valuation and post-money valuation are used by VCs for many purposes, including communication, interim valuation for reporting, and as starting points in contractual disputes. In this chapter, we demonstrated that pre- and post-money valuation are not accurate measures of value—and in their place we developed alternative measures called implied pre-valuation and implied post-valuation that are more accurate reflections of market value.

KEY TERMS

<i>Implied valuation</i>	<i>Implied LP valuation,</i>
Market valuation	<i>implied GP valuation,</i>
<i>Implied post-valuation</i>	<i>implied partial valuation</i>
(IV_{post}) , <i>implied</i>	<i>Personal valuation</i>
<i>pre-valuation</i> (IV_{pre})	

EXERCISES

17.1 *True, False, or Uncertain:* If an investor believes that the total valuation of a company is higher than the implied post-valuation for the transaction, then he should invest.

17.2 Suppose that EBV is considering a \$10M Series A investment in Newco. EBV proposes to structure the investment as 6M shares of convertible preferred stock (CP) plus RP with \$4M APP. The employees of Newco have claims on 10M shares of common stock. Following the Series A investment, Newco will have 10M common shares outstanding and would have 16M shares outstanding on conversion of the CP.

- (a) After this round, what are the pre- and post-money valuations for Newco?
- (b) Find IV_{post} and IV_{pre} .

17.3 Talltree is considering a \$12M Series B investment in Newco for 5M shares of CP with \$12M APP. The other investors are (1) the employees, who have claims on 10M shares of common; and (2) EBV, the Series A investors, who have 5M shares of CP with \$6M APP. In both of these structures, the Series B has a liquidation preference to Series A. All the parties agree on an estimate of \$30M for the total valuation of Newco.

- (a) After this round with Talltree, what are the pre- and post-money valuations for Newco?
- (b) What are IV_{post} and IV_{pre} ?
- (c) After this round by Talltree, what is the implied LP valuation for the Series A investment made by EBV?

17.4 Consider the situation given in Example 17.3. After the Series C investment by Owl, is the Series A implied LP valuation lower than its original LP cost?

COMPLEX STRUCTURES

IN PART III, we have developed a framework for the partial valuation of many different types of VC structures. Because most VC transactions use standard security types such as RP, CP, PCP, and PCPC, we are able to automate many of these techniques in the *AUTO* calculator of the *VCV* model. Some transactions, however, use complex structures that are not easily reduced to a one-size-fits-all methodology. In this chapter, we give a few examples of such transactions and show how to break them down into the same pieces used in the previous chapters. With practice, analysts can learn to analyze many nonstandard securities using these techniques. As a general rule, if all securities are paid off only at exit, then you can write an exit diagram. If you can write an exit diagram, then you can read the diagram and value the underlying securities. Of course, not all transactions can be handled within this framework. In particular, if there are intermediate cash payments (before exit), then the exit diagrams won't tell the whole story, and the analytic formulas for RE options do not apply. To value these kinds of transactions, we need to use techniques developed in Part IV.

18.1 MANAGEMENT CARVE-OUTS

Many times, a complex structure will arise as part of a down round. In these cases, early expectations for the business have turned out to be too ambitious, but at least one new investor is convinced that value can still be captured in a new transaction. In these cases, the new investor often decides that there are insufficient incentives for the management and employees to stay around, and a new employee stock pool may not solve the problem, because of large preferences that stand before the common stock. Then, to provide incentives for management to stay around and work hard, a **management carve-out** is often made at the time of the new investment. The simplest type of carve-out is to set aside some fraction of exit

proceeds to be given to management.¹ This fraction is often paid from the first dollar of exit proceeds to incent management for even the smallest exits. We illustrate this type of carve-out in Example 18.1. More complex incentive schemes can be provided by lump-sum payments when certain exit thresholds or performance targets are met. We illustrate this kind of carve-out in Example 18.2.

EXAMPLE 18.1

Newco has received four rounds of investments (Series A, B, C, and D) for a total of 40M shares of CP plus 10M shares of common claimed by the employees. After the Series D investment, Newco falls on hard times. After searching hard for new financing, the investors finally agree to \$12M Series E investment with Vulture Ventures (VV) for 50M shares of CP and a 3X liquidation preference. As part of this agreement, all previous investors (Series A through Series D) give up all their preferred rights and are converted to common stock, so the capital structure of Newco is now 50M shares of common plus the Series E CP. As part of the investment, Vulture creates a carve-out: management will receive 10 percent of all exit proceeds, with a value of this carve-out capped at \$5M. Vulture Ventures has \$250M of committed capital, \$50M of lifetime fees, and 20 percent carried interest.

Problems

- (a) Draw and read the exit diagrams for the management carve-out, for the Series E, and for all other investors combined.
- (b) Compute the breakeven valuation for the Series E investment under base-case assumptions.
- (c) Compute the implied valuation for the management carve-out under base-case assumptions.

Solutions

We begin by drawing the exit diagram for the carve-out in Exhibit 18-1. Management receives 10 percent of all proceeds up to a total of \$5M. This cap is reached when proceeds are equal to \$50M.

We can read this diagram as

$$\text{Partial valuation of management carve-out} = 1/10 * V - 1/10 * C(50). \quad (18.1)$$

With this equation in hand, we are ready to tackle the Series E stake. The trick here is to adjust for the change in the redemption value caused by the carve-out. Without the carve-out, Vulture Ventures would be entitled to the first \$36M in proceeds (= \$12M APP * 3X liquidation preference.) Although the total RV of Series E is still \$36M after the carve-out, it will now take a little bit longer to get there, because Series E will only receive 90 percent of the proceeds. Thus, Vulture will receive 90 percent of all proceeds until $36M = 0.9 * W$, which occurs at $W = \$40M$.

¹Management carve-outs in VC transactions should not be confused with the more common meaning of “carve-out” in mature companies, where a division of a company is separated from the parent and given an independent existence.

EXHIBIT 18-1

EXIT DIAGRAM FOR MANAGEMENT CARVE-OUT

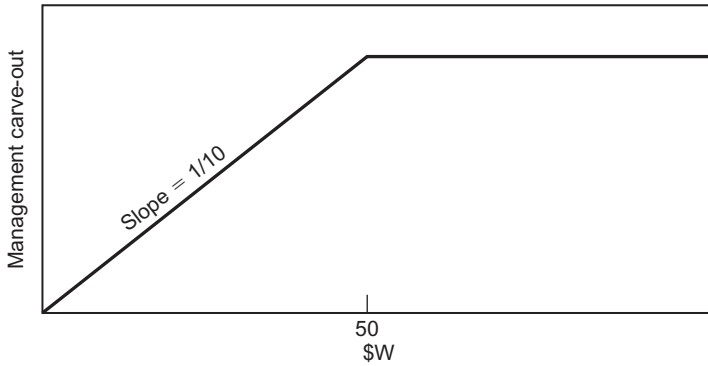

After receiving the RV, Vulture would choose to convert the CP when its conversion value exceeds the redemption value of \$36M. How is this conversion condition affected by the carve-out? As long as the conversion point occurs above \$40M, the only difference would be the reduction of the maximal \$5M carve-out from the exit proceeds:

Series E conversion condition

$$\frac{1}{2} * (W - 5) > 36M \rightarrow W_E = \$77M. \quad (18.2)$$

We are now ready to draw the exit diagram for the Series E as shown in Exhibit 18-2.

EXHIBIT 18-2

EXIT DIAGRAM FOR THE SERIES E

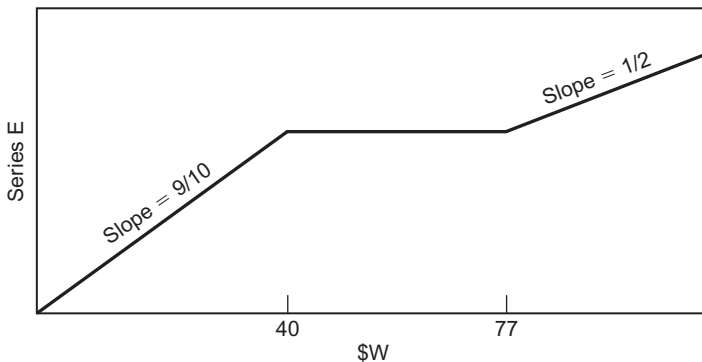

We can read this diagram as

$$\text{Partial valuation of the Series E} = 9/10 * V - 9/10 * C(40) + 1/2 * C(77). \quad (18.3)$$

We next analyze the remaining investors—Series A through Series D plus the employee claims—who collectively own 50 million shares of common stock. This holding includes complex changes, which are easiest to analyze by reversing our usual order and doing the exit equation first. Because the 50 million shares held by these remaining investors include everything not already claimed by Vulture or the carve-out, we can write the exit equation as the difference between the whole firm (V) and the partial valuations given in Equations (18.1) and (18.3):

Partial valuation of the 50 million remaining shares

$$\begin{aligned} &= V - [1/10 * V - 1/10 * C(50)] - [9/10 * V - 9/10 * C(40) + 1/2 * C(77)] \quad (18.4) \\ &= 9/10 * C(40) + 1/10 * C(50) + 1/2 * C(77). \end{aligned}$$

We draw this exit diagram in Exhibit 18-3.

EXHIBIT 18-3

EXIT DIAGRAM FOR THE REMAINING SHARES

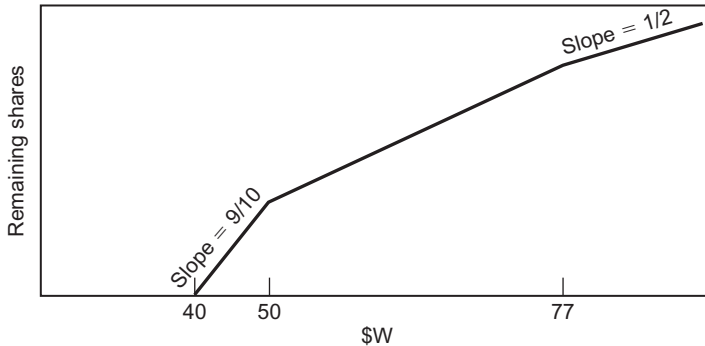

(a) To compute the breakeven valuation for the Series E, we use the typical GP% of 0.10 (since VV has carried interest of 20 percent like EBV and Talltree) and subtract the GP valuation from Equation (18.3) to obtain

$$\text{LP valuation of Series E} = 0.9 * [9/10 * V - 9/10 * C(40) + 1/2 * C(77)]. \quad (18.5)$$

Next, we find the LP cost as $(\$250\text{M}/\$200\text{M}) * \$12\text{M} = \15M . The breakeven valuation ($= IV_{post}$) is found by setting LP valuation = LP cost. Because this transaction includes a nonstandard structure (the carve-out), it is necessary to use the *FLEX* Calculator of the VCV model for this computation. Under base-case assumptions for a Series E investment, we find a breakeven valuation $= IV_{post} = \$24.26\text{M}$.

(b) Using the IV_{post} of \$24.26M and the same base-case assumptions as in part (b), we can use *FLEX* Calculator to compute the partial valuation of the carve-out (Equation (18.1)) as \$1.52M. ■

The previous example used a proportional carve-out. It is also possible to have discrete payouts at preset trigger points. The next example illustrates this case.

EXAMPLE 18.2

We use the same setup as in Example 18.1, but this time with a different structure for the management carve-out. Now, following the \$12M Series E investment from Vulture Ventures (50M shares of CP with a 3X liquidation preference), management is promised the following incentives: If Newco has an exit of at least \$50M, then the employees will receive \$5M from these proceeds. If Newco has an exit of at least \$80M, then the employees will receive an additional \$5M from these proceeds. The earlier investors have 40M shares of common, and the employees have claims on a further 10M shares.

Problems

- Draw and read the exit diagrams for the management carve-out, for the Series E, and for all other investors combined.
- Compute the breakeven valuation for the Series E investment under base-case assumptions.
- Compute the implied valuation for the management carve-out under base-case assumptions.

Solutions

We begin by drawing the exit diagram for the carve-out in Exhibit 18-4. Here, we have discrete jumps in the payouts to management at \$50M and \$80M.

We can read this diagram as

$$\text{Partial valuation of management carve-out} = 5 * BC(50) + 5 * BC(80). \quad (18.6)$$

We next turn to the Series E stake. Now the main complication is to adjust properly for the discrete payouts. Without doing some calculations, we cannot tell whether the jumps occur below or above the conversion point. In principle, it is possible that neither payout occurs before conversion (if $W_E < 50$), that only the first one does ($50 < W_E < 80$), or that both do ($W_E > 80$). The only way to know for sure is to compute all the cases and look for logical contradictions. For example, Series E conversion condition, if occurs below the first payout ($W_E < 50$):

$$1/2 * W > 36M \rightarrow W_E = \$72M. \quad (18.7)$$

This condition gives us a contradiction, because if W_E is equal to \$72M, we should have to include a payout (because $W_E > 50$). Thus, Equation (18.7) is not a proper conversion condition.

We next consider the possibility that $\$50M < W_E < \$80M$.

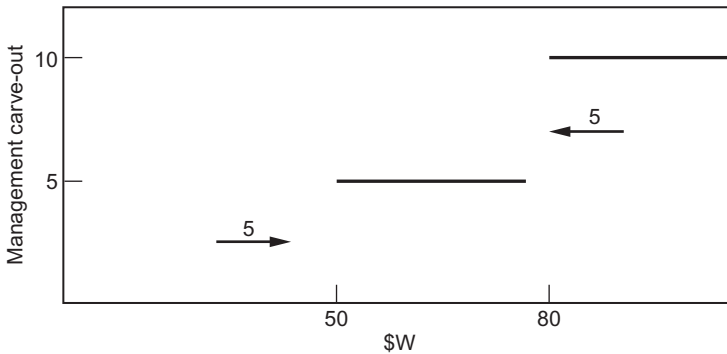
EXHIBIT 18-4**EXIT DIAGRAM FOR MANAGEMENT CARVE-OUT**

Series E conversion condition, if occurs above the first payout ($50M < W_E < 80M$)

$$1/2 * (W - 5) > 36M \rightarrow W_E = \$77M. \quad (18.8)$$

In this case, there is no logical inconsistency, because the condition for being between the two payouts ($50M < W_E < 80M$) is consistent with $W_E = \$77M$. Thus, Equation (18.8) is a proper conversion condition.

Even though we have found a conversion condition, we still check the last possibility, $W_E > 80$. As we shall see, an interesting surprise awaits us. Series E conversion condition, if occurs above the second payout ($W_E > \$80M$):

$$1/2 * (W - 10) > 36M \rightarrow W_E = \$82M. \quad (18.9)$$

Again, there is no logical inconsistency here: $W_E = \$82M$ is higher than the condition for the second payout, $W_E > 80M$. It seems as though we have two different conversion conditions.

How is this possible? It happens because for all exits between \$77M and \$80M, Equation (18.8) applies, and it is optimal for Vulture to convert the Series E. However, for an exit between \$80M and \$82M, after the second payout is made, Equation (18.9) applies, and it is no longer optimal to convert. For exits in this range, Vulture would choose to redeem. They would again convert for any exit above \$82M. Their exit diagram is shown in Exhibit 18-5. In complex cases like this, we must take special care to label all the key points to facilitate our reading of the diagram. For example, at $W = \$80M$, the Series E will suffer a drop of $3/2$ (because instead of $1/2 * (W - 5) = 37.5$ they drop back to 36) and a slope change of one-half (because they no longer are converting and getting half of all additional exit proceeds.)

EXHIBIT 18-5

EXIT DIAGRAM FOR THE SERIES E

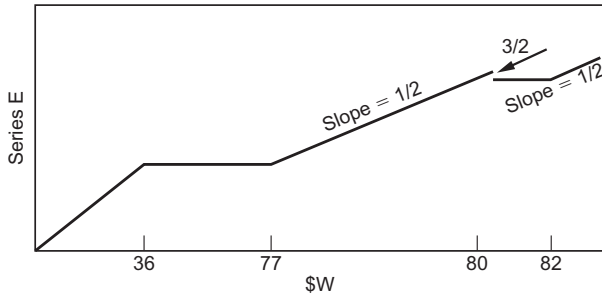

We can read this diagram as

$$\begin{aligned} \text{Partial valuation of the Series E} = & V - C(36) + 1/2 * C(77) - 1/2 \\ & * C(80) - 3/2 * BC(80) + 1/2 * C(82). \end{aligned} \tag{18.10}$$

We next analyze the remaining investors—Series A through Series D plus the employee claims—who collectively own 50 million shares of common stock. As in Example 18.1, we write this exit equation as the difference between the whole firm (V) and the partial valuations of the other investors. These partial valuations are given in Equations (18.6) and (18.10):

$$\begin{aligned} \text{Partial valuation of the 50 million remaining shares} = & V - [5 * BC(50) + 5 * BC(80)] \\ & - [V - C(36) + 1/2 * C(77) - 1/2 * C(80) - 3/2 * BC(80) + 1/2 * C(82)] \\ = & C(36) - 5 * BC(50) - 1/2 * C(77) + 1/2 * C(80) - 7/2 * BC(80) - 1/2 * C(82) \end{aligned} \tag{18.11}$$

We can draw this exit diagram as shown in Exhibit 18-6.

EXHIBIT 18-6

EXIT DIAGRAM FOR THE REMAINING SHARES

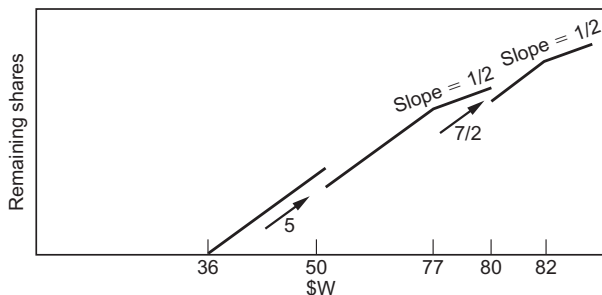

(b) To compute the breakeven valuation ($= IV_{post}$) for the Series E, we first subtract the GP valuation from Equation (18.10) to obtain

$$\begin{aligned} \text{LP valuation of Series E} = & 0.9 * [V - C(36) + 1/2 * C(77) - 1/2 * C(80) \\ & - 3/2 * BC(80) + 1/2 * C(82)]. \end{aligned} \quad (18.12)$$

As in Example 18.1, it is necessary to use the *FLEX* Calculator to compute the IV_{post} . Under base-case assumptions for a Series E investment, we find an IV_{post} of \$22.82M.

(c) Using the IV_{post} of \$22.82M and the same base-case assumptions as in part (b), we can use *FLEX* to compute the partial valuation of the carve-out (Equation (18.6)) as \$0.59M. ■

18.2 DEALING WITH PARTNERS

Because VC-backed companies are cash poor, they often must give up equity as payment in transactions with service providers or other partners. The following example shows how we could value these transactions.

EXAMPLE 18.3

EBV makes a \$10M Series A investment in Newco for 10M shares of CP. The employees of Newco have claims on 10M shares of common stock. At the same time as this investment, Newco enters into a transaction with Techco to obtain licenses for some Techco patents. As consideration for providing these licenses, Techco receives an option to purchase 10M shares of common stock for \$1.50 a share, but this option can only be exercised upon an exit above \$150M. (Assume that this \$150M would be adjusted for any future dilution, so that the threshold is effective for the proceeds owed to the current shareholders.) EBV is aware of the deal with Techco at the time that they make their Series A investment.

Problems

- (a) Draw and read the exit diagrams for Techco and for the Series A.
- (b) Compute the breakeven valuation for the Series A investment under base-case assumptions.
- (c) Compute the implied valuation for Techco's stake under base-case assumptions.

Solutions

(a) We begin with Techco. Their options are valuable only for an exit above \$150M. What happens at this point? Techco exercises their options at a cost of \$15M, and receives 10M shares, which are worth $10M/30M =$ one-third of the firm $=$ \$50M. In addition, the \$15M total strike price will be shared equally among the common stock holders, so Techco will effectively get back one-third of their strike price $=$ \$5M. In the exit diagram, these two pieces will be represented by a jump up (binary option) representing the profit they make on the option

transaction (\$50M - \$15M + \$5M = \$40M), plus a positive slope starting at \$150M (regular call option) representing their new ownership of one-third of the common shares.

EXHIBIT 18-7

EXIT DIAGRAM FOR THE TECHCO OPTIONS

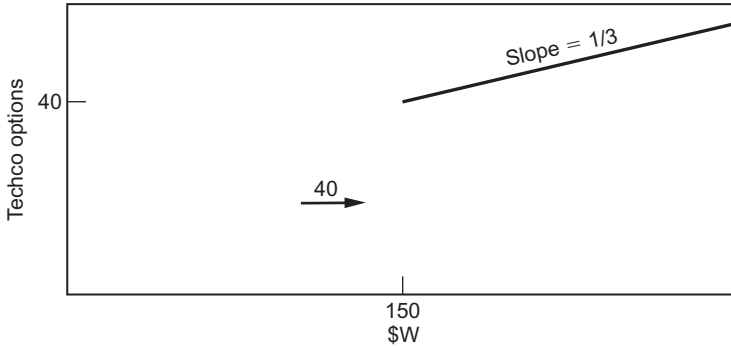

We can read this exit diagram as

$$\text{Partial valuation of Techco options} = 40 * BC(150) + 1/3 * C(150). \quad (18.13)$$

To find the value of the Series A, we must first compute the conversion condition. As in Example 18.2, we don't know whether this conversion condition occurs before or after the conversion of Techco's options, and we don't have a simple RVPS rule to help us. Thus, we must check both possibilities.

Series A conversion condition, Techco not yet converted ($W_A < 150$):

$$1/2 * W > 10 \rightarrow W_A = 20. \quad (18.14)$$

This condition is consistent with $W_A < 150$.

Next, we look to check for a conversion condition if Techco has already converted. In this case, we must add \$15M to the proceeds to represent Techco's exercise payments.

Series A conversion condition, Techco converted ($W_A > 150$):

$$1/3 * (W + 15) > 10 \rightarrow W_A = 15. \quad (18.15)$$

Clearly, Equation (18.15) represents a contradiction with Techco's threshold of \$150M, so Equation (18.14) is the only valid conversion condition. We can now draw the exit diagram for the Series A stake as shown in Exhibit 18-8.

We can read this diagram as

$$\begin{aligned} \text{Partial Valuation of Series A} = & V - C(10) + 1/2 * C(20) - 20 * BC(150) \\ & - 1/6 * C(150). \end{aligned} \quad (18.16)$$

EXHIBIT 18-8

EXIT DIAGRAM FOR THE SERIES A

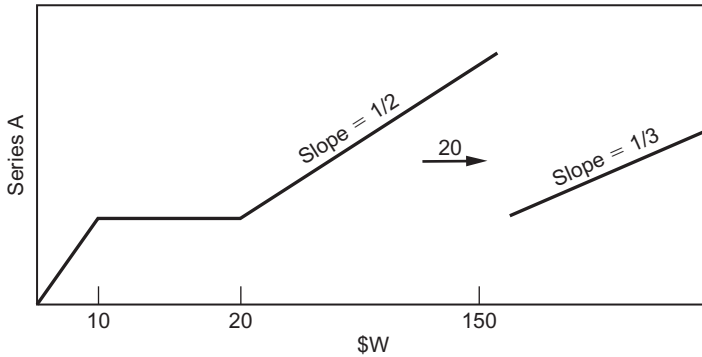

Usually, the part of this diagram that confuses people is the drop of \$20M at $W = 150$. This drop is due to the combination of two effects. First, when Techco exercises their options, they immediately receive $1/3$ of the proceeds, which reduces the value of the EBV stake from one-half of \$150M (= \$75M) to one-third of \$150M (= \$50M). This causes a drop of \$25M. This drop is somewhat cushioned by one-third of the proceeds from the exercise cost ($1/3 * \$15M = \$5M$), leaving a total drop of $\$25M - \$5M = \$20M$. Note that this kind of binary call does not occur when “regular” preferred stock converts, because there is no windfall profit or loss at the time of such conversions. In this example, however, Techco’s options are well in-the-money before they are allowed to convert them at $W = \$150M$. When they are finally able to convert, the resulting profits cause the jumps in the diagrams.

(b) To compute the breakeven valuation (= implied valuation) for the Series A, we first subtract the GP valuation from Equation (18.16) to obtain

$$\begin{aligned} \text{LP valuation of Series E} = & 9/10 * [V - C(10) + 1/2 * C(20) \\ & - 20 * BC(150) - 1/6 * C(150)]. \end{aligned} \quad (18.17)$$

The LP cost is $(\$100M/\$80M) * \$10M = \$12.5M$. As in the previous examples, it is necessary to use the *FLEX* Calculator to compute the IV_{post} . Under base-case assumptions for a Series A investment, we find an IV_{post} of \$30.52M.

(c) Using the IV_{post} of \$30.52M and the same base-case assumptions as in part (b), we can use *FLEX* to compute the partial valuation of Techco’s options (Equation (18.13)) as \$4.58M. ■

18.3 A COMPLEX EXAMPLE

Next, we try to solve a real messy problem. If we can do this, we can do (almost) anything.

EXAMPLE 18.4

We begin with the same setup as in Example 16.5. Talltree has just made a Series F investment in Newco. The details of the Series F and all prior rounds are given below.

Series A: 10M shares of CP (\$6M APP)

Series B: 10M shares of CP (\$10M APP)

Series C: 10M shares of CP (\$4M APP and a 3X liquidation preference)

Series D: 10M shares of PCPC (\$10M APP), with liquidation return capped at 3X APP and a QPO at \$5 per share.

Series E: 10M shares of CP (\$10M APP).

Series F: 10M shares of PCP (\$20M APP) with a QPO at \$6 per share.

These venture investors all have 20 percent carried interest, \$250M in committed capital, and \$50M in lifetime fees. In the event of a liquidation, the preferred stock is redeemed in reverse order of investment (i.e., the Series F has a preference to the Series E, which has a preference to the Series D, and so on). In addition to these investors, the employees have claims on 20M shares of common stock.

Now, we add two new features to this capital structure from Example 16.5, with both of these new features put in place at the same time as the Series F investment. First, the investors create a management carve-out for 20 percent of the first \$50M in exit proceeds. Second, Newco acquires a smaller competitor, Subco, with the owners of Subco receiving 20M shares of common stock, with a further payment of 10M shares of common stock if the merged company has an exit exceeding \$1000M.

Problems

- (a) Compute the breakeven valuation for the Series F under base-case assumptions.
- (b) Given this breakeven valuation, compute the implied valuation for the management carve-out.
- (c) Given this breakeven valuation, compute the implied valuation for Subco's stake.

Solutions

(a) We begin this solution with the same two steps as in Example 16.5. First, we compute the conversion order for the CP. Second, we insert the PCP and PCPC into this order. In order of the RVPS of the CP, we have

Series A: $\$6M/10M = \0.60

Series B: $\$10M/10M = \1.00

Series C: $\$12M/10M = \1.20

Series E: $\$10M/10M = \1.00

We next add the participating preferred to the ordering. For the Series F PCP, automatic conversion occurs at a QPO of \$6 per share, which will be after all series of CP have converted. For the Series D PCPC, we first determine if conversion is voluntary or automatic.

With voluntary conversion at $\$30M/10M = \3.00 and automatic conversion at the QPO = \$5.00, the QPO threshold is redundant and conversion will occur voluntarily at \$3 per share. Finally, we can compute the Series D per-share cap as

$$\text{Per-share cap} : (\$30M - \$10M)/10M = \$2.00.$$

So far, these are exactly the same answers we found in Example 16.5. Our next step is different, as we must find the trigger point for the Subco incentive. At an exit value of \$1B, even if all shares of CP and PCP have already been converted (yielding a total of 100M shares outstanding), the proceeds available to the common stock would be \$1B - \$10M (for the carve-out) = \$990M, for a per-share value of \$990/100M = \$9.90. Thus, the Subco trigger will not occur until after all other series have converted.

Taken together, these calculations imply a conversion and cap order of A (\$0.60), B and E together (\$1.00), C (\$1.20), D (cap) (\$2.00), D (convert) (\$3.00), F (\$6.00), and Subco incentive (\$9.90). Except for the Subco incentive, this is the same answer as we found in Example 16.5. We diverge more from Example 16.5 when we compute the actual conversion conditions for all series. Here, we must take account of the management carve-out and of the additional 20M shares given to Subco. The management carve-out is for the first \$50M of proceeds. As there is a total of \$20M + \$10M + \$10M + \$12M + \$10M + \$6M = \$68M of preferences, we can be confident that the carve-out will be complete while preferences are still being paid, and thus before any of the preferred would choose to convert. Thus, we can simply add the entire value of the carve-out (= 0.20 * \$50M = \$10M) as a preference to the common stock. For the Series A, these preferences total \$68M - \$6M (the Series A RV) + \$10M (the carve-out) = \$72M. Upon conversion, the 10M shares from Series A would represent one-seventh of the common stock because 60M shares would already be outstanding: 20M to the employees, 20M to the previous owners of Subco, 10M (as if) to the Series D PCPC, and 10M (as if) to the Series F PCP. Thus, we have

$$\text{Series A conversion condition : } 1/7 * (W - 72) > 6 \rightarrow W_A = \$114M. \quad (18.18)$$

Series B and E convert at the same time, followed by Series C:

$$\text{Series B conversion condition : } 1/9 * (W - 52) > 10 \rightarrow W_B = \$142M. \quad (18.19)$$

$$\text{Series E conversion condition : } 1/9 * (W - 52) > 10 \rightarrow W_E = \$142M. \quad (18.20)$$

$$\text{Series C conversion condition : } 1/10 * (W - 40) > 12 \rightarrow W_C = \$160M. \quad (18.21)$$

Next in order is the Series D cap, followed by the Series D voluntary conversion.

$$\text{Series D cap : } 10 + 1/10 * (W - 40) = 30 \rightarrow W_D(\text{cap}) = \$240M \quad (18.22)$$

$$\text{Series D conversion condition : } 1/10 * (W - 30) > 30 \rightarrow W_D = \$330M. \quad (18.23)$$

At the QPO of \$6 per share, the only preference left is the \$10M carve-out, so the QPO occurs at

$$\text{Series F conversion condition (QPO): } 100M * \$6 + \$10M = W_F = 610. \quad (18.24)$$

At this QPO, the Series F will return \$20M to the other shareholders and thus recapture $1/10 * \$20M = \$2M$ for themselves, for a net drop of $\$20M - \$2M = \$18M$. Finally, we have the contractual condition that the Subco trigger for extra shares is at $W = \$1000M$. At this trigger, Subco receives 10M additional shares, to raise their stake in the company from $2/10$ to $3/11$. At this point, the only liquidation preference still being paid is the \$10M management carve-out, so $\$1000M - \$10M = \$990M$ remains for the common. The additional 10M shares means that the stake of the Series F investor drops by

$$1/10 * 990 - 1/11 * 990 = \$9M. \quad (18.25)$$

With these calculations in hand, we are ready to draw the exit diagram for the Series F, as shown in Exhibit 18-9.

EXHIBIT 18-9

EXIT DIAGRAM FOR THE SERIES F

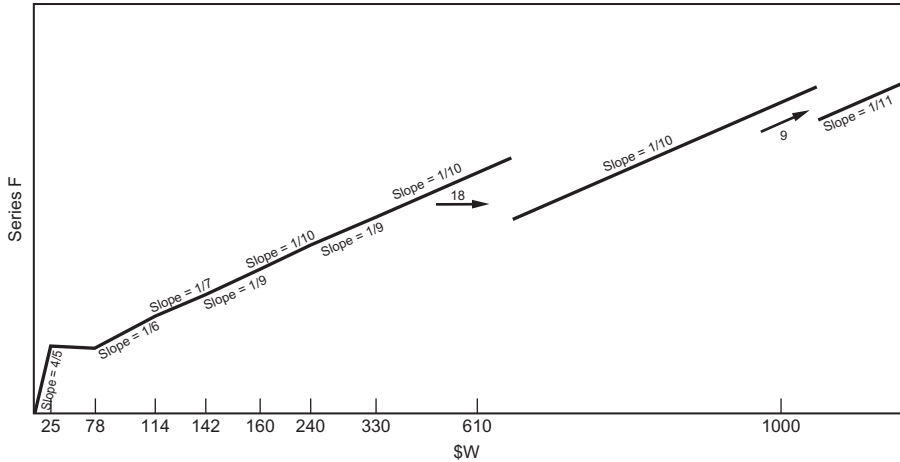

We can read this diagram as

Partial valuation of the Series F

$$\begin{aligned}
 &= 4/5 * V - 4/5 * C(25) + 1/6 * C(78) - 1/42 * C(114) - 2/63 * C(142) - 1/90 * C(160) \\
 &+ 1/90 * C(240) - 1/90 * C(330) - 18 * BC(610) - 9 * BC(1,000) - 1/110 * C(1,000)
 \end{aligned}
 \tag{18.26}$$

Using our standard GP% of 10 percent, the LP valuation of the Series F is 90 percent of Equation (18.26). LP cost for Series F is $(250/200) * \$20M = \$25M$. Finally, we can use the *FLEX* Calculator of *VCV* to compute the breakeven valuation under base-case assumptions as \$171.10M.

(b) The exit diagram for the management carve-out is shown in Exhibit 18-10.

We can read this diagram as

$$\text{Partial valuation of the management carve-out} = 1/5 * V - 1/5 * C(50). \tag{18.27}$$

Using base-case assumptions and the breakeven valuation ($= IV_{post}$) from part (a), we can use *FLEX* to compute this valuation as \$6.96M.

(c) The previous owners of Subco have 20M shares of common stock before their trigger point at $W = 1,000$, when they receive an additional 10M shares. At this trigger point, their value increases by

$$3/11 * (1,000 - 10) - 2/10 * (1,000 - 10) = \$72M. \tag{18.28}$$

EXHIBIT 18-10

EXIT DIAGRAM FOR THE MANAGEMENT CARVE-OUT

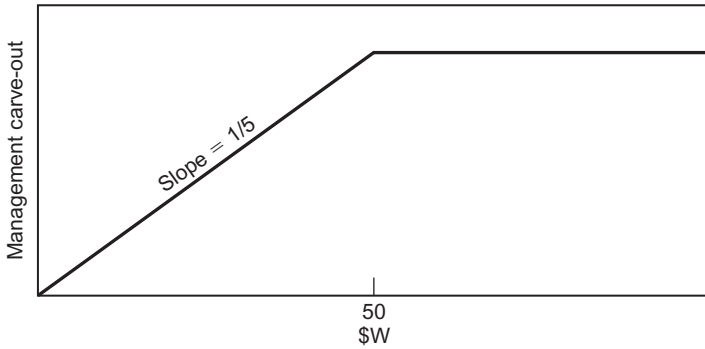
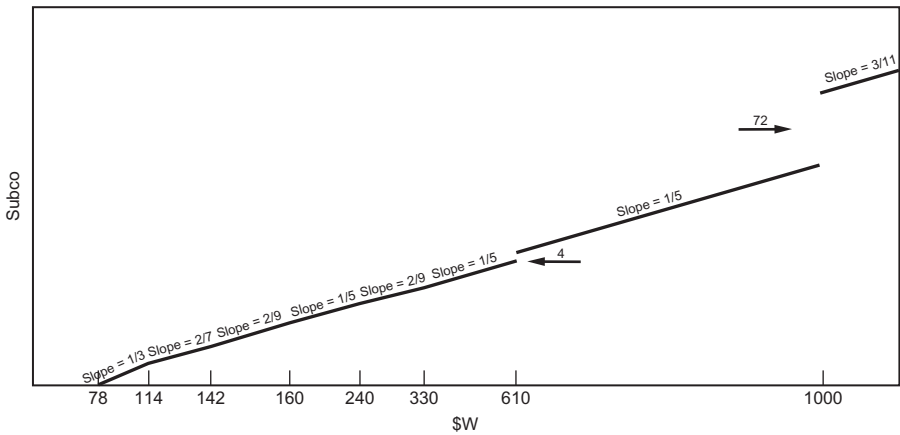

EXHIBIT 18-11

EXIT DIAGRAM FOR THE SUBCO STAKE



We can draw the exit diagram for Subco's stake as shown in Exhibit 18-11. We can read this diagram as

Partial valuation for Subco's stake

$$\begin{aligned}
 &= \frac{1}{3} * C(78) - \frac{1}{21} * C(114) - \frac{4}{63} * C(142) - \frac{1}{45} * C(160) + \frac{1}{45} * C(240) \\
 &\quad - \frac{1}{45} * C(330) + 4 * BC(610) + 72 * BC(1,000) + \frac{4}{55} * BC(1,000).
 \end{aligned}$$

(18.29)

Under base-case assumptions and the IV_{post} found in part (a), we can use *FLEX* to compute the implied value of this stake as \$31.62M. ■

SUMMARY

The option-pricing approach to partial valuation allows us to estimate valuations for virtually all VC structures. In previous chapters, we derived solutions for structures with the standard VC securities of RP, CP, PCP, PCPC, and common stock. These structures can be valued using the prepackaged routines in the *AUTO* Calculator of *VCV*. In some cases, however, the transaction structures can contain unique components that cannot easily be automated. In this chapter, we demonstrated how to use the techniques of Part III to draw exit diagrams for these complex structures and then to value these structures using the *FLEX* Calculator of *VCV*. Examples of such complex securities include management carve-outs (where managers share in exit proceeds with the preferred investors), deals with suppliers or service providers, or incentives included as part of a merger.

KEY TERMS

Management carve-out

EXERCISES

18.1 Newco has received four rounds of investments (Series A, B, C, and D) for a total of 50M shares of CP plus 10M shares of common claimed by the employees. After the Series D investment, Newco falls on hard times. After searching hard for new financing, the investors finally agree to \$10M Series E investment with Vulture Ventures (VV) for 40M shares of CP and a 2X liquidation preference. As part of this agreement, all previous investors (Series A through Series D) give up all their preferred rights and are converted to common stock, so the capital structure of Newco is now 60M shares of common + the Series E CP. As part of the investment, Vulture creates a carve-out: management will receive 20 percent of all exit proceeds, with a value of this carve-out capped at \$5M. Vulture Ventures has \$250M of committed capital, \$50M of lifetime fees, and 20 percent carried interest.

- (a) Draw and read the exit diagrams for the management carve-out, for the Series E, and for all other investors combined.
- (b) Compute the breakeven valuation for the Series E investment under base-case assumptions.
- (c) Compute the implied valuation for the management carve-out under base-case assumptions.

18.2 We use the same setup as in Exercise 18.1, but this time with a different structure for the management carve-out. Now, following the \$10M Series E investment from Vulcan Ventures (40M shares of CP with a 2X liquidation preference), management is promised the following incentives: If Newco has an exit of at least \$40M, then the employees will receive \$5M from these proceeds. If Newco has an exit of at least \$60M, then the employees will receive an additional \$5M from these proceeds. The earlier investors have 50M shares of common, and the employees have claims on a further 10M shares.

- (a) Draw and read the exit diagrams for the management carve-out, for the Series E, and for all other investors combined.
- (b) Compute the breakeven valuation for the Series E investment under base-case assumptions.
- (c) Compute the implied valuation for the management carve-out under base-case assumptions.

18.3 EBV makes a \$5M Series A investment in Newco for 5M shares of CP. The employees of Newco have claims on 10M shares of common stock. At the same time as this transaction, Newco enters into a transaction with Techco to obtain licenses for some Techco patents. As consideration for providing these licenses, Techco receives an option to purchase 10M shares of common stock for \$1.00 a share, but this option can only be exercised on an exit above \$100M. (Assume that this \$100M would be adjusted for any future dilution, so that the threshold is effective for the proceeds owed to the current shareholders.) Newco is aware of the deal with Techco at the time that they make their Series A investment.

- (a) Draw and read the exit diagrams for Techco and for the Series A.
- (b) Compute the breakeven valuation for the Series A investment under base-case assumptions.
- (c) Compute the implied valuation for Techco's stake under base-case assumptions.

18.4 Talltree has just made a Series F investment in Newco. The details of the Series F and all prior rounds are given below.

Series A: 10M shares of CP (\$5M APP)

Series B: 10M shares of CP (\$8M APP)

Series C: 10M shares of CP (\$10M APP and a 2X liquidation preference)

Series D: 10M shares of PCPC (\$10M APP), with liquidation return capped at 4X APP and a QPO at \$5 per share.

Series E: 10M shares of CP (\$12M APP).

Series F: 10M shares of PCP (\$20M APP) with a QPO at \$6 per share.

These venture investors all have 20 percent carried interest, \$250M in committed capital, and \$50M in lifetime fees. In the event of a liquidation, the preferred stock is redeemed in reverse order of investment (i.e., the Series F has a preference to the Series E, which has a preference to the Series D, and so forth). In addition to these investors, the employees have claims on 10M shares of common stock.

Now, we add two other features to this capital structure. First, the investors create a management carve-out for 10 percent of the first \$50M in exit proceeds. Second, Newco

acquires a smaller competitor, Subco, with the owners of Subco receiving 10M shares of common stock, with a further payment of 20M shares of common stock if the merged company has an exit exceeding \$805M.

- (a) Compute the breakeven valuation for the Series F under base-case assumptions.
- (b) Given this breakeven valuation, compute the implied valuation for the management carve-out.
- (c) Given this breakeven valuation, compute the implied valuation for Subco's stake.

PART **IV**

*THE FINANCE OF
INNOVATION*

This page intentionally left blank

R&D FINANCE

RESearch AND development (R&D) is critical for economic growth and improvements in human health and welfare. Indeed, human civilization owes its existence to prehistoric R&D activity. Some early humans sacrificed productive labor time to tinker with toolmaking “technology”, experiment with different forms of agricultural cultivation, and devise alphabets. All these activities would be classified today as R&D, which in its official international definition “comprises creative work undertaken on a systematic basis in order to increase the stock of knowledge, including knowledge of man, culture, and society, and the use of this stock of knowledge to devise new applications”.¹

In the United States, R&D investment is between \$300B and \$400B per year and comprises approximately 2.7 percent of GDP. Because total VC investment has averaged about \$20B per year since 2002, it is clear that the majority of R&D spending must come from other sources. In Section 19.1, we discuss these sources and provide data on geographic and sectoral patterns of R&D investment. In this discussion, we rely on statistics published by the National Science Foundation (NSF) in their annual reports on worldwide and U.S. R&D. In Section 19.2, we introduce two R&D examples—a drug development project and fuel cell development project—that will serve as touchstones for the remaining chapters of the book. In Section 19.3, we describe the advantages and disadvantages of the various methods to finance such projects. Section 19.4 describes the organization of the remaining chapters and introduces the tools necessary for the valuation of complex R&D projects.

19.1 R&D AROUND THE WORLD

Worldwide R&D spending is concentrated in developed countries. Exhibit 19-1 shows the distribution of R&D spending for select countries tracked by the

¹This is the official definition used by the OECD, as quoted in NSF (2005), p. 7.

EXHIBIT 19-1*R&D SPENDING IN SELECT COUNTRIES IN 2007*

Total OECD	886.3
U.S.	368.8
Japan	147.8
Germany	71.9
France	43.2
UK	38.9
Italy	19.7
Canada ^a	23.8
Russia	23.5
China	102.3
Israel	8.8

Figures in PPP \$billions.

^aThe Canadian statistics is from 2008.

SOURCE: NSF (2010), p. 8.

Organization for Economic Co-operation and Development (OECD) in 2007, the most recent year with data for all surveyed countries in the most recent NSF publication. The 30 OECD member countries include all developed economies in the world and some of the developing economies; Israel, Russia, and China are not yet member countries of OECD as of the writing of this book.

As shown in the exhibit, the United States has the most R&D among these developed countries, but the patterns are less skewed than they are for VC spending (as seen in Chapter 6). Most of these countries spend between 1 and 3 percent of GDP on R&D, while Japan and Israel spend higher percentages. Most developing countries spend considerably less, both in absolute terms and as a percentage of domestic GDP. Exhibit 19-2 tabulates R&D as a percentage of GDP for a broad range of countries.

Exhibit 19-2 illustrates the strong emphasis on R&D in both Asian and Nordic countries—it is no accident that these countries have their fair share of high-technology industries. Low R&D percentages in developed countries (e.g., Spain and Italy) do not bode well for the long-run competitiveness of these economies. On the other hand, the low R&D percentages in many developing countries is probably less of a problem, as these economies can still grow rapidly through technology transfer from richer nations; inexpensive labor provides incentives for companies to set up operations in developing countries and to bring advanced technology with them. For example, while India and Brazil (part of BRIC) are missing from this OECD survey, UNESCO (2007) reports that their R&D share of GDP was between 0.5 and 1 percent.

EXHIBIT 19-2*R&D SHARE OF GDP, MOST RECENT YEAR, 2004–2008*

Region/country/economy	RD/GDP (%)	Region/country/economy	RD/GDP (%)
North America		Central and Eastern Europe	
United States (2007)	2.68	Russian Federation (2007)	1.12
Canada (2008)	1.82	Turkey (2007)	0.71
Latin America and Caribbean		Czech Republic (2007)	1.54
Mexico (2005)	0.46	Poland (2007)	0.57
Argentina (2007)	0.51	Hungary (2007)	0.97
Western Europe		Romania (2007)	0.53
Germany (2007)	2.54	Slovenia (2007)	1.53
France (2007)	2.08	Slovak Republic (2007)	0.46
United Kingdom (2007)	1.79	East, South, West Asia	
Italy (2006)	1.13	Japan (2007)	3.44
Spain (2007)	1.27	China (2007)	1.49
Sweden (2007)	3.60	South Korea (2007)	3.47
Netherlands (2007)	1.70	Taiwan (2007)	2.63
Austria (2008)	2.66	Singapore (2007)	2.61
Switzerland (2004)	2.90	Pacific	
Belgium (2007)	1.87	Australia (2006)	2.01
Finland (2008)	3.46	New Zealand (2007)	1.20
Denmark (2007)	2.55	Africa and Middle East	
Norway (2007)	1.64	Israel (2007)	4.68
Ireland (2008)	1.45	South Africa (2005)	0.92
Portugal (2007)	1.18	Selected country group	
Greece (2007)	0.58	OECD (2007)	2.29
Luxembourg (2007)	1.63	European Union-27 (2007)	1.77
Iceland (2008)	2.76	G-7 countries (2007)	2.53

SOURCE: NSF (2010), p. 8.

We turn next to the distribution of R&D activity by funding source, type of R&D organization, and industry. In these exhibits, we focus on data from the United States, for which we have the longest time series of data. In the United States, the vast majority of R&D is funded by either the federal government or by industry. Fifty years ago the federal government was the main provider of R&D funds; around 1980, private industry became the main provider. In 2008, the latest year for which the NSF data is available, industry provided 67 percent of all R&D funding, the federal government provided 26 percent, universities and colleges provided 3 percent, and other nonprofit sources provided the remainder. Exhibit 19-3 illustrates these trends, with spending by source, indexed to inflation using constant 2000 dollars.

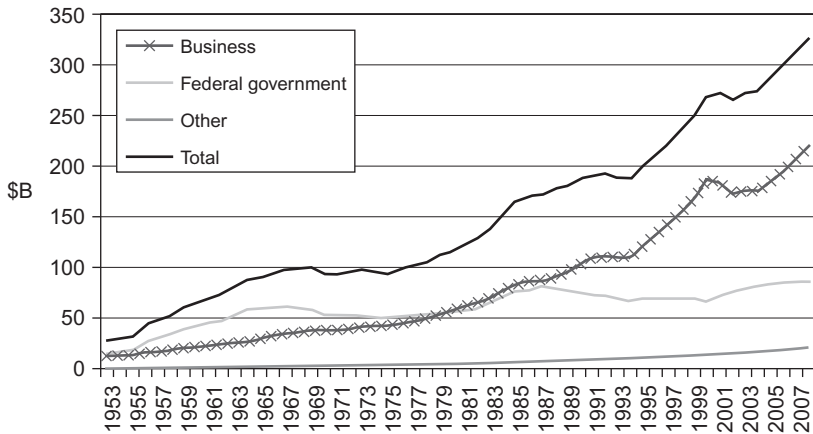
EXHIBIT 19-3*U.S. R&D FUNDING BY SOURCE (IN \$B OF 2000 DOLLARS)*

SOURCE: NSF (2010), p. 5.

Since 1953, inflation-adjusted R&D spending has increased more than elevenfold. Federal spending on R&D has been dominated by defense spending since the beginning of the Cold War; in 2003, the most recent year in which such data is available, the Department of Defense represents nearly half of the federal R&D budget. The largest other component of the federal R&D budget is the National Institutes of Health—a unit of the Department of Health and Human Services—which represents about one-quarter of the total. The cycles of federal R&D can mostly be attributed to corresponding cycles in defense spending, most recently for bioterrorism research.

Exhibit 19-3 tells us where the money came from, but not where the money was spent. For example, in 2008, although the federal government provided 26 percent of R&D funding, it only performed about 11 percent of this work itself. The other 15 percent was paid out to universities and to industry. Exhibit 19-4 illustrates the difference between the source of funds and the actual performance of R&D. The largest beneficiary of federal spending is the academic sector, especially those large universities with medical centers. Industry also receives a considerable transfer from the federal government, but the vast majority of that spending is for defense-related R&D projects.

Thus far, we have discussed R&D as one broad class of activities. It is also informative to break R&D into three types: **basic research**, **applied research**, and **development**. The National Science Foundation's definitions for these three categories are given in Exhibit 19-5.

Of the \$398B of R&D performed in the United States in 2008, approximately 17 percent was basic research, 22 percent was applied research, and 60 percent was

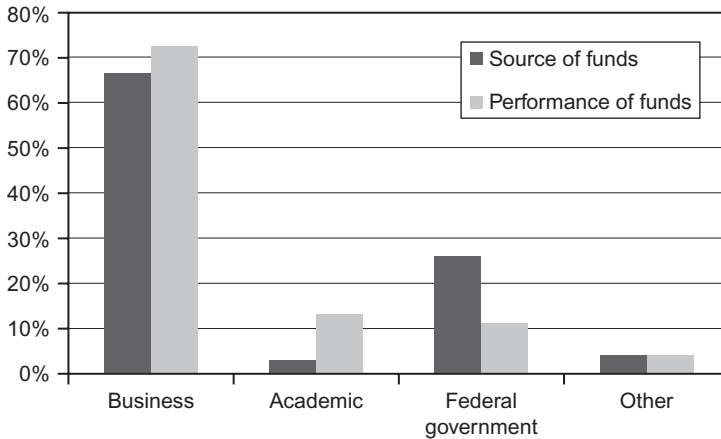
EXHIBIT 19-4*R&D EXPENDITURE BY SOURCE AND PERFORMER, 2008*

SOURCE: NSF (2010), p. 4.

EXHIBIT 19-5*R&D DEFINITIONS FROM THE NSF*

Basic research: The objective of basic research is to gain more comprehensive knowledge or understanding of the subject under study without specific applications in mind. In industry, basic research is defined as research that advances scientific knowledge but does not have specific immediate commercial objectives, although it may be performed in fields of present or potential commercial interest.

Applied research: The objective of applied research is to gain the knowledge or understanding to meet a specific, recognized need. In industry, applied research includes investigations to discover new scientific knowledge that has specific commercial objectives with respect to products, processes, or services.

Development: Development is the systematic use of the knowledge directed toward the production of useful materials, devices, systems, or methods, including the design and development of prototypes and processes.

SOURCE: National Science Foundation (2005), p. 7.

development. In any R&D project, the basic research must be performed before the applied research, which must be performed before development. Although some companies will perform all three steps themselves, it is also common for each step to take place at a different institution. For example, whereas universities performed only 13 percent of all R&D in the United States in 2008, they focus almost

exclusively on basic research: universities performed about 56 percent of all basic research in the United States in 2008, with the results broadly disseminated in academic journals. These results can then provide the background for applied research and development done by industry.

Exhibit 19-6 provides the breakdown of R&D activity across broad industry groups.

The exhibit gives the R&D totals for all industry groups and their subgroup industries that have at least \$5B in R&D. The industry group with the highest R&D by far is “computers and electronic products”. The other manufacturing groups with

EXHIBIT 19-6

R&D BY INDUSTRY AND INDUSTRY GROUP, 2007 IN \$BILLIONS

Industry	All R&D	Federal	Company and other
All industries	269.3	26.6	242.7
Manufacturing industries	187.5	18.2	169.3
Chemicals	D	D	55.3
Pharmaceuticals and medicines	D	D	47.6
Machinery	9.9	0.1	9.8
Computer and electronic products	58.6	8.8	49.8
Communications equipment	11.7	0.2	11.4
Semiconductor and other electronic components	18.7	0.4	18.3
Navigational, measuring, electromedical, and control instruments	20.4	8.2	12.3
Electrical equipment, appliances, and components	2.7	0.1	2.6
Transportation equipment	D	D	31.0
Nonmanufacturing industries	81.8	8.4	73.4
Information	D	D	28.8
Publishing, including software	20.9	0.0	20.9
Telecommunications	D	D	3.1
Internet service and data processing providers	D	D	4.2
Professional, scientific, and technical services	40.5	7.6	32.9
Computer systems design and related services	14.4	0.8	13.6
Scientific R&D services	16.8	4.8	12.0

D = suppressed to avoid disclosure of confidential information.

SOURCE: NSF (2009), p. 3.

more than \$5B in R&D are “transportation equipment”, “machinery”, “electrical equipment”, and “chemicals”, the latter of which is dominated by the pharmaceutical industry.

When the NSF first began gathering R&D statistics, virtually all R&D was performed by manufacturing firms. Over time, with the increased role of service industries in the U.S. economy, a substantial share of R&D has moved to non-manufacturing companies. In particular, the high R&D in the “professional, scientific, and technical services” group is illustrative of large outsourcing trends in the U.S. economy—in this case, the outsourcing of R&D to specialized research organizations. This outsourcing is particularly prominent in the pharmaceutical and computer industries. Another nonmanufacturing group with more than \$5B in R&D is “Information”, which is dominated by the software industry, but also includes “Telecommunications” and “Internet service and data processing providers”. These two categories include both wired and wireless telecommunications carriers, satellite service providers, and web search portals such as Google and Yahoo!.

19.2 TWO TOUCHSTONES

In this section, we discuss two prototypical projects: drug development (Section 19.2.1) and energy innovation (19.2.2). Because we will return to these projects frequently in the following chapters, we call them our “touchstones”.

19.2.1 Drug Development

Our first example is drug development by a pharmaceutical company. The pharmaceutical industry is one of the largest industries in the world in terms of sales, profits, market capitalization, and R&D. For our purposes, their R&D projects are particularly interesting, because drug development is carefully regulated by government agencies. Because of this regulation, drug companies must take their R&D projects through well-defined stages. These stages provide a framework for modeling the investment decisions. In the United States, the principal regulator is the Food and Drug Administration (FDA), and the stages are **preclinical**, **Phase I**, **Phase II**, **Phase III**, and **FDA approval**. Here, *preclinical* refers to all activities that precede testing in humans. Testing in humans—which includes Phases I, II, and III—is collectively known as **clinical trials** or **human trials**. Once all clinical trials have been completed, the data is submitted to the FDA, who makes the final decision allowing (or forbidding) sales to the public.

Typically, scientists work for many years before deciding on a specific compound for testing. During these early years, they use a variety of techniques to identify candidate compounds; then they screen these compounds in the laboratory, by using computer models, and in a progression of animals with increasing similarity to humans. All these activities are classified as preclinical. In this preclinical testing, the researchers are attempting to estimate the potential efficacy and side

effects of the drug. Although all these preclinical activities are costly, the costs increase substantially once a compound proceeds to clinical trials.

To better understand the stages of a clinical trial, we consider a prototypical drug development project by Drugco for Newdrug, a chemical compound designed to treat complications of diabetes. Before any human trials can begin, Drugco must file an Investigational New Drug (IND) application with the FDA. If the FDA accepts the IND, then Phase I trials can begin. In Phase I trials, Newdrug is given to a small number of healthy volunteers—those without diabetes or any other serious medical condition. Because Phase I trials take place in healthy subjects, it is not possible to assess the efficacy of the drug. Instead, the purpose of Phase I trials is to assess the safety of the treatment and to establish some baselines of how the drug is metabolized in humans. On average, Phase I trials cost about \$15M and take one year to complete.²

If Phase I trials are “successful”, then Drugco may proceed to Phase II. What determines success? Obviously, the drug must appear relatively safe. Virtually all drugs have some side effects, but Drugco must carefully weigh the potential side effects against its estimated efficacy before deciding whether to proceed. While the FDA will sometimes approve drugs with serious side effects, this is only likely when the drug fills a serious medical need. In addition to safety, Drugco may also consider any changes in the business conditions related to Newdrug. A lot can happen in the one year it takes to complete Phase I trials. Drugco would be particularly aware of any alternative diabetes treatments coming to market and of any changes in the willingness of insurance companies and government agencies to pay for diabetes drugs.

Phase II trials are the first opportunity for Drugco to test the efficacy of Newdrug in diabetes patients. On average, these tests use several hundred patients, take two years, and cost \$25M. During these trials, the drug is assessed for both efficacy and side effects. It is important to note that these trials must conform to the highest standards of medical testing: double-blind randomized trials. In these trials, some patients receive the actual drug, whereas others receive either an identical-looking but inactive placebo, or an existing standard treatment. Here, “double-blind” means that neither the patient nor the treating physician is aware of whether the patient has received the actual drug or a placebo or standard treatment. This is important, as some researchers can behave differently toward patients depending on whether they are given treatments or placebos.

After Phase II, Drugco must decide whether to proceed to Phase III. On average, Phase III trials take three years and cost \$85M. These trials typically include thousands of patients across several different medical centers. The objective of this phase is to assess definitively the efficacy of the new drug compared with the current “gold standard” treatment for the indication. At the end of Phase III trials, Drugco will submit all their data to the FDA. In making an approval decision,

²Cost estimates for clinical trials are from DiMasi et al. (2003).

the FDA relies heavily on advisory panels of specialized physicians, who weigh the potential costs (side effects) and benefits (efficacy). The FDA would typically take alternative treatments (or lack thereof) into account when considering the potential benefits of the drug. The FDA approval process takes an average of 18 months following the completion of Phase III.

Exhibit 19-7 gives a graphical depiction of the Newco project. The exhibit shows three different types of risks: **technical risks**, **business risks**, and **competitive risks**. Any or all of these risks may play a role at any point in the project. Technical risks are the most straightforward. For Newdrug, the technical risks are “Will this drug work?” (efficacy) and “Will this drug harm patients?” (side effects). These technical risks exist at every stage—it is even possible to learn of new side effects long after a drug has been approved. For valuation purposes, technical risks are often the easiest to model. There are two reasons for this ease of modeling. First, as narrowly defined scientific or engineering projects, it is often possible for project scientists to accurately estimate the probabilities of success. Scientists, with long experience and a familiarity with probability and statistics, can provide analysts with well-informed estimates. Second, as we first studied in Chapter 4, technical risks often have a zero beta (i.e., no correlation with the market). In this case, we can use the risk-free rate as the discount rate and do not have to deal with the complexities of computing a risk-adjusted discount rate. The modeling of technical risks can often be accomplished using Monte Carlo simulation, a topic to be covered in Chapter 20.

EXHIBIT 19-7
DRUG DEVELOPMENT

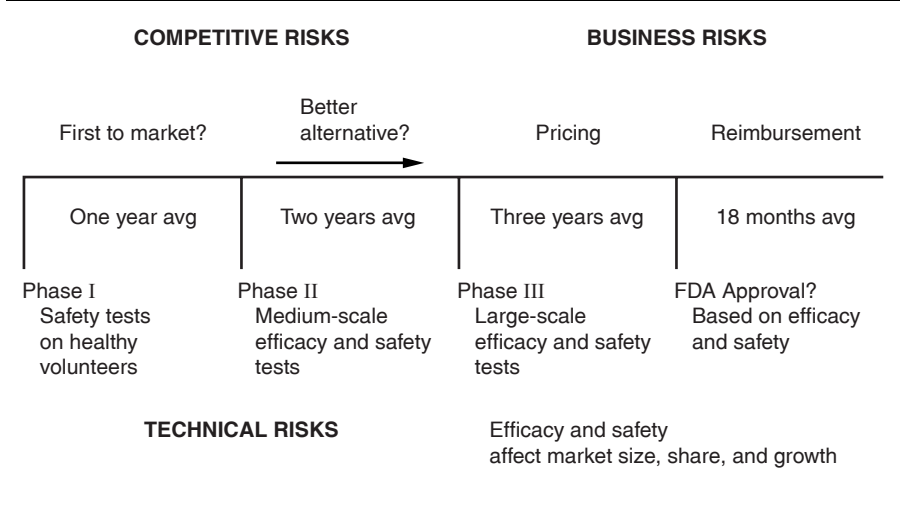

Business risks can take many forms. In general, a business risk relates to changes in consumer preferences. For example, the demand for Newdrug would be affected by the performance of the overall economy, because the availability of health insurance and consumers' willingness to pay out of pocket would both be affected by the strength of the labor market. Also, because diabetes strikes disproportionately among older patients, it is likely that Medicare—government-run health insurance for citizens over the age of 65—would be a major customer. Thus, Drugco needs to worry about the pressure of federal budgets. These types of risks would certainly have positive market betas and would require risk-adjusted discount rates. The computation of these discount rates requires careful modeling for the timing of various investment decisions. These models often use decision trees and real-options analysis (to be studied in Chapter 21), sometimes aided by the use of binomial trees (to be studied in Chapter 22).

Competitive risks relate to the behavior of other companies. For the development of Newdrug, Drugco needs to worry about the competitive responses of other drug companies in the diabetes business. In response to Newdrug, competitors may accelerate (or decelerate) their own diabetes drug projects. Even if these competitors do not develop new drugs, they may alter the pricing of existing drugs, file lawsuits claiming the infringement of some intellectual property, or increase their sales efforts on existing drugs. Some of these activities depend on the state of the economy and hence would carry positive betas and require the calculation of risk-adjusted discount rates. In any case, competitive risks require careful modeling using game theory, a topic covered in Chapter 23.

19.2.2 Energy Innovation

Fuelco is considering several development projects using its patented Newcell technology. Project A is a government contract that requires competitive bidding against other companies. Project B is a product to be sold to automotive manufacturers for eventual resale in consumer projects. Project C is product to be sold directly to consumers. The technology for Project C requires a successful completion of Projects A and B as inputs. Exhibit 19-8 sketches the timeline and risks for these projects.

In the shorthand representation of Exhibit 19-8, we see that each of the three projects has technical risks, with Project C effectively incorporating technical risks from Projects A and B in addition to direct risks from Project C. All three projects may have competitive risks. These risks are clearest for Project A, which must compete for a government contract against other companies. Business risks may be largely absent from Project A (if we are willing to believe that the government will follow through on the contract regardless of economic conditions), but these business risks are present for Projects B and C. In some cases, long-term contracts with potential customers can alleviate business risk in the short run (particularly for Project B), but in the long run it is difficult for energy projects to completely eliminate business risks. For Fuelco, the main business risk is the price of crude oil.

EXHIBIT 19-8**FUEL CELL PROJECT**

1 Year Total	
Project A (government contract)	Technical risk A (does tech A work?) Competitive risk A (do we win the bid?)
Project B (sold to auto manufacturers)	Technical risk B (does tech B work?) Business risk B (what happens to oil prices?)
Project C (sold to consumers)	Technical risk A, B, and C (do tech A,B,C all work?) Business risk C (what happens to oil prices?) Competitive risk C (what do other companies do?)
Technical risk is uncorrelated across the three projects	
Business risk (oil prices) is correlated across B and C	
Competitive risk is uncorrelated across A and C	

If oil is relatively expensive, then there is more scope for alternative energy projects such as Newcell.

In the Newdrug example of the previous section, the regulatory hurdles provide us with a clear framework for modeling. Here, we have no such luck. To model Fuelco's decisions, we will need to make some informed assumptions about the length of time for various development steps, the probability of success for these steps, and the potential market size for each project. Although the Newdrug problem is relatively tidy, the Newcell problem is much messier and much more representative of "typical" R&D projects.

19.3 HOW IS R&D FINANCED?

Return now to our first touchstone, Drugco's R&D project for Newdrug. Suppose Drugco estimates that the Newdrug project will cost \$100M to reach FDA approval. What options does Drugco have to finance this project? In this section, we consider the following options: (1) government, (2) internal corporate funds, (3) banks, (4) public debt markets, (5) public equity markets, (6) venture capital, and (7) strategic partners.

1. *Government.* In the United States, the federal government funds about 25 percent of all R&D. This total funding of \$104B in 2008 was performed at federal, academic, and industrial locations. Although nearly \$14B of this \$104B was used for development-stage R&D in industry, the majority of that \$14B was for defense-related projects. Thus, unless Newdrug is believed to have some biodefense function, it is unlikely that Drugco will be able to finance much of their required \$100M from direct government sources.

Nevertheless, although the government is unlikely to be much help in the direct financing of the Newdrug project, Drugco may receive a significant benefit from the tax system. The first benefit is that, unlike other investments, R&D spending is treated as an expense for tax purposes, so that with an effective federal tax rate of 35 percent, (profitable) companies can recover more than one-third of their costs when they file their taxes. Furthermore, the United States—like most developed countries—has an **R&D tax credit**. A \$1 credit is more valuable than a \$1 deduction, because a \$1 deduction only gives a company 35 cents. The federal *Research and Experimentation Tax Credit* was first introduced in 1981 and provided companies with a credit of 25 percent of “incremental” R&D costs, where these incremental costs are defined as **Qualified Research Expenses (QREs)**. Although the definition of QREs is complex and often contentious, on average they comprise about two-thirds of all R&D costs.

From 1981 to 2009, the “temporary” R&D tax credit was extended 14 times, and the credit grew more complex and slightly less generous. In its most recent form, the typical credit gives companies 20 percent of their QREs. On December 31, 2009, the latest version of the R&D tax credit expired. As of this writing (early 2010), a bill extending the credit through the end of 2010 has passed the House, and is being considered at the Senate (where, if history is any indication, it will probably pass again). In addition to the federal tax credit, many states and municipalities have passed their own R&D tax credits, although total expenditures for these local credits are far lower than the federal version.

2. *Internal corporate funds.* A profitable company can finance R&D from its own positive cash flows. Although \$100M for Newdrug might seem like a lot of money, it would only buy a small portion of the R&D at the largest pharmaceutical companies. We do not have aggregate statistics to tell us the percentage of R&D financed by internal funds, but we can still draw some inferences from the data. Exhibit 19-9 gives the size distribution of companies in the United States, along with the R&D spending for each size group.

We see from this data that more than half of all R&D spending is made by those companies that have more than 10,000 employees. These companies collectively employed nearly 10 million people in the United States alone and had domestic sales of more than 4 trillion dollars in 2007. Because it is difficult to sustain such large enterprises without profits, it is likely that a large portion of that R&D could be financed by internal funds. For smaller companies, we cannot be as sure about the availability of internal funds. For example, the vast majority of *publicly traded* biotechnology firms has fewer than 500 employees and has a negative cash flow. It is safe to assume that—at least for these money-losing companies—internal funds will not be sufficient to pay for a \$100M project like Newdrug.

EXHIBIT 19-9*R&D EXPENDITURE AND COMPANY SIZE IN 2007*

Size of company (number of employees)	\$B
5–24	\$10.9
25–49	\$7.9
50–99	\$10.1
100–249	\$13.4
250–499	\$8.3
500–999	\$14.3
1,000–4,999	\$41.1
5,000–9,999	\$22.7
10,000–24,999	\$45.9
25,000 or more	\$94.8
Total	\$269.3

SOURCE: NSF (2009), p. 2.

- 3. Banks.** In the United States, banks provide the majority of external capital for small companies. In other developed countries, banks have a near-monopoly on small-company finance. Nevertheless, banks are unlikely to provide any significant funds for a \$100M project like Newdrug. Banks are financial institutions that specialize in making loans backed by collateral and a demonstrated ability to repay. A typical bank loan would allow a profitable manufacturer to invest in plant, property, or equipment. Such loans rely on the manufacturer's positive cash flow from other operations, combined with the ability to seize the purchased assets in foreclosure. For riskier loans, banks often turn to various government guarantees. In the United States, the largest such programs are run by the Small Business Administration, which effectively subsidizes loans for "small" companies. Although such loans are certainly helpful for some development projects, the maximum loan size is about \$1M and would provide little help for Drugco.
- 4. Public debt markets.** Historically, public markets for corporate debt have been able to take on projects that are either too large or too risky for an individual bank. For example, it was European investment in publicly traded bonds that largely financed the expansion of railroads in the United States. Although railroads may seem a staid industry today, it was a capital-hungry and speculative industry in the middle of the nineteenth century. More than

100 years later, the public bond markets filled a financing void for mezzanine debt in the large leveraged buyouts of the 1980s. These so-called junk bonds, junior to bank debt in the capital structure, allowed some LBO investors to purchase large companies with less than 10 percent of the deal in equity. Fifteen years later, in the latest credit boom of 2005–2007, the rapid growth of collateralized debt obligations (CDOs) and collateralized loan obligations (CLOs) markets helped LBO firms to buy even larger companies, though the debt-to-equity ratio was considerably lower this time around.

Would public debt markets be willing to finance Drugco's \$100M Newdrug project? It is highly unlikely. Although Newdrug is risky like old-time railroads and new-age LBOs, it is unlike those projects in its inability to pay interest in early years. When railroads were successful, they would have revenues within a few years at most, and most LBOs are even quicker. Newdrug, on the other hand, is expected to take between five and seven years before FDA approval is possible. Until that point, the project would have costs but no revenues. To finance such a project would require zero-coupon bonds, which accrue all interest until their expiration date. However, a zero-coupon bond on a risky project would require a very high interest rate. In this case, the bond would pay off zero if the project failed and would give a large payout, far in the future, if the project succeeded. This sounds a lot like equity! Indeed, the financial instrument just described is almost the definition of "equity capital", which we turn to next.

5. *Public equity markets.* Without question, public equity markets finance a significant fraction of R&D. For evidence, one needs to look no further than the biotechnology industry. There are currently about 350 publicly traded biotechnology companies, which collectively have over \$40B in sales. Approximately one-third of these sales are plowed back into R&D. This industry loses a lot of money: only about one-sixth of all biotech firms are profitable, and the collective losses for the industry have been between \$10B and \$15B per year since 2000. Overall, the industry's losses are about equal to its R&D spending, and that money has to come from somewhere. Since the founding of the industry in the 1970s, biotechnology firms have raised about \$150B, about 60 percent of which came from the public markets.³

From this evidence, we can conclude that public equity markets might make a dent in the \$100M Newdrug project. Indeed, public markets are capable of funding projects of this size, and many public biotech companies can largely finance their drug development by issuing stock to the public. For nonpublic companies, however, such issuance would require an IPO. Historically, biotech companies usually must be in Phase III trials, or at least

³All statistics on the biotechnology industry are from Burrill (2005).

far along in Phase II, before an IPO is possible. Outside the biotech industry—except during the boom period of the late 1990s—companies typically need to be profitable before they can go public. Thus, if Fuelco (Section 19.2.2) were not already public or profitable, then it would be difficult for it to use an IPO to raise funds for the fuel cell project.

Overall, public equity markets are an important source of capital for R&D projects. Nevertheless, even with the other main sources discussed earlier—governments and internal funds—there are still some financing gaps that need to be filled. In particular, applied research and the earliest stages of development are financing challenges for negative cash flow companies.

6. *Venture capital.* Public equity markets have financed approximately 60 percent of the \$150B raised by the biotech industry; the other 40 percent came from VCs. Readers of the previous 18 chapters will already know that VC is an obvious source to fill the financing gap for applied research and early development-stage projects. Unfortunately for Drugco, many biotech VCs are wary of investing in projects in Phase I trials. The low probability of success coupled with large capital needs has pushed most VCs toward projects at Phase II and beyond. Although some VCs do still invest in at Phase I, projects like Newdrug face a difficult task in attracting VC investment, and few VCs would be willing (or able) to support Newdrug through the entire approval process. At some point, Drugco will need to raise public equity or receive an investment from a larger company.
7. *Large companies.* If Drugco is a small company without significant internal funds or access to public markets, then the main alternative to VC is to form a **strategic alliance** with a large drug company. Here, we use the term *strategic alliance* to mean any long-term agreement between companies. The most common strategic alliance in high-tech industries is an **R&D licensing agreement**, also known simply as a **license**. In a typical licensing agreement, the larger company pays the costs for an R&D project performed by a smaller company in return for receiving some rights to the technology. In addition to the direct R&D costs, the larger company often provides an **upfront payment** at the time the deal is signed and **milestone payments** as the project advances. If the larger company has received the rights to sell products based on the technology, then the agreement would typically include **royalty payments** as some fraction of these sales. Finally, in some cases the larger company will make a direct investment in the smaller company at the time of the deal.

Suppose that Drugco enters an R&D licensing agreement with Bigco for the Newdrug project. Drugco expects to need \$100M to pay for the R&D. Bigco agrees to pay these R&D costs, plus a \$50M upfront payment and additional milestone payments of \$25M if Newdrug makes it to Phase II, \$50M for Phase III, and \$100M for FDA approval. In return,

Bigco receives exclusive worldwide marketing rights for Newdrug, with a 10 percent royalty paid to Drugco on all sales. With this license, Bigco would expect to pay a total of $\$100\text{M} + \$50\text{M} + \$25\text{M} + \$50\text{M} + \$100\text{M} = \325M just to get Newdrug approved, plus the royalty on all sales. Obviously, Bigco only enters this transaction if they believe that the NPV for their share of the sales is worth this investment. Many deals of this size or larger are signed every year in the pharmaceutical industry. Overall, licensing deals are the most important source of finance for pharmaceutical R&D at small companies.

Licensing deals can be both lucrative and complex, with many opportunities for financial analysis and the use of option-pricing techniques. For example, consider the following deal in 2005 between Anadys Pharmaceuticals Inc. (the smaller company) and Novartis AG (the larger company):

Novartis gets the exclusive worldwide development, manufacturing, and marketing rights to Anadys's ANA975 and other [similar compounds] for chronic hepatitis B and C viruses and other infectious diseases Novartis will pay a \$20M up-front license fee, \$550M in regulatory and commercial milestones for the development and marketing of ANA975, including \$10M payment upon a successful IND submission (it anticipates a mid-2005 filing). Novartis will provide funding for 80.5 percent of the expenses associated with developing the lead candidate, with Anadys funding 19.5 percent of the costs. Anadys has a co-promotion option to keep 35 percent of the U.S. profits if it pays that percentage of the marketing costs. If Anadys declines the option, it will get royalties on global sales of the resulting product. No equity was exchanged. (Source: In Vivo, July/August 2005, p. 92)

This agreement poses several interesting problems for a financial analyst. In addition to valuing the product conditional on FDA approval (this is somewhat like a success-case exit valuation), it is necessary to estimate the probabilities for achieving each milestone and to value the Anadys option to pay marketing costs. Novartis must make all these estimates before agreeing to this deal. Unlike leanly staffed VC firms, large companies like Novartis often have specialized groups whose sole purpose is to value these deals. Such groups are heavy users of the tools studied in the next five chapters.

19.4 WHERE DO WE GO FROM HERE?

In this chapter, we gave brief descriptions of two examples of R&D projects: a pharmaceutical project (drug development) and an energy project (fuel cell development). The schematic exhibits that accompanied these descriptions,

Exhibits 19-7 and 19-8, summarize the types of risks involved, but do not give us any specific models to analyze. In future chapters, we provide more structure for these (and other) examples in specialized diagrams known as **trees**. The following paragraph describes various types of trees that will be analyzed in the next five chapters. This description is only intended to provide a road map for Part IV—readers are not expected to know how to define or use any of these trees until after they have been covered in the later chapters.

The simplest tree is an **event tree**, which we will study in Chapter 20. Event trees are particularly useful for handling technical risks. Once a decision on a project has been made, event trees help us to value that project. If, instead, we want a tool to help us decide between different options, we use a **decision tree**, which we introduce in Chapter 21. Decision trees are particularly helpful in dealing with technical risks and business risks that are intertwined with future decisions, with the trees showing us if any of the key decisions can be delayed until after these risks have been resolved. Such delay often gives rise to real options, which we also study in Chapter 21. **Binomial trees**, studied in Chapter 22, are a special case of decision trees. In this special case, if we restrict the way that certain risks are modeled, we can pack a large amount of information into a model. Binomial trees are particularly useful for the valuation of options that provide some payoffs before the expiration (or exit) date. In Chapter 23 we introduce game theory and **game trees**, which allow us to model the actions of multiple decision makers in one diagram. Game trees are helpful for modeling competitive risks such as technology races or competitive bidding. Finally, in Chapter 24 we pull all these tools together and solve full-blown models for the drug-development and energy-innovation projects.

SUMMARY

Research and development (R&D) is about 2.7 percent of the U.S. economy and is the primary driver of long-run economic growth. In the United States, almost two-thirds of R&D is funded by corporations, with half of that spending occurring in large corporations that have more than 10,000 employees. R&D investment decisions share many features with VC investment decisions, with long time horizons, high failure rates, and business risks embedded in a rapidly changing technological landscape. In this chapter we introduced two prototypical R&D projects—one in drug development and one in energy innovation. Drug development takes place in a highly regulated environment, which lends itself to structured models with well-specified data and milestones. The energy-innovation project is typical of most other R&D projects, with little regulatory structure and many modeling decisions necessary for the analyst.

In the previous chapters, we studied the VC industry in great detail. Although VC is an important contributor to R&D projects at small companies, most R&D is financed from other sources, including internal cash flow, public equity markets, and strategic alliances. R&D licensing agreements—a type of strategic alliance—play a particularly important role in the funding of drug development R&D.

KEY TERMS

Research and development (R&D)	Technical risks, business risks, competitive risks	Upfront payments, milestone payments, royalty payments
Basic research, applied research, development	R&D tax credit	
Preclinical, Phase I, Phase II, Phase III, FDA approval	Qualified Research Expenses (QREs)	Trees, event trees, decision trees, binomial trees, game trees
Clinical trials = human trials	Strategic alliance R&D licensing agreement = license	

REFERENCES

- Burrill & Company, 2005, *Biotech 2005*, Burrill & Company LLC, San Francisco, CA.
- DiMasi, Joseph A., Ronald W. Hansen, and Henry G. Grabowski, "The Price of Innovation: New Estimates of Drug Development Costs", *Journal of Health Economics* 22, 151–185.
- National Science Foundation, 2005, *National Patterns of Research and Development Resources: 2003*, NSF 05–308, Brandon Shackleford, Arlington, VA.
- National Science Foundation, 2008, *National Patterns of R&D Resources: 2007 Date Update*, NSF 08-318, Mark Boroush, Arlington, VA.
- National Science Foundation, 2009, *Info Brief*, NSF 09–316, Raymond M. Wolfe, Arlington, VA.
- National Science Foundation, 2010, *Info Brief*, NSF 10–312, Mark Boroush, Arlington, VA.
- UNESCO Institute for Statistics, 2007, *A Global Perspective on Research and Development: Fact Sheet, UIS/FIS/07/05*, available at www.uis.unesco.org.

MONTE CARLO SIMULATION

IN MANY R&D projects, several random variables can affect the outcome. To compute the NPVs of these projects, it is necessary to multiply the probability of each outcome by its corresponding payoff. When many different risks intersect at one time, this computation can be difficult or impossible. To solve this problem, analysts often use computers to **simulate** thousands (or millions) of possible outcomes and then estimate the NPV as the average of these simulated outcomes. Because these computational methods are reminiscent of games of chance in Monte Carlo, the most popular method is called **Monte Carlo simulation**.

In this chapter, we learn the concepts and mechanics behind these simulations. In Section 20.1, we show how to represent uncertainty by using event trees, and we demonstrate how to solve for the NPV of an event tree by Monte Carlo simulation. The problems in Section 20.1 use simple **discrete random variables** with two possible outcomes: “success” or “failure”. In Section 20.2, we introduce **continuous random variables** and demonstrate how to use these variables in Monte Carlo simulation. The examples in Section 20.1 and 20.2 are relatively simple and, in fact, could be solved without using simulation. In Section 20.3, we model a version of the Newdrug project from Chapter 19. In this model, there are several independent sources of uncertainty, and simulation provides the fastest route to a solution.

20.1 EVENT TREES

Drugco has just begun Phase III trials for Newdrug. Drugco’s scientists estimate that the R&D has a 50 percent chance of success (= FDA approval), and Drugco management estimates an NPV of \$1B at the time of approval. If the drug fails, then it would be worth nothing. The success of the drug will be learned over the next three years, over which the discount rate is equal to the riskfree rate of

5 percent per year.¹ The total cost of R&D is \$100M and must be paid at the beginning of development. Exhibit 20-1 gives a graphical representation of this information using an **event tree**.

EXHIBIT 20-1

EVENT TREE FOR NEWDRUG

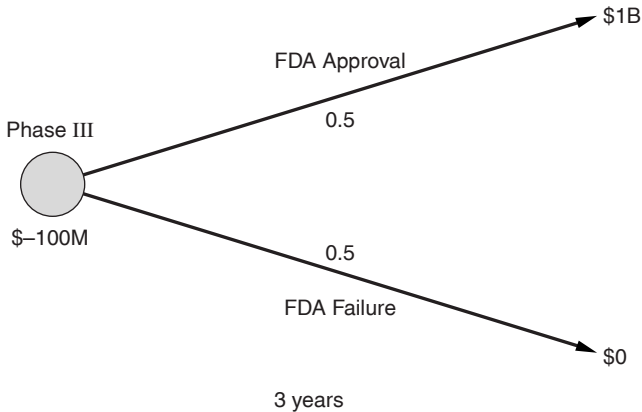

The event tree uses circles to signify a **risk node** in the tree. In this case, the risk node is followed by two possible **branches**. The success branch has a probability of 50 percent, leading to a **terminal node** with a payoff of \$1B. The failure branch has a probability of 50 percent, leading to a terminal node of \$0. We can use all the information in the tree to calculate the expected value of the terminal nodes as $0.5 * \$1B = \$500M$. Using a discount rate of 5 percent for three years, we can compute the NPV of the new drug as

$$\text{NPV} = 0.5 * \$1B / (1.05)^3 - \$100M = \$331.9M. \quad (20.1)$$

This is about as easy as a valuation can get: one source of risk, two branches, and a constant discount rate. For the next five chapters we will take problems like this and add complications. In many cases, these complications make it difficult to calculate NPVs in simple equations like (20.1). In those cases, **Monte Carlo simulation** is often the most efficient way to compute the NPV. In Monte Carlo simulation, the

¹Why the riskfree rate? Recall the Boxco versus Drugco example from Chapter 4: if the project only has technical risk, then this risk can be diversified away and has a zero beta. We discuss discount rates in more detail in Chapter 21.

analyst generates random numbers and “simulates” thousands of possible outcomes for the event tree. Then, the average outcome is the expected value of the tree.

In our simple Newdrug tree, the only random variable is FDA approval of the drug, which has a simple yes/no probability distribution. To simulate this distribution, we can imagine flipping a coin 10,000 times, with each “heads” flip leading to FDA approval, and each “tails” flip leading to FDA failure. On average, this process will give us 5,000 flips of heads, so the expected outcome will be the same as Equation (20.1). To perform this randomization on a computer—a much more efficient way to flip a coin—we can either use specialized simulation software, or we can program the simulation ourselves using a general package like Microsoft Excel.

For the next two examples in this chapter, we will show how to do the simulation “the hard way” using Microsoft Excel. By doing some simple examples in Excel, the reader can learn the intuition and mechanics behind the simulation methods. For complex examples, programming everything in Excel becomes unwieldy, and it is much more efficient to use a specialized package. In Appendix C of this book, we provide a brief users’ guide to Crystal Ball[®], a popular simulation program that works as an add-in to Excel. In that appendix, we also provide Crystal Ball solutions for all the examples in this chapter.

To compute the NPV of Newdrug using Excel, we use the random number function—the Excel command is “rand()”—to generate a random number between 0 and 1. Then, if this random number is less than or equal to 0.5, we classify the outcome as FDA approval. If the outcome is greater than 0.5, we classify the outcome as FDA failure.

Exhibit 20-2 displays the output for 10 draws of the simulation. In the “Random Number” column, we type the Excel command “rand()”, which yields a random number between 0 and 1. In the “FDA Approval” column, we use an if

EXHIBIT 20-2

MONTE CARLO SIMULATION: FIRST TEN DRAWS

Draw	Random number = rand()	FDA approval?	NPV
1	0.8172	0	−\$100.00
2	0.8729	0	−\$100.00
3	0.3396	1	\$763.84
4	0.9276	0	−\$100.00
5	0.0186	1	\$763.84
6	0.6416	0	−\$100.00
7	0.4539	1	\$763.84
8	0.9188	0	−\$100.00
9	0.2199	1	\$763.84
10	0.3146	1	\$763.84

statement: if (Random Number < 0.5, 1, 0), which yields the answer of one if FDA approval occurs, and zero if it fails.² Finally, the NPV column computes the NPV as $\text{FDA Approval} * \$1\text{B}/(1.05)^3 - \100M . To run multiple draws, we need only type these formulas into the first row and then copy this row down. (Thus, it is just as easy to do 10,000 draws as it is to do 10.) The average of the “NPV” column is the Monte Carlo estimation of the NPV. On average, we should get \$331.9M, the same answer as achieved from Equation (20.1).

Of course, real problems are rarely so simple. A slightly more complex version of the problem would consider all three phases of the approval process. We do this in the next example.

EXAMPLE 20.1

Drugco has just begun Phase I trials for Newdrug. Phase I takes one year and costs \$10M. Drugco’s scientists estimate that the R&D has a 50 percent chance of successfully completing Phase I and moving to Phase II. Phase II takes one year and costs \$30M. If Newdrug enters Phase II, the scientists estimate a 40 percent chance of successfully completing Phase II and moving to Phase III. Phase III takes three years (including the time waiting for FDA approval) and costs \$60M. If Newdrug enters Phase III, the scientists estimate a 50 percent chance of success (= FDA approval). Drugco management estimates an NPV of \$1B at the time of approval. If the drug fails, then it would be worth nothing. The discount rate is equal to the risk-free rate of 5 percent per year. All development costs must be paid at the beginning of the respective phase.

Problems

- Draw the event tree for the Newdrug project.
- Find and solve the formula for the NPV of the Newdrug project.
- Build a Monte Carlo simulation for Newdrug and confirm the same (average) NPV solution as obtained in part (b).

Solutions

(a) Given the information in the example, we can draw the event tree as shown in Exhibit 20-3. (b) In Exhibit 20-3, there is a different probability of success for each stage. Each risk node in the tree is given a number (1 to 3 in the tree) to help us keep track of things. At any node, the failure branch ends the project and has a payoff of zero. Only the terminal node with \$1B has a positive payoff. To find the NPV of the project, we must compute the probability of reaching each node in the tree, and then discount the expected payoffs of those nodes by the appropriate number of years. Thus, the NPV for Node 1 is $-\$10\text{M}$, and

$$\text{NPV of Node 2} = (0.5 * -\$30\text{M})/1.05 = -\$14.3\text{M}, \quad (20.2)$$

$$\text{NPV of Node 3} = (0.5 * 0.4 * -\$60\text{M})/(1.05)^2 = -\$10.9\text{M}, \quad (20.3)$$

$$\text{NPV of terminal node of } \$1\text{B} = (0.5 * 0.4 * 0.5 * \$1\text{B})/(1.05)^5 = \$78.4\text{M}. \quad (20.4)$$

²In the actual Excel spreadsheet, we would need to use an exact cell address instead of “random variable”. Similarly, other examples in this chapter will use variable names instead of cell addresses.

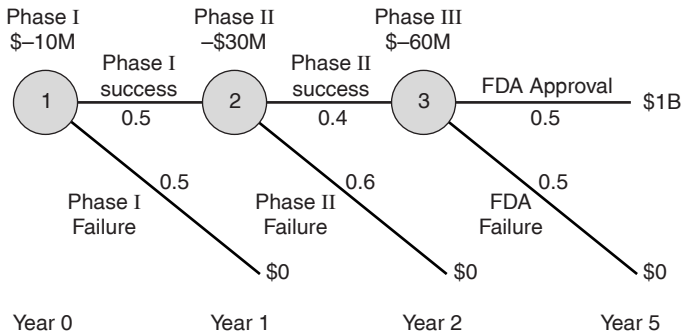
EXHIBIT 20-3**EVENT TREE WITH THREE RISK NODES**

So the NPV of the whole project is

$$\text{NPV of project} = \$78.4\text{M} - \$10\text{M} - \$14.3\text{M} - \$10.9\text{M} = \$43.1\text{M}. \quad (20.5)$$

(c) To do a Monte Carlo simulation, we define a random variable in Excel for each risk node and then combine these random variables with the costs of development and terminal values, just as in Equation (20.4). Exhibit 20-4 demonstrates an example of this simulation.

EXHIBIT 20-4**MONTE CARLO SIMULATION: FIRST TEN DRAWS**

Draw	(1) rand()	Phase I success?	(2) rand()	Phase II success?	(3) rand()	FDA approval?	NPV
1	0.4127	1	0.0373	1	0.7718	0	-\$92.99
2	0.8501	0	0.7807	0	0.0544	0	-\$10.00
3	0.9134	0	0.8742	0	0.9967	0	-\$10.00
4	0.7750	0	0.6548	0	0.2297	0	-\$10.00
5	0.9448	0	0.4999	0	0.5549	0	-\$10.00
6	0.9625	0	0.5304	0	0.0089	0	-\$10.00
7	0.0766	1	0.3117	1	0.5861	0	-\$92.99
8	0.1479	1	0.7106	0	0.4112	0	-\$38.57
9	0.9461	0	0.3570	0	0.0422	0	-\$10.00
10	0.1802	1	0.0104	1	0.0674	1	\$690.53

In Exhibit 20-4, Phase I success depends only on the outcome of the first random number [labeled as (1) in the top row of the table], Phase II success depends on the outcome of

both Phase I and Phase II [labeled as (2) in the top row], and FDA approval requires Phase I success, Phase II success, plus the outcome of Phase III [labeled as (3) in the top row].

The average estimate from this simulation is \$43.1M, the same answer as we obtained in part (b). ■

20.2 SIMULATION WITH CONTINUOUS PROBABILITY DISTRIBUTIONS

Example 20.1 used **discrete random variables**, where the different outcomes can be separated when plotted on a line, like a “1” for success and a “0” for failure. In many applications, it is necessary to use **continuous random variables**, where the different outcomes have no gaps when plotted on a line. Continuous variables have an infinite number of possible outcomes, where the relative likelihoods of these outcomes is represented as a **probability density function (pdf)** and drawn as two-dimensional curve.

The simplest type of continuous distribution is the uniform distribution. If a variable x is distributed as a uniform distribution with a minimum point of a and a maximum point of b , then we use the shorthand notation $x \sim U[a, b]$, where “ \sim ” stands for “is distributed as”. We write the pdf, $f(x)$, as

$$U(a, b) : f(x) = 1/(b - a). \quad (20.6)$$

Exhibit 20-5 illustrates this pdf.

EXHIBIT 20-5

UNIFORM PDF

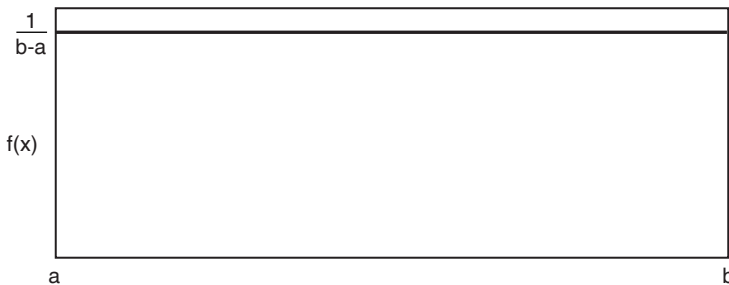

For Monte Carlo simulations, we will make heavy use of the **cumulative distribution function (cdf)**. The cdf, written as $F(x)$, is the area under a pdf up to

point x , which can be written as the integral of $f(x)$ from the distribution minimum to x .

The cdf of a uniform distribution is

$$F(x) = \int_a^x \frac{1}{b-a} dz = \frac{x-a}{b-a}. \tag{20.7}$$

By construction, all cdfs must be equal to one at the maximum of their range. The uniform cdf is illustrated in Exhibit 20-6.

EXHIBIT 20-6

UNIFORM CDF

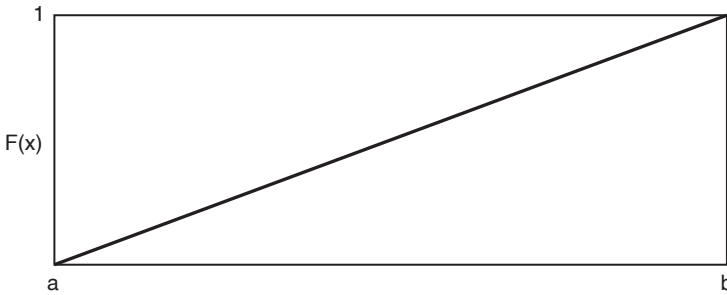

In general, the **mean** (= expected value) of a continuous random variable, x , can be written as the integral

$$\int_{-\infty}^{\infty} x * f(x) dx. \tag{20.8}$$

For a uniform distribution, we have $f(x) = 1/(b - a)$. Also, the upper and lower bounds are not infinity, but are given by a and b . Thus, the mean of a uniform distribution can be solved as

$$\int_a^b x * \frac{1}{b-a} dx = \left. \frac{x^2}{2(b-a)} \right|_a^b = \frac{b^2 - a^2}{2(b-a)} = \frac{(b+a)(b-a)}{2(b-a)} = \frac{b+a}{2}. \tag{20.9}$$

Now, let's use the uniform distribution in an NPV calculation.

EXAMPLE 20.2

Drugco has just begun Phase III trials for Newdrug. For simplicity, we assume that we are sure the drug has no side effects, so all that matters for FDA approval is its efficacy. Efficacy is distributed $E \sim U[0,1]$ and will be learned during three years of Phase III trials. The NPV of the drug after 3 years is $\$1B * E^2$ (i.e., even with a low efficacy and a high likelihood of FDA failure, we are still allowing for some salvage value for the project). The discount rate is equal to the riskfree rate of 5 percent per year. The total cost of R&D is \$100 M and must be paid at the beginning of development.

Problems

- Draw an event tree for the Newdrug project.
- What is the NPV of Newdrug if efficacy is set equal to its expected value?
- Use Monte Carlo simulation to solve for the NPV of the Newdrug project.
- Why is the answer to part (b) different than the answer to part (c)?

Solutions

- We begin with the event tree, given in Exhibit 20-7.

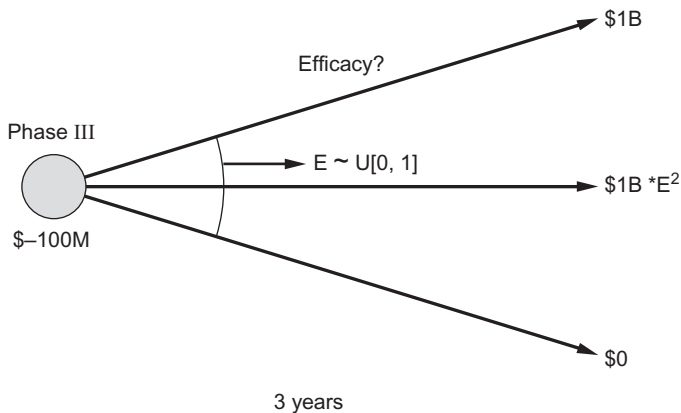
EXHIBIT 20-7**EVENT TREE FOR NEWDRUG, WITH UNIFORM DISTRIBUTION**

Because the uniform distribution has an infinity of possible outcomes, we do not bother drawing lots of branches, but instead draw three branches connected by a curve. The notation for the distribution— $U[0,1]$ —is then given after an arrow on the middle branch. The top

branch represents the maximum of the distribution (if applicable), and the bottom branch represents the minimum. The main formula for the terminal nodes is given on the middle terminal node. In the remaining chapters, we follow this same convention for representing continuous distributions within trees.

(b) From Equation (20.9), we know that the mean (= expected value) of a uniform distribution is equal to $(b + a)/2$. In this case, we have $b = 1$ and $a = 0$, so the mean is $1/2$. If we substitute $E = 1/2$, then the expected terminal value would be $\$1B * (1/2)^2 = \$250M$, and the NPV would be $\$250M/(1.05)^3 - \$100M = \$116.0M$.

(c) To simulate from a continuous distribution, we must invert the cdf to find the efficacy (E) that goes with a specific random draw. To provide a graphic illustration of this inversion, consider the following three steps:

Step 1: Draw a random number between 0 and 1.

Step 2: Plot this random number on the Y -axis of the cdf.

Step 3: Find the corresponding point on the X -axis.

The answer to Step 3 is the “draw” from the continuous distribution. These three steps are illustrated in Exhibit 20-8 for an example draw of $\text{rand}() = 0.748$. For this case, the sampling procedure turns out to be very easy, because the cdf of a $U[0,1]$ distribution is just $F(E) = E$. Nevertheless, for even more complex distributions considered later, we can still visualize the procedure using the same three steps. Of course, the actual steps are done by a computer. With our knowledge that $F(E) = E$, we build an Excel worksheet to perform the simulation.

EXHIBIT 20-8

SAMPLE FROM A CDF FOR $E \sim U[0, 1]$

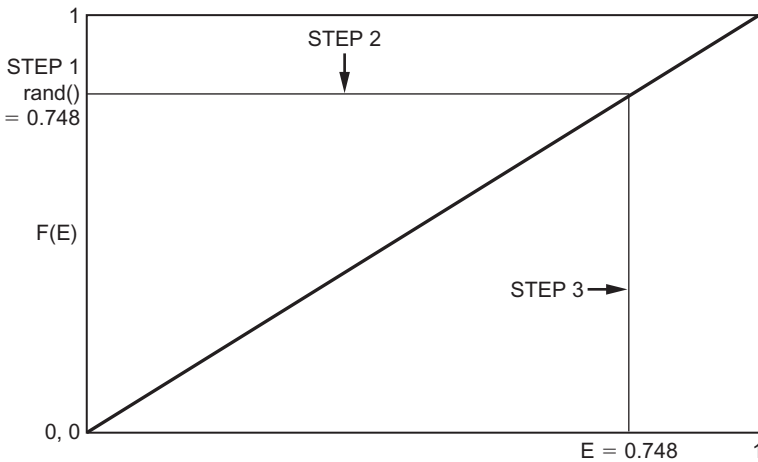

Exhibit 20-9 displays sample output from 10 draws.

EXHIBIT 20-9

MONTE CARLO SIMULATION: FIRST TEN DRAWS

Draw	rand() = $F(E) = E$	NPV
1	0.2171	−\$59.29
2	0.5099	\$124.58
3	0.7905	\$439.80
4	0.4074	\$43.37
5	0.8775	\$565.21
6	0.2346	−\$52.47
7	0.9779	\$726.03
8	0.9250	\$639.07
9	0.2250	−\$56.26
10	0.5531	\$164.31

On average, this simulation yields an estimate of \$187.9M for the NPV.

(d) In part (b), we substituted the mean value of $E = 1/2$ and solved for an NPV of \$116.0M. In part (c), we used Monte Carlo simulation to estimate an expected NPV of \$187.9M. The most important thing to recognize about this difference is that *Monte Carlo simulation is the correct way to estimate the NPV*. The answer in part (b) is *wrong*. It is wrong because when we have a **non-linear model**, it is not correct to simply substitute expected values in for random variables. The model is nonlinear because it includes a term for E^2 , the square of efficacy. Once we introduce any nonlinearity, it is no longer correct to substitute expected values for random variables. This is a very important point that applies to any DCF analysis that has nonlinear interactions between its inputs.

It is fine to replace variables by their expected values in a **linear model**. Suppose, for example, that the terminal payoffs were written as $\$1B * E$. Then, an analyst would get the same (average) answer from simulation as he would by just substituting $E = 1/2$. Exercise 20.1 will ask you to confirm this result. ■

Mathematical Interlude

Example 20.2 calculated the NPV using a simulation—this is called a “computational solution”. Alternatively, we could have just derived the formula for the NPV—this is called an “analytical solution”. To derive an analytical solution with continuous variables, we take an integral of each possible outcome multiplied by its probability density. (This is similar to the way we computed the mean of an expected value in Equations (20.8) and (20.9)). For any outcome, E , the terminal value is $E^2 * \$1B$. The probability density of that outcome is $f(E)$, so the quotient

is $= E^2 * \$1B * f(E)$. Then, the expected terminal value is the integral of these quotients for the entire $[0,1]$ range of E . In our example, we have $b = 1$ and $a = 0$. Thus, $f(E) = 1/(b - a) = 1$. With this formula, we can compute the expected terminal value as

$$\text{Expected terminal value} = \int_a^b \$1B * E^2 dE = \left. \$1B * \frac{E^3}{3} \right|_a^b = \$333.3M. \quad (20.10)$$

Then, we can solve for the NPV as

$$\text{NPV} = \$333M / (1.05)^3 - \$100M = \$187.9M. \quad (20.11)$$

We solved Example 20.2 with a computational solution to illustrate an important point: *Monte Carlo simulation is just a computational method to solve integrals.* For relatively simple problems like Example 20.2, the integral would be easier to do than the simulation. However, in most real-world problems, it is not possible to solve the integral. In those cases, Monte Carlo simulation is the best way to get an answer.

End Mathematical Interlude

Next, we examine two other useful distributions: the normal and the log-normal. Exhibit 20-10 shows the familiar “bell curve” for the pdf of a normal distribution with a mean of μ and a standard deviation of σ .

EXHIBIT 20-10

NORMAL PDF

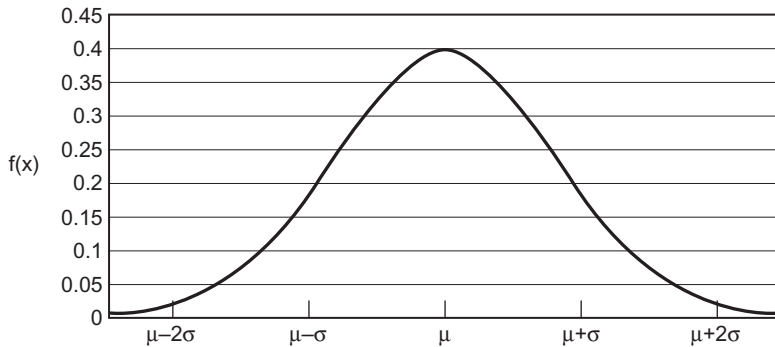

The formula, $f(x)$, for this pdf is

$$N(\mu, \sigma) : f(x) = \frac{1}{\sigma\sqrt{2\pi}} \exp\left[-\frac{(x-\mu)^2}{2\sigma^2}\right]. \quad (20.12)$$

There is no need to integrate Equation (20.12) to find the mean of the normal distribution: the mean is already given to us as the parameter μ .

The corresponding cdf is illustrated in Exhibit 20-11.

EXHIBIT 20-11

NORMAL CDF

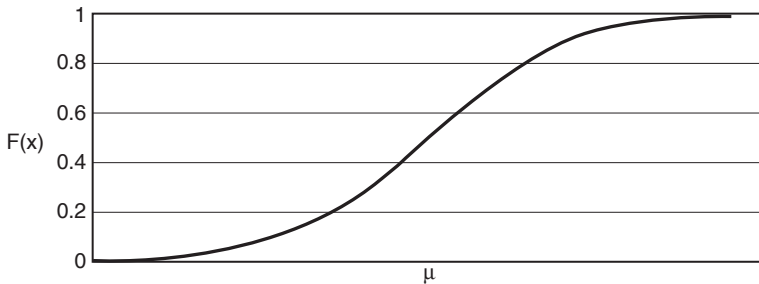

Log-normal distributions are often used in finance for distributions of asset returns. In a log-normal distribution, the natural log of x ($= \ln x$) is distributed with a normal distribution (as in 20.12). This has the nice property that x can never be negative, which is useful for many finance applications. We first saw a picture of a log-normal distribution in Chapter 13, when we studied the Black-Scholes formula. If x is distributed log-normally, with $x \sim \text{LogN}(\mu, \sigma)$, then the pdf of x is

$$\text{LogN}(\mu, \sigma) : f(x) = \frac{1}{\sigma x \sqrt{2\pi}} \exp\left[-\frac{(\ln x - \mu)^2}{2\sigma^2}\right], \quad (20.13)$$

where the notation “ $\exp[x]$ ” is equivalent to e^x .

This pdf is illustrated in Exhibit 20-12. In the $x \sim \text{LogN}[\mu, \sigma]$ notation, μ is *not* the mean of x , but rather is the mean of $\ln x$. Similarly, σ is not the standard deviation of x , but is the standard deviation of $\ln x$. To compute the mean of x , we would integrate $x * f(x)$ from 0 to infinity, where $f(x)$ is given by Equation (20.13). The solution to this integral is

$$\text{mean of } x \text{ when } x \sim \text{LogN}[\mu, \sigma] = \exp[\mu + \sigma^2/2]. \quad (20.14)$$

EXHIBIT 20-12

LOG-NORMAL PDF

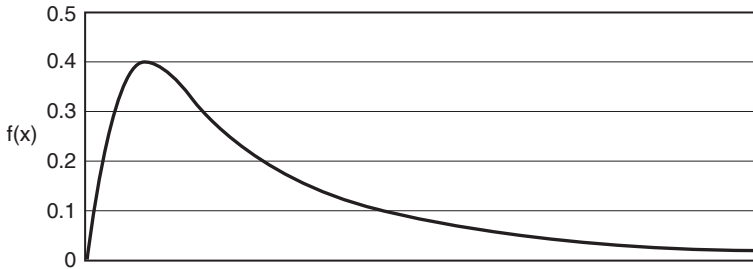

This “extra” term of $\sigma^2/2$ might remind some readers of similar terms floating around as part of the Black-Scholes formula (Chapter 13). This similarity is no coincidence: the Black-Scholes formula uses assumptions about log-normal returns in continuous time, so the means of these distributions will have the $\sigma^2/2$ term in them.

Exhibit 20-13 illustrates a cdf for a log-normal distribution.

EXHIBIT 20-13

LOG-NORMAL CDF

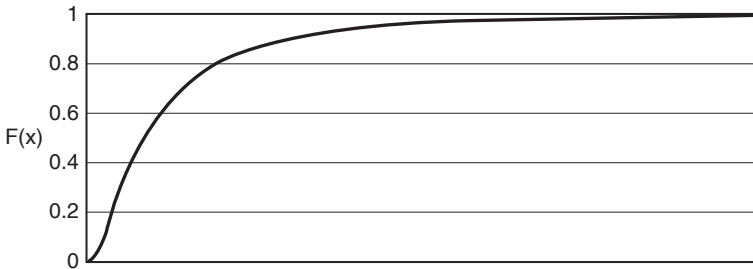

EXAMPLE 20.3

Drugco has just begun Phase III trials for Newdrug. For simplicity, we assume that we are sure the drug has no side effects, so all that matters for FDA approval is its efficacy. Efficacy is distributed $E \sim \text{LogN}[0, 1]$ and will be revealed after three years of Phase III trials. The NPV of the drug after three years is $\$1B * E^2$. The discount rate is equal to the risk-free rate of 5 percent per year. The total cost of R&D is $\$100M$ and must be paid at the beginning of development.

Problems

- (a) Draw the event tree for this project.
 (b) What is the NPV of Newdrug if efficacy is set equal to its expected value?
 (c) Use Monte Carlo simulation to estimate the NPV of the project.

Solutions

(a) The event tree is identical to Exhibit 20-7, except that we replace the uniform distribution with a log-normal distribution.

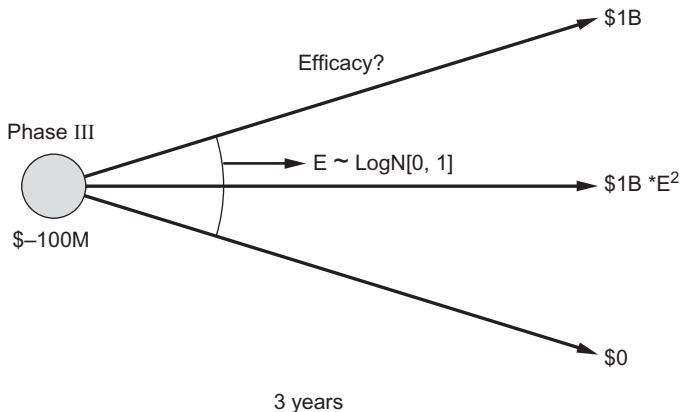
EXHIBIT 20-14**EVENT TREE FOR NEWDRUG, WITH LOG-NORMAL DISTRIBUTION**

(b) From Equation (20.14), we know that the mean of $\text{Log } N[0,1]$ is equal to $\exp[0 + 1/2 * (1)^2] = \exp[1/2] = 1.65$. Substituting this mean for E yields an expected terminal value of \$2.72B and

$$\text{NPV} = \$2.72\text{B}/(1.05)^3 - \$100\text{M} = \$2.25\text{B}. \quad (20.15)$$

Because this is a nonlinear model, we know that \$2.25B is not the correct NPV for the project.

(c) To solve for the correct NPV, we set up a Monte Carlo simulation as in Exhibit 20-9. To perform this simulation, we make use of the Microsoft Excel built-in function to give the inverse of the cdf for a log-normal distribution. The syntax for this function is $\text{loginv}[(F(x), \mu, \sigma)]$, so we can do simulations by substituting the random number function, $\text{rand}()$, for $F(x)$.

After 1,000,000 draws, this simulation gave an average NPV of \$6.24B. This is much higher than the answer in part (b), which demonstrates the importance of using simulation in this example. Why is this answer much higher? Because the log-normal distribution is not symmetric—extreme outcomes are possible only in the long “right-tail” of Exhibit 20-12. When extreme outcomes are possible, the square term exacerbates these

EXHIBIT 20-15*MONTE CARLO SIMULATION: FIRST TEN DRAWS*

Draw	rand() = F(E)	E	NPV
1	0.9931	11.7513	\$119,190.77
2	0.4724	0.9332	\$652.31
3	0.0474	0.1882	-\$69.41
4	0.8850	3.3221	\$9,433.84
5	0.7578	2.0123	\$3,397.88
6	0.8735	3.1363	\$8,397.22
7	0.9013	3.6301	\$11,283.62
8	0.9246	4.2056	\$15,178.48
9	0.4581	0.9001	\$599.87
10	0.3610	0.7007	\$324.11

outcomes into extreme values for the NPV. We can see an example of such an extreme outcome in draw #1 of Exhibit 20-15. ■

Although many other distributions are useful for analysts, in this book we will use only the uniform, normal, log-normal, and one other—the triangular distribution. Unlike the other distributions used in this book, triangular distributions are rarely found “in nature”. Instead, these distributions are an invention of analysts looking for a shorthand way to express their intuition about relative likelihoods on a fixed range. A triangular distribution is described by three parameters—minimum (a), maximum (b), and mode (c)—with notation $T(a, b, c)$, with a pdf that looks like Exhibit 20-16.

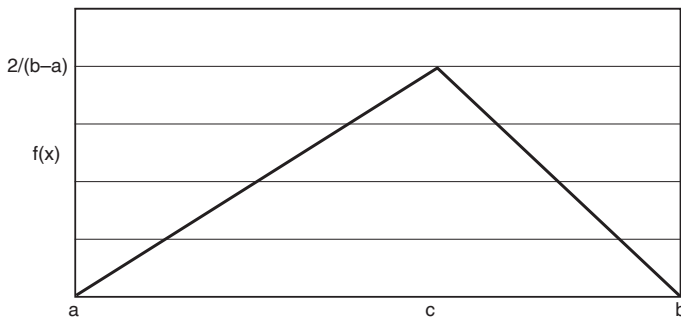
EXHIBIT 20-16*TRIANGULAR PDF*

Because the triangular distribution is not found in most standard textbooks, it will be useful for us to take some time to discuss a few of the key properties for this distribution. To be a proper pdf, the total area under the $f(x)$ curve must be equal to a total probability of 100 percent. Because the triangular distribution is indeed a triangle, its area is equal to $1/2 * \text{base} * \text{height}$. Writing the base as $= \text{maximum} - \text{minimum} = b - a$, and the height at the mode (point c) as h , we have

$$\text{Area} = 1/2 * (b - a) * h = 1 \rightarrow h = 2/(b - a), \tag{20.16}$$

which is given as the maximum height in Exhibit 20-16. Because the density begins at zero at point a , rises linearly to its maximum height at point c , and then falls linearly back to zero at point b , we can write the equation for the pdf as

$$\text{for } x < c : \frac{2}{b - a} * \frac{x - a}{c - a} = \frac{2 * (x - a)}{(b - a) * (c - a)}.$$

$$T(a, b, c) : f(x) = \tag{20.17}$$

$$\text{For } x \geq c : \frac{2}{b - a} * \frac{b - x}{b - c} = \frac{2 * (b - x)}{(b - a) * (b - c)}.$$

The mean of a triangular distribution is $= (a + b + c)/3$. We will use this mean in our solution to Example 20.4.

The cdf for this triangular distribution is illustrated in Exhibit 20-17.

EXHIBIT 20-17
TRIANGULAR CDF

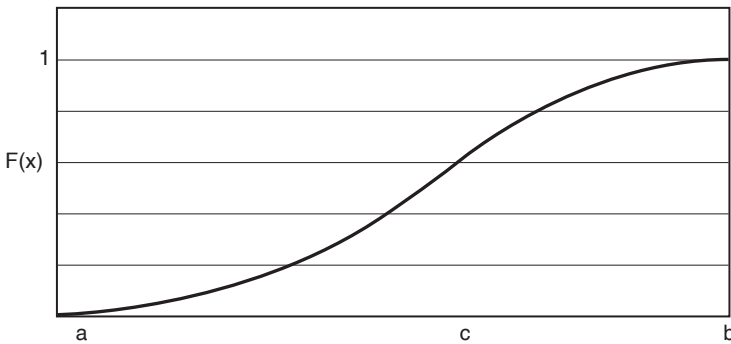

20.3 SIMULATION WITH MULTIPLE SOURCES OF UNCERTAINTY

With the tools of the earlier sections, we are ready to tackle a more complex problem.

EXAMPLE 20.4

Drugco has just begun Phase III trials for Newdrug at a cost of \$100M. Drugco expects Phase III trials to take two years and the FDA approval decision to take one year, so that the FDA decision is expected in three years. Phase II trials were promising, with a score of 40 on the standard medically recognized scale. (We will refer to this score as the “efficacy” of the drug.) Although the best alternative drug has an efficacy of 50, it is not helpful for all patients. Given the side effects of Newdrug and the risks and benefits of alternative treatments, Drugco believes that the FDA will approve Newdrug if the Phase III trials find an efficacy of 30 or greater. Based on the results of the Phase II trials, Drugco estimates that the efficacy results of Phase III will be $E \sim N(40, 20)$. (It is possible for efficacy to be negative because some drugs can make symptoms worse.) During the three years of Phase III trials, it is possible that the alternative treatments will also improve from their current efficacy of 50. Drugco estimates a final distribution for the alternative of $A \sim T(50, 100, 50)$. If Newdrug is approved by the FDA, then its market share will depend on the relative efficacy of Newdrug versus the best available treatment, that is,

$$\text{Newdrug market share} = E^2 / (E^2 + A^2). \quad (20.18)$$

Drugco estimates market size for Newdrug in the approval year (in millions of doses) as $M \sim N(1000, 100)$, with 6 percent annual growth going forward. Each dose yields a gross profit of \$1. To stay in the market, Drugco must spend \$300M on marketing in the first year, with this sum increasing each year by 6 percent. Upon approval, Newdrug would have 10 years of patent life remaining. After the patent expiration, Drugco expects generic competition and other improved alternatives to greatly erode the value of Newdrug, so for simplicity we assume that the continuing value would be zero after the patent expires. Following earlier examples in this chapter, we assume a discount rate equal to the riskfree rate of 5 percent.

Problems

- Draw the event tree for the valuation of Newdrug.
- What is the probability of FDA approval for Newdrug?
- What is the expected value in three years for A , the efficacy of the best alternative treatment?
- Suppose that all random variables are exactly equal to their expected values. What would be the NPV of Newdrug?
- Use Monte Carlo simulation to estimate the NPV of Newdrug.

Solutions

- The event tree is given in Exhibit 20-18.

EXHIBIT 20-18

EVENT TREE FOR NEWDRUG

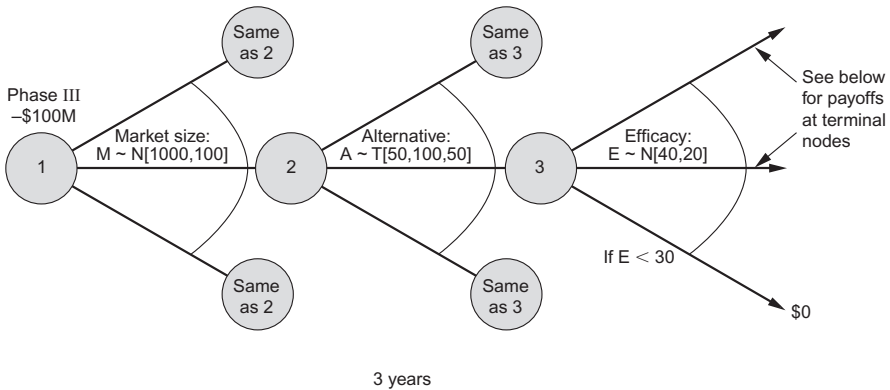

The first year of profits following the terminal nodes with $E > 30$ (FDA approval) = $M * E^2 / (E^2 + A^2) - \$300M$. For years 2 through 10, multiply profits in the previous year by 1.06, then sum all years and discount by 1.05 per year to get the NPV.

(b) Efficacy is distributed as $N[40, 20]$, so we can estimate the probability that $E > 30$ by using the cdf for this distribution, $F(E)$:

$$\text{Probability of approval} = \text{Prob}(E > 30) = 1 - F(30) = 0.69. \quad (20.19)$$

Thus, there is a 69 percent chance that a draw from the $N[40, 20]$ distribution will be greater than 30. (The normal cdf can be accessed as a built-in function of Microsoft Excel called "normdist".)

(c) As mentioned earlier in our discussion of triangular distributions, the mean of a triangular distribution is equal to $(a + b + c)/3$. In this case, we have $a = 50$, $b = 100$, and $c = 50$, so

$$\text{Expected value of the alternative treatment} = (50 + 100 + 50)/3 = 66.7. \quad (20.20)$$

(d) Exhibit 20-19 provides a DCF model for calculating the NPV of Newdrug. The bolded cells in the model are the random variables: efficacy, alternative efficacy, and starting market size. In this model, each of the random variables is set at its expected value. Efficacy is distributed as $N[40, 20]$ and so is set to 40. Alternative efficacy is distributed $T[50, 100, 50]$ and so is set to 66.7 (as discussed in part (c)). Starting market size is distributed as $N[1000, 100]$ and so is set to 1000. At these expected values, Newdrug is approved by the FDA, the market share is equal to 26.5 percent $(= 40^2 / (40^2 + 66.7^2))$, and profits in the first year postapproval ($=$ year 4 of the model) are equal to gross profits of $0.265 * 1000$, minus marketing costs of $\$300M = -\$35.3M$. The overall NPV (as of year 0) is then equal to $-\$410.6M$.

(e) To perform a Monte Carlo simulation on this model, we need to make separate draws for each of the random variables. Because three random variables feed into a multiyear model, it would be unwieldy (but not impossible) to build this simulation directly in Excel. Instead, we

EXHIBIT 20-19

DCF MODEL FOR NEWDRUG, ALL VARIABLES SET TO THEIR EXPECTED VALUES

				Mean	Stdev		Min	Mode	Max	
Efficacy		40		40	20					
Alternative efficacy		67					50	50	100	
Starting market size		1,000		1,000	100					
Approval threshold		30								
Gross profit per unit		1								
Market share		26.5%								
Market growth		6.0%								
Discount rate		5.00%								
approved?		1								
				\$ in millions						
Year	3	4	5	6	7	8	9	10	11	12
Market size	1,000	1,060	1,124	1,191	1,262	1,338	1,419	1,504	1,594	1,689
Market share	26.5%	26.5%	26.5%	26.5%	26.5%	26.5%	26.5%	26.5%	26.5%	26.5%
Gross profit	\$264.7	\$280.6	\$297.4	\$315.3	\$334.2	\$354.2	\$375.5	\$398.0	\$421.9	\$447.2
Marketing costs	\$300.0	\$318.0	\$337.1	\$357.3	\$378.7	\$401.5	\$425.6	\$451.1	\$478.2	\$506.8
Profit	-\$35.3	-\$37.4	-\$39.7	-\$42.0	-\$44.6	-\$47.2	-\$50.1	-\$53.1	-\$56.3	-\$59.6
NPV as of year 0	-\$410.6									

suggest using a specialized program like Crystal Ball. In Appendix C, we show how to use Crystal Ball, and we discuss the implementation of Crystal Ball for the model in Exhibit 20-19. After 1M draws, the simulation gives an average NPV of \$285.9M, which is significantly higher than the NPV found in part (d). Sixty-nine percent of the draws resulted in FDA approval (as solved in part (b)). The outcomes below $-\$100M$ occur when gross profits are less than the $\$300M$ marketing costs. An example of such an outcome is given in Exhibit 20-19. One might think that Drugco should simply abandon the project if projected profits are negative. This reasoning is absolutely correct, but it is not yet built into this model. To allow Drugco this kind of flexibility, we will need to use decision trees and real options. We will learn these tools in Chapter 21, and we will extend Example 20.4 to allow for such flexibility in Example 21.4. ■

SUMMARY

R&D investment decisions often require the analysis of several risks at the same time. These risks can often be modeled as random variables and represented in an event tree. If the analyst needs to estimate the NPV of an R&D project, then she will need to posit the probability distributions of these random variables. In this chapter, we learned some basic properties of four different continuous probability distributions: uniform, normal, log-normal, and triangular. In some cases, a model may be simple enough to allow an analytical solution for the NPV of an R&D project. In many cases, however, the analyst must find a computational solution by using Monte Carlo simulation. In Monte Carlo simulation, the computer makes draws from each probability distribution for each draw of the simulation. The estimated answer is the average answer over many draws. Simple simulations can be performed using Microsoft Excel. For more complex simulations, it is helpful to use a specialized package such as Crystal Ball. Appendix C shows how to solve all the examples from this chapter using Crystal Ball.

KEY TERMS

Monte Carlo simulation = Monte Carlo analysis	Event tree Risk node, terminal node	Cumulative distribution function (cdf)
Discrete random variables, continuous random variables	Branch Probability density function (pdf)	Mean Nonlinear model, linear model

EXERCISES

20.1 Drugco has just begun Phase III trials for Newdrug. For simplicity, we assume that we are sure the drug has no side effects, so all that matters for FDA approval is its efficacy. Efficacy is distributed $E \sim U[0, 1]$ and will be learned during three years of Phase III trials. The NPV of the drug after three years is $\$1B * E$. The discount rate is equal to the riskfree rate of 5 percent per year. The total cost of R&D is $\$100M$ and must be paid at the beginning

of development. (Note that this problem is identical to Example 20.2 except for the formula for the NPV after three years.)

- (a) Draw an event tree for the Newdrug project.
- (b) What is the NPV of Newdrug if efficacy is set equal to its expected value?
- (c) Use Monte Carlo simulation to solve for the NPV of the Newdrug project.
- (d) On average, will the answer to part (b) be different than the answer to part (c)?

20.2 Drugco has just begun Phase III trials for Newdrug. For simplicity, we assume that we are sure the drug has no side effects, so all that matters for FDA approval is its efficacy. Efficacy is distributed $E \sim T[0, 1, 0.4]$ and will be learned during three years of Phase III trials. The NPV of the drug after three years is $\$1B * E^2$. The discount rate is equal to the risk-free rate of 5 percent per year. The total cost of R&D is \$100M and must be paid at the beginning of development. (This is tricky, because Microsoft Excel does not have a built-in function for the Triangular distribution. To solve this, you will either need to be creative or use Crystal Ball.)

- (a) Draw an event tree for the Newdrug project.
- (b) What is the NPV of Newdrug if efficacy is set equal to its expected value?
- (c) Use Monte Carlo simulation to solve for the NPV of the Newdrug project.
- (d) On average, will the answer to part (b) be different than the answer to part (c)?

20.3 *True, False, or Uncertain:* Done properly, analytical solutions and computational solutions will give the same result every time.

20.4 Consider the same problem as in Example 20.4, except that now we add two additional types of uncertainty. In Example 20.4, we assumed that the gross profit per unit was fixed at \$1. Now, we assume that this gross profit is distributed as $T[\$0.50, \$1.50, \$1]$, with this level learned on FDA approval and then fixed for the life of the product. Next, if Newdrug is approved, then there is a 10 percent chance every year that a superior product will be introduced by a competitor. If this superior product is introduced, then Newdrug's sales are cut in half for all future years (relative to what they would have been without this superior product.) Only one superior product can be introduced in each year, but it is possible for such products to be introduced in multiple years. For example, if a superior product occurs in year 6 and in year 8, then Newdrug would have one-half of its original (Example 20.4) sales in years 6 and 7, and then one-quarter of its original sales in year 8 and beyond.

- (a) Use Monte Carlo simulation to solve for the NPV of Newdrug.

REAL OPTIONS

YOU ARE stranded alone on a desert island. For the sake of argument, we assume that you would like to get off this island. You have a flare gun with one charge. You see a plane flying overhead. The plane is not directly over the island, so you are uncertain if your flare will be visible. Do you fire? If you do fire, it will be your only shot. If you don't fire, what are the chances that a plane will ever fly any closer?

In making this decision, you are considering a **real option**. Real options are created whenever you face a decision that is costly to reverse. In the desert island example, the firing of the gun is irreversible. You can delay firing the gun (thus preserving the “option” to fire), but you are uncertain about the outcome. If you do fire, the real option is exercised, as your only flare has been spent. It is not easy to solve this problem. To do it right, you would need to estimate various probabilities and make complex calculations—all in the short time before the plane goes by.

The solving of real options problems has two parts. The first part is “spotting options” and the second part is “valuing options”. To spot options, we need to have a deep understanding of the whole decision landscape. In our desert island case, this would only require that you realize that the gun has only one flare. In other situations, an analyst must be clever enough to recognize (or create) real options where none are obvious.

In Section 21.1, we show how real options can be represented in a decision tree. In Section 21.2, we classify different types of real options that are relevant for R&D decisions. In Section 21.3, we show how to value these options using replication—the same technique first studied in Chapter 13. In Section 21.4, we demonstrate another solution technique: risk-neutral valuation. Finally, in Section 21.5, we apply real-options methodology to extend our Drugco example from the previous chapter.

21.1 DECISION TREES

When a decision maker is considering all possibilities, it is helpful to sketch all possible events and decisions in a **decision tree**. A decision tree adds **decision nodes** to an event tree (Chapter 20). Exhibit 21-1 gives a decision tree for Joe Veesee's drive home from work.

EXHIBIT 21-1

COMMUTING OPTIONS

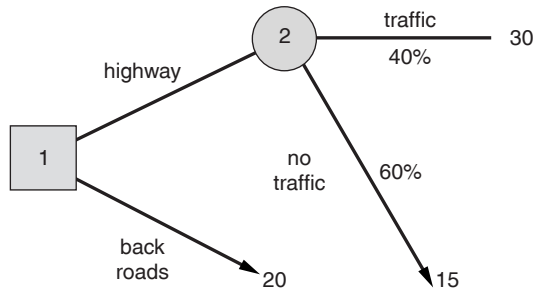

Upon leaving his garage, Joe has two choices: he can take the highway or he can take “back roads”. This choice is represented with a box at the decision node. If he takes back roads, then he will get home in 20 minutes for sure. If he takes the highway, there is some traffic risk. This risk is represented by a risk node (circle) in the tree. When there is no traffic on the highway, it is Joe’s fastest route (15 minutes). If there is traffic on the highway, then the same commute would take 30 minutes. Based on past experience, Joe knows that there is a 40 percent chance of traffic (and a 60 percent chance of “no traffic”), so his expected commute time if he takes the highway is $0.6 * 15 + 0.4 * 30 = 21$ minutes. If Joe cares only about the average time of his commute, then he would compare the expected commute times for each of his choices and then pick the faster (back roads) route.

So far, this is a straightforward problem. Joe has to make an irreversible decision right at the beginning, and then nature takes its course. The problem gets more interesting if we give Joe the “option” of getting off the highway. For example, suppose that traffic conditions can be observed once he enters the highway (but not before) and that after only a few minutes of such traffic he can exit the highway and take an alternate route. This alternate route is not as fast as the original “back roads” option, but it is not as slow as staying on the highway with traffic. Exhibit 21-2 gives a decision tree for Joe’s commuting problem with this new exit option.

EXHIBIT 21-2

COMMUTING OPTIONS, WITH EXIT

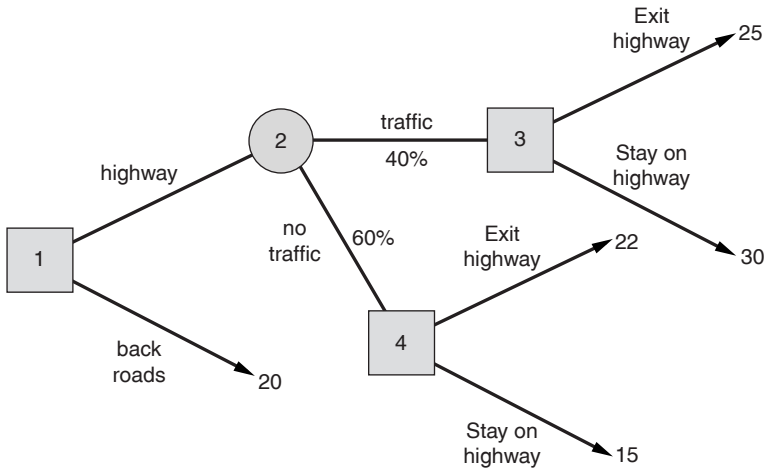

Decision trees are solved backward. Consider Joe's decision at Node 3. If he chooses to exit the highway, his commute will be 25 minutes. If he chooses to stay on the highway, his commute will be 30 minutes. Thus, he should choose to exit the highway. Conversely, at Node 4 his fastest option is to stay on the highway, for a commute time of 15 minutes. With this information, we can prune the decision tree by replacing Nodes 3 and 4 with their optimal decisions. This pruning yields Exhibit 21-3. Next, we

EXHIBIT 21-3

COMMUTING OPTIONS, PRUNED

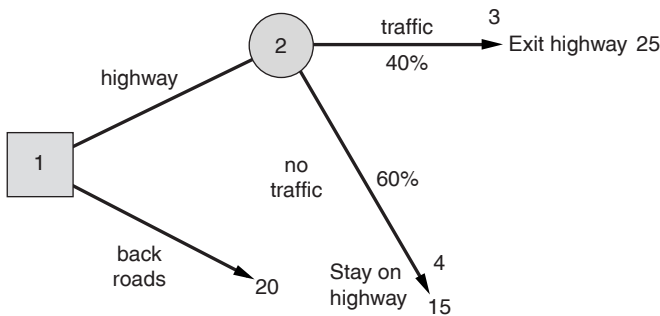

compute the expected value at Node 2 as $0.4 * 25 + 0.6 * 15 = 19$ minutes. Because this is less than the 20 minutes for “back roads”, the optimal decision at Node 1 is to take the highway.

21.2 REAL OPTIONS IN R&D

As mentioned in the introduction, real options occur whenever you face a decision that is costly to reverse. Anybody who shies away from commitment with the excuse that “I am just trying to keep my options open” is indeed doing exactly that: commitment implies some cost for reversing the decision. Real option analysis is an attempt to quantify the value of “flexibility”. In R&D settings, there are many possible applications. Most of these applications can be classified more naturally as either call options or put options—but keep in mind that for a decision maker considering whether to take “Action A” or “Action B”, it is often possible to redefine a call option on Action A as a put option on Action B.

The following discussion describes six different types of real options. This is by no means a comprehensive list.

Call Options

The Option to Delay: Drugco has possible development projects based on the same science behind Newdrug. Drugco scientists are not sure if these new projects will work, but they expect to learn more about the probabilities of success after learning whether the original Newdrug project is successful. Examples 21.1 and 21.2 analyze options to delay.

The Option to Expand: Semico is considering whether to add capacity to their microchip fabrication plant. The value of an added-capacity plant depends on the demand for Semico’s chips. If Semico can wait and learn more about demand before deciding whether to add capacity, then this is a type of call option.¹

The Option to Extend: Autoco currently builds its Oldcar at an aging plant in Michigan. The assembly lines in this plant are so outdated that Autoco loses money manufacturing Oldcar, and it looks like the brand is slowly dying. If we know with certainty that the demand for the brand will never pick up, then it is best to shut down the plant today. But Autoco management believes that there is some chance that the demand will be high again in the near future, so keeping the

¹In recessions, new investments decline because many companies decide to keep their expansion options alive and not exercise them. In recoveries, the opposite happens – finally companies see enough positive signs in the economy and decide to exercise their options, so investments surge. See, for example, “Radical Shifts Take Hold in U.S. Manufacturing”, *Wall Street Journal*, February 3, 2010.

plant open gives them an option to extend the brand for a few more years at a moderate cost.²

Put Options

The Option to Abandon: Drugco is currently developing Newdrug to treat diabetes. Drugco scientists believe it is likely that Newdrug will be approved by the FDA, but this approval is still three years away. In the meantime, alternative treatments might be improved, the expected market for Newdrug might shrink, and pricing pressures might harm margins for the drug. Although it is possible that Newdrug will be a blockbuster, it is also possible that it will be a money loser (after marketing costs). Drugco would like to continue trials for the drug while preserving the option to abandon the project later on if it proves to be unprofitable. We analyze this case in Example 21.4.

The Option to Shrink: This is the flip side of the option to expand, considered earlier. If Semico needed to wait a year before deciding whether to reduce some capacity, then it would be a type of put option.

Combinations of Options

Option to Switch: Joe Veese’s commuting problem in Section 21.1 is an example of a switching option. Switching options can be calls, puts, or a combination of the two. It is more natural to think of the option on the asset that has some uncertainty. Hence, for Joe Veese, it was a put option because he would have to “sell” the road that he was already on. Alternatively, if Joe could start on the back roads, listen to the traffic report on the radio, and then switch to the highway if there was no traffic, then he would be “buying” a new road, and it would be a call option. Finally, if both the back roads and the highway had uncertainty, and Joe could learn about the traffic on both roads and switch back and forth, then he would hold a combination of puts and calls.

21.3 THE VALUATION OF REAL OPTIONS

The valuation of real options is essentially about solving for the correct discount rate. The easiest problems to solve are those with no beta risk, so that all discount rates are equal to the riskfree rate.

²As of 2010, it looks like the Big 3 let this option expire for Saturn, Pontiac, and a few other brands.

EXAMPLE 21.1 (Fuelco)

Fuelco is considering a development project using its patented fuel-cell technology. (This corresponds to “Project A” as originally discussed in Chapter 19.) If Fuelco pays \$200M to start the project, then they are permitted to bid for a government contract. The objective probability of winning the contract is 50 percent, and there is no beta risk for the government’s decision. If Fuelco’s bid is accepted (one year later), then they can choose to finish the project by accepting the contract (cost = \$300M), when they will earn an NPV (as of one year from now) of \$600M (not including the \$300M cost of finishing the project). If they do not receive the contract, then they can still finish the development project (cost = \$300M), but they could only receive \$200M for the project by selling it to some nongovernmental buyer (not including the \$300M cost of finishing the project). The riskfree rate is zero.

Problems

- (a) Draw the tree for Fuelco’s problem under the assumption that it starts the project.
 (b) Compute the NPV for the project. Should Fuelco start the project?

Solutions

(a) Based on the information given in the example, we draw Fuelco’s decision tree as shown in Exhibit 21-4.

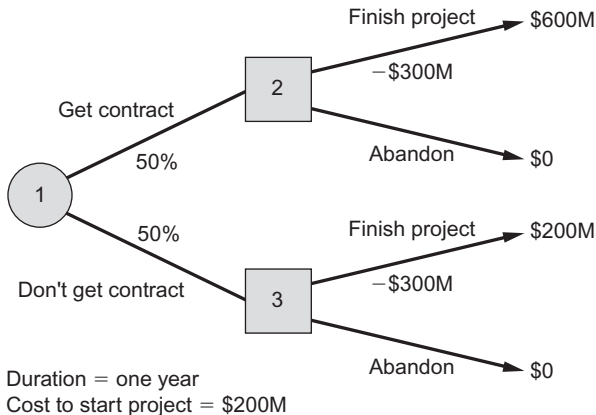
EXHIBIT 21-4**FUELCO’S DECISION TREE (PROJECT A)**

(b) To compute the NPV, we prune the tree at Nodes 2 and 3 by finding Fuelco’s optimal decision at each node. At Node 2, Fuelco would receive $600M - 300M = 300M$ for finishing the project, and 0 for abandoning it. Thus, the project should be finished if Node 2 is reached. At Node 3, Fuelco would receive $200M - 300M = -100M$ for finishing the project and 0

for abandoning it. Thus, the project should be abandoned if Node 3 is reached. To complete the solution, we compute the expected value of receiving the contract, discount this expected value by the riskfree rate (conveniently equal to 0), and subtract the cost to start the project (= \$200M):

$$\text{NPV of project} = (0.5 * 300 + 0.5 * 0) - 200 = -50M \quad (21.1)$$

Because the NPV is negative, Fuelco should not start the project. ■

In Example 21.2, we computed the NPV for Fuelco's project by using backward induction, the objective probabilities of success, and a riskfree discount rate. This riskfree discount rate was appropriate because we assumed a zero beta for the government's decision to award the contract. The decision problem is more complex when there is beta risk in the underlying project.

EXAMPLE 21.2

In addition to the government contract considered in Example 21.1, Fuelco is also considering a separate investment in fuel-cell technology designed to replace oil-based energy for some types of engines. (This corresponds to "Project B" as first discussed in Chapter 19.) By investing \$100M today to start the project, Fuelco would maintain the option to finish the project with a further investment (= \$200M) in one year. If oil prices are at least \$60 per barrel in one year (objective probability = 50%), then on completion of the project, Fuelco would have an NPV (as of one year from now) of \$1,000M (not including the \$200M cost of finishing the project). If oil prices are less than \$60 a barrel in one year (objective probability = 50%), then the project would not be economical for most applications and would have an NPV (one year from now) of \$300M (not including the \$200M cost of finishing the project). If Fuelco decides not to finish the project, then they can sell the technology to a competitor for \$200M, regardless of the price of oil. The beta for the project is unknown, but we do have some information about oil prices: the market price of a European binary call option (payoff = \$1) on oil with a strike price of \$60 per barrel and an expiration of 1 year is 25 cents.

Problems

- (a) Draw the tree for Fuelco's problem under the assumption that it starts the project.
- (b) Compute the NPV for the project. Should Fuelco start the project?

Solutions

- (a) We draw Fuelco's decision tree in Exhibit 21-5.
- (b) We solve backward by finding the optimal decisions at Nodes 2 and 3. In both cases, abandonment would result in a payoff of \$200M. At Node 2, Fuelco would receive $1,000M - 200M = 800M$ by finishing the project, so it should finish. At Node 3, Fuelco would receive $300M - 200M = 100M$ by finishing the project, so they should abandon and receive \$200M. Pruning the tree to reflect these decisions leaves us with Exhibit 21-6.

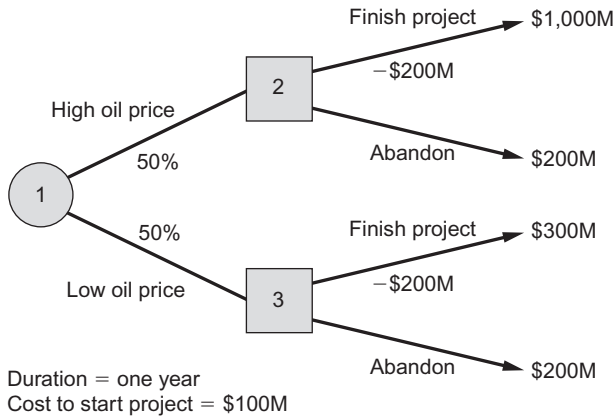
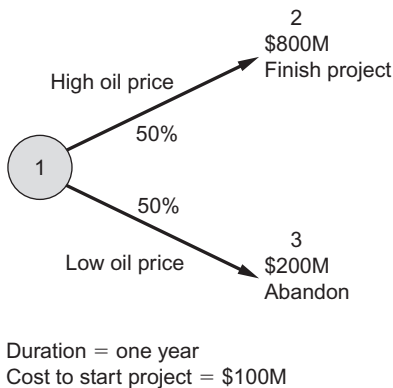
EXHIBIT 21-5**FUELCO'S DECISION TREE (PROJECT B)****EXHIBIT 21-6****FUELCO'S DECISION TREE (PROJECT B, PRUNED)**

At this point, it is easy to compute the expected future value of the project (in one year) as $0.5 * 800M + 0.5 * 200M = \$500M$, but what discount rate should we use to bring this value back to today? Before proceeding to the correct answer, let's consider two *incorrect* alternatives: (1) the riskfree rate and (2) the cost of capital for the binary option given in the problem.

If we use a riskfree rate of zero, then the NPV of the project would be $\$500M - \$100M = \$400M$. This would be correct if and only if there is no beta risk associated with the project. In Example 21.1, we were able to use the riskfree rate for exactly this reason: under the assumption that the government's decision had no beta risk, the appropriate discount rate was the riskfree rate. In Example 21.2, the value of the project is based on the price of oil. Do oil prices have beta risk? Lucky for us, we do not have to answer this question in a vacuum, as the example provides us with pricing information for a binary option on oil prices. This option pays \$1 if oil prices are high (50 percent chance), so it has an expected future value of 50 cents. With a price today of 25 cents, the option has an expected return of 100 percent. Clearly, this return is significantly higher than the riskfree rate of zero, so there must be some beta risk in oil prices. Thus, it would not be appropriate to use the riskfree rate to discount the returns to Project B. As our next alternative, we consider using the same discount rate of 100 percent that applies for the binary option. In this case, the NPV of the project would be $500M/(1 + 1) - 100M = \$150M$. Why is this wrong? *Because there is absolutely no reason to believe that Project B has the same beta risk as the binary option.* Although it is tempting to think that exposure to oil risk makes these two assets equivalent, this equivalence is incorrect. To see why this is true, imagine a leveraged version of the binary option where an investor combines 25 cents of capital with 75 cents of borrowed money to buy 4 options (= 25 cents * 4 = \$1 cost). In this case, the payoffs in the next period when oil prices are high would be \$4 (option payoff) - \$0.75 (loan payback) = \$3.25. When oil prices are low, the payoffs would be \$0 (option payoff) - \$0.75 (loan payback) = -\$0.75. Thus, the expected value of this leveraged option would be $0.50 * 3.25 + 0.50 * -0.75 = \1.25 , for a whopping expected return of 400 percent on the 25-cent investment. As in the original binary option, these payoffs *depend only on the oil price*. Note, however, that the expected returns are very different: 400 percent here versus 100 percent for the original option.

Because we cannot blindly apply the discount rate from the binary option, it is necessary to find another solution. Instead of computing a discount rate directly, we can adopt the replicating-portfolio approach first discussed in Chapter 13. Although the applications in Chapter 13 were for financial options, the same approach can also be applied for real options like Project B.

To build a replicating portfolio, we begin with two "known" assets: the binary call and a riskfree bond. The binary call is worth 25 cents today. In one year, if oil prices are high, the binary call is worth \$1, and if oil prices are low, the binary call is worth \$0. Because the riskfree rate is zero, the price of the bond today is the same as its value in both the high-price and low-price cases next year. For convenience, we set this value to be \$1 in all cases, but we could equally well choose any other value. (After the solution, we will demonstrate why this is so.) The asset to be priced is the value of Project B in one year, after the oil price is known. The value of the project is \$800M in the high-price state and \$200M in the low-price state.

Next, we build a portfolio of binary options and riskfree bonds that provides exactly the same payoff as Project B in both states. As in Chapter 13, we write an equation for each outcome, high or low, that takes the form

Project Value at Expiration (high price or low price)

$$= (\text{Shares of binary option}) * (\text{binary option value} = \$1 \text{ if high price, } \$0 \text{ if low price}) \\ + (\text{Shares of Bond}) * (\text{Bond Value} = \$1 \text{ in both cases}). \quad (21.2)$$

Denoting shares of the binary option as y and shares of the bond as z , we write the equations as

$$\text{Project B (high oil price)} = 800M = y + z, \quad (21.3)$$

and

$$\text{Project B (low oil price)} = 200M = z. \quad (21.4)$$

Equations (21.3) and (21.4) give us two equations and two unknowns (y and z), which we can solve to find that $y = 600M$ and $z = 200M$. To check this solution, we return to the logic of replication: if we purchase 600M binary options and 200M bonds, then we exactly replicate the payoffs to the call option. If oil prices are high, 600M binary options would be worth \$600, and 200M bonds would be worth \$200, for a total of \$800M, the same value as Project B. If oil prices are low, then the binary options are worthless, whereas the bonds are still worth \$200M, also the same value as Project B.

Now, to find the present value of owning Project B (not including the \$100M cost of investment today), we compute the cost of the replicating portfolio

$$\begin{aligned} \text{Value of Project B (not including today's 100M investment)} \\ = 600M * BC_0 + 200M * B_0 = 600M * 0.25 + 200M = \$350M \end{aligned} \quad (21.5)$$

This solution of \$350M represents the value of Project B once the initial \$100M investment has been made. The total NPV of the project should include this \$100M investment and is equal to $350M - 100M = 250M$. Nevertheless, the \$350M figure is still an important input into our analysis, as it represents the total valuation for the project after the investment. That is, after making the initial \$100M investment, if Fuelco wanted to sell all the rights to Project B (including the right to finish the project), they would use \$350M as their total valuation. One application of the total valuation is to compute the appropriate discount rate for Project B. Earlier we computed the expected value of Project B to be \$500M. Thus, if the total valuation (after the initial investment) is \$350M, then the expected return on Project B would be $500M/350M - 1 = 43$ percent. Recall that the expected return on the binary option was much higher (100 percent). Why the difference? Equation (21.5) gives us the answer. Project B is just like a \$350M portfolio with \$200M invested in the riskfree bond and \$150M invested in the binary option. This portfolio is less risky than a 100 percent allocation in the binary option, so the expected return is lower.

When setting up this problem, we used a bond price of \$1 and claimed that the exact price does not matter. With the solution in hand, we can check that claim. If, for example, we had chosen a bond price of \$2, then Equations (21.2) and (21.3) would have included a “ $2 * z$ ” term, the solution for z would have been 100M (instead of 200M), and the contribution of the bonds to the Project B value (the $200M * B_0$ term in Equation (21.5)) would have been $100M * \$2 = \$200M$, the same amount as we found when using \$1 for the bond price. In general, for any bond price B_0 , we would obtain a solution of $z = 200/B_0$, with a contribution to the Project B value of $B_0 * 200/B_0 = \$200M$. ■

21.4 RISK-NEUTRAL PROBABILITIES

In this section, we introduce an alternate solution method based on **risk-neutral probabilities**. Risk-neutral probabilities are from the world of make-believe. We “make believe” that all investors are completely risk-neutral, and then we ask, “In this make-believe world, what probabilities would lead to the same asset prices as we observe in the real world?” Once we obtain these probabilities, we then use them to price any asset in the economy. The key feature of a risk-neutral world is that beta does not matter: in a risk-neutral world, nobody cares about any kind of risk, and *all assets have an expected return equal to the riskfree rate*. An extra \$1 of consumption means the same thing to a poor person as it does to a rich person. In the banana-bird language of Chapter 4, we could say that each extra banana is worth the same no matter how many bananas have already been eaten. The banana-utility functions would be straight lines, with no curvature.

To make this concept more concrete, we return to Fuelco’s problem in Example 21.2. In that example, the objective probability of a high oil price was given as 50 percent. In the solution, we found that the expected return on a binary option—with a price of 25 cents and paying \$1 in the state with a high oil price—was 100 percent. In a risk-neutral world, the same 25-cent binary option still exists, but now the return on this option must be equal to the riskfree rate of zero. We can use this information to solve for the risk-neutral probabilities. Let p^t represent the risk-neutral probability of a high oil price. Then, the expected value of the option in one year in a risk-neutral world would be given by

$$\text{Expected value of the option at expiration} = p^t * \$1 + (1 - p^t) * \$0. \quad (21.6)$$

Because the price of the option is \$0.25, the expected return on the option would be

$$\text{Expected return on the option} = [p^t * \$1 + (1 - p^t) * \$0] / 0.25 - 1. \quad (21.7)$$

If we set this expected return to be equal to the riskfree rate ($= 0$), then we can solve for $p^t = 0.25$. Thus, in a risk-neutral world, the probability of a high oil price must be 25 percent. Now, the nice thing about this make-believe number is that we can use it to solve for option prices. For example, we can now write Fuelco’s tree as shown in Exhibit 21-7.

The only difference between Exhibits 21-6 and 21-7 is that the probabilities have shifted from 50/50 (in Exhibit 21-6) to 25/75 (in Exhibit 21-7). The key conceptual distinction is that in the “real world” of Exhibit 21-6, we did not know the proper discount rate, and we had to build a replicating portfolio to solve for the NPV of the project. In the “make-believe” risk-neutral world of Exhibit 21-7, we know that all assets must earn the riskfree rate of zero percent, so we can compute the NPV of Project B (not including the initial \$100M investment as)

$$\begin{aligned} \text{Value of Project B (not including today's 100M investment)} \\ = 800M * 0.25 + 200M * 0.75 = \$350M, \end{aligned} \quad (21.8)$$

which is exactly the same solution as found by replication.

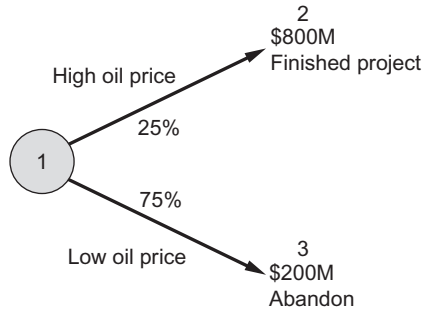
EXHIBIT 21-7**FUELCO'S DECISION TREE (PROJECT B, PRUNED) RISK-NEUTRAL WORLD**

Duration = one year
 Cost to start project = \$100M

This solution method is very powerful and is used in many finance applications. Nevertheless, many students find the whole topic to be somewhat magical and confusing. If you are confused, then you are not alone, as many of the smartest financial economists were also puzzled by these concepts at first. We can gain some conceptual understanding by reexamining the replicating-method solution of Example 21.2. In that example, we knew that the objective probability of a high oil price was 50 percent, but the solution never used this information. Indeed, the probabilities were completely extraneous. We have seen this phenomenon before: in Chapter 13, in our very first option pricing problem (Example 13.1), we solved for an option price without ever knowing the probabilities. Instead, we used only the market prices of the underlying assets—a stock in Example 13.1, and a binary option in Example 21.2. Probabilities are unnecessary because the options are derivative assets, and all the probability information is already embodied in the underlying assets.

Once we notice that the probabilities are not used, it gives us license to make up whatever probabilities that we want. We then use this freedom to create our make-believe risk-neutral world. We imagine that everyone is risk neutral; this implies that all assets earn the riskfree rate, and the riskfree return then implies some specific probabilities. Then, we have bootstrapped our way to alternative solution method, because if everyone is risk-neutral, then it is easy to price all assets as equal to their expected values, discounted by the riskfree rate.

In the Fuelco example, we were very lucky to have information about a binary call option. This information allowed us to easily compute the risk-neutral

probabilities. We are rarely so lucky. In the next example, we must figure out the risk-neutral probabilities using a more roundabout method.

EXAMPLE 21.3

Fuelco is considering a consumer application for their patented fuel-cell technology. (This corresponds to Project C from Chapter 19) They have already completed several R&D projects with this technology, so they have eliminated the technical risk for this new project. To begin producing and marketing to the consumer market would require a new investment of \$150M, to be paid in one year. The value of Project C depends on consumer demand. If demand is “high” (50 percent chance), then the value of the project would be \$600M (one year from now). If demand is “low” (50 percent chance), then the value of the project would be \$200M. If Fuelco chooses not to undertake the project, then they can still sell some of the related patents to another firm. If demand is “high” (50 percent chance), then the salvage value of these patents would be \$300M (one year from now). If demand is “low” (50 percent chance), then the salvage value of these patents would be \$100M. Selling the patents has no effect on any of Fuelco’s other projects. We will use the CAPM to estimate expected returns in this problem, where the expected market premium is 7 percent, and the riskfree rate is 5 percent.

Problems

- Draw Fuelco’s decision tree, where its first decision (Node 1) is whether to *invest* in the project immediately (at a cost of \$150M), or to *wait* one year before making an investment decision.
- Suppose that Fuelco chooses to *invest* at Node 1. Under this assumptions, solve for the NPV of the project as a function of its beta. Compute this value in the special cases of $\beta = 1$ and $\beta = 0$.
- Suppose that Fuelco chooses to *wait* at Node 1. Use replication methods to solve for the NPV of this decision.
- What is the value of the real option to *wait* at Node 1?
- Compute the risk-neutral probabilities of high demand and low demand under the same cases as in part (b). Use these risk-neutral probabilities to calculate the NPV of waiting. Verify that these NPVs are the same as found in part (c).

Solutions

- Fuelco’s decision tree is given in Exhibit 21-8.
- If Fuelco chooses to *invest* at Node 1, then there are no further decisions to make. If demand is high, then the value of the project would be \$600M. If demand is low, then the value of the project would be \$200M. To compute the present value of choosing *invest* at node 1, we discount the expected value ($= 0.5 * 600M + 0.5 * 200M = 400M$) by the appropriate discount rate. For now, we ignore the \$150M cost to add the capacity. We can compute the appropriate discount rate using the CAPM as

$$r = R_f + \beta(R_m - R_f) = 0.05 + \beta * 0.07. \quad (21.9)$$

EXHIBIT 21-8

FUELCO'S DECISION TREE

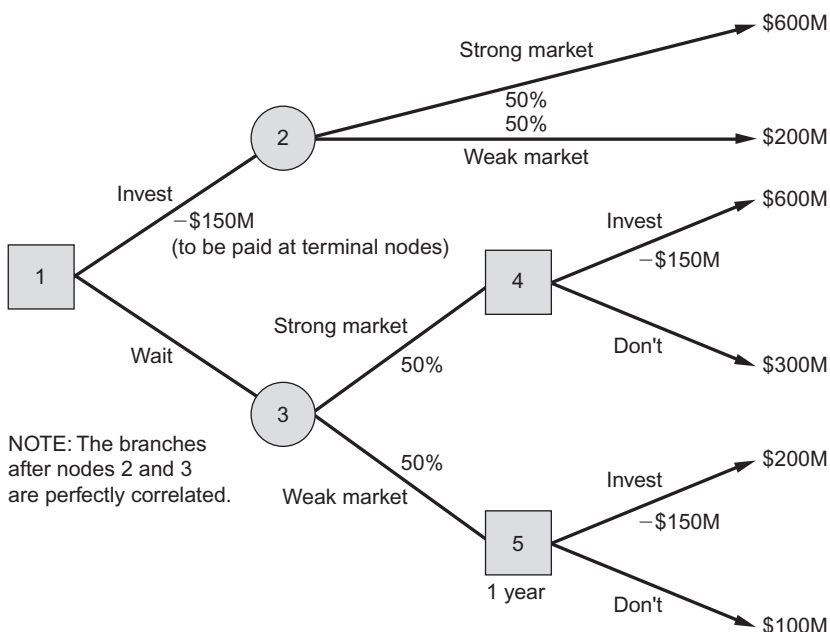

Thus, the present value of the project with commitment can be written as a function of β , $V(\beta)$, as

$$V(\beta) = 400 / (1.05 + \beta * 0.07). \quad (21.10)$$

Then, $V(0) = 400 / 1.05 = 381.0$, and $V(1) = 400 / 1.12 = 357.1$.

Note that these calculations represent a “present value” for the project, but not a “net present value”. If we want an NPV, we need to subtract the \$150M cost of adding capacity. Because this cost is committed to be paid in one year, we should discount it by the riskfree rate, so that the NPV of the project with commitment would be

$$\text{NPV}(\beta) = V(\beta) - 150 / 1.05. \quad (21.11)$$

(c) If Fuelco chooses to *wait* at Node 1, we must still take account of the option to invest in one year. If demand is strong, it would be optimal to invest ($600M - 150M > 300M$). If demand is weak, it would *not* be optimal to invest ($200M - 150M < 100M$). Thus, the pruned version of the tree is shown in Exhibit 21-9.

EXHIBIT 21-9

FUELCO'S DECISION TREE, PRUNED

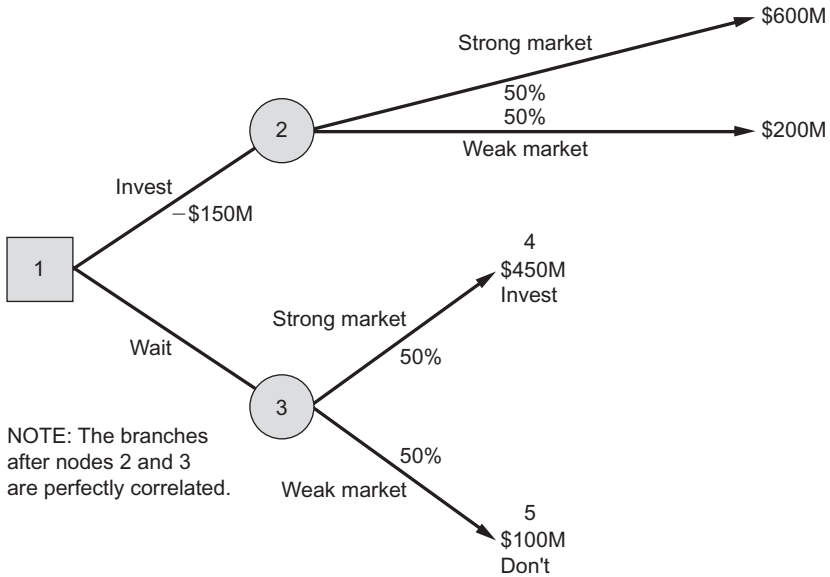

In part (b), we were able to solve for the present value of *invest* as a function of beta. To solve for the present value of *wait* is a harder problem, because we do not know the beta for the bottom half of the tree. We can solve for this NPV by building a replicating portfolio that combines the top half of the tree (with the present value solved in part (b)) and a riskfree bond. As we learned in Example 21.2, the exact expiration value of the bond is not important, so we arbitrarily set it to be equal to the cost of adding capacity = \$150M. Denoting “shares” of the added-capacity factory as y and shares of the bond as z , we write the replicating equations as

$$\text{Value of waiting (strong demand)} = 450\text{M} = 600y + 150z, \quad (21.12)$$

and

$$\text{Value of waiting (weak demand)} = 100\text{M} = 200y + 150z. \quad (21.13)$$

Equations (21.12) and (21.13) give us two equations and two unknowns, which we can solve for $y = 0.875$ and $z = -0.5$. The cost of this replicating portfolio will be the same as the NPV of the project with flexibility.

$$\begin{aligned} \text{NPV of project with flexibility} &= 0.875 * V(\beta) - 0.5 * B_0 \\ &= 0.875 * V(\beta) - 0.5 * 150/1.05, \end{aligned} \quad (21.14)$$

where $V(\beta)$ is given by Equation (21.10). For $\beta = 0$ we have $V(0) = 381.0$, and thus

$$\begin{aligned} \text{NPV of project with flexibility } (\beta = 0) \\ 0.875 * 381.0 - 0.5 * 150/1.05 = 261.9. \end{aligned} \tag{21.15}$$

For $\beta = 1$ we have

$$\begin{aligned} \text{NPV of project with flexibility } (\beta = 1) \\ 0.875 * 357.1 - 0.5 * 150/1.05 = 241.1. \end{aligned} \tag{21.16}$$

(d) To compute the option value of waiting, we compare the NPV of project with commitment to the NPV of project with flexibility. The difference between these NPVs is the value of the waiting “option”:

$$\begin{aligned} \text{Option value of waiting} = \text{NPV of project with flexibility} \\ - \text{NPV of project with commitment} \end{aligned} \tag{21.17}$$

The NPV of project with commitment is given by Equation (21.11). The NPV of project with flexibility is given by Equation (21.14). By substituting these equations in Equation (21.17), we obtain

$$\text{Option Value of Waiting } (\beta = 0) = \$261.9\text{M} - \$238.1\text{M} = \$23.8\text{M} \tag{21.18}$$

and

$$\text{Option Value of Waiting } (\beta = 1) = \$241.1\text{M} - \$214.3\text{M} = \$26.8\text{M}. \tag{21.19}$$

(e) Let p^t be the probability of strong demand in a risk-neutral world. Then, the present value of investing at node 1 ($= V^t$) in the risk-neutral world would be

$$V^t = [p^t * 600 + (1 - p^t) * 200]/1.05. \tag{21.20}$$

Now, to figure out the appropriate risk-neutral probabilities, we set V^t equal to $V(\beta)$. For example, when $\beta = 1$, we have $V(1) = 357.1$. In a risk-neutral world, p^t is set so that the value of the asset V^t would also be equal to 357.1:

$$V^t = [p^t * 600 + (1 - p^t) * 200]/1.05 = V(1) = 357.1 \rightarrow p^t = 0.4375. \tag{21.21}$$

This answer can be interpreted the following way: “If everyone was risk-neutral and the probability of strong demand was 43.75 percent, then the Project C would be worth \$357.1M today and would have an expected return of 5 percent.” Using this risk-neutral probability, we can rewrite Exhibit 21-9 as shown in Exhibit 21-10.

Now, we can solve for the expected terminal value of waiting as

$$\text{Expected terminal value} = 0.4375 * 450 + 0.5625 * 100 = 253.125. \tag{21.22}$$

In the risk-neutral world, all assets must earn the riskfree rate, so the NPV is

$$\text{NPV} = 253.125/1.05 = \$241.1\text{M}. \tag{21.23}$$

This is the same answer we found in part (c).

If we do the same steps for the case of $\beta = 0$, things turn out to be simpler. When $\beta = 0$, we have $V(0) = 381.0$. In a risk-neutral world, p^t is set so that the value of the asset V^t would also be equal to 380.1:

$$V^t = [p^t * 600 + (1 - p^t) * 200]/1.05 = V(0) = 380.1 \rightarrow p^t = 0.5. \tag{21.24}$$

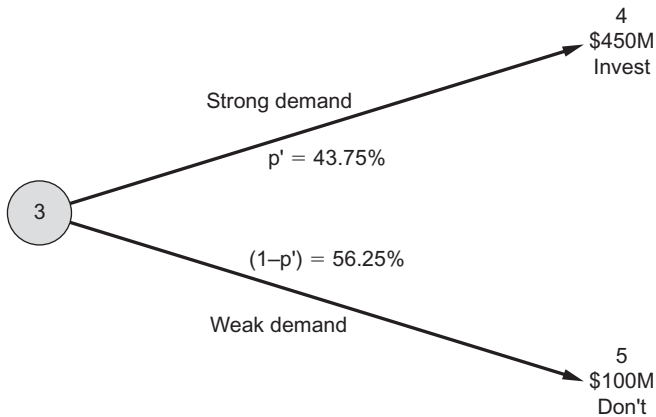
EXHIBIT 21-10**FUELCO'S EVENT TREE, AFTER NODE 3**

Thus, when $\beta = 0$, the risk-neutral probability is exactly the same as the objective probability. You should think about this result and convince yourself of its generality. When $\beta = 0$, the investment already earns the riskfree rate, so risk-neutral people would feel right at home. Because $p^1 = 0.5$, we can compute the NPV by using the event tree in Exhibit 21-10. The expected terminal value of waiting is

$$\text{Expected terminal value} = 0.5 * 450 + 0.5 * 100 = 275. \quad (21.25)$$

In the risk-neutral world, all assets must earn the riskfree rate, so the NPV is

$$\text{NPV} = 275/1.05 = \$261.9\text{M}. \quad (21.26)$$

This is the same answer we found in part (c) for the $\beta = 0$ case. ■

Please note that the betas and risk do matter here: our answers in the $\beta = 0$ and $\beta = 1$ cases are different. “Risk-neutral option pricing” just means that all the relevant information about betas is already built into the underlying asset prices, represented here by $V(\beta)$. Once we know the underlying asset prices, we can compute option values based on these assets without ever again using betas or expected returns.

As a special case, any time we have $\beta = 0$, we can just use objective probabilities and the riskfree rate. This shortcut comes in very handy when the only risks we face are (diversifiable) technical risks. We see an example of this shortcut in the next section.

21.5 DRUGCO, REVISITED

In this section, we take another look at the long Drugco example from the last chapter. Our new version is identical to Example 20.4 from the previous chapter, except that now we allow Drugco to abandon the Newdrug project even after it has been approved. The new text in this example (as compared to Example 20.4) is given in *italics*.

EXAMPLE 21.4

Drugco has just begun Phase III trials for Newdrug. Drugco expects Phase III trials to take two years and the FDA approval decision to take one year, so that the FDA decision is expected in three years. Phase II trials were promising, with a score of 40 on the standard medically recognized scale. (We will refer to this score as the “efficacy” of the drug.) Although the best alternative drug has an efficacy of 50, it is not helpful for all patients. Given the side effects of Newdrug and the risks and benefits of alternative treatments, Drugco believes that the FDA will approve Newdrug if the Phase III trials find an efficacy of 30 or greater. Based on the results of the Phase II trials, Drugco estimates that the efficacy results of Phase III will be $E \sim N(40, 20)$. (It is possible for efficacy to be negative because some drugs can make symptoms worse.) During the three years of Phase III trials, it is possible that the alternative treatments will also improve from their current efficacy of 50. Drugco estimates a final distribution for the alternative of $A \sim T(50, 100, 50)$. If Newdrug is approved by the FDA, then its market share will depend on the relative efficacy of Newdrug versus the best available treatment, that is,

$$\text{Newdrug market share} = E^2 / (E^2 + A^2). \quad (21.27)$$

Drugco estimates market size for Newdrug in the approval year (in thousands of doses) as $M \sim N(1,000, 100)$, with 6 percent annual growth going forward. Each dose yields a gross profit of \$1. *Following FDA approval, with all uncertainty about market size and efficacy known, Drugco can decide either to enter or not to enter the market. If they do not enter, then they can still sell the approved drug to a European company for $\$100M * E/(E + A)$.* If they do enter, then to stay in the market, Drugco must spend \$300M on marketing in the first year, with this sum increasing each year by 6 percent. Upon approval, Newdrug would have 10 years of patent life remaining. After the patent expiration, Drugco expects generic competition and other improved alternatives to greatly erode the value of Newdrug, so for simplicity we will assume that the continuing value would be zero after the patent expires. We assume that Newdrug faces only technical risk and that the riskless rate is 5 percent.

Problems

- (a) Draw the decision tree for the valuation of Newdrug.
- (b) Use Monte Carlo simulation to estimate the NPV of Newdrug.

Solutions

(a) The decision tree is given in Exhibit 21-11. This tree is identical to the event tree in Exhibit 20-18 (from Example 20.4), except for the additional decision nodes at the end of the

EXHIBIT 21-11

DECISION TREE FOR NEWDRUG

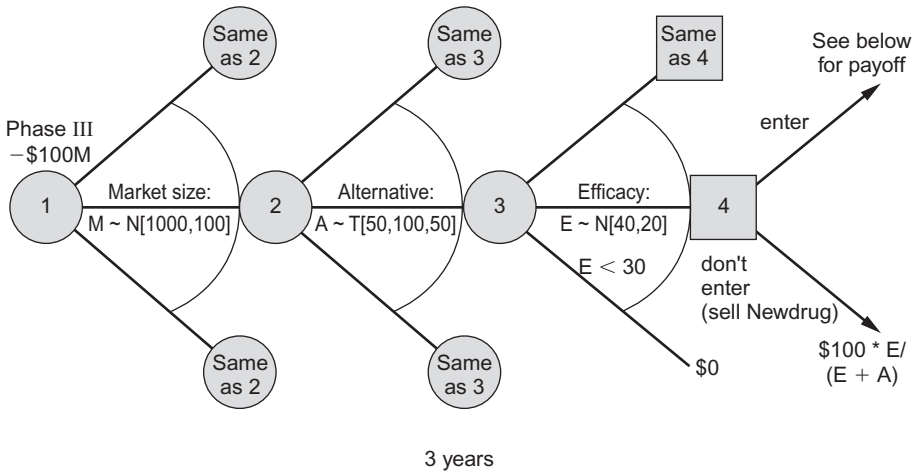

tree. At these decision nodes, Drugco must decide whether or not to enter the market. If Drugco enters the market, then they earn profits of $M * E^2 / (E^2 + A^2) * \$300M$ in the first year, with increases of 6 percent in each subsequent year up to year 10. If they choose not to enter the market, then Drugco can sell Newdrug for $\$100 * E / (E + A)$.

(b) Exhibit 21-12 provides a DCF model for calculating the NPV of Newdrug. This model is identical to Exhibit 20-19 (from Example 20.4) except for two additional cells used for the decision calculation. These additional cells are given in bold type. The first bolded cell is the discounted salvage value = $\$100 * E / [(E + A) * (1.05)^3]$. This cell is set to its expected value in the exhibit. The middle bolded cell represents the NPV with commitment. This cell is set to its average over 1M draws, \$285.9M, the same average as computed in Chapter 20, \$285.9M. The bottom bolded cell is the NPV with the option to abandon, computed in each draw by comparing the NPVs in the previous two shaded cells. After 1M draws, the average NPV was \$473.8M, a significant increase over the NPV with commitment. (This example is also discussed in Appendix C.)

At “enter” terminal nodes, the first year of profits = $M * E^2 / (E^2 + A^2) - \$300M$. For years 2 through 10, multiply profits in the previous year by 1.06, then sum all years and discount by 1.05 per year to get the NPV.

SUMMARY

Real options are finance-speak for “flexibility”; real options are created when costly decisions can be delayed. A commuter has a real option to switch from a congested highway to back roads; a fuel company has a real option to abandon its fuel-cell project if oil prices are low; a semiconductor company has a real option to expand its factory if demand is strong. A good analyst must learn to spot real options by keeping an open mind and developing a deep understanding of his business. Once spotted, real options can be represented in decision trees and valued using two main techniques. The first technique, replication, is useful for simple problems but unwieldy for complex problems. The second technique, risk-neutral valuation, relies on a key insight learned from replication: option-pricing formulas do not rely on risk aversion—if everyone is highly risk-averse we still get the same answer as the one we get if everyone is risk-neutral. With this insight, we pretend that we live in a make-believe world where everyone is risk-neutral, and then use the probabilities from this make-believe world to price options. This powerful method can be extended to complex examples by using binomial trees, a topic studied in the next chapter.

KEY TERMS

Real options	The option to expand	The option to switch
Decision trees	The option to extend	Risk-neutral probabilities
Decision nodes	The option to abandon	
The option to delay	The option to shrink	

EXERCISES

21.1 True, False, or Uncertain : In a risk-neutral world, all assets earn a zero rate of return.

21.2 True, False, or Uncertain : To use risk-neutral valuation, we assume that the underlying asset only faces technical risks.

21.3 Semico is considering whether to add capacity to their microchip fabrication plant. Adding capacity would cost \$600M, to be paid in one year. The value of an added-capacity plant depends on the demand for Semico’s chips. If demand is “high” (25 percent chance), then the value of the added-capacity plant would be \$1,600M (one year from now). If demand is “low” (75 percent chance), then the value of the added-capacity plant would be \$400M. If Semico chooses to keep the current capacity, then there is no incremental cost. If demand is “high” (25 percent chance), then the value of the current-capacity plant would be \$600M (one year from now). If demand is “low” (75 percent chance), then the value of the current-capacity plant would be \$400M. We will use the CAPM to estimate expected returns in this problem, where the expected market premium is 7 percent, and the riskfree rate is 5 percent.

- (a) Draw the decision tree for Semico's problem, where its first decision (node 1) is whether to commit today to add capacity at a cost of \$600M (to be paid in one year), or to wait one year until information about demand is revealed.
- (b) Suppose that Semico chooses to commit at node 1. Solve for the NPV of the project as a function of its beta. Compute this value in the special cases of $\beta = 1$ and $\beta = 0$.
- (c) Suppose that Semico chooses to wait at node 1. Use replication methods to solve for the NPV under the same cases as in part (b).
- (d) What is the value of the real option to wait?
- (e) Compute the risk-neutral probabilities of high demand and low demand under the same cases as in part (b). Use these risk-neutral probabilities to calculate the NPV of the project with flexibility. Verify that these NPVs are the same as found in part (c).

21.4 (This problem takes some work. For some guidance, see the last example in Appendix C, which solves a slightly easier version of the problem.) Begin with the same setup as in Example 21.4, except that now it is one year earlier, and Drugco is deciding whether to proceed with Phase II trials. Phase II trials will take one year and cost \$50M. Following the Phase II trials, Drugco will learn some information about efficacy, denoted as E^t , with $E^t \sim T[0, 80, 40]$, and about alternative efficacy denoted as $A^t \sim T[50, 80, 50]$. If, after learning this information, Drugco decides to go forward with Phase III trials, then everything is identical to Example 21.4, except that now the efficacy after Phase III trials is distributed as $E \sim N[E^t, 20]$, and alternative efficacy is distributed as $A \sim T[A^t, A^t + 50, A^t]$. All risks are technical risks, so all betas are zero and the appropriate discount rate is the riskfree rate of 5 percent.

- (a) For what values of E^t should Drugco continue on to Phase III trials?
- (b) What is the NPV of Newdrug at the beginning of Phase II trials?

BINOMIAL TREES

IN CHAPTER 21, we learned about risk-neutral probabilities and showed how to use these probabilities to solve one-step option-pricing problems. In this chapter, we extend the risk-neutral approach to multistep problems using **binomial trees**. In a binomial tree, we restrict all risk nodes to have only two branches, and we set the moves in those branches by a specific formula. In Section 22.1, we show how binomial trees can be used to approximate the Black-Scholes formula for European options. The advantage of binomial trees over analytical formulas is that the former can be used even when underlying assets have dividends or changes in volatility, and when the options allow for early exercise, have multiple strike prices on different dates, and have other special features. In Section 22.2, we value an option on Drugco with early exercise and multiple strike prices; in Section 22.3, we value a real option for Fuelco with early exercise and dividend payments. Indeed, the main concepts behind binomial trees allow analysts to handle virtually any complication that nature can throw at them. For this reason, binomial trees are the main tools used to analyze complex derivatives on Wall Street and complex real options on Main Street.

22.1 THE BLACK-SCHOLES EQUATION, REVISITED

Bigco stock currently trades for $\$S$ per share. Joe Trader holds a (European) call option with a strike price of $\$X$ and an expiration date of one year. The riskfree rate is r , and Bigco stock has an annualized volatility of σ . As is usual in option-pricing problems, we assume that these are continuously compounded returns. In Chapter 13, we learned how to value this call option using the Black-Scholes formula. In this chapter, we learn a new valuation technique based on **binomial trees**. The advantage of binomial trees is that they are flexible enough to handle many deviations from the Black-Scholes assumptions. However, before we introduce these deviations, we demonstrate how to build and solve binomial trees for standard European call options.

We begin by expressing Joe's call option as a decision tree (Exhibit 22-1).

EXHIBIT 22-1

CALL OPTION IN A DECISION TREE

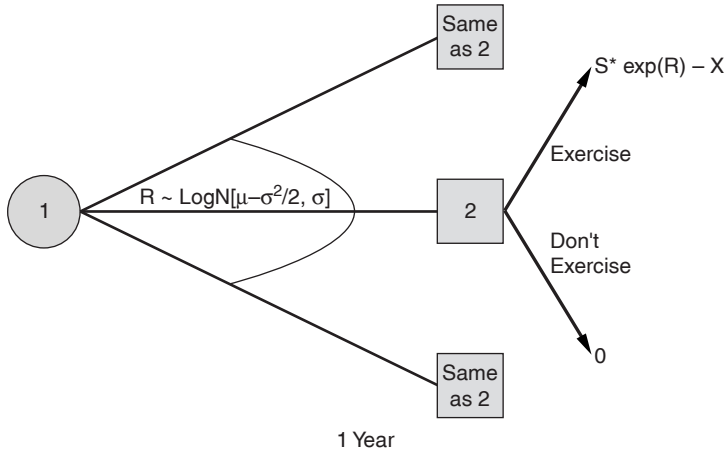

Node 1 is a risk node, and Node 2 is a decision node. At node 1, we draw a one-year stock return, R , from a log-normal distribution. This is a continuously compounded return, so the new stock price is then equal to $S * \exp(R)$. Working backward, we can see that Joe's optimal decision at Node 2 would be to exercise if $S * \exp(R)$ is greater than X , the exercise price. This gives us a terminal value of $\text{Max}[S * \exp(R), 0]$ at each possible terminal node.

The hard part about this problem is figuring out the correct discount rate to use for the terminal values. This problem is so hard that we didn't have a solution until Black and Scholes. When we first saw this solution in Chapter 13, we did not have all the tools and language to properly discuss all its implications. Now, we do have this language, so let's take another look. The Black-Scholes equation for a European call option is

$$C_0 = N(d_1)S_0 - N(d_2)Xe^{-rT}, \tag{22.1}$$

where $N(.)$ is the Normal distribution function and

$$d_1 = [\ln(S_0/X) + (r + \sigma^2/2)T]/(\sigma\sqrt{T}), \tag{22.2}$$

$$d_2 = [\ln(S_0/X) + (r - \sigma^2/2)T]/(\sigma\sqrt{T}) = d_1 - \sigma\sqrt{T}, \tag{22.3}$$

where T = years until the expiration date, σ = the annual volatility of returns, and r = the annual riskfree rate.

When this solution was first unveiled by its authors, the most surprising part was that *the expected return of the stock does not appear anywhere in the formula.*

Take a look again—there is no μ to be found. The only return that appears is the riskfree rate, r . What is happening here? It all comes back to the logic of replication. The Black-Scholes logic is the same as the replication logic that we used to value options in chapters 13 and 21. In replication, we match the option payoffs by constructing portfolios of riskfree bonds plus underlying risky assets. When we do this, *all information about probabilities, risk aversion, and expected returns is already embodied in the price of the underlying risky asset*. If expected returns change, then the stock price S_0 would change. Thus, option prices do depend on expected returns, but only indirectly through the price of the underlying asset.

The insight about expected returns led directly to the development of risk-neutral probabilities. The idea is that because expected returns and objective probabilities do not appear anywhere in the formula, then any set of probabilities that gives the same stock price should also imply the correct option price. We demonstrated applications of risk-neutral probabilities in Chapter 21. In those applications, the use of risk-neutral probabilities was limited to one-step trees. The real power of the risk-neutral insight is that it can be applied to multistep trees. In the most widely used applications, these trees have exactly two branches after every risk node: hence, they are called binomial trees. Exhibit 22-2 gives an example of a three-step binomial tree applied to Joe Trader’s example. In this exhibit, we break the one-year time period into three subperiods of four months each. Then, in each

EXHIBIT 22-2

A BINOMIAL TREE

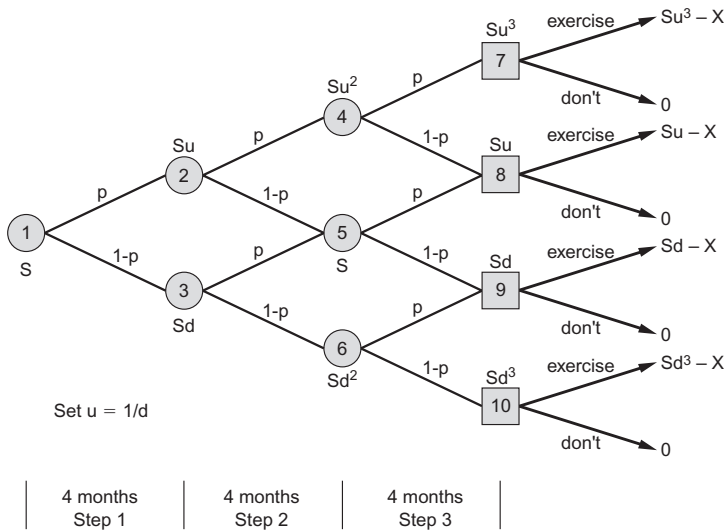

subperiod, we allow only two possible movements for the stock price, an “up” movement or a “down” movement.

In this tree, there are three different steps, each lasting four months. In each step, the stock price can either go up (with a return = u), or down (with a return = $d = 1/u$). Thus, after the first step (Node 1), we have two possible outcomes: a stock price of Su (Node 2) or a stock price of Sd (Node 3). From Node 2, once again the stock can go up or down. If the stock goes up, then the value is Su^2 (Node 4), and if it goes down, then the value is $Sdu = S$ (Node 5). The nice feature of binomial trees is that they **recombine**, so that the down movement from Node 2 leads to the same stock price as an up movement from Node 3. With our assumption that $u = 1/d$, this recombination occurs at the same price across each two time periods.

After all three risk steps, we reach the decision nodes of the tree. At each decision node, Joe should exercise if the stock is valued higher than the exercise price. In solving binomial trees, it is often helpful to construct two separate binomial trees: a **base tree** and an **option tree**. The base tree gives only the values of the underlying asset. We build a base tree forward at each node by multiplying the previous price by either u or d . Exhibit 22-3 gives the base tree for Joe’s option.

Once the base tree is constructed, we solve the option tree backward, starting with the decision nodes 7 through 10 at time = T . At each decision node, we set the value of the call option equal to the $\text{Max}(S_T - X, 0)$. Then, we compute the expected discounted value of the call option at each prior node as

$$C_{T-1} = [p * C_T \text{ (from up node)} + (1 - p)C_T \text{ (from down node)}] / R_{ft}, \quad (22.4)$$

EXHIBIT 22-3

BASE TREE

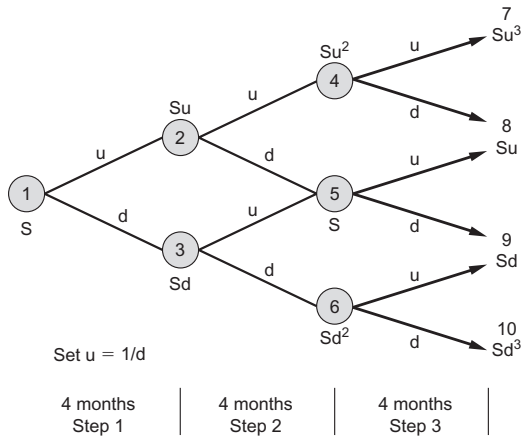

where R_{ft} is the appropriate riskfree discount rate for a time step length of t . Exhibit 22-4 illustrates this option tree.

To understand the option tree, we must begin at the decision nodes: 7 to 10. Each of the decision nodes, 7 to 10, contains an equation $C_M = \text{Max}(S_M - X, 0)$, where M is the node number and S_M is the terminal value from that node, as taken from the base tree. Next, we solve backward from these terminal nodes, taking the expected discounted value at each previous node. For example, consider Node 4. From Node 4, there will be a probability p of an up move to Node 7 and a probability $(1 - p)$ of a down move to Node 8. The expected value of these moves is $p * C_7 + (1 - p) * C_8$. Because this move takes t units of time, we must discount this expected value by R_{ft} , which yields a discounted value of $C_4 = (p * C_7 + (1 - p) * C_8) / R_{ft}$. (R_{ft} is known as the periodic **growth factor** of the tree.) We solve every risk node in the tree using exactly the same formula. When we finally reach C_1 , we get a solution for the starting value of the call option.

To transform the general solution of Exhibit 22-4 into a numerical solution, we apply the same risk-neutral approach as in Chapter 21. First, we need to derive the appropriate risk-neutral probabilities (p and $1 - p$) and the appropriate size

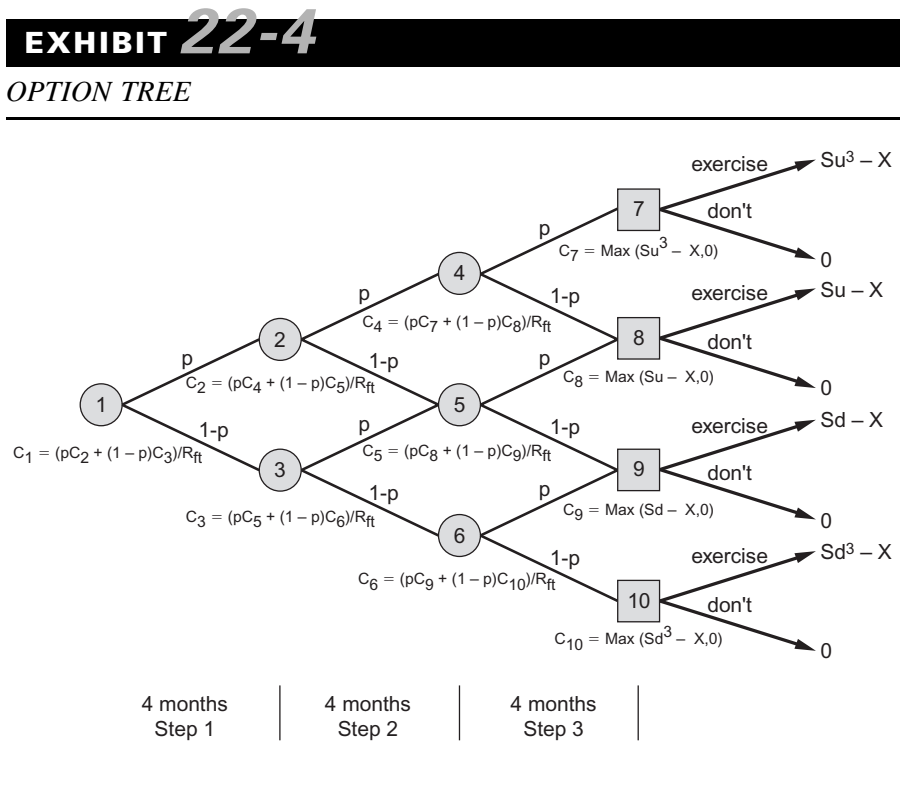

of the up and down movements (u and d). Thus, we have three unknown parameters, p , u , and d . To solve for these parameters, we need three equations. Just our luck, we have exactly three equations: one for the expected return (which must be equal to the riskfree rate, r , in our risk-neutral world), one for the volatility (which must be equal to σ , the “known” volatility of the stock), and a final equation with our assumption that $d = 1/u$.

We begin with the expected return equation. In Exhibit 22-2, the length of the whole tree is one year, and the length of each step on the tree is four months. For generality, we write the length of the whole tree as T and the length of each step as $t = T/N$, where N is the number of steps in the tree. Then, the risk-free return (= growth factor) over each step size t is $R_{ft} = \exp(r * t)$. Then, using the up and down movements in the tree, we can write this growth factor as

$$R_{ft} = \exp(r * t) = p * u + (1 - p) * d. \tag{22.5}$$

We next write an equation for the variance of returns. The variance of returns in each full year in the tree is σ^2 . Because variance is additive over time, the variance of returns for the whole tree must be $\sigma^2 * T$, and the variance of returns in each step in the tree must be $\sigma^2 * t$. In general, the formula for the variance of returns, R , can be written as

$$\text{Variance of returns, } R = \text{Expected value } [R^2] - (\text{Expected Value } [R])^2. \tag{22.6}$$

We now replace each term of Equation (22.6). As stated earlier, the left-hand side of the equation is equal to $\sigma^2 * t$. Next, the first term on the right-hand side can be written by multiplying the probability of each branch by the square of the return on each branch:

$$\text{Expected value } [R^2] = p * u^2 + (1 - p) * d^2. \tag{22.7}$$

Finally, we can write the second term on the right-hand side of Equation (22.6) by squaring the expected return from Equation (22.5)

$$(\text{Expected Value } [R])^2 = (p * u + (1 - p) * d)^2. \tag{22.8}$$

Next, we substitute Equations (22.7) and (22.8) into (22.6) to obtain

$$\text{Variance of returns, } R = \sigma^2 * t = p * u^2 + (1 - p) * d^2 - (p * u + (1 - p) * d)^2. \tag{22.9}$$

Now Equations (22.5) and (22.9) can be combined with our assumption that $d = 1/u$ to give us three equations and three unknowns. The hard part is over, and the rest is algebra. We can use these equations to solve for the unknown variables as

$$p = \frac{R_{ft} - d}{u - d} \tag{22.10}$$

where

$$\begin{aligned}R_{ft} &= \exp(r * t), \\ u &= \exp(\sigma\sqrt{t}), \text{ and} \\ d &= \exp(-\sigma\sqrt{t}).\end{aligned}\tag{22.11}$$

The solution in Equations (22.10) and (22.11) was first proposed by Cox, Ross, and Rubinstein (1979) and is known as the **CRR model**. The key assumption of the CRR model is that $d = 1/u$, which leads to a tree like Exhibit 22-2, with nodes that recombine at the same value as previous nodes on the same row of the tree. There are many other methods to build binomial trees, but we will exclusively use the CRR model in this chapter. Please see Hull (2005) for a discussion of other methods.

For concreteness, let's assume that for Joe Trader's Bigco option, we have a starting stock price of \$100, a strike price of \$50, a volatility $\sigma = 60$ percent, and a riskfree interest rate of $r = 5$ percent. With a three-step tree ($N = 3$) and a one-year option ($T = 1$), we have $t = 1/3$ (four months), so that

$$R_{ft} = \exp(r * t) = \exp(0.05 * 1/3) = 1.017\tag{22.12}$$

Now, we are ready to solve for u , d , and p as

$$u = \exp(\sigma\sqrt{t}) = \exp(0.6 * \sqrt{1/3}) = 1.414,\tag{22.13}$$

$$d = 1/u = 0.707, \text{ and}\tag{22.14}$$

$$p = \frac{R_{ft} - d}{u - d} = \frac{1.017 - 0.707}{1.414 - 0.707} = 0.438.\tag{22.15}$$

To solve for the option value, we use these numbers to build the base tree, and then we substitute the terminal values into the option tree and solve backward. Exhibits 22-5 and 22-6 give these two trees. Readers can compare the analytical formulas in Exhibits 22-3 and 22-4 with their numerical solutions in Exhibits 22-5 and 22-6 and see that the solutions are consistent. To make it easier to read these trees, we put the numerical values inside in the nodes, with the node label (#1, #2, etc.) given above the nodes.

Exhibit 22-6 gives a solution of \$54.91 for C_1 (the first entry in the tree). To check this solution, we can use the *European Call Option Calculator* of the VCV model, where these same inputs yield a solution of \$54.52. Because we know that the Black-Scholes solution in *European Call Calculator* is correct, the three-step tree is off by \$0.39, which is less than 1 percent of the true value. To achieve more precise estimates, we need to use a larger tree with shorter time steps. There are many commercial sources for binomial trees.¹ For this book, we use a relatively small tree, fixed at 60 steps, included in a spreadsheet named as *bintree.xls*. This spreadsheet contains three linked worksheets: *inputs*, *base-tree*, and *option-tree*.

¹For inexpensive versions, see the software included with Hull (2005) and Haug (1998).

EXHIBIT 22-5

JOE'S PROBLEM, BASE TREE

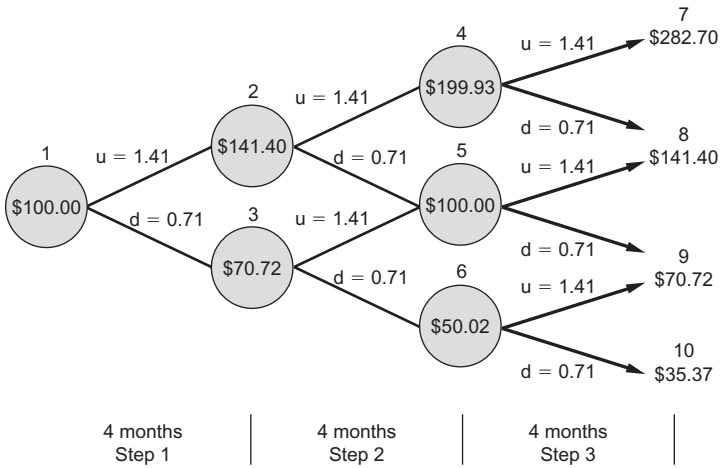
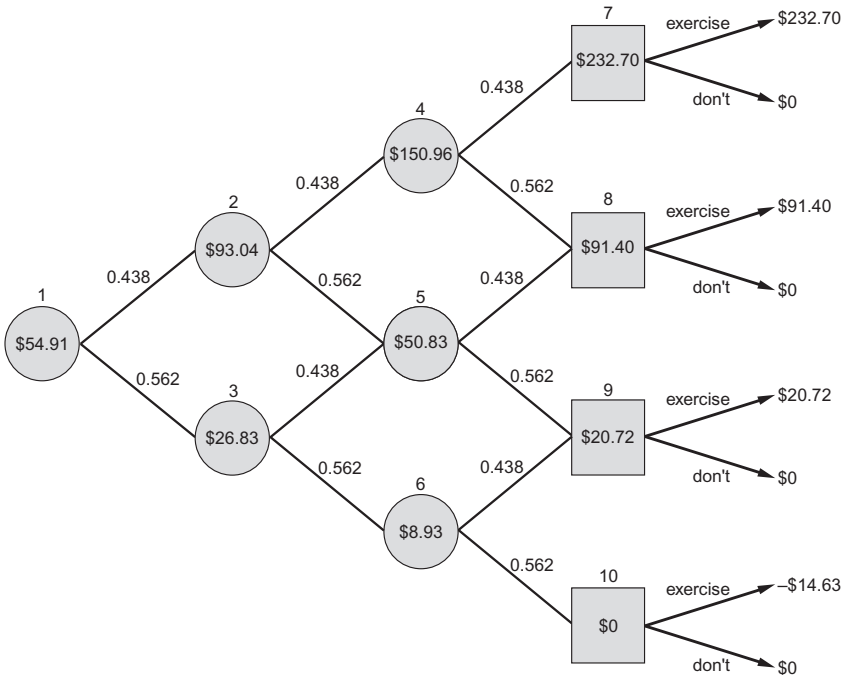

EXHIBIT 22-6

JOE'S PROBLEM, OPTION TREE



The *inputs* worksheet converts assumptions for interest rates, volatility, and time-to-expiration into outputs for t , u , d , and p , and then the *base-tree* worksheet builds a base tree from these outputs. The worksheet then solves a European call-option tree. To solve more complex options, we usually need to copy and alter the option-tree worksheet. We will describe how to do this in Examples 22.1 and 22.2.

Exhibit 22-7 shows a portion of the *inputs* sheet for Joe's problem.

In Exhibit 22-7, the inputs are given on the left, and the outputs are given on the right. With $N = 60$, the time steps are $1/60$ of a year, and the growth factor ($= \exp(r * t)$) is 1.000834 for each step. From this *inputs* sheet, we build a base tree with 60 steps in the *base-tree* worksheet. Of course, this whole worksheet is much too large to display on the printed page. At step 1 there is one risk node, at step 2 there are two risk nodes, . . . , all the way up to 60 risk nodes at step 60. Overall, there are $1 + 2 + 3 + \dots + 60 = 1,830$ risk nodes in the tree, followed by 61 terminal nodes after Step 60. The *option-tree* worksheet then takes the 61 terminal nodes from the *base-tree* worksheet, "decides" whether to exercise based on $\text{Max}(S_{60} - \$50, 0)$, and then solves backward exactly as in Exhibits 22-4 and 22-6. The answer of \$54.53 is displayed at the base of the *option-tree* worksheet. This answer is only \$0.01 away from the Black-Scholes solution found in *European Call Calculator*.

EXHIBIT 22-7

THE INPUTS SHEET FOR JOE'S PROBLEM

σ	60%	t	0.02
R	5%	R_{ft}	1.000834
S	100	u	1.080539
T	1	d	0.925464
X	50	p	0.486021

Note that the actual *option-tree* worksheet does not include branches after the decision nodes. Instead, the decision-node cells use the "max" function in Microsoft Excel. This is a space-saving device that is particularly useful when we alter the sheet to value American options, where every time period includes both a risk node and a decision node. American options will be discussed in Section 22.3.

22.2 MULTIPLE STRIKE PRICES AND EARLY EXERCISE

In the previous section, we showed that binomial trees can approximate the Black-Scholes solution. By itself, this approximation does not buy us anything because we already had an analytical solution for European options. The real payoff of binomial trees comes when we introduce complications that cannot be handled by Black-Scholes, or by any other analytical formula. In this section, we use binomial trees to value an option with two different strike prices on two different dates. The options analyzed in Example 22.1 are **warrants**. Warrants are call options that are issued by companies on their own stock; in contrast, regular call options are issued by some third party. Although there are some valuation differences between call options and warrants, we will sidestep these differences by making some subtle assumptions in the example, so that we can just treat these warrants as regular call options. Readers interested in exploring the differences between warrants and options are encouraged to look at Chapter 11 of Hull (2005).

EXAMPLE 22.1

Drugco is a publicly traded biotechnology company with several drugs in development, but no products on the market. To raise capital for the development of Newdrug, Drugco enters a strategic alliance with Bigco. In return for marketing rights for Newdrug, Bigco will pay for clinical trials and will give drugco up-front and milestone payments. Bigco also agrees to make an equity investment in Drugco, purchasing 10 million shares at the market price of \$10 per share and also receiving warrants to purchase an additional 10 million shares. (The market price of \$10 includes the market reaction to the Bigco alliance.) These warrants can either be exercised in exactly two years at a strike price of \$20 per share or in exactly five years, with a strike price of \$50 per share. Drugco does not pay dividends and has no plans (or cash) to do so for at least the next five years. The expected volatility of Drugco stock is 60 percent per year.

Problem What is the value of Bigco's warrants?

Solution If not for the step up in the exercise price, this would be a straightforward option pricing problem and could be solved by the Black-Scholes equation. With the step up, we need to use a binomial tree to solve the problem. We start by building the base tree, which is invariant to strike-price complications. If we use *bintree.xls*, then we have a 60-step tree. With $T = 5$ years, then $t = 5/60 = 1/12 = 0.833 =$ one month. Exhibit 22-8 shows the other inputs for the tree.

From these inputs, the *base-tree* worksheet builds values for the stock. Now, the tricky part—how do we build and solve the option tree? Option trees are always solved backward. We start at the exercise date, after all 60 steps of the tree. At that point, the exercise decision is the “normal” one: exercise if and only if the stock price is greater than the exercise price (= \$50). Because this is the standard approach in the option tree, we do not need to make any

EXHIBIT 22-8

INPUTS TREE FOR BIGCO'S PROBLEM

σ	60%	T	0.08
r	5%	R_{ft}	1.004175
S	10	U	1.18911
T	5	D	0.840965
X	50	P	0.4688

changes. Similarly, to compute the discounted value at steps 59, 58, ..., 25, we can just follow the same procedure as in earlier examples. The only complication occurs at Step 24, which is after two years of the tree. At this step, Bigco has another choice to make: it can either exercise the option, and receive an immediate payoff of $S_{24} - \$20$, or let the first exercise date expire and receive the present discount value of the option that would ordinarily be calculated for that node of the tree.

Exhibit 22-9 gives portions of Steps 24 and 25 for various trees associated with Bigco's two-strike problem. Column (A) gives the row number, so that we can refer to cells in the tree as we would in a spreadsheet. Column (B) shows all possible payoffs in the upper half of the base tree at Step 24: these payoffs are copied from the *base-tree* worksheet. The next four columns, (C) through (F), show Steps 24 and 25 from two different versions of the option-tree worksheet. The first version is the standard *option-tree* worksheet included in the *bin-tree* file. This sheet is shown in columns (C) and (D), and it is a standard European call without allowing for the possibility of an early exercise at Step 24. The second version, named as *early-tree* and shown in columns (E) and (F), modifies the first version to allow for early exercise.

To build the *early-tree* worksheet, we start with a copy of *option-tree*. In *early-tree*, all columns from Step 25 to Step 60 are identical to the corresponding columns in *option-tree*. This is illustrated in part by column (F) in the exhibit, which is identical to column (D). Next, we edit the cells in Step 24 of column (E) to reflect the possibility of early exercise at a strike of \$20. For example, to compute the entry for cell E2, we write

$$E2 = \text{Max} (B2 - \$20, C2). \quad (22.16)$$

Equation (22.16) states that, at Step 24, Bigco can either choose to exercise and receive the stock value (cell B2) minus the strike price (\$20), or it can choose to hold onto the option and receive the expected discounted value of a one-strike option (cell C2). We then repeat this same formula for all cells in column (E). These are the only changes that are needed to solve the two-strike tree. By examining the exhibit, we can see that Bigco would choose to exercise early in all cases at row 20 and above. If we then look at the solution in Step 1 of the tree (not shown in the exhibit), we get an option value of \$2.15. In contrast, the one-strike tree yields an option value of \$1.87. Thus, the possibility of early exercise

EXHIBIT 22-9*EXCERPTS FROM TREES FOR EARLY-STRIKE DECISION*

(A)	(B) Base-tree	(C) Option-tree	(D)	(E) Early-tree	(F)
	Step 24	Step 24	Step 25	Step 24	Step 25
1			716.44		716.44
2	638.75	595.92		618.75	
3			494.25		494.25
4	451.74	409.21		431.74	
5			337.38		337.38
6	319.48	277.55		299.48	
7			226.93		226.93
8	225.94	185.09		205.94	
9			149.61		149.61
10	159.79	120.66		139.79	
11			96.06		96.06
12	113.01	76.38		93.01	
13			59.62		59.62
14	79.92	46.60		59.92	
15			35.48		35.48
16	56.52	27.19		36.52	
17			20.08		20.08
18	39.97	15.04		19.97	
19			10.71		10.71
20	28.27	7.83		8.27	
21			5.35		5.35
22	19.99	3.81		3.81	
23			2.47		2.47
24	14.14	1.71		1.71	
25			1.05		1.05
26	10.00	0.71		0.71	
27			0.41		0.41

at \$20 gives an incremental value of $\$2.15 - \$1.87 = \$0.28$ per option, making Bigco's 10M options worth \$2.8M. ■

22.3 DIVIDENDS

Many public companies pay periodic dividends on common stock, and these dividends can complicate the valuation of call options. For non-dividend-paying

stocks, a diversified investor that holds American call options should never exercise early. The logic for waiting until the very end—first discussed in Chapter 13—is that the option holder can earn the interest on the strike price without giving up anything. If the stock pays dividends, then waiting to exercise until the end may no longer be optimal. Unfortunately, analytical solutions are usually not possible for these problems. Thus, most analysts build binomial trees to compute numerical solutions for American options on dividend-paying stocks.

Consider Joe’s three-step problem, as first illustrated in Exhibit 22-2. Now, let’s add a dividend in the second-to-last period (eight months into the year) that is equal to 10 percent of the stock value. Now, if Joe decides to exercise after eight months, he would receive the whole value of the stock (including the 10 percent dividend). If, instead, he decides to wait until the full year is over, then the 10 percent dividend gets paid out after eight months, and the stock price falls by 10 percent before making an up or down move in the last period. Exhibit 22-10 illustrates the new base tree under this assumption.

EXHIBIT 22-10
JOE’S PROBLEM, BASE TREE, WITH DIVIDENDS

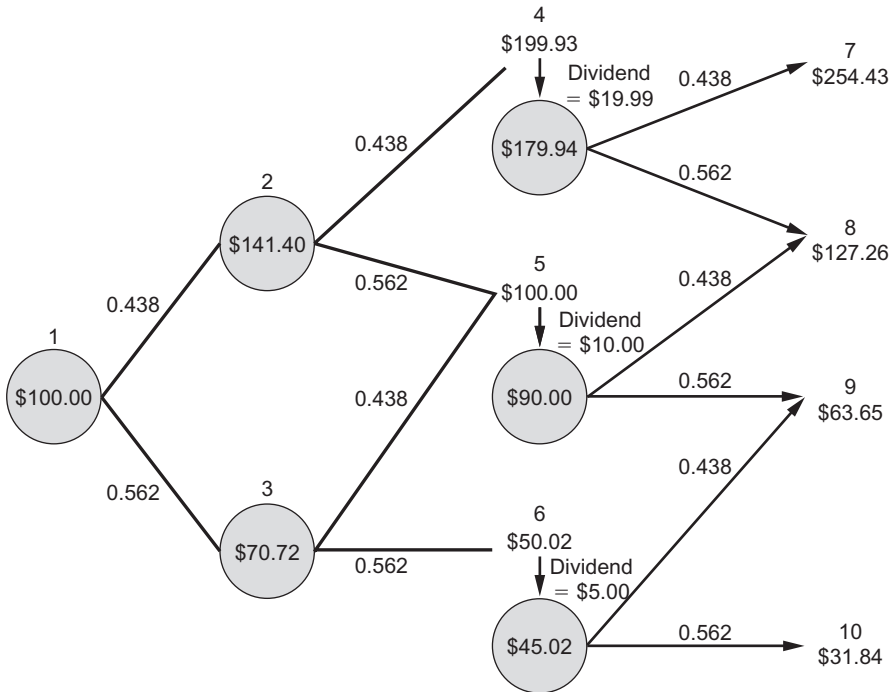

In Exhibit 22-11, we show the option tree, an analogue to Exhibit 22-6 from the no-dividend case. In this tree, we divided nodes 4, 5, and 6 into two nodes each. For example, Node 4 is now a decision node for early exercise, and Node 4A is a risk node that is only relevant if Joe decides to wait at Node 4. Although these nodes would not be divided in the *bintree* spreadsheet, it is useful to divide them in the exhibit to make comparisons to decision trees.

As always, we solve the option tree backward. In nodes 7 through 10, Joe needs only to compare payoffs at the terminal nodes. If he chooses to exercise, then the option would be worth $S_T - \$50$, where S_T is taken from the corresponding terminal node of the base tree; if he chooses not to exercise, then the option is worth \$0. We then assign each terminal node (7 though 10) with the maximum of $S_T - \$50$ and \$0.

Continuing our backward march through the tree, we next come to risk nodes 4A, 5A, and 6A. Joe will only reach these nodes if he chooses to wait at decision

EXHIBIT 22-11
JOE'S PROBLEM, OPTION TREE, WITH DIVIDENDS

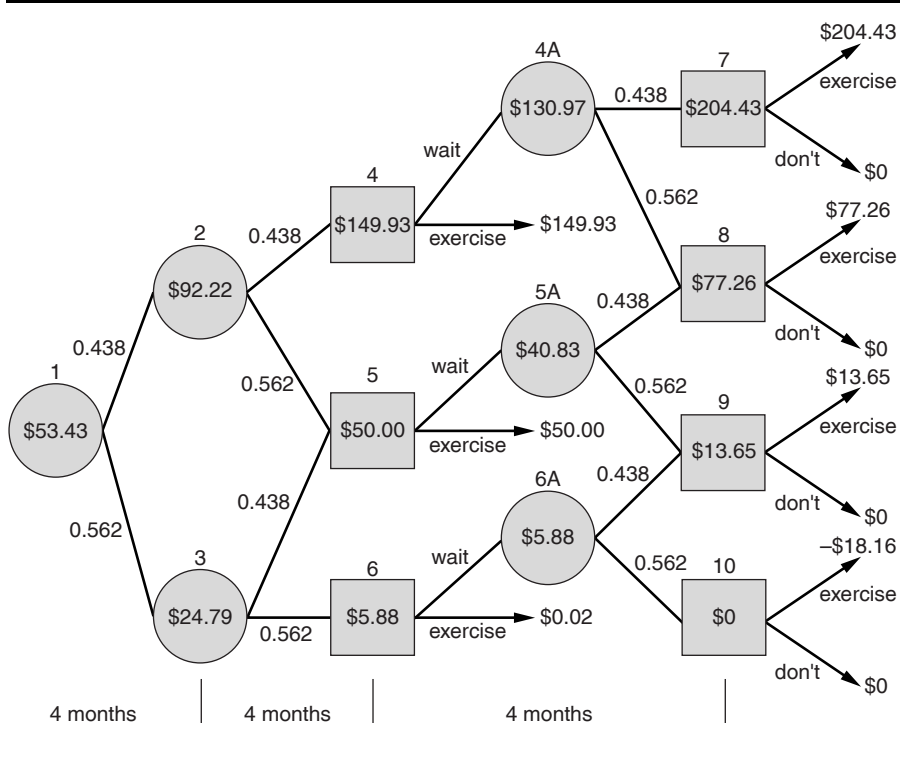

Nodes 4, 5, and 6, respectively. To compute the expected value at these risk nodes, we take $0.438 * \text{the up branch} + 0.562 * \text{the down branch}$, discounted by $R_{ft} = 1.017$ (from Equation (22.12)). For example, at Node 4A we have²

$$\text{Value at Node 4A} = (0.438 * \$204.43 + 0.562 * \$77.26)/1.017 \approx \$130.97 \quad (22.17)$$

Now, at Node 4, Joe can either choose to wait (and receive a discounted expected value of \$130.97) or exercise immediately. If he exercises immediately, then he will get the stock before it pays the dividend. This is the key factor driving the possibility of early exercise. Thus, with early exercise he would get the full value of the stock before the dividend, minus the strike price of \$50: $\$199.93 - \$50 = \$149.93$. The decision at Node 4 is to take the maximum of the waiting value (\$130.97) and the early exercise value (\$149.93). We then type this maximum into Node 4 in the tree.

With similar comparisons, we can see that early exercise is optimal at Nodes 4 and 5, but not at Node 6. We then back the expected values up through risk nodes 2 and 3, and finally back to the base of the tree at Node 1. This procedure yields an option value of \$53.43 at the first node.

In our next example, we generalize the dividend problem to our full 60-step tree and model a real option for a company to invest in a profitable project. If the company invests right away, then it immediately gets some positive cash flows and a positive overall NPV. If it waits, however, then it may be able to avoid investing for some cases where the project goes bad. There is a cost to waiting because the company must forego the positive cash flows that would have been generated during this waiting period. These positive cash flows are modeled as “dividends”. One nice feature of real-option problems is that it is reasonable to model these dividends as a continuous payment of some fraction of the project value. By modeling dividends as a continuous payment, the construction of the binomial tree is simplified. We demonstrate this technique in the following example.

EXAMPLE 22.2

Fuelco is considering a consumer application for their patented fuel-cell technology. (This corresponds to Project C from Chapter 19 and is similar to Example 21.3 from the previous chapter.) They have already completed several R&D projects with this technology, so they have eliminated the technical risk for this new project. To begin producing and marketing to the consumer market would require a new investment of \$200M. At the present time, Fuelco estimates that the completed project would have a present value of \$400M (i.e., if Fuelco spent \$200M to initiate the project, they believe they could spin off the initiated project for \$400M). Fuelco can delay starting the project for up to five years, during which time they expect this value of the project to fluctuate, with an annual volatility of 90 percent. Once initiated, the project is expected to generate annual cash flows equal to 10 percent of its

²We use the \approx operator in Equation (22.18) because of a rounding error.

value. Thus, if Fuelco delays the project, they will forego these cash flows. After five years, some important Fuelco patents will expire, and they will no longer have the option to profitably enter this new market. If Fuelco does not enter the market, then Project C has no salvage value.

Problem What is the NPV of Project C?

Solution The problem here is to value Fuelco's real option to invest. If Fuelco invests right away, then it would cost \$200M and provide a present value of \$400M, for a total NPV of \$200M. So why would Fuelco ever decide to wait? Because it is possible that the project will have terrible performance in the next few years, in which case Fuelco will be happy that they held on to the \$200M. There is a cost to such patience because Fuelco will have to forego some positive cash flows during this waiting period. Because Fuelco can make this decision at any time, there are an infinity of possible decision nodes. To get an approximate answer to the problem, we assume that decisions to invest can only be made once per month, and we adopt a binomial-tree framework with only two possible branches (up and down) from each risk node. Even with this assumption, over five years there are still 60 possible dates in which to invest. Exhibit 22-12 shows the first part of the decision tree.

EXHIBIT 22-12

FUELCO'S PROBLEM, PROJECT C

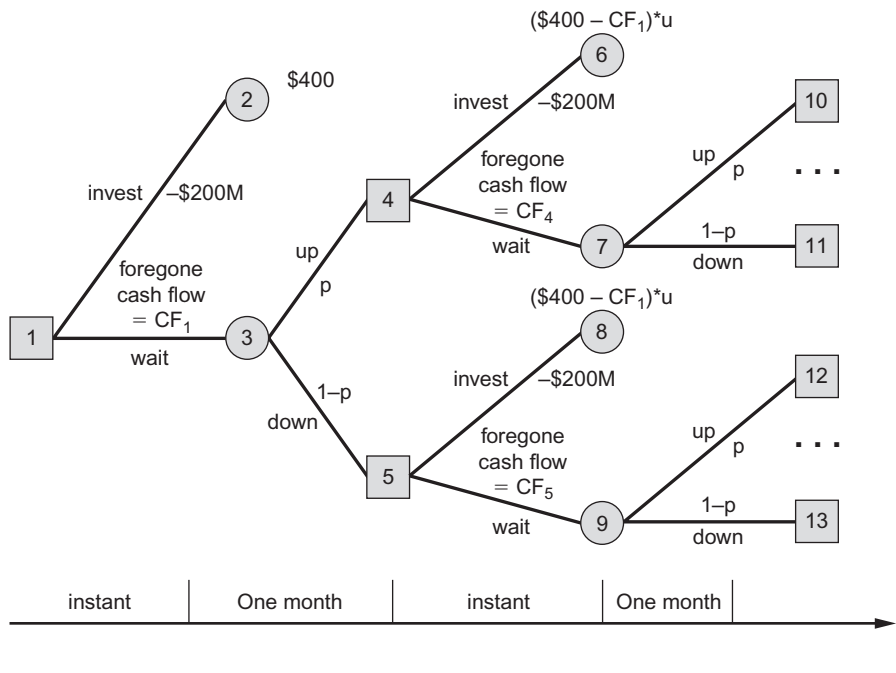

The first decision occurs at Node 1. As we already discussed, if Fuelco chooses to invest immediately, then they spend \$200M for a project with a value of \$400M, as shown at terminal Node 2. If Fuelco chooses to wait, then some project risk evolves during the first month (Node 3), during which time Fuelco does not receive any of the project cash flows. We write these cash flows as CF_1 , which means “cash flows forgone by waiting at Node 1”. At Node 3, an up move results in a project value of $(\$400 - CF_1) * u$ and a down move leads to a project value of $(\$400 - CF_1) * d$. At the end of this first month, Fuelco again makes a decision about whether to invest (Nodes 4 and 5). This process continues for 59 more months. To solve the tree, we work backward from Step 60.

Clearly, this decision tree grows very large by Step 60. To make the problem more manageable, we follow the same procedure as in earlier problems and break the decision tree into two binomial trees: a base tree and an option tree. Exhibit 22-13 gives the *inputs* sheet for these trees. This exhibit includes a row for the dividend yield (y) and for the *dividend factor*, $R_{yt} = \exp(yt)$, which is an analogue to the growth factor.

EXHIBIT 22-13

INPUTS SHEET FOR FUELCO'S PROBLEM

σ	90%	t	0.08
r	5%	R_{ft}	1.004175
S	400	u	1.296681
T	5	d	0.7712
X	200	p	0.443357
y	10%	R_{yt}	1.008368

Because the annual dividend yield (10%) is greater than the riskfree interest rate (5%), Fuelco may indeed want to exercise early at several points in the option tree. As in the previous example, we will need to alter the option-tree worksheet to allow for early exercise. We refer to this new worksheet as *am-tree*. Exhibit 22-14 gives excerpts from the last few steps of the binomial trees. The first half of the tree gives an excerpt from the *base-tree* worksheet, and the second half of the tree gives an excerpt from the *am-tree* worksheet. All excerpts are from the middle of the tree at Steps 58, 59, and 60. To build the base tree, we multiply cells by the up (or down) branch and divide by the dividend factor. (The values of these inputs are given in Exhibit 22-13.) For example, to compute cell C1 we use the following formula:

$$C1 = B2 * u/R_{yt} = \$697.40 * 1.296681/1.008368 = \$896.80. \quad (22.18)$$

In the *base-tree* portion of Exhibit 22-14, notice that the rows of the tree do not have a constant value (e.g., in cell B4 the value of the project is \$414.78, whereas in cell D4 the value is \$407.92). This “loss” of value occurs because of the dividends; in binomial trees without dividends (like Exhibit 22-5), the tree recombines at the same value.

The *am-tree* tree is solved backward, starting with Step 60. The entries in column G are the value of the real option in the last period. We calculate these values with the standard maximum formulas. For example, the value of cell G2 is

$$G2 = \text{Max} (D2 - \$200, \$0). \quad (22.19)$$

EXHIBIT 22-14**EXCERPTS FROM TREES FOR FUELCO'S PROBLEM**

(A)	Base-tree			Am-tree		
	(B)	(C) STEP	(D)	(E)	(F) STEP	(G)
ROW	58	59	60	58	59	60
1		\$896.80			\$696.80	
2	\$697.40		\$685.87	\$497.40		\$485.87
3		\$533.37			\$333.37	
4	\$414.78		\$407.92	\$214.78		\$207.92
5		\$317.22			\$117.22	
6	\$246.69		\$242.61	\$62.18		\$42.61
7		\$188.67			\$18.81	
8	\$146.72		\$144.29	\$8.31		\$0.00

Next, at Step 59 Fuelco must decide whether to exercise immediately (and receive the value in the base tree minus \$200) or to wait (and receive the expected discounted value of the up and down branches.) The formula for cell F3 is

$$F3 = \text{Max} ((p * G2 + (1 - p) * G4) / R_{ft}, C3 - \$200) = \text{Max} (\$329.78, \$333.37) = \$333.37. \quad (22.20)$$

Thus, Fuelco would choose early exercise in cell F3. This should not be surprising: because Fuelco knows it will exercise in both successor cells (G2 and G4), it will benefit by exercising early and taking the dividend (10 percent annualized), even at the cost of losing the time value of the strike price (5 percent annualized).

The computer uses the same formulas to solve the tree all the way back to its first cell. The *am-tree* worksheet values the real option at \$249.66M. Thus, Project C is worth almost \$50M more than the \$200M value from immediate investment. ■

SUMMARY

In this chapter we learned about binomial trees, a flexible and powerful type of decision tree. In binomial trees, each risk node is followed by two branches: an “up” branch with probability = p , and a down branch with probability = $1 - p$. In the Cox-Ross-Rubenstein (CRR) model, the size of the down move is set equal to the reciprocal of the up move: $d = 1/u$. Binomial trees built with the CRR model have several nice features, and modified versions of the trees can be used to obtain solutions for many complex option features. In this chapter, we solved examples for options with multiple strike prices on different dates, and for real options on positive cash-flow projects.

KEY TERMS

Binomial trees	Growth factor	<i>Dividend factor</i>
Recombine	CRR model	
Base tree, option tree	Warrants	

REFERENCES

- Cox, John C., Steven A. Ross, and Mark Rubinstein, 1979, "Option Pricing: A Simplified Approach", *Journal of Financial Economics* 7, 229–263.
- Haug, Espen G., 1997, *Option Pricing Formulas*, McGraw-Hill, New York.
- Hull, John C., 2005, *Option, Futures, and Other Derivatives*, 6th Edition, Prentice Hall, Upper Saddle River, NJ.

EXERCISES

22.1 True, False, or Uncertain : Assume that all Black-Scholes assumptions hold. Let C be the value of a call option with strike price X on underlying stock S and exercise date T in a world with riskfree interest rate r . This underlying stock has an expected return of μ and an expected volatility of σ . Now, assume that everyone in the world suddenly becomes more risk averse, and the new expected return on the underlying stock is μ^f , where $\mu^f > \mu$. There is no change in σ or r . After this change, the value of C will go down.

22.2 Begin with the same setup as Example 22.1: Bigco's investment in Drugco for equity plus warrants. Now, in addition to the strike price of \$20 after two years and \$50 after five years, assume that the warrants can also be exercised after three years at a strike of \$30 or after four years at a strike of \$40. Assume everything else from the problem is unchanged. Use *binrtree* to solve for the value of Bigco's warrants.

22.3 Begin with the same setup as Example 22.2: Fuelco's investment in Project C. Now, in addition to the assumptions made in the example, we add an additional possibility: Fuelco has an option to sell the patents that underlie Project C for \$100M in exactly three years. They can only sell these patents if they have not yet invested the required \$200M in the project. Selling the patents has no effect on any of Fuelco's other projects. How does this new option affect the NPV of Project C?

22.4 Begin with the same setup as Example 22.2: Fuelco's investment in Project C. Now, suppose we believe that the volatility of the project is really 120 percent. With this high volatility, a 60-step tree may not be sufficiently precise. Edit the *binrtree* spreadsheet to build a 100-step tree, and then compare the option values for $N = 60$ and $N = 100$. How different are these values? Do you think it is necessary to build an even larger tree? (This exercise will be time consuming. It is good practice if you want to learn how to build your own trees.)

GAME THEORY

R**&D DECISIONS** are rarely made in isolation from competition. So far, all our models have ignored the strategic aspects of competition, with potential competitors modeled as random events that might reduce profits. In a more realistic model, a company must consider a variety of different strategies in response to competition, while simultaneously recognizing that competitors will also be making similar calculations. The interaction among different decision makers, all of whom may have different objectives, is the domain of game theory. Despite its fun-sounding name, game theory has always been concerned with serious matters, with nuclear deterrence among its earliest topics.

In this chapter, we give an introduction to game theory and discuss several applications to R&D investing. Although the subject of game theory is vast enough to justify years of study, the key concepts are accessible to all interested amateurs. In Section 23.1, we provide a core set of terms and definitions and set up a few canonical games, beginning with the **prisoner's dilemma**. In Section 23.2, we “solve” these canonical games using the powerful concept of the Nash Equilibrium. In Section 23.3, we introduce a more complex set of games and refine the Nash equilibrium concept to allow for more robust solutions. In Section 23.4, we show how the game-theory analysis of this chapter can provide fresh insights into real-option investment problems.

23.1 WHAT IS GAME THEORY?

We begin with the most famous example in all of game theory: the prisoner's dilemma. Two people, Al and Bob, have been arrested by the police and are being held in separate rooms. In each room an interrogator explains to the prisoner that he should make things easy for himself and “confess” to the crime. (Whether Al and Bob are actually guilty is immaterial to the problem.) Each prisoner can choose whether or not to confess. If both prisoners confess, then they will both go to jail for eight years. If neither prisoner confesses, then the prosecutors will not be able to

convict both defendants of the highest crime, but they will still both go to jail for two years. If, however, only one of the prisoners confesses, then the confessor will be released without any jail time, while the other prisoner will get 10 years. Exhibit 23-1 expresses these payoffs in a 2×2 matrix. This matrix is called the **normal form** of the game.

EXHIBIT 23-1

PRISONER'S DILEMMA, NORMAL FORM

		Bob	
		Confess	Don't Confess
A1	Confess	8 years, 8 years,	0 years, 10 years
	Don't Confess	10 years, 0 years	2 years, 2 years

In this exhibit, the **strategies** of each player are given in the first column (for A1) and in the first row (for Bob). The **payoffs** corresponding to each **strategy pair** are given in the corresponding box in the matrix, with A1's payoff listed first. For example, if A1 chooses *don't confess* and Bob chooses *confess*, then A1 gets 10 years and Bob goes free (0 years).

We can also represent the prisoner's dilemma in a **game tree**. This game tree, also known as the **extensive form** of the game, is shown in Exhibit 23-2.

In Exhibit 23-2, we draw the first decision node for A1, and the second (and third) decision nodes for Bob. The payoffs are given at the terminal nodes, with years of jail time expressed as negative numbers: (— A1's years, — Bob's years). Although this representation might imply that A1 actually decides before Bob, the description of the game has the two players making their decisions at the same time. To illustrate that the decisions are actually simultaneous, the standard practice is to draw a closed curve around Bob's two decision nodes; this closed curve indicates that Bob does not know whether he is at Node 2 or Node 3. He must make his decision at Nodes 2 and 3 based on his best guess of what A1 will do, just like A1 must make his decision at Node 1 based on his best guess of what Bob will do. This is called a **simultaneous game**. If A1 actually did move first, then we would erase the closed curve around Nodes 2 and 3, and we would have a **sequential game**. In Section 23.2, we learn how to solve for the equilibria of simultaneous games. In Section 23.3, we learn how to solve for the equilibria in sequential games. First, we get some practice with drawing the normal and extensive form for another game.

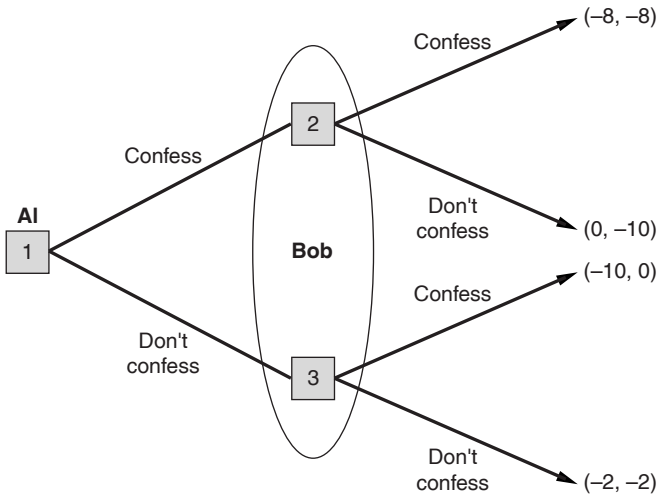
EXHIBIT 23-2**PRISONER'S DILEMMA, EXTENSIVE FORM****EXAMPLE 23.1**

Anne and Beth completed a group assignment for their finance class. The assignment is due in five minutes, but neither of them brought it to class. (They each believed that the other student was going to bring it.) Because this professor never grants any extensions, Anne and Beth both know that one of them will need to run back to their apartment to print out the assignment. To decide which one of them must make this long trek in the rain, they resort to the oldest of games: "odds and evens". In the odds-and-evens game, one player (here, Anne) takes "odds", and one player (here, Beth) takes "evens". Then, both players simultaneously show one or two fingers. If both players show the same number of fingers, then the evens player (Beth) wins the game. If players show different numbers of fingers, then the odds player (Anne) wins the game.

Problems

- Draw the normal form for this game.
- Draw the extensive form for this game.

Solutions

- The normal form is given in Exhibit 23-3.

EXHIBIT 23-3*ODDS-AND-EVENS GAME, NORMAL FORM*

		Beth	
		One	Two
Anne	One	0, 1	1, 0
	Two	1, 0	0, 1

If the players choose a different number of fingers, then Anne wins and gets to stay, with Beth going back to her apartment to get the assignment. If the players choose the same number of fingers, then Beth wins and gets to stay. We give a payoff of one to the player who wins the game (“stays”), so that the payoffs where Anne wins (odds) are (1, 0), and the payoffs where Beth wins (evens) are given payoffs of (0, 1).

Games like this are known as **zero-sum games** or **constant-sum games**, because there is a fixed amount to be won or lost (not necessarily zero), and this fixed amount must be shared by the two players. In contrast, in the prisoner’s dilemma, the total amount of jail time was not fixed.

(b) The extensive form for the odds-and-evens game is given in Exhibit 23-4.

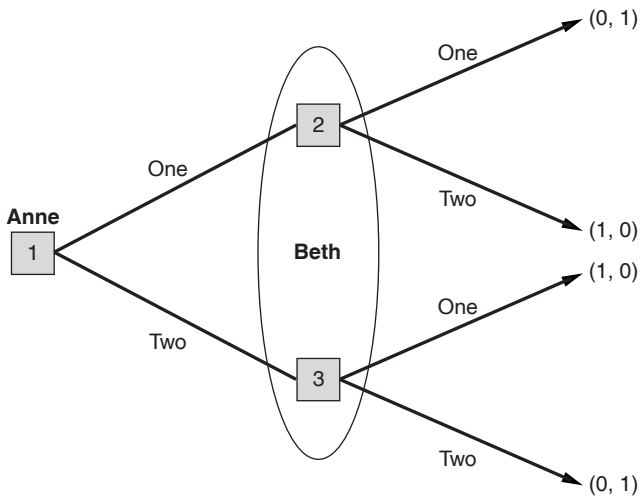
EXHIBIT 23-4*ODDS-AND EVENS-GAME, EXTENSIVE FORM*

As in the prisoner's dilemma game (Exhibit 23-2), we arbitrarily put one of the players first (Anne) and then draw a closed curve around decision nodes 2 and 3 to indicate that Beth cannot tell which node she is at when she makes her decision.

23.2 SIMULTANEOUS GAMES

In the previous section, we drew normal and extensive forms for two games, but we did not make any statements about optimal strategies or solutions. However, before proceeding to a solution, we need to define what a "solution" would be. In game theory, there are many different **equilibrium concepts** for solving a game. The unifying theme to all these concepts is that *all players must be maximizing their expected utility subject to some beliefs about other players' decisions*. The concepts differ only in the precise meaning of "subject to some beliefs".

The most famous and flexible of all equilibrium concepts is **Nash Equilibrium (NE)**. This concept is named for its founder, John Nash, a Nobel Prize winner in economics and the subject of an Academy Award-winning movie, *A Beautiful Mind*. NE requires that each player's **equilibrium strategy** must be a **best response** to the equilibrium strategies of all other players. Put another way, once the equilibrium strategies have been written down, no player could improve the payoff by changing to a different strategy.

For games where the normal form can be easily written down (as in Exhibits 23-1 and 23-3), we can use a simple procedure for finding the NE. Exhibit 23-5 illustrates this procedure for the prisoner's dilemma.

EXHIBIT 23-5

PRISONER'S DILEMMA, NORMAL FORM, WITH BEST RESPONSES

		Bob	
		Confess	Don't Confess
A1	Confess	8 years, 8 years	0 years, 10 years
	Don't Confess	10 years, 0 years	2 years, 2 years

Exhibit 23-5 uses the normal form (Exhibit 23-1) as its starting point and then circles the best responses for each player. Remember that in each cell of the normal-form matrix, the first payoff belongs to A1, and the second payoff belongs to

Bob. Now imagine that Bob believes that Al is going to *confess*. With this belief, Bob knows that his payoff will be in the top row of the matrix. Then Bob can either *confess*, leading to the upper left cell of (*confess*, *confess*) and giving him eight years, or *don't confess*, leading to the upper right cell of (*confess*, *don't confess*) and giving him 10 years. Because we assume that Bob would prefer to spend fewer years in prison, we circle his payoff of eight years in the upper left quadrant.

Next, suppose that Bob believes that Al is going to play *don't confess*. Now Bob knows that he is going to be in the bottom row of the matrix. Then, Bob can either *confess*, leading to the lower left cell of (*don't confess*, *confess*) and setting him free with 0 years in prison, or *don't confess*, leading to the lower right cell of (*don't confess*, *don't confess*) and giving him two years. Again, we assume that Bob would prefer to spend fewer years in prison, so we circle his payoff of zero years in the lower left quadrant.

After performing these steps, we have determined Bob's best responses to both of Al's possible strategies. To finish the problem, we need to do the same thing for Al. First, we imagine that Al believes that Bob is going to *confess*. With this belief, Al knows that his payoff will be in the left column of the matrix. Then Al can either *confess*, leading to the upper left cell of (*confess*, *confess*) and giving him eight years, or *don't confess*, leading to the lower left cell of (*don't confess*, *confess*) and giving him 10 years. Because Al would prefer to spend fewer years in prison, we circle his payoff of eight years in the upper left quadrant.

Finally, suppose that Al believes that Bob is going to play *don't confess*. Now Al knows that he is going to be in the right column of the matrix. Then Bob can either *confess*, leading to the upper right cell of (*don't confess*, *confess*) and setting him free with zero years in prison, or *don't confess*, leading to the lower right cell of (*don't confess*, *don't confess*) and giving him two years. Again, we assume that Bob would prefer to spend fewer years in prison, so we circle his payoff of zero years in the upper right quadrant.

Now, to find the NE, we look for all cells in the matrix where both strategies have been circled. This requirement yields the upper left quadrant of (*confess*, *confess*), which is the only NE for the game. In this equilibrium, both prisoners will spend eight years in jail. To both Al and Bob, this is going to seem like a terrible outcome. If only they could somehow agree to play *don't confess*, then they could each receive two years in prison. It is easy to see, however, that this outcome is not possible unless the players can make some binding agreement. In the absence of a binding agreement, both players have an incentive to play *confess* and to get away without any jail at all. Indeed, we can see that *confess* is a **dominant strategy** for both players: each player will do better (less jail time) by playing *confess* than they will by playing *don't confess*, regardless of what the other player does. In the real world, there are many examples of games like the prisoner's dilemma: both players would like to settle on a different outcome (*don't confess*, *don't confess*), but both players have an incentive to cheat on this outcome. Some versions of these games are called **arms races**, as the next example illustrates.

EXAMPLE 23.2

Drugco and Pharmco produce the two leading drugs to treat severe flu symptoms. These are strong medications available only by prescription, and both firms market their medicines heavily to physicians. Both firms are considering large direct-to-consumer advertising plans. Advertising is very costly, but it would increase awareness of the drugs and help each firm in its competitive position. Each firm can independently choose to be aggressive in the direct-to-consumer market by choosing *high advertising* or to be less aggressive by choosing *low advertising*. If only one of the two firms chooses *high advertising*, then the NPV of that firm's product (including advertising costs) would be \$500M, whereas the NPV of the *low advertising* firm would be \$100M. If both firms choose *high advertising*, then the NPV of each product would be \$200M. If both firms choose *low advertising*, then the NPV of each product would be \$400M.

Problems

- (a) Draw the extensive form for this game.
 (b) Draw the normal form for this game and solve for all Nash equilibria.

Solutions

(a) The extensive form is given in Exhibit 23-6. We have arbitrarily chosen to put Drugco first and Pharmco second, with a closed curve around Pharmco's decision nodes (2 and 3) to denote the simultaneity of the game.

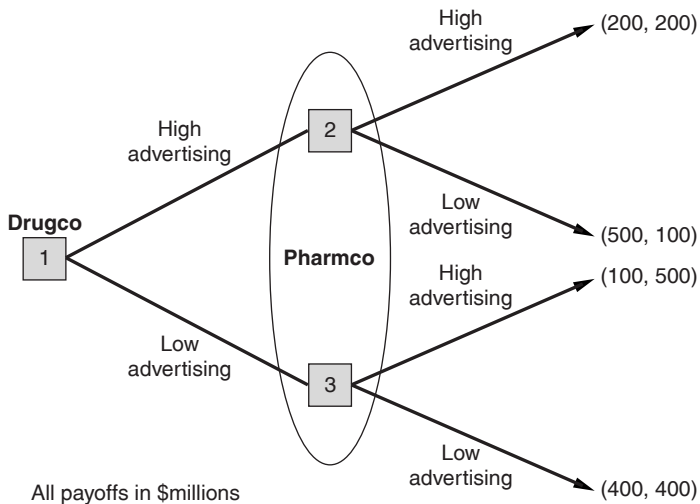
EXHIBIT 23-6**ADVERTISING GAME, EXTENSIVE FORM**

(b) The normal form, with best responses circled, is given in Exhibit 23-7. There is a unique NE of (High Advertising, High Advertising), where both firms have an NPV of \$200M. Notice the similarity of this problem to the prisoner's dilemma shown in Exhibit 23-5.

EXHIBIT 23-7

ADVERTISING GAME, NORMAL FORM

		Pharmco	
		High Advertising	Low Advertising
Drugco	High Advertising	\$200 M, \$200 M	\$500 M, \$100 M
	Low Advertising	\$100 M, \$500 M	\$400 M, \$400 M

As in the prisoner's dilemma, the players in this game would like to collude on a different outcome—in this case with both firms playing “low advertising”, leading to payoffs of \$400M for both. Unfortunately, this superior outcome (for the firms) is not an NE, as both firms would have an incentive to deviate and play “high advertising”. For this reason, we could call this game an “advertising arms race”, with the firms engaged in an escalating spiral of advertising spending. Arms-race games were among the first topics of game theory, as applied to the ever-increasing military expenditures during the Cold War. ■

Next, we look for the Nash equilibrium for the odds-and-evens game. By following the same procedures as we did for the prisoner's dilemma, we can circle the best responses for each player. This normal form, with best responses circled, is shown in Exhibit 23-8.

For anyone who has enjoyed the childhood pastime of odds and evens, it will come as no surprise that there is no clean solution. Anne, who is playing “odds”, always wants to do the opposite of Beth. Conversely, Beth, who is playing “evens”, always wants to do the same thing as Anne. When we circle the best responses, there is no cell in the matrix with two circles. When this happens, we say that there is no **pure-strategy NE**. A pure strategy is a strategy that plays one choice all the time: *one* is a pure strategy in the odds-and-evens game; *confess* is a pure strategy in the prisoner's dilemma. In contrast, a **mixed strategy** combines multiple pure strategies. For example “play one finger 50 percent of the time and play two fingers 50 percent of the time” is an example of a mixed strategy. In his original paper about NE, John Nash proved that every game has at least one NE. Thus, if there is no pure-strategy NE, then there must be at least one **mixed-strategy NE**.

EXHIBIT 23-8

ODDS-AND-EVENS GAME, NORMAL FORM, WITH BEST RESPONSES

		Beth	
		One	Two
Anne	One	0, $\textcircled{1}$	$\textcircled{1}$, 0
	Two	$\textcircled{1}$, 0	0, $\textcircled{1}$

In general, there is no easy way to find all the mixed-strategy NE for a game. In the special case of games with two players with two strategies each—also called **two-by-two games**—we can solve for the mixed-strategy equilibrium by solving one equation for each player. In the paragraphs below, we solve these equations for the odds-and-evens game.

Let p be the probability of Anne playing *one*, so that $1 - p$ is the probability of Anne playing *two*. With these probabilities, if Beth plays *one* then she would receive an expected payoff of

$$\text{Beth's expected payoff of playing one} = p * 1 + (1 - p) * 0 = p. \quad (23.1)$$

If Beth plays *two*, then she would receive an expected payoff of

$$\text{Beth's expected payoff of playing two} = p * 0 + (1 - p) * 1 = 1 - p. \quad (23.2)$$

With these expected payoffs, Beth will choose to play *one*, if and only if $p > 1 - p$. Then,

$$\text{Beth's expected payoff for the game} = \text{Max}(p, 1 - p). \quad (23.3)$$

Because this is constant-sum game, everything Beth gets is effectively taken from Anne (e.g., if Beth gets a payoff of p , then Anne gets an expected payoff of $1 - p$). Thus, to maximize her own expected payoff, Anne can just try to minimize Beth's maximum payoff. This is called the **minimax solution**, because a player tries to “minimize the maximum payoff” of her opponent.

To minimize Beth's payoff, Anne should set p so that both terms in the “Max” function are equal to each other:

$$\text{To minimize Beth's expected payoff: } p = 1 - p \rightarrow p = 0.5. \quad (23.4)$$

Next, we repeat these steps, this time with Beth trying to minimize Anne's maximum payoff. Let q be the probability of Beth playing *one*, so that $1 - q$ is the probability of Beth playing *two*. With these probabilities, if Anne plays *one* then she would receive an expected payoff of

$$\text{Anne's expected payoff of playing one} = q * 0 + (1 - q) * 1 = 1 - q. \quad (23.5)$$

If Anne plays *two*, then she would receive an expected payoff of

$$\text{Anne's expected payoff of playing two} = q * 1 + (1 - q) * 0 = q. \quad (23.6)$$

With these expected payoffs, Anne will choose to play *one*, if and only if $1 - q > q$. Then,

$$\text{Anne's expected payoff for the game} = \text{Max} (1 - q, q). \quad (23.7)$$

To minimize Anne's payoff, Beth should set q so that both terms in the Max function are equal to each other:

$$\text{To minimize Anne's expected payoff: } 1 - q = q \rightarrow q = 0.5. \quad (23.8)$$

With these results, we can claim that $(p = 0.5, q = 0.5)$ is a mixed-strategy NE of the game. To verify this claim, we check that both players are making best responses to the other player's choices. This is a trivial proof, for because both players are randomizing 50–50, then it does not matter what the other player does: all possible strategies lead to a payoff of 0.5. Thus, $(p = 0.5, q = 0.5)$ is a mixed-strategy NE.

Mixed-strategy equilibria are common in competitive zero-sum type games and sports such as poker, sailing (really!), and penalty shots in soccer. Many scenarios from business strategy can mimic these kinds of games. Mixed-strategy equilibria also show up in technology investing, in the form of a **leader-follower game**. Example 23.3 illustrates such a game.

EXAMPLE 23.3

Leadco is the market-leading producer of microprocessors for home and small business computers. Followco is Leadco's closest competitor in this market. Both firms are currently working on their next-generation microprocessor. These development projects, carried out in great secrecy, face typical constraints for microprocessor development: customers demand many new features, but adding features tends to reduce processor speed. Both Leadco and Followco believe that the majority of customers want to have more graphics capabilities on the chip, but the reduction in speed will turn off other customers. Both companies must decide how much more graphics capability to add, knowing that this addition will reduce the processor speed.

We summarize the contrasting goals with two possible strategies for each firm: *more graphics* and *faster speed*. With a larger installed-base and more brand awareness, Leadco would like to have the same strategy as Followco because this symmetry will tend to preserve their current lead. If both companies choose the same strategy, then Leadco would maintain a 75 percent share of the market, and their processor would have an NPV of \$6B, with \$2B for Followco. On the other hand, Followco would like to adopt the opposite strategy from Leadco because they would then have the opportunity to steal some of Leadco's installed base. If the two firms choose different strategies, then the firm with *more graphics* will have an NPV of \$5B, and the firm with *faster speed* will have an NPV of \$4B.

Problems

- (a) Draw the extensive form for this game.
 (b) Draw the normal form for this game and solve for all Nash equilibria.

Solutions

(a) The extensive form is given in Exhibit 23-9. From this extensive form, one might think that *more graphics* is a “better” strategy because it gives higher payoffs when the players choose different strategies. This kind of reasoning is dangerous, because, as we will see, a pure strategy of *more graphics* is not part of any NE.

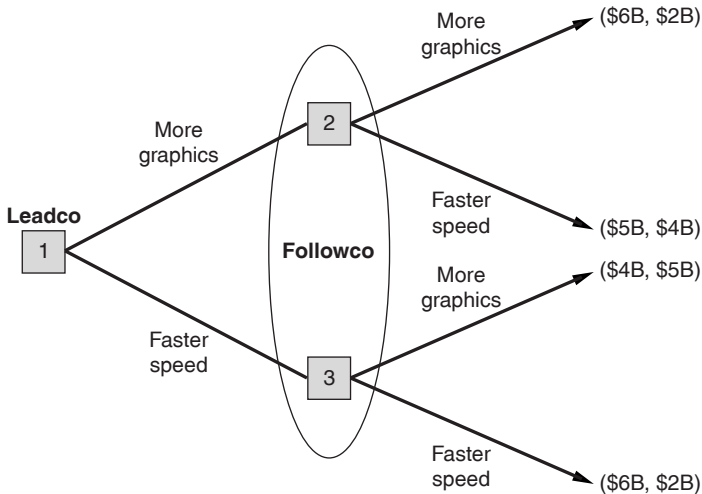
EXHIBIT 23-9**LEADER-FOLLOWER GAME, EXTENSIVE FORM**

(b) The normal form for this game, with best responses circled, is given in Exhibit 23-10.

As in the odds-and-evens game, we find no pure-strategy NE. The reason is that Leadco always wants to be the same as Followco, whereas Followco wants to be different. With a simultaneous game, the best strategy is to try to keep the other company guessing. The game-theoretic way to do this is with a mixed strategy.

To find the mixed-strategy equilibrium, we follow the same steps as we did for the odds-and-evens game. Let p be the probability of Leadco playing *more graphics*, so that $1-p$ is the probability of Leadco playing *faster speed*. With these probabilities, if Followco plays *more graphics* then it would receive an expected payoff of

$$p * \$2B + (1 - p) * \$5B = \$5B - \$3B * p. \quad (23.9)$$

EXHIBIT 23-10

LEADER-FOLLOWER GAME, NORMAL FORM

		Followco	
		More Graphics	Faster Speed
Leadco	More Graphics	\$6B, \$2B	\$5B, \$4B
	Faster Speed	\$4B, \$5B	\$6B, \$2B

If Followco plays *faster speed*, then it would receive an expected payoff of

$$p * \$4B + (1 - p) * \$2B = \$2B + \$2B * p. \quad (23.10)$$

Thus, Followco's expected payoff for the game is

$$\text{Max } (\$5B - \$3B * p, \$2B + \$2B * p). \quad (23.11)$$

To minimize Followco's payoff, Leadco should set p so that both terms in the Max function are equal to each other:

$$\$5B - \$3B * p = \$2B + \$2B * p \rightarrow p = 3/5. \quad (23.12)$$

Next, we repeat these steps, this time with Followco trying to minimize Leadco's expected payoff. Let q be the probability of Followco playing *more graphics*, so that $1 - q$ is the probability of Followco playing *faster speed*. With these probabilities, if Leadco plays *more graphics* then it would receive an expected payoff of

$$q * \$6B + (1 - q) * \$5B = \$5B + \$1B * q. \quad (23.13)$$

If Leadco plays *faster speed*, then it would receive an expected payoff of

$$q * \$4B + (1 - q) * \$6B = \$6B - \$2B * q. \quad (23.14)$$

Thus, Leadco's expected payoff for the game is

$$\text{Max } (\$5B + \$1B * q, \$6B - \$2B * q). \quad (23.15)$$

To minimize Leadco's payoff, Followco should set q so that both terms in the Max function are equal to each other:

$$\$5B + \$1B * q = \$6B - \$2B * q \rightarrow q = 1/3. \quad (23.16)$$

Equations (23.12) and (23.16) tell us that the mixed-strategy NE of this game is ($p = 3/5, q = 1/3$). In words, this means that Leadco plays *more graphics* 60 percent of the time, and Followco plays *more graphics* 33.3 percent of the time. If both firms are using these strategies, then neither firm can do better by using any other strategy. ■

Thus far in the book, we have performed two kinds of analysis: **positive analysis** and **normative analysis**. Positive analysis aims to describe actual behavior. Our studies of VC returns (chapters 3 and 4), the performance of specific VC investments (Chapter 7), and the frequencies of various contractual terms (chapters 2 and 8) were all examples of positive analysis. Normative analysis aims to describe optimal behavior. When we presented the modified VC method in Chapter 9, we did so not because we think VCs actually use this method, but because it is the “correct” model under certain assumptions. Similarly, all of Part III provides a normative model for partial valuation. Although the book argues that this framework is helpful for making investment decisions, it does not claim that current VCs are actually using this framework. In short, positive analysis attempts to describe the world “the way it is”, whereas normative analysis attempts to describe the world “the way it ought to be”. One cannot jump easily from one type of analysis to another.

Game theory is normative analysis. Although game theorists often speak of “equilibrium predictions”, they do not mean this literally. Instead, game theory makes the assumption that all players are behaving rationally, and then logically derives the implications of such behavior for equilibrium outcomes. These equilibria are not positive predictions about the way the world is, but instead are normative predictions about the way the world would be under some strong assumptions about rationality. Thus, when we say that the equilibrium in Example 23.3 is $(p = 3/5, q = 1/3)$, we are not predicting this outcome, but merely establishing a baseline for rational players. For our purposes, game theory is best used to force us to think rigorously about all the strategic moves available to all interested parties. The Nash equilibrium solutions should not be thought of as final answers, but rather as a structure for understanding these moves.

So far in this chapter, we have analyzed two types of games: arms-race games (prisoner’s dilemma and Example 23.2), where both players have a dominant strategy that leads to an unhappy NE, and competitive games like Example 23.3, of which constant-sum games like odds-and-evens are a special class. A third type of game commonly appears: the **coordination game**. In a coordination game, there are no dominant strategies and more than one possible pure-strategy NE. Example 23.4 gives a typical game of this type.

EXAMPLE 23.4

Gameco and Movieco are the leading developers of DVD technology. In the past, these two companies were able to agree on identical technical standards, but they are now embroiled in a fierce debate about the next generation of technology. Gameco believes that the time is ripe for a revolutionary change in DVD technology that would provide much larger storage capacity and allow for highly complex interactive games. Movieco, on the other hand, favors a more evolutionary change that would maintain a higher degree of backward compatibility.

Because the companies are unable to agree on a standard technology, they have continued with separate development projects. Other content providers are reluctant to choose sides, fearing that they may pick the wrong company to back. This delay is damaging

the long-term sales potential of both technologies. If the two companies are unable to settle on a single technology, then each project would be worth \$2B. Both companies would do better if they could agree on a single standard—but which one? The revolutionary standard would favor Gameco, with an expected NPV of \$10B versus only \$4B for Movieco. The evolutionary standard would favor Movieco, with an expected NPV of \$10B versus only \$4B for Gameco. Although this is an ongoing battle with no clear endpoint, we choose to model it as a single-stage simultaneous game, where each company must decide on a standard.

Problems

- (a) Draw the extensive form for this game.
- (b) Draw the normal form for this game and solve for all pure-strategy Nash equilibria.

Solutions

- (a) The extensive form is given in Exhibit 23-11.

EXHIBIT 23-11
STANDARDS GAME, EXTENSIVE FORM

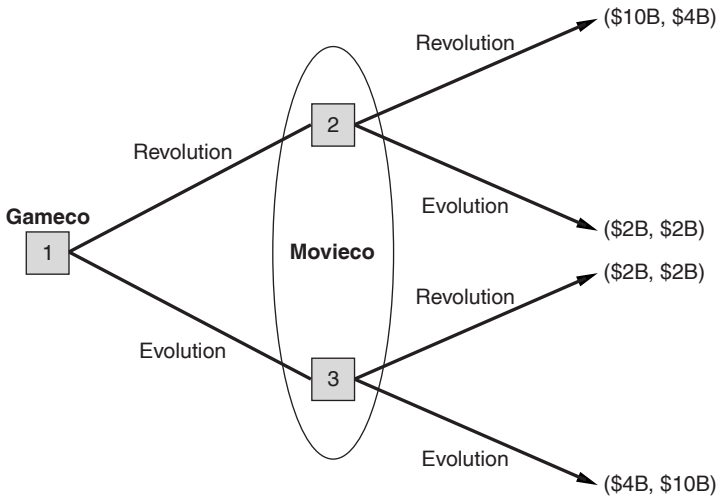

- (b) The normal form, with best responses circled, is given in Exhibit 23-12.

This game has two pure-strategy NE: *(Revolution, Revolution)* and *(Evolution, Evolution)*. From a normative perspective, we cannot say which outcome “should” occur, only that the companies would rather agree than disagree.

EXHIBIT 23-12**STANDARDS GAME, NORMAL FORM**

		Movieco	
		Revolution	Evolution
Gameco	Revolution	$\$10B,$ $\$4B$	$\$2B,$ $\$2B$
	Evolution	$\$2B,$ $\$2B$	$\$4B,$ $\$10B$

In addition to these two pure-strategy NE, there is also a unique mixed-strategy NE. In Exercise 23.1, you are asked to solve for this equilibrium. ■

REALITY CHECK: In the real world, these kinds of coordination games are common. Perhaps the most famous example is the battle between VHS and Beta-max for the video recording market in the early 1980s. The scenario of Example 23.4, a standards battle for new DVD technology, is still being waged as of this writing. In practice, these battles tend to get resolved over time as one of the technologies gains a critical mass of developers and content providers. Once this happens, the owners of the trailing technology can choose to continue the fight (and get a large share of an ever-shrinking market) or give up and join the leading technology to get a smaller share of a larger market. The longer the fight goes on, the greater the damage to its potential market. Indeed, some standards battles can go on for so long that a new technology completely overtakes them. By modeling these contests as one-step simultaneous games, we lose some important nuances but still gain insight into the stakes of the battle.

23.3 SEQUENTIAL GAMES

In this section, we analyze sequential games, where players take turns making moves. These games introduce some new complications, as illustrated by the following **entry game**. Drugco sells *Leaufleau*, the market-leading drug for hypertension. This drug is about to lose patent protection for its key ingredient. Generico, a maker of generic drugs, is considering entry into the hypertension market with the chemical equivalent of *Leaufleau*. Under law, if Generico is the first company to gain approval for a generic version of *Leaufleau*, then they will be allowed six months as the only generic competitor. After this six months is over, other

companies can enter the market with their own versions. As soon as generic competition intensifies, the profits for both the incumbent (Drugco) and the first generic (Generico) would fall significantly. Drugco would like to postpone this date for as long as possible by “scaring” Generico out of the market. As Generico plans to introduce their drug, Drugco files expensive lawsuits claiming infringement of patents related to the manufacturing of *Leaufleau* and prepares to drop the price of *Leaufleau* to keep consumers from switching to the generic form during Generico’s six-month exclusivity period. If Drugco succeeds in scaring Generico away from entry, then Drugco will increase their NPV by \$1B, and Generico will have an NPV of 0. If Generico enters the market and Drugco chooses to fight with these measures, then both companies will lose \$100M. If Generico enters and Drugco decides not to fight, then both companies will make \$100M. Exhibit 23-13 gives the extensive form for this game. Exhibit 23-14 gives the normal form, with best responses circled.

EXHIBIT 23-13

ENTRY GAME, EXTENSIVE FORM

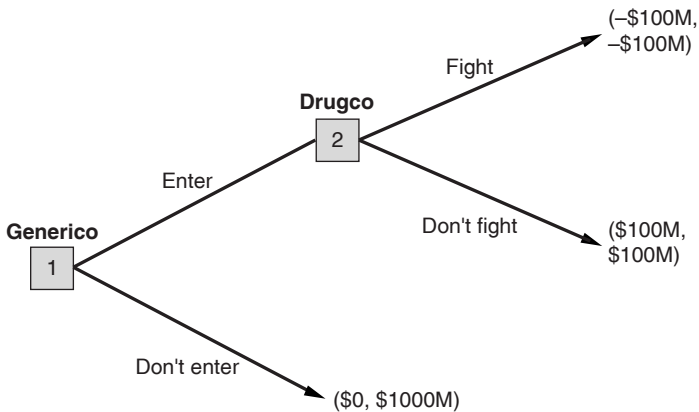

Exhibit 23-14 shows two NE: (*don't enter, fight*) and (*enter, don't fight*). In the first equilibrium, Generico expects Drugco to fight, so it chooses not to enter. If this were a simultaneous game, then there would be nothing troubling about this equilibrium. In a sequential game, something might make us uneasy: the Drugco strategy to *fight* is not a credible threat. It is not a credible threat because if Generico chooses to *enter*, then Drugco's best response would be *don't fight*. The only reason that (*don't enter, fight*) is a NE is that the decision to fight is irrelevant if Generico does not enter. Thus, technically speaking, anything played by Drugco

EXHIBIT 23-14

ENTRY GAME, NORMAL FORM

		Drugco	
		Fight	Don't Fight
Generico	Enter	\$-100M, \$-100M	\$100M, \$100M
	Don't Enter	\$0M, \$1000M	\$0M, \$1000M

can be a “best response” to *don't enter*. In response to this counterintuitive equilibrium, game theorists devised a refinement of NE based on the concept of **subgames**. A subgame is any part of a game that can be cleanly separated from the rest of the game and analyzed on its own. Graphically, we can identify subgames by looking at the extensive form. If there are any decision nodes in the tree that do not have closed curves around them, then we can “snip” the tree at those nodes and analyze these snipped nodes as part of a subgame. For example, we can snip the extensive form in Exhibit 23-13 at Node 2, leaving us a subgame with only one player (Drugco) and that player’s decision to *fight* or *don't fight*. In simultaneous games like Examples 21.1 through 21.4, there is no way to snip a decision node off the tree—after the first node, all other decision nodes had closed curves around them. Those simultaneous games had no subgames, so no further analysis can be done.

If we do have subgames, then we solve for the NE of each subgame, using backward induction to solve each subgame in reverse order. The simplest way to do this for the entry game is by circling best responses in the extensive form. Exhibit 23-15 illustrates this solution method. The subgame following Node 2 has only one player, so the NE of that subgame is just the optimal move for Drugco, which is *don't fight*. If we then back through the tree, Generico should play *enter* if it expects that Drugco would play *don't fight*. We have now solved for the unique **subgame-perfect Nash equilibrium (SPNE)** as *(enter, don't fight)*. Thus, for sequential games, the method of circling best responses in the normal form is no longer sufficient. We need to use information about the timing of decisions, and this information is only available in the extensive form.

Like NE, the SPNE is a normative concept, not a positive prediction. Just because *(enter, don't fight)* is the only SPNE does not mean that, in practice, Drugco won't be able to scare Generico away from entering. Often, however, we can model the methods that Drugco can use to succeed in keeping Generico out of the market. Example 23.5 demonstrates one of these methods, where Drugco uses a commitment mechanism to make the fight threat more credible.

EXHIBIT 23-15

ENTRY GAME, EXTENSIVE FORM, WITH SUBGAME PERFECT STRATEGIES CIRCLED

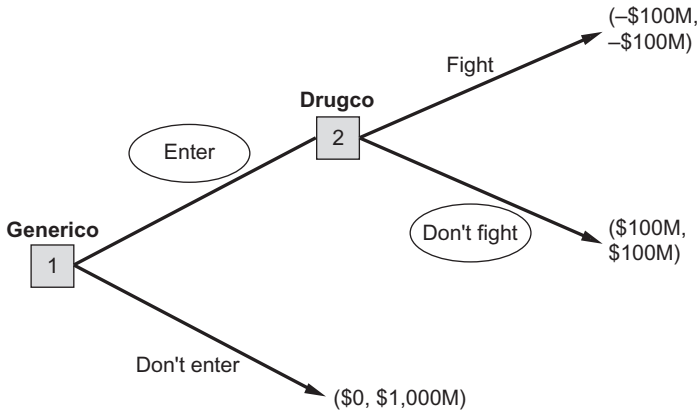
**EXAMPLE 23.5**

Consider the game shown earlier in Exhibit 23-13. Now, we add an additional move to this game. Before Generico decides whether to enter (Node 1 in Exhibit 23-13), Drugco can *commit* to a fight. Drugco makes this commitment by placing \$500M in an escrow account with a specialized “commitment agent”. The terms of this escrow state that if Drugco fails to fight, then the \$500M will be forfeited to the commitment agent. In all other respects, the payoffs are the same as in Exhibit 23-13.

Problem Draw the extensive form for this game, identify the subgames, circle the best responses in each subgame, and solve for the SPNE.

Solution Exhibit 23-16 gives the extensive form for this entry game, with best responses circled. This game has four subgames. We can snip the tree at Nodes 4 and 5, leaving only Drugco’s fight decision. We can also snip the tree at Nodes 2 and 3, leaving Generico’s entry decision, to be followed by Drugco’s fight decision. (The subgame that follows Node 3 is identical to the full game tree in Exhibit 23-13.) To find the SPNE, we must make sure to have only NE in each subgame, with the full tree solved by backward induction. We begin with the bottom half of the tree. At Node 5, Drugco would choose *don’t fight*. If Generico expects Drugco to play *don’t fight*, then at Node 3, it would choose to *enter*. Thus, the SPNE payoffs from the bottom half of the tree are (\$100M, \$100M), just as we found in Exhibit 23-13.

EXHIBIT 23-16

ENTRY GAME, WITH COMMITMENT EXTENSIVE FORM

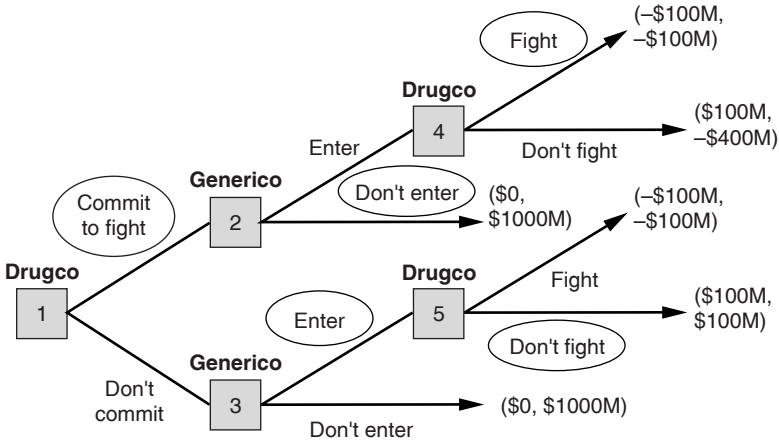

In the top half of the tree, we have a different situation. Because Drugco has played *commit*, the *don't fight* strategy at Node 4 would result in a loss of \$500M relative to the *don't fight* strategy at Node 5. The overall payoff of *don't fight* then becomes negative \$400M, which is inferior to the *fight* payoff of negative \$100M. Thus, at Node 4, Drugco should *fight*. If Generico expects Drugco to *fight* at Node 4, then it should choose *don't enter* at Node 2. Thus, the SPNE payoffs from the top half of the tree are (\$0, \$1000M).

To finish the solution, we compare Drugco's payoffs from choosing to *commit*—the top half of the tree—which are equal to \$1000M, with Drugco's payoff from playing *don't commit*—the bottom half of the tree—which are equal to \$100M. Because the former is higher than the latter, Drugco's optimal strategy at Node 1 is to *commit*. Thus, the unique SPNE, which must specify a strategy at every node (including nodes that are not reached in equilibrium!), is (1 = *commit*, 2 = *don't enter*, 3 = *enter*, 4 = *fight*, 5 = *don't fight*), with SPNE payoffs of (\$0, \$1000).

The main theme of this example will seem familiar to armchair strategists everywhere: sometimes you can improve your bargaining position by restricting your future options. For example, leaders sometimes make public pronouncements—which are costly to repudiate—committing their organization to some (possibly unpopular) strategy. Such pronouncements can be effective ways to stifle internal dissent because subordinates realize that the leader will “fight” any attempt to change the strategy.

In Example 23-5, Drugco's commitment device allows it to make a credible threat of fighting the entry of Generico. The game does not have to stop here. Some clever executive at Generico could approach the "commitment agent" and say, "Drugco has promised you \$500M if we enter and Drugco does not fight. As long as you hold this contract in your hand, we will not enter, and the contract is worthless to you. Thus, why don't you just rip up the contract, and we will give you \$1?" If we add this strategy to the game, the new SPNE has the contract ripped up, and Generico enters. This kind of game can go back and forth, as each player tries to think of ever more powerful ways to alter the game. Alas, some lawyers we know insist that most of these fanciful contracts would be unenforceable. Spoil sports.

Drugco can also rely on "reputation" to make their threat credible. Speaking loosely, the reputation argument goes like this: "Here at Drugco, we always fight whenever anyone enters our markets. We have done this for decades, and we are not about to stop now. We realize that it costs us money to fight, but in the long run it saves us even more, because potential competitors are scared away by our fearsome reputation." To make this reputation argument more formally, we need to model an extensive form and see if it works.

As it turns out, reputation stories do not work in **finite games**. If you can actually write down the terminal nodes of the game, then you will be able to solve the game backward and SPNE arguments will keep the threats from being credible. To see this, imagine that the entry game from Exhibit 23-13 is repeated 100 times, always between the same two players. One might think that this would be a long enough time to gain a reputation, but if we divide the game into sub-games, we will find that in the 100th playing it is not optimal for Drugco to fight, so thus it is not optimal to fight in the 99th playing, the 98th playing, and so on. In contrast, for an **infinite game**, under a wide variety of conditions it will be possible for Drugco to establish a reputation, and virtually any outcome can be claimed as part of an equilibrium. Because corporations are, in theory, infinitely lived institutions, reputation effects are supported by game theory and lead to generally indeterminate equilibrium predictions. This paradoxical contrast between finite and infinite games has been recognized since almost the dawn of game theory, and the proof that infinite games can support virtually any equilibria is so well known that its creator has passed into oblivion, with the proof known simply as the **folk theorem**.

23.4 GAME THEORY AND REAL OPTIONS

In Chapter 21, we demonstrated several examples of real options, where firms could profitably delay making investment decisions until more information was known. An important critique of the real-options approach is that it can be misleading when a firm faces competition. The idea of "waiting to invest" can be strategic suicide if a

competitor can just come along and steal your market. In Example 23-6, we provide an illustration of this critique.

EXAMPLE 23.6

Fuelco is considering a consumer application for their patented fuel-cell technology. (This corresponds to Project C from Chapter 19.) They have already completed several R&D projects with this technology, so they have eliminated the technical risk for this new project. To begin producing and marketing to the consumer market would require a new investment of \$200M, to be paid in one year. The value of Project C depends on consumer demand and also depends on whether a competitor, Cellco, also enters this market. To keep things (relatively) simple, we assume that the beta for the project is zero and that the risk-free rate is also zero, so all discount rates are zero for the both firms.

At time 0, Cellco and Fuelco each decide whether to invest or wait. If one firm invests and the other waits, then the investing firm will get the whole market and have an NPV of \$300M, whereas the waiting firm will have an NPV of \$0. If both firms invest, then competition will drive down the profits of both firms, which will each have an NPV of \$50M. (All NPVs described in this problem are net of the \$200M investment, when the investment is made. Thus, the gross NPV if both firms invest would be \$250M.) If both firms wait, then they both get to observe whether demand is “high” or “low”, after which each firm decides whether or not to invest. If demand is “high” (50 percent chance) and only one firm chooses to invest, then that firm receives an NPV of \$700M, and the other firm receives an NPV of \$0. If neither firm invests, then both firms receive an NPV of \$0. If both firms invest, then each firm receives an NPV of \$200M. If demand is “low” (50 percent chance), and only one firm chooses to invest, then that firm receives a negative NPV of $-\$100M$, and the other firm receives an NPV of \$0. If neither firm invests, then both firms receive an NPV of \$0. If both firms invest, then each firm receives a negative NPV of $-\$100M$.

Problems

- (a) Draw the extensive form for this game.
- (b) Identify all the subgames.
- (c) Solve for the unique SPNE.

Solutions

- (a) The extensive form is given in Exhibit 23-17.
- (b) To identify the subgames, we look for places where we can “snip” the tree at a decision node without cutting any closed curves. This procedure yields subgames beginning with Nodes 8 or 9.
- (c) Unlike the entry game in Example 23.5, the subgames for this game include decision nodes for both players. Thus, to find SPNE for the whole game, we need to consider the NE of the subgames, not just optimal play for one player in isolation.

We can solve the tree backward by solving for the NE of each subgame. Because each subgame represents a two-by-two simultaneous game, we can find these NE by circling the best responses in the normal form. We do this first for the subgame that begins with Node 8.

EXHIBIT 23-17

FUELCO'S PROJECT C, WITH COMPETITION

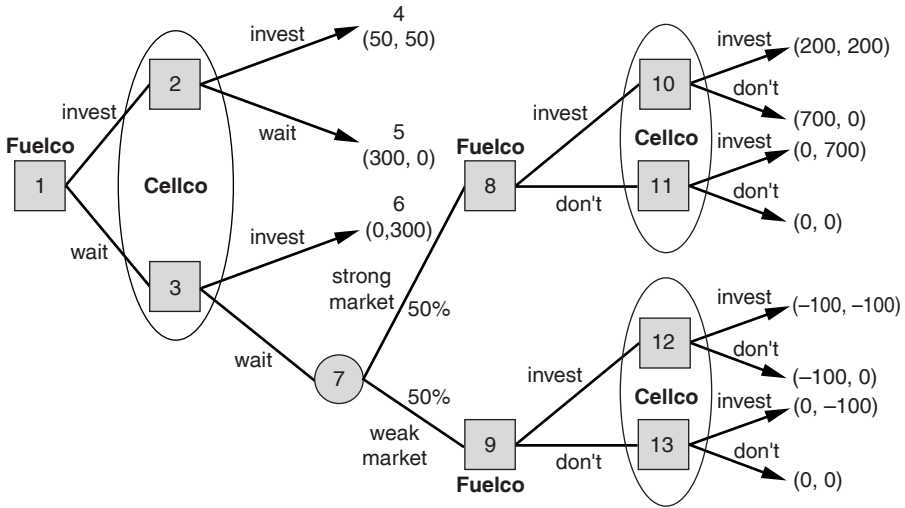

EXHIBIT 23-18

PROJECT C, STEP 2, STRONG MARKET, NORMAL FORM

		Cellco	
		Invest	Don't Invest
Fuelco	Invest	(<u>\$200M</u> , <u>\$200M</u>)	(<u>\$700 M</u> , \$0M)
	Don't Invest	\$0M, <u>\$700M</u>	\$0M, \$0M

The unique NE of this subgame is *(Invest, Invest)*, with payoffs of (\$200M, \$200M). We next consider the subgame that begins with Node 9, as shown in Exhibit 23-19. The unique NE of this subgame is *(Don't Invest, Don't Invest)*, with payoffs of (0,0).

EXHIBIT 23-19*PROJECT C, STEP 2, WEAK MARKET, NORMAL FORM*

		Cellco	
		Invest	Don't Invest
Fuelco	Invest	-\$100M, -\$100M	-\$100M, \$0M
	Don't Invest	\$0M, -\$100M	\$0M, \$0M

With NE solutions for the two subgames, we can prune the extensive form, replacing the decision nodes at 8 and 9 with their respective NE payoffs. With payoffs of (\$200M, \$200M) in a strong market and (0,0) in a weak market, Node 7 would have a 50-50 chance of these two outcomes, for an expected payoff of (\$100M, \$100M). We then redraw the extensive form in Exhibit 23-20.

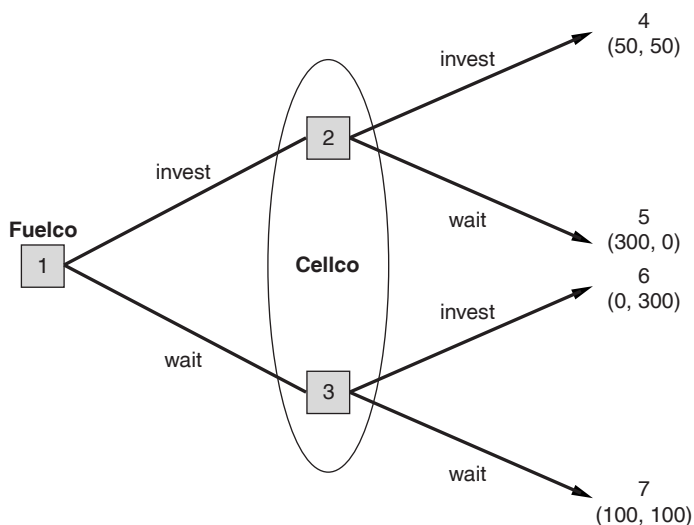
EXHIBIT 23-20*FUELCO'S PROJECT C, WITH COMPETITION, PRUNED*

This pruned version of the extensive form is a one-step simultaneous game with no subgames. We can solve for the NE of this game by circling the best responses in their normal form.

The unique NE of this game is *(invest, invest)*, yielding payoffs of (\$50M, \$50M). After doing all this work, we can see the prisoner's dilemma arms race once again rear its

EXHIBIT 23-21

PROJECT C, STEP 1, NORMAL FORM

		Cellco	
		Invest	Wait
Fuelco	Invest	$(\$50M, \$50M)$ $(\$50M, \$0M)$	$(\$300M, \$0M)$ $(\$0M, \$100M)$
	Wait	$(\$0M, \$300M)$ $(\$300M, \$100M)$	$(\$100M, \$100M)$ $(\$100M, \$100M)$

EXHIBIT 23-22

FUELCO'S PROJECT C, WITH COMPETITION, BEST RESPONSES CIRCLED

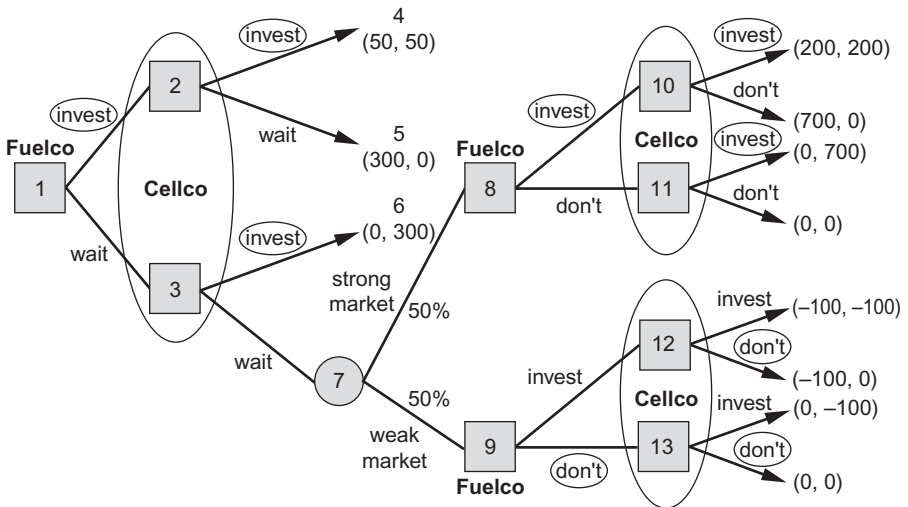

ugly head: both Fuelco and Cellco would prefer a combined switch to the (*wait, wait*) outcome, but this outcome is not a NE because each company would have an incentive to change its strategy and invest.

Now that we have solved for the NE of all the subgames, we can rewrite the extensive form for the whole game, with all best responses circled. Exhibit 23-22 shows this solution. The unique SPNE of the game is (Node 1 = *invest*, Nodes 2/3 = *invest*, Node 8 = *invest*, Node 9 = *don't invest*, Nodes 10/11 = *invest*, Nodes 12/13 = *don't invest*), with an SPNE payoff of (\$50M, \$50M). Note that Cellco's strategies must be the same at nodes 2&3, 10&11, and 12&13 because Cellco is unable to distinguish its exact location at any of these node pairs. ■

SUMMARY

Game theory is the study of multiplayer decision problems. In this chapter, we learned the basic tools of game theory, and we applied these tools to the analysis of several prototypical R&D investment scenarios. We first studied three different types of simultaneous games, where players make their moves at the same time. The first game we analyzed, an advertising arms race between two companies, is reminiscent of the classic prisoner's dilemma: both companies would like to spend fewer resources on advertising, but competition leads to high advertising by both. We next analyzed a game between a technology leader and follower. In this game, the leader would like to maintain the status quo where everyone includes similar technology features in their products, whereas the follower would like to introduce more differentiation. In equilibrium, each side tries to keep the other guessing as to its strategy. A third example was the coordination game, which can occur in battles to set technological standards. Unlike the arms-race and leader-follower games, standards battles do not have unique game-theoretic predictions, with many possible standards leading to many possible equilibrium outcomes.

In the second part of the chapter, we turned our attention to sequential games, in which players take turns making their moves. We first analyzed a game of market entry, where an incumbent drug company sought to keep a generic firm from marketing a competing product. These games can allow for rich strategy by all players, with incumbents trying to scare potential rivals away by making credible threats of litigation and price wars, and potential entrants working to defuse these threats. Game-theoretic reasoning can also provide fresh insights into standard real-option investment problems. In our final example of the chapter, we showed how competition can destroy the option value of waiting and give rise to yet another prisoner's dilemma situation.

KEY TERMS

Prisoner's dilemma	Game tree	Zero-sum games, constant
Normal form	= extensive form	sum games
Strategies, strategy pair	Simultaneous game,	Equilibrium concepts
Payoffs	sequential game	Nash equilibrium (NE)

Equilibrium strategy	Pure-strategy NE, mixed- strategy NE	Coordination games
Best response		Subgames
Dominant strategy	Two-by-two games	Subgame-perfect Nash equilibrium (SPNE)
Arms race	Minimax solution	
Pure strategy, mixed strategy	Leader-follower games	Finite games, infinite games
	Positive analysis, normative analysis	Folk theorem

EXERCISES

23.1 Solve for the mixed-strategy NE in Example 23.4. Does this equilibrium seem like a realistic outcome for the game? Do you see any conceptual difference between this mixed-strategy NE and the mixed-strategy NE in the leader-follower game?

23.2 Suppose that the advertising arms race in Example 23.2 is repeated a second time by the same two firms.

- (a) Draw an extensive form for the two-period game, showing all strategies for both firms in both periods.
- (b) Solve for all the pure-strategy NE of the game.
- (c) Solve for the unique SPNE of the game.

23.3 Consider the game modeled in Example 23.6. Now, suppose that the cost of investment is \$280M, instead of the \$200M given in the original example. In this case, all the payoffs after investment should be reduced by \$80M as compared to Exhibit 23-17. In this new game, solve for all the SPNE of the game and compare the payoffs among these SPNE.

23.4 In an enclosed space stand 57 lions and one sheep. The lions, all perfectly rational and well trained in game theory, would all like to eat the sheep. For simplicity, we imagine that the lions are numbered from 1 to 57, and sequentially decide whether they would like to eat. (If the sheep is still alive after lion #57 makes his decision, then lion #1 gets to decide again, and the process goes around and around forever.) If any lion begins to eat the sheep, then the other lions will respect his property rights and allow him to finish by himself. The sheep is powerless to stop this. If a lion eats the sheep, then he will fall asleep for one hour, during which time he becomes defenseless and can be eaten by any other lion. (While awake, a lion cannot be eaten by another lion.) The best outcome for a lion would be to eat the sheep, fall asleep, and not be eaten himself. The second best outcome for a lion would be to go hungry. The worst outcome would be to eat, fall asleep, and be eaten. So, in the unique SPNE of this game, what happens to the sheep? (Hint: The answer would be different if there were only 56 lions.)

R&D VALUATION

IN THIS CHAPTER, we pull together everything we have learned in Part IV and analyze complex examples for Drugco and Fuelco. In the Drugco example in Section 24.1, we draw on game theory, real options, and Monte Carlo simulation to evaluate two possible structures for a drug-development strategic alliance. In the Fuelco example in Section 24.2, we combine the three projects studied in previous chapters into one metaproject. The resulting analysis combines several linked real options, including one that requires a binomial tree. Finally, in Section 24.3 we review some of the key lessons from Part IV and urge readers to see both the forest and the (decision) trees.

24.1 DRUG DEVELOPMENT

This example uses a similar valuation model as in Examples 20.4 and 21.4, except that here we allow uncertainty for efficacy, alternative efficacy, and market size to be resolved during both Phase II and Phase III.

EXAMPLE 24.1

Drugco is about to begin Phase II trials for Newdrug, at a cost of \$50M. If the drug continues to Phase III trials, then these trials would cost an additional \$100M. Drugco is financially constrained, so it is looking for a partner to help fund the project. Bigco, a potential partner, has proposed two possible deal structures.

Deal 1 is a standard-looking alliance deal, where Bigco pays an up-front fee of \$200M to acquire all rights to the compound and then pays all the development costs, makes a milestone payment of \$150M on entering Phase III, and makes royalty payments of 5 percent on sales.

Deal 2 would reduce the up-front payment to \$100M, require Drugco to bear 20 percent of the development costs in Phase III, and replace the Phase III milestone with a larger \$300M milestone if Bigco decides to market the product after FDA approval. Deal 2 would have a higher royalty percentage than Deal 1 (10 percent versus 5 percent) and would give Drugco more control over the project, by allowing it to decide whether the project advances from Phase II to Phase III. In both deals, if Bigco decides not to market the product,

then all rights revert back to Drugco. If Bigco does decide to market the product, then it will incur marketing costs of \$300M in the first year, with these costs increasing annually in proportion to the 6 percent growth in the size of the market.

Both firms expect Phase II trials to take one year, Phase III trials to take two years, and the FDA approval decision to take one year, so that the FDA decision is expected in four years total. Based on preclinical testing, both firms expect Phase II trial results, E^t , to be distributed as $N(40, 40)$. The best alternative drug currently has an efficacy of 40, but has several possible improvements in the works, so its expected efficacy after one year (after the Phase II trials of Newdrug) is $A^t \sim T(40, 70, 40)$. Given the side effects of Newdrug and the risks and benefits of alternative treatments, Drugco believes that the FDA will approve Newdrug if the Phase III trials find an efficacy of 30 or greater. Based on the results of the Phase II trials, Drugco estimates that the efficacy results of Phase III will be $E \sim N(E^t, 20)$. During the three years of Phase III trials and FDA decision making, the alternative may improve again, with a distribution of $A \sim T(A^t, A^t + 50, A^t)$. If Newdrug is approved by the FDA, then its market share will depend on the relative efficacy of Newdrug versus the best available treatment, that is,

$$\text{Newdrug market share} = E^2 / (E^2 + A^2). \quad (24.1)$$

Drugco estimates that the eventual market size of Newdrug in the approval year (in millions of doses) will be 1,000, but there is considerable uncertainty around this estimate. Some of this uncertainty will be resolved in the next year (during Phase II trials), with $M^t \sim N(1,000, 50)$, and more uncertainty will be resolved over the following three years, with $M \sim N(M^t, 100)$. Each dose will sell for \$1.00, with a production cost of \$0.25. On approval, Newdrug would have 10 years of patent life remaining. After the patent expiration, Drugco expects generic competition and other improved alternatives to greatly erode the value of Newdrug, so for simplicity we assume that the continuing value would be zero after the patent expires. Following earlier examples for Newdrug, we assume a discount rate equal to the riskfree rate of 5 percent.

Problems

- (a) Draw the game tree for this problem, beginning with Drugco's decision of whether to take Deal 1 or Deal 2.
- (b) Suppose that Drugco decides to take Deal 1. What is the optimal strategy for Bigco following the Phase III trials? What is the optimal strategy for Bigco following the Phase II trials? Assuming that Bigco chooses these strategies, what are the expected payoffs to Drugco and Bigco for Deal 1?
- (c) Suppose that Drugco decides to take Deal 2. What is the optimal strategy for Bigco following the Phase III trials? Given this strategy for Bigco, what is the optimal strategy for Drugco following the Phase II trials? Assuming that Bigco and Drugco choose these strategies, what are the expected payoffs to Drugco and Bigco for Deal 2?
- (d) What is the unique SPNE of this game? What are the expected payoffs for the equilibrium?

Solutions

- (a) We draw the game tree in three pieces. First, Exhibit 24-1 shows the high-level structure for the tree. The node numbers in this tree correspond to node numbers in the detailed trees that follow for Deal 1 (Exhibit 24-2) and Deal 2 (Exhibit 24-3).

EXHIBIT 24-1

SCHEMATIC FOR THE FULL EXTENSIVE FORM

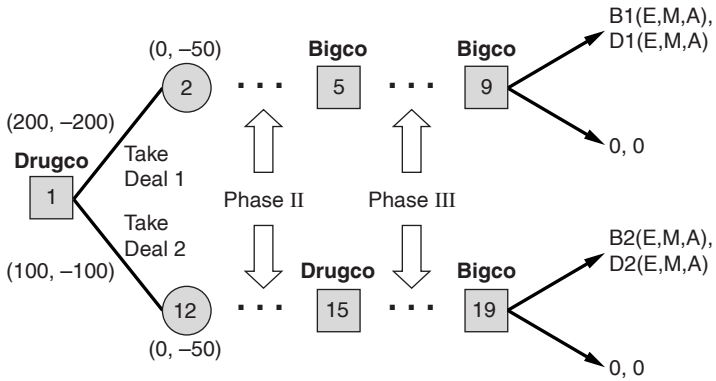

EXHIBIT 24-2

EXTENSIVE FORM FOR DEAL 1

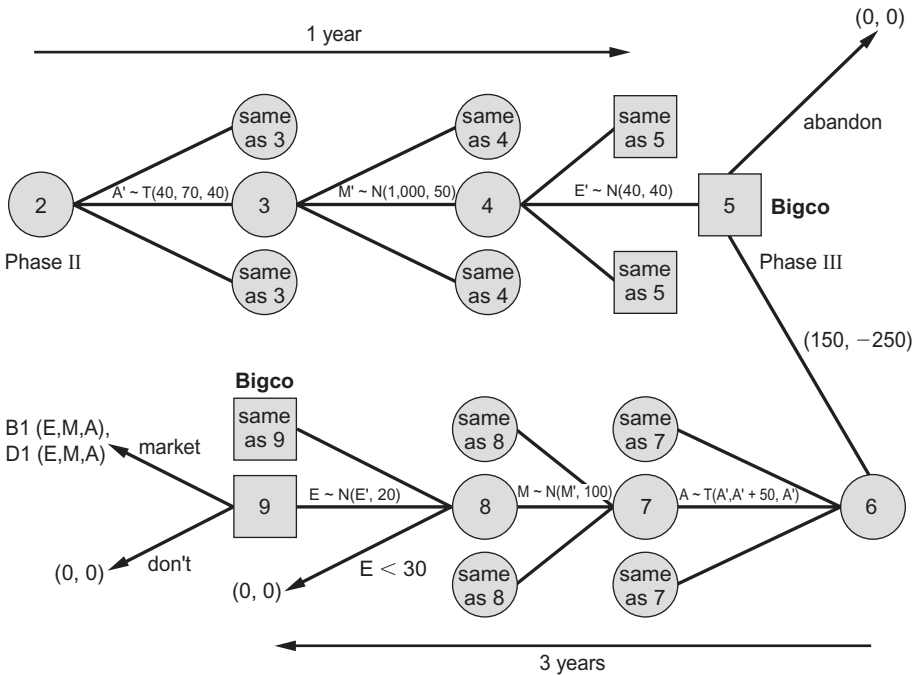
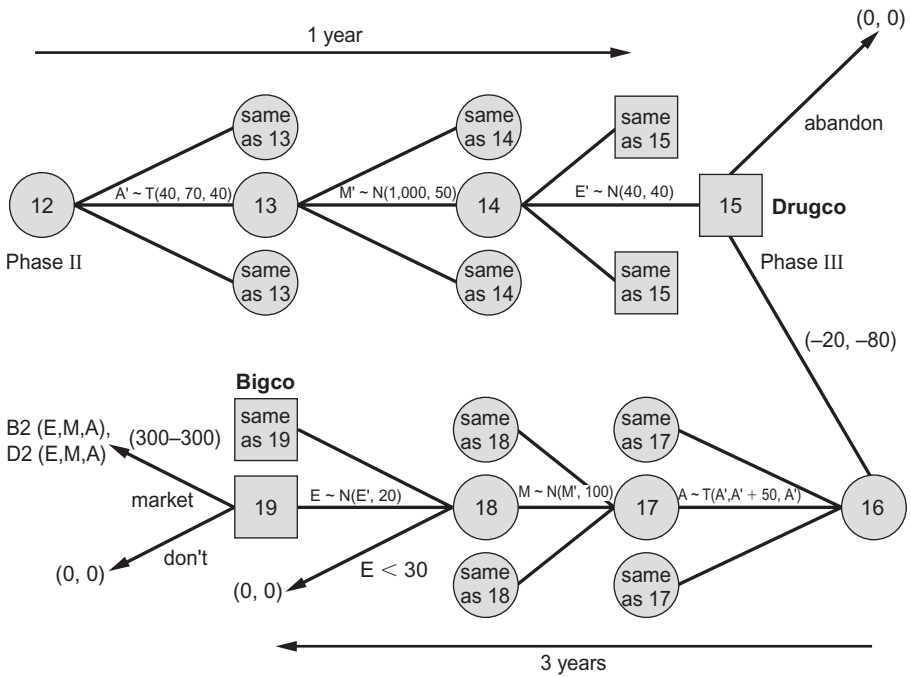

EXHIBIT 24-3

EXTENSIVE FORM FOR DEAL 2



Before attempting a solution, we note a few important elements of these game trees. First, in Exhibit 24-1, we see the up-front fees for the two deals yielding payoffs of (200, -200) in Deal 1 and (100, -100) in Deal 2. (Drugco's payoff is always listed first.) Furthermore, because Bigco pays the \$50M cost of Phase II in both structures, there is a payoff of (0, -50) at nodes 2 and 12. In Exhibit 24-2, with the extensive form for Deal 1, the Phase III continuation decision belongs to Bigco (Node 5). If Bigco decides to continue, then it pays \$100M in costs plus a \$150M milestone, yielding aggregate payoffs of (150, -250). In the analogue position of Exhibit 24-3, Drugco makes the Phase III continuation decision (node 15), no milestones are paid, and Drugco incurs \$20M of the \$100M cost, for aggregate payoffs of (-20, -80). Finally, the marketing decision is always made by Bigco. In Exhibit 24-2, there is no milestone. In Exhibit 24-3, if Bigco decides to market, then it must pay Drugco a milestone of \$300M, leading to aggregate payoffs of (300, -300).

(b) As is our usual practice, we solve the tree backward. Starting with the terminal nodes and moving back in time, we arrive at Bigco's decision about whether or not to market the product (node 9). In Example 21.4, we solved a very similar problem. All the market inputs were the same—the only difference is that here, Bigco would have to pay royalties on 5 percent of the gross sales. Exhibit 24-4 gives the full valuation model for Bigco's decision,

EXHIBIT 24-4

DCF MODEL, DEAL 1

1	A	B	C	D	E	F	G	H	I	J	K	L
2					Mean	St dev		Min	Mode	Max		
3	Efficacy (E ¹)	40			40	40						
4	Alternative efficacy (A ¹)	50						40	40	70		
5	Starting market size (M ¹)	1,000			1,000	50						
6												
7	Efficacy (E)	40			40	20						
8	Alternative efficacy (A)	67						50	50	100		
9	Starting market size (M)	1,000			1,000	100						
10	Phase III milestone	150										
11	Continuation Threshold	30.1										
12	Phase III?	1.0			Bigco NPV (if enter)		\$388.5					
13	Approval threshold	30			Drugco NPV		\$207.0					
14	Price per unit	\$1.00			Bigco NPV (option)		\$388.5					
15	Royalty rate	5.00%										
16	Cost per unit	\$0.25										
17	Market share	26.5%			Total Bigco NPV		-\$136.1					
18	Market growth	6.0%			Total Drugco NPV		\$508.4					
19	Discount rate	5.00%										
20	Approved?	1										
21	Salvage value	42.86										
22												
23	Year		5	6	7	8	9	10	11	12	13	14
24												
25	Market size		1,000	1,060	1,124	1,191	1,262	1,338	1,419	1,504	1,594	1,689
26	Market share		26.5%	26.5%	26.5%	26.5%	26.5%	26.5%	26.5%	26.5%	26.5%	26.5%
27	Revenue		\$264.7	\$280.6	\$297.4	\$315.3	\$334.2	\$354.2	\$375.5	\$398.0	\$421.9	\$447.2
28	Royalty		\$13.2	\$14.0	\$14.9	\$15.8	\$16.7	\$17.7	\$18.8	\$19.9	\$21.1	\$22.4
29	CGS		\$66.2	\$70.1	\$74.4	\$78.8	\$83.5	\$88.6	\$93.9	\$99.5	\$105.5	\$111.8
30	Marketing costs		\$300.0	\$318.0	\$337.1	\$357.3	\$378.7	\$401.5	\$425.6	\$451.1	\$478.2	\$506.8
31	Bigco profit		-\$48.5	-\$51.4	-\$54.5	-\$57.8	-\$61.3	-\$64.9	-\$68.8	-\$73.0	-\$77.3	-\$82.0
32	Drugco profit		\$13.2	\$14.0	\$14.9	\$15.8	\$16.7	\$17.7	\$18.8	\$19.9	\$21.1	\$22.4

with inputs set to their mean values. The market decision at Node 9 is made with a “Max” function in cell G14. This function takes the maximum of the NPV of marketing the drug (cell G12) with the NPV of abandoning the drug (0).

To better understand this worksheet, let’s discuss the special case shown in the exhibit, with all variables set to their mean values. In Phase II, the mean values are $E^t = 40$, $A^t = (40 + 70 + 40)/3 = 50$, and $M^t = 1,000$. In the following solution, we will demonstrate that the optimal policy for Bigco—with these Phase II outputs for A^t and M^t —is to continue if $E^t > 30.1$. (Don’t worry about the reason for this number right now. It is just a coincidence that this cutoff is so close to the FDA threshold of 30.) Because our example estimate for E^t is 40, the project continues to Phase III, where the mean outputs are $E = 40$, $A = (50 + 100 + 50)/3 = 66.7$, and $M = 1,000$. Because the FDA threshold is 30, Newdrug is approved. Cell G12 tells us that Bigco gets a positive NPV if they decide to market the drug. Nevertheless, standing at time 0, Bigco would be disappointed with this outcome because the costs (\$200M up-front, \$50M for Phase II, \$100M for Phase III, and \$150 as a milestone) are higher than the NPV of profits. The “max” function in cell G14 only tells us that once Bigco had sunk the \$500M total into developing the drug, it is optimal for them to market the drug; overall, they will still wish they had never signed the contract in the first place. Of course, this is just one special case. To determine if the overall deal is good for Bigco, we will need to complete our solution and simulate many different cases.

With an optimal strategy given by the maximum function in Cell G14, we can continue our backward journey through the tree to arrive at Node 5, the Phase III continuation decision made by Bigco. In principle, this decision is also made with a “Max” function: Bigco wants to take the maximum of either (1) NPV of continuing to Phase III, or (2) abandoning the project. In practice, this maximum computation is much more difficult than the analogue at Node 9. At Node 9, there was no more uncertainty left to be resolved: Bigco already knew the market size, the efficacy for Newdrug, and the efficacy of its alternative. Thus, the NPV of marketing the drug could be computed exactly. At Node 5, there is still uncertainty about market size, efficacy, and alternative efficacy. In this case, we cannot simply compute an NPV, but rather must run simulations to estimate it. Bigco wants to answer the following question: “Given the Phase II outcomes E^t, A^t, M^t , what is the expected NPV of the project?” Then, Bigco’s optimal strategy is to continue to Phase III if and only if this expected NPV is greater than the abandonment value of 0.

There are many ways that a clever analyst could approach this problem. (Indeed, some software packages will automate the process so that the analyst need not be clever at all.) We will not attempt to find an efficient path to a solution; instead, we break the problem down into steps to illustrate the general intuition behind the solution. We begin by assuming (for the moment), that the Phase II outputs for A^t and M^t are set to their mean values of 50 and 1,000, respectively. Next, we run simulations for the NPV of the project using various inputs of E^t . The results are graphed in Exhibit 24-5. We also graph the NPV = 0 line. The intersection of the NPV = 0 line and the Bigco NPV line occurs when E^t is equal to 30.14. This intersection means that, if $A^t = 50$ and $M^t = 1,000$, Bigco will have a positive expected value only if $E^t > 30.14$. Thus, if $E^t < 30.14$, Bigco should abandon the project, and if $E^t > 30.14$, they should continue.

Next, we allow the value of A^t to vary, while still holding M^t fixed at 1,000. For each value of A^t , we run simulations to find the value of E^t such that the NPV of the project is equal to zero. Because A^t is $T(40, 70, 40)$, the range of possible values is limited. We perform the analysis for every A^t in the set (40, 45, 50, 55, 60, 65, 70). In each case, we

EXHIBIT 24-5

BIGCO NPV AS OF PHASE III, AS A FUNCTION OF E^t ASSUMES $A^t = 50$ AND $M^t = 1,000$

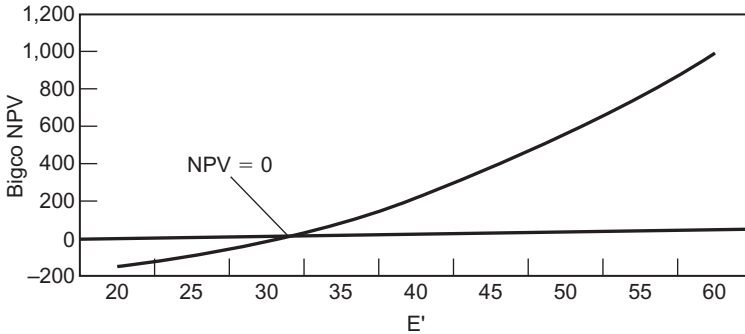

find the corresponding E^t that makes the expected NPV equal to zero. We call this a “zero-profit point”. We fit a zero-profit curve through these points in Exhibit 24-6. (This curve is nearly a straight line.) Notice that the point (50, 30.14) in the exhibit corresponds to the intersection shown in Exhibit 24-5.

We are slowly clawing our way toward a solution. At this point, if we knew that M^t were equal to 1,000, then we would make the continuation decision by looking at Exhibit 24-6 and seeing if the pair (A^t , E^t) was above or below the zero-profit curve. To finish the solution, we need to compute a different curve for each level of M^t . Although this might sound like a lot of work, by making a few smart guesses we can use interpolation to build these curves. Exhibit 24-7 shows zero-profit curves for a range of values for M^t .

From these curves, we use interpolation to build curves for intermediate levels of M^t . Analysts who want more precise results can estimate more curves and rely less on interpolation. In either case, we finish the solution by building a lookup table¹ in Excel, where the entries in the table are taken from the y-axis (E^t) in Exhibit 24-7, and the rows and columns of the table are given by the values of A^t and M^t . Then, for any given Phase II output (A^t , M^t), we instruct Excel to find the closest match from the table to find the corresponding E^t to use as a Phase III continuation threshold. Graphically, the lookup table is equivalent to using Exhibit 24-7 to identify the correct line (M^t) and the correct x-coordinate (A^t), and then finding the corresponding y-coordinate (E^t). Then, if the actual phase II output E^t is higher than this point, Bigco continues to Phase III. With this strategy defined, we can compute the expected payoffs for Deal 1 by simulating the whole project from the very beginning

¹Readers unfamiliar with lookup tables should consult a reference on Microsoft Excel. One helpful reference is Walkenbach (2003), Chapter 12.

EXHIBIT 24-6

BIGCO ZERO-PROFIT CURVE, ASSUMING THAT $M^t = 1,000$

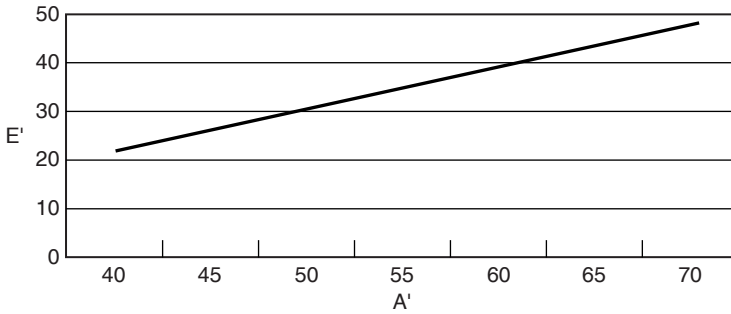
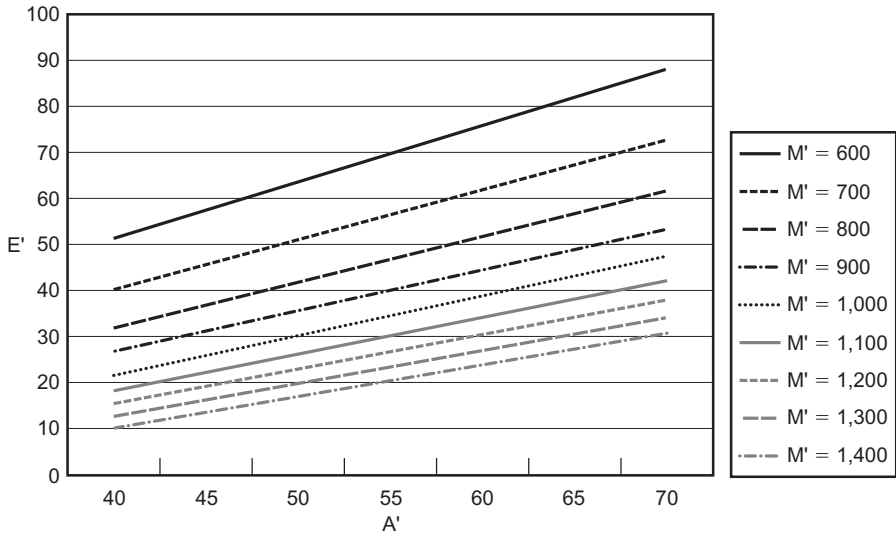

EXHIBIT 24-7

BIGCO ZERO-PROFIT CURVES, DEAL 1



(node 2). After 1M trials, we get an expected payoff of \$400.0M for Bigco and \$506.4M for Drugco. Thus, even though Bigco has a negative NPV using expected values (Exhibit 24-4), the simulation shows a positive NPV for Deal 1.

(c) To evaluate Deal 2, we solve backward the extensive form in Exhibit 24-3. This solution begins the same way as the solution for Deal 1, with an optimal strategy for Bigco for the marketing of the project. This decision occurs at Node 19. As in the decision at Node 9 for Deal A, Bigco can make this decision by comparing the NPV of marketing the product with the NPV of abandoning it. Because uncertainties about efficacy, alternative efficacy, and market size have all been resolved, the decision can be made with a simple Max statement.

Exhibit 24-8 shows the modified spreadsheet model for Deal 2. As in Exhibit 24-4, we display sample output with all variables set to their mean values. This example is illustrative, because with these inputs Bigco makes a different decision under Deal 2 than it did under Deal 1. The Max statement is given in cell G14, as a comparison of cell G12 and \$0. Here, with $A = 67$, $E = 40$, and $M = 1,000$, Bigco chooses to abandon the project. The main driver of this difference is the need to pay a \$300M milestone payment. (In Deal 1, all milestones had already been paid by this point.) Thus, we can already see that the deal structure can have an important influence on outcomes.

Once we input the max statement for Bigco's marketing decision, we are ready to evaluate Drugco's optimal strategy for the Phase III continuation decision. To do this, we follow the same steps as we did for Deal 1. Because we have seen these steps already, we will jump directly to the zero-profit curves for Drugco, shown in Exhibit 24-9.

Note that these curves are much lower than the corresponding curves for Bigco in Exhibit 24-7. The reason for this difference is that Drugco has little to lose by going to Phase III because it only needs to pay \$20M for the trials. Furthermore, FDA approval is pure upside for Drugco because at the very least they can get salvage value for the drug, and they may get much more. In contrast, in Deal 1, Bigco has to pay the full \$100M for the trials and also faces the possibility that the drug will be worthless to them even if it is approved. Taken together, these differences lead Drugco to be far more aggressive in Deal 2 than Bigco is in Deal 1. It is this power to be aggressive that makes "control" of the decision valuable to Drugco.

With the Phase III continuation strategy defined, we can compute the expected payoffs for Deal B by simulating the whole project from the very beginning (Node 2). In practice, we do this using a lookup table in Crystal Ball, just as we did for Deal 1. After 1M trials, we get an expected payoff of \$496.2M for Bigco and \$391.5M for Drugco.

(d) Using the results of parts (b) and (c), we are ready to solve for the SPNE of the game. Because it is Drugco's choice at Node 1 that determines the deal structure, we need to compare Drugco's payoffs under the two deals. Because Deal 1 gives Drugco an expected payoff of \$506.4M and Deal 2 gives Drugco an expected payoff of \$391.5M, it should choose Deal 1. This might be surprising to some readers because Deal 2 provides more control and a seemingly higher upside from the 10 percent royalty. It is dangerous to rely too much on your intuition when analyzing complex scenarios. In Deal 2, Drugco controls the Phase III continuation decision and receives generous milestones and royalties. This backloading of benefits leads to Bigco being more conservative when deciding whether to market the product—we can see an example of this conservatism by comparing Bigco's marketing decision in Exhibits 24-4 and 24-8. With this conservatism, Newdrug is in fact less likely to make it to market and earn royalties and milestones for Drugco.

To describe the SPNE of the game, we must write down the strategy at every node, regardless of whether that node is on the equilibrium path. This is difficult to do because the Phase III continuation decision is quite complex. We will revert to shorthand, relying on Max

EXHIBIT 24-8

DCF MODEL—DEAL 2

1	A	B	C	D	E	F	G	H	I	J	K	L
2	Mean					St dev		Min	Mode	Max		
3	Efficacy (E ¹)	40			40	40						
4	Alternative efficacy (A ¹)	50						40	40	70		
5	Starting market size (M ¹)	1,000			1,000	50						
6	Efficacy (E)	40			40	20						
7	Alternative efficacy (A)	67						50	50	100		
8	Starting market size (M)	1,000			1,000	100						
9	Cost sharing	0										
10	Approval milestone	300										
11	Continuation threshold	6.0										
12	Phase III?	1			Bigco NPV (if enter)		– \$68.1					
13	Approval threshold	30			Drugco NPV		\$39.7					
14	Price per unit	\$1.00			Bigco NPV (option)		\$0					
15	Royalty rate	10.00%										
16	Cost per unit	\$0.25										
17	Market share	26.5%			Total Bigco NPV		–\$226.2					
18	Market growth	6.0%			Total Drugco NPV		\$126.21					
19	Discount rate	5.00%										
20	Approved?	1										
21	Salvage value	32.39										
22							\$ in millions					
23	Year		5	6	7	8	9	10	11	12	13	14
24												
25	Market size		1,000	1,060	1,124	1,191	1,262	1,338	1,419	1,504	1,594	1,689
26	Market share		40.5%	40.5%	40.5%	40.5%	40.5%	40.5%	40.5%	40.5%	40.5%	40.5%
27	Revenue		\$405.0	\$429.3	\$455.0	\$482.3	\$511.3	\$542.0	\$574.5	\$608.9	\$645.5	\$684.2
28	Royalty		\$40.5	\$42.9	\$45.5	\$48.2	\$51.1	\$54.2	\$57.4	\$60.9	\$64.5	\$68.4
29	CGS		\$101.2	\$107.3	\$113.8	\$120.6	\$127.8	\$135.5	\$143.6	\$152.2	\$161.4	\$171.1
30	Marketing costs		\$300.0	\$318.0	\$337.1	\$357.3	\$378.7	\$401.5	\$425.6	\$451.1	\$478.2	\$506.8
31	Bigco profit		\$64.5	\$68.4	\$72.5	\$76.8	\$81.4	\$86.3	\$91.5	\$97.0	\$102.8	\$108.9
32	Drugco profit		\$40.5	\$42.9	\$45.5	\$48.2	\$51.1	\$54.2	\$57.4	\$60.9	\$64.5	\$68.4

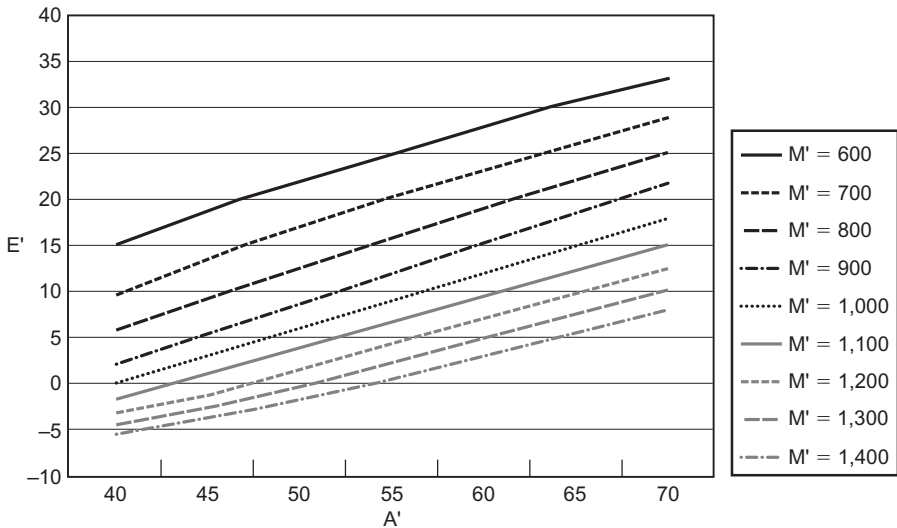
EXHIBIT 24-9**DRUGCO ZERO-PROFIT CURVES, DEAL 2**

functions in Exhibits 24-4 and 24-8 and the zero-profit lines in Exhibits 24-7 and 27-9 to simplify the description of the SPNE strategies:

Unique SPNE:

For Drugco:

At Node 1: choose Deal 1.

At Node 15: use Exhibit 24-9 to make the Phase III continuation decision.

For Bigco

At Node 5: use Exhibit 24-7 to make the Phase III continuation decision.

At Node 9: Use the Max function in cell G14 of Exhibit 24-4.

At Node 19: Use the Max function in Cell G14 of Exhibit 24-8.

Notice that the formal description of the SPNE strategies includes listings for Nodes 15 and 19, even though these nodes are never reached in equilibrium. These SPNE strategies yield expected payoffs of \$506M for Drugco and \$400M for Bigco. ■

24.2 ENERGY

In the next example, we combine Fuelco's Projects A, B, and C as originally modeled in Examples 21.1, 21.2, and 22.2, respectively. (We make a slight alteration to the

assumptions for Project C, but otherwise all the numbers are the same here as in the original examples.) The main twist is that Fuelco must complete *both* Projects A and B to have the option to complete Project C. This twist enriches and complicates the modeling.

EXAMPLE 24.2

Fuelco is considering a development project using its patented fuel-cell technology (“Project A”). If Fuelco pays \$200M to develop the technology, then they can bid for a government contract. The objective probability of winning the contract is 50 percent, and there is no beta risk for the government’s decision. If Fuelco’s bid is accepted (one year later), then they can choose to finish the project by accepting the contract (cost = \$300M), when they will earn an NPV (as of one year from now) of \$600M (not including the \$300M cost of finishing the project). If they do not receive the contract, then they can still finish the development project (cost = \$300M) but they could only receive \$200M for the project by selling it to some nongovernmental buyer (not including the \$300M cost of finishing the project). The riskfree rate is zero. (By itself, this project is identical to the project analyzed in Example 21.1.)

In addition to Project A, Fuelco is also considering a separate investment in fuel-cell technology designed to replace oil-based energy for some types of engines (“Project B”). By investing \$100M today to start the project, Fuelco would maintain the option to finish the project with a further investment (= \$200M) in one year. If oil prices are at least \$60 per barrel in one year (objective probability = 50%), then on completion of the project, Fuelco would have an NPV (as of one year from now) of \$1,000M (not including the \$200M cost of finishing the project). If oil prices are less than \$60 a barrel in one year (objective probability = 50%), then the project would not be economical for most applications and would have an NPV (one year from now) of \$300M (not including the \$200M cost of finishing the project). If Fuelco decides not to finish the project, then they can sell the technology to a competitor for \$200M, regardless of the price of oil. The beta for the project is unknown, but we do have some information about oil prices: the market price of a European binary call option (payoff = \$1) on oil with a strike price of \$60 per barrel and an expiration of 1 year is 25 cents. (By itself, this project is identical to the project analyzed in Example 21.2.)

Finally, Fuelco is also considering a consumer application for their patented fuel-cell technology (“Project C”). Project C would only be possible if Projects A and B have *already* been completed. To begin producing and marketing to the consumer market would require a new investment of \$200M, made in one year (after A and B have been completed). At the present time, Fuelco estimates that the completed project would have a present value of \$320M in one year (i.e., if Fuelco spent \$200M to initiate the project, they believe they could spin off the initiated project for \$320M). Fuelco can delay starting the project for an additional five years, during which time they expect this value of the project to fluctuate, with an annual volatility of 90 percent. Once initiated, the project is expected to generate annual cash flows equal to 10 percent of its value. Thus, if Fuelco delays the project, they will forego these cash flows. After five years, some important Fuelco patents will expire, and they will no longer have the option to profitably enter this new market. If Fuelco does not enter the market, then Project C has no salvage value. (By itself, this project is similar to the project analyzed in Example 22.2, except that the initial spin-off value is different (\$320M here versus \$400M in Example 22.2, and the riskfree interest rate here is zero.)

Problems

- (a) Draw the decision tree for Fuelco.
 (b) Assuming that Fuelco does complete Project A and B, what would be the value of the option to do Project C?
 (c) What is Fuelco optimal strategy? What is the NPV of this strategy?

Solutions

(a) The decision tree is given in several parts. First, we review the decision trees for each project separately. The tree for Project A, originally given in Exhibit 21-4, is reproduced in Exhibit 24-10; the tree for Project B, originally given in Exhibit 21-5, is reproduced in Exhibit 24-9; the tree for Project C, with the same shape but different payoffs as given in Exhibit 22-11, is reproduced in Exhibit 24-12. Last, after showing the three projects separately, Exhibit 24-13 gives a tree with a schematic version of the full decision problem, showing the decision nodes and branches for each project, with the event branches omitted.

EXHIBIT 24-10

FUELCO'S DECISION TREE (PROJECT A)

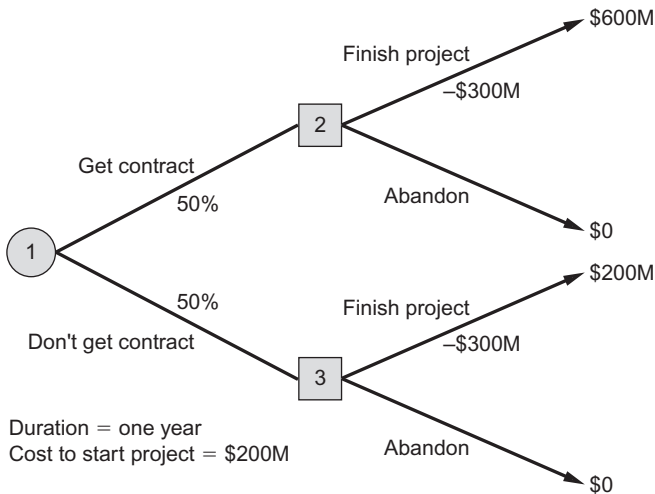

(b) To find the value of the all the projects combined, we solve backward, beginning with Project C. The valuation problem here is similar to Example 22.2, except for the difference in the initial value of the project (\$320M here) and in the riskfree rate (0 percent here). To estimate the value of the option, we use the *bin tree* spreadsheet and build an American

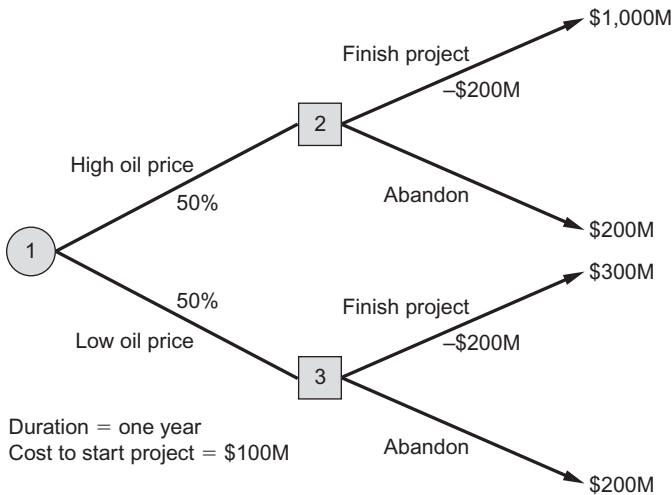
EXHIBIT 24-11**FUELCO'S DECISION TREE (PROJECT B)**

option tree with a possible exercise in every month over a five-year period. This tree is identical to the tree we built in Example 22.2, except for the small changes in the *inputs* worksheet. After making these changes, the spreadsheet gives an option value of \$180.77M. In the interest of simplifying our calculations for the rest of the problem, we round this value off to \$180M.

(c) To value the full set of projects, we need a practical way to combine the trees from Exhibits 24-10, 24-11 and 24-12. In Exhibit 24-14, we combine Projects A and B into a single tree, and we combine the risk-neutral probabilities for each type of uncertainty. For example, because Project A faces only the idiosyncratic risk of the government contract, the risk-neutral probability of getting the contract is identical to the objective probability (50 percent). In contrast, the oil prices in Project B do include some market risk. Luckily for us, the binary call option allows us to solve for the risk-neutral probabilities of 25 percent for high oil prices and 75 percent for low oil prices. (Do you remember why this is true? If you forgot, see Section 21.4 for an explanation.) Exhibit 24-14 prunes the final decisions for each project, with the extensions for these decisions shown in Exhibits 24-15, 24-16, 24-17, and 24-18. Following these exhibits, we explain the trees in more detail.

To see how Exhibit 24-14 has been pruned, we start by looking at Nodes 6 to 9. At Nodes 6 and 7, Fuelco has elected to start Project B but not Project A. Because A has not been started, it is not possible to complete both A and B, and thus Project C does not come

EXHIBIT 24-12

FUELCO'S DECISION TREE (PROJECT C)

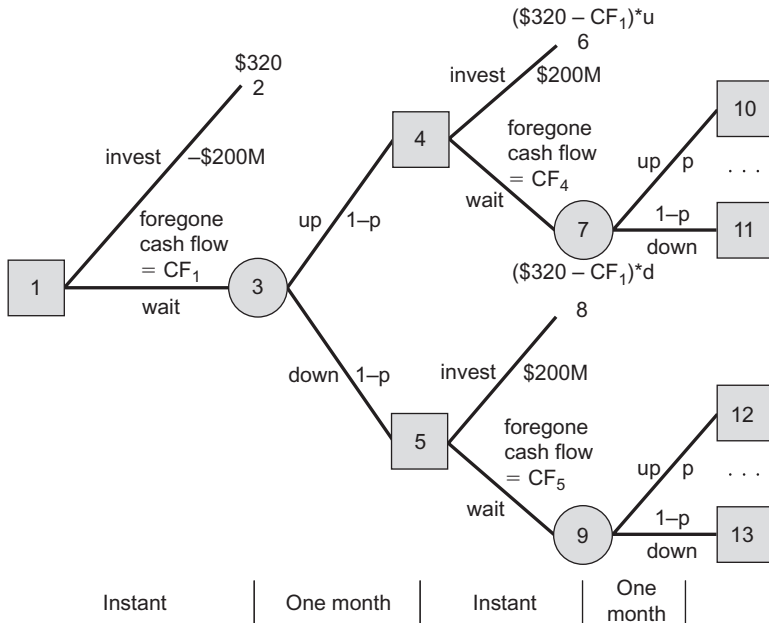

under consideration at all. Thus, Nodes 6 and 7 reduce to a straightforward analysis of Project B, which is illustrated in Exhibit 24-11. For Project B, we know it is optimal to abandon the project when oil prices are low (node 6, \$200M) and to finish the project when oil prices are high (node 7, \$1,000M - \$200M = \$800M). With risk-neutral probabilities of 0.75 for low oil prices and 0.25 for high oil prices, the NPV of the “Start A” strategy is $0.75 * 200 + 0.25 * 800 - 100 = \$250M$, which is the same answer we got in Example 21.2.

We turn next to Nodes 8 and 9, where Fuelco has elected to start Project A but not Project B. Here, as in the previous case, Project C is not possible, because it is not possible to complete both A and B. Thus, we have a straightforward analysis of Project A, which is illustrated in Exhibit 24-10. For Project A, we know it is optimal to finish the project if Fuelco gets the contract (node 8, \$600M - \$300M = \$300M) and to abandon the project if they don't (node 9, \$0). With risk-neutral probabilities of 0.50 for getting the contract and 0.50 for not getting the contract, the NPV of the “Start B” strategy is $0.50 * 300 + 0.50 * 0 - 200 = -\$50M$, which is the same answer we got in Example 21.1.

The problem grows more complex when we analyze the “Start both” branch, which leads to terminal nodes at 10, 11, 12, and 13. To aid in this analysis, Exhibits 24-15 through

EXHIBIT 24-13

FUELCO'S DECISION TREE, SCHEMATIC (ALL PROJECTS)

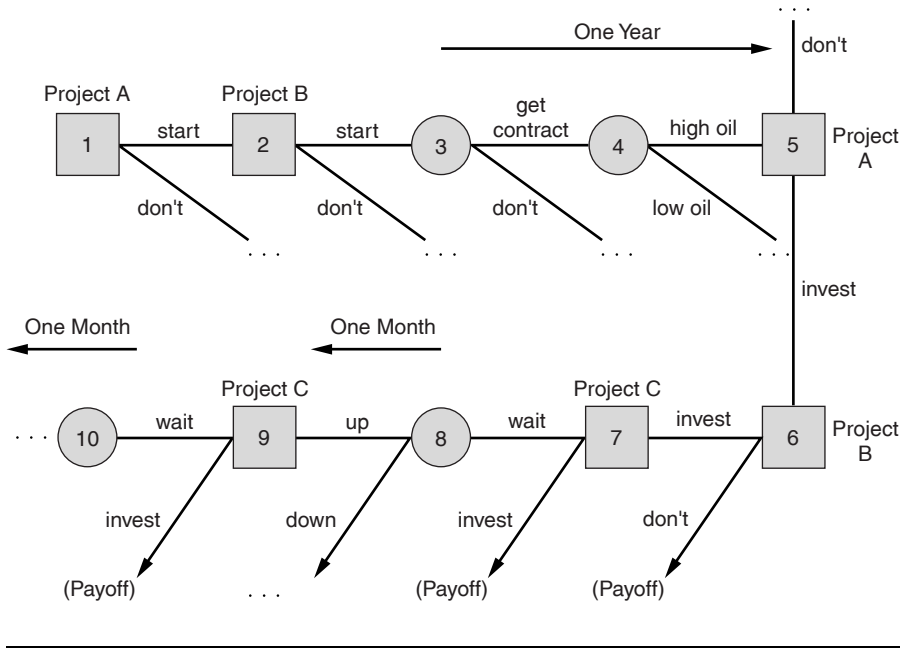

24-18 show the payoffs in each of these extensions. Consider the payoffs in Exhibit 24-15, which corresponds to Node 10. At this node, Fuelco has chosen “start both”, and the uncertainty has resolved to give Fuelco the contract but with low oil prices. The risk-neutral probability of this branch is equal to the product of the risk-neutral probabilities for “low oil price” (75 percent) and “get contract” (50 percent). This product is equal to 0.375. Once node 10 is reached, Fuelco has four possible choices, representing the yes/no decision for finishing both projects. The terminal nodes in Exhibit 24-15 show the payoffs from each of these choices. These payoffs come directly from Exhibits 24-10 and 24-11, with one important exception: if Fuelco chooses to finish both projects, then it receives a “bonus” equal to the NPV of Project C (= \$180 M). Indeed, this bonus—only possible when both A and B have been completed—makes “finish both” the optimal decision. This optimal decision is circled in Exhibit 25-15, with the payoff of \$580 M shown for Node 10 in the pruned tree of Exhibit 24-14.

The payoffs at Nodes 11, 12, and 13 are computed using the same method. For Node 11, Exhibit 24-16 indicates that the optimal strategy is “finish neither”, with a payoff of \$200M. At nodes 11 and 12, the respective Exhibits 24-17 and 24-18 indicate that “finish both” is the optimal strategy. Once we include the payoffs from these strategies into Exhibit 24-14, we are ready to compute the expected payoff for the “start both” branch as

EXHIBIT 24-14

FUELCO'S DECISION TREE, PRUNED (ALL PROJECTS), WITH RISK-NEUTRAL PROBABILITIES

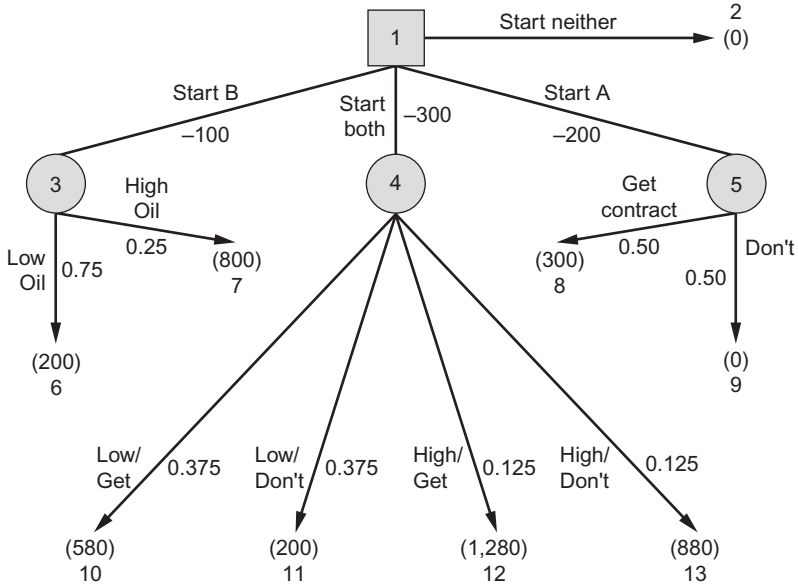

$$\begin{aligned} \text{Expected payoff of "start both" branch} &= 0.375 * 580 \\ &+ 0.375 * 200 + 0.125 * 1,280 + 0.125 * 880 - 300 = \$262.5\text{M}. \end{aligned} \quad (24.2)$$

This payoff is higher than the \$250M payoff for “start B”, the $-\$50\text{M}$ expected payoff for “start A”, and the \$0 payoff from “start neither”. Thus, Fuelco’s optimal strategy for all projects is

1. Start Projects A and B.
2. If “low oil” + “don’t get contract” then abandon both projects, otherwise finish both.
3. Follow the optimal strategy of the binomial tree for Project C.

The NPV of this strategy is \$262.5M. Note that the optimal strategies for Projects A and B have been significantly altered by the presence of Project C. Indeed, when we considered A and B in isolation, we always abandoned these projects in the “low oil” or “don’t get contract” states. The option to invest in Project C has changed the optimal investment strategy on other projects and given Fuelco a reason to pursue those projects

EXHIBIT 24-15

NODE 10, EXPANDED

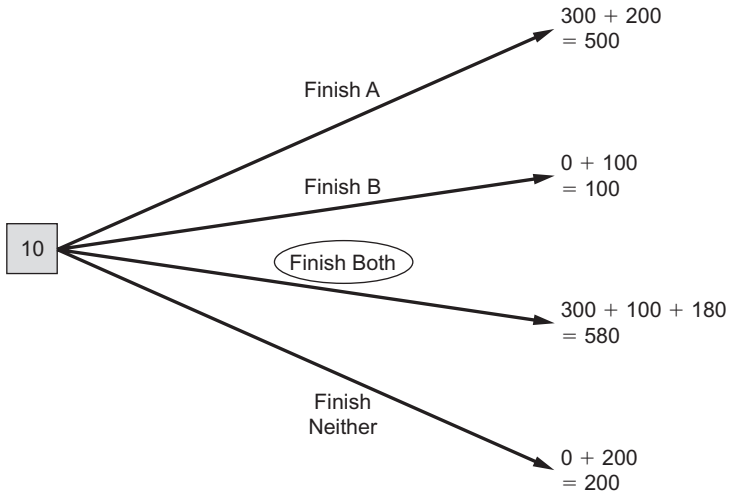

EXHIBIT 24-16

NODE 11, EXPANDED

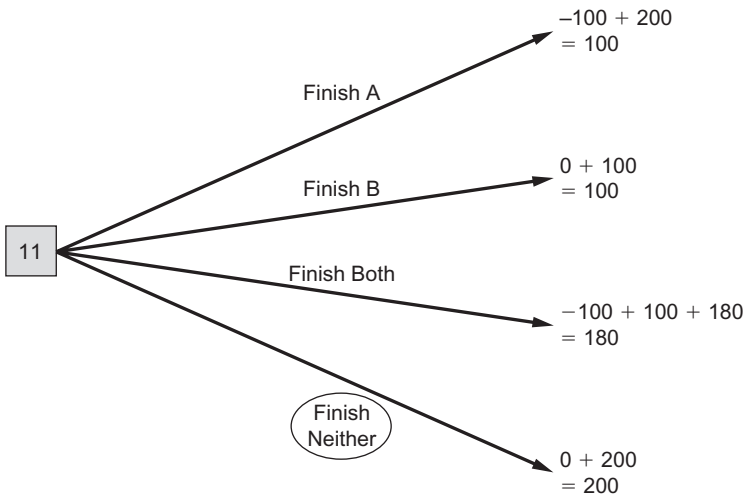
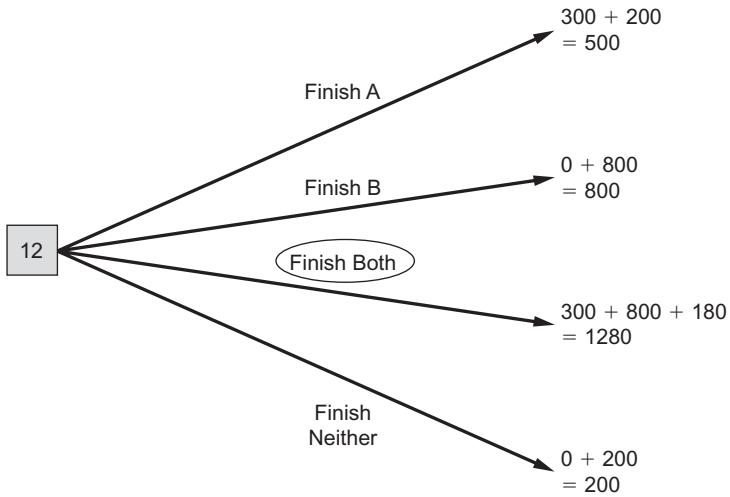
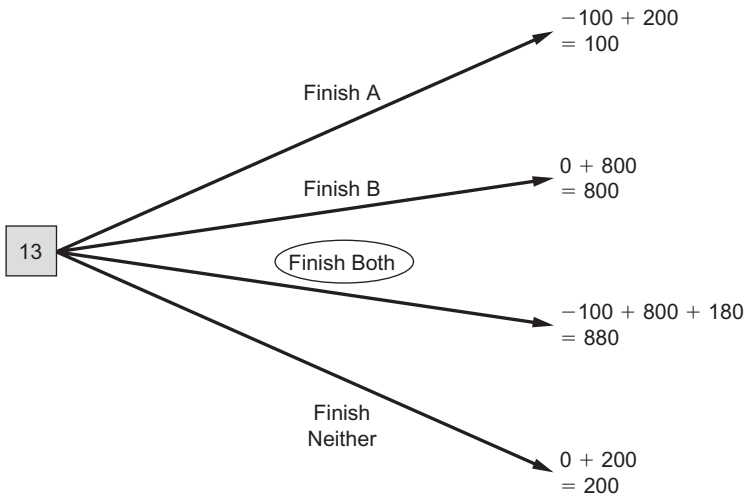

EXHIBIT 24-17*NODE 12, EXPANDED***EXHIBIT 24-18***NODE 13, EXPANDED*

mainly for the technological flexibility for a later project. Although this is an abstract example, it is illustrative of the kind of strategic thinking that is necessary in R&D investment. ■

24.3 THE FOREST AND THE TREES

Part IV has been all about trees. We learned about event trees in Chapter 20, decision trees in Chapter 21, binomial trees in Chapter 22, and game trees in Chapter 23. In this chapter, we put all these trees together to solve some complex examples. In the midst of all these trees, it is easy to lose sight of the forest. R&D investing is a highly uncertain endeavor. In our examples, we pretended to know a lot of things that are essentially unknowable: starting values for projects, objective probabilities, volatilities—all these things are guesses. Given all this uncertainty, why do we bother? We do it because it is by modeling things carefully that we force rigor into our thought process. In Example 24.1, this rigor allowed us to see why “control” might not be worth its costs, because giving too much power to Drugco at one stage can lead Bigco to grow very conservative at another. These are fundamental insights about the strategic situation, insights that transcend the specific numbers used in the example. Similarly, the Fuelco problem in Example 24.2—although very unrealistic in the specifics—is illustrative of the interconnections across R&D projects. Many managers have a natural intuition for real options and the value of flexibility. By running through a few models, we can begin to quantify and sharpen this intuition.

Although we have applied the models in Part IV to general R&D investment—rather than to venture capital—the insights of these models can readily be applied to VC investment. Because VC firms are lean organizations staffed mostly by generalists, most do not have the capabilities (or time) to perform this kind of analysis. The flexible spreadsheets included with this book can help to bridge this gap. In all these cases, it is important to remember the big picture, even when paying close attention to the details. We must not lose sight of the forest because we are staring at the trees.

SUMMARY

In this chapter, we pulled together the various methods studied in Part IV. We use these methods to analyze complex investment problems for Drugco and Fuelco. The framework of these problems was first introduced in Chapter 19, with the building blocks for the solutions covered in Chapter 20 (event trees and Monte Carlo analysis), Chapter 21 (decision trees and real options), Chapter 22 (binomial trees), and Chapter 23 (game trees and game theory).

The main value of working through solutions to these problems is in the process itself; by providing structure to the decision problem, the analyst can quantify his intuition and gain a deeper understanding of the strategic nuances of the situation. Although such deep study

can reap great rewards, it is dangerous to rely exclusively on the model answers. The most successful investors are those who ride their visions using a structured investment discipline.

REFERENCES

Walkenbach, John, 2003, *Excel 2003 Bible*, Wiley, Indianapolis, IN.

EXERCISES

24.1 Use the same setup as in Example 24.1. Suppose that Bigco offers Drugco a third option, Deal 3. In Deal 3, Bigco retains full control and pays all costs (just like Deal 1), with one change: instead of paying a \$150M milestone for Phase III continuation, Bigco would pay a \$400M milestone if they decide to market Newdrug.

- (a) Draw the extensive form for Deal 3.
- (b) Suppose that Drugco decides to take Deal 3. What is the optimal strategy for Bigco following the Phase III trials? What is the optimal strategy for Bigco following the Phase II trials? Assuming that Bigco chooses these strategies, what are the expected payoffs to Drugco and Bigco?
- (c) Given the choice of Deals 1, 2, and 3, which should Drugco choose?

24.2 Use the same setup as in Example 24.2.

- (a) Suppose that the starting value for Project C is \$400M. How does that change your answers to parts (b) and (c)?
- (b) Suppose that the starting value for Project C is \$200M. How does that change your answer to parts (b) and (c)?

24.3 Suppose that EBV is considering an equity investment in Drugco to coincide with the signing of a strategic alliance (Deal 1 from Example 24.1) with Bigco. What suggestions would you give to EBV of how to think about this investment?

24.4 *True, False or Uncertain:* A deep understanding of finance can help someone make better venture capital and R&D investment decisions.

SAMPLE TERM SHEET

THIS IS a public-domain document from the website of the National Venture Capital Association. The version in this appendix was last updated in April 2009.

This sample document is the work product of a coalition of attorneys who specialize in venture capital financings, working under the auspices of the NVCA. See the NVCA website for a list of the Working Group members. This document is intended to serve as a starting point only, and should be tailored to meet your specific requirements. This document should not be construed as legal advice for any particular facts or circumstances. Note that this sample presents an array of (often mutually exclusive) options with respect to particular deal provisions.

PRELIMINARY NOTES

This term sheet maps to the NVCA Model Documents, and for convenience the provisions are grouped according to the particular Model Document in which they may be found. Although this term sheet is perhaps somewhat longer than a “typical” VC Term Sheet, the aim is to provide a level of detail that makes the term sheet useful as both a road map for the document drafters and as a reference source for the business people to quickly find deal terms without the necessity of having to consult the legal documents (assuming of course there have been no changes to the material deal terms prior to execution of the final documents).

TERM SHEET
FOR SERIES A PREFERRED STOCK FINANCING OF
[INSERT COMPANY NAME], INC.
[__ __, 200__]

This Term Sheet summarizes the principal terms of the Series A Preferred Stock Financing of [____], Inc., a [Delaware] corporation (the “**Company**”). In consideration of the time and expense devoted and to be devoted by the Investors with respect to this investment, the No Shop/Confidentiality [and Counsel and Expenses] provisions of this Term Sheet shall be binding obligations of the Company whether or not the financing is consummated. No other legally binding obligations will be created until definitive agreements are executed and delivered by all parties. This Term Sheet is not a commitment to invest, and is conditioned on the completion of due diligence, legal review and documentation that is satisfactory to the Investors. This Term Sheet shall be governed in all respects by the laws of the [State of Delaware], and does not constitute an offer to sell or a solicitation of an offer to buy securities in any state where the offer or sale is not permitted.

Offering Terms

Closing Date: As soon as practicable following the Company’s acceptance of this Term Sheet and satisfaction of the Conditions to Closing (the “**Closing**”). [*provide for multiple closings if applicable*]

Investors: Investor No. 1: [____] shares ([__]%),
 \$[____]
 Investor No. 2: [____] shares ([__]%),
 \$[____]
 [as well other investors mutually agreed upon by
 Investors and the Company]

Amount Raised: \$[____], [including \$[____] from the conversion of principal [and interest] on bridge notes].¹

Price Per Share: \$[____] per share (based on the capitalization of the Company set forth below) (the “**Original Purchase Price**”).

¹Modify this provision to account for staged investments or investments dependent on the achievement of milestones by the Company.

Pre-Money Valuation: The Original Purchase Price is based upon a fully-diluted pre-money valuation of \$[_____] and a fully-diluted post-money valuation of \$[_____] (including an employee pool representing [__]% of the fully-diluted post-money capitalization).

Capitalization: The Company’s capital structure before and after the Closing is set forth on Exhibit A.

EXHIBIT A

PRE- AND POST-FINANCING CAPITALIZATION

Security	Pre-Financing		Post-Financing	
	# of Shares	%	# of Shares	%
Common – Founders				
Common – Employee Stock Pool				
Issued				
Unissued				
[Common – Warrants]				
Series A Preferred				
Total				

CHARTER²

Dividends: [Alternative 1: Dividends will be paid on the Series A Preferred only on an as-converted basis when, as, and if paid on the Common Stock.]

[Alternative 2: The Series A Preferred will accrue dividends at the rate of [__]% per annum[, payable only when and if declared by the Board] [or upon a liquidation or redemption.] For any other dividends or distributions, participation with Common Stock on an as-converted basis.]³

²The Charter is a public document, filed with the [Delaware] Secretary of State, which establishes all of the rights, preferences, privileges and restrictions of the Preferred Stock.

³In some cases, accrued and unpaid dividends are payable on conversion as well as upon a liquidation event. Most typically, however, dividends are not paid if the preferred is converted. Another alternative is to give the Company the option to pay accrued and unpaid dividends in cash or in common shares valued at fair market value. The latter are referred to as “PIK” (payment-in-kind) dividends.

Liquidation Preference:

In the event of any liquidation, dissolution or winding up of the Company, the proceeds shall be paid as follows:

[Alternative 1 (non-participating Preferred Stock): First pay the greater of (i) [one] times the Original Purchase Price [plus accrued dividends] [plus declared and unpaid dividends] on each share of Series A Preferred or (ii) such amount as would have been payable had all shares of Preferred Stock been converted to Common Stock on each share of Series A Preferred. The balance of any proceeds shall be distributed pro rata to holders of Common Stock.]

[Alternative 2 (full participating Preferred Stock): First pay [one] times the Original Purchase Price [plus accrued dividends] [plus declared and unpaid dividends] on each share of Series A Preferred. Thereafter, the Series A Preferred participates with the Common Stock pro rata on an as-converted basis.]

[Alternative 3 (cap on Preferred Stock participation rights): First pay [one] times the Original Purchase Price [plus accrued dividends] [plus declared and unpaid dividends] on each share of Series A Preferred. Thereafter, Series A Preferred participates with Common Stock pro rata on an as-converted basis until the holders of Series A Preferred receive an aggregate of [_____] times the Original Purchase Price per share, at which point each holder of Series A Preferred is entitled to receive the greater of (i) that amount per share or (ii) the amount such holder would receive if all shares of Series A Preferred Stock had been converted to Common Stock immediately prior to such liquidation.]

A merger or consolidation (other than one in which stockholders of the Company own a majority by voting power of the outstanding shares of the surviving or acquiring corporation) and a sale, lease, transfer, exclusive license or other disposition of all or substantially all of the assets of the Company will be treated as a liquidation event (a “**Deemed Liquidation Event**”), thereby triggering payment of the liquidation preferences described above [unless the holders of [_____] % of the Series A Preferred elect otherwise].

[Investors' entitlement to their liquidation preference shall not be abrogated or diminished in event part of consideration is subject to escrow in connection with a Deemed Liquidation Event.]⁴

Voting Rights:

The Series A Preferred Stock shall vote together with the Common Stock on an as-converted basis, and not as a separate class, except (i) the Series A Preferred as a class shall be entitled to elect [_____] [()] members of the Board (the “**Series A Directors**”), and (ii) as required by law. The Company's Certificate of Incorporation will provide that the number of authorized shares of Common Stock may be increased or decreased with the approval of a majority of the Preferred and Common Stock, voting together as a single class, and without a separate class vote by the Common Stock, irrespective of the provisions of Section 242(b)(2) of the Delaware General Corporation Law.⁵

Protective Provisions:

[So long as [*insert fixed number, or %, or “any”*] shares of Series A Preferred are outstanding,] in addition to any other vote or approval required under the Company's Charter or By-laws, the Company will not, without the written consent of the holders of at least [__]% of the Company's Series A Preferred, either directly or indirectly by amendment, merger, consolidation, or otherwise:

(i) liquidate, dissolve or wind-up the business and affairs of the Company, or effect any Deemed Liquidation Event or consent to any of the foregoing; (ii) amend, alter, or repeal any provision of the Certificate

⁴When a portion of the merger consideration is placed in escrow to secure a company's indemnification obligations to an acquirer, the company's stockholders will need to address how the deductions from the merger consideration used to fund the escrow are to be allocated among themselves. Today most charters are silent on the subject of escrow allocations, and the parties simply work it out at the time of the M&A event. However, this provision is intended to cause the parties to at least consider these issues at the time of the initial investment. Today, the more common approach is simply to allocate the acquisition escrow pro rata among all stockholders. Section 2.3.4 of the NVCA Model Charter provides for the alternative approach, namely, allocation of the escrow in a manner that ensures that the Preferred Stock holders always receive their liquidation preference, even if some or all of the escrow is forfeited. See fn. 25 to the NVCA Model Charter for examples and a more detailed explanation.

⁵For California corporations, one cannot “opt out” of the statutory requirement of a separate class vote by Common Stockholders to authorize shares of Common Stock.

of Incorporation or Bylaws [in a manner adverse to the Series A Preferred];⁶ (iii) create or authorize the creation of [or issue or obligate itself to issue shares of,] any other security convertible into or exercisable for any equity security, having rights, preferences or privileges senior to or on parity with the Series A Preferred, or increase the authorized number of shares of Series A Preferred or of any additional class or series of capital stock [unless it ranks junior to the Series A Preferred]; (iv) reclassify, alter or amend any existing security that is junior to or on parity with the Series A Preferred, if such reclassification, alteration or amendment would render such other security senior to or on parity with the Series A Preferred; (v) purchase or redeem or pay any dividend on any capital stock prior to the Series A Preferred, [other than stock repurchased from former employees or consultants in connection with the cessation of their employment/services, at the lower of fair market value or cost;] [other than as approved by the Board, including the approval of [_____] Series A Director(s)]; (vi) create or authorize the creation of any debt security [if the Company's aggregate indebtedness would exceed \$[_____] [other than equipment leases or bank lines of credit] unless such debt security has received the prior approval of the Board of Directors, including the approval of [_____] Series A Director(s)]; (vii) create or hold capital stock in any subsidiary that is not a wholly-owned subsidiary or dispose of any subsidiary stock or all or substantially all of any subsidiary assets; or (viii) increase or decrease the size of the Board of Directors].

Optional Conversion:

The Series A Preferred initially converts 1:1 to Common Stock at any time at option of holder, subject to adjustments for stock dividends, splits, combinations and similar events and as described below under "Anti-dilution Provisions".

⁶Note that as a matter of background law, Section 242(b)(2) of the Delaware General Corporation Law provides that if any proposed charter amendment would adversely alter the rights, preferences and powers of one series of Preferred Stock, but not similarly adversely alter the entire class of all Preferred Stock, then the holders of the impacted series are entitled to a separate series vote on the amendment.

Anti-dilution Provisions: In the event that the Company issues additional securities at a purchase price less than the current Series A Preferred conversion price, such conversion price shall be adjusted in accordance with the following formula:

[*Alternative 1: “Typical” weighted average:*

$$CP_2 = CP_1 * (A + B)/(A + C)$$

CP_2 = Series A Conversion Price in effect immediately after new issue

CP_1 = Series A Conversion Price in effect immediately prior to new issue

A = Number of shares of Common Stock deemed to be outstanding immediately prior to new issue (includes all shares of outstanding common stock, all shares of outstanding preferred stock on an as-converted basis, and all outstanding options on an as-exercised basis; and does not include any convertible securities converting into this round of financing)

B = Aggregate consideration received by the Corporation with respect to the new issue divided by CP_1

C = Number of shares of stock issued in the subject transaction]

[*Alternative 2: Full-ratchet—the conversion price will be reduced to the price at which the new shares are issued.*]

[*Alternative 3: No price-based anti-dilution protection.*]

The following issuances shall not trigger anti-dilution adjustment:⁷

- (i) securities issuable upon conversion of any of the Series A Preferred, or as a dividend or distribution on the Series A Preferred; (ii) securities issued upon the conversion of any debenture, warrant, option, or other convertible security; (iii) Common Stock issuable upon a stock split, stock dividend, or any subdivision of shares of Common Stock; and (iv) shares of Common Stock (or options to purchase

⁷Note that additional exclusions are frequently negotiated, such as issuances in connection with equipment leasing and commercial borrowing. See additional exclusions defined as “Exempted Securities” in Section 4.4.1 of the NVCA Model Charter.

such shares of Common Stock) issued or issuable to employees or directors of, or consultants to, the Company pursuant to any plan approved by the Company's Board of Directors [including at least [_____] Series A Director(s)] [(v) shares of Common Stock issued or issuable to banks, equipment lessors or other financial institutions, or to real property lessors, pursuant to a debt financing, equipment leasing or real property leasing transaction approved by the Board of Directors of the Corporation [, including at least [_____] Series A Director(s)].

Mandatory Conversion:

Each share of Series A Preferred will automatically be converted into Common Stock at the then applicable conversion rate in the event of the closing of a [firm commitment] underwritten public offering with a price of [___] times the Original Purchase Price (subject to adjustments for stock dividends, splits, combinations and similar events) and [net/gross] proceeds to the Company of not less than \$[_____] (a "QPO"), or (ii) upon the written consent of the holders of [___]% of the Series A Preferred.⁸

Pay-to-Play:

[Unless the holders of [___]% of the Series A elect otherwise,] on any subsequent down round all [Major] Investors are required to participate to the full extent of their participation rights (as described below under "Investor Rights Agreement – Right to Participate Pro Rata in Future Rounds"), unless the participation requirement is waived for all [Major] Investors by the Board [(including the vote of [a majority of] the Series A Director[s])].

[Alternative 1: [Each share] [applicable portion of the shares]⁹ of Series A Preferred of any [Major] Investor failing to do so will automatically convert to

⁸The per share test ensures that the investor achieves a significant return on investment before the Company can go public. Also consider allowing a non-QPO to become a QPO if an adjustment is made to the Conversion Price for the benefit of the investor, so that the investor does not have the power to block a public offering.

⁹The second formulation serves to have the consequences of the pay-to-play provisions apply on a proportionate basis (e.g., if Investor plays for ½ of pro rata share, then only ½ of the Investor's Preferred converts to common, or does not receive anti dilution adjustment, etc., as applicable).

Common Stock and lose the right to a Board seat if applicable.]

[Alternative 2: [Each share] [applicable portion of the shares] of any [Major] Investor failing to do so will automatically [lose anti-dilution rights] [lose right to participate in future rounds].]¹⁰

*Redemption Rights:*¹¹

The Series A Preferred shall be redeemable from funds legally available for distribution at the option of holders of at least [__]% of the Series A Preferred commencing any time after [_____] at a price equal to the Original Purchase Price [plus all accrued but unpaid dividends]. Redemption shall occur in three equal annual portions. Upon a redemption request from the holders of the required percentage of the Series A Preferred, all Series A Preferred shares shall be redeemed [(except for any Series A holders who affirmatively opt-out)].¹²

STOCK PURCHASE AGREEMENT

Representations and Warranties:

Standard representations and warranties by the Company. [Representations and warranties by Founders

¹⁰If the punishment for failure to participate is losing some but not all rights of the Preferred (e.g., anything other than a forced conversion to common), the Charter will need to have so-called “blank check preferred” provisions at least to the extent necessary to enable the Board to issue a “shadow” class of preferred with diminished rights in the event an investor fails to participate. Note that as a drafting matter it is far easier to simply have (some or all of) the preferred convert to common.

¹¹Redemption rights allow Investors to force the Company to redeem their shares at cost [plus a small guaranteed rate of return (e.g., dividends)]. In practice, redemption rights are not often used; however, they do provide a form of exit and some possible leverage over the Company. While it is possible that the right to receive dividends on redemption could give rise to a Code Section 305 “deemed dividend” problem, many tax practitioners take the view that if the liquidation preference provisions in the Charter are drafted to provide that, on conversion, the holder receives the greater of its liquidation preference or its as-converted amount (as provided in the NVCA Model Charter), then there is no Section 305 issue.

¹²Due to statutory restrictions, it is unlikely that the Company will be legally permitted to redeem in the very circumstances where investors most want it (the so-called “sideways situation”), investors will sometimes request that certain penalty provisions take effect where redemption has been requested but the Company’s available cash flow does not permit such redemption—e.g., the redemption amount shall be paid in the form of a one-year note to each unredeemed holder of Series A Preferred, and the holders of a majority of the Series A Preferred shall be entitled to elect a majority of the Company’s Board of Directors until such amounts are paid in full.

[regarding technology ownership, conflicting agreements, litigation etc.].¹³

Conditions to Closing:

Standard conditions to Closing, which shall include, among other things, satisfactory completion of financial and legal due diligence, qualification of the shares under applicable Blue Sky laws, the filing of a Certificate of Incorporation establishing the rights and preferences of the Series A Preferred, and an opinion of counsel to the Company.

Counsel and Expenses:

[Investor/Company] counsel to draft closing documents. Company to pay all legal and administrative costs of the financing [at Closing], including reasonable fees and expenses, in an amount not to exceed [____], of Investor counsel [, unless the transaction is not completed because the Investors withdraw their commitment without cause].¹⁴

Company Counsel: [_____

 _____]

Investor Counsel: [_____

 _____]

INVESTOR RIGHTS AGREEMENT

Registration Rights:

Registrable Securities:

All shares of Common Stock issuable upon conversion of the Series A Preferred and any other

¹³Founders' representations are controversial and may elicit significant resistance. They are more common in the Northeast and counsel should be warned that they may not be well received elsewhere. They are more likely to appear if Founders are receiving liquidity from the transaction or if there is heightened concern over intellectual property (e.g., the Company is a spin-out from an academic institution or the Founder was formerly with another Company whose business could be deemed competitive with the Company). Founders' representations are not common in subsequent rounds, even in the Northeast, where risk is viewed as significantly diminished and fairly shared by the investors rather than being disproportionately borne by the Founders.

¹⁴The bracketed text should be deleted if this section is not designated in the introductory paragraph as one of the sections that is binding upon the Company regardless of whether the financing is consummated.

- Demand Registration:* Common Stock held by the Investors will be deemed “**Registrable Securities**”.¹⁵ Upon earliest of (i) [three-five] years after the Closing; or (ii) [six] months following an initial public offering (“**IPO**”), persons holding [__]% of the Registrable Securities may request [one][two] (consummated) registrations by the Company of their shares. The aggregate offering price for such registration may not be less than \$[5-15] million. A registration will count for this purpose only if (i) all Registrable Securities requested to be registered are registered and (ii) it is closed, or withdrawn at the request of the Investors (other than as a result of a material adverse change to the Company).
- Registration on Form S-3:* The holders of [10–30]% of the Registrable Securities will have the right to require the Company to register on Form S-3, if available for use by the Company, Registrable Securities for an aggregate offering price of at least \$[1–5 million]. There will be no limit on the aggregate number of such Form S-3 registrations, provided that there are no more than [two] per year.
- Piggyback Registration:* The holders of Registrable Securities will be entitled to “piggyback” registration rights on all registration statements of the Company, subject to the right, however, of the Company and its underwriters to reduce the number of shares proposed to be registered to a minimum of [20–30]% on a pro rata basis and to complete reduction on an IPO at the underwriter’s discretion. In all events, the shares to be registered by holders of Registrable Securities will be reduced only after all other stockholders’ shares are reduced.
- Expenses:* The registration expenses (exclusive of stock transfer taxes, underwriting discounts and commissions) will be borne by the Company. The Company will also pay the reasonable fees and expenses [not to exceed \$_____] of one special counsel to represent all the participating stockholders.

¹⁵Note that Founders/management sometimes also seek limited registration rights.

Lock-up:

Investors shall agree in connection with the IPO, if requested by the managing underwriter, not to sell or transfer any shares of Common Stock of the Company [(including/excluding shares acquired in or following the IPO)] for a period of up to [180] days¹⁶ following the IPO subject to extension to facilitate compliance with FINRA rules (provided all directors and officers of the Company [and [1–5]% stockholders] agree to the same lock-up). [Such lock-up agreement shall provide that any discretionary waiver or termination of the restrictions of such agreements by the Company or representatives of the underwriters shall apply to Investors, pro rata, based on the number of shares held.]

Management and Information Rights:

A Management Rights letter from the Company, in a form reasonably acceptable to the Investors, will be delivered prior to Closing to each Investor that requests one.¹⁷

Any [Major] Investor [(who is not a competitor)] will be granted access to Company facilities and personnel during normal business hours and with reasonable advance notification. The Company will deliver to such Major Investor (i) annual, quarterly, [and monthly] financial statements, and other information as determined by the Board; (ii) thirty days prior to the end of each fiscal year, a comprehensive operating budget forecasting the Company's revenues, expenses, and cash position on a month-to-month basis for the upcoming fiscal year[; and (iii) promptly following the end of each quarter an up-to-date capitalization table]. A “**Major Investor**” means any Investor who purchases at least \$[_____] of Series A Preferred.

Right to Maintain Proportionate Ownership:

All [Major] Investors shall have a pro rata right, based on their percentage equity ownership in the Company [(assuming the conversion of all outstanding Preferred

¹⁶See commentary in fn. 23 and 24 of the NVCA Model Investor Rights Agreement regarding possible extensions of lock-up period.

¹⁷See commentary in introduction to NVCA Model Managements Rights Letter, explaining purpose of such letter.

Stock into Common Stock and the exercise of all options outstanding under the Company's stock plans)]¹⁸, to participate in subsequent issuances of equity securities of the Company (excluding those issuances listed at the end of the "Anti-dilution Provisions" section of this Term Sheet. In addition, should any [Major] Investor choose not to purchase its full pro rata share, the remaining [Major] Investors shall have the right to purchase the remaining pro rata shares.

*Matters Requiring Investor Director Approval:*¹⁹

So long as the holders of Series A Preferred are entitled to elect a Series A Director, the Company will not, without Board approval, which approval must include the affirmative vote of [one/both] of the Series A Director(s):

(i) make any loan or advance to, or own any stock or other securities of, any subsidiary or other corporation, partnership, or other entity unless it is wholly owned by the Company; (ii) make any loan or advance to any person, including, any employee or director, except advances and similar expenditures in the ordinary course of business or under the terms of a employee stock or option plan approved by the Board of Directors; (iii) guarantee any indebtedness except for trade accounts of the Company or any subsidiary arising in the ordinary course of business; (iv) make any investment inconsistent with any investment policy approved by the Board; (v) incur any aggregate indebtedness in excess of \$[_____] that is not already included in a Board-approved budget, other than trade credit incurred in the ordinary course of business; (vi) enter into or be a party to any transaction with any director,

¹⁸See commentary in fn. 40 of the NVCA Model Investor Rights Agreement regarding possible variations on the calculation of pro-rata rights.

¹⁹Founders will often resist having specified corporate acts subject to approval by the investors' Board designee(s). On the other hand, some investors won't go forward without this provision. An alternative is to move items from this list to the "protective provisions" of the charter, where they would require a Preferred stockholder vote. If the investor insists on such provisions, the Company generally would find the director approval approach preferable, as the director representative on the Board has a fiduciary duty to the corporation when acting in the capacity of a director. Other formulations could be: requiring the vote of a supermajority of the Board, or a majority of the non-management directors.

officer or employee of the Company or any “associate” (as defined in Rule 12b-2 promulgated under the Exchange Act) of any such person [except transactions resulting in payments to or by the Company in an amount less than \$[60,000] per year], [or transactions made in the ordinary course of business and pursuant to reasonable requirements of the Company’s business and upon fair and reasonable terms that are approved by a majority of the Board of Directors];²⁰ (vii) hire, fire, or change the compensation of the executive officers, including approving any option grants; (viii) change the principal business of the Company, enter new lines of business, or exit the current line of business; (ix) sell, assign, license, pledge or encumber material technology or intellectual property, other than licenses granted in the ordinary course of business; or (x) enter into any corporate strategic relationship involving the payment contribution or assignment by the Company or to the Company of assets greater than [\$100,000.00].]

*Non-Competition and Non-Solicitation and Agreements:*²¹

Each Founder and key employee will enter into a [one] year non-competition and non-solicitation agreement in a form reasonably acceptable to the Investors.

Non-Disclosure and Developments Agreement:

Each current and former Founder, employee and consultant will enter into a non-disclosure and proprietary rights assignment agreement in a form reasonably acceptable to the Investors.

Board Matters:

[Each non-employee director shall be entitled in such person’s discretion to be a member of any Board committee.]

²⁰Note that Section 402 of the Sarbanes-Oxley Act of 2003 would require repayment of any loans in full prior to the Company filing a registration statement for an IPO.

²¹Non-compete restrictions are a matter of state law, and you need to investigate the relevant law in the state where the employee works (e.g., permissible temporal and geographic scope, what constitutes adequate consideration). In California, other than in connection with the sale of a business, they are prohibited.

The Board of Directors shall meet at least [monthly] [quarterly], unless otherwise agreed by a vote of the majority of Directors.

The Company will bind D&O insurance with a carrier and in an amount satisfactory to the Board of Directors. Company shall agree that its indemnification obligations to Series A Directors are primary, and obligations of affiliated Investors are secondary.²² In the event the Company merges with another entity and is not the surviving corporation, or transfers all of its assets, proper provisions shall be made so that successors of the Company assume the Company's obligations with respect to indemnification of Directors.

Employee Stock Options:

All employee options to vest as follows: [25% after one year, with remaining vesting monthly over next 36 months].

[Immediately prior to the Series A Preferred Stock investment, [_____] shares will be added to the option pool creating an unallocated option pool of [_____] shares.]

Key Person Insurance:

Company to acquire life insurance on Founders [*name each Founder*] in an amount satisfactory to the Board. Proceeds payable to the Company.

RIGHT OF FIRST REFUSAL/CO-SALE AGREEMENT

*Right of first Refusal/
Right of Co-Sale
(Take-me-Along):*

Company first and Investors second (to the extent assigned by the Board of Directors,) have a right of first refusal with respect to any shares of capital stock of the Company proposed to be sold by Founders [and current and future employees or consultants

²²A 2007 Delaware Chancery Court decision held that an investment fund that itself indemnified its partner who served on a portfolio company board was a co-indemnitor with the portfolio company and, therefore, the investor director was not entitled to recover from the portfolio company the full amount of any payments advanced by the portfolio company on behalf of the investor director. Following that decision, investors will insist on provisions such as the one here, as a provision in the Investor Rights Agreement and/or as part of a separate Indemnification Agreement (see NVCA Model Indemnification Agreement).

holding greater than [1]% of Company Common Stock (assuming conversion of Preferred Stock and whether then held or subject to the exercise of options)], with a right of oversubscription for Investors of shares unsubscribed by the other Investors. Before any such person may sell Common Stock, he will give the Investors an opportunity to participate in such sale on a basis proportionate to the amount of securities held by the seller and those held by the participating Investors.²³

Lock-Up

Founders will not transfer, hedge or otherwise dispose of any capital stock following an IPO for a period specified by the Company and the managing underwriter [not to exceed [180] [210] days].

VOTING AGREEMENT

*Board
of Directors:*

At the initial Closing, the Board shall consist of [_____] members comprised of (i) [Name] as [the representative designated by [____]], as the lead Investor, (ii) [Name] as the representative designated by the remaining Investors, (iii) [Name] as the representative designated by the Founders, (iv) the person then serving as the Chief Executive Officer of the Company, and (v) [____] person(s) who are not employed by the Company and who are mutually acceptable [to the Founders and Investors][to the other directors].

Drag Along:

Holders of Preferred Stock and the Founders [and all future holders of greater than [1]% of Common Stock (assuming conversion of Preferred Stock and whether then held or subject to the exercise of options)] shall be required to enter into an agreement with the Investors that provides that such stockholders will vote their shares in favor of a Deemed Liquidation Event or transaction in which 50% or

²³Certain exceptions are typically negotiated, e.g., estate planning or *de minimis* transfers. Transfers are sometimes also prohibited to competitors or to other parties to protect confidential information.

more of the voting power of the Company is transferred and which is approved by [the Board of Directors] [and the holders of ____% of the outstanding shares of Preferred Stock, on an as-converted basis].²⁴

OTHER MATTERS

Founders' Stock:

All Founders to own stock outright subject to Company right to buyback at cost. Buyback right for [__]% for first [12 months] after Closing; thereafter, right lapses in equal [monthly] increments over following [__] months.

*Existing Preferred Stock*²⁵:

The terms set forth above for the Series [__] Preferred Stock are subject to a review of the rights, preferences and restrictions for the existing Preferred Stock. Any changes necessary to conform the existing Preferred Stock to this term sheet will be made at the Closing.]

No Shop/Confidentiality:

The Company agrees to work in good faith expeditiously towards a closing. The Company and the Founders agree that they will not, for a period of [_____] weeks from the date these terms are accepted, take any action to solicit, initiate, encourage or assist the submission of any proposal, negotiation or offer from any person or entity other than the Investors relating to the sale or issuance, of any of the capital stock of the Company [or the acquisition, sale, lease, license or other disposition of the Company or any material part of the stock or assets of the Company] and shall notify the Investors promptly of any inquiries by any third parties in regards to the foregoing. [In the event that the

²⁴This provision is typically subject to a number of negotiated conditions, including: the representations and warranties required are limited to authority and title to shares, liability for breaches of representations by the Company is limited to a pro rata share of any escrow amount withheld, any liability is several and capped at the stockholder's purchase price and that the stockholder receive the same form and amount per share of consideration as other holders of the same class or series of stock.

²⁵Necessary only if this is a later round of financing, and not the initial Series A round.

Company breaches this no-shop obligation and, prior to [____], closes any of the above-referenced transactions [without providing the Investors the opportunity to invest on the same terms as the other parties to such transaction], then the Company shall pay to the Investors \$[____] upon the closing of any such transaction as liquidated damages.]²⁶ The Company will not disclose the terms of this Term Sheet to any person other than officers, members of the Board of Directors and the Company's accountants and attorneys and other potential Investors acceptable to [____], as lead Investor, without the written consent of the Investors.

Expiration:

This Term Sheet expires on [____ __, 200_] if not accepted by the Company by that date.

EXECUTED THIS [__] DAY Of [____], 20[__].

[SIGNATURE BLOCKS]

²⁶It is unusual to provide for such "break-up" fees in connection with a venture capital financing, but might be something to consider where there is a substantial possibility the Company may be sold prior to consummation of the financing (e.g., a later stage deal).

THE VCFI SPREADSHEETS

THIS APPENDIX DESCRIBES the spreadsheets and models used in the text. The spreadsheets are available on the publisher's websites; the VCV model is available at VCVtools.com. Section B.1 gives an annotated list of all spreadsheets. Most of these spreadsheets are self-explanatory and easy to use. For the VCV model, we present a user's guide in Section B.2. The VCV model was developed by Anthony Curnes, Holland Gary, Andrew Metrick, Jonathan Reinstein, David Smalling, and Rebecca Yang.

B.1 AN ANNOTATED LISTING OF SPREADSHEETS AND MODELS USED IN THIS BOOK

All spreadsheets were built using Microsoft Excel and carry the .xls extension.

Chapter 6—*Betas*, with estimates of industry betas for the U.S. market premium, and country betas for the global market premium.

Chapter 10—*VC method*, to make investment recommendations using the standard and modified versions of the VC method.

Chapter 11—*DCF*, with examples of reality-check models for three companies, a sample investment function, and industry statistics for DCF inputs.

Chapters 13 through 18—*VCV*, with templates for the valuation of preferred stock structures. See Section B.2 for a user's guide and Section B.3 for screenshots.

Chapter 22—*Bintree*, with a 60-step binomial tree and modular worksheets for underlying asset value and option value.

B.2 THE VCV MODEL

The VCV model is built as a web application. The model consists of four calculation modules: The European Call Option Calculator, the Random-Expiration (RE) Call Option Calculator, the FLEX Calculator, and the AUTO Calculator. The examples using European Call Option and RE Option Calculator are discussed

in Chapters 13. We describe below how to enter inputs into FLEX and AUTO Calculators.

Inputs Common to FLEX and AUTO:

- Volatility is in %. For 90%, enter “90”.
- Risk Free Rate is in %. For 5%, enter “5”.
- Total valuation is in million dollars. For \$100M, enter “100”.
- Expected Holding Period is in years. For 5 years, enter “5”.

For Inputs Specific to FLEX:

- Strike Price is in \$ millions. For \$100M, enter “100”.
- Options are calculated as either regular RE options or binary RE options. Select the correct type by clicking on the tab.

For Inputs Specific to AUTO:

- Founder’s Shares is in millions. For 10M shares, enter “10”.
- Shares are in millions. For example, for 10M shares, enter “10”.
- Investment is in \$ millions.
- RP APP is in \$ millions. This input cell is grayed out unless you select RP + C or RP + CP as the security Type.
- Security types are abbreviated as follows:
 - C = Common Stock
 - CP = Convertible Preferred
 - RP = Redeemable Preferred
 - RP + C = Redeemable Preferred and Common
 - RP + CP = Redeemable Preferred and Convertible Preferred
 - PCP = Participating Convertible Preferred
 - PCPC = Participating Convertible Preferred with Cap
- Cap is in multiples of the APP. For example, for 3X cap, enter “3”. This input cell is grayed out unless you select PCPC as the Security Type.
- QPO is in multiples of the OPP. For example, for 5X OPP threshold, enter “5”. This input cell is grayed out unless you select PCP or PCPC as the Security Type.
- Dividends is in monthly rate as percentage of the original APP. For example, for 1% monthly dividends, enter “1”.
- Dividends are calculated as either simple dividends or complex dividends. Select the correct type by clicking on the tab.

486 APPENDIX B THE VCFI SPREADSHEETS

- Liquidation Preference is in multiples of APP. For example, for 1X preference, enter “1”.
- GP(%) is in %. For example, for 10%, enter “10”.
- Lifetime Fees is in \$millions. For example, for \$20M, enter “20”.
- Committed Capital is in \$millions. For example, for \$100M, enter “100”.

GUIDE TO CRYSTAL BALL[®]

Crystal Ball[®] is a popular simulation program that works as an add-in to Excel. The software was originally developed by Decisioneering, Inc., a company that provides risk analysis and decision-making software and solutions.¹ In this appendix, we will introduce Crystal Ball[®], provide an overview of functionalities, and solve the all examples from Chapter 20 and some from Chapter 21 using this software.²

As we learned in Chapter 20, we can use the random number function of Excel to run simulations. However, programming simulations in Excel quickly become unwieldy for more complex problems. Crystal Ball[®] makes it easier to set up simulation models by providing extra functionalities, which allow users to define random variable assumptions for one scenario, to specify run preferences for running the trial multiple times, and to view graphical and statistical summaries of overall simulation outcomes.

To get started with Crystal Ball[®], users need to install the program and to launch the Crystal Ball[®] add-in either by clicking on the Crystal Ball[®] icon or by going through Start > All Programs > Crystal Ball[®]. Once the program has finished loading, a Crystal Ball[®] toolbar should appear at the top of a blank Excel spreadsheet. Exhibit C-1 describes the buttons of this Crystal Ball[®] toolbar.

Once the program has been successfully launched, the next step is to set up the simulation model in Crystal Ball[®]. Unlike with Excel, where we need to set up 10,000 rows of the simulation if we want to model 10,000 potential outcomes of project trials, Crystal Ball[®] allows us to build the model based on only one run of the project because the program records the individual outcome and runs the model for the prespecified number of project trials. Crystal Ball[®] then synthesizes the results of all the runs and presents the summary of outcomes both graphically and statistically.

1. Define random number assumptions.
2. Define the forecast.
3. Set simulation run preferences.
4. Run the simulation.
5. Analyze the results.

¹Following the acquisition of Decisioneering by Oracle, the software is now sold by Oracle.

²This appendix was coauthored with Greta Lin. Crystal Ball[®] Edition 7.1.2 was used to solve the problems in this appendix. For the latest edition of Crystal Ball[®], see <http://www.oracle.com/appserver/business-intelligence/crystalball/index.html>.

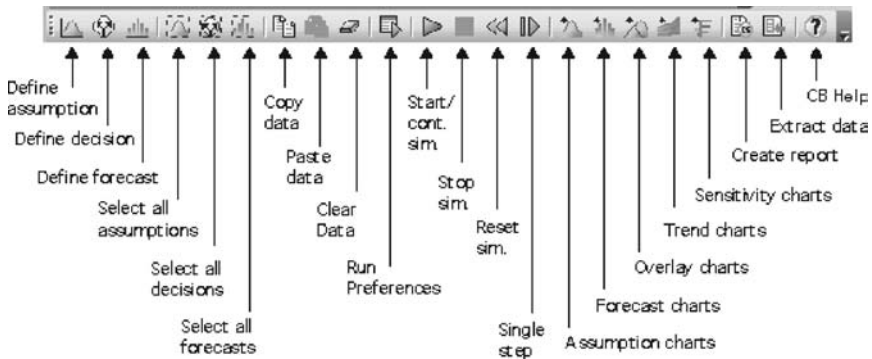
EXHIBIT C-1**CRYSTAL BALL® TOOLBAR**

We will discuss each of these steps in detail as we work through the examples presented in Chapter 20 of the text using Crystal Ball®.

EXAMPLE 20.1

Drugco has just begun Phase I trials for Newdrug. Phase I takes one year and costs \$10 M. Drugco's scientists estimate that the R&D has a 50 percent chance of successfully completing Phase I and moving to Phase II. Phase II takes one year and costs \$30 M. If Newdrug enters Phase II, the scientists estimate a 40 percent chance of successfully completing Phase II and moving to Phase III. Phase III takes three years (including the time waiting for FDA approval) and costs \$60 M. If Newdrug enters Phase III, the scientists estimate a 50 percent chance of success (=FDA approval). Drugco management estimates an NPV of \$1B at the time of approval. If the drug fails, then it would be worth nothing. The discount rate is equal to the risk-free rate of 5 percent per year. All development costs must be paid at the beginning of the respective phase.

Problem Use Crystal Ball® to build a Monte Carlo simulation for Newdrug and confirm the same (average) NPV solution as obtained in Chapter 20.

Crystal Ball® Solution To solve this problem we need to create a model that replicates the scenario described earlier. One possible spreadsheet setup is shown in Exhibit C-2. To then complete the simulation, we need to follow the five main steps of Crystal Ball® simulations.

EXHIBIT C-2

SPREADSHEET SETUP FOR CRYSTAL BALL® SIMULATION OF EXAMPLE 20.1

A1	B	C	D	E	F	G	
2	Example 20.1						
3					a	b	
4	Phase I outcome	0.393331183			0	1	
5	Phase I successful? (1 = Yes, 0 = No)	1 =IF(C4<0.5,1,0)					
6							
7	Phase II outcome	0.135942738			0	1	
8	Phase II successful? (1 = Yes, 0 = No)	1 =IF(C7<0.4,1,0)					
9							
10	Phase III outcome	0.509778687			0	1	
11	Phase III successful? (1 = Yes, 0 = No)	0 =IF(C10<0.5,1,0)					
12							
13		Potential impact	Go/no go		Actual impact	NPV	
14	Phase I	\$ (10)	1		\$ (10)	\$ (10.0)	
15	Phase II	\$ (30)	1 =C5		\$ (30)	\$ (28.6)	
16	Phase III	\$ (60)	1 =C5*C8		\$ (60)	\$ (54.4)	
17	Market drug	\$ 1,000	0 =C5*C8*C11		\$ -	\$ -	
18							
19	NPV					\$ (93.0)	
20							

Step 1: Define random number assumptions

In this problem, there are three points of uncertainty.

1. Success of Phase I (Cell C4 of Exhibit C-2)
2. Success of Phase II (Cell C7)
3. Success of Phase III (Cell C10)

These uncertainties are interrelated because Phase II can only be successful if Phase I was successful, and FDA approval requires Phase I success, Phase II success, and Phase III success.

Therefore, to set up the model we need to define three random numbers. We have assumed that there is a 50 percent chance of successfully completing Phase I and moving to Phase II, a 40 percent chance of successfully completing Phase II and moving to Phase III, and a 50 percent chance of successfully completing Phase III and obtaining FDA approval, so we should draw our random numbers based on a uniform distribution from 0 to 1. Because every number between 0 and 1 has an equal probability of being selected, we know that the number drawn will be less than 0.4 for 40 percent of trials and will be less than 0.5 for 50 percent of trials.

To tell Crystal Ball® to generate random numbers based on a uniform distribution, we need to take the following steps:

- Enter a default numerical value in the cell that defines the random number.
- Hit the “Define Assumption” button on the Crystal Ball® toolbar (located on the far left—refer back to Exhibit C-1 if necessary).

EXHIBIT C-3

CRYSTAL BALL® DISTRIBUTION GALLERY

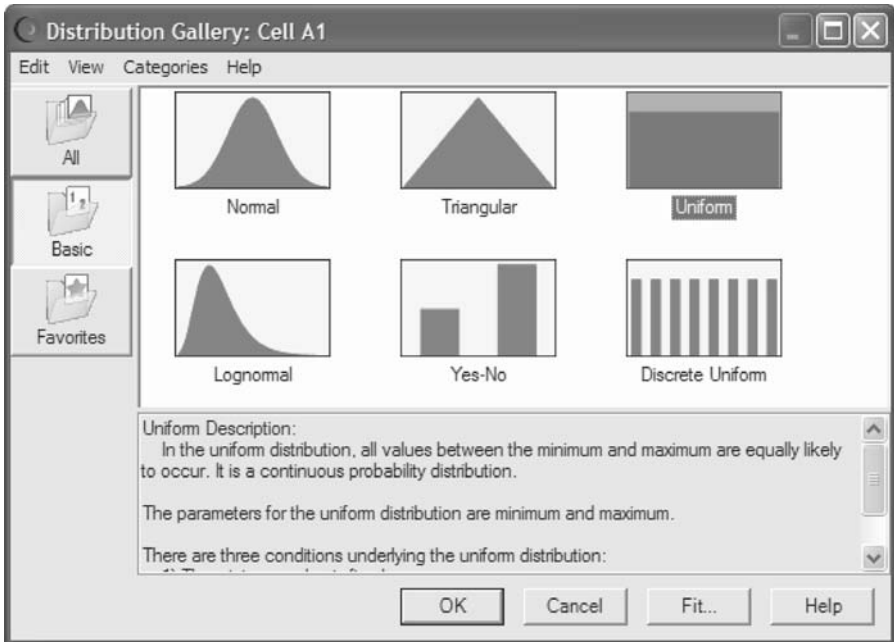

- At this point, the Crystal Ball® distribution gallery should appear (Exhibit C-3). Select the uniform distribution and click “OK”.
- Next, specify the maximum and minimum values (a and b , respectively) for the range of the uniform distribution. It is good idea to get in the habit of directly referencing these cells within the Crystal Ball® window to cells from the spreadsheet that contains values for a and b — this is a good mechanism for tracking and recording the parameters. To do this, hit the button at the right side of the parameter input space (highlighted by the large red arrow in Exhibit C-4) within the distribution window and then click on the cell that contains the correct value on the spreadsheet.
- Repeat these steps in order to generate random numbers that simulate the outcomes of Phase II and Phase III trials.
- Once these random number generators have been specified, we need to translate these random numbers into outcomes. We can do this by writing IF statements, which tell us whether or not the drug successfully passes a phase based on the random number that is generated. For Phase I, we stipulate that:

IF(RN < 0.5, 1, 0). [Cell C5 Exhibit C-2]

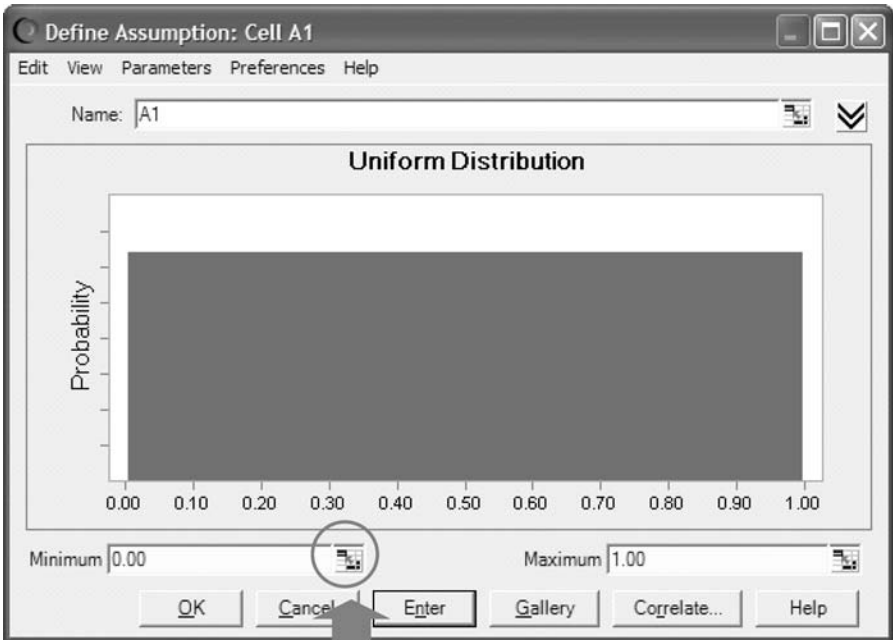
EXHIBIT C-4**SPECIFYING THE UNIFORM DISTRIBUTION**

Click here to link parameter
input to Excel spreadsheet

Therefore, if the random number is less than 0.5, the drug passes Phase I and a value of 1 is returned in our success indicator cell. On the other hand, if the random number is greater than 0.5, the drug does not pass Phase I and a value of 0 is given in the success indicator cell.

- These success indicator cells allow us to easily set up the relationships between phases. Because any number multiplied by 0 is 0, we know that when we multiply success indicator cells together, the only time we will return a value of 1 is when the drug has successfully passed all the phases involved in the multiplication.

Step 2: Define the forecast

- In this example, the outcome we want to forecast is the NPV of the project. To calculate the NPV of the project, we need to determine the costs and revenues associated with each

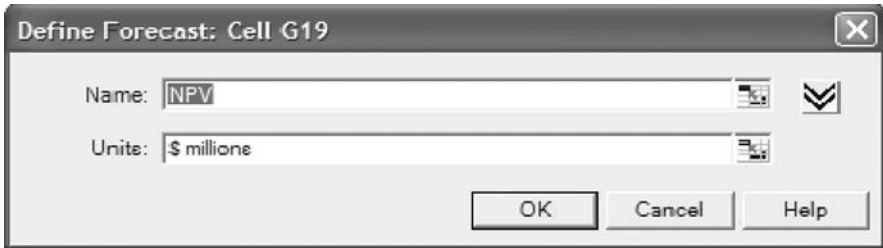
EXHIBIT C-5**DEFINE FORECAST WINDOW**

phase of the project. We know that we incur the \$10 M cost of Phase I trials with certainty. We only incur Phase II costs of \$30 M if the project passes Phase I and moves onto Phase II. Therefore, we multiply the \$30 M cost by the Phase I outcome success indicator value. If Phase I is successful, \$30 M is multiplied by 1, if it is unsuccessful \$30 M is multiplied by 0, and no cost is incurred. The same logic holds for the \$60 M cost of Phase III except that we need to multiply by Phase I and Phase II outcome success indicator values. We only take on Phase III if the project has passed through both phases and therefore both indicators have a value of 1. Finally, we multiply the potential \$1B in revenues by the Phase I, II, and III outcome success indicators.

- Use the 5 percent discount rate and the timing of the trials to discount the potential costs and revenues appropriately.
- Finally define the forecast cell for Crystal Ball® by highlighting the cell that contains the final NPV calculation for the scenario (Cell G19 of Exhibit C-2). Then, select “Define Forecast” from the Crystal Ball® toolbar (refer back to Exhibit C-1).
- When the Define Forecast window appears (Exhibit C-5), provide an appropriate name and specify units of the forecast. Although this example only has one forecast cell, descriptive names and units become important when there are multiple forecast cells we wish to analyze.

Step 3: Set simulation run preferences

- Select “Run Preferences” from the Crystal Ball® toolbar (refer back to Exhibit C-1).
- On the trials tab of the Run Preferences window that appears (Exhibit C-6), specify the number of outcomes you wish Crystal Ball® to run. This value should be sufficiently large so that Crystal Ball® returns approximately the same results each time the simulation is run. However, the larger the number of trials, the more time Crystal Ball® will require to complete the simulation.

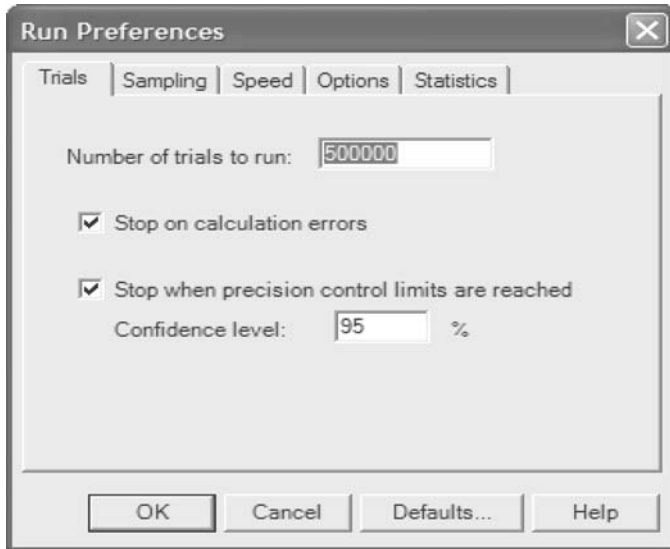
EXHIBIT C-6*RUN PREFERENCES WINDOW***Step 4: Run the simulation**

- We are finally ready to run the simulation. We can first test to make sure that our simulation is set up correctly by running the model one trial at a time by hitting the “Single Step” button of the Crystal Ball® toolbar (refer back to Exhibit C-1). One smart thing to check is to make sure that the NPV of the project is $-\$10\text{M}$ whenever Phase I is unsuccessful. Similarly, the NPV is $\$690.5$ when all three phases are successful.
- Once we are sure the model works, we hit “Reset Simulation” from the toolbar to clear the history of runs and then we select “Start/Continue Simulation”, which is designated by the large right arrow in the center of the toolbar (Refer back to Exhibit C-4.)
- A control panel should appear to let the user know when the progress of the simulation including when the trials are complete.

Step 5: Analyze the results

- Crystal Ball® provides several tools to allow us to analyze results. These analysis tools are found by clicking on “Forecast Charts” button of the Crystal Ball® tool bar (refer back to Exhibit C-1) and then opening the appropriate forecast window.
- We can examine the statistical outputs of the simulation by clicking on View > Statistics within the Forecast Chart window (Exhibit C-7). As determined in Chapter 20, the expected NPV of the project, the mean outcome of the simulation, is $\$43.1\text{M}$.

EXHIBIT C-7**STATISTICAL OUTPUT OF EXAMPLE 20.1 CRYSTAL BALL[®] SIMULATION**

Forecast: NPV	
Statistic	Forecast values
Trials	500,000
Mean	\$43.10
Median	(\$10.00)
Mode	(\$10.00)
Standard Deviation	\$217.20
Variance	\$47,192.00
Skewness	2.6
Kurtosis	7.91
Coeff. of Variability	5.04
Minimum	(\$93.00)
Maximum	\$690.50
Mean Std. Error	\$0.30

Example 20.1 used discrete random variables, which we modeled as “1” for success and “0” for failure. We used IF statements to indicate the success or failure of the phase based on the random numbers drawn by Crystal Ball[®]. In the next example, we solve a problem that uses a continuous random variable, which has an infinite number of possible outcomes.

EXAMPLE 20.2

Drugco has just begun Phase III trials for Newdrug. For simplicity, we assume that we are sure the drug has no side effects, so all that matters for FDA approval is its efficacy. Efficacy is distributed $E \sim U[0, 1]$ and will be revealed after three years of Phase III trials. The NPV of the drug after three years is $\$1B * E^2$. The discount rate is equal to the riskfree rate of 5 percent per year. The total cost of R&D is \$100M and must be paid at the beginning of development.

Problem Use Crystal Ball[®] to run a Monte Carlo simulation to solve for the NPV of the Newdrug project. The outcome should match our Excel solution from Chapter 20.

EXHIBIT C-8

SPREADSHEET SETUP FOR CRYSTAL BALL® SIMULATION OF EXAMPLE 20.2

A1	B	C	D	E	F	G	H
2	Example 20.2						
3				a	b		
4	Phase III efficacy	0.897067		0	1		
5							
6							
7	Year	0	1	2	3		
8	R&D	-100					
9	Value of project					804.7287=1000*C4^2	
10							
11	NPV	595.1549					
12							

Solution Crystal Ball® **Solution** We approach this problem by setting up a spreadsheet such as in Exhibit C-8 and completing the five step Crystal Ball® process.

Step 1: Define random number assumptions

As with Example 20.1, our first step is to define our random number assumptions within Crystal Ball®. The one unknown in the problem is the efficacy of the drug once it has passed Phase III. We are given that efficacy is uniformly distributed across a range of 0 to 1. Thus, we need to take the following steps:

- Enter a default numerical value in the cell that defines the random number.
- Hit the “Define Assumption” button on the Crystal Ball® toolbar.
- From the Distribution Gallery that appears, select uniform distribution and click “OK”.
- Specify the maximum and minimum values (a and b) for the range of the uniform distribution in the appropriate cells of the Crystal Ball® Define Assumption window by creating links to reference cells on the worksheet.

Step 2: Define the forecast

In this problem, we wish to forecast the NPV of the overall project. We were told that we incur \$100M in R&D costs at the beginning of development with certainty. However, our value after three years is uncertain. From the discussion in Chapter 20, we know that $F(E) = E$, so we can compute our values by taking our random number draw and plugging directly into the equation that was given:

$$\text{Value after 3 years} = \$1B * E^2$$

where E is the random value that was drawn within the uniform range. Once we have calculated the value number, we apply the discount rate, and we compute the overall NPV for the project. We define the cell that contains the overall NPV computation (Cell C11 in Exhibit C-8) as the forecast cell for Crystal Ball[®]. To do this, highlight this cell and select “Define Forecast” from the Crystal Ball[®] toolbar. When the Define Forecast window appears, name the forecast and define units.

Step 3: Set simulation run preferences

Select “Run Preferences” from the Crystal Ball[®] toolbar. Specify the number of outcomes you wish Crystal Ball[®] to run on the trials tab of the Run Preferences window that appears. In the example Crystal Ball[®] output shown in Exhibit C-9, the number of outcomes was set to 1 M.

Step 4: Run the simulation

Test the spreadsheet if desired by running a “Single Step”. Then “Reset Simulation” and hit “Start/Continue Simulation”. Crystal Ball[®] will provide updates on the progress of the simulation.

Step 5: Analyze the results

On examination of the statistical outcomes (Exhibit C-9), we find that as we predicted in the Excel simulation in Chapter 20, the average NPV of the project is approximately \$188 M.

EXHIBIT C-9

STATISTICAL OUTPUT OF EXAMPLE 20.2 CRYSTAL BALL[®] SIMULATION

Statistic	Forecast values
Trials	1,000,000
Mean	\$187.86
Median	\$115.54
Mode	---
Standard Deviation	\$257.62
Variance	66,366.10
Skewness	0.63819
Kurtosis	2.14
Coeff. of Variability	1.37
Minimum	(\$100)
Maximum	\$763.84
Mean Std. Error	\$0.26

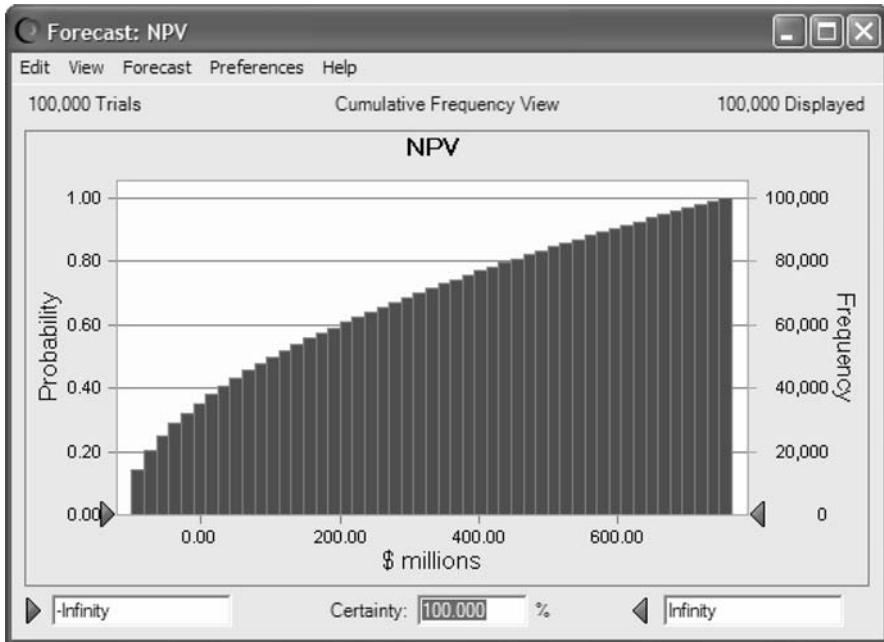
EXHIBIT C-10**CUMULATIVE FREQUENCY CHART FOR EXAMPLE 20.2**

Another tool that Crystal Ball® provides for analyzing results is cumulative frequency charts (Exhibit C-10). We open this chart by clicking on View > Cumulative Frequency within the Forecast Chart window of Crystal Ball®. Within this window we can also examine the probability that outcomes will fall within a certain range of values.

EXAMPLE 20.3

Drugco has just begun Phase III trials for Newdrug. For simplicity, we assume that we are sure the drug has no side effects, so all that matters for FDA approval is its efficacy. Efficacy is distributed $E \sim \text{LogN}[0, 1]$ and will be revealed after three years of Phase III trials. The NPV of the drug after three years is $\$1\text{B} * E^2$. The discount rate is equal to the riskfree rate of 5 percent per year. The total cost of R&D is $\$100\text{M}$ and must be paid at the beginning of development.

EXHIBIT C-11

SPREADSHEET SETUP FOR CRYSTAL BALL® SIMULATION OF EXAMPLE 20.3

A1	B	C	D	E	F	G
2	Example 20.3					
3					Mean	SD
4				Ln:	0	1
5	Phase III efficacy	0		LogN:	1.65	2.16
6						
7						
8	Year	0	1	2	3	
9	R&D	-100				
10	Value of project					0
11						
12	NPV	-100				
13						

Problem Use Crystal Ball® to run a Monte Carlo simulation to solve for the NPV of the Newdrug project. The outcome should match our Excel solution from Chapter 20.

Solution Crystal Ball® Solution The only difference between Example 20.2 and 20.3 is that in 20.2 Phase III efficacy is distributed uniformly, whereas in 20.3 Phase III efficacy follows a lognormal distribution. Thus we need to define our random number assumptions differently, but all the other steps are the same as in Example 20.2.

Step 1: Define random number assumptions

The one unknown in the problem is the efficacy of the drug once it has passed Phase III. We are given that efficacy is distributed $E \sim \text{LogN}[0, 1]$. Thus, we need to take the following steps:

- Enter a default numerical value in the cell that defines the random number.
- Hit the “Define Assumption” button on the Crystal Ball® toolbar.
- From the Distribution Gallery that appears, select lognormal distribution and click “OK”.
- As noted in Chapter 20, in the $x \sim \text{LogN}[\mu, \sigma]$ notation, μ and σ are not the mean and standard deviation (“SD”) of the lognormal distribution, instead they represent the mean and SD of $\ln(x)$. When specifying the parameters of the lognormal distribution within Crystal Ball®, we need to find the actual mean and SD of x . The conversion equations are as follows:

$$\text{Mean of } x \text{ when } x \sim \text{LogN}[\mu, \sigma] = \exp[\mu + \sigma^2/2] \tag{C.1}$$

$$\text{SD of } x \text{ when } x \sim \text{LogN}[\mu, \sigma] = (\exp[2\mu + 2\sigma^2] - \exp[2\mu + \sigma^2])^{(1/2)}. \tag{C.2}$$

Solving these equations, we get a mean of 1.65 and an SD of 2.16.

EXHIBIT C-12**STATISTICAL OUTCOME AND FREQUENCY CHART FOR EXAMPLE 20.3**

Statistic	Forecast values
Trials	1,000,000
Mean	\$6,324.37
Median	\$763.23
Mode	---
Standard Deviation	\$52,576.02
Variance	\$2,764,237,765.34
Skewness	186.46
Kurtosis	73,449.51
Coeff. of Variability	8.31
Minimum	(\$99.95)
Maximum	\$26,549,919.12
Mean Std. Error	\$52.58

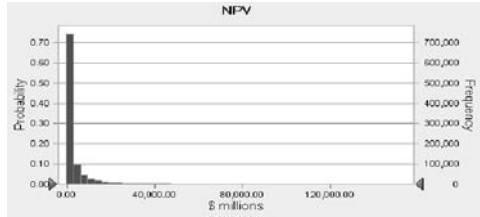
**Steps 2, 3, and 4**

Follow the same steps as in Example 20.2.

Step 5: Analyze the results

As expected based on the Excel simulation from Chapter 20, the average NPV of the project is approximately \$6.3 billion (Exhibit C-12). If we examine the frequency chart of outcomes (View > Frequency), we see that outcomes are skewed toward lower NPVs because of the lognormal distribution of Phase III efficacy. ■

We are now ready to use Crystal Ball® to solve a more complex problem. Example 20.4 has three sources of uncertainty which each exhibit different distributions and each uniquely influence the outcome.

EXAMPLE 20.4

Drugco has just begun Phase III trials for Newdrug, which has an associated R&D cost of \$100M. Drugco expects Phase III trials to take two years and the FDA approval decision to take one year, so that the FDA decision is expected in three years. Phase II trials were promising, with a score of 40 on the standard medically

recognized scale. (We will refer to this score as the “efficacy” of the drug.) Although the best alternative drug has an efficacy of 50, it is not helpful for all patients. Given the side effects of Newdrug and the risks and benefits of alternative treatments, Drugco believes that the FDA will approve Newdrug if the Phase III trials find an efficacy of 30 or greater. Based on the results of the Phase II trials, Drugco estimates that the efficacy results of Phase III will be $E \sim N(40, 20)$. (It is possible for efficacy to be negative because some drugs can make symptoms worse.) During the three years of Phase III trials, it is possible that the alternative treatments will also improve from their current efficacy of 50. Drugco estimates a final distribution for the alternative of $A \sim T(50, 100, 50)$. If Newdrug is approved by the FDA, then its market share will depend on the relative efficacy of Newdrug versus the best available treatment, that is,

$$\text{Newdrug market share} = E^2 / (E^2 + A^2).$$

Drugco estimates market size for Newdrug in the approval year (in thousands of doses) as $M \sim N(1,000, 100)$, with 6 percent annual growth going forward. Each dose yields a gross profit of \$1. To stay in the market, Drugco must spend \$300 M on marketing in the first year, with this sum increasing each year by 6 percent. On approval, Newdrug would have 10 years of patent life remaining. After the patent expiration, Drugco expects generic competition and other improved alternatives to greatly erode the value of Newdrug, so for simplicity we assume that the continuing value would be zero after the patent expires. Following earlier examples in this chapter, we assume a discount rate equal to the riskfree rate of 5 percent.

Problem Use Crystal Ball[®] to run a Monte Carlo simulation that estimates the FDA approval rate and the NPV of Newdrug.

Crystal Ball[®] Solution The three unknowns in this problem are efficacy, alternative efficacy, and starting market size. Efficacy and starting market size exhibit normal distributions whereas alternative efficacy follows a triangular distribution.

Step 1: Define random number assumptions

- Enter a default numerical value in the cell that defines the random number for *efficacy* (Cell C5 of Exhibit C-13).
- Hit the “Define Assumption” button on the Crystal Ball[®] toolbar.
- From the Distribution Gallery that appears, select “normal distribution” and click “OK”.
- Specify the mean and SD of the normal distribution in the appropriate cells of the Crystal Ball[®] Define Assumption window by creating links to reference cells on the worksheet. In the case of *efficacy*, we are given that the mean value is 40 with a SD of 20.
- Repeat the preceding steps to define *market starting size* as a random number, which is normally distributed with a mean of 1,000 and a SD of 100 (Cell C7 of Exhibit C-13).
- Next we define *alternative efficacy* according to a triangular distribution (Cell C6 of Exhibit C-13). Again hit “Define Assumption”, but this time select “Triangular Distribution” within the Distribution Gallery.

EXHIBIT C-13

SPREADSHEET SETUP FOR EXAMPLE 20.4

A1	B	C	D	E	F	G	H	I	J	K	L	M
2	Example 20.4											
3												
4												
5	Phase III Efficacy	51										
6	Alternative Efficacy	59										
7	starting market size	1084										
8												
9												
10	Approval Threshold	30										
11	gross profit per unit	1										
12	Market Share	42.5%=C15*C5^2/(C5^2 + C6^2)										
13	market growth	6.0%										
14	discount rate	5.00%										
15	approved?	1 =IF(C5>C10,1,0)										
16												
17	Year		3	4	5	6	7	8	9	10	11	12
18												
19	market size		1084	1149	1218	1291	1369	1451	1538	1630	1728	1831
20												
21	Market share	\$C12=	42.5%	42.5%	42.5%	42.5%	42.5%	42.5%	42.5%	42.5%	42.5%	42.5%
22	gross profit	(D19*D21)*\$C11=	\$460.6	\$488.2	\$517.5	\$548.6	\$581.5	\$616.4	\$653.4	\$692.6	\$734.1	\$778.2
23	marketing costs	C15*300=	\$300.0	\$318.0	\$337.1	\$357.3	\$378.7	\$401.5	\$425.6	\$451.1	\$478.2	\$506.8
24	profit	D22-D23=	\$160.6	\$170.2	\$180.5	\$191.3	\$202.8	\$214.9	\$227.8	\$241.5	\$256.0	\$271.3
25												
26	NPV as of year 0	\$1,313.5=NPV(C14,D24:M24)*SQRT(1+C14)/(1+C14)^3-100										

- Triangular distributions are defined by the minimum, likeliest, and maximum values of the distribution. In the case of alternative efficacy, these values are 50, 50, and 100, respectively

Step 2: Define the forecast

In this problem, we wish to forecast two outcomes: the probability of FDA approval and the NPV of the overall project.

- Because we are given that the approval threshold is 30, we know that the drug is approved whenever the random number draw for Phase III efficacy is greater than 30. Thus, we can forecast the outcome with an IF statement:

IF(Phase III efficacy>30, 1, 0). [Cell C15 of Exhibit C–13]

We define the cell that contains this IF statement as the forecast cell for Crystal Ball[®]. As before, we do this by highlighting this cell and selecting “Define Forecast” from the Crystal Ball[®] toolbar. When the Define Forecast window appears, name the forecast and define units.

- To forecast the NPV of the project we need to construct the DCF model for Newdrug with the random variables set to their expected values. The key line items of the DCF are
 - Market share, which is zero if Newdrug is not approved or determined by Newdrug and Alternative efficacies when the drug is approved
 - Market size, which flows from the random draw of the starting market size
 - Profit, which is derived from market size and gross profit per unit
 - Marketing costs, which are only incurred if the drug is approved

An example of the full DCF spreadsheet can be found in Exhibit C-13.

Step 3: Set Simulation run preferences

In the example output shown (Exhibit C-14), 1 M trials were run.

Step 4: Run the simulation

Because the model is complex, it is a good idea to run the model in single steps to check that only \$100 M in costs is incurred when the drug is not approved and to observe profitability when the drug is approved at different Phase III and alternative efficacies.

Step 5: Analyze the results

As was discussed in Chapter 20, the simulation reveals that the probability of FDA approval is 69% and that the maximum NPV of the 1 M draws was more than \$6.5B, whereas in the worst-case scenario the company loses \$2.2B. The average NPV for simulation is approximately \$285 M (Exhibit C-14).

On examination of the cumulative frequency chart (Exhibit C-15), we notice an interesting result of the simulation. We observe that most of the projects have an NPV above $-\$100$ M, the R&D cost for Phase III. However, some trials resulted in NPV below $-\$100$ M. These are

EXHIBIT C-14

STATISTICAL OUTCOME FOR EXAMPLE 20.4

Forecast: NPV

Statistic	Forecast values
Trials	1,000,000
Mean	\$285.90
Median	(\$100.00)
Mode	(\$100.00)
Standard Deviation	\$1,082.00
Variance	\$1,170,726.00
Skewness	1
Kurtosis	4.08
Coeff. of Variability	3.78
Minimum	(\$2,205.20)
Maximum	\$6,733.80
Mean Std. Error	\$1.10

Forecast: approved?

Statistic	Forecast values
Trials	1,000,000
Mean	0.69
Median	1
Mode	1
Standard Deviation	0.46
Variance	0.21
Skewness	-0.8307
Kurtosis	1.69
Coeff. of Variability	0.66748
Minimum	0
Maximum	1
Mean Std. Error	0

EXHIBIT C-15

CUMULATIVE FREQUENCY CHART FOR OUTCOMES OF EXAMPLE 20.4

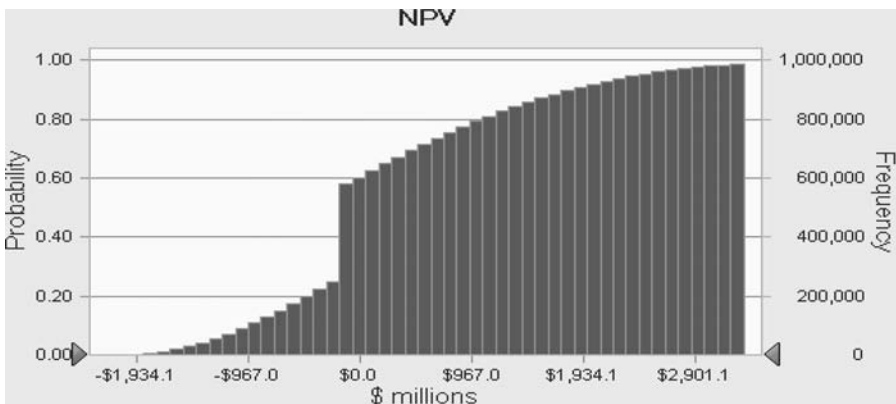

the runs where the efficacy of Newdrug was low and the alternative efficacy was high. In these scenarios, the drug was launched but market share of Newdrug was so low that marketing costs could not be recouped. In these scenarios, Drugco would have been better off if the company had abandoned the Newdrug project, even though the drug had been approved. In Example 21.4 of

EXHIBIT C-16**STATISTICAL OUTCOME AND CUMULATIVE FREQUENCY CHART FOR EXAMPLE 21.4****Forecast: NPV (with option)**

Statistic	Forecast values
Trials	1,000,000
Mean	\$473.80
Median	(\$67.50)
Mode	(\$100.00)
Standard Deviation	\$904.80
Variance	\$818,614.10
Skewness	1.75
Kurtosis	5.52
Coeff. of Variability	1.91
Minimum	(\$100.00)
Maximum	\$6,576.20
Mean Std. Error	\$0.90

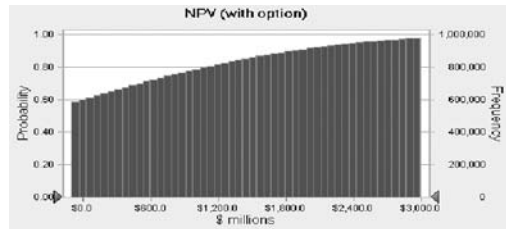

Chapter 21, we revisit Example 20.4 to value this “abandonment” option. We are able to rerun the Monte Carlo simulation with the additional option by making two simple modifications to our spreadsheet. First, we need to calculate the salvage value according to the information given in Example 21.4. Then we compare the NPV of abandoning the project to the NPV of launching Newdrug, and we forecast outcomes based on the higher NPV. We do this with the following equation:

$$\text{MAX}(\text{NPV if launch drug}, \text{Salvage value} - \$100\text{M}). \quad (\text{D.3})$$

The results of the Newdrug project with abandonment option are shown in Exhibit C-16.

As discussed in Chapter 21, the average NPV of the simulation with the option is more than \$180 M greater than the average NPV without the option. Also, when we view the cumulative frequency chart we clearly see that we no longer have runs that result in NPV less than $-\$100\text{M}$. ■

We have finished solving four examples in which we used Crystal Ball® to simulate project outcomes and forecast NPV in the presence of uncertainty. The key steps for setting up simulations are defining assumptions for random variables based on different types of distributions, defining forecasts, setting run preferences, and running simulations. We also examined various Crystal Ball® tools (e.g., statistical outcomes, cumulative frequency charts) that allow us to analyze and interpret the outcomes of the simulations.

Crystal Ball® provides many more features for more advanced users. Two more functionalities that may be useful when modeling R&D projects are (1) defining dynamic assumptions and (2) defining decision variables and tables. To demonstrate these additional tools, we will work through parts of Exercise 21.4 (Remember that

EXHIBIT C-18**STATISTICAL OUTPUT OF PHASE III EFFICACY AS DETERMINED BY A DYNAMIC ASSUMPTION**

Forecast: E	
Statistic	Forecast values
Trials	500,000
Mean	40.01
Median	40
Mode	---
Standard Deviation	25.83
Variance	667.06
Skewness	0.00279
Kurtosis	2.91
Coeff. of Variability	0.64548
Minimum	-81.55
Maximum	152.48
Mean Std. Error	0.04

DEFINING DECISION VARIABLES AND DECISION TABLES

We can instruct Crystal Ball[®] to test various values for certain inputs by defining that input as a decision variable and then running a decision table. In this example, we want to determine the minimum value of E' such that Drugco should continue on to Phase III trials—that is to establish a “continuation threshold”. The spreadsheet for this problem is very similar to the earlier solution of Example 21.4, except that we begin the simulation one year earlier, and Phase III is determined by the dynamic assumption that we just modeled.

By defining the efficacy threshold as a decision variable with a minimum of 0 and maximum of 50, we can tell Crystal Ball[®] to run 11 simulations in which only drugs with Phase II E' above 0, then 5, then 10, etc. are passed onto Phase III based on an IF statement that defines the “continuation threshold”. The following steps are necessary to define a decision variable.

- Highlight the input cell to be varied (Cell C7 of Exhibit C-19). Then click on the “Define Decision” button of the Crystal Ball[®] toolbar (second button from the left— refer back to Exhibit C-1 if necessary).

EXHIBIT C-19

SPREADSHEET SETUP FOR DEFINING DECISION VARIABLE IN EXERCISE 21.4

A1	B	C	D	E	F	G	H	I	J	K	L	M
2	Exercise 21.4											
3												
4				Mean	SD		Min	Max	Mode			
5	Phase II efficacy	39.09					0	80	40			
6												
7	Continuation Threshold	???										
8	Phase II approved?	0										
9												
10	Phase III efficacy	70.11		39.09	20							
11												
12	Alternative Efficacy	60					50	100	50			
13	starting market size	1,006		1,000	100							
14												
15												
16	Approval Threshold	30										
17	gross profit per unit	1										
18	Market Share	0.0%										
19	market growth	6.0%										
20	discount rate	5.00%										
21	Phase III approved?	1										
22	Disc Salvage value?	0.00										
23							\$ in millions					
24	Year		4	5	6	7	8	9	10	11	12	13
25												
26	market size		1,006	1,066	1,130	1,198	1,270	1,346	1,427	1,513	1,604	1,700
27												
28	Market share		0.0%	0.0%	0.0%	0.0%	0.0%	0.0%	0.0%	0.0%	0.0%	0.0%
29	gross profit		\$0.0	\$0.0	\$0.0	\$0.0	\$0.0	\$0.0	\$0.0	\$0.0	\$0.0	\$0.0
30	marketing costs		\$0.0	\$0.0	\$0.0	\$0.0	\$0.0	\$0.0	\$0.0	\$0.0	\$0.0	\$0.0
31	profit		\$0.0	\$0.0	\$0.0	\$0.0	\$0.0	\$0.0	\$0.0	\$0.0	\$0.0	\$0.0
32												
33	NPV (if enter)	-\$50.0										
34												
35	NPV (with option)	-\$50.0										

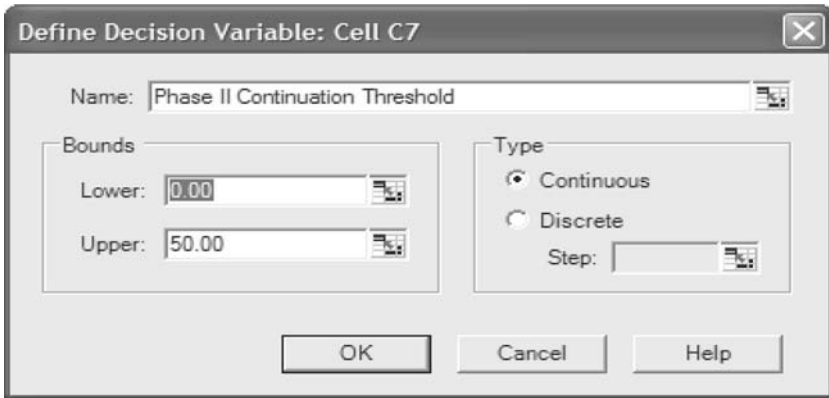
EXHIBIT C-20*DEFINE DECISION VARIABLE WINDOW*

- Once the Define Decision Window (Exhibit C-20) appears, name the variable, set the upper and lower bounds of values to be tested, and decide whether or not input values should be continuous or discrete.

After the random number assumptions, forecasts, and decision variables are all defined, we are ready to run a decision table.

- First we need to set “Run Preferences” so that Crystal Ball® selects the same sequence of random variables to run against the different inputs. This allows us to compare the different mean NPV outcomes for the various continuation thresholds without having to worry about variability from random number selection. To do this, click on “Run Preferences” in the Crystal Ball® toolbar. When the Crystal Ball® window appears, go to the “Sampling” tab and then enter a seed number – for this example, we used an initial seed value of 999 (Exhibit C-21)
- Go to Run > Tools > Decision Table.
- Select the target forecast from the menu, click “Next”.
- Then select the decision variable from the menu, and click “Next” (Left side of Exhibit C-22). In this example, we only defined one decision variable, but up to two decision variables may be selected for a decision table.
- Specify the other options of the Decision Table such as number of test values, test runs, and settings while running, and hit “Start” (Right side of Exhibit C-22). For this example, we could run 51 trials to test every integer continuation threshold between 0 and 50 (inclusive), however, this would be a very time-consuming simulation run, so we will only run 11 trials to get a sense of outcomes at every multiple of 5.

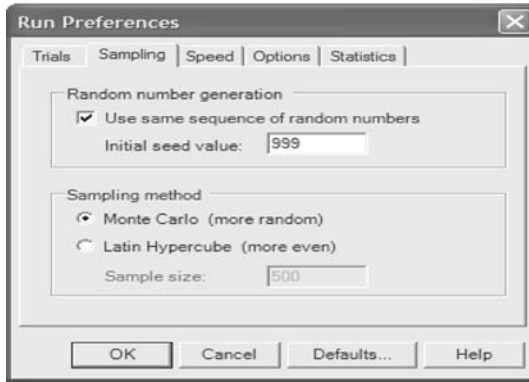
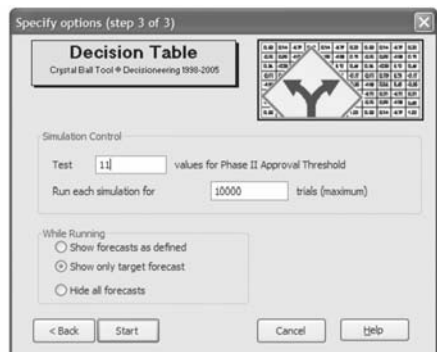
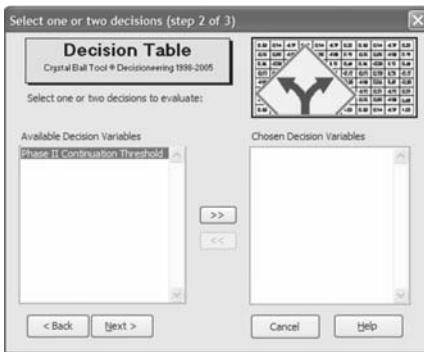
EXHIBIT C-21*SPECIFYING THE SEQUENCE OF RANDOM VARIABLES***EXHIBIT C-22***SPECIFYING DECISION VARIABLES AND OPTIONS FOR THE DECISION TABLE*

- The resulting Decision Table will appear in a new spreadsheet (Exhibit C-23). We can graphically view the data by creating an Excel bar chart from the data.

From the decision table, we see that the average NPV of the project is maximized when the continuation threshold is set somewhere between 15 and 20. Therefore, we should further investigate the efficacies in this range. Because decision

EXHIBIT C-23

RESULTING DECISION TABLE

Phase II Continuation Threshold (0)	Phase II Continuation Threshold (5)	Phase II Continuation Threshold (10)	Phase II Continuation Threshold (15)	Phase II Continuation Threshold (20)	Phase II Continuation Threshold (25)	Phase II Continuation Threshold (30)	Phase II Continuation Threshold (35)	Phase II Continuation Threshold (40)	Phase II Continuation Threshold (45)	Phase II Continuation Threshold (50)
\$536.9	\$537.6	\$538.9	\$540.0	\$540.0	\$536.6	\$524.3	\$500.2	\$457.3	\$395.2	\$321.3
1	2	3	4	5	6	7	8	9	10	11

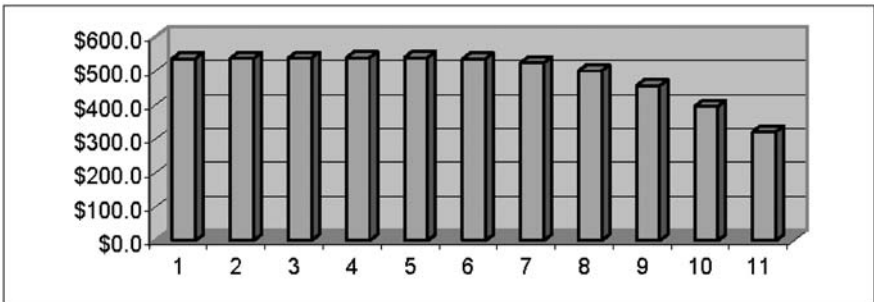

tables are constrained at 10,000 trials for each test value, we can perform a more refined analysis by running each integer value between 15 and 20 through a standard Crystal Ball® run of 500,000 trials by inputting the continuation threshold manually and then running the simulation six times. We want to continue using the same initial seed value within “Run Preferences” for these individual runs as with the decision table so that we continue to eliminate variability from random number selection. As before, click on “Run Preferences”. When the Crystal Ball® window appears, go to the “Sampling” tab to confirm the initial seed value.

The outcomes shown in Exhibit C-24 reveal that the Phase II continuation threshold should be set at around 17 to maximize the average NPV of the project. This means that Phase II trials with efficacies much lower than 17 are not worth continuing into Phase III because it is unlikely that the Phase III R&D costs can be recouped. However, trials with efficacies above 17 should be continued.

EXHIBIT C-24**OUTCOMES OF 500,000 TRIAL RUNS WITH DIFFERENT CONTINUATION THRESHOLDS****DIFFERENT CONTINUATION THRESHOLDS**

Continuation threshold: 15			Continuation threshold: 16			Continuation threshold: 17		
Forecast: NPV (with option)			Forecast: NPV (with option)			Forecast: NPV (with option)		
Statistic	Forecast values		Statistic	Forecast values		Statistic	Forecast values	
Trials	500,000		Trials	500,000		Trials	500,000	
Mean	\$531.50		Mean	\$531.60		Mean	\$531.70	
Median	(\$92.50)		Median	(\$50.00)		Median	(\$50.00)	
Mode	(\$145.20)		Mode	(\$145.20)		Mode	(\$145.20)	
Standard Deviation	\$1,019.00		Standard Deviation	\$1,018.40		Standard Deviation	\$1,017.80	
Variance	\$1,038,320.90		Variance	\$1,037,048.90		Variance	\$1,035,864.6C	
Skewness	1.58		Skewness	1.59		Skewness	1.59	
Kurtosis	4.73		Kurtosis	4.73		Kurtosis	4.74	
Coeff. of Variability	1.92		Coeff. of Variability	1.92		Coeff. of Variability	1.91	
Minimum	(\$145.20)		Minimum	(\$145.20)		Minimum	(\$145.20)	
Maximum	\$6,650.60		Maximum	\$6,650.60		Maximum	\$6,650.60	
Mean Std. Error	\$1.40		Mean Std. Error	\$1.40		Mean Std. Error	\$1.40	

Continuation threshold: 18			Continuation threshold: 19			Continuation threshold: 20		
Forecast: NPV (with option)			Forecast: NPV (with option)			Forecast: NPV (with option)		
Statistic	Forecast values		Statistic	Forecast values		Statistic	Forecast values	
Trials	500,000		Trials	500,000		Trials	500,000	
Mean	\$531.60		Mean	\$531.40		Mean	\$531.10	
Median	(\$50.00)		Median	(\$50.00)		Median	(\$50.00)	
Mode	(\$145.20)		Mode	(\$145.20)		Mode	(\$145.20)	
Standard Deviation	\$1,017.00		Standard Deviation	\$1,016.30		Standard Deviation	\$1,015.40	
Variance	\$1,034,353.40		Variance	\$1,032,840.00		Variance	\$1,031,137.8C	
Skewness	1.59		Skewness	1.59		Skewness	1.6	
Kurtosis	4.75		Kurtosis	4.77		Kurtosis	4.78	
Coeff. of Variability	1.91		Coeff. of Variability	1.91		Coeff. of Variability	1.91	
Minimum	(\$145.20)		Minimum	(\$145.20)		Minimum	(\$145.20)	
Maximum	\$6,650.60		Maximum	\$6,650.60		Maximum	\$6,650.60	
Mean Std. Error	\$1.40		Mean Std. Error	\$1.40		Mean Std. Error	\$1.40	

In this Appendix, we solved Chapter 20 and 21 problems using Crystal Ball[®] and discussed some of the more advanced features of the software package. If possible, you should try solving these examples on your own using Crystal Ball[®] or another simulation software. Software add-ins like Crystal Ball[®] can be extremely helpful for setting up and running complex simulations to forecast outcomes in the presence of uncertainty.

REFERENCES

- Gans Noah, Jack Hershey, Anjani Jain, and Ziv Katalan. The Wharton School. OPIM 621: Decision Models and Uncertainty—Class lecture notes.
- Ragsdale, Cliff T., 2004. *Spreadsheet Modeling and Decision Analysis*, 4th Edition, Thomson/South-Western, Mason, OH, pp. 595–667.

GLOSSARY

This glossary includes all key terms given in bold in the text, plus some others that are helpful for these definitions or for VC practice. When multiple entries have the same meaning, the definition is given only once, with an “=” for all synonyms. The definition is typically given for the first alphabetical entry, unless one of the later entries is much more commonly used. Key terms are given in **bold** type for their first appearance in each entry. Many of these terms also have a generic meaning in English; in most cases, this glossary gives only the meanings relevant to venture capital and the finance of innovation.

In most cases, we do not give formulas for these terms, relying on verbal descriptions instead. To see formulas and to read more contextual material for any of these terms, please consult the index to find places in the text where the terms are discussed. Some of these key terms are used in multiple ways in the book, which mirrors the multiple meanings for these terms in VC practice. Rather than pretend that these confusions do not exist, we have highlighted the distinctions in this glossary.

Since venture capital is a relatively new academic field, it was helpful in this book to make up some new terms to aid in the translation between financial economics and VC practice. These terms are given in **bold italic** type. In some cases, these new terms have a common-sense meaning in English, but are still put in bold italic type in order to formalize the specific meaning used in this book.

TERMS

Abnormal return: The additional return above the **expected return** from a **factor model**. (= **Alpha**)

Absolute return: The amount distributed to the **limited partners** of a **fund**, expressed as a multiple of each dollar contributed by the partners: e.g., over the life of a fund that has \$100M in **committed capital**, the limited partners receive \$200M back. The absolute return of this fund = $\$200M/\$100M = 2$. (= **Investment multiple**, = **Realization ratio**, = **Value multiple**)

Absolute valuation: Any method of valuation that relies on estimates and forecasts made by the analyst. **Discounted cash flow analysis** is an example of absolute valuation. (See also **Relative valuation**.)

Accrued cash dividend: A dividend that adds to the **redemption value** of **preferred stock**, but is not actually paid until a **deemed liquidation event**.

Adjusted conversion price: The **conversion price** after **antidilution protections** have taken effect. (See also **Adjusted conversion rate**.)

Adjusted conversion rate: The **conversion rate** after **antidilution protections** have taken effect. (See also **Adjusted conversion price**.)

Aggregate purchase price (APP): The total amount paid for a specific class of stock. The APP is equal to the **original purchase price** multiplied by the number of shares purchased.

Alpha: English pronunciation of the Greek letter, α . (= **Abnormal return**) (See also **Beta**.)

American option: An **option** that can be exercised any time on or before the **exercise date**.

Angel: A wealthy individual that invests in young, growth companies. An angel differs from a venture capitalist because the former is using her own money. (= **Angel investors**)

Angel investors: (= **Angel**)

Annualized return: An asset return expressed on a per-year basis.

APP: acronym for *aggregate purchase price*.

Applied research: Research intended to translate scientific findings into practical uses. (See also **Basic research, Development**.)

Arms race: A strategic situation where all parties have an incentive to escalate some activity, even though all parties would be better off if they could agree not to escalate.

As-if conversion: A feature of **PCP** and **PCPC** stock, where the stock receives its **redemption value** and also is entitled to participate in the upside “as-if” it had been converted to **common stock**.

At the money: An **option** where the **strike price** is exactly the same as the current value of the **underlying security**.

Barriers to entry: An obstacle, either legal or economic, that prevents or slows down competition in some market.

Base tree: A **binomial tree** showing the possible price paths for the **underlying security** in an option-pricing problem. (See also **Option tree**.)

Basic research: Research designed to better understand the universe, without regard for immediate practical application. (See also **Applied research, Development**.)

BC(X): Abbreviation for a *random-expiration binary call option* with a **strike price** of X.

Best response: In game theory, a move that gives Player A the highest expected payoff against Strategy Z by Player B is called a best response by A against Z by B. (See also **Nash equilibrium**.)

Beta: English pronunciation of the Greek letter, β . Within the **Capital Asset Pricing Model (CAPM)**, the beta of an asset is the **factor loading** of that asset on the **market portfolio**. In this model, beta is the regression coefficient on an asset’s **excess returns** when it is regressed on the **market premium**. Within **multifactor models**, beta is sometimes used generically to refer to the loading on any **factor**. (See also **Alpha**.)

Binary call option: An **option** that pays a fixed amount if the price of an **underlying asset** is higher than a preset **strike price** on an **exercise date**.

Binomial trees: A **decision tree** with exactly two **branches** from each **risk node** and a fixed time period for each branch. Binomial trees are commonly used to value **options**.

Black-Scholes formula: A valuation formula for **European call** options.

Boom period: As used in this book, the period between 1995 and 2000, inclusive. (See also *Preboom, Postboom periods*.)

Branch: In a **tree**, each possible move is represented by a **branch**.

Breakeven valuation: The total valuation of a company such that $LP\text{ valuation} = LP\text{ cost}$.

Broad-base formula: One of the methods used to compute the **adjusted conversion price** under **weighted average antidilution protections**. The broad-base formula gives smaller adjustments than does the **narrow-base formula**.

Burn rate: The speed with which a company is using up its cash.

Business plan: A summary document about the business that entrepreneurs show to investors.

Business risks: Risks faced by **R&D** investors that are correlated with the state of the economy. These risks are best modeled using real options. (See also *Competitive risks*, *Technical risks*.)

CA: Acronym for **Cambridge Associates**.

Call option: Gives the holder the right, but not the obligation, to purchase an **underlying security** at a **strike price**.

Cambridge Associates (CA): A **gatekeeper** and a provider of a **net-return** index for the VC industry.

Cap point: The level of **proceeds** where the **liquidation return** of **PCPC** stock is maximized. (= W_A (cap))

Capital call: When the **general partner** of a fund requests capital from the **limited partners**. (= **Drawdown**, = **Takedown**)

Capital asset pricing model (CAPM): Model that expresses the expected return of an asset as a function of the **risk-free rate**, the **market premium**, and **beta**.

Capitalization table: A table prepared as part of the **term sheet** that lists the stock ownership of all investors, both before and after the current transaction.

CAPM: acronym for **capital asset pricing model**

Carried interest: The **fund** profits paid to the **general partner**. (= **Carry**)

Carried interest basis (= carry basis): Fund profits are defined as total proceeds minus the **carried interest basis**. Typically, this basis is set to be either the **committed capital** or the *investment capital* of the fund.

Carry: (= **Carried interest**)

Carry basis: (= **Carried interest basis**)

Carry%: The percentage level of **carried interest**. The most common *carry%* is 20 percent.

Cash distributions: The distribution of cash to **limited partners**. The alternative to a cash distribution is an **in-kind distribution**.

Catch-up provision: When limited partners receive a **hurdle return**, the **general partner** may have a **catch-up provision** that allows them to receive a share greater than *carry%* for some range of profits after the hurdle return is achieved.

CDF: Acronym for **cumulative distribution function**.

Certificate of incorporation: (= **Charter**)

Charter: A legal document, setting out the main rules of corporate governance. Key provisions from the charter are included as part of the **term sheet**. (= **Certificate of incorporation**) (See also **Investor Rights Agreement**.)

Clawback: If carried interest is received before the entire **carried interest basis** and **hurdle returns** have been paid, and if later proceeds are insufficient to reach these thresholds,

- then **general partners** may be subject to a **clawback**, where some of the earlier carried interest must be transferred to the **limited partners**.
- Cliff vesting:** When all remaining options (or stock) becomes vested at the same time. (See also **Step vesting**.)
- Clinical trials:** Drug tests in humans for safety and efficacy. (= **Human trials**)
- Closed:** In raising a **fund**, **general partners** ask **limited partners** to commit to providing capital. When the general partners have reached some desirable threshold of **committed capital**, they publicly announce that the fund has closed. Despite the finality of this term, some funds close multiple times, each time announcing a new level of committed capital. (See also **Raised**.)
- Closing:** With respect to transactions in **portfolio companies**, the **closing** is the formal signing of all necessary contracts and the transferring of the capital from the fund to the company.
- Commitment period:** The time—usually the first five years of life—during which the **fund** is permitted to make investments in new portfolio companies. (= **Investment period**)
- Committed capital:** The total amount of capital promised to the **fund** by the **limited partners**.
- Common stock:** Equity claims that are paid last upon any **liquidation** of the company. (See also **Preferred stock**.)
- Comparables analysis:** The valuation of an asset by using data on similar assets. (= **Multiple analysis**, = **Method of multiples**, = **Relative valuation**)
- Competitive advantage:** Anything that allows a company to charge prices above marginal costs.
- Competitive risks:** Risks faced by R&D investments that are caused by competition from other entities. Competitive risks are modeled using game theory. (See also **Business risks**, **Technical risks**.)
- Compound interest:** Interest that is paid on principal and on any interest accrued from previous periods. (See also **Simple interest**.)
- Compound return:** A **periodic return** calculated by multiplying the subperiod returns.
- Constant-sum games:** A game where the sum of the payoffs to all players is a constant. (See also **Zero-sum games**.)
- Continuous random variables:** A random variable defined on a continuous range, with an infinity of possible outcomes. (See also **Discrete random variables**.)
- Continuously compounded returns:** Returns with interest compounded at every instant. (= **Log returns**)
- Contributed capital:** At any given time in the life of the **fund**, contributed capital is equal to the sum of **invested capital** plus all prior **management fees**.
- Conversion condition:** An inequality for **convertible preferred** stock that requires that conversion value be greater than **redemption value**. The minimum value of proceeds that satisfies the **conversion condition** is called the **conversion point**.
- Conversion-order shortcut:** When there are multiple rounds of **convertible preferred** shareholders, they would choose to convert in the same order as the **redemption value per share**.
- Conversion point** (= W_A): The minimum level of proceeds such that the holder of **convertible preferred** stock would choose to convert rather than to redeem. The **conversion point** is the minimum solution to the **conversion condition**.

- Convertible preferred (CP):** Equity that can either be turned in for its **redemption value** or converted to **common stock**.
- Coordination games:** Games with multiple **pure-strategy Nash equilibria** where all players would prefer any of these equilibria to the nonequilibrium outcomes.
- Corporate venture capital:** VC investment by corporations. Although traditional VC seeks to maximize financial returns, corporate venture capital often mixes financial and strategic goals.
- Cost of capital (r):** The cost of capital is the risk-adjusted **discount rate** for an investment project. In an equilibrium model like the **CAPM**, the cost of capital is equal to the **expected return**.
- Country beta:** In the **global CAPM**, the **country beta** is the **factor loading** of a country on the **global market premium**.
- Country risk:** The risk that an investment project in a foreign country will fail because of some political or economic disaster in that country.
- Covariance:** Covariance measures the extent to which two variables tend to move together. In financial economics, assets earn **excess returns** because of the covariance of asset returns with some price **factor**. (See also **Variance**.)
- CP:** Acronym for **convertible preferred**
- Crossover investing:** Investment in public companies by **private equity** firms.
- CRR model:** Acronym for **Cox-Ross-Rubenstein Model**, a specific method for constructing **binomial trees**.
- Cumulative distribution function (cdf):** The cdf evaluated at point x gives the probability that the random variable will be less than or equal to x . The cdf evaluated at x is the integral of the **pdf** from negative infinity to x .
- Cumulative dividends:** **Dividends** that accrue if not paid. (See also **Noncumulative dividends**.)
- DCF:** Acronym for **discounted cash flow analysis**.
- Deal flow:** The investment opportunities available to a VC. In general, the better a VC firm's reputation, the better quality is their deal flow. (See also **Sourcing**, **Proprietary deal flow**.)
- Decision nodes:** The point in a **tree** where a player must make a decision.
- Decision trees:** **Trees** with two types of **nodes**, **risk nodes** and **decision nodes**. (See also **Event trees**, **Binomial trees**, **Game trees**.)
- Deemed liquidation event: (= Liquidation)** An event where certain **preferred stock** rights come into force. These events are carefully defined in the **term sheet**. The most common triggers for a **deemed liquidation event** are when a **portfolio company** is purchased or shut down.
- Demand registration rights:** Rights that allow **preferred stock** holders to demand that their shares be sold in a **registered transaction**. (See also **Registration rights**, **S-3 registration rights**, **Piggyback registration rights**.)
- Derivative assets:** Assets whose value is completely dependent on the value of other assets. (See also **underlying assets**.)
- Development:** When used to describe a type of **R&D** project, **development** projects are those designed to translate scientific research into marketable products. (See also **Applied research**, **Basic research**.)

- Discount rate:** The rate that equates a \$1 today with the expected value of \$1 in some future period.
- Discounted cash flow (DCF) analysis:** A method that values an asset as the sum of the discounted value of all cash flows produced by that asset. DCF analysis is a form of **absolute valuation**.
- Discrete random variables:** A random variable whose possible values are physically separated when plotted on a real line. (See also **Continuous random variables**.)
- Distress investing:** Investing in companies that have a significant risk of going out of business. (= **Special situations**)
- Diversifiable risk:** Risk that has only a negligible impact on the whole economy (e.g., the risk that any specific house will burn down is **diversifiable risk**). (= **Idiosyncratic risk**)
- Dividend preference:** The restriction that dividends cannot be paid to common stock holders unless they are first paid to preferred stock holders.
- Domestic beta:** The regression coefficient on an asset's excess returns when it is regressed on the **market premium** from its own country. (See also **Domestic CAPM**.)
- Domestic CAPM:** A **CAPM** that uses the market premium from any one country. In contrast, the **global CAPM** uses the **global market premium**. (See also **Domestic beta**.)
- Dominant strategy:** In **game theory**, a **strategy** that does at least as well as every other strategy, no matter what strategies are chosen by other players.
- Down round:** In **term sheets**, the **technical definition** that **round Y** is a down round typically requires that the **conversion price** for **preferred stock** in round *Y* is lower than the conversion price for preferred stock in Round *X*, where $X < Y$. More generally, we can also think of a down round occurring if the **implied valuation** for **series X** after round *Y* is lower than the **LP cost** of series *X*.
- Dragalong:** A right of **preferred stock** holders to force other investors to sell their stake in the company, provided that the preferred stock holder has found a buyer for all shares at the same price. (See also **Take-me-along**, = **Tagalong**, = **Right of first offer**, = **Right of first refusal**, = **Transfer restrictions**.)
- Drawdown:** (= **Capital call**, = **Takedown**)
- Due diligence:** Careful study of all aspects of a potential investment.
- Early stage:** The definitions of early stage, **midstage** (= **Expansion stage**), and **later stage** are imprecise. The **NVCA** definitions (Exhibit 1-5) indicate that this stage "provides financing to companies completing development where products are mostly in testing or pilot production".
- Early stage fund:** A **fund** that invests predominantly in **early stage** companies. (See also **Late-stage fund**, **Multistage fund**.)
- Earnings:** (= **Net income**, = **Net profits**): The difference between revenue and expenses.
- Earnings before Interest and Taxes (EBIT):** **Earnings** plus interest expense plus taxes.
- EBIT:** Acronym for **Earnings before Interest and Taxes**.
- Enterprise value:** The **market value** of all securities issued by a company.
- Entrepreneurial ecosystem:** A regional community of entrepreneurs, **venture capitalists**, technologists, and service providers.

Equilibrium concept: In *game theory*, a set of conditions necessary to define an equilibrium.

For example, for the equilibrium concept of **Nash equilibrium**, the conditions require that every player give a full menu of **strategies** at every **decision node**, with all these strategies being a **best response** to the menu provided by all other players.

Equilibrium strategy: In *game theory*, the **strategy** for any given player that satisfies a specific **equilibrium concept**.

Equity market value: (= **market cap**, = **market capitalization**)

European call: Gives the holder the right, but not the obligation, to purchase an **underlying security** at a **strike price** on a specific **expiration date**.

European put: Gives the holder the right, but not the obligation, to sell an **underlying security** at a **strike price** on a specific **expiration date**.

Event trees: **Trees** without any **decision nodes**. (See also **Binomial trees**, **Decision trees**, **Game trees**.)

Exercise price: (= **Strike price**) (**2X**, **3X**, **4X** etc.) **excess liquidation preference:** The multiple of **aggregate purchase price** that holders of **preferred stock** receive on **redemption**. (See also **Liquidation preference**.)

Excess returns: The difference between the return on a specific asset and the **risk-free rate** over the same time period.

Exit: This term has two related meanings. First, an exit refers to the sale or **initial public offering (IPO)** of a **portfolio company**. Second, an exit refers to the sale of a **VC's** stake in a portfolio company. These two definitions are not always the same (e.g., a VC usually must hold his stock for at least six months after an IPO). Then, we have the paradox of an IPO “exit” followed by the VC “exit” six months later.

Exit diagram: On the *x*-axis, the market value of a company at exit; on the *y*-axis, the value of a VC stake in that company at exit. An exit diagram differs from an **expiration diagram** in that the former plots values at a VC exit at some unknown exit date, whereas the latter plots values on a known expiration date.

Exit equation: The value of a VC stake in a company at exit, expressed as a portfolio of **random-expiration options**. We obtain exit equations by *reading the exit diagram*.

Exit valuation: The expected value of a portfolio company, conditional on a **successful exit**.

Expansion stage: The definitions of early stage, **midstage** (= **Expansion stage**), and **later stage** are imprecise. The **NVCA** definitions (Exhibit 1-5) indicate that “this stage involves applying working capital to the initial expansion of a company. The company is now producing, is shipping, and has growing accounts receivables and inventories. It may or may not be showing a profit”.

Expected holding period: The amount of time that a VC expects to hold an investment before exit.

Expected retention percentage: Suppose a **VC fund** owns *X* percent of a company after making its initial investment. Before an **exit** occurs, the fund expects that the company will need to raise more capital by selling additional shares, which will reduce the initial ownership to *Y* percent. Then, the expected retention percentage would be *Y/X*.

Expected return: From a mathematical perspective, the expected return on an investment is computed by multiplying each possible return by the probability of that return. In an equilibrium model like the **CAPM**, the expected return is equal to the **cost of capital**.

Expiration date: The last possible date that an **option** can be exercised.

- Expiration diagram:** On the x -axis, the market value of the **underlying asset** on the **expiration date**; on the y -axis, the value of an **option** on that asset. An **exit diagram** differs from an expiration diagram in that the former plots values at a VC exit at some unknown exit date, whereas the latter plots values on a known expiration date.
- Expropriation:** A fancy way to say “stealing”. Minority investors (like VCs) must always be on guard for subtle ways that managers and majority investors can expropriate resources of the company. (= **Investor Expropriation**, = **Self-dealing**, = **Tunneling**)
- Extensive form:** A **decision tree** with more than one player. In **game theory**, the **normal form** lists all possible **strategies** for all players; the extensive form provides all the information available in the normal form, and also shows the timing for all moves. (= **Game tree**)
- Factor:** A **systematic risk** in the economy. In the **CAPM**, the only factor is the **market premium**. (= **Risk factor**)
- Factor model:** A model where **expected returns** are determined by **factor loadings** on a set of **factors**. The **CAPM** is an example of a factor model, where the **market premium** is the factor and **beta** is the factor loading.
- Factor loading:** The amount that an asset’s return is related to a specific **factor**. In the **CAPM**, the **market premium** is the **factor** and **beta** is the factor loading.
- Fama-French Model (FFM):** A **multifactor model** with three **factors** related to the **market premium**, the size of the company, and the growth prospects of the company.
- FDA:** Acronym for the Food and Drug Administration, a unit of the U.S. government that is responsible for the regulation of prescription drugs.
- FDA approval:** The final step before a drug can be legally sold in the United States. (See also **Phase I, Phase II, Phase III, Preclinical**.)
- FFM:** Acronym for the **Fama-French Model**.
- Financial intermediary:** Any economic actor that stands between a supplier of capital and the real investment of that capital.
- Financial options:** **Options** on financial assets. In contrast, **real options** are options on, you guessed it, real assets.
- Financing round:** (= **Round**) A discrete event where a young company receives capital from investors. Financing rounds are often referred to sequentially as **first round** (= **Series A**), **second round** (= **Series B**), etc.
- Finite games:** A game with a finite number of moves for every player. Finite games can be completely described using the **normal form** and the **extensive form**. (See also **Infinite games**.)
- Firm:** In **VC**, a firm is the legal entity that serves as the **general partner** for a **VC fund**.
- First Round (Series A):** The first **round** of investment by VCs. (See also **Financing Round, Second Round (Series B)**.)
- FOF:** Acronym for **fund-of-funds**.
- Folk theorem:** Loosely speaking, the folk theorem is that virtually any observed behavior in an **infinite game** can be supported as part of a **subgame-perfect Nash equilibrium**.
- Follow-on investments:** Investments made in **Round Y** by a **VC investor** in **Round X** , where $Y > X$.

Full-ratchet antidilution: A strong version of **antidilution protection**, where the **adjusted conversion price** is the lowest price paid by any later-round investor. (See also **Weighted-average antidilution**.)

Fully diluted basis: Any computation that assumes the conversion of all **preferred stock** and the **exercise** of all **options**.

Fully diluted share count: The total number of shares outstanding assuming the conversion of all **preferred stock** and the **exercise** of all **options**.

Fund: (= **VC fund**) A pool of capital used for **VC** investments. Typically, a **VC fund** is a **limited partnership** with a fixed lifetime, where the capital is provided by **limited partners** and the fund is managed by a **VC firm** acting as the **general partner**.

Fund-of-funds (FOF): A fund that makes investments in other funds, rather than making investment directly in portfolio companies.

Game tree: (= **Extensive form**) (See also **Event trees, Decision trees, Binomial trees, Trees**.)

Gatekeeper: A consultant who advises **limited partners** on their **fund** investments.

General partner (GP): The investment manager of a **limited-partnership VC fund**.

Geometric mean: For a series of N numbers, the geometric mean is the n th root of the product of all N numbers.

Global beta: The **beta** in a **global CAPM**.

Global CAPM: The **CAPM**, with the **global market premium** used as the **factor**.

Global market premium: The expected **excess return** of the **value-weighted** global equity market.

GP: Acronym for general partner.

GP valuation: The valuation, using option pricing methods, of the **GP's** stake in an investment.

GP%: The expected percentage of partial valuation that belongs to the **VC**. **GP Valuation** = **GP% * partial valuation**.

Graduation: In the **reality-check DCF model**, graduation marks the date where a company moves from the **rapid-growth period** to the **stable-growth period**.

Graduation value: The discounted value of the company at **graduation**.

Gross investment: The gross amount added to a company's capital stock in a period.

Gross investment multiple (= Gross value multiple (GVM)): The total value of all investments at **exit**, divided by **investment capital**.

Gross return: A return calculated before subtracting **management fees, carried interest**, or any other investment costs.

Gross value multiple (GVM): (= **Gross investment multiple**)

Growth capital: Capital used for **VC** investing beyond the **early stage**.

Growth factor: In a **binomial tree**, the growth factor is the **risk-free rate** measured over the step size of the tree.

GVM: Acronym for **gross value multiple** (= **Gross investment multiple**)

Harmonic mean: In a group of numbers, the harmonic mean is the reciprocal of the mean of the reciprocals (i.e., for N numbers X_i , $I = 1, \dots, N$, the harmonic mean =

$$N / \sum_{i=1}^N \frac{1}{X_i}$$

Hedge funds: Hedge funds comprise a wide class of investment vehicles, with mandates that include virtually any strategy that can be imagined. Hedge funds differ from mutual funds in that the former has much lighter regulation. Hedge funds differ from **private equity funds** in that the former tends to focus mostly on publicly traded securities, although the distinctions between these types of funds has blurred somewhat in recent years. With more liquid investments, hedge funds typically have much shorter lockup periods for investors than do private equity funds.

Historical return: (= **Realized return**) The past return for an asset, fund, or manager.

Hockey stick: (= **J-curve**): On the x -axis, the number of years since a **fund's vintage year**. On the y -axis, the **IRR** of the fund up to that year. For successful funds, this curve takes the form of a hockey stick, with negative IRRs reported for early years (when **management fees** are paid but before any **exits**) and higher IRRs in later years (after the best exits have occurred.)

Human trials: (= **Clinical trials**)

Hurdle returns: (= **Preferred returns**, = **Priority returns**) A preset level of returns that the **fund** must pay to investors before the **GP** can begin to take any **carried interest**.

Idiosyncratic risk: (= **Diversifiable risk**)

Implied GP valuation: The *implied valuation* of the **GP** stake in an investment, based on the price paid in the most recent **round**. (See also *Implied LP valuation*, *Implied partial valuation*.)

Implied LP valuation: The *implied valuation* of the **LP** stake in an investment, based on the price paid in the most recent **round**. (See also *Implied GP valuation*, *Implied partial valuation*.)

Implied partial valuation: The *implied valuation* of the **fund's** stake in an investment, based on the price paid in the most recent **round**. Implied partial valuation = *Implied GP valuation* + *Implied LP valuation*.

Implied prevaluation (IV_{pre}): The *implied valuation* of a company immediately prior to the most recent **round** of investment.

Implied postvaluation (IV_{post}): The **market value** of a company, as implied by the **VCV** model, under the assumption that the most recent investors paid fair value, *LP valuation* = *LP cost*.

Implied valuation: For any piece of a company, the implied valuation of that piece is its valuation, as implied by the **VCV** model, under the assumption that the most recent investors paid fair value, *LP valuation* = *LP cost*.

Infinite games: Games with an infinite number of **decision nodes** for at least one player. (See also **Finite games**.)

Initial public offering (IPO): A company's first sale of securities in public markets. Historically, IPOs have been the most lucrative **exits** for **VCs**.

In-kind distributions: (= **Stock distributions**) The distribution of stock to **limited partners**. The alternative to an in-kind distribution is a **cash distribution**.

Integrated markets: When all investors can make investments in any country, we say that financial markets are integrated. (See also **Segmented markets**.)

Internal rate of return (IRR): Start with a stream of cash flows. Compute the **NPV** of these cash flows as a function of the **discount rate**. The discount rate that makes this NPV equal to zero is the **IRR**.

In the money: If the price of an **underlying asset** is above (below) the **strike price** for a **call (put) option**, we say that the option is in the money. (See also **Out of the money**.)

Invested capital: At any point during the life of a fund, invested capital is equal to the total amount of capital that has already been invested in **portfolio companies**. For a fund that has reached the end of its life, invested capital is equal to **investment capital**.

Investment capital: The difference between **committed capital** and **lifetime fees**.

Investment: The amount of cash invested by the **fund** in a specific **round** of investment.

Investment multiple: (= **Absolute return**, = **Realization ratio**, = **Value multiple**)

Investment period: (= **Commitment period**)

Investment rate (IR): (= **Plowback ratio**, = **Reinvestment rate**) The percentage of a company's earnings that is reinvested into the capital stock of the company.

Investor expropriation: (= **Expropriation**, = **Self-dealing**, = **Tunneling**)

Investor Rights Agreement: The portion of the **term sheet** that lists any special rights of the investors.

IPO: Acronym for **initial public offering**.

IR: Acronym for **investment rate**.

IRR: Acronym for **internal rate of return**.

IV_{pre} : Abbreviation for **implied pre-valuation**.

IV_{post} : Abbreviation for **implied post-valuation**.

J-curve: (= **Hockey stick**).

Later-stage: The definitions of **early stage**, **midstage** (= **Expansion stage**), and later stage are imprecise. The NVCA definitions (Exhibit 1-5) indicate that "capital in this stage is provided for companies that have reached a fairly stable growth rate; that is, companies that are not growing as fast as the rates attained in the expansion stages".

Late-stage fund: A **fund** that invests predominantly in **late-stage** companies. (See also **Early stage fund**, **Multistage fund**.)

LBO: Acronym for **leverage buyout**.

Lead investor: In a **round** of investment, there may be multiple investors that form a **syndicate**. In this case, one of the investors will typically take the lead in organizing the syndicate and negotiating with the **portfolio company**. If the syndicate receives a single board seat, then this seat will typically be filled by the lead investor.

Leader-follower games: A game where one player (the leader) would like to play the same strategy as the other player (the follower), whereas the follower would like to play a different strategy than the leader. Notwithstanding the temporal implications of its name, leader-follower games are typically **simultaneous games**.

Least-squares regression: A statistical technique where the analyst attempts to find the best equation to explain a set of data.

Leveraged buyouts (LBOs): When a company is purchased using a significant amount of debt.

Levered beta: A **beta** estimated from a **factor model** regression using the returns of a levered asset. If a company has any debt, then the stock of that company is a levered asset. (See also **Unlevered beta**.)

License: (= **R&D licensing agreement**) A contract between a technology provider (**licensor**) and a user of that technology (**licensee**). The license agreement may be

exclusive (only the licensee can use the technology) or nonexclusive (the licensor is free to license the technology to other users).

Licensee: The user of technology in a license.

Licensor: The technology provider in a license.

Lifetime fees: The total amount of **management fees** that will be paid by **limited partners** over the lifetime of a **fund**.

Limited partner (LP): In a **private equity fund**, the **limited partners** provide the capital, which is then invested by the **general partner**.

Linear model: A model without any nonlinear interactions between any of the input variables. For example, if X and Y are input variables that determine Z , then $Z = 2X + 2Y$ would be a linear model, whereas $Z = 2X * 2Y$ would be a **nonlinear model**.

Liquidation: (= **Deemed liquidation event**)

Liquidation preference: In its simplest meaning, a liquidation preference describes the order in which different security holders are paid in the event of a **liquidation**. For example, if we say that the **Series B preferred stock** has a liquidation preference to the **Series A preferred stock**, which in turn has a liquidation preference to the **common stock**, we are saying that B gets paid before A, which gets paid before the common stock holders. In a more complex meaning of the term, some preferred stock holders may have an **excess liquidation preference**, which provides a multiple of the **aggregate purchase price** in a liquidation. Thus, we could say that Series B has a liquidation preference to Series A, which has a **2X liquidation preference** to the common stock. In this case, we are saying that Series B gets paid back its aggregate purchase price before Series A, which then receives two times its aggregate purchase price before the common stock holders get anything.

Liquidation return: The return on **preferred stock** in the event of a **deemed liquidation event**.

Liquidity risk: The **systematic risk** for an asset that corresponds with movements in a liquidity **factor**. (See also the **Pastor-Stambaugh model**.)

Lockup: An agreement between the **underwriter** of an **IPO** and the prior investors in the company that prevents these prior investors from selling any of their shares for some lockup period that follows the IPO.

Log return: (= **Continuously compounded return**) The natural logarithm of a **periodic return**.

Long position: The ownership of a positive amount of an asset. (See also **Short position**, **Zero-cost long-short portfolio**.)

LP: Acronym for **limited partner**.

LP cost: The all-inclusive cost to **limited partners** of a **fund** investment: $LP\ cost = \$investment * (committed\ capital / investment\ capital)$.

LP valuation: The valuation, using **option** pricing methods, of the **LP's** stake in an investment. (See also **GP valuation**, **Partial valuation**.)

LP valuation equation: The equation, expressed as a portfolio of **options**, for the **LP valuation**.

Management carve out: At the time of an **exit**, the portion of proceeds reserved for current management. Management carve outs are common in cases where managerial stock **options** are **out of the money** at exit.

Management fees: Regular payments made by **limited partners** to **general partners** intended to cover the fixed costs of operating the **fund**.

Management test: “Does the current management have the capabilities to make this business work?” Along with the **market test**, the management test is one of the two big-picture questions about any potential investment.

Market cap: (= **Equity market value** = **Market capitalization**) For public companies, the market capitalization is equal to the total market value (price per share times shares outstanding) of a company’s **common stock**.

Market capitalization: (= **Equity market value** = **Market cap**).

Market portfolio: In theory, the market portfolio in the **CAPM** includes all risky assets in every market around the world. In practice, most analysts include only the **common stocks** in a single country (for a **domestic CAPM**) or in all major world markets (for a **global CAPM**).

Market premium: The expected **excess return** on the **market portfolio**.

Market risk: (= **Nondiversifiable risk**, = **Systematic risk**) Market risk is the component of asset risk that cannot be diversified away. In the **CAPM**, market risk is described by the **beta** of the security.

Market test: “Does this venture have a large and addressable market?” Along with the **management test**, the market test is one of the two big-picture questions about any potential investment.

Market valuation: Any valuation method that relies on current market prices for a company’s securities. The market cap is an example of a market valuation for a public company; the **implied valuation** is an example of a market valuation for a private company.

Mean: The expected value of a random variable.

Method of multiples: (= **Comparable analysis**, = **Multiples analysis**, = **Relative valuation**)

Mezzanine: This has two meanings within **private equity**—in both cases the meanings rely on a generic definition of mezzanine as “middle”. In the first meaning, mezzanine refers to the “middle of capital structure”, as in **subordinated debt**. This debt is typically purchased by specialized mezzanine lenders in **leveraged buyout** transactions. In the second meaning, mezzanine refers to the “middle of a company’s development”, as in the last private financing round before an **IPO**. This second meaning of mezzanine has gone out of favor in recent years, with most investors substituting terms like **growth capital**, **expansion stage**, or **late stage**.

Midstage: (= **Expansion stage**) (See also **Early-stage**, **Late-stage**.)

Midyear correction: In many **DCF** models, analysts estimate a single cash flow at the end of each year. Because these cash flows would in reality be spread across the year, many analysts shift all cash flows back by six months. This can be accomplished by a single multiplication of the uncorrected **NPV** by $(1 + r)^{1/2}$, where r is the **discount rate**.

Milestone payments: Payments made to a licensor based on achievement of specific milestones. In drug development, typical milestones are the achievement of **Phase II**, **Phase III**, and **FDA approval**. (See also **Royalty payments**, **Up-front payments**.)

Minimax solution: In game theory, the solution method where one player seeks to minimize the maximum payoff of the other player.

Mixed strategy: In game theory, a **strategy** that includes more than one **pure strategy**, with each pure strategy played with positive probability.

Mixed-strategy NE: A **Nash equilibrium** where at least one player uses a **mixed strategy**. (See also **Pure-strategy NE**.)

Modified VC method: An adjustment to the *standard VC method* where the analyst explicitly take account of **management fees** and **carried interest**.

Monitoring: The collection of **VC** activities to watch over and help **portfolio companies**.

Monte Carlo analysis: (= **Monte Carlo simulation**) The estimation of expected value by computing the average from a simulated sample of observations.

Monte Carlo simulation: (= **Monte Carlo analysis**)

Multifactor models: A model where **expected returns** are determined by **factor loadings** on a set of **factors**. The **Fama-French Model** is an example of a multifactor model, with three **factors** related to the **market premium**, the size of the company, and the growth prospects of the company. (See also **Pastor-Stambaugh model (PSM)**.)

Multiples analysis: (= **Comparable analysis**, = **Method of multiples**, = **Relative valuation**)

Multiple of money: When multiple of money is used in regard to **fund** returns, it means the same thing as **absolute return**, **realization ratio**, and **times money**. When a multiple of money (= X) is used in regard to the return on a specific **VC** investment, it means “for every dollar we invested, we got back $\$X$.”

Multistage fund: A **VC fund** that invests across all **stages**. (See also **Early stage fund**, **Late-stage fund**.)

Narrow-base formula: One of the methods used to compute the **adjusted conversion price** under **weighted average antidilution protections**. The narrow-base formula provides larger adjustments than does the **broad-base formula**.

Nash equilibrium (NE): In game theory, where all players are choosing **best responses** to the **strategies** of the other players. In a NE, no player can benefit by changing his strategy.

National Venture Capital Association (NVCA): The main organization for venture capitalists in the United States.

NE: Acronym for **Nash equilibrium**

Net contributed capital: At any given time in the life of the **fund**, net contributed capital is equal to **contributed capital**, less the cost basis of all exited and written-off investments.

Net income: (= **Earnings**, = **Net profits**)

Net invested capital: At any given time in the life of the **fund**, net invested capital is equal to **invested capital**, less the cost basis of all exited and written-off investments.

Net investment (NI): The net amount added to a company’s capital stock in a period: net investment = gross investment – depreciation.

Net profits: (= **Earnings**, = **Net income**)

Net return: Return computed after taking account of **management fees**, **carried interest**, and any other investment costs.

NI: Acronym for **net investment**.

Nodes: In a **tree**, **decision nodes** signify where a player must make a move and **risk nodes** signify where uncertainty is resolved.

Noncumulative dividends: Dividends that do not accrue across periods. (See also **Cumulative dividends**.)

Nondiversifiable risk: (= **Market risk**, = **Systematic risk**)

- Nonlinear model:** A model with nonlinear interactions between any of the input variables. For example, if X and Y are input variables that determine Z , then $Z = 2X + 2Y$ would be a **linear model**, whereas $Z = 2X * 2Y$ would be a nonlinear model.
- Normal form:** A matrix representation of a game. In a two-player game, one player's **strategies** are represented in the columns and the other player's strategies are represented in the rows.
- Normative analysis:** Research about how things "should" be. In contrast, **positive analysis** is research about how things actually are.
- NVCA:** Acronym for the **National Venture Capital Association**.
- Operating assets:** Company assets that are necessary for the production of goods and services.
- OPP:** Acronym for **original purchase price**.
- Option to abandon:** A **real option** to abandon a project after it has been started.
- Option to delay:** A **real option** to begin a project at a later date.
- Option to expand:** A **real option** to expand a project at a later date.
- Option to extend:** A **real option** to extend a project at a later date.
- Option to shrink:** A **real option** to shrink a project at a later date.
- Option to switch:** A **real option** to switch the underlying production process.
- Option tree:** A type of **binomial tree** showing the values of an **option** at each point in time. (See also **Base tree**.)
- Original purchase price (OPP):** The price per share paid in a transaction. (See also *Aggregate purchase price (APP)*.)
- Out of the money:** If the price of an **underlying security** is below (above) the **strike price** for a **call (put) option**, then the option is out-of-the-money. (Also see **In the money**.)
- Partial valuation:** The valuation of the **fund's** stake, using **option-pricing** methods. (See also *Total valuation*.)
- Participating convertible preferred (PCP):** **Convertible preferred** stock that is entitled to a **liquidation return**, which includes both its **redemption value** and **as-if conversion** into **common stock**. PCP is forced to convert to common stock in the event of a **qualified public offering**.
- Participating convertible preferred with cap (PCPC):** Identical to **PCP**, except that the **liquidation return** is capped, even if there is no **qualified public offering**.
- Pastor-Stambaugh Model (PSM):** A **multifactor model** with four **factors** related to the **market premium**, the size of the company, the growth prospects of the company, and the **liquidity risk** of the company. (See also **Fama-French Model (FFM)**.)
- Payment-in-kind (PIK) dividends:** (= **Stock dividends**) Dividends that are paid in stock.
- Payoffs:** In a **tree**, we refer to all cash flows, positive and negative, as payoffs.
- PCP:** Acronym for **participating convertible preferred**.
- PCPC:** Acronym for **participating convertible preferred with cap**.
- PDF:** Acronym for **probability density function**. This acronym was around for a long time before Adobe software.
- Performance-evaluation regression:** The estimation of a **factor model** on returns generated by an investment manager. The estimate of **alpha**—the **abnormal return**—is then interpreted as the performance of the manager.

Periodic return: The return over a set time period from $t - 1$ to t : $R_t = (P_t + D_t)/P_{t-1}$, where R is the periodic return, P is the price, and D is the dividend (if any).

Perpetuity: A constant payment in every period, forever.

Personal valuation: An analyst's opinion about the value of an asset. This personal valuation may rely almost exclusively on the analyst's forecasts (as in **absolute valuation**), or it may use market information from similar assets (as in **relative valuation**). In contrast, a **market valuation** relies exclusively on information embedded in the price of the actual asset or **derivative** securities for the asset.

Phase I: The first phase of clinical trials for a drug. Phase I trials test for the safety of the drug using healthy volunteers. (See also **FDA approval**.)

Phase II: The second phase of clinical trials for a drug. Phase II trials test for efficacy and safety of the drug using patients who have the relevant disorder. Phase II trials differ from **Phase III** trials in that the latter are much larger, take longer, and are more expensive. (See also **FDA approval**.)

Phase III: The third and final phase of human trials for a drug. Phase III trials test for efficacy and safety of the drug using patients who have the relevant disorder. **Phase II** trials differ from Phase III trials in that the latter are much larger, take longer, and are more expensive. (See also **FDA approval**.)

Piggyback registration rights: Rights that allow **preferred stock** holders to "piggyback" and sell their shares in an already scheduled **registered transaction**. Piggyback registration rights are weaker than demand registration rights, because the former cannot create a new transaction, but must rely on other investors obtaining a registered transaction. (See also **Registration rights, S-3 registration rights**.)

PIK: Acronym for **payment-in-kind**

Pitch meeting: A meeting where entrepreneurs attempt to sell VCs on making an investment in their company.

Plowback ratio: (= **Investment rate (IR)**, = **Reinvestment rate**)

Portfolio company: A company that has received VC investment and has not yet been exited.

Positive analysis: Research about how things "actually are". In contrast, **normative analysis** is research about how things "should be".

Postboom period: In this book, the period since 2001. (See also *Preboom, boom*.)

Postmoney valuation: The *\$investment* divided by the **proposed ownership percentage**. (See also **Premoney valuation**.)

Preboom: In this book, the period before 1995. (See also **Boom, Postboom periods**.)

Preclinical: The stage of drug testing that precedes **clinical trials**. (See also **Phase I, Phase II, Phase III, FDA approval**.)

Preferred returns: (= **Hurdle returns**, = **Priority returns**)

Preferred stock: Equity that is above common stock in the capital structure.

Premoney valuation: The **post-money valuation** minus the *\$investment*.

Priority returns: (= **Hurdle returns**, = **Preferred returns**)

Prisoner's dilemma: A famous game used to illustrate an **arms race**.

Private equity: In its broadest meaning, private equity includes all investments that cannot be resold in public markets. In its more narrow meaning, private equity refers to a class of

investments, managed by private equity **firms**, which make investments in **VC**, **leveraged buyouts**, **mezzanine**, or **distress**.

Probability density function (pdf): For a **discrete random variable**, the pdf evaluated at point x is the probability that the random variable is exactly equal to x . For a **continuous random variable**, the definition is more subtle. In standard continuous distributions, there are an infinity of possible outcomes, so the probability of any one outcome is vanishingly small. To obtain probabilities from continuous functions, we need to integrate that function over some range. The pdf is the function that we integrate: its inputs are not exactly probabilities, but are equivalent to probabilities if integrated over a unit interval.

Proceeds: The amount of value (in cash and stock) that is received in an **exit**.

Proposed%: The shorthand we use in equations to represent the *proposed ownership percentage*.

Proposed ownership percentage (= Proposed%): In any given transaction, the proposed ownership percentage represents the percentage of **fully diluted** shares that the **VC** is proposing to buy.

Proprietary deal flow: When a **private equity** investor receives investment opportunities that are not offered to anyone else, we say that he has proprietary deal flow. (See also **Deal flow**, **Sourcing**.)

PSM: Acronym for **Pastor-Stambaugh model**.

Pure strategy: In game theory, if a player chooses the same move every time, we say that he is playing a pure **strategy**. In contrast, a **mixed strategy** is a combination of several moves, each with a positive probability of being played.

Pure-strategy NE: A **Nash equilibrium** where all players choose **pure strategies**.

QIBs: Acronym for **qualified institutional buyers**.

QPO: Acronym for **qualified public offering**.

QREs: Acronym for **qualified research expenses**.

Qualified Institutional Buyers (QIBs): Large institutional investors, who are permitted to purchase securities under exceptions to the SEC's **registration** rules. The main class of QIBs are institutions that manage more than \$100M.

Qualified public offering (QPO): An **IPO** above a minimum size and above a minimum per-share price. These minimums are specified in the **term sheet**.

Qualified Research Expenses (QREs): **R&D** expenses that qualify for the **R&D tax credit** in the United States.

r: Symbol for the **cost of capital**.

R: Symbol for the **return on capital**

R&D: Acronym for **research and development**.

R&D licensing agreement: (= **License**)

R&D tax credit: A program by a government to reduce the tax liability of companies in some proportion to their **R&D** expenses. In the United States, the federal government provides the largest tax credit, and many states and municipalities have smaller programs.

Raised: (= **Closed**)

Random-expiration (RE) option: An **option** with a random and unknown **expiration date**.

Random-expiration binary call option (BC(X)): A **binary call option** with a random and unknown **expiration date**.

Rapid-growth period: In the *reality-check DCF model*, the rapid-growth period is between **exit** and **graduation**.

RE option: Abbreviation for *random-expiration option*.

Reading the exit diagram: The translation of an *exit diagram* into a portfolio of *random-expiration options*.

Real options: An **option** on a real asset. In contrast, financial options are options on financial assets.

Reality-check DCF: A model that uses aggressive data-driven assumptions for growth, margins, and capital efficiency in order to get an **absolute valuation** for the **exit value**.

Realization ratio: (= **Investment multiple**, = **Absolute return**, = **Value multiple**)

Realized return: This term has two meanings: The first meaning, which is generic for all finance, is a synonym for **historical returns**. The second meaning, specialized for **private equity**, refers to a **fund's** returns from all **exited** investments. (See also **Unrealized returns**.)

Recombine: If a **binomial tree** recombines, then each additional step in the **tree** only adds one additional branch. In a nonrecombining tree, each additional step doubles the number of branches. In the **CRR model**, the up moves and down moves are reciprocals of each other. Thus, from any starting price, if an underlying asset follows an up move with a down move, the **base tree** recombines at the starting price. If the **underlying asset** pays a dividend that is proportional to the stock price, then the tree will recombine at a price slightly below the starting price. If the underlying asset pays a fixed cash dividend, then the tree does not recombine.

Redeemable preferred (RP): Preferred stock that pays a **redemption value** on **liquidation**, but does not offer the holder the option of conversion to **common stock**.

Redemption: The act of turning in **preferred stock** in return for the **redemption value**.

Redemption rights: The right of **preferred stock** holders to redeem their stock outside of a **deemed liquidation event**. This right is usually less powerful in practice than it is on paper because **preferred stock** holders, as equity investors, do not have the power to force a company into bankruptcy if the company cannot pay the redemption.

Redemption value (RV): The amount paid to the holder of **preferred stock** on redemption. In the absence of dividends or **excess liquidation preferences**, the redemption value is equal to the **aggregate purchase price**.

Redemption Value per Share (RVPS): The **redemption value** of for a specific class of **convertible preferred** stock divided by the number of shares of **common stock** on conversion of that class.

Registration rights: As specified in the **term sheet**, registration rights give the holders the power to sell some of their shares in a **registered transaction**. These rights come in several different strengths, with **demand registration rights** being the strongest. (See also **S-3 registration rights**, **Piggyback registration rights**.)

Registered transaction: A transaction on a public exchange that has been approved by the Securities and Exchange Commission. Restricted stock becomes **unrestricted** after it is sold in a registered transaction.

Reinvestment rate: (= **Investment rate (IR)**, = **Plowback ratio**)

Relative valuation: The valuation of an asset based on the **market values** of similar assets. (See also **Absolute valuation**.)

Replicating portfolio: A combination of **risk-free** bonds and risky assets that provides exactly the same payoffs as a **derivative asset**.

Required investment: The amount of capital needed for a round of **VC** investment.

Research and development (R&D): Investment made in **basic research**, **applied research**, or **development projects**.

Restricted stock: Stock that cannot be sold in a public market, except through a **registered transaction** or through a **Rule 144** exception to the registration rules. Once a stock has been sold in a registered or Rule 144 transaction, it becomes **unrestricted stock**.

Restrictive covenants: Contractual terms in **limited partnership** agreements that restrict the activities of the **general partner**.

Return on capital (R): For a company, the return on capital is an (adjusted) operating profit divided by operating assets. For an investment manager, the return on capital is the **periodic return** on the assets under management.

Return on investment (ROI): For a company, ROI is defined the same way as **R**, except that the profits and assets are measured only for the newly invested capital.

Right of first offer: If Investor X has a right of first offer for investor Y's shares, then Y must give X the option to bid on Y's shares before those shares are offered to anyone else. If Y turns down X's offer, then she can sell her shares to other investors, but only if she obtains a price above X's initial offer. (See also **Take-me-along = Tagalong**, = **Right of first refusal**, = **Dragalong**, = **Transfer restrictions**.)

Right of first refusal: The right of first refusal is more powerful than the **right of first offer**. If Investor X has a right of first refusal for investor Y's shares, then Y must give X the option to buy on Y's shares at any price that Y has negotiated with an outside bidder. In this case, few outside bidders are likely to make an offer because they know that X can just come in and take away the deal. (See also **Take-me-along = Tagalong**, = **Right of first offer**, = **Dragalong**, = **Transfer restrictions**.)

Risk-free rate: The rate of return on securities that have no **systematic risk**. In the United States, federal government debt is often considered to be risk free (= **riskless rate**).

Riskless rate: (= **risk-free rate**).

Risk-neutral: We say that an investor is risk-neutral if her utility function in wealth is a straight line.

Risk-neutral probabilities: The probabilities that would have to exist if all investors were risk-neutral and asset prices were the same as in the real world.

Risk factor: (= **Factor**)

Risk node: The point in a **tree** where uncertainty is resolved along multiple **branches**.

ROI: Acronym for **return on investment**

Round: (= **Financing round**)

Royalty payments: When a product is sold as part of a **license** agreement, the **licensee** will sometimes pay a percentage of sales or gross profit to the **licensor**. (See also **Milestone payments**, **Up-front payments**.)

RP: Acronym for redeemable preferred.

Rule 144: A Securities and Exchange Commission rule that provides exceptions that allow the public sale of (otherwise) **restricted stock**.

Rule 144A: A Securities and Exchange Commission rule that allows the private sale of **restricted stock to qualified institutional buyers.**

RV: Acronym for *redemption value*.

RVPS: Acronym for *redemption value per share*.

S-3 registration rights: A type of **demand registration right** that only takes effect once the company is already public. S-3 rights are weaker than regular demand registration rights because the former cannot be used to force a private company to go public. (See also **Demand registration rights, Piggyback registration rights, Registration rights.**)

Sand Hill Econometrics (SHE): A company that produces the Sand Hill Index[®] and its successor (DowJones Index of Venture Capital), a **gross-return** index for the VC industry.

Sand Hill Road: The street in Menlo Park, California, that is home to many of the world's top VC firms.

Screening: The activities of analyzing companies, performing **due diligence**, and making investment decisions.

Second Round (Series B): The second occurrence of VC investment. (See also **Financing Round, First Round (Series A).**)

Seed stage: An investment in an idea that has not yet become a company. Seed-stage investments are typically made by **angels**, not by VCs.

Segmented markets: When investors in countries A and B are unable to make investments in the other country, we say that these two markets are segmented (See also **Integrated markets.**)

Self-dealing: (= **Expropriation, = Investor expropriation, = Tunneling**).

Sequential game: A game where players take turns making moves. (See also **Simultaneous game.**)

Series: In VC transactions, **preferred stock** is referred to by a series letter: Series A, Series B, etc. The letter usually refers to the **round** of investment, with Series A referring to **first round** and Series B referring to **second round**, etc. Most of the time that a VC refers to a "Series A" investment, they mean this as a synonym for "first round". Nevertheless, in some cases, a VC round will include multiple series, so it is possible for the first round of investment to include shares labeled as Series A and as Series B.

SHE: Acronym for **Sand Hill Econometrics**.

Short position: The ownership of a negative amount of an asset. (See also **Long position, Zero-cost long-short portfolio.**)

Simple interest: Interest that does not compound (i.e., 5 percent simple interest on \$100 would pay \$5 every year, even if the previous payments were accrued to the face value). (See also **Compound interest.**)

Simultaneous game: A game where players make moves at the same time. (See also **Sequential game.**)

Sourcing: The activities performed by VCs to generate **deal flow**.

Special situations: (= **Distress investing**)

SPNE: Acronym for **subgame-perfect Nash equilibrium**.

Stable-growth period: In the *reality-check DCF model*, the stable-growth period follows *graduation*.

- Stale values:** When live **VC funds** report their performance, active investments are usually reported at the **postmoney valuation** of their most recent **round**. Because many of these companies have had material changes since the last round, we say that these values are stale. When evaluating the performance of the VC industry using a **factor model**, we adjust for stale values by including past observations of the **factors** in the regression.
- Standard VC method:** The name for the group of techniques used by **VCs** to make investment decisions. The main idea of the standard VC method is to estimate a value for the company conditional on a **successful exit**, and then discount that value back to the present using a high **target rate of return**. (See also **Modified VC method**.)
- Star fund:** A **VC fund** with **committed capital** of at least \$50M and a **value multiple** of five or greater.
- Startup stage:** A pre-marketing stage of company development that may involve product development, market research, building a management team, and developing a business plan.
- Step vesting:** When some set percentage of **options** (or stock) becomes **vested** on a specific date (e.g., if options are 25 percent step vested each year, then the vesting increases from 25 percent to 50 percent to 75 percent to 100 percent over a four-year period). (See also **cliff vesting**.)
- Stock dividends:** (= **Payment-in-kind (PIK) dividends**)
- Strategic alliance:** A long-term contract between two companies that facilitates work toward a common goal.
- Strategic investing:** Investing with goals beyond the maximization of financial returns.
- Strategy:** A complete description of a player's choices at every **decision node**.
- Strategy pair:** The strategies of both players in a two-player game.
- Strike price:** (= **Exercise price**) The price that is paid (received) to purchase (sell) stock when a **call (put) option** is exercised.
- Style adjustments:** Adjustments made to the **CAPM** to reflect differential risks for various classes of stocks. The style adjustments in the **Pastor-Stambaugh model** are for size, value, growth, and liquidity.
- Subgame-perfect Nash equilibrium (SPNE):** A set of strategies that represent **Nash equilibria** on all **subgames**.
- Subgames:** A subgame includes any collection of **decision nodes** that can be "snipped" from the **extensive form** without cutting a closed curve around those nodes.
- Successful exit:** An **exit** where the company has executed on optimistic (but reasonable) expectation from the time of the **VC** investment. Most successful exits end with an **IPO** or high-value acquisition.
- Superstar fund:** A **VC fund** with **committed capital** of at least \$50M and a **value multiple** of ten or greater.
- Survivor bias:** A statistical bias caused when the data sample includes a disproportionate number of entries from surviving entities. For example, there would be survivor bias if a database of **VC funds** was more likely to include historical data from long-lived **VC firms**.
- Syndicate:** When multiple **VCs** invest in the same round, we call this group a syndicate.
- Systematic risk:** (= **Market risk**, = **Nondiversifiable risk**)

- Tagalong:** (= **Take-me-along**) If shareholder A has a tagalong right relative to shareholder B, then A can force B to include A in any sale of shares made by B. Typically, this right gives A a *pro rata* claim on any stock sales. (See also **Right of first offer**, **Right of first refusal**, **Dragalong**, **Transfer restrictions**.)
- Takedown:** (= **Capital call**, = **Drawdown**)
- Take-me-along:** (= **Tagalong**) (See also **Right of first offer**, **Right of first refusal**, **Dragalong**, **Transfer restrictions**.)
- Target multiple of money:** The average **multiple of money** that a VC expects in a *successful exit*. The target multiple of money is a key input in the **venture capital method** of valuation.
- Target return:** Similar to the **target multiple of money**, but expressed as an annual return.
- Technical risks:** In R&D investment, the risks that the project will fail for nonmarket reasons, usually scientific or engineering failures. (See also **Business risks**, **Competitive risks**.)
- Term Sheet:** The summary document describing the key terms of a proposed VC investment. (See also **Charter**, **Investor Rights Agreement**.)
- Terminal node:** A final point on a **game tree**. (See also **Decision node**, **Risk node**.)
- Times money:** (= **Absolute return**, = **Value multiple**, = **Multiple of money**)
- Top-quartile fund:** A fund with an **IRR** among the top 25 percent of all **funds** in the same **vintage year**.
- Top-tier firm:** A generic industry term meant to denote a high reputation **firm**. In this book, we classify six Tier A firms and nine Tier B firms in Exhibit 5-2 of Chapter 5.
- Total valuation:** An analyst's *personal valuation* for an entire company. (See also **Partial valuation**.)
- Tranche:** Generically, within finance a tranche refers to a slice of the capital structure of a company or security offering. Within VC, a tranche refers to a slice of a financing round, with different tranches delivered to the portfolio company at different times.
- Transfer restrictions:** Any restriction that prevents a shareholder from selling any part of her shares. (See also **Take-me-along** = **Tagalong**, = **Right of first offer**, = **Right of first refusal**, = **Dragalong**.)
- Trees:** Generically, a perennial woody plant with a main trunk. Within economics, a graphical representation of decisions and risks. (See also **Event trees**, **Decision trees**, **Binomial trees**, **Game trees**.)
- Tunneling:** (= **Investor expropriation**, = **Self-dealing**)
- Two-by-two games:** Games with two players each with two possible **strategies**.
- Underlying asset:** An asset on which an **option** has been written. (See also **Derivative assets**.)
- Underwriter:** Financial intermediary that takes possession of an asset or a risk. In capital markets, this possession is of a very short duration, with the assets transferred to the ultimate investors. In these markets, the underwriter's main job is to identify and sell to these ultimate investors.
- Unlevered beta:** A **beta** estimated from a **factor model** regression for an unlevered asset. The equity in an all-equity company is an unlevered asset.

- Unrealized returns:** In a **VC fund**, the unrealized returns are the estimated returns from investments that have not yet been **exited**. (See also **Realized returns**.)
- Unrestricted stock:** Stock that can be sold to any investor in a public market.
- Upfront payments:** Payments from a **licensee** to a **licensor** made at the beginning of a **license agreement**. (See also **Milestone payments**, **Royalty payments**.)
- Value multiple:** (= **Investment multiple**, = **Realization ratio**, = **Absolute return**)
- Variance:** A measure of the dispersion of a random variable. (See also **Covariance**.)
- VC:** Acronym for **venture capital** and for **venture capitalist**.
- VCs:** Acronym for **venture capitalists**.
- VC firm:** (= **Firm**)
- VC fund:** (= **Fund**)
- VCV model:** A Web-based model, developed as a companion to Part III of this book, which can be used to estimate *partial valuation*, *LP valuation*, *GP valuation*, and *implied valuation*.
- Venture capital (VC):** Capital used by specialized financial intermediaries for investment in private companies with the intention of helping these companies to grow.
- Venture capitalists (VCs):** Financial intermediaries who invest in and monitor private companies with the intention of helping these companies to grow.
- Venture capital method of valuation:** The name for the group of techniques used by **VCs** to make investment decisions. The two versions studied in this book are the *standard VC method* and the *modified VC method*.
- Venture period:** In the *reality-check DCF model*, the period that precedes the **exit**.
- Vesting:** In **VC** transactions, managerial stock ownership and **option** claims are typically granted over time, in a process called vesting. For specific rules of vesting, see the entries for **cliff vesting** and **step vesting**.
- Vintage year:** Typically defined as the calendar year that a **VC fund** began investing. Fund performance is often compared with other funds with the same vintage year.
- $W_A(\text{cap})$:** Equation shorthand for the *cap point*.
- Weighted-average antidilution:** A version of **antidilution protection**, where the **adjusted conversion price** is a weighted average of prices paid by all investors. (See also **Broad-base formula**, **Narrow-base formula**, **Full-ratchet antidilution**.)
- Zero-cost long-short portfolio:** A portfolio with an equal amount of investment on both **long** and **short positions**. These zero-cost portfolios are used to construct factors.
- Zero-sum games:** A game where the sum of the **payoffs** to all players is zero. (See also **Constant-sum games**.)

INDEX

- Abnormal returns, 68, **512**
 - negative, 68
 - positive, 68
- Absolute return, 55, **512**
- Absolute valuation, 179, **512**
- Accel Partners, 89
- Accrued cash dividends, 153, 282–284, **512**
- Adjusted conversion price, 173, **513**
- Adjusted conversion rate, 173, **513**
- Aggregate purchase price (APP), 149, 252, **513**
- Alpha, 67, 74, 79, **513**
- Alternative investments, 5, 7–8
- American option pricing, 242–243, **513**
- American Research and Development Corporation (ARD), 10
- Americanization, 87
- Am-tree* worksheet, 416
- Analysis
 - normative, 431
 - positive, 431
- Angel investors/angels, 4, **513**
- Angel shares, exit diagram for, 309,
- Annualized returns, 47, **513**
- Antidilution provisions, 152, 154, 173–176
 - adjusted conversion price, 173
 - adjusted conversion rate, 173
 - full-ratchet, 173
 - weighted-average, 173
- Applied research, 342, **513**
- Arbitrage, 237
- Arms races, 424, **513**
- As-if conversion, **513**
- Assets
 - derivative, 232, **516**
 - underlying, 232, **533**
- At the money, 242, **513**
- AUTO Calculator, 255, 484
- Banana utility
 - with bird risk, 70
 - with weather risk, 72
- Barriers to entry, 205, **513**
- Base trees, 403, **513**
 - base-tree* worksheet, 407, 412
- Base-case option-pricing assumptions, 253–254
- Basic research, 342, **513**
- Battery Ventures, 91
- BC(X)*, **513**
- Benchmark Capital, 89, 126, 138
- Best response, 423, **513**
- Best VCs, 83–98. *See also* Portfolio firms
 - Group A, 89–91
 - Accel Partners, 89
 - Benchmark Capital, 89
 - Charles River Ventures, 90
 - Kleiner Perkins Caufield & Byers (KPCB), 90
 - Matrix Partners, 91
 - Sequoia Capital, 91
 - Group B, 91–95
 - Battery Ventures, 91
 - Doll Capital Management (DCM), 92
 - Draper Fisher Jurvetson (DFJ), 92
 - Institutional Venture Partners, 93
 - InterWest Partners, 93
 - Menlo Ventures, 93
 - New Enterprise Associates (NEA), 93–94
 - Summit Partners, 94
 - Technology Crossover Ventures (TCV), 94
- Beta, 66, 74, 79, **513**
- Binary options, 291–292, 386, **513**
- Binomial trees, 355, 400–418, **513**. *See also*
 - Black-Scholes equation; Dividends
 - base tree, 403
 - CRR model, 406

- Binomial trees (*continued*)
 - dividends, 411–417
 - multiple strike prices and early exercise, 409–411
 - warrants, 409
 - option tree, 403–404
 - recombine feature, 403
- Bintree.xls* spreadsheet, 406–410
- Black-Scholes equation/formula, 231, 238–242, 244, 250–251, 368, 400–408, **513**
 - binomial trees and, 400–408
- Board of Directors, 160
- Board representation, 95–96, 157
- Bond values, 235
- Boom period, 12–13, **513**
- Branches, event tree, 358, **514**
- Breakeven valuation, 252, **514**
- Broad-base formula, 174, **514**
- Burn rate, 143, **514**
- Business plan, 137, **514**
- Business risks, 347, **514**
- Busy boards, 96
- Buyout, 99

- California Public Employee Retirement System (CALPERS), 61
- Californization, 88
- Call option, 40, 232, **514**
 - in a decision tree, 401
 - delay, 381
 - expand, 381
 - extend, 381
- Cambridge Associates (CA), 50, 59, 112, 118, 124, **514**
- Cap point, 169, **514**
- Capital
 - calls, 21, **514**
 - contributed, 35, **515**
 - cost of, 224–226, **516**
 - net contributed, 35, **525**
 - net invested, 32, **525**
- Capital asset pricing model (CAPM), 65–69, **514**. *See also* Global CAPM
 - domestic CAPM, 112
 - least-squares regression, 67
 - market risk, 67
 - nondiversifiable risk, 67
 - performance evaluation regression, 68
 - reflecting covariance of asset's returns, 67
- Capitalization, 150
 - capitalization table, 148, **514**
- Carried interest, 11, 32–39, 247–248, **514**
 - carried interest basis, 33, **514**
 - clawbacks, 33, **515**
 - contributed capital, 35, **515**
 - net contributed capital, 35, **525**
 - percentage level of, 33
 - priority returns, 33, 35, **527**
 - refund of, 37
 - timing of, 34–35
 - write downs (partial losses), 36
- Carry basis, **514**
- Cash distributions, **514**
- Cash flow (CF), 200
- Catch-up provision, priority returns, 35–36, **514**
- Certificate of Incorporation. *See* Charter
- Channels, 142–143
- Charles River Ventures, 90
- Charter, 151–155, **514**
 - anti-dilution provisions, 152
 - deemed liquidation event, 151, **516**
 - dividends, 151, 153
 - liquidation preference, 151, 153–154, **523**
 - mandatory conversion, 152, 154
 - optional conversion, 152
 - protective provisions, 151
 - redemption rights, 152, 154–155
 - voting rights, 151, 154
- Clawbacks, 33, **514–515**
- Cli vesting, 159, **515**
- Clinical trials, 345, **515**
- Closing, 135, **515**
- Coase, Ronald, 14
- Collateralized debt obligations (CDOs), 352
- Collateralized loan obligations (CLOs), 352
- Commitment period, 21, **515**
- Committed capital, 21, **515**
 - by limited partners, 28
- Common stock, 150, 167, **515**
 - exit diagram for, 167
- Comparables analysis, 214–228, **515**
 - choice of comparable companies, 214
 - choice of valuation measures, 214
 - choosing comparable companies, 219–224
 - cost of capital estimation, 224–226
 - EV/EBIT, 215
 - EV/EBITDA, 216
 - EV/Employees, 217

- EV/Revenue, 216
- Price/Book, 217
- Price/Earnings, 216
- Compensation, venture capital, 32
- Competition, 142
- Competitive advantage, 205, **515**
- Competitive risks in drug development, 347, **515**
- Complex structures, 320–336. *See also*
 - Management carve-outs
 - dealing with partners, 327–329
 - Series F, exit diagram for, 332
- Compound interest, 153, **515**
- Compound return, 46, **515**
- Comps. *See* Comparables analysis
- Constant-sum games, 422, **515**
- Continuous probability distributions
 - simulation with, 362–373
- Continuously random variables, 357, 362, **515**
- Continuously compounded returns, 238, **515**
- Contributed capital, 35, **515**
- Conversion condition, 163–164, **515**
- Conversion-order shortcut, 278, **515**
- Conversion point, 163, **515**
- Convertible preferred (CP) stock, 163, **516**
 - conversion condition, 163–164
 - exit diagram, 164–165
 - participating convertible preferred (PCP), 165
 - participating convertible preferred with cap (PCPC), 166
 - Series A CP, 172
- Convertible preferred (CP) valuation, 261–263
 - combining RP and CP, 266–268
 - comparing RP and CP, 268–269
 - with excess liquidation preferences or dividends, 263–266
- Coordination games, 431, **516**
- Corporate Governance, 96
- Corporate venture capital, 6, **516**
- Cost basis, 32
- Cost of capital estimation, 224–226, **516**
- Cost of capital for VC, 65–82. *See also* Beta and the banana birds; Capital asset pricing model (CAPM)
 - estimating, 74–79
 - CAPM estimations for VC indices, 74
 - liquidity risk, 75, 77
 - SIZE factor, 76
 - stale values, 75, 78
 - style adjustments, 75–77
 - VALUE factor, 76
- Country beta, 113, **516**
- Country risk, 108, **516**
 - global CAPM, 116–117
- Covariance, **516**
- Crossover investing, 94, **516**
- CRR model (Cox-Ross-Rubenstein), 406, **516**
- Crystal ball[®], guide to, 487–511
 - cumulative frequency chart, 497
 - decision tables, defining, 506–511
 - decision variables, defining, 506–511
 - dynamic assumptions, defining, 505–506
 - spreadsheet setup for, 489
 - distribution gallery, 490
 - forecast, defining (Step 2), 491–492, 495, 499, 502
 - random number assumptions, defining (Step 1), 489–490, 495, 498, 500
 - results analysis (Step 5), 493, 496, 499, 502
 - simulation, running (Step 4), 493, 496, 499, 502
 - simulation run preferences, setting (Step 3), 492–493, 496, 499, 502
 - toolbar, 488
- Cultural differences, in VC activity 108
- Cumulative distribution function (cdf), 362, **516**
 - log-normal CDF, 369
 - normal CDF, 368
 - triangular CDF, 372
 - uniform CDF, 363
- Cumulative dividend rights, 153, **516**
- Currency risk, global CAPM, 115–116
- Customers, 141
- Dark Side of Valuation, The*, 195
- Deal flow, 137, **516**
 - proprietary deal flow, 137
- Decision nodes, 379, **516**
- Decision trees, 355, 379–381, **516**
 - commuting options, 379
 - with exit, 380
 - pruned, 380
 - decision nodes, 379
- Deemed liquidation event, 151, 153, **516**
- Demand registration, 155, 158, **516**

- Demand side, 83
- Derivative assets, 232, **516**
- Discounted cash flow (DCF) analysis, 180, 195–213, **517**. *See also* Graduation value; Reality-check model DCF model
 - concepts, 196–198
 - graduation, 196
 - leverage of VC-backed firms, 199
 - mechanics, 198–203
 - phases of growth, 196
 - rapid-growth period, 196
 - stable-growth period, 196
 - venture period, 196
- Discrete random variables, 357, 362, **517**
- Distress investing, 8, **517**
- Diversifiable risk, 66, **517**
- Dividend preference, 153, **517**
- Dividends, 151, 153, 259–261, 411–417
 - am-tree* worksheet, 416
 - base tree, 412
 - Fuelco's problem, 416–417
 - in later rounds, 282–285. *See also under* Later-round investments
 - option tree, 413
- Doll Capital Management (DCM), 92
- Dollar-denominated bonds, sovereign spread of, 109
- Domestic beta, 113, **517**
- Domestic CAPM, 112, **517**
- Dominant strategy, simultaneous game, 424, **517**
- Doriot, George, 10
- Dow Jones Report*, 146–148
- Down round, 154, **517**
- Down rounds, question of, 314–317
 - Series C, exit diagram for, 315–316
- Dragalong, **517**
- Draper Fisher Jurvetson (DFJ), 92
- Drawdowns, 21, **517**
- Drug development, 345–348, 445–455
 - Investigational New Drug (IND), 346
 - risks
 - business, 347–348
 - competitive, 347–348
 - technical, 347
 - stages, 345
 - FDA approval, 345
 - Phase I, 345–346
 - Phase II, 345–346
 - Phase III, 345
 - preclinical, 345
- Drugco, 395–397
 - newdrug
 - DCF model for, 397
 - decision tree for, 396
- Due diligence, 9, 135, 140, **517**
- Early stage, **517**
- EarlyBird Ventures (EBV), 22–23, 43–44
- Early-stage fund, 21, **517**
- Earnings before Interest and Taxes (EBIT), 200, **517**
- Earnings before interest, taxes, depreciation, and amortization (EBITDA), 215
- eBay, 138–139
- Economic profits, 84
- Economics of VC, 83–86
 - demand side, 83
 - supply side, 83–85
- Employee stock options, 157–159
- Energy innovation, 348–349
 - fuel cell project, 349
- Energy, 455–464
- Enterprise value (EV), 199, 215, **517**
- Entrepreneurial ecosystem, 103–104, **517**
- Entrepreneurial self-confidence, 110
- Entry game, 433
 - extensive form, 434
 - normal form, 435
- Equilibrium concepts, 423, **518**
- Equilibrium strategy, 423, **518**
- Equity betas, 225
- Equity market capitalization, 215
- Equity market value, **518**
- European Call-Option Calculator, 240
- European options, 232–234, **518**
 - call option, 232
 - European put, 233
 - expiration diagram, 233
 - put option, 234
- European put, 233, **518**
- Event trees, 355, 357–362, **518**
 - branches, 358
 - first ten draws, 359, 361
 - risk node, 358
 - with three risk nodes, 361
 - terminal node, 358
- Excess liquidation preferences, 154, 257–259
- Excess returns, **518**

- Exercise price, **518**
- Exit diagram, 164–165, **518**
reading, 245–247
- Exit diagrams, **518**
for angel shares, 309
for carried interest, 247
for common stock, 167
for employees' shares, 310
for management carve-out, 322, 325
for participating convertible preferred (PCP), 169
for participating convertible preferred with cap (PCPC), 170
reading, 245–47
for redeemable preferred (RP), 168
for remaining shares, 323, 326
for Series A, 172, 255, 258, 260, 262, 264–265, 267
for Series B, 274, 275, 313
for Series C, 315
for Series E, 322, 326
for Series F, 302
- Exit valuation, 178–180, **518**
absolute valuation, 179
relative valuation, 179
- Expansion stage, 6, **518**
- Expected holding period, **518**
- Expected retention percentage, 178, 182–183, **518**
- Expected returns, 48, **518**
- Expected terminal value, 367
- Expenses, 155
- Expiration date, 232, **518**
- Expiration diagram, 233, **519**
- Expiration, 160
- Expropriation, 104, **519**
- Extensive form, game theory, 420–421, **519**
- Factor loadings, 75, **519**
- Factor model, **519**
- Factors, 75, **519**
SIZE factor, 76
VALUE factor, 76
- Fama-French model (FFM), 75, **519**
- Fees
lifetime, 30, **523**
management, 11, 30–32, 43–45, **524**
- Financial intermediary, 3, **519**
- Financial options, 232, **519**
- Financing round, 15, **519**
first round (or Series A), 15
second round (or Series B), 15
- Finite games, 438, **519**
- Firms, 21–27, **519**
- First Round (Series A), **519**
- FLEX Calculator, 256, 484
- Folk theorem, 438, **519**
- Follow-on investments, 21, **519**
- Food and Drug Administration (FDA), 345, **519**
- Founders' stock, 160–161
- Freedom of Information Act (FOIA), 61
- Full-ratchet anti-dilution protection, 173, **520**
- Fully diluted basis, 148, **520**
- Fully diluted share count, 148, **520**
- Fund returns, 53–62
definitions, 53–59
evidence, 59–62
gross value multiple (GVM), 57–58, **520**
internal rate of return (IRR), 54, **521**
J-curve, 55–56, **522**
top-quartile fund, 60
Venture Economics (VE), 59
VE median and top-quartile returns by vintage year, 60
- Fund-of-funds (FOF), 29, **520**
- Funds, 21–27, **520**
EarlyBird Ventures (EBV), 22–23
early-stage fund, 21
general partner (GP) for, 21
late-stage fund, 21
limited partners (LPs), 21, 27–30. *See also individual entry*
multistage fund, 22
- Game theory, 419–444
coordination game, 431
description, 419–422
extensive form, 420–421
normal form, 420
normative analysis, 431
odds-and evens-game, extensive form, 422
odds-and-evens game, normal form, 422
payos, 420
positive analysis, 431
prisoner's dilemma, 419–421
and real options, 438–443

- Game theory (*continued*)
 sequential games, 420, 433–438. *See also individual entry*
 simultaneous games, 420, 423–433. *See also individual entry*
 standards game
 extensive form, 432
 normal form, 433
 strategies, 420
 zero-sum games, 422
- Game trees, 355, **520**
- Gatekeeper, 50, **520**
- General partners (GP), 3, 21–41, **520**
 income sources, 26–27
 carried interest, 26
 management fees, 26
 restrictions on activities of, 39, 41
- Geometric mean, 218, **520**
- Global beta, **520**
- Global CAPM, 112–114, **520**
 extensions to, 114–117
 country risk, 116–117
 currency risk, 115–116
 segmented markets, 117
 style adjustments, 114
 objective, 114–117
- Global distribution of VC investing, 99–111
- continental Europe and Asia lagging in,
 reasons for, 101–102
- country risk, 108
- cultural differences, 108
- entrepreneurial ecosystem, 103–104
- exits, 101
- law and corporate governance, 104–108
- dollar-denominated bonds, sovereign spread
 of, 109
- entrepreneurial self-confidence, 110
- high-tech private-equity investment,
 100–101
 Asia-Pacific region, 100
 European GDP, 100
 Israel, 100
 Sweden, 100
 United Kingdom, 100
 United States, 100
- Global Entrepreneurship Monitor*, 109–111
- Global market premium, **520**
- Global multifactor model for VC, 118–119
- Global Private Equity Report (GPER)*, 99
- Google, 138–139
- Graduation, 196, **520**
- Graduation value, 204–207, **520**
 barriers to entry, 205
 competitive advantage, 205
 return on capital as a function of NI, 205
- Gross investment, **520**
- Gross-Return Index, 48–50
- Gross returns, 47, **520**
- Gross value multiple (GVM), 57–58,
 125, **520**
 for first-round investments, 127–128
 acquisitions, 127
 IPOS, 127
 for second-round investments, 130–131
 acquisitions, 130
 IPOS, 130
 for third-round investments, 133–134
 acquisitions, 133
 IPOS, 133
- Growth capital, 7, **520**
- Growth companies, discounted-cash-flow
 analysis, 195–212
- Growth factor, **520**
- Hamilton Lane Advisors, 59
- Harmonic mean, 218, **520**
- Health care, investment pattern in, 15
- Hedge funds, 6, **521**
 private enquiry and, 7
- High-tech private-equity investment, 100
- Historical returns, 48, **521**
- History of venture capital, 10–14
 boom period, 12–13
 limited partnerships, 11
 pension funds, 12
 postboom period, 12–13
 preboom period, 12
 profit sharing, 11
- Hockey stick pattern of returns, 55, **521**
- Human Resources, 97
- Human trials, **521**
- Hurdle returns. *See* Priority returns
- Idiosyncratic risk, 66, **521**
- Implied GP valuation, 311, **521**
- Implied LP valuation, 311, **521**
- Implied partial valuation, 311, **521**
- Implied post-valuation (IV_{post}),
 305–306, **521**
- Implied pre-valuation (IV_{pre}), 311, **521**

- Implied valuation, 305–319, **521**. *See also*
 - Portfolio value, measurement; Post-money valuation
 - confusion, avoiding, 317–318
- In the money, 242, **522**
- Index
 - gross-return, 48–50
 - net-return, 50–53
- Industry, investments by, 15–18
- Industry, venture capital (VC), 3–20
 - funds flow in, 4
- Industry returns, 46–53
 - annualized returns, 47
 - compound return, 46
 - definitions, 46–48
 - expected returns, 48
 - gross returns, 47, 48–50
 - historical returns, 48
 - net-return index, 50–53
 - net returns, 47
 - periodic return, 46–48
 - realized returns, 48
- Industry Statistics*, 198
- Infinite games, 438, **521**
- Information technology (IT), investment
 - pattern in, 15
- Initial public offering (IPO), 3, 101–102, **521**
- In-kind distributions, 158, **521**
- Inputs sheet, example of, 408, 416
- Inputs tree, example of, 410
- Inputs* worksheet, 406–408, 410
- Institutional Venture Partners, 93
- Integrated markets, 111, **521**
- Interest
 - carried, 247–248
 - compound, 153, 515
 - simple, 153, 531
- Internal corporate funds for R&D, 350
- Internal growth, 6
- Internal rate of return (IRR), 54, **521**
- International VC, 111–119
 - baseline model, 112–114
 - country beta, 113
 - domestic beta, 113
 - global CAPM, 112–114. *See also individual entry*
 - cost of capital for, 111–119
 - global multifactor model, 118–119
- InterWest Partners, 93
- Invested capital, 32, **522**
- Investigational New Drug (IND), 346
- \$Investment, 148, **522**
- Investment Benchmark Reports (IBR)*, 59
- Investment capital, 30, **522**
- Investment multiple, **522**
- Investment period, 21, **522**
- Investment process, 135–144. *See also*
 - Analysis of VC investments
 - channels, 142–143
 - closing, 135
 - competition, 142
 - customers, 141
 - due diligence, 135, 140
 - management test, 137–139, 141
 - market test, 137–139, 141
 - money, 143
 - partners, 143
 - pitch meeting, 140
 - post-term-sheet step, 140
 - preterm-sheet step, 140
 - product, 142
 - projections, 142
 - screening, 135, 137, 140
 - technology, 142
 - term sheet, 135
 - terrible things, 144
 - themes, 136
 - transaction terms, 143
- Investment rate (IR), 200, **522**
- Investment recommendation, 183
- Investor director approval, matters requiring, 156, 158
- Investor expropriation, 104, **522**
- Investor Rights Agreement, 146, 155–159, **522**
 - board matters, 157
 - demand registration, 155
 - employee stock options, 157, 158–159
 - expenses, 155
 - key person insurance, 157
 - lockup, 155
 - management and information rights, 156
 - matters requiring investor director approval, 156, 158
 - non-competition and non-solicitation and agreements, 157
 - non-disclosure and developments agreement, 157
 - piggyback registration, 155
 - registrable securities, 155

- Investor Rights Agreement (*continued*)
 - registration on form S-3, 155
 - registration rights, 155, 158
 - right to maintain proportionate ownership, 156
- Investors, 148–149
- Israel, 100

- Japan, 100
- J-curve, 55–56, **522**

- Key person insurance, 157
- Kleiner, Perkins Caufield & Byers (KPCB), 61, 90

- Later stages, 16
- Later-round investments, 272–289
 - conversion order shortcut, 277–278, **515**
 - dividends in later rounds, 282–285
 - accrued cash dividends, 282–284
 - payment-in-kind (PIK) dividends, 284–285, **515**
 - Series B, 272–276
 - Series C, 278–282
 - beyond Series C, 285–288
- Late-stage fund, 21, **522**
- Latin America, 104
- Law, corporate governance and, 104–108
- Lead investor, 91, **522**
- Leader-follower game, 428, **522**
 - extensive form, 429
 - normal form, 430
- Least-squares regression, 67, **522**
- Leveraged buyout (LBO) transactions, 7–8, **522**
- Levered betas, 224, **522**
- License, R&D, 353, **522**
 - licensee, **523**
 - licensing agreement, 353
 - licensor, **523**
- Lifetime fees, 30, **523**
- Limited partners (LPs), 3, 21, 27–30, **523**
 - committed capital by, 28
 - corporations, 29
 - endowments, 28
 - financial institutions, 28
 - foundations, 28
 - individuals and families, 29
 - pension funds, 27
 - intermediaries in, 29
- Linear model, **523**
 - Monte Carlo simulation, 366
- Liquidation preference, 151, 153–154, **523**
- Liquidation return, **523**
- Liquidity risk, 75, 77, **523**
- Lockup, 155, 159, **523**
- Log-normal distribution, 370
- Log returns, 238, **523**
- Long position, **523**

- Major Investor, 156
- Management and information rights, 156
- Management carve-outs, 320–327, **523**
 - exit diagram for, 322, 325, 333
 - remaining shares, exit diagram for, 323, 326
 - Series E, exit diagram for, 322, 326
- Management fees, 11, 30–32, **524**
 - coverage by, 32
 - investment capital, 30
 - lifetime fees, 30
 - realized investments, 32
 - unrealized investments, 32
- Management test, 137–139, 141, **524**
- Mandatory conversion, 152, 154
- Market cap, 215, **524**
- Market capitalization, 215, **524**
- Market portfolio, **524**
- Market premium, 66, **524**
- Market risk, 67, **524**
- Market test, 137–139, **524**
- Market valuation, 317, **524**
- Matchmaking, 97
- Matrix Partners, 91
- Mean, 363, **524**
 - geometric, 218
 - harmonic, 218
- Menlo Ventures, 93
- Method of multiples, 214, **524**
- Mezzanine, 7–8, **524**
- Midstage, 15, **524**
- Midyear correction, 201, **524**
- Milestone payments, R&D, 353, **524**
- Minimax solution, 427, **524**
- Minority investors, 106
- Mixed-strategy NE, 426, **525**
- Models. *See individual entries*
- Modified VC method, 185–191, **525**
 - 11 steps, 187
 - GP valuation, 186

- LP cost, 186
- LP valuation, 186
- Monitoring, of venture capital (VC)
 - board representation, 95
 - corporate governance, 96
 - human resources, 97
 - matchmaking, 97
 - strategy, 97
- Monte Carlo simulation, 357–377, **525**.
 - See also* Continuous probability distributions; Event trees
 - linear model, 366
 - nonlinear model, 366
- Multifactor models, **525**
- Multiple of money, 55, **525**
- Multiple sources of uncertainty, 373–376
 - simulation with, 373–376
- Multiple strike prices and early exercise, 409–411
- Multiples analysis, 214–228, **525**
- Multistage fund, 22, **525**

- Narrow-base formula, 174, **525**
- NASDAQ, 5, 92, 222
 - versus* CA Index, 51
 - versus* Sand Hill Index, 49
- Nash Equilibrium (NE), 423, **525**
- National Science Foundation (NSF), 339
 - research & development definitions from, 343
- National Venture Capital Association (NVCA), 146, **525**
- Net contributed capital, 35, **525**
- Net income (= earnings), **525**
- Net invested capital, 32, **525**
- Net investment (NI), 200, **525**
- Net profits, **525**
- Net-return index, 50–53
 - Cambridge Associates (CA), 50
 - CA index[®] *versus* NASDAQ, 51
- Net returns, 47, **525**
- Netscape, 138
- New Enterprise Associates (NEA), 93–94
- No shop/confidentiality, 160
- Nodes, 448, 455, **515**
 - decision, 380
- Non-competition and non-solicitation and agreements, 157
- Noncumulative dividends, 153, **525**
- Non-disclosure and developments
 - agreement, 157
- Nondiversifiable risk, 67, **525**
- Nonlinear model, **526**
 - Monte Carlo simulation, 366
- Non-solicitation agreement, 17
- Normal form, game theory, 420, **526**
- Normative analysis, game theory, 431, **526**

- Odds-and evens-game, extensive form, 422
- Odds-and-evens game, normal form, 422
- Operating assets, 199, **526**
- Option pricing, 231–251
 - American options, 241–243
 - carried interest as an option, 247–248
 - European options, 232–234
 - exit diagrams, reading, 245–247
 - random-expiration (RE) options, 243–245
 - using replicating portfolio, 234–237
 - bond values, 235
 - option values, 236
 - replicating portfolio, 234
 - stock values, 235
- Option to abandon, 382, **526**
- Option to delay, 381, **526**
- Option to expand, 381, **526**
- Option to extend, 381, **526**
- Option to shrink, 382, **526**
- Option to switch, 382, **526**
- Option tree, 403–404, **526**
- Option values, 236
- Optional conversion, 152
- Option-tree* worksheet, 406–408, 410
- Organization for Economic Co-operation and Development (OECD), 340
- Original purchase price (OPP), 149, **526**.
 - See also* Price per share
- Out of the money, 242, **526**

- Pacific Corporate Group, 59
- Pari passu*, 153
- Partial implied valuation, 311, **521**
- Partial valuation, 183, **526**
- Participating convertible preferred stock (PCP), 165, 252–271, 290–304, **526**
 - binary options, 291–292
 - exit diagram for, 291
 - exit diagram for, 169
 - Series B and beyond, 296–303

- Participating convertible preferred stock (PCP) (*continued*)
 exit diagram, 297–298
 Series D, 301
 Series F, 302
 valuation of, 292–294
 breakeven valuation, sensitivity analysis, 293
 Series A, exit diagram for, 293
- Participating convertible preferred with cap (PCPC), 166, 252–271, 290, **526**
 exit diagram for, 170
 valuation of, 294–296
 Series A, exit diagram for, 295
 voluntary conversion for, 170
- Partners, dealing with, 143, 327–329
 Techco options, exit diagram for, 328
- Partnership agreements, 30–41. *See also* Restrictive covenants
 carried interest, 32–39. *See also individual entry*
 management fees, 30–32. *See also individual entry*
- Pastor-Stambaugh model (PSM), 77, 79, 118, **526**
- Payment-in-kind (PIK) dividends, 153, 284–285, **526**
- Payments
 milestones, 353
 royalty, 353
 upfront, 353
- Payos, game theory, 420, **526**
- Performance evaluation regression, 68, **526**
- Periodic return, 46–48, **527**
- Periods
 rapid-growth, 196, **529**
 stable-growth, 196, **531**
 venture, 196, **534**
- Perpetuity, 201, **527**
- Personal valuation, 317, **527**
- Piggyback registration, 155, 158, **527**
- Pitch meeting, 140, **527**
 post-term-sheet step, 140
 pre-term-sheet step, 140
- Plowback ratio, 201, **527**
- Portfolio companies, 3, **527**
 early-stage, 6
 late-stage, 6
 mid-stage, 6
- Portfolio company status over time, 125–126, 129
 assuming no private companies after 10 years
 all first-round investments, 126
 all second-round investments, 131
 all third-round investments, 132
- Portfolio firms, 95–98
 value added and the monitoring of, 95–98
 corporate governance, 96
 human resources, 97
 matchmaking, 97
 strategy, 97
- Portfolio value, measurement, 310–314
 implied GP valuation, 311
 implied LP valuation, 311
 implied partial valuation, 311
 implied prevaluation, 311
 Series B, exit diagram for, 313
 value division after Series B investment, 311
- Positive analysis, game theory, 431, **527**
- Postboom period, 12–13, **527**
- Post-money valuation, 149–150, 306–310, 318, **527**
 angel shares, exit diagram for, 309
 employees' shares, exit diagram, 310
 Series A investment
 exit diagram for, 308
 value division after, 307
- Preboom period, 12, **527**
- Preclinical stage, development, 345, **527**
- Preferred returns. *See* Priority returns
- Preferred stock valuation, 252–271. *See also* Convertible preferred (CP) valuation; Redeemable preferred (RP) valuation, 254–256
- Preferred stock, 150, 163–177, **527**
 types of, 163–173. *See also* Antidilution provisions; Common stock; Convertible preferred (CP) stock; Redeemable preferred (RP) stock
- Pre-money valuation, 149–150, **527**
- Price per share, 149
- PricewaterhouseCoopers, 99
- Pricing options. *See* Option pricing
- Priority returns, 33, 35, **527**
 catch-up provision, 35–36
- Prisoner's dilemma, 420, **527**
- Private Equity Analyst*, 87
- Private Equity International (PEI), 61–62

- Private Equity Performance Monitor*, 87
- Private equity, 5, **527**
and hedge funds, 7
- Probabilities, risk-neutral, 461
- Probability density function (pdf), 362, **528**
log-normal PDF, 369
normal PDF, 367
triangular PDF, 372
uniform PDF, 362
- Proceeds, **528**
- Product, role in investment, 142
- Profits, economic, 84
- Projections, role in investment, 142
- Proposed ownership percentage, 148, **528**
- Proprietary deal flow, 94, 137, **528**
- Protective provisions, 151
- Pure strategy NE, 426, **528**
- Put option, 234
- Qualified Institutional Buyers (QIBs),
158, **528**
- Qualified public offering (QPO), 154, **528**
- Qualified Research Expenses (QREs),
350, **528**
- R&D finance, 339–356, **528, 530**
applied research, 343–344
basic research, 343–344
development, 343–344
expenditure by source and performer, 343
global stance, 339–345
 spending, 340
by industry and industry group, 344
options in, 349–354
 banks, 351
 government, 349
 internal corporate funds, 350
 large companies, 353
 license, 353
 milestone payments, 353
 public debt markets, 351
 public equity markets, 352
 royalty payments, 353
 strategic alliance, 353
 upfront payment, 353
 venture capital, 353
- Qualified Research Expenses (QREs), 350
- R&D share of GDP, 2004–08, 341
- R&D tax credit, 350
- sources, 354–355
- touchstones, 345–349. *See also* Drug
 development; Energy innovation
 U.S. R&D funding, 342
- R&D licensing agreement, **528**
- R&D tax credit, **528**
- R&D valuation, 445–465
 drug development, 445–455
 energy, 455–464
 Fuelco's decision tree, 457–461
 node 10, expanded, 462
 node 11, expanded, 462
 node 12, expanded, 463
 forest and the trees, 464
- Random-expiration (RE) options,
243–245, 484, **528**
- Random-expiration binary call option
(BC(X)), **528**
- Rapid-growth period, 196, **529**
- Reading the exit diagram, **529**
- Real options, 378–399, **529**. *See also*
 Decision trees; Risk-neutral
 probabilities
 Drugco, 395–397
 game theory and, 438–443
 in R&D, 381–382
 call options, 381–382
 combinations of options, 382
 option to abandon, 382
 option to delay, 381
 option to expand, 381
 option to extend, 381
 option to shrink, 382
 option to switch, 382
 put options, 382
 spotting options, 378
 valuation of, 382–387
 Fuelco Project, 383–387
 valuing options, 378
- Reality-check model DCF model,
207–212, **529**
 baseline assumptions for, 207–212
- Realization ratio, 55, **529**
- Realized investments, 32
- Realized returns, 48, **529**
- Realized value multiple, 55
- Redeemable preferred (RP) stock/valuation,
165, 254–257, **529**
 AUTO Calculator, 256
 combining RP and CP, 266–268
 comparing RP and CP, 268–269

- Redeemable preferred (RP) stock/valuation
 - (*continued*)
 - exit diagram for, 168
 - FLEX Calculator, 256
 - Series A RP, 171
- Redemption rights, 152, 154–155, **529**
- Redemption value (RV), 252–271, **529**
- Redemption value per share (RVPS), 277–289, **529**
- Regional distribution of VC investment, 18–19
- Registered transaction, **529**
- Registrable securities, 155
- Registration on form S-3, 155
- Registration rights, 155, 158, **529**
 - demand, 158
 - in-kind distributions, 158
 - Piggyback, 158
 - Rule 144, 158
 - Rule 144A, 158
 - S-3, 158
- Regression
 - equation for, 78
 - least-squares, 67
 - performance evaluation, 68
- Reinvestment rate, 201, **529**
- Relative valuation, **529**
- Replicating portfolio, 234–237, **530**.
 - See also under* Option pricing
- Reputation, of venture capital, 97
- Required investment, 179, **530**
- Research and development (R&D). *See* R&D
 - finance; R&D valuation
- Restrictions, 160, **530**
 - transfer restrictions, 160
- Restrictive covenants, 39–41, **530**
 - restrictions on fund management, 39–40
 - restrictions on GP activities, 39, 41
 - restrictions on investment type, 39, 41
- Retention percentage, 182
- Return on capital (R), 84, **530**
- Return on investment (ROI), 84, **530**
- Returns, VC, 46–64. *See also* Fund returns;
 - Industry returns
- Right of first offer, 160, **530**
- Right of first refusal/co-sale agreement and voting agreement, 159, **530**
 - Board of Directors, 160
 - Lockup, 159
- Right of First Refusal/Co-Sale Agreement, 159–160
- Rights, 160
 - to maintain proportionate ownership, 156
 - right of first offer, 160
 - right of first refusal, 160
- Risk factor, **530**
- Risk-free rate, **530**
- Riskless rate, **530**
- Risk node, event tree, 358, **530**
- Risk-neutral probabilities, 388–394, **530**
 - Fuelco Project, 389–391
 - decision tree, 391
 - decision tree, pruned, 392
 - event tree, after node 3, 394
- Rounds, 15, 147, **530**
- Royalty payments, R&D, 353, **530**
- Rule 144, 158, **530**
- Rule 144A, 158, **531**
- S-3 registration rights, 158, **531**
- Sample term sheet. *See* Term sheet, sample
- Sand Hill Econometrics (SHE), 123, **531**
- Sand Hill Index[®], 48–52, **531**
 - San Hill index[®] versus NASDAQ, 49
 - survivor bias, 52
- Screening, 135, 137, 140, **531**
- Securities and Exchange Commission (SEC), 5
- Seed stage, 15, **531**
- Segmented markets, 111, **531**
 - global CAPM, 117
- Self-dealing, 104, **531**
- Sensitivity analysis, 190, 191
 - for breakeven valuation, 256, 258, 261, 263
- Sequential games, 420, 433–438, **531**
 - entry game, 433
 - with commitment extensive form, 437
 - extensive form, 434, 436
 - normal form, 435
 - finite games, 438
 - infinite games, 438
 - subgames, 435
- Sequoia Capital, 91
- Series, 16, **531**
- Series B investment, 272–276
 - conversion condition, 277
 - exit diagram for, 274–275
 - valuation of LP, 274

- Series C investment, 278–282
 - exit diagram for, 281, 287
- Short position, **531**
- Silicon Valley, location of firms in, 87, 103
- Simple interest, 153, **531**
- Simulation, with multiple sources of uncertainty, 373–376
- Simultaneous games, 420, 423–433, **531**
 - advertising game
 - extensive form, 425
 - mixed-strategy NE, 426
 - normal form, 426
 - pure strategy NE, 426
 - two-by-two games, 426
 - arms races, 424
 - best responses, 423
 - dominant strategy, 424
 - equilibrium concepts, 423
 - equilibrium strategy, 423
 - leader-follower game, 428
 - minimax solution, 427
 - Nash Equilibrium (NE), 423
 - odds-and-evens game, normal form, with best responses, 427
- SIZE factor, 76
- Small Business Act of 1958, 11
- Small Business Investment Companies (SBICs), 11
- Sourcing, 137, **531**
- Special situations, **531**
- Spotting options, 378
- Stable-growth period, 196, **531**
- Stale values, 75, 78, **532**
- Standard VC method, 184–185, **532**
- Standards game, 432, 433
- Star fund, 86, **532**
- Step vesting, 158, **532**
- Stock
 - common, 150, **515**
 - preferred, 150, **527**
 - values, 235
- Stock dividends, 153, **532**
- Stock Purchase Agreement, 159
 - conditions to closing, 159
 - counsel and expenses, 159
 - representations and warranties, 159
- Stock values, 235
- Strategies, **532**
 - game theory, 420, **532**
 - portfolio firms, 97
 - strategic alliance, R&D, 353, **532**
 - strategic investing, **532**
- Strike price, 232, **532**
- Style adjustments, 75–77, **532**
 - global CAPM, 114
- Subgame perfect Nash equilibrium (SPNE), 435, **532**
- Subgames, 435, **532**
- Successful exit, 178, **532**
- Summit Partners, 94
- Superstar fund, 86, **532**
- Supply side, 83–85
- Survivor bias, 52, **532**
- Syndication, 91, **532**
- Systematic risk, 67, **532**

- Tag-along rights, 160, **533**
- Takedown, 21, **533**
- Take-me-along rights, 160, **533**
- Talltree Ventures IV, 44–45
- Target multiple of money, 178, 181, **533**
- Target returns, 178, 180–182, **533**
- Tax credit, 350
- Technical risks in drug development, 347, **533**
- Technology Crossover Ventures (TCV), 94
- Technology, 142
- Term sheet, sample, 466–483
 - existing preferred stock, 482
 - Founders' stock, 482
 - investor rights agreement, 475
 - Board matters, 479
 - demand registration, 476
 - employee stock options, 480
 - expenses, 476
 - key person insurance, 480
 - lock-up, 477
 - management and information rights, 477
 - matters requiring investor director approval, 478
 - non-competition and non-solicitation and agreements, 479
 - non-disclosure and developments agreement, 479
 - piggyback registration, 476
 - registrable securities, 475
 - registration on Form S-3, 476
 - registration rights, 475
 - right to maintain proportionate ownership, 477
 - no shop/confidentiality, 482

- Term sheet, sample (*continued*)
 - pre and post-financing capitalization, 468
 - anti-dilution provisions, 472
 - capitalization, 468
 - dividends, 468
 - liquidation preference, 469
 - mandatory conversion, 473
 - optional conversion, 471
 - pay-to-play, 473
 - pre-money valuation, 468
 - protective provisions, 470
 - redemption rights, 474
 - voting rights, 470
 - right of first refusal/co-sale agreement, 480
 - lock-up, 481
 - right of first refusal/right of co-sale (take-me-along), 480
 - stock purchase agreement, 474–475
 - conditions to closing, 475
 - counsel and expenses, 475
 - representations and warranties, 474
 - voting agreement, 481
 - Board of Directors, 481
 - drag along, 481
- Term sheets, 9, 135–136, 146–162, **533**. *See also* Charter; Investor rights agreement
 - aggregate purchase price (APP), 149
 - basics, 147–150
 - capitalization, 150
 - common stock, 150
 - expiration, 160
 - founders' stock, 160–161
 - investors, 148–149
 - no shop/confidentiality, 160
 - original purchase price (OPP), 149
 - post-money valuation, 149–150
 - preferred stock, 150
 - pre-money valuation, 149–150
 - price per share, 149
 - right of first refusal/co-sale agreement and voting agreement, 159
 - rights and restrictions, 160
 - stock purchase agreement, 159
- Terminal node, event tree, 358, **533**
- Termination, 156
- Terrible things, 144
- Times money, **533**
- Top-quartile fund, 60, **533**
- Top-tier firms, 89–95, **533**
- Total valuation, 179, 317, **533**
- Tranches, 148, **533**
- Transaction terms, 143
- Transfer restrictions, 160, **533**
- Trees, 355, **533**. *See also* Event trees
 - binomial, 355
 - decision, 355
 - game, 355
- Triangular distribution, 373
- Tunneling expropriation, 104, **533**
- Two-by-two games, 426, **533**
- Unbiased approximation, 240–241
- Underlying asset, 232, **533**
- Underwriter, **533**
- Uniform CDF, 363
- Uniform PDF, 362
- United Kingdom, 99
- United States, VC investment patterns in, 14–19
 - growth stages, 16
 - early stage financing, 16–17
 - expansion (mid) stage financing, 16–17
 - later stage financing, 16–17
 - seed/startup stage financing, 16–17
 - investments by industry, 15–18
 - boom period, 17–18
 - health care, 15
 - information technology (IT), 15
 - postboom period, 17–18
 - preboom period, 17–18
 - investments by region, 18–19
- Unlevered betas, 224, **533**
- Unrealized investments, 32
- Unrealized returns, **534**
- Unrealized value multiple, 55
- Unrestricted stock, **534**
- Valuation*, 195
- VALUE factors, 76
- Value multiple, 55, **534**
- Valuing options, 378
- Variables
 - continuous random, 357, 362
 - discrete random, 357, 362
- Variance, 66, **534**
- VC method, 178–194, **534**
 - exit valuation, 178–180
 - expected retention, 178, 182–183
 - investment recommendation, 183
 - modified VC method, 185–191

- spreadsheet, 189
- standard VC method, 184–185
- target returns, 180–182
- VCV model, 484–486, **534**
 - AUTO calculator, 484
 - Euro-option calculator, 484
 - FLEX calculator, 484
 - Random-Expiration (RE) option calculator, 484
- Venture capital (VC), 3, **534**
 - characteristics, 3–5
 - as financial intermediary, 3
 - helping in companies portfolio, 5
 - investing in internal growth, 6
 - investing in private companies, 5
 - maximizing financial return, 5
- Venture capitalists (VCs), **534**
 - exiting, 9–10
 - investing, 9
 - monitoring, 9
 - work of, 9–10
 - top-tier, 89-95
- Venture Economics (VE), 59
- Venture period, 196, **534**
- VentureExpert, 123
- VentureSource* database, 253
- Vesting, 158, **534**
 - cli vesting, 159
 - step vesting, 158
- Vintage year, 22, **534**
- Volatility ratios, selected countries, 115
- Voluntary conversion for the PCPC, 170
- Voting agreement, 159–160
- Voting rights, 151, 154
- Warrants, 409
- Weighted-average antidilution protection, 173, **534**
- Woodward, Susan, 48
- Worldwide investments, 99–119. *See also*
 - Global distribution of VC investing;
 - International VC
- Write downs, 36
- Yahoo!, 138
- Zero-cost long-short portfolios, 76, **534**
- Zero-profit curve, 452, 455
- Zero-sum games, 422, **534**