



Rig Your Townie for Speed

Bill Key
and
Brendan O'Grady



SEMINAR #1 WINTER 2020

GOALS

- CLEAR AWAY MYTHS AND SEA STORIES
- PROVIDE REFERENCE DETAILS FOR GO FAST GADGETS, RIGGING AND HULL MODIFICATIONS

Topics

- Mast Position and Rake
- Hull Modifications
- Sail Trim Devices
- Deck Running Rigging
- Interesting Structural Items

REFERENCE

DOWNLOAD FROM THE MTCA WEBSITE AND READ:

TOWN CLASS SPECIFICATIONS
ISSUE #5 with revisions of July
2000 (updated February 2004)

This is a “must do”



MAST POSITION AND RAKE

WHY WORRY ABOUT MAST POSITION AND RAKE

- Town Class design is poorly balanced (old nautical term is “Crank”)
 - Have excessive weather helm
- Weather helm is bad
 - Rudder drag slows boat
 - Breaks tillers
- Fix is Move Sail CE Forward
 - Move Mast Forward
 - Rake Mast Forward

Strong Arm,
Bent Tiller

Water Brake

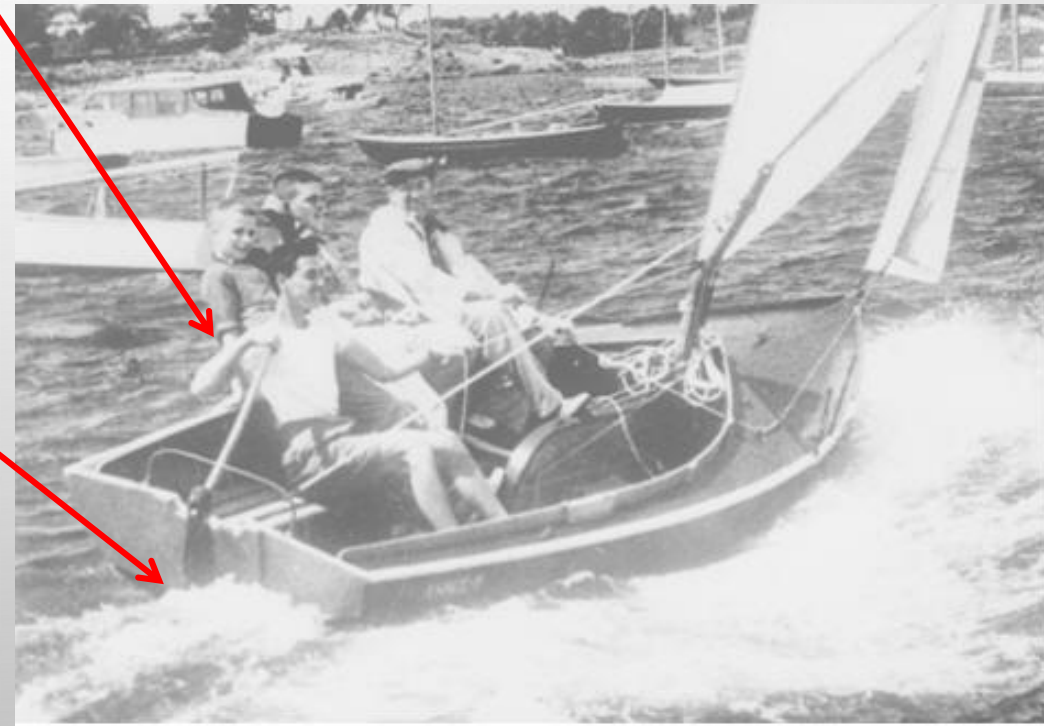

MAST PARTNER AND STEP MODS

- Cut out the Deck about 4” or more Forward to Move the Mast Forward to Reduce Weather Helm. If you cut into a Deck Rib, Epoxy a Reinforcement on the Rib. Install a new Wooden Mast Partner to finish the Extended Mast Hole. A good place to mount a Compass.
- The Mast Step Should be moved or lengthened forward to match the lengthened Deck Opening. New Mast Step works best. Be sure to put drain holes in the bottom of the step so that the mast is not sitting in water and rots

2093 Mast Deck
Cutout about as
far Forward
as it can get



2093 Mast Step:
Plywood bottom
Reinforcing under step.
Step fabricated with Oak sides
and opening at each
end for drainage.

1/4" Brass Tierods from
Step to deck to spread
Mast loads to Deck/Hull



MAST STEP DIMENSIONS

Measurement is from front of CB box to Fwd end of step where the Fwd face of the mast would stop.

Longer is better as it permits more variations in mast butt placement using mast blocks.



Pert Lowell Std 7"



2086 step 10 1/2"

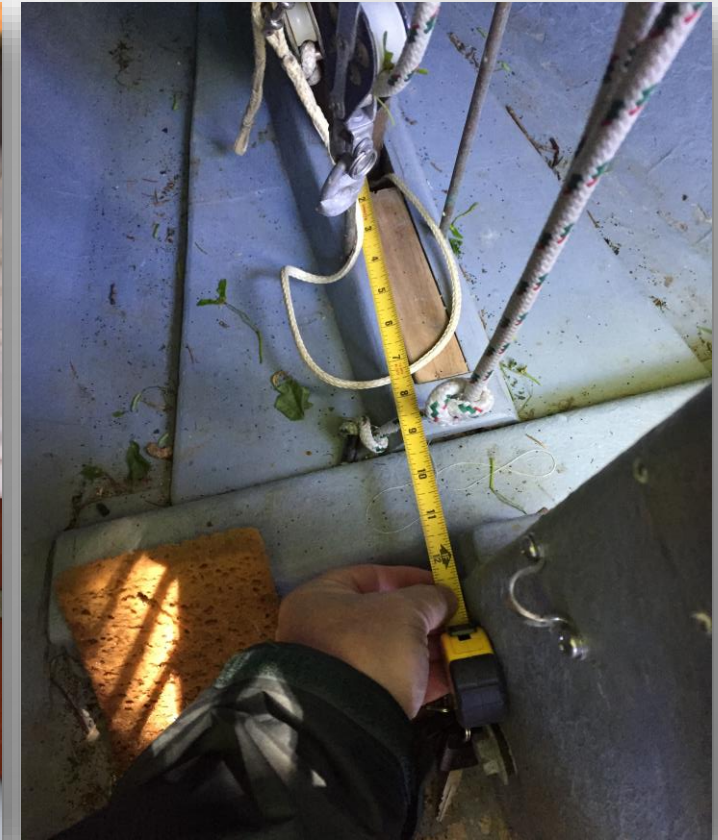

2093 step 12 1/2"

MAST POSITION #2086:



MAST STEP REFERENCE DIMENSIONS

Distance from Front of CB box to Fwd End of Step

Pert Lowell Rebuild

2086

2093

7"	10 1/2"	12 1/2"
----	---------	---------

Note 1: 2086 is one of the fastest boats in the Fleet and sails with mast vertical.

Note 2: a 7" step dimension permits only forward rake to stop weather helm

Note 3: Recommend using the 12 1/2" step length which gives widest range of Mast adjustment using mast blocks

MASTHEAD REFERENCE DIMENSIONS

Measurement from Masthead to Outside of Transom using Main Halyard

Boat	Owner	Rake	Mast Butt Position	Distance	Date
2047	Cooke	Vertical	Forward	24' 10"	2015
2074	Solstad	Forward	Standard	24' 10"	2015
2086	Howes	Slight Aft	Forward	24' 7"	2018

NOTE: Moving mast forward (2047) and raking forward (2074) provided the same dimension with approximately the same forward movement of the sail CE

A close-up, dark, and moody photograph of a mechanical watch. The watch has a dark dial with a compass bezel showing numbers like 110, 130, 140, 160, and 180. The watch is surrounded by numerous water droplets of various sizes, creating a sense of depth and texture. The overall aesthetic is high-contrast and artistic.

HULL MODIFICATIONS

WHY WORRY ABOUT HULL MODIFICATIONS

- Town Class boats are hydrodynamically no one's dream. Reducing drag is job #1
 - The Skeg enlargement reduces Weather Helm drag by improving hull balance.
 - Cleaning up the CB edges and keeping it clean of growth decreases drag.
 - Narrowing the CB slot and moving the CB pennant to the front of the board gets the wire out of water flow and significantly reduces drag.
 - A flat bottom on a Townie produces reduced drag and better sailing characteristics.
 - A 750 lb. Townie is faster than a 900 lb. so reductions in weight count.
 - The Chain Plates should be checked to ensure well secured and in the right position to facilitate correct mast shape and rig tune.

SKEG

Make Skeg Maximum Size 5' x 7" – see diagram in Town Class Specs

Quote from Specs

“The skeg shall be as shown in Figure 1 in this appendix and must measure no more than 5' 0" long, and no more than 7" deep at the after end and not greater than 1" maximum depth at the forward end.”

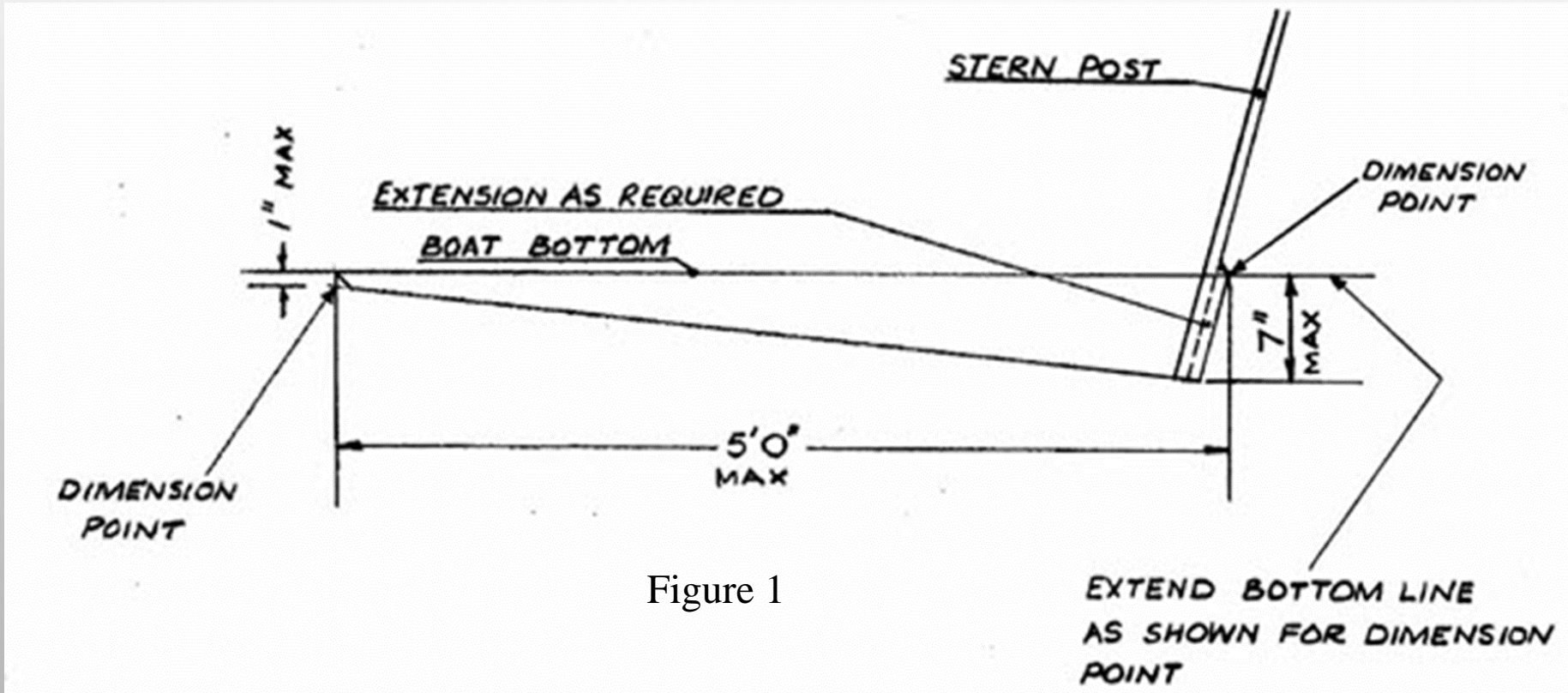

Figure 1

Fiberglass Skeg
Extension
Finished Ready
For Fairing



CENTERBOARD

- Narrow centerboard slot on the bottom to ½” to minimize turbulence
- Centerboard lifting pennant sheave should be on forward upper corner of trunk.
- Fair edges, round on front, tapered on back. Paint only the bottom or front edge up 10”.
- Recommend that the centerboard be stainless steel or bronze. Iron is ok, but high maintenance

IMPORTANT

Make sure that bolt is the same material and grade as the board. If not, bolt will corrode (crack) with CB loss. Inspect every year. Renew if necessary. Talk with Bill Key on how to inspect.

Narrow CB Slot

1/2" Slot helps
Minimize turbulence
Stops board banging



Move CB Lifting Pennant

Left: CB Pennant from top makes wire drag in Water

Right: Move CB Pennant to forward, top of CB box, best for no drag

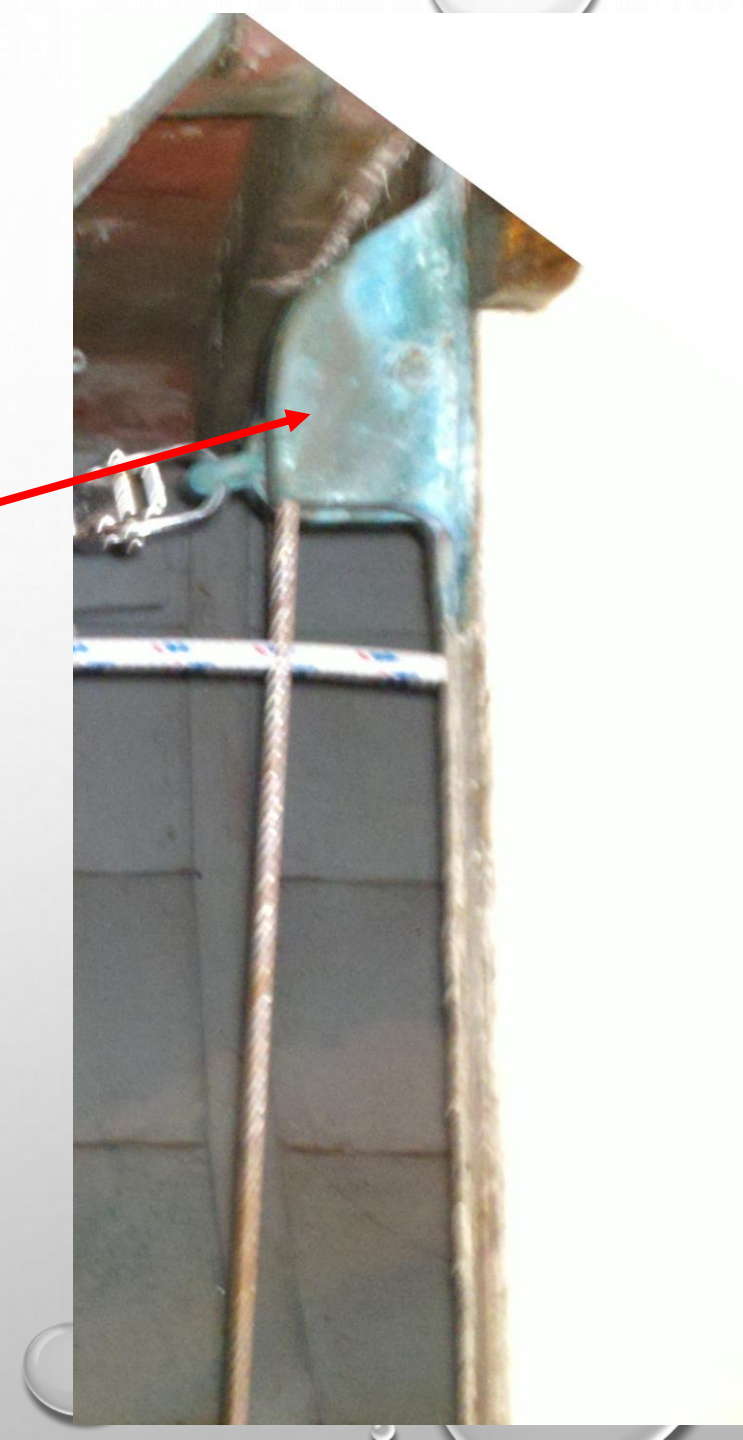
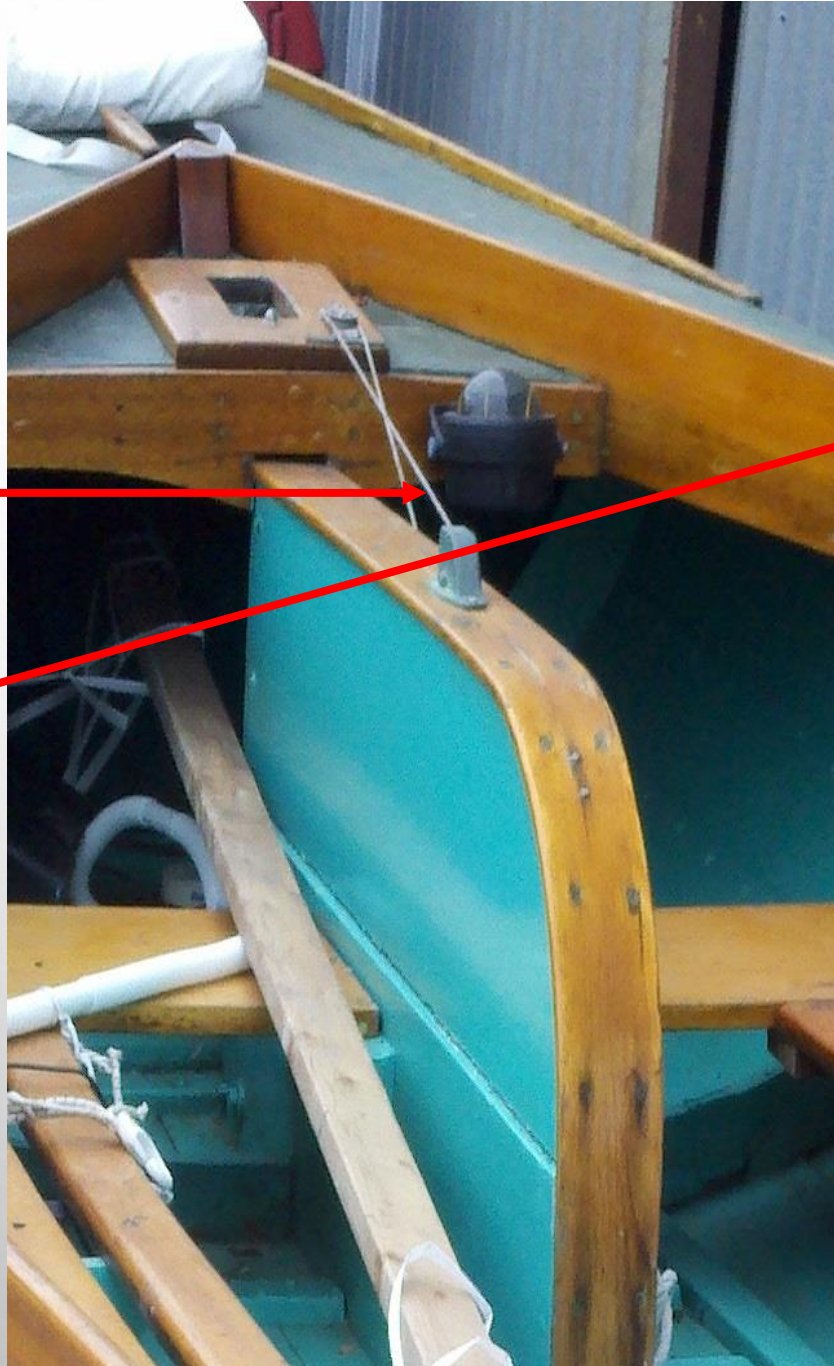

CENTERBOARD PIN LOCATION REFERENCE DIMENSIONS

Boat #	Distance from inside of transom to Center of CB pin
2093	10' 3/8"
2074	10' 1"
2047	10" 3"

Note 1: CB pin is installed at boat yard. Check to ensure measurement is in correct range

BOTTOM (FLAT BOTTOM = FAST BOAT)

- Wood boats - check for flatness. Discuss a fix with Ralph Johnson
- Fiberglass boats - all fiberglass bottoms become concave because they have no athwartship strength members
 - Install 4 ribs on the inside floor to flatten the bottom of the hull.. Use a jack to flatten bottom during installation. Buy reinforcing sections and use epoxy to install (reinforcing sections available from Jamestown distributors (Prisma Composite Preforms Hull Stiffener)) or similar



Athwartships Reinforcing
Section V shaped

HULL WEIGHT

- Minimum weight is 750 pounds with specified equipment (mast, boom, rudder, etc.)
- If your boat has a cockpit sole with balsa core or foam core, replace the cockpit sole with fiberglass as permitted by class specifications.
- Check the foam gunwale ring around the inside of the boat for wetness, since when the deck joint leaks, foam gets wet.
- Check the Transom to see if plywood reinforcement is wet (heavy). Strength is typically not an issue, but weight is.

CHAINPLATES

- **Must do item**.....The chain plates are fastened with 1/4” bolts threaded into the fiberglass only. Cut flotation tanks and install (2) 4” diameter inspection ports on each side for access to replace those bolts with longer ones with nuts and washers. Good time to inspect the inside foam for wetness.
- Chain plates should be located so that the forward shroud (upper) at deck level shall not be forward of the center line of the mast with the fore stay taut. A chain plate locator bar is permitted by the specifications so chain plates will not have to be moved.



SAIL TRIM DEVICES

WHY SAIL TRIM DEVICES ?

- Sail shape is controlled by sail trim devices
- Required sail shape changes with breeze levels
 - Light air requires a full sail with shape in correct place
 - Heavy air requires a flat sail with shape in the correct place
- Outhaul, Cunningham and Vang control main shape
- Jib Tension controls jib shape

SAIL TRIM DEVICES



Outhaul

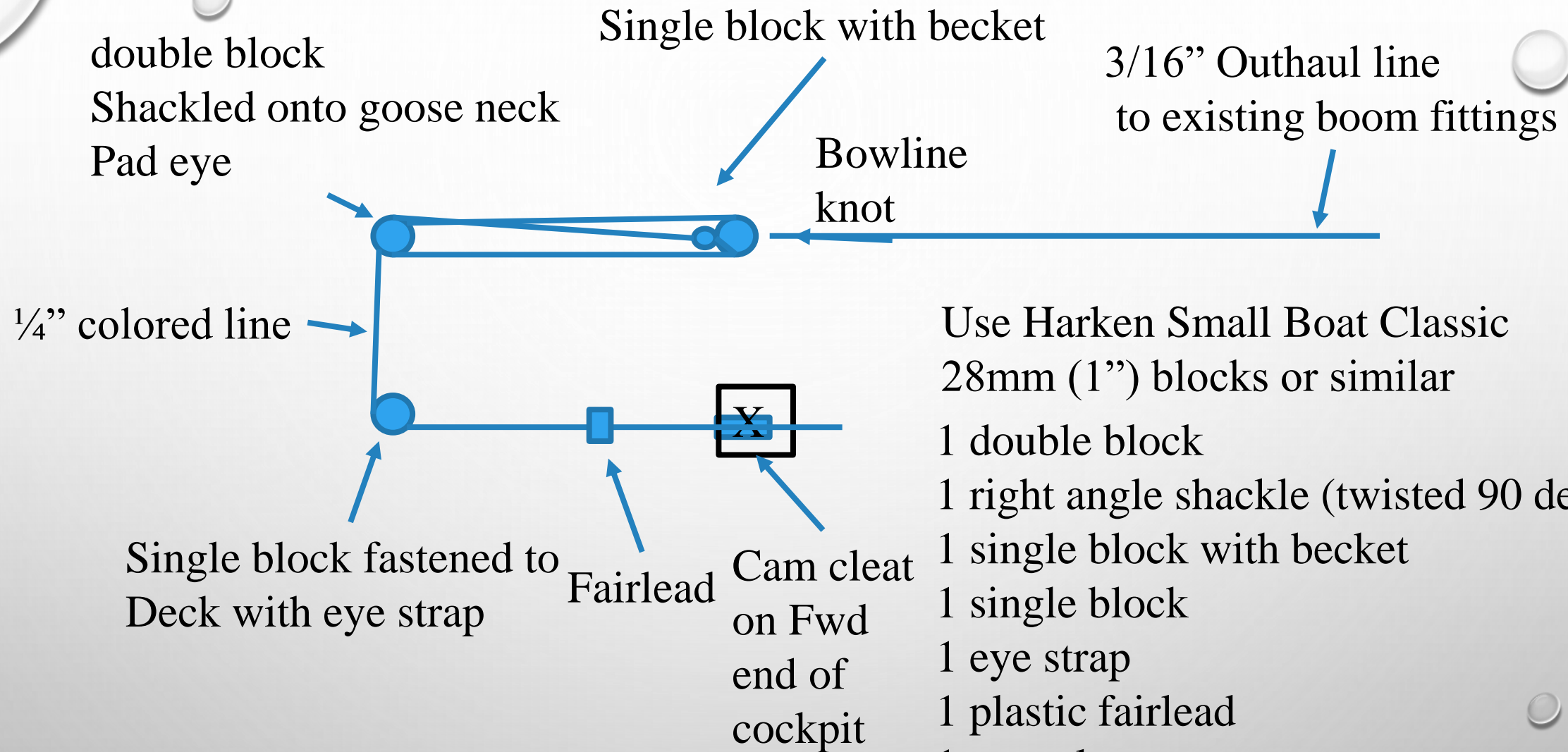

- Use Harken Small Boat Classic 28mm (1") blocks or similar
- 1 double block
 - 1 right angle shackle (twisted 90 deg)
 - 1 single block with becket
 - 1 single block
 - 1 eye strap
 - 1 plastic fairlead
 - 1 cam cleat
 - 3/16 Outhaul line (measure length)
 - 1/4 or 3/16 Tackle Line "Green"

OUTHAUL

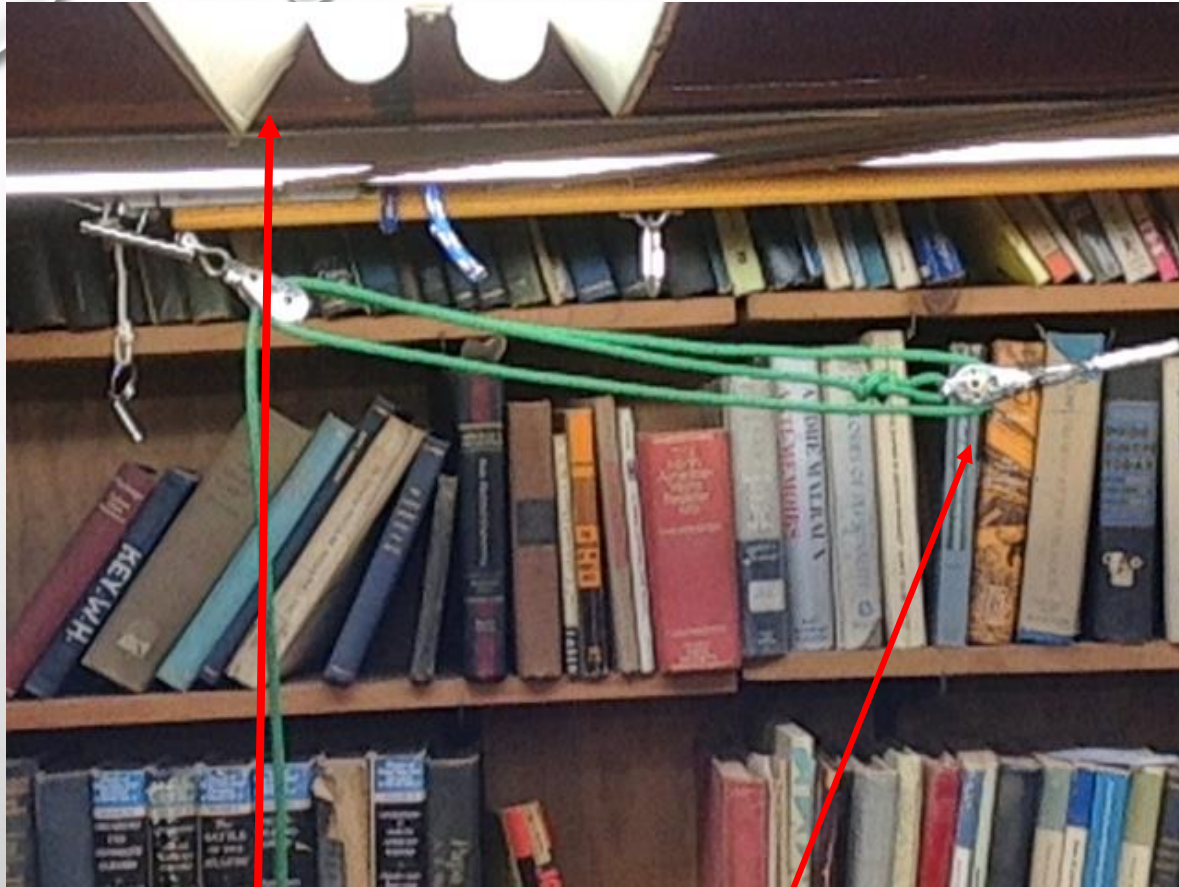

**Double block
with
90 deg shackle
attached**

**Single Block with
Becket**

OUTHAUL

Tackle for outhaul #2093



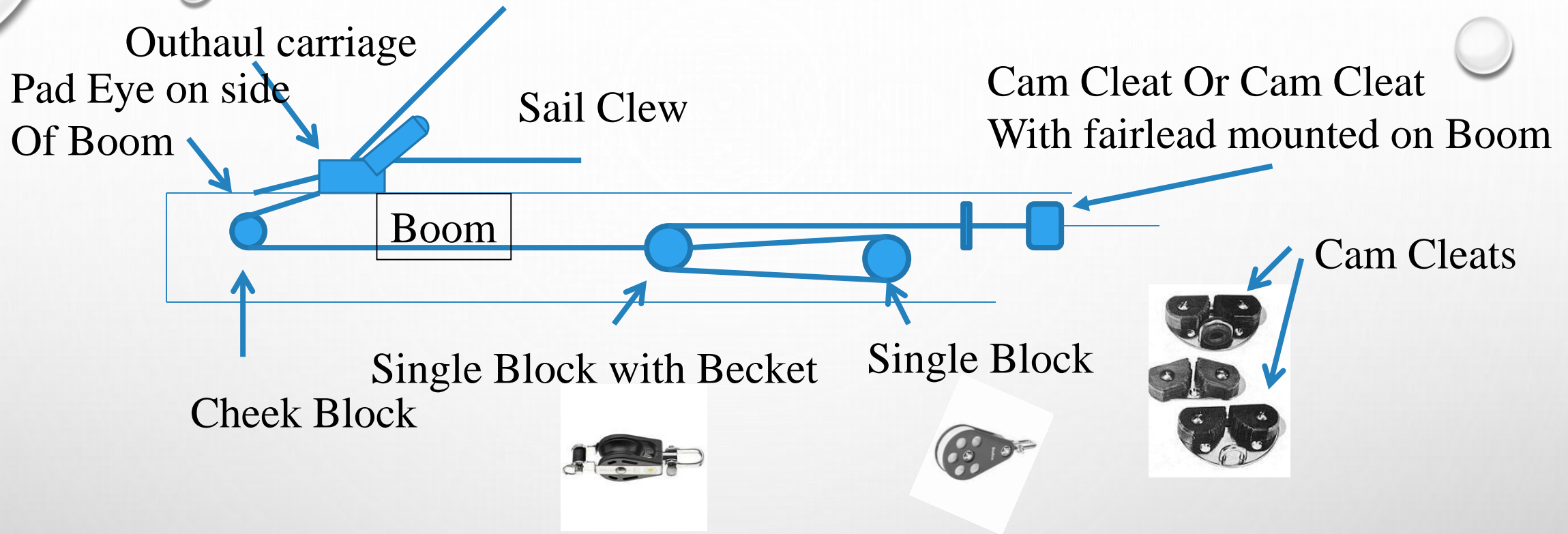

Use 28mm (1") blocks Harken or similar blocks

ALTERNATE OUTHAUL TACKLE

TYPICAL TOWNIE BOOM OUTHAUL



Outhaul Tackle
Adjustable by
Crew while sailing



SAIL TRIM DEVICES

Outhaul
Cunningham

3/16" Vectran (slippery)
 Through Cunningham
 Grommet on sail
 (about 12" up from
 Tack grommet)

Single
 Block
 With
 Becket



Double Fiddle Block
 Or Double Block

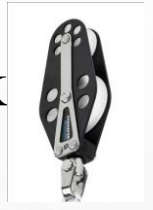

Some implementations use
 a hook that hooks directly
 into the Cunningham
 grommet

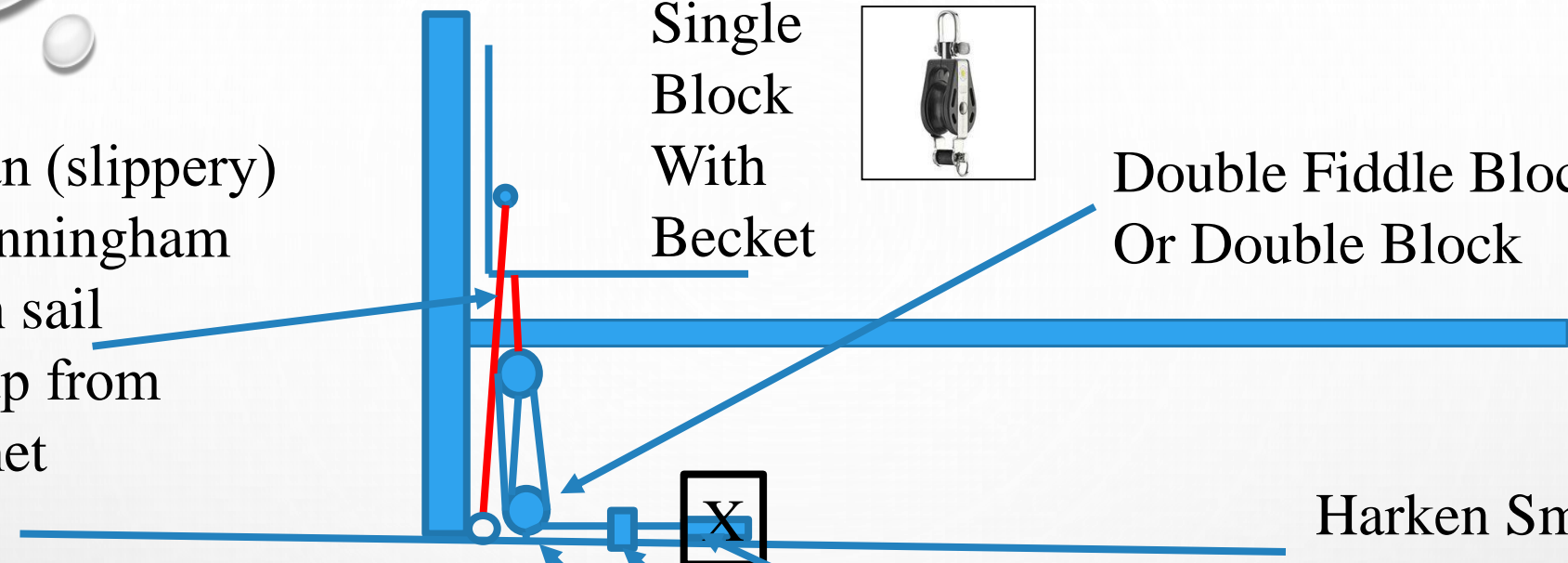

Eye Strap to deck



Fairlead

Cam
 Cleat on
 Fwd end
 of
 cockpit

Harken Small Boat Classic
 28 mm(1") blocks or simila

- 1/4" Vectran (measure length)
- 1 eye strap
- 1 carabiner
- 1 Single block with becket
- 1 double or fiddle block
- 1 plastic fairlead
- 1 cam cleat
- 1/4" Tackle line Red (measure

CUNNINGHAM #2093

CUNNINGHAM #2093

3/16" Vectran through
Cunningham grommet
to Carabiner on Deck

Single Block with
Becket

Double Fiddle Block

Fairlead

Cam Cleat

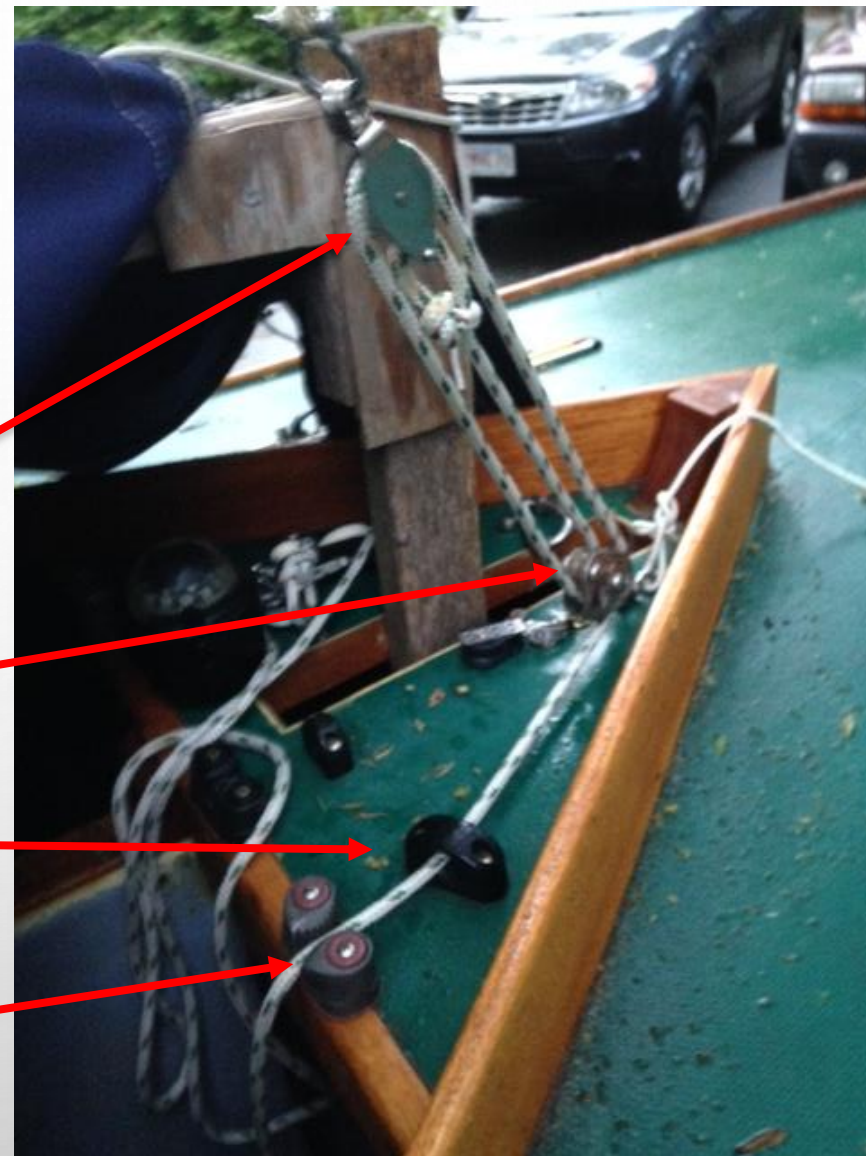
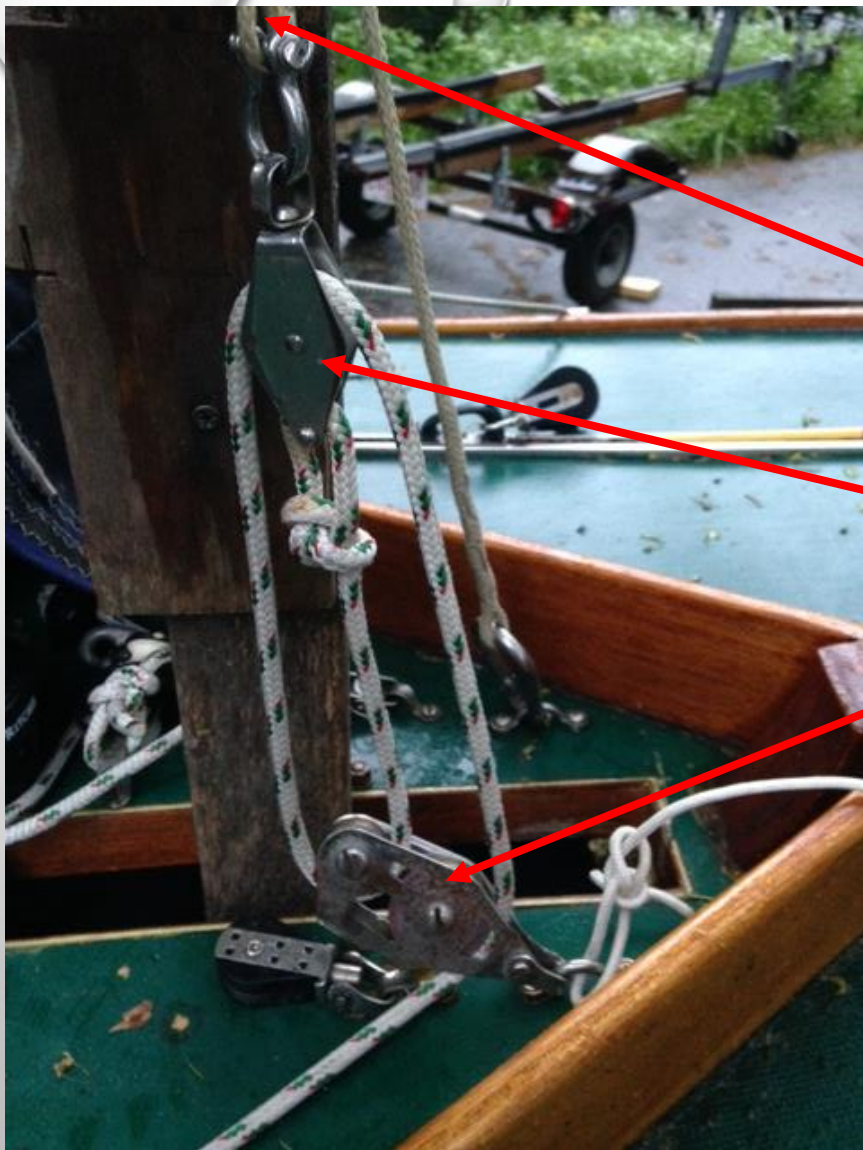

Alternate Cunningham
Installations utilize a
Hook into the grommet
on the sail

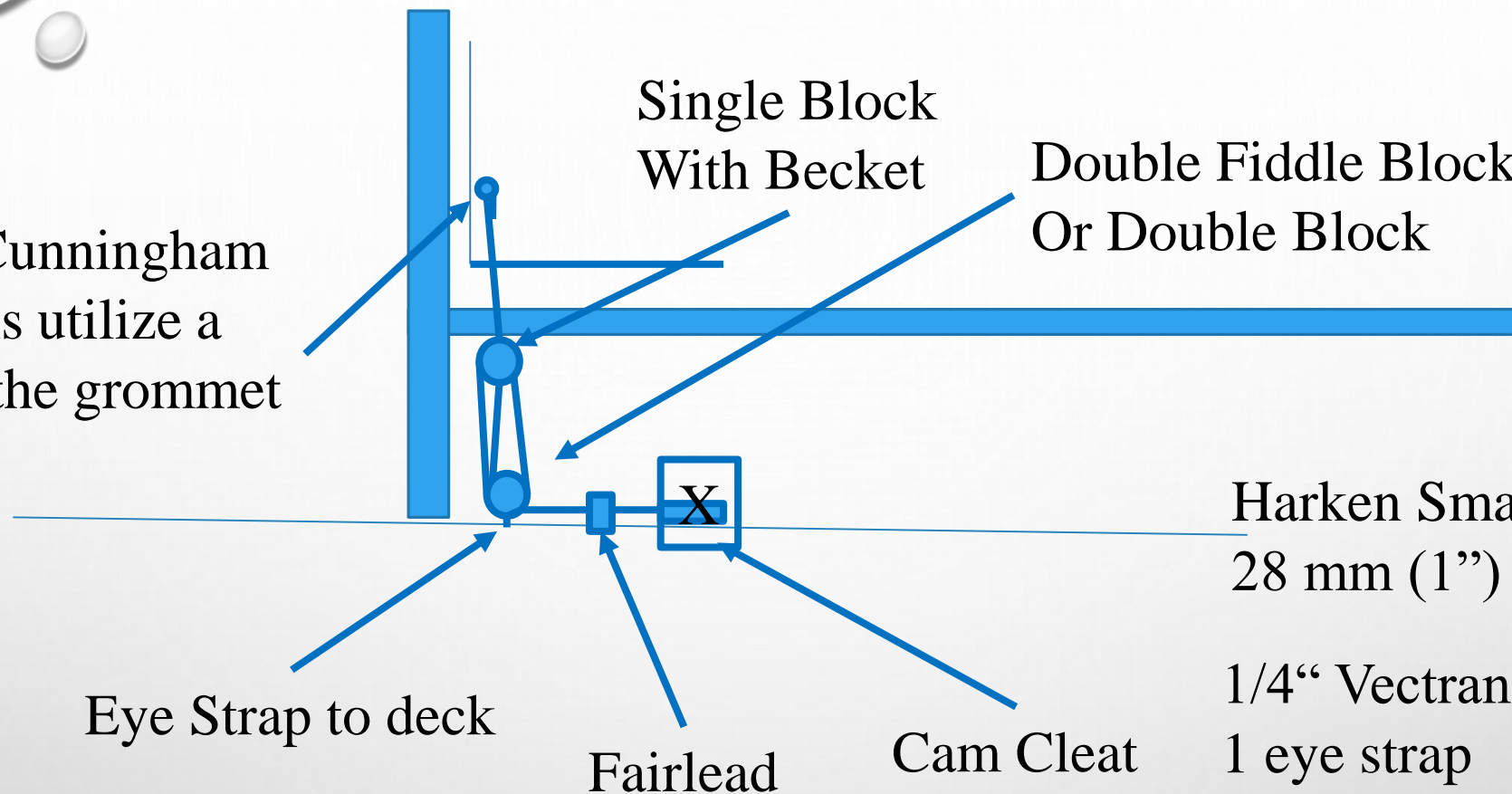

Harken Small Boat Classic
28 mm (1") blocks or similar

1/4" Vectran (measure length)

1 eye strap

1 carabiner

1 Single block with becket

1 double or fiddle block

1 plastic fairlead

1 cam cleat

1/4" line Red (measure length)

ALTERNATE CUNNINGHAM

TYPICAL TOWNIE CUNNINGHAM

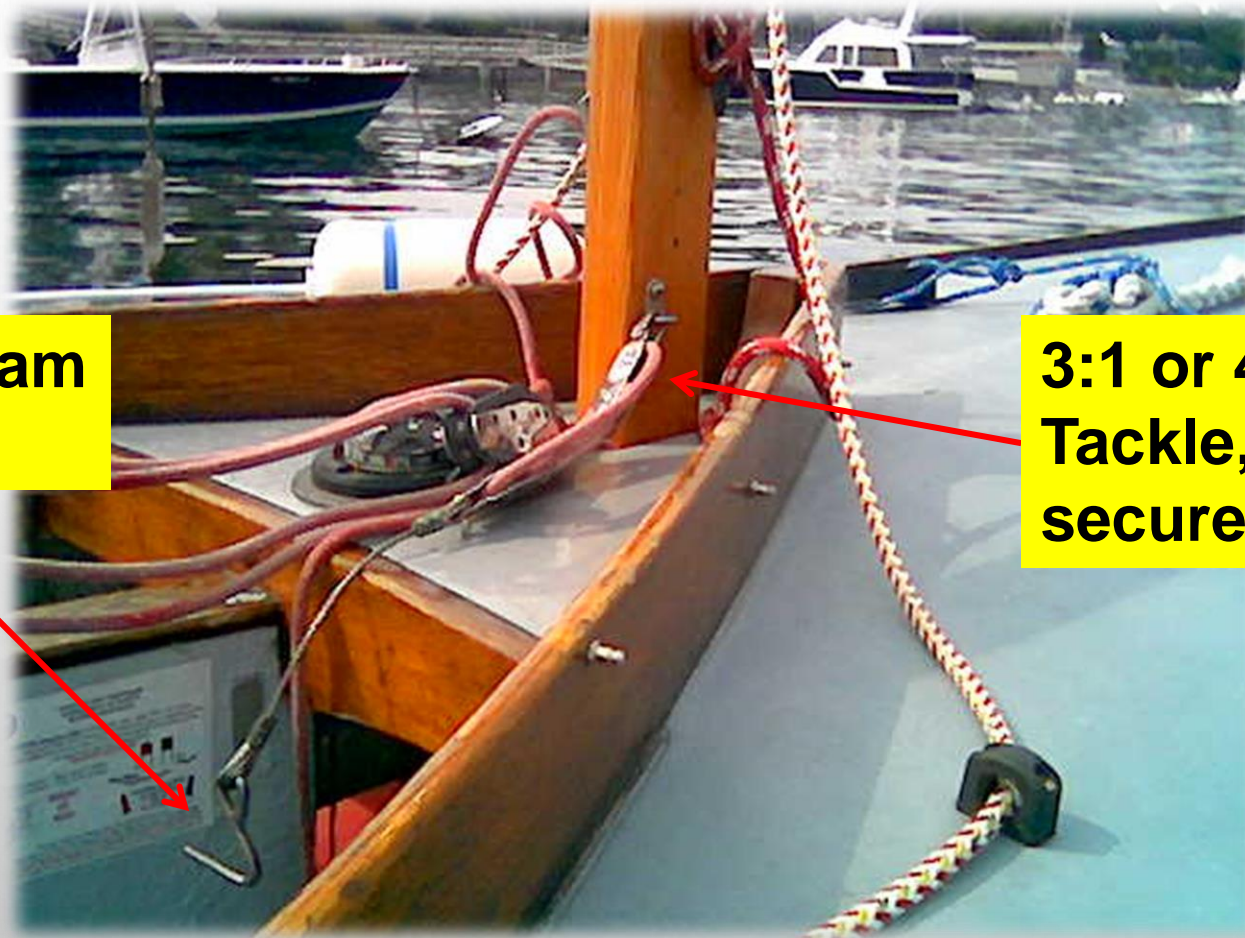

**Cunningham
Hook**

**3:1 or 4:1
Tackle, best
secured on deck**



SAIL TRIM DEVICES

Outhaul
Cunningham
Boom Vang

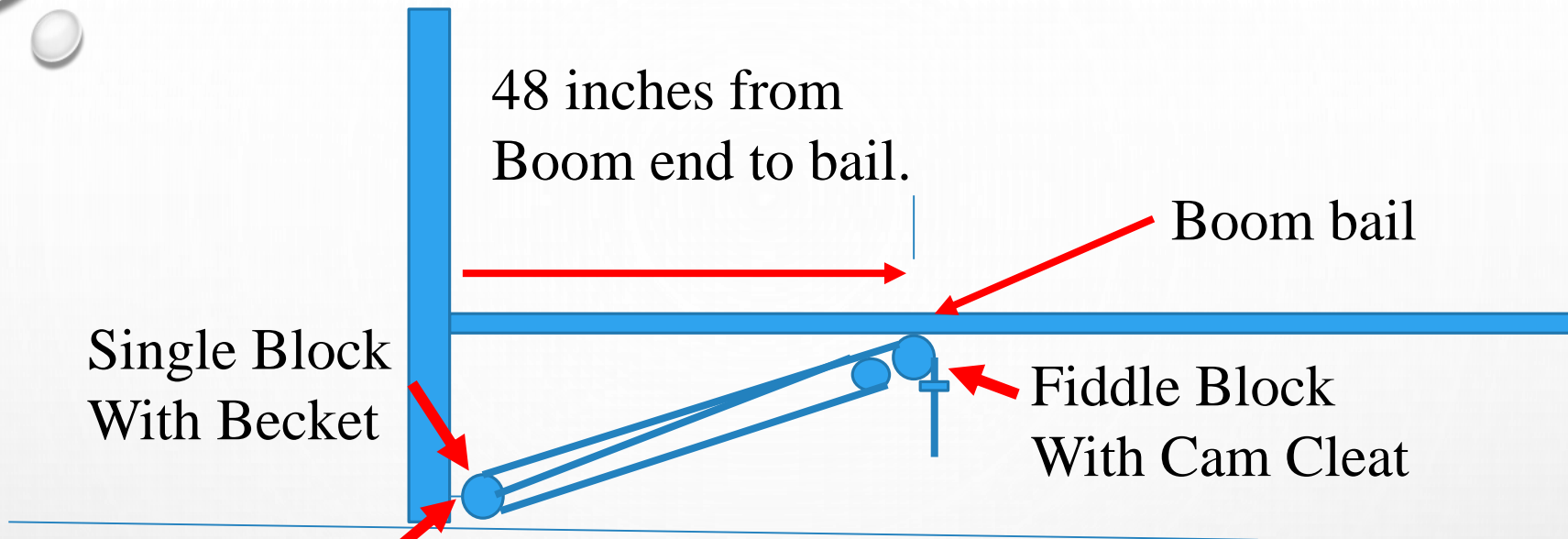

Deck Pad Eye through bolted on mast at deck edge. Use old jib sheet Brass Deck pad eye.

1 single block with becket
 1 fiddle block with cam cleat
 (Alternate double block with clam cleat On boom)

1 plastic fairlead

1 boom bail

1 heavy pad eye bolted on mast (use deck pad eye)
 1/4" tackle line Speckled Red(measure length)

BOOM VANG TOP CAM CLEAT

Harken Small Boat Classic
 28 mm (1") blocks

Single Block
With Becket

Fiddle Block
shackled
To bail on boom

Fiddle block with
Attached Cam
Cleat

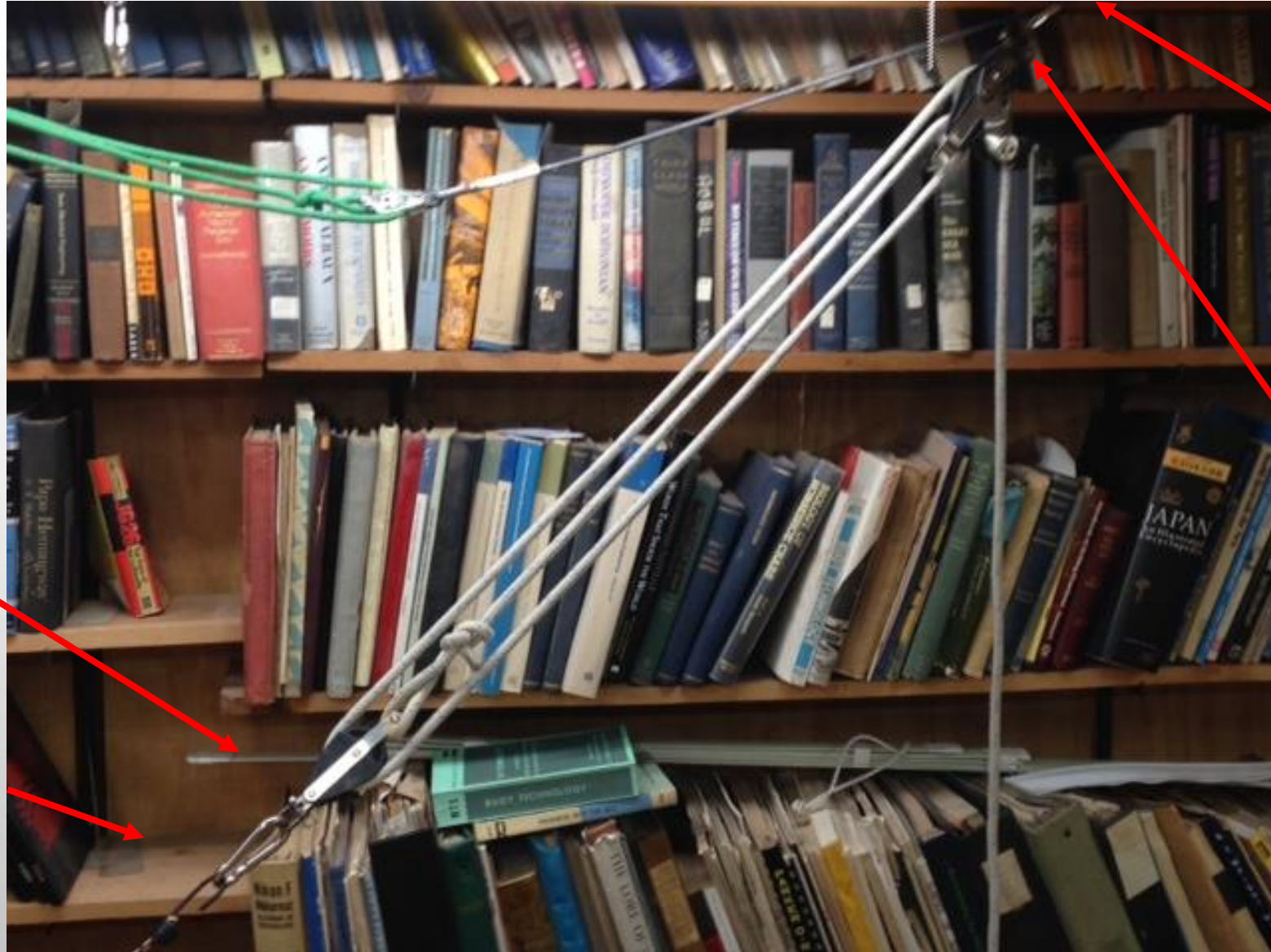

Carabiner to bail
On Mast just above
Deck.

Pad Eye Bolted
Through Mast, Block
Shackled to Pad Eye

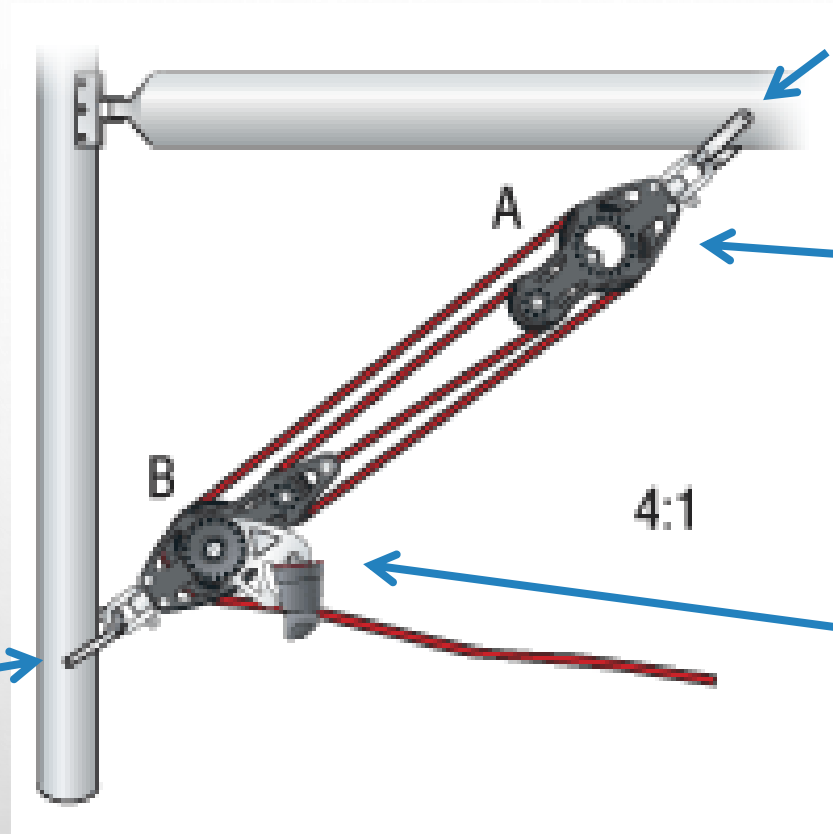

Pad Eye Bolted Through
Boom, Block Shackled to
Pad Eye

Fiddle
Block
No Becket

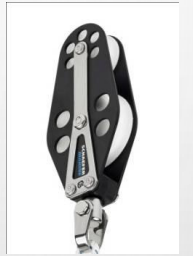

Fiddle Block
With Becket and
Bottom Cam Cleat

Use 28mm (1") blocks

ALTERNATE BOOM VANG BOTTOM CAM CLEAT

Typical Townie Boom Vang



4:1 Tackle
With Top Cam
Cleat

Easy for
Crew to
Set

SAIL TRIM DEVICES

Outhaul
Cunningham
Boom Vang
Jib Tensioner

Jib halyard with Loop Knot within distance Of tensioner with carabiner



Brummel Hooks, Shackle or Carabiner On upper block

Single block With becket

Harken Small Boat Classic 28 mm (1") blocks or similar

Double Fiddle Block

Eye Strap

Fairlead

Cam Cleat



JIB HALYARD TENSIONER #2093

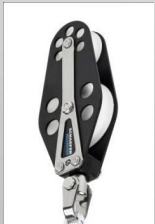

- 1/4" jib halyard (measure to length)
- 1 small carabiner
- 1 single block with becket
- 1 double or fiddle block
- 1 eye strap
- 1 plastic fairlead
- 1 cam cleat
- 1/4 " tackle line Blue (measure length)

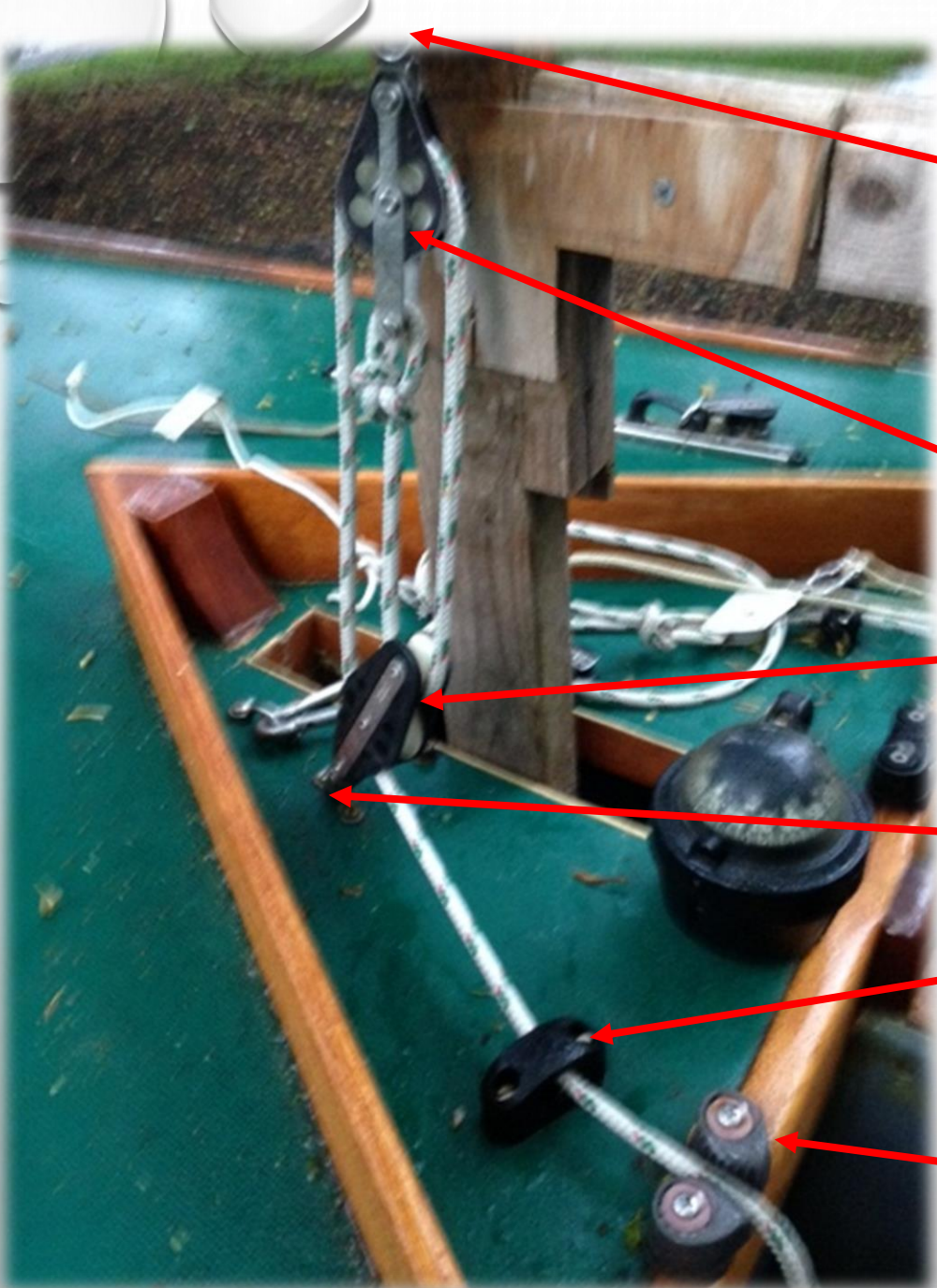

Brummel Hooks attach Jib Halyard to Tackle with tail of Halyard coiled below deck

Single Block with Becket

Double Fiddle Block Or plain Double Block

Eye strap on Deck

Fairlead

Cam Cleat

JIB TENSIONER #2093

NOTE: This is a double Fiddle block because it lines Up better, but costs more than Standard double block, so take Your choice. Double block twists A little more but is workable.

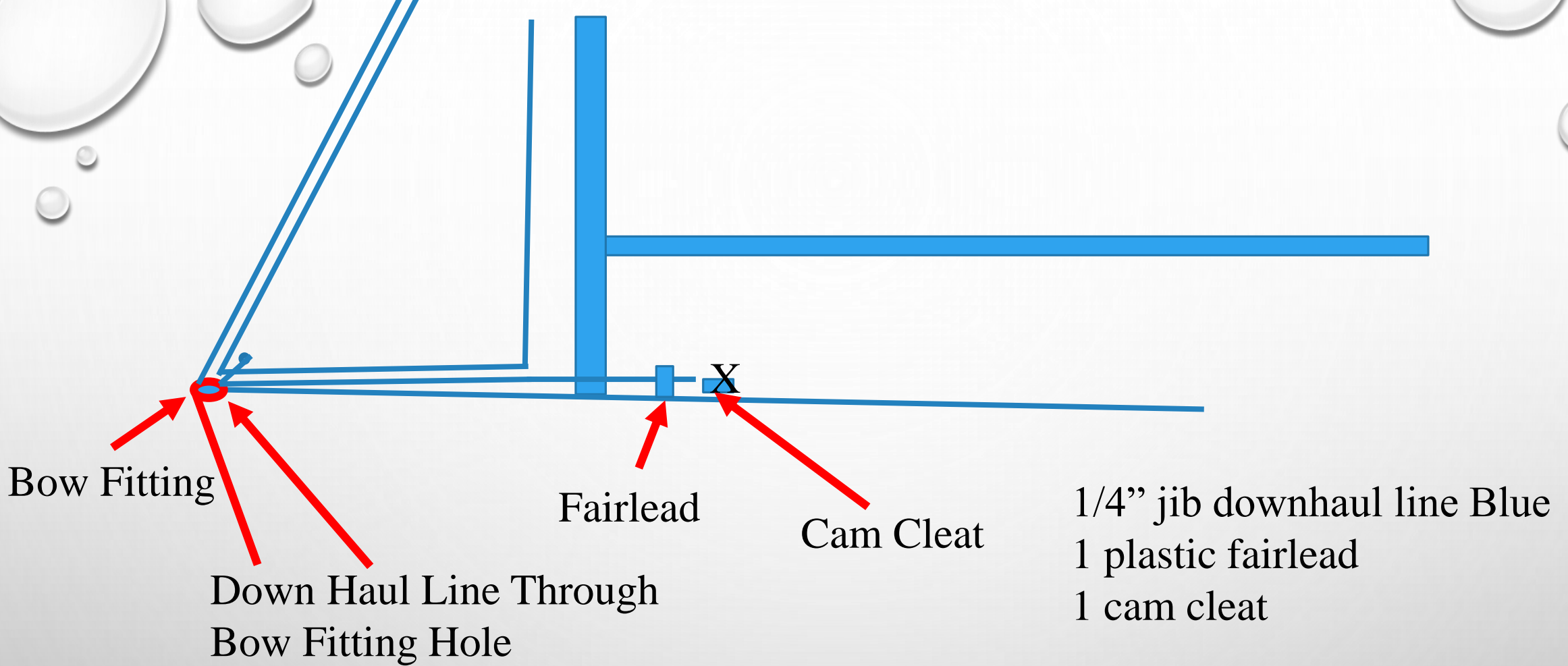

ALTERNATE JIB TENSIONER #2086
(Tension by pulling down on jib tack)



DECK RUNNING RIGGING

COCKPIT RUNNING RIGGING ARRANGEMENT #2093

Cunningham

Boom Vang

Jib Tensioner

Use different color
lines to help crew

Use CB Box Saddle
Bags to Organize
Cockpit mess.
Get your Raffle Tickets
before its too late



COCKPIT COMPASS #2093

A Compass is Required by
Racing Rules,

Useful for Establishing Starting
Line Bias and Observing Wind
Shifts during the Race

Place where Easy to
See.





DECK RUNNING RIGGING
Jib Track

JIB TRACK PLACEMENT

Doyle/Cressy jibs older than 2018 should use the 15 deg lead angle. Doyle jibs after 2018 should use a 10 deg lead angle.

Disregard comments About the Dyson jib.

The jib sheet goes

Through the combing using a plastic fairlead grommet or a fairlead block set in the combing.

Cleats can be installed on the CB box or on the combing near the fairlead grommet or block.

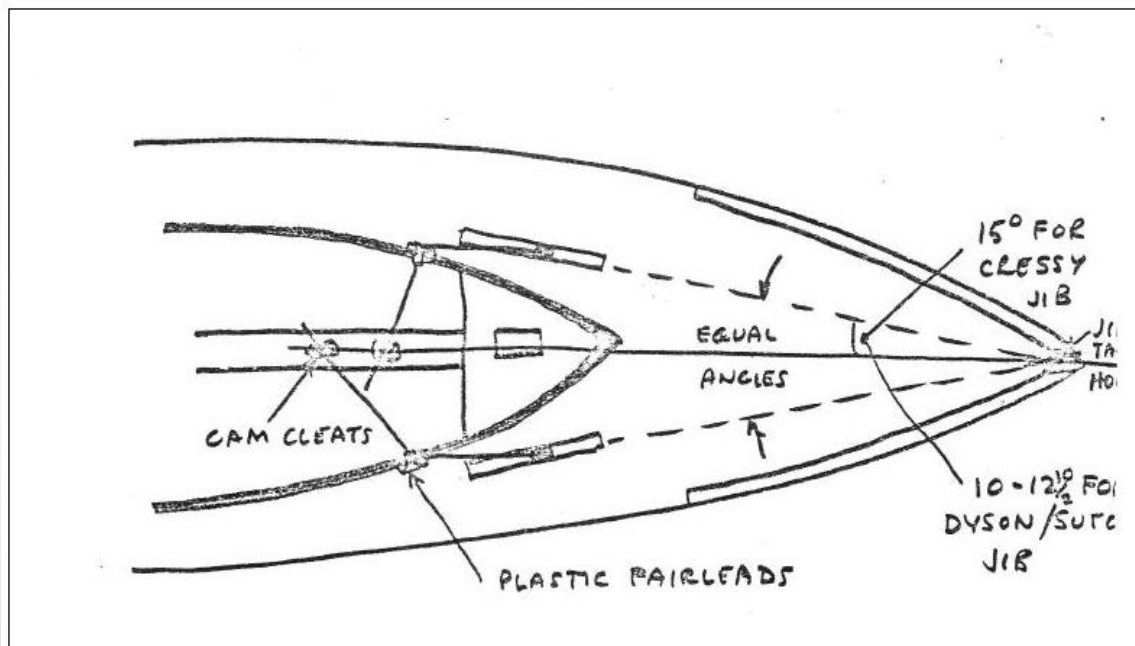

Use the Trim Line on the jib to locate the fore and aft position of the jib track. Set the track so that the trim line is on the Jib Turning Block in the middle of the track.

Trim Line is a line from the center of the jib luff running through the jib clew grommet. New jibs come with a trim line. Older jibs will require marking

Traditional Jib Lead Arrangement (from the 1970 Elders)

- **Tracks with Movable Blocks**
- **Fairlead through Combing**
- **Cam Cleat on CB Box or Combing**

JIB TRACK PLACEMENT

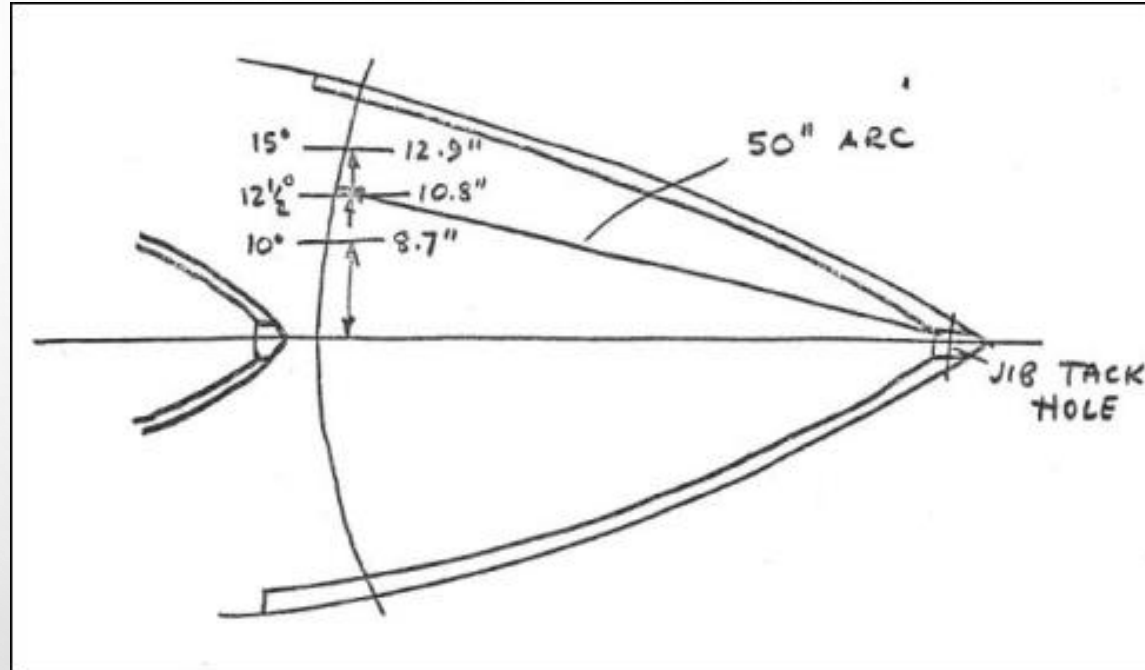

Measure 50" from the jib tack grommet and 8 3/4" perpendicular to the Centerline to get the 10 deg lead angle for the new Doyle jibs.

**Traditional Jib Lead Angles
(from the 1970 Elders)**

JIB TRACK HISTORY- #2093

(FOLLOW THE HOLES)

15 Deg Jib Track
10 Deg Jib Track
Older Diagonal Track

Pre-2018 Doyle/Cressy Jib Cut used 15 Deg Track. Post 2018 Doyle Jib is Cut Flat and uses the 10 Deg Track to “squeeze” the Jib/Main Slot.

Don't use the 10 Deg Track with Pre-2018 Jibs which are a Fuller Cut



JIB TRACK LAYOUT #2086



Jib Block all way
aft on a 10 deg track
provides best trim for
newer Doyle jibs



Jib track is on
a 10 deg angle

The background features a close-up, slightly blurred view of a compass rose. The compass is circular with a dark face and a light-colored bezel. The needle is visible, pointing towards the top. The entire scene is set against a dark background, and several clear, realistic water droplets of various sizes are scattered across the image, some appearing to be on the surface of the compass or floating nearby.

DECK RUNNING RIGGING

Jib Track

Jib Out Haul

WHY A JIB OUT HAUL

- Need to Open up slot for Reaching.
 - Windward Jib turning block location too narrow for Reaching
- Jib turning block needs to be outboard to open jib/main slot
- Use the Outhaul to pull the Jib Sheet outboard to the rail while reaching

TOWNIE JIB OUT HAUL #2093



Normal Position for
going to Weather



Extended Position for
reaching



Pennant with Clam Cleat
on Combing

TOWNIE JIB OUT HAUL

#2086

Note Small Dia Jib Sheet

Low Friction Rings

Vectran
Slippery

Chain Plate
Spreader Bar

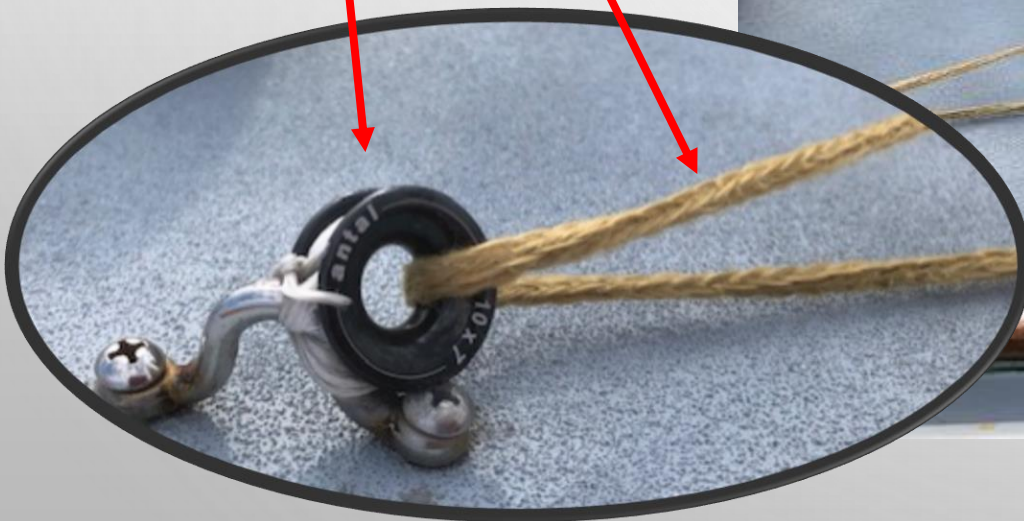
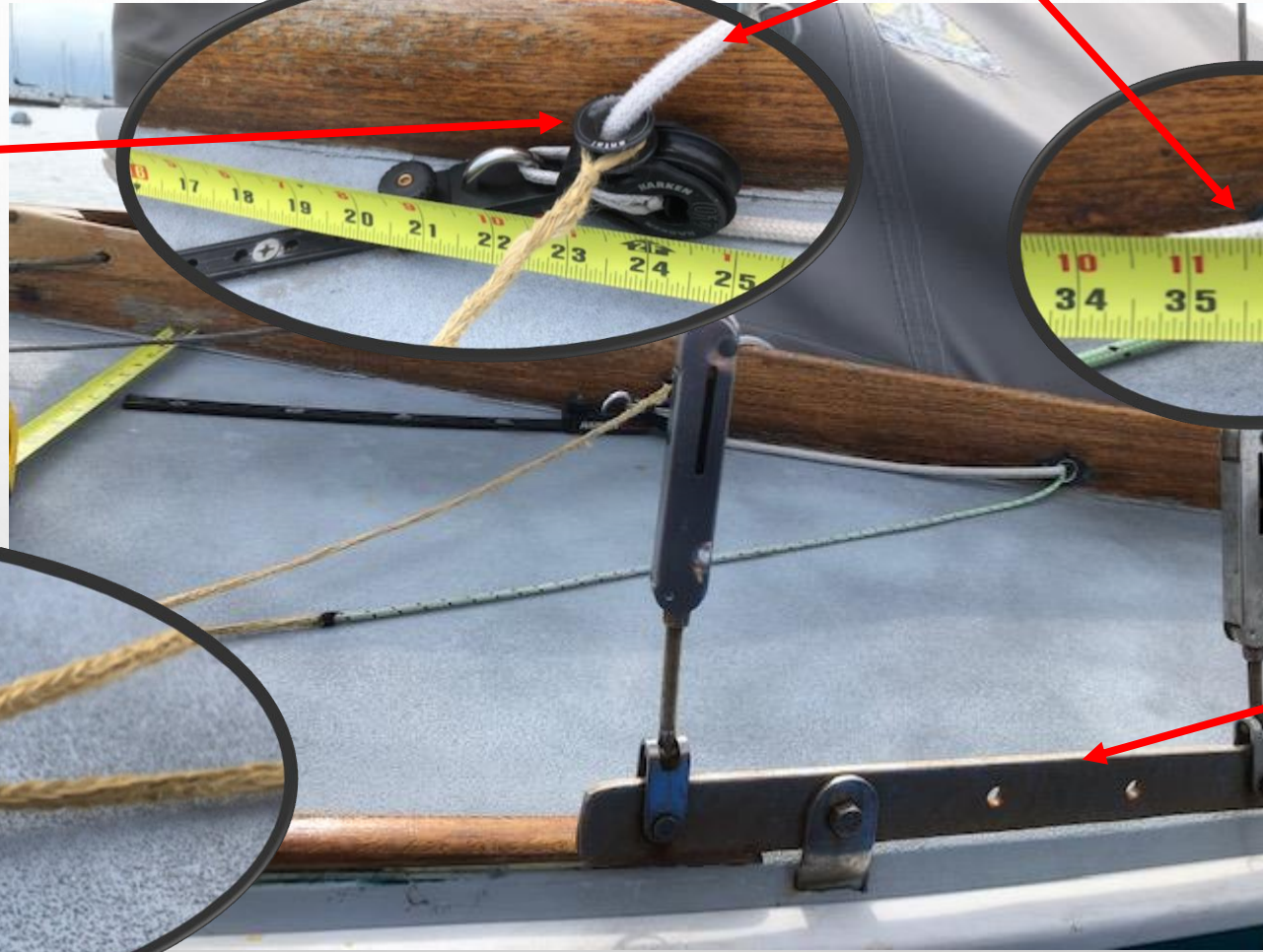



MAIN TRAVELER

Soft Traveler Option

WHY A SOFT TRAVELER

- Hard travelers are great for attaching the main sheet block, but not great for sail control
- Soft travelers permit positioning the boom in light or heavy air while optimizing sail shape for conditions without distortion.
 - Light air: enables pulling boom to centerline in light air without flattening the Main shape
 - Heavy air: enables dropping the boom to the leeward rail to create a heavy air friendly flat Main.

Soft Traveler
permits
Dropping boom to
leeward In heavy air.

Sail Shape is Maintained
while not causing
excessive heel



SIMPLE SOFT TRAVELERS (FROM THE ELDERS)

Limited Control Traveler

Better Soft Traveler Better

Control, Permits Center line Sheeting and Gunwale Sheeting

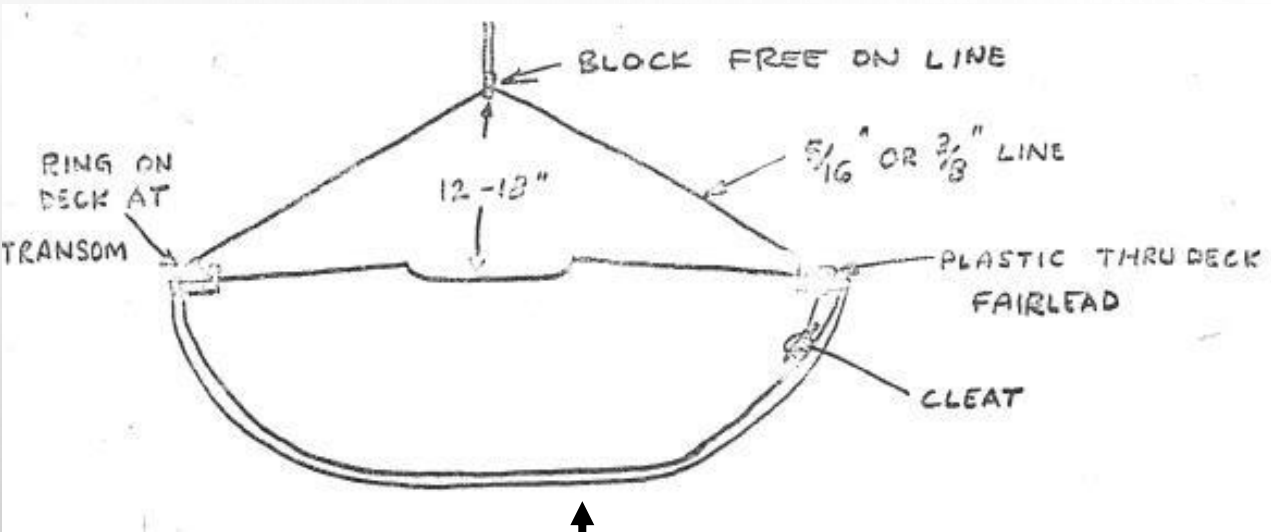

No Control Traveler

Simple Soft Traveler Limited Control
But Permits Limited Sheeting to Gunwale

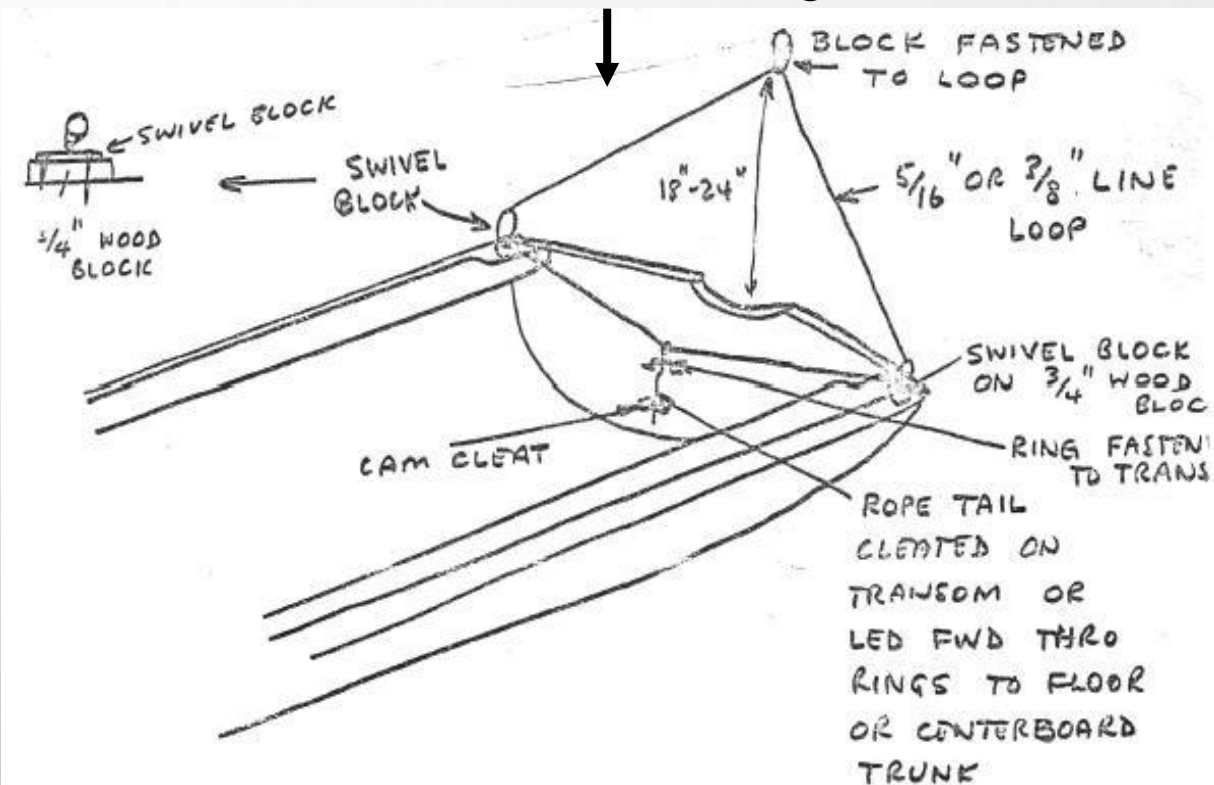

CONTROLLABLE TRAVELER #2093

Continuous Vectran Loop
With block at top and control
lines on bottom

Port and Stbd control
lines pull the bottom of the loop
enabling the movement of the
mainsheet block to windward for
light air and to leeward in heavy
air.



CONTROLLABLE TRAVELER #2093



Stbd Traveler Control Line.

Plastic Fairleads keep the control line along the flotation tanks

Cam Cleat mounted under the deck after the turning block



INTERESTING STRUCTURAL ITEM
Hull to Deck Joint

WHY HULL TO DECK JOINT ?

Hull joint gets loose and water seeps in when boat is heeled over, wetting the foam floatation and adding weight.

- Remove the rub rail and the track around the boat holding the hull and deck together.
- Seal the hull to deck joint so that no water is getting in when the boat is heeled. Use 5200 and pop rivets .



Hull to Deck joint with
Fendering removed
Seal with 5200 and re-rivet
Joint with pop rivets



INTERESTING STRUCTURAL ITEM
Transom

WHY TRANSOM ?

Transom wood reinforcing gets wet from leaks related to the rudder track screws not being sealed.

- The inside of the transom is plywood. Check it for water. Remove the bottom screw in the rudder track and see if water comes out.
- For replacement, remove the inner skin, leaving the outer skin and rudder track and build it back up with new marine plywood or foam board laminate and fiberglass. Alternate approach is to remove outer skin, vice inner skin.

ALTERNATE OUTER SKIN REMOVAL

New Wood in
Place, epoxy
drying



Note
Hull Thickness
"Not too Thin"
LOL

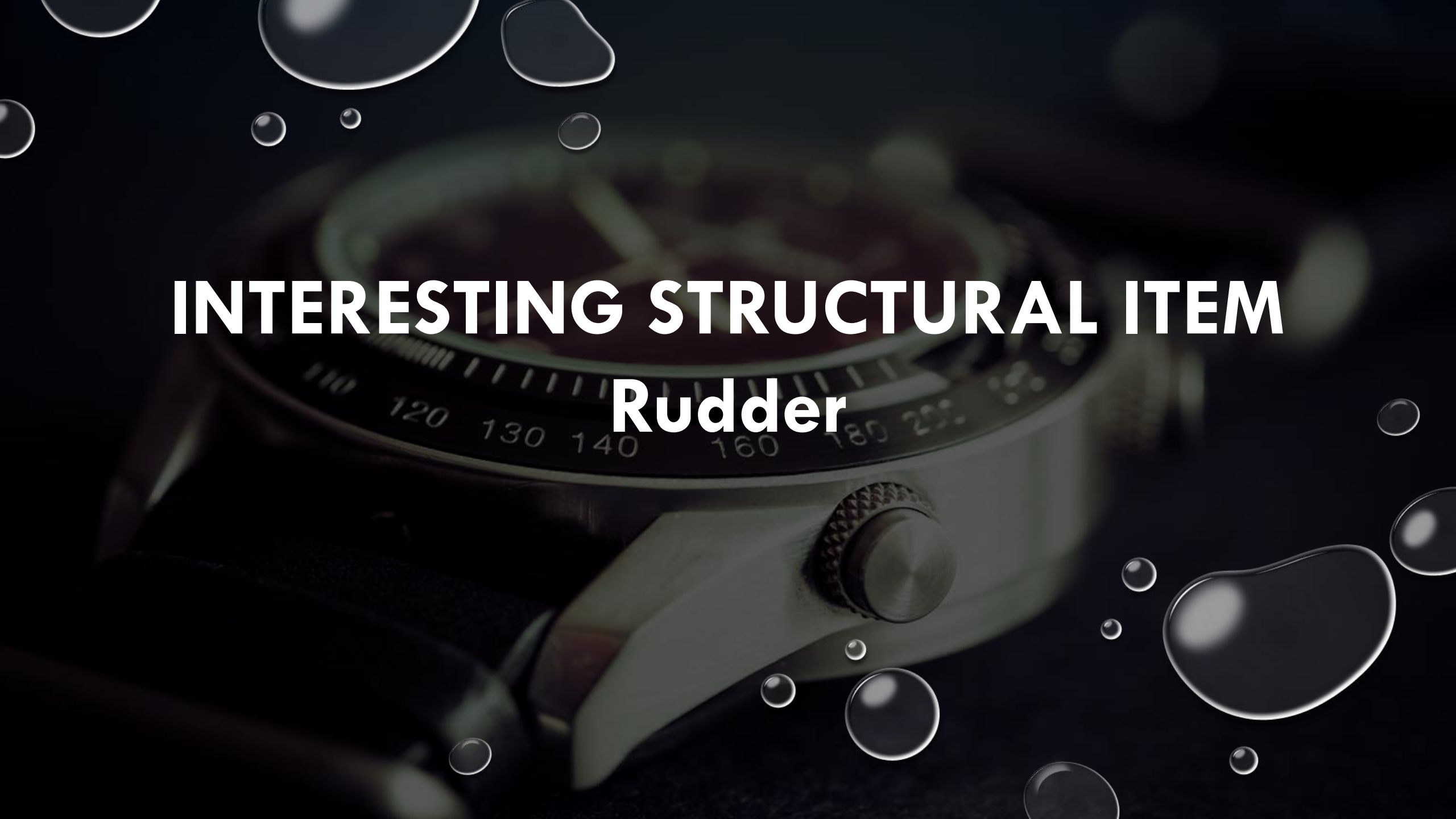

INTERESTING STRUCTURAL ITEM
Rudder

WHY RUDDER ?

- Inspect your rudder and make sure it is sound.
- Cracks occur between pintals. Repair with epoxy.
- Make sure your Tiller is long so Skipper can sit way forward.
- Make sure you have a Hiking Stick as well as a long Tiller
 - Adjustable Length is nice. Get a rubber universal joint which has no slop
- Bart uses a Tiller about 63” with a fixed 30” Hiking Stick.

Look for cracks
in this area and
repair with epoxy
before they get bad.

Cheek Plates loosen near
top of Rudder. Be sure to
check.





INTERESTING TIDBIT

Bow Cleat Cover

BOW CLEAT COVER #2093

Need a Cleat Cover to Keep
Jib Sheet from Fouling at
Wrong Moment

Many variations. Some are
plastic and cover Cleat
completely. Some are metal.
Wrapping Bow Line around
Cleat works as well

#2093 uses Bent Brass stock
And Velcro





INTERESTING TIDBIT

Mast Bands

WHY MASTS BANDS ?

- Original intent to keep sailors from cheating by having a sail too big
- Town Class Rules:
 - “THE OUTER EDGES OF A PAIR OF BANDS SHALL BE LOCATED 19’ 8” APART. IF DESIRED, ADDITIONAL PAIRS OF BANDS MAY BE USED. THE SAIL MUST BE LOCATED WITHIN ONE PAIR OF BANDS WHILE RACING.”
- Town class practical use: **“Ensure sail is hoisted to top of mast”**
 - Hoist sail and see if foot is outside the lower band.
 - If the Foot of the Main is way outside lower band, then check to ensure sail is at the top of the mast.
 - No sense in starting a race with a Handicap



**MOM,
When I Grow up
I want to be a
sailor.**

**Well son
you have to decide
you can't do both**



References

MASTHEAD REFERENCE DIMENSIONS

Measurement from Masthead to Outside of Transom using Main Halyard

Boat	Owner	Rake	Mast Butt Position	Distance	Date
2047	Cooke	Vertical	Forward	24'10"	2015
2074	Solstad	Forward	Standard	24'10"	2015
2086	Howes	Slight Aft	Forward	24' 7"	2018

NOTE: Moving mast forward (2047) and raking forward (2074) provided the same dimension with approximately the same forward movement of the sail CE

MAST STEP REFERENCE DIMENSIONS

Distance from Front of CB box to Fwd End of Step

Pert Lowell Rebuild

2086

2093

7"	10 1/2"	12 1/2"
----	---------	---------

NOTE: 2086 is one of the fastest boats in the Fleet and sails with mast vertical. A 7" step dimension permits only forward rake to stop weather helm.

CENTERBOARD PIN LOCATION REFERENCE DIMENSIONS

Boat #	Distance from inside of transom to Center of CB pin
2093	10' 3/8"
2074	10' 1"
2047	10" 3"

NOTE 1: CB PIN AFT IS BETTER FOR A NO WEATHER HELM SOLUTION

NOTE 2: CB PIN IS INSTALLED AT BOAT YARD. CHECK TO ENSURE MEASUREMENT IS IN CORRECT RANGE