



844-FLO-STOP | sales@mainlinecs.com | www.MainlineControlSystems.com

**Mainline**  
Control Systems

# Kleiss MCS60-1016 System Manual

Flow Stopping System / 10" - 16" (18" PE) up to 60 psi

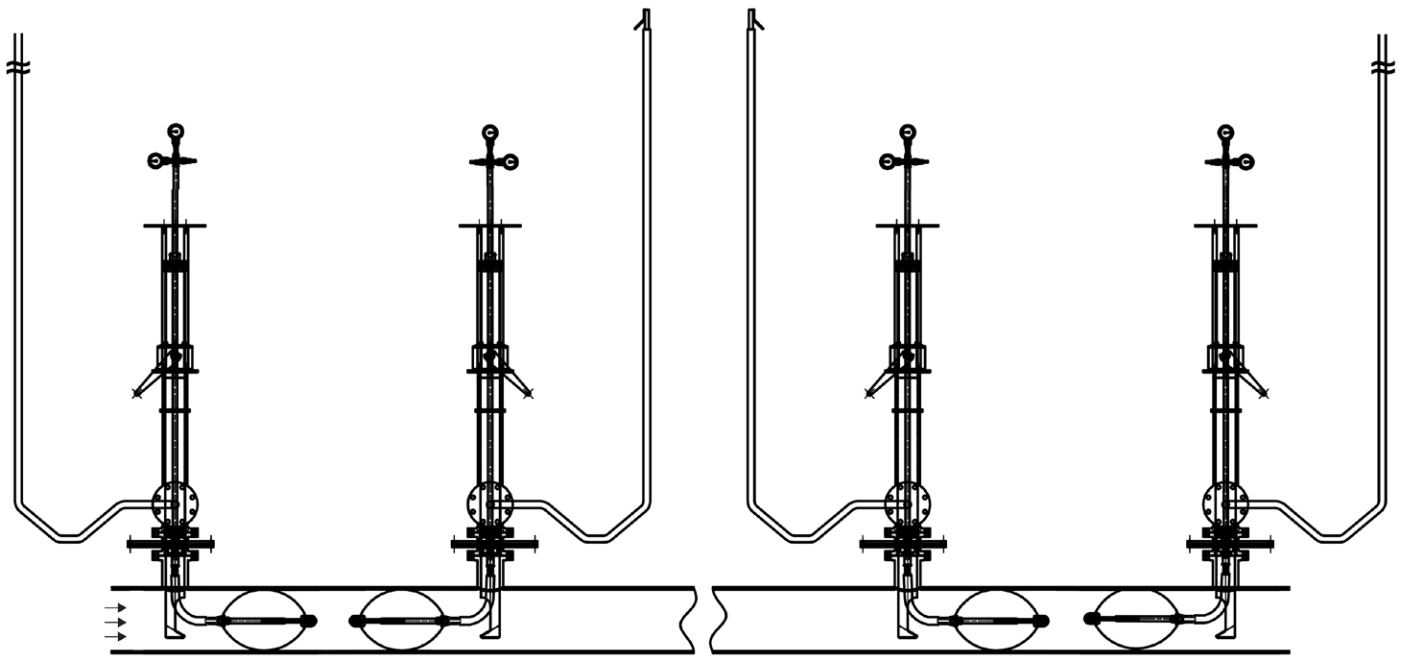



## **Kleiss MCS60-1016 System Overview**

The Kleiss inflatable stopping systems meet the needs of the North American Natural Gas LDCs by providing a flow control system that is easy to use and effective at stopping off flow in various pipe materials and a wide range of pipe diameters.

The Kleiss MCS60-1016 System consists of four major components:

1) fitting to access the pipe, 2) tapping / completion tool, 3) inflatable stopper, and 4) stopping tool.

The Kleiss MCS60-1016 System (all tools) has a maximum operating pressure of 60 psi. The inflatable stoppers have a design safety factor of 3. The balance of the tools have a design safety factor of 2.5.

The Kleiss MCS60-1016 System is designed to handle flow control on pipe sizes 10” to 16” (18” PE) on all pipe material – cast iron, polyethylene, steel and PVC pipes. To accommodate the various pipe materials and sizes the tapping tool and stopping tool are outfitted with the appropriate fitting, cutter, chute, and stopper. See the Sizing Table in Section 4.0 to identify and install the correct components before operating the equipment.

The basic operation of the equipment is the same for all pipe materials. When working on non-metallic pipe materials, make sure the equipment is grounded per your company operating practices.

*(Kleiss & Co., who developed the system, has reviewed and approved this manual.)*

## **Table of Contents:**

Table of Contents: .....	1
1.0 General Safety Information: .....	2
2.0 System Specifications: .....	2
3.0 Typical Site Set Up and Sequence: .....	4
4.0 Equipment: .....	9
5.0 Preparatory Steps: .....	16
6.0 Tapping Operation: .....	16
7.0 Stopping Operation: .....	25
8.0 Retrieving MDS Stopper: .....	35
9.0 Plugging Operation: .....	41
10.0 General Maintenance: .....	45
APPENDIX A: Stopper Testing and Verification.....	46
APPENDIX B: Tower Positioning and Distances .....	48
APPENDIX C: Manual Updates.....	52

## 1.0 General Safety Information:

**NOTE:** Before using the Kleiss MCS60-1016 System make certain you read the instruction manual completely and are comfortable and familiar with the operation of the tools. If you have any questions, concerns or feel there is conflicting information, please contact Mainline Control Systems (MCS) before proceeding at 844-FLO-STOP.

**NOTE:** The purpose of the Kleiss MCS60-1016 System is to tap and stop flow in natural gas lines sizes 10” through 16” (18” PE) operating at a maximum of 60 psi. Review and follow your company safety procedures for operations involving tapping and stopping live natural gas lines.

**NOTE:** When operating the Kleiss MCS60-1016 System on non-metallic pipe materials, please follow company procedures for grounding equipment for discharge of any static electricity.

## 2.0 System Specifications:

### 2.1 General

- A) Pipe diameter between 10” and 16” plus up to 18” polyethylene
- B) Pipe material of cast iron, polyethylene, steel or PVC
- C) Maximum operating pressure of 60 psi  
*NOTE: Tools are designed and built with a safety factor to allow +10% (+6 psi) for operation on 60 psi MAOP systems or in abnormal operating conditions.*
- D) Tool to fitting connection of 4” ANSI 150 flange

### 2.2 Tapping Tool and Completion Tool Kit Specifications

- A) Maximum operating pressure of 60 psi (see NOTE in 2.1C)
- B) Cutters available
  - a) 3.8” (96.5 mm) cast iron and steel [Part #13200725]
  - b) 3.8” (96.5 mm) polyethylene and PVC [Part #13100100]
- C) Pilot drills available
  - a) 0.5625” (14.3 mm) cast iron and steel [Part #14300010]
  - b) 0.433” (11.0 mm) polyethylene and PVC [Part #13200727]
- D) Air motor & compressor requirements
  - a) Connection to the air motor ~ 3/4” NPT
  - b) 90 psi measured at the inlet of the air motor during operation
  - c) Air volume through the motor should operate the air motor at 20 RPM’s load speed (cut) & 40 RPM’s free speed (non-cut)
  - d) Refer to manufacturer air motor specifications guide
- E) Oiler / separator required to be used to extend the life of the air motor
  - a) Use standard pneumatic oil in tool
- F) Weights
  - a) Tapping tool with cutter, stabilizing bridge, and bridge stands = 67 lbs.
  - b) Completion tool without plug attached = 38 lbs.
  - c) Air motor = 31 lbs.
  - d) Shipping weight in case = 152 lbs.
- G) Dimensions
  - a) Tapping tool height with cutter, stabilizing bridge, and bridge stands = 51”
  - b) Completion tool height = 37”
  - c) Storage case = 57” length x 17” width x 12” height

## 2.3 Stopping Tool Kit Specifications

- A) Maximum operating pressure of 60 psi (see NOTE in 2.1C)
- B) Stopping Case Weights
  - a) Stopping tool = 116 lbs.
  - b) Stopping case shipping weight = 260 lbs.
- C) Stopping Case Dimensions
  - a) Stopping tool height with stopper rod completely extended and gear box cranked to highest position = 12' 11"
  - b) Stopping tool height with stopper set = 10' 7"
  - c) Storage case = 85-1/2" length x 19-1/2" width x 19-1/2" height
- D) Stopping Accessories Case Weights
  - a) Slide gate valve = 34 lbs.
  - b) Stopping accessories case shipping weight = 88 lbs.
- E) Stopping Accessories Case Dimensions
  - a) Slide gate valve height = 5" (9-1/2" with bolts)
  - b) Storage case = 30" length x 28" width x 10-1/2" height
- F) By-pass / vent port
  - a) Full 4" ANSI 150 (3-3/4") tap size
  - b) 4" ANSI 150 flange connection

## 2.4 MDS Inflatable Stopper Specifications

- A) Sizes
  - a) 8.85" – 10.82" (225 mm – 275 mm) Pipe ID [Part #23101357]
  - b) 9.84" – 12.40" (250 mm – 315 mm) Pipe ID [Part #23101358]
  - c) 12.40" – 15.74" (315 mm – 400 mm) Pipe ID [Part #23101359]
- B) Inflation pressure of 120 psi or 2x system pressure if unable to achieve 120 psi by compressor or nitrogen
- C) Design burst pressure of 350 psi
- D) Operating temperature range of 5° F (- 15° C) to 140° F (60° C)
- E) Maximum temperature range of 158° F (70° C) for up to 30 minutes

## 2.5 Vent Stack Specifications

- A) Height assembled = 112"
- B) 1" camlock male coupling
- C) Air hose to venturi connection
- D) Hose (standard) of 10 m, 1" camlock connection F x F
- E) Ground rod included
- F) Weight (less hose) = 27 lbs.
- G) Air supply and flow capacity rates =

Air Supply		Flow Capacity
Working Pressure (PSI)	Air Consumption (ft <sup>3</sup> /min)	Blow Out Volume (ft <sup>3</sup> /hr)
80	13	24300
120	13	21200

## 2.6 Hand Pump (Pressure and Vacuum Pump)

- A) 1 positive pressure connection
- B) 1 negative pressure (vacuum) connection
- C) 10 foot air hose with quick disconnects included
- D) Weight = 12 lbs.

## 2.7 Maximum Flow Rates

- A) Maximum design flow rate = 60 ft/sec (18.288 m/sec)
- B) For reducing speed, use by-pass / vent port

**NOTE: The system is designed to be used in controlled stop off applications, and is not intended to be used to stop flows in severely ruptured pipes. Flow should be reduced before attempting stop off.**

## 3.0 Typical Site Set Up and Sequence:

It is important to understand the MCS stopping tools and their operation completely. It is also important to understand the complete job and sequence of steps to perform a safe stop. Safety of the operators on the job site is the most important factor so pre-plan the whole job including the stopping and retrieval sequences.

The following examples are typical installations. Example I (yellow background) illustrates stoppers positioned towards each other. Example II (blue background) illustrates stoppers positioned away from the work area. Both configurations work equally well. For additional set up illustrations, see Appendix B or contact your distributor / MCS representative.

Remember to consider the ancillary steps like purging / venting the area to be worked on and back pressuring stoppers for removal. The features of the MCS60-1016 offer options to make these processes efficient.

Plan accordingly to avoid launching or inflating stoppers under existing fittings, joints, or other obstructions.

## Example I – Stopping Sequence: Stoppers Positioned Towards Each Other (Most Flexible)

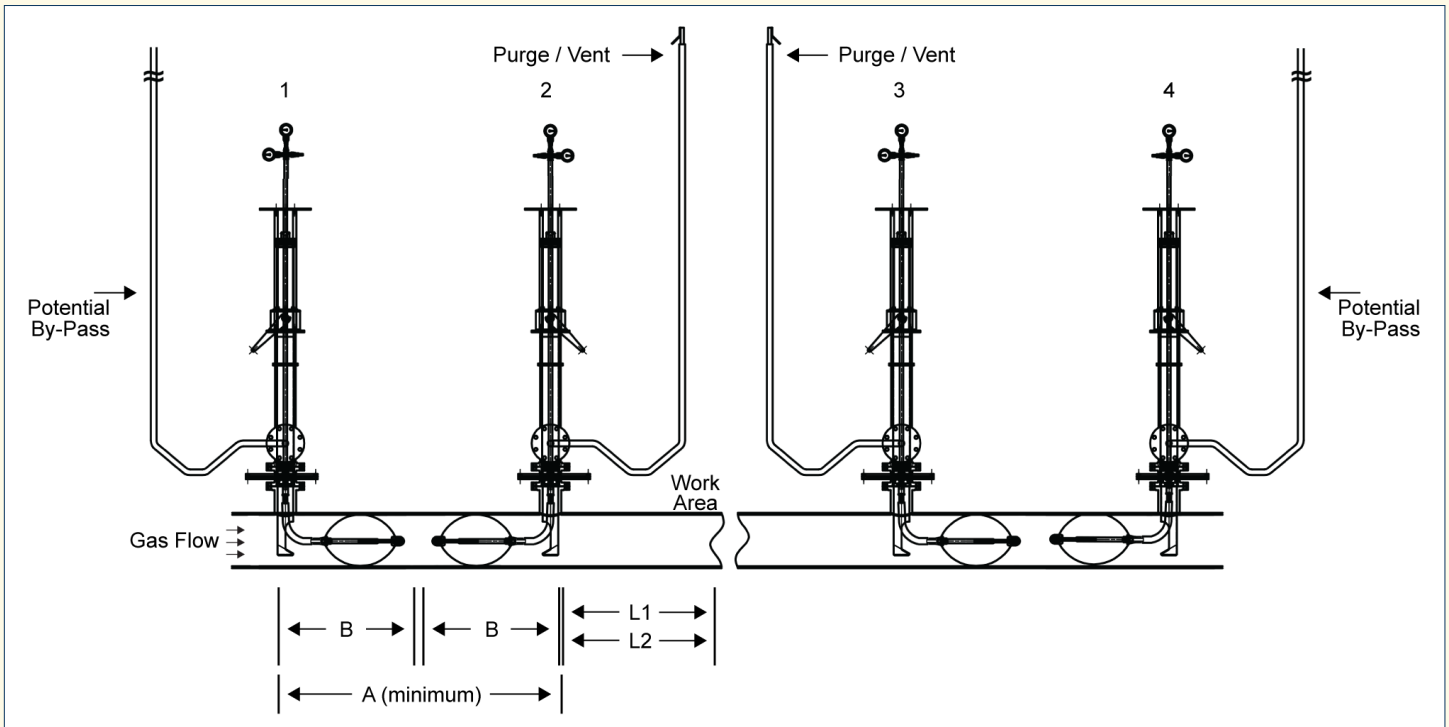

### STOPPING TOWER DISTANCES

Nominal Pipe Size	A (minimum)	B	L1* = Steel Welding	L2** = PE, CI, and Mechanical
10"	88"	44"	40"	30"
12"	106"	53"	40"	36"
14"	106"	53"	40"	42"
16"	114"	57"	40"	48"
18"	114"	57"	N/A	54"

*A = minimum distance between towers*

*B = stopper length*

*L1\* = distance from stopper/tower to work area - use standard industry & company practices to minimize heat transfer & sparks reaching the inflatable stopper*

*L2\*\* = distance from stopper/tower to work area - measurement is a guide only, follow manufacturer's fitting recommendations*

- 1) If a by-pass in the work area is being used (through our MCS tool or another), initiate the by-pass flow first.
- 2) Always insert first inflatable stopper WITH the flow of gas.
- 3) Always inflate the stopper as quickly as practical.
- 4) Suggested stopper setting sequence is tower #1, #2, #3, #4. Set all 4 stoppers.
- 5) First inflated stopper is now in a no flow condition. Reset stopper for best possible seal (deflate, reposition stopper rod, inflate).
- 6) Always allow stoppers to settle for 10 minutes prior to beginning pipeline work. This allows the stopper to acclimate to internal pipe conditions. Verify system pressures, inflation pressures, and any bleed-by before starting pipeline work. Adjust as necessary.
- 7) Use the by-pass / vent port on tower #2 or #3 to purge the work area. Utilize the MCS vent stack to assist in evacuating the work area. This connection can also be used to inject nitrogen into the work zone.
- 8) Keep by-pass / vent ports on towers #2 and #3 open to atmosphere during work to keep gas away from the work area. Follow company procedures for venting and purging gas.
- 9) This set up can easily be used on both single feed and dual feed systems.



## Example I – Stopper Retraction Sequence: Stoppers Positioned Towards Each Other

NOTE: Always equalize pressure on both sides of the stopper before deflation or removal.

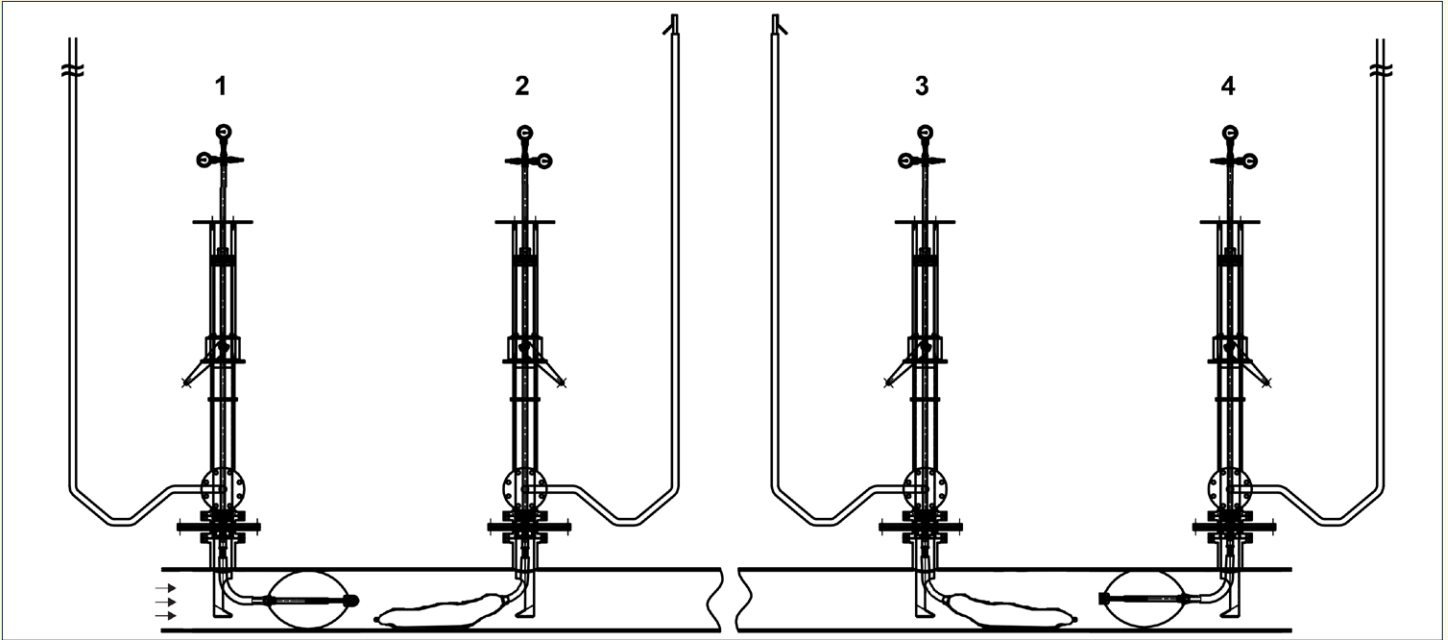

1) Deflate stoppers #2 and #3.

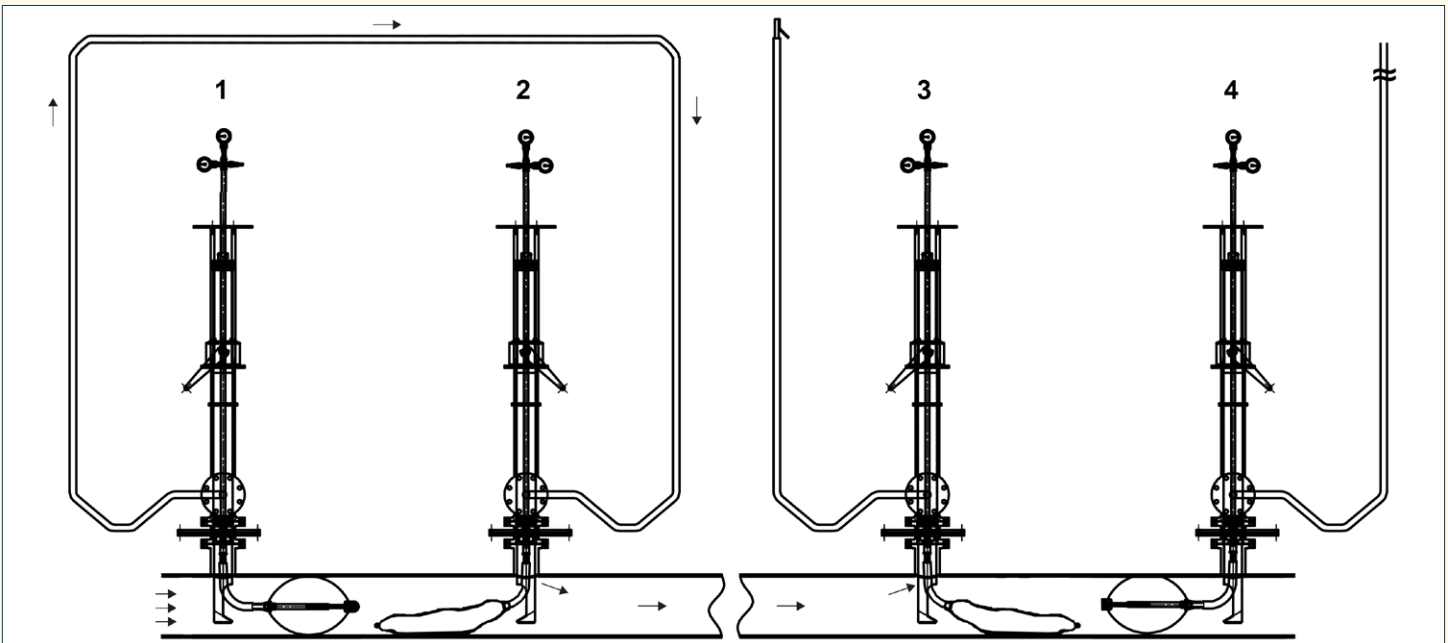

- 2) Use by-pass / vent ports on tower #1 and #2 to equalize pressures on stoppers #1 and #4. Equalize slowly.
- 3) Use by-pass / vent port on tower #3 to purge air from the repaired area.
- 4) Use system pressure gauge on tower #1, #2, #3, or #4 to determine if stoppers are equalized.
- 5) When pressure is equalized, deflate stoppers #1 and #4. Retract all stoppers.
- 6) Remove tools and install completion plugs.

## Example II – Stopping Sequence: Stoppers Positioned Away From Work Area

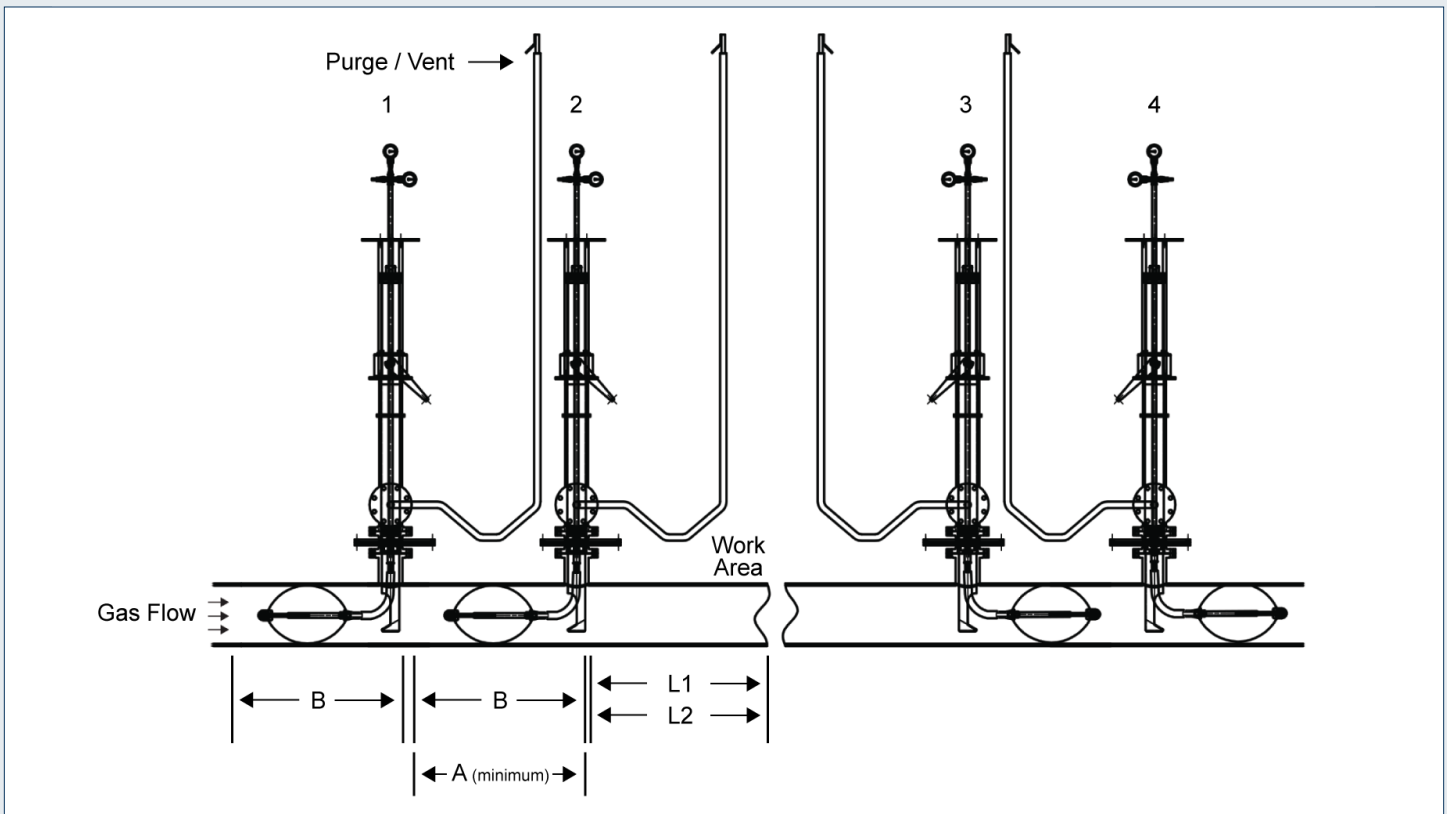

### STOPPING TOWER DISTANCES

Nominal Pipe Size	A (minimum)	B	L1* = Steel Welding	L2** = PE, CI, and Mechanical
10"	44"	44"	40"	30"
12"	53"	53"	40"	36"
14"	53"	53"	40"	42"
16"	57"	57"	40"	48"
18"	57"	57"	N/A	54"

*A = minimum distance between towers*

*B = stopper length*

*L1\* = distance from stopper/tower to work area - use standard industry & company practices to minimize heat transfer & sparks reaching the inflatable stopper*

*L2\*\* = distance from stopper/tower to work area - measurement is a guide only, follow manufacturer's fitting recommendations*

- 1) If a by-pass in the work area is being used (through our MCS tool or another), initiate the by-pass flow first.
- 2) Always insert first inflatable stopper WITH the flow of gas.
- 3) Always inflate the stopper as quickly as practical.
- 4) Suggested stopper setting sequence is tower #3, #4, #2, #1. Set all 4 stoppers.
- 5) First inflated stopper is now in a no flow condition. Reset stopper for best possible seal (deflate, reposition stopper rod, inflate).
- 6) Always allow stoppers to settle for 10 minutes prior to beginning pipeline work. This allows the stopper to acclimate to internal pipe conditions. Verify system pressures, inflation pressures, and any bleed-by before starting pipeline work. Adjust as necessary.
- 7) Use the by-pass / vent port on tower #2 or #3 to purge the work area. Utilize the MCS vent stack to assist in evacuating the work area. These connections can also be used to inject nitrogen into the work zone.
- 8) Keep all by-pass / vent ports on towers open to atmosphere during work to keep gas away from the work area. Follow company procedures for venting and purging gas.



## Example II – Stopper Retraction Sequence: Stoppers Positioned Away From Work Area

NOTE: Always equalize pressure on both sides of the stopper before deflation or removal.

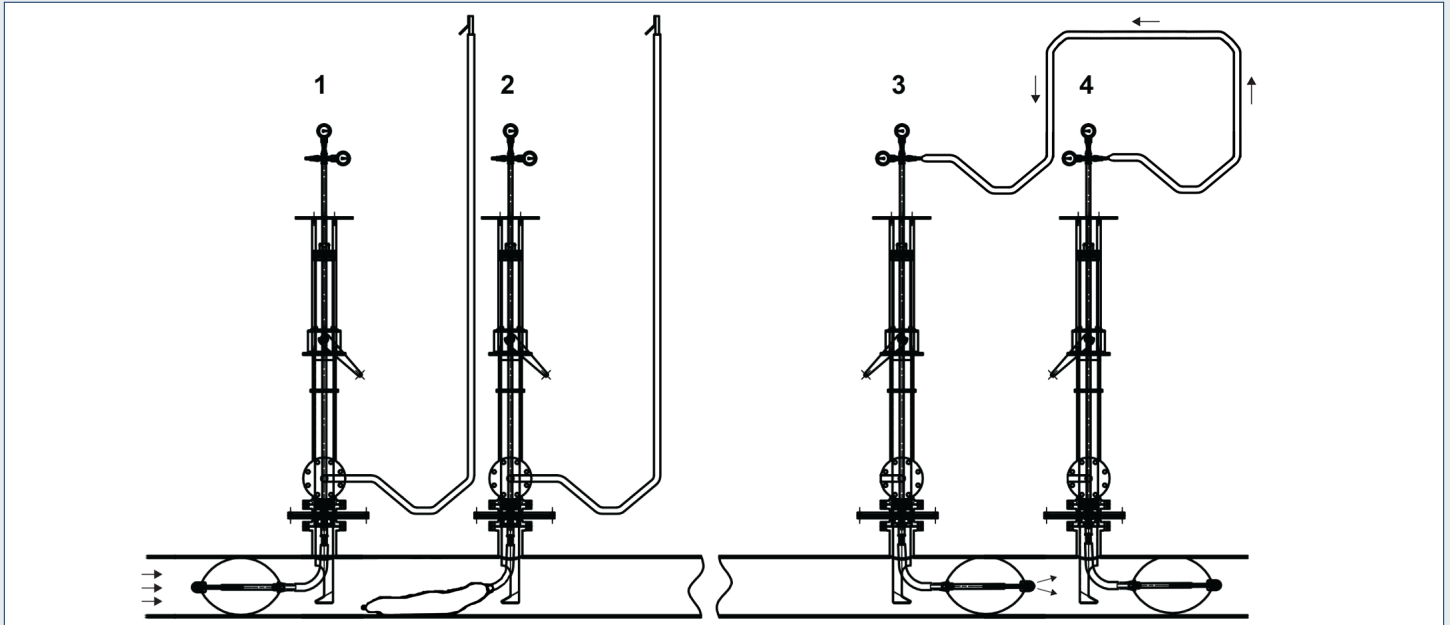

- 1) Deflate stopper #2.
- 2) Back pressure stopper #4 through the system pressure ports in towers #3 and #4.

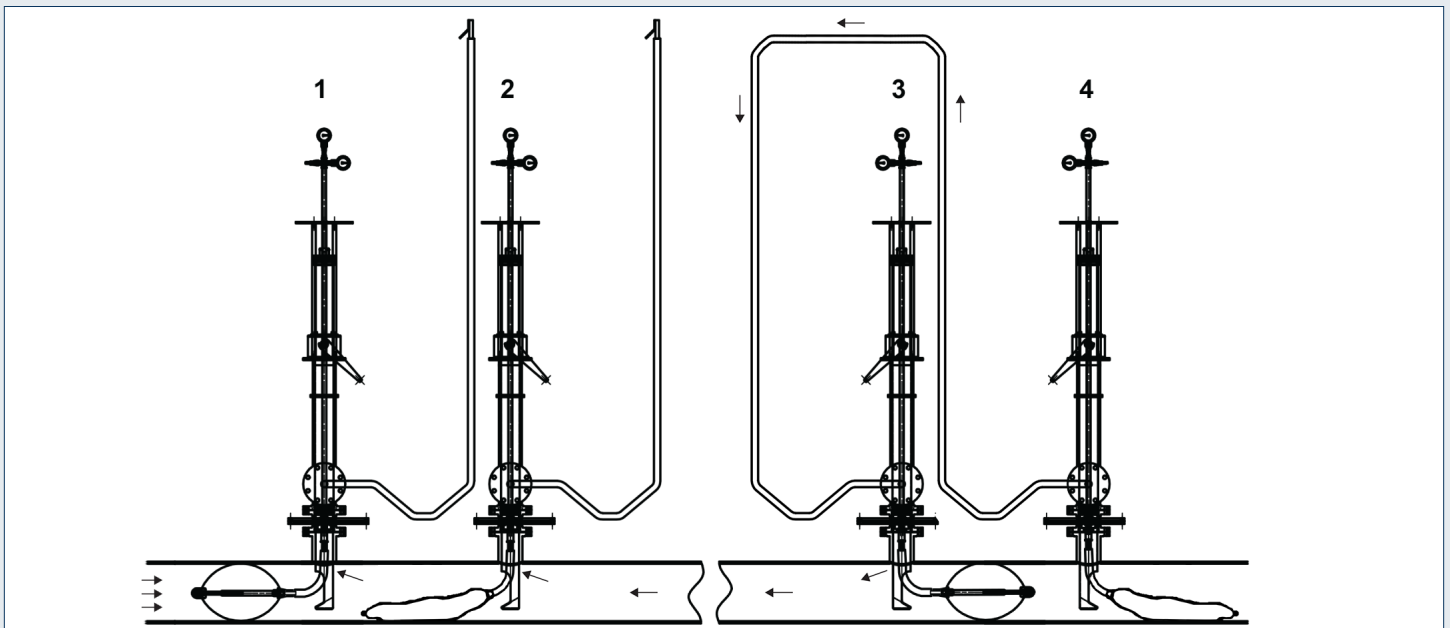

- 3) Deflate stopper #4.
- 4) Equalize pressure on stoppers #1 and #3 through the by-pass / vent port between towers #3 and #4.
- 5) Use the by-pass / vent port in tower #1 or #2 to purge air from repaired area.
- 6) Use system pressure gauge on tower #1 or #2 to determine stoppers are equalized.
- 7) Deflate and remove stoppers.
- 8) Remove tools and install completion plugs.

NOTE: For additional set up illustrations, see Appendix B.

## 4.0 Equipment:

### Tapping Case [Part # MCSTK060-1016-001]:

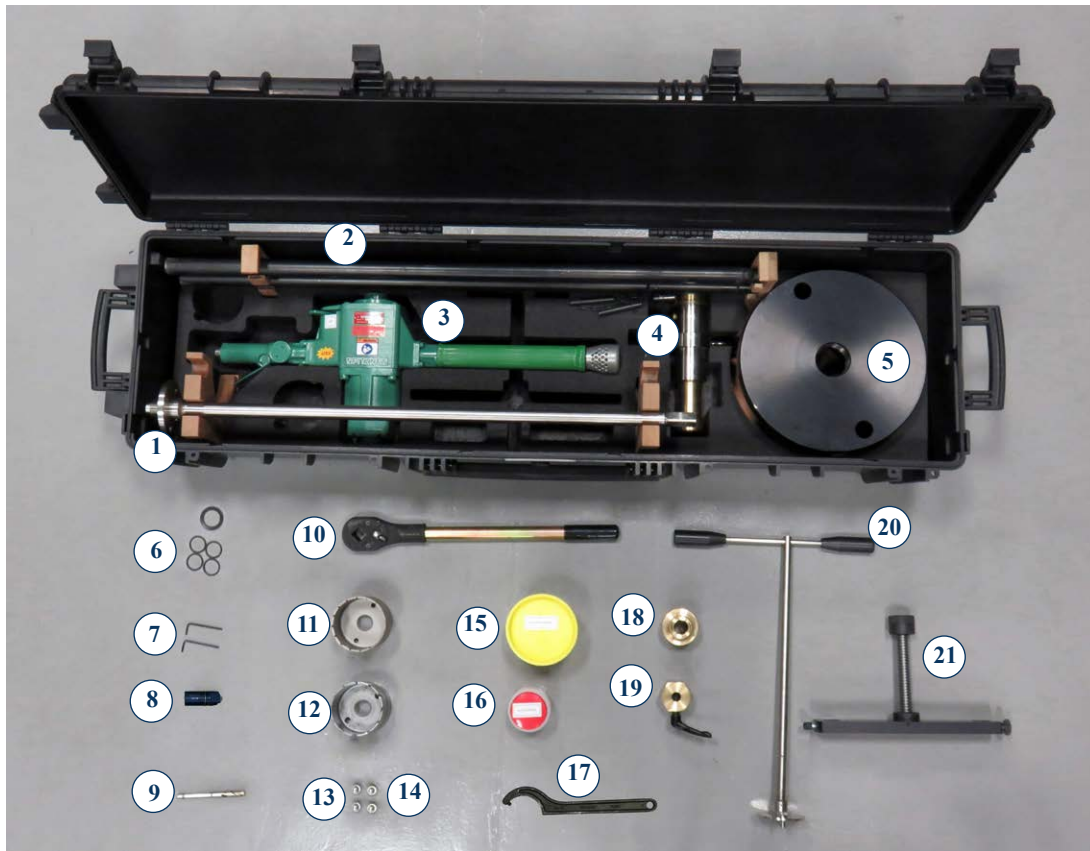

	PART #	DESCRIPTION
1)	10310916	Drilling Rod (865 mm 25 mm x 7/8", square, 20 mm)
2)	90004080	Bridge Stands (2 rods)
3)	10800250	Air Motor (large type, square, 20 mm)
4)	10310800	Tapping Device / Hot Tap Tool (LB-493HD)
5)	10310826	Drilling Dome (2" female x 4" flange 150#)
6)	10310830	Spare Seal Set
7)	10310270	Hex Key (3 mm) [set of 2]
8)	14300010	Steel and Cast Iron Pilot Drill
9)	13200727	PE and PVC Pilot Drill
10)	11000120	Ratchet (square, 20 mm)
11)	13100100	PE and PVC Cutter (1003 96.5 mm x 7/8")

	PART #	DESCRIPTION
12)	13200725	Steel and Cast Iron Cutter (1004HM 96.5 mm x 7/8")
13)	10310925	Cutter Assembly Bolts [set of 2]
14)	99509211	PE Cutter Assembly Bolts [set of 2]
15)	14700014	Cutter Grease (500 ml)
16)	94200020	Silicone Grease Canister
17)	11005310	Hook Assembly Wrench (58-62)
18)	12242500	Dome Adapter Ring (1-1/4" x 16 mm)
19)	10310828	Completion Tool Adapter (1-1/4" male x 2" male)
20)	12242500	Service Rod Assembly for Plugging (2" male connection)
21)	99513365	Feeding Rod with Bridge
	99500003	Case (Explorer)
	99300250	Wooden Interior
	99300251	Foam Interior

## Tapping Tool and Completion Tool Components:

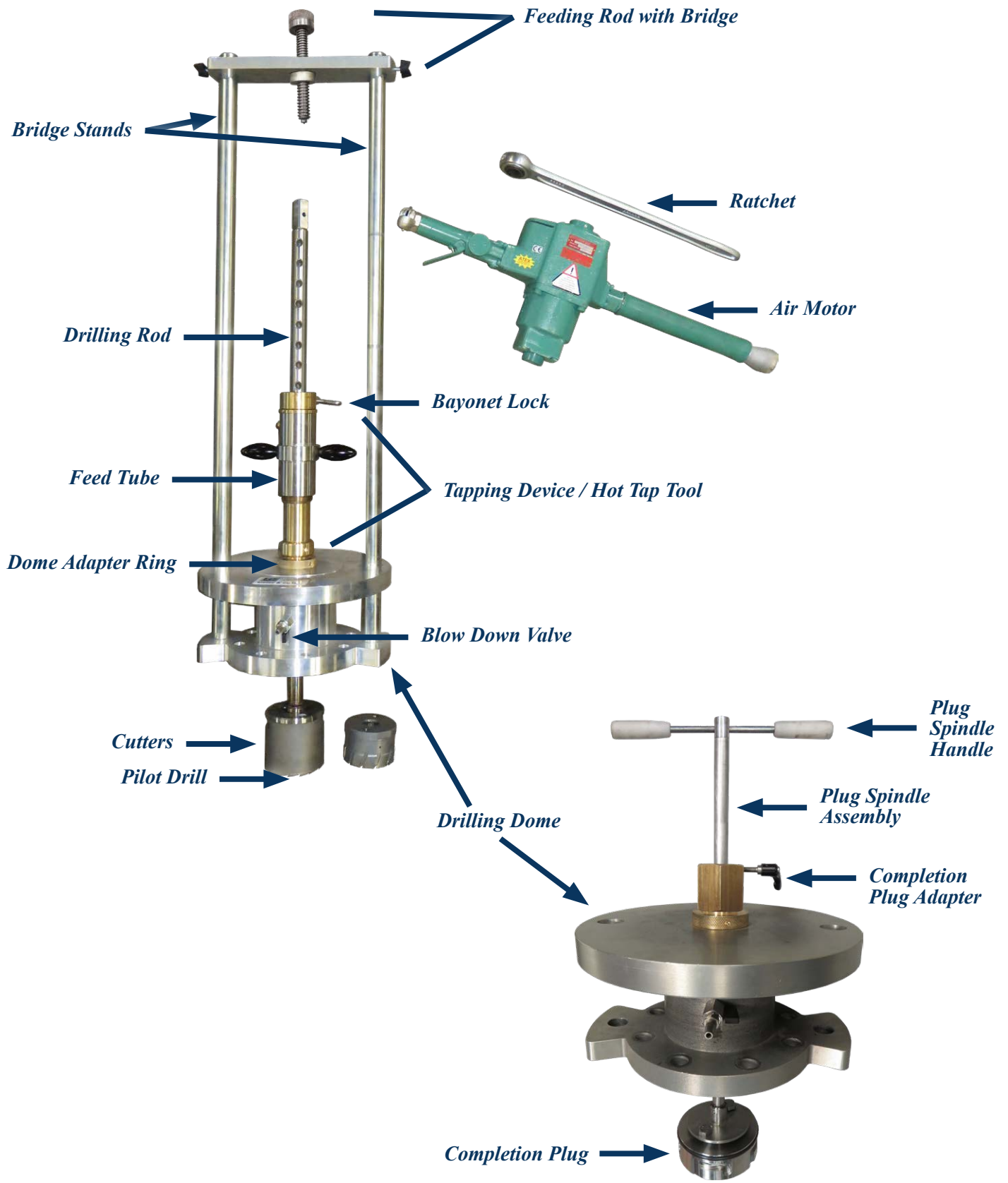

## Stopping Case [Part # MCS060-1016-002]:

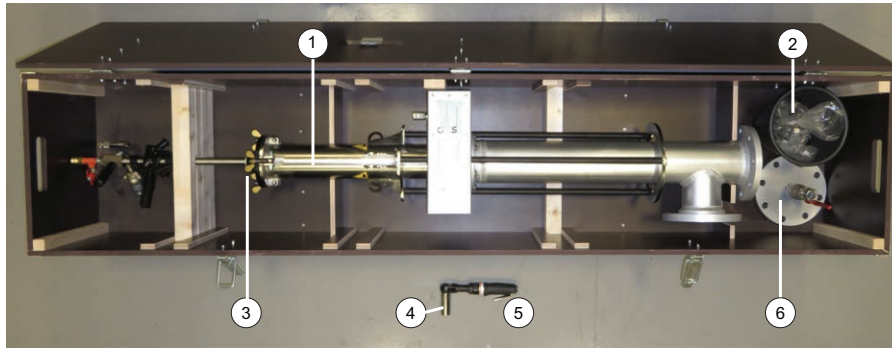

	PART #	DESCRIPTION
1)	12241000	Flow Stopping Tower MCS60-1016
2)	12100044	<i>For By-Pass:</i> 8 Stud Bolts (5/8" x 4"), 16 Nuts, & 16 Washers
	99519097	<i>For Slide Gate Valve:</i> 16 Nuts & 16 Washers
3)	12242220	Bolts for Stopper Rod Removal [set of 2]
4)	12101040	Socket for Gear Box Air Ratchet
5)	AR-1	Gear Box Air Ratchet
6)	12242112	By-Pass / Vent Port / Test Fitting (4" ANSI)
	12241500	Case with Interior

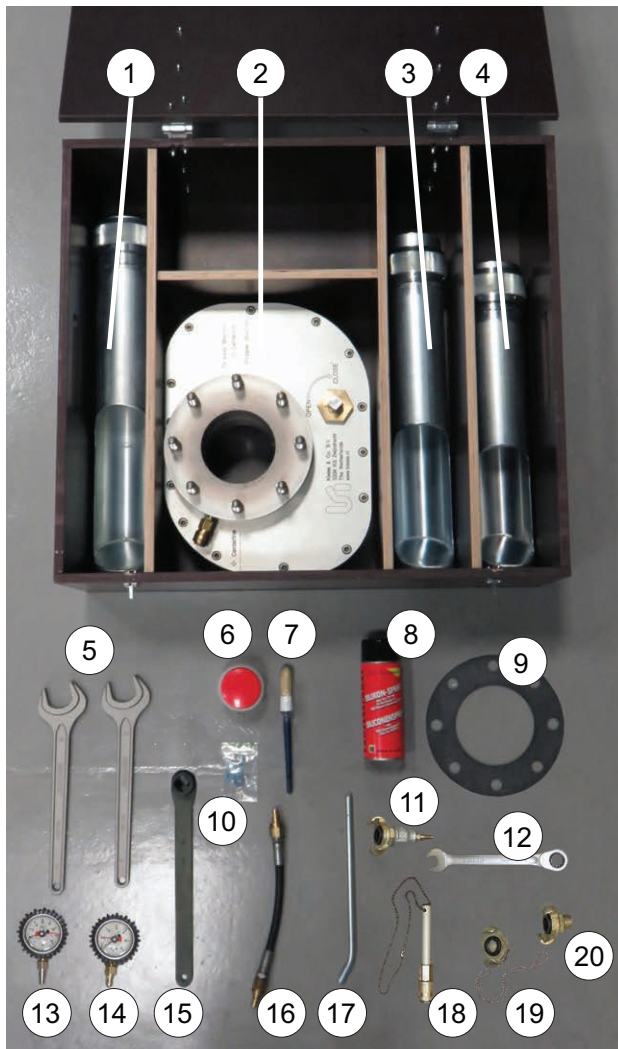

	PART #	DESCRIPTION
1)	12241300	Chute # 1
2)	12242000	Slide Gate Valve
3)	12241310	Chute # 2
4)	12241320	Chute # 3
5)	11000201	Wrench (41 mm) [set of 2]
6)	94200020	Silicone Grease
7)	99600450	Brush
8)	94200010	Silicone Grease Aerosol
9)	99510080	Gasket (4" ANSI) [set of 4]
10)	99519645	Gasket Set (MCS60-1016)
11)	12242210	Hand Pump Adapter
12)	99301338	Wrench for Stopper Rod Removal
13)	12100022	Inflation Pressure Gauge (-15 to 160 psi)
14)	12100023	Pipeline Pressure Gauge (0 to 60 psi)
15)	59512950	Valve Wrench (square, 19 mm)
16)	99401705	Pressure Equalizing Hose
17)	10200190	Jacking Handle
18)	12100740	Safety Fitting (silver)
19)	99000705	Safety Fitting (gold / claw)
20)	99000740	Air Motor Adapter (claw)
	12242100	Case with Interior

**Stopping Tool Components:**

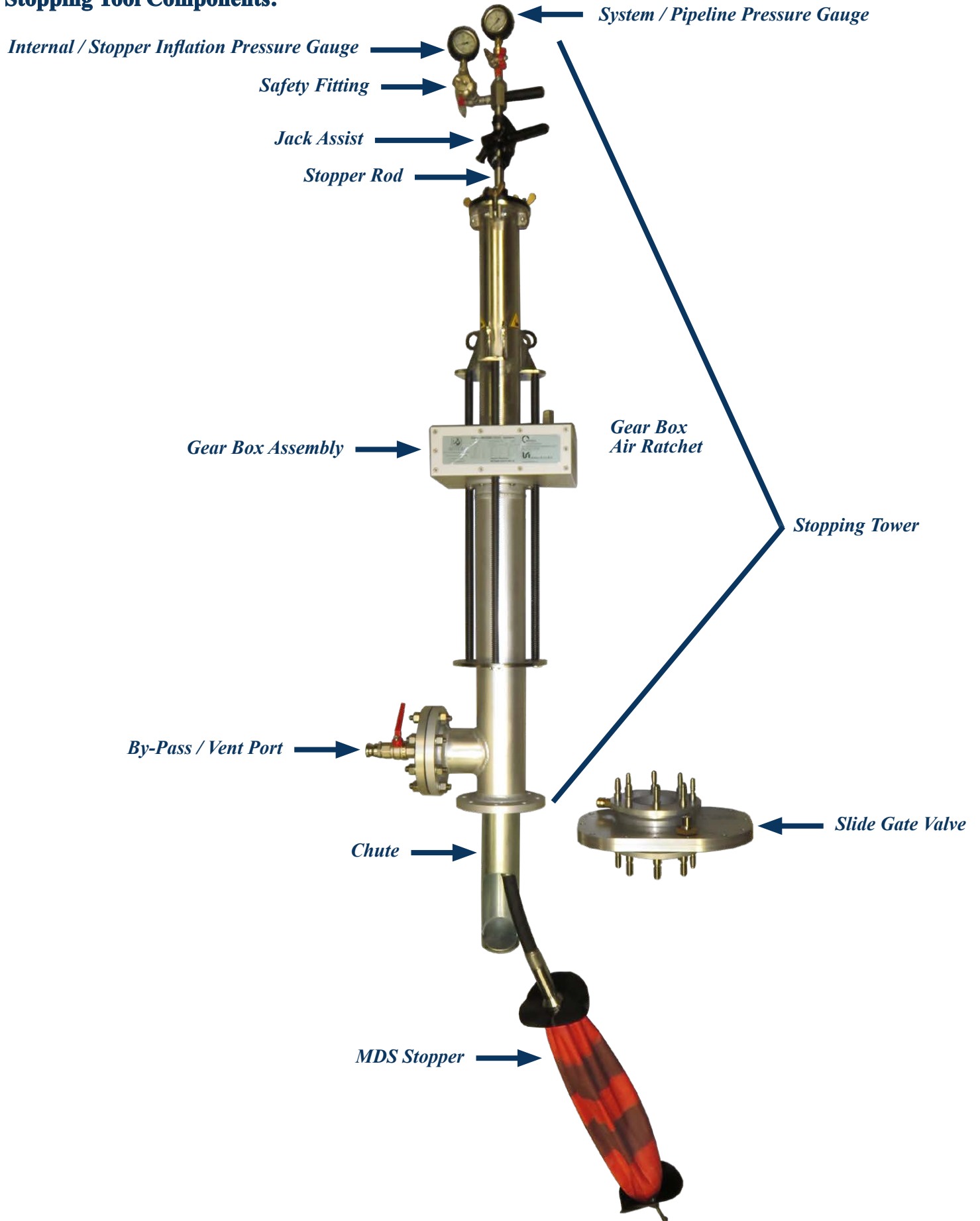



**MDS Stoppers:**



	PART #	DESCRIPTION
1)	23101357	MDS Stopper size 8.85” – 10.82” (225 mm – 275 mm) with Shock Absorber Hose
2)	23101358	MDS Stopper size 9.84” – 12.40” (250 mm – 315 mm) with Shock Absorber Hose
3)	23101359	MDS Stopper size 12.40” – 15.74” (315 mm – 400 mm) with Shock Absorber Hose

**Fitting / Completion Plug / Blind Flange / Stud Bolts:**

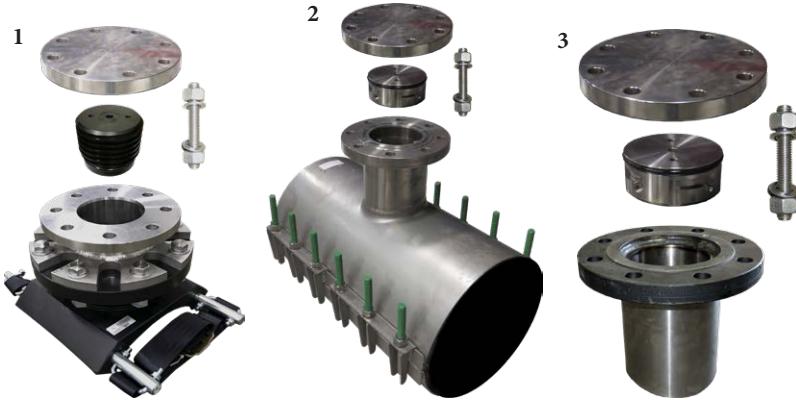

	PART #	DESCRIPTION
1)	90403010 to 90403050	Polyethylene Fitting (size specific)
2)	90502160 to 90502220	Stainless Steel Saddle Fitting (size specific)
3)	12100051	Steel Fitting (10” – 16”)



**Accessories:**

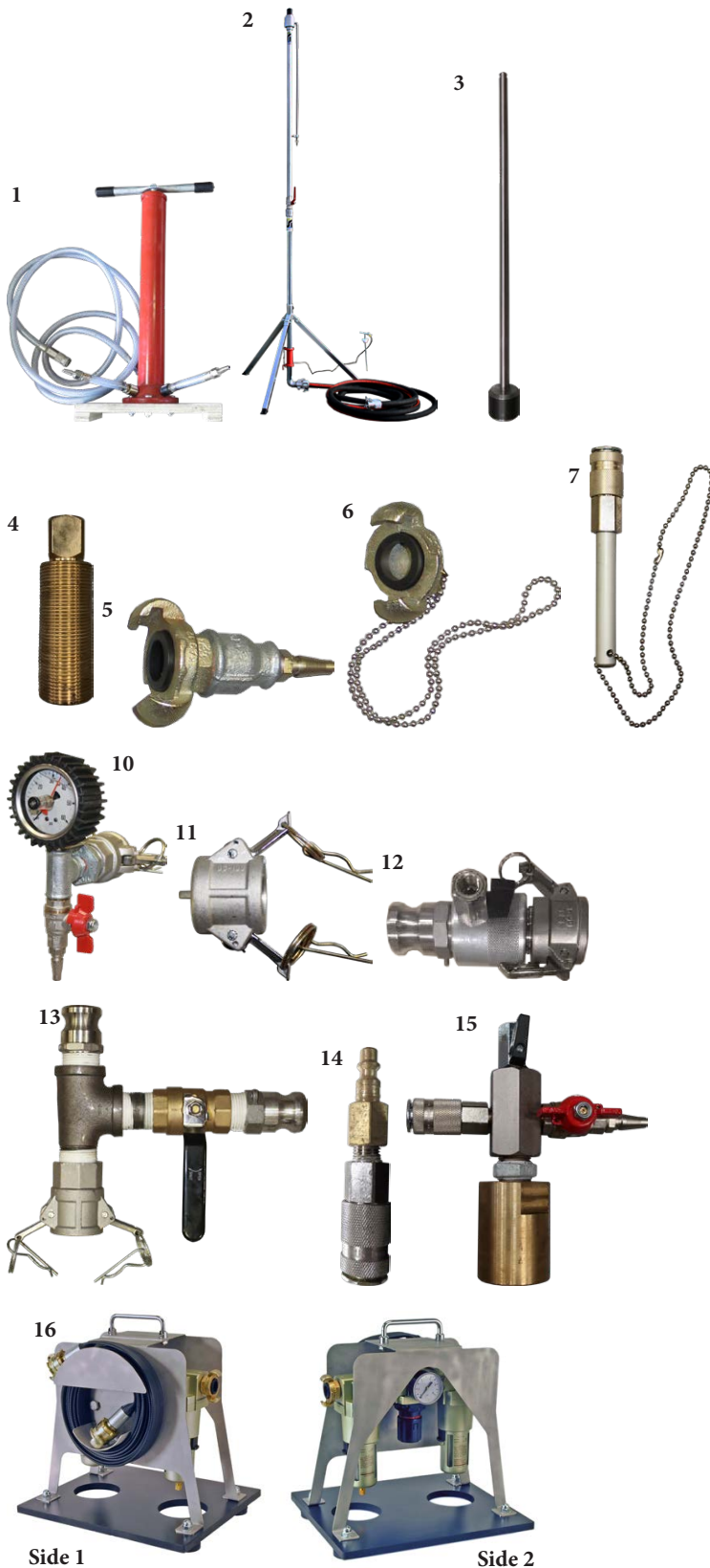

	PART #	DESCRIPTION
1)	22500011	Hand Pump with Hose
2)	59003176	1" Vent Stack with Hose
3)	10800853	Magnetic Spindle
4)	13605135	Coupon Remover (7/8" connection)
5)	12242210	Hand Pump Adapter
6)	99000705	Safety Fitting (gold / claw)
7)	12100740	Safety Fitting (silver)
8)	BPGT-1	By-Pass Gauge Tree
9)	BPC-1	By-Pass Cap
10)	BPVA-1	By-Pass Vent Adapter
11)	BPT-1	By-Pass Tee Assembly
12)	AHA-1	Air Hose Adapter
13)	12242200	MDS Stopper Test Adapter (MCS60-1016)
14)	49101380	Air Motor Oiler / Water Separator Unit (complete)

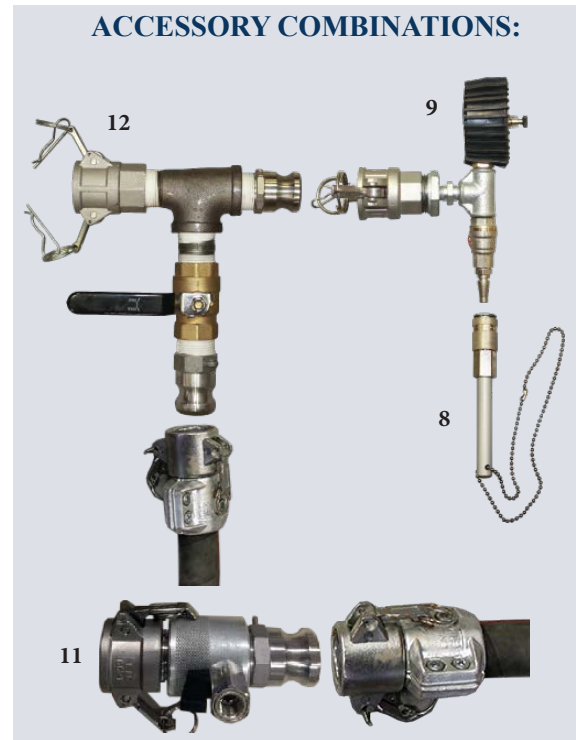

## Sizing Table [Equipment Part #'s]:

POLYETHYLENE PIPE					
Nominal Pipe Size	10"	12"	14"	16"	18"
<b>Fitting</b>	90403010	90403020	90403030	90403040	90403050
<b>Cutter</b>	13100100	13100100	13100100	13100100	13100100
<b>Pilot Drill</b>	13200727	13200727	13200727	13200727	13200727
<b>Chute</b>	12100450 (#1)	12100460 (#2)	12100460 (#2)	12100470 (#3)	12100470 (#3)
<b>MDS Stopper</b> <i>(Pipe ID Range)</i>	23101357 <i>(8.85" - 10.82" / 225 mm - 275 mm)</i>	23101358 <i>(9.84" - 12.40" / 250 mm - 315 mm)</i>	23101358 <i>(9.84" - 12.40" / 250 mm - 315 mm)</i>	23101359 <i>(12.40" - 15.74" / 315 mm - 400 mm)</i>	23101359 <i>(12.40" - 15.74" / 315 mm - 400 mm)</i>

CAST IRON PIPE					
Pipe OD Range	10.71" - 11.61"	12.99" - 13.98"	15.16" - 16.14"	16.54" - 17.32"	17.32" - 18.31"
<b>Fitting</b>	90502160	90502180	90502200	90502210	90502220
<b>Cutter</b>	13200725	13200725	13200725	13200725	13200725
<b>Pilot Drill</b>	14300010	14300010	14300010	14300010	14300010
<b>Chute</b>	12100450 (#1)	12100460 (#2)	12100470 (#3)	12100470 (#3)	12100470 (#3)
<b>MDS Stopper</b> <i>(Pipe ID Range)</i>	23101357 <i>(8.85" - 10.82" / 225 mm - 275 mm)</i>	23101358 <i>(9.84" - 12.40" / 250 mm - 315 mm)</i>	23101359 <i>(12.40" - 15.74" / 315 mm - 400 mm)</i>	23101359 <i>(12.40" - 15.74" / 315 mm - 400 mm)</i>	23101359 <i>(12.40" - 15.74" / 315 mm - 400 mm)</i>

NOTE: Verify actual pipe OD and wall thickness to make certain fitting and stopper dimensions will work.

STEEL PIPE				
Nominal Pipe Size	10"	12"	14"	16"
<b>Fitting</b>	12100051	12100051	12100051	12100051
<b>Cutter</b>	13200725	13200725	13200725	13200725
<b>Pilot Drill</b>	14300010	14300010	14300010	14300010
<b>Chute</b>	12100450 (#1)	12100460 (#2)	12100470 (#3)	12100470 (#3)
<b>MDS Stopper</b> <i>(Pipe ID Range)</i>	23101357 <i>(8.85" - 10.82" / 225 mm - 275 mm)</i>	23101358 <i>(9.84" - 12.40" / 250 mm - 315 mm)</i>	23101359 <i>(12.40" - 15.74" / 315 mm - 400 mm)</i>	23101359 <i>(12.40" - 15.74" / 315 mm - 400 mm)</i>

## 5.0 Preparatory Steps:

<input type="checkbox"/>	Measure accordingly to avoid launching or inflating stopper under existing fittings, joints, or other obstructions.
<input type="checkbox"/>	Select proper MDS Stopper from the sizing table in Section 4.0.
<input type="checkbox"/>	Select proper fitting from the sizing table in Section 4.0.
<input type="checkbox"/>	Attach selected fitting, based on pipe material, per company standards and specifications.
<input type="checkbox"/>	Before welding steel fitting on main, remove the blind flange, gasket, and plug from fitting.
<input type="checkbox"/>	Kleiss Gastool PE fittings use a 4.0 mm fusion pin. Ensure you have the appropriate tips/adapters on your electrofusion processor that will fit the 4.0 mm pins.
<input type="checkbox"/>	When installing PE fittings, as part of the electrofusion process, make certain to allow the fitting to completely cool down for the entire “cooling time” before tapping the main.
<input type="checkbox"/>	Pressure test attached fitting per company standards and specifications.

## 6.0 Tapping Operation:

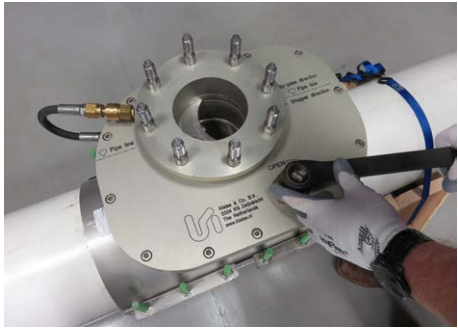
<input type="checkbox"/> Attach slide gate valve, with gasket in place, to fitting outlet using nuts and washers. Check gasket.	
<input type="checkbox"/> Attach pressure equalizing hose to slide gate valve.	
<input type="checkbox"/> Use valve wrench to check if slide gate valve opens and closes.	

❑ Take the tapping device out of the case and inspect the device visually for irregularities. Make sure the threads are clean and the device operates freely.



❑ Begin to assemble the tapping tool by attaching the dome adapter ring to the drilling dome. Tighten the connection by means of the hook assembly wrench.



❑ Thread the tapping device on to the dome adapter ring by means of the hook assembly wrench.

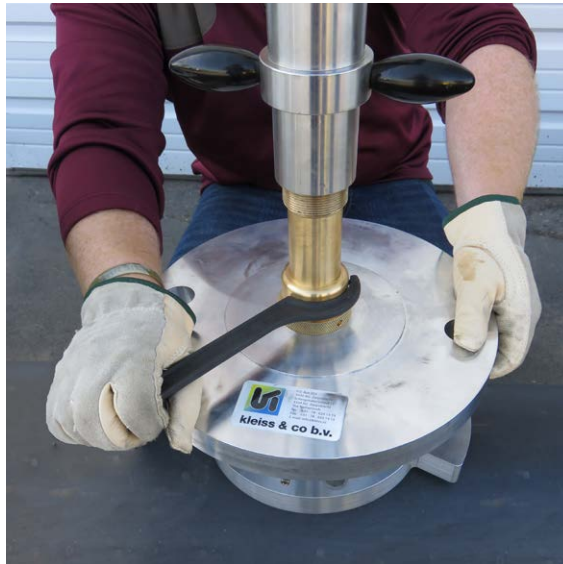

- ❑ Install the drilling rod through the middle of the tapping device and drilling dome.



- ❑ Attach pilot drill to drilling rod then attach proper cutter by means of the cutter assembly bolts.

Figure A:

Steel and cast iron cutter [13200725] and pilot drill [14300010]. Thread the pilot drill into the drilling rod.



Figure B:

PE cutter [13100100] and pilot drill [13200727]. Secure the pilot drill using the set screw on the drilling rod.

**\*\*PE Cutter MUST be greased completely on the inside and on the teeth before cutting\*\***



A:



B:



- ❑ If cutting through steel or cast iron, grease the cutter and pilot drill with the cutting grease for better drilling results.

If cutting through PE or PVC, skip this step.



- ❑ Retract the cutter completely into the drilling dome. No part of the cutter should be visible.

When retracting into the drilling dome, the cutter should be in the position as shown in the picture.

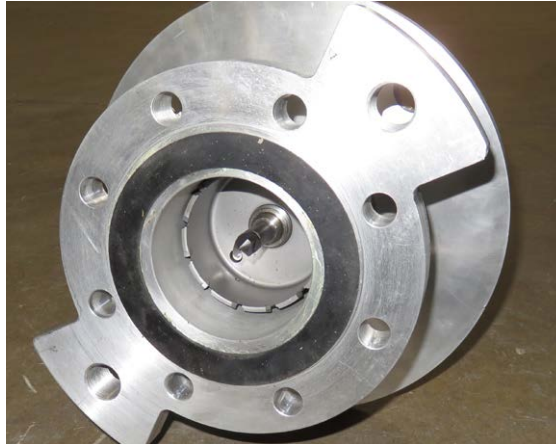

- ❑ Attach complete tapping tool, with gasket in place, to top of slide gate valve using nuts and washers. Check gasket.





☐ Position feed tube so it is flush with the bottom thread.

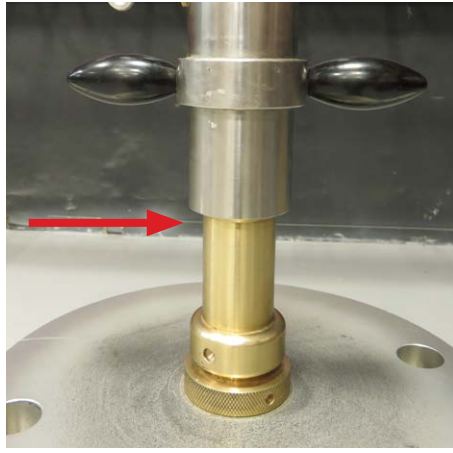

☐ Attach bridge stands (both rods) to top of drilling dome.



☐ Make sure the slide gate valve is open.

☐ Pull out the bayonet lock on tapping device and lower drilling rod until pilot drill touches the surface of the pipeline to be tapped.

When doing this, make sure the bayonet lock is in a free position and does not lock into the drilling rod.



❑ After the pilot drill is in contact with the pipeline, lock the feed tube to the drilling rod at the closest hole on the drilling rod using the bayonet lock. Do this by either rotating the feed tube until it locks in place or pulling up on drilling rod.

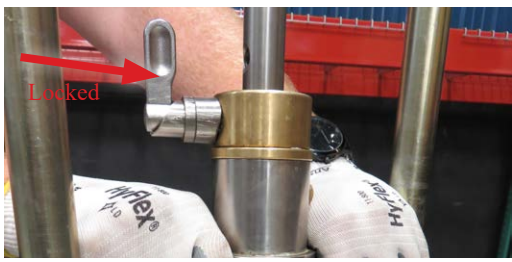

❑ Locate the maximum drilling depth by measuring 2" down from the bottom of the feed tube. Place a mark on the brass tapping tube. (In picture, 1/2" black electrical tape was used.)



❑ Rotate the feed tube counterclockwise until 3 additional threads are exposed. (This ensures the pilot drill is not on the pipe and is in the proper position to start drilling.)



❑ Place air motor on drilling rod square.

Operator should ensure the air compressor is working properly at 90 psi measured at the inlet of the air motor. Air volume through the motor should operate the air motor at 20 RPM's load speed (cut) & 40 RPM's free speed (non-cut).

Make certain the oiler / separator is in place.

NOTE: If issues with air motor occur, tapping can be completed by hand using the ratchet.

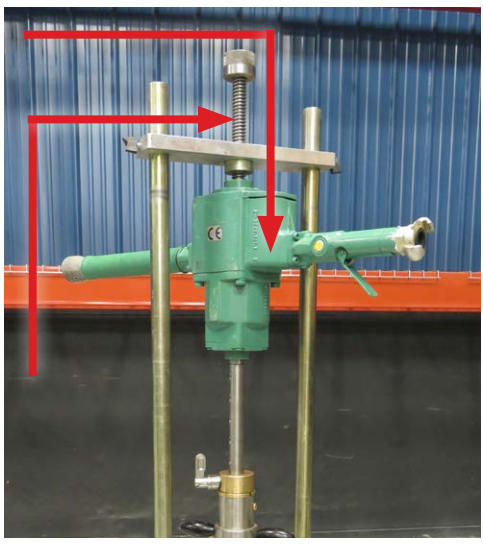

❑ Attach feeding rod with bridge to bridge stands.

Lower feeding rod with bridge down to air motor.

❑ Use the air motor to turn the drilling rod clockwise. **Make certain the drilling direction is set in the down position.**

While the drilling rod is rotating clockwise slowly hand feed the cutter downward by turning the feed tube handles clockwise to cut the pipe.

(Do not feed the cutter too quickly and cause a bind and potential cutter breakage. Especially on steel and cast iron.)

Continue to lower the feeding rod from above with bridge as the air motor lowers to keep the air motor centered and stable.



❑ The tapping procedure is finished when the drilling rod can rotate without any resistance.

NOTE: You will feel less resistance twice - once in the beginning when the pilot drill has perforated the pipe wall and secondly when the cutter is completely through.

❑ To retract cutter and coupon, continue spinning the drilling rod clockwise while rotating the feed tube counterclockwise until you have reached the starting position with 3 threads exposed.

*(NEVER turn the drilling rod counterclockwise. This can damage the cutter.)*

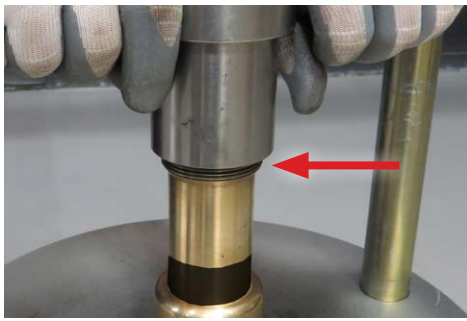

❑ Detach feeding rod with bridge, bridge stands, and air motor or hand ratchet.

❑ **WARNING: Always control the drilling rod.**

Free the drilling rod by unlocking the bayonet lock on the tapping device. Then pull the drilling rod completely upwards above the slide gate valve.

*(If assistance to get the cutter out is needed, turn the drilling rod clockwise.)*

*(NEVER turn the drilling rod counterclockwise. This can damage the cutter.)*

*(Be aware of the fact that the pressure inside the pipeline may automatically move the rod upwards. Avoid being above the rod with your hands or face.)*

**WARNING: Always control the drilling rod.**







❑ Close slide gate valve.



❑ Disconnect valve equalization hose at the lower connection. This releases the pressure above the slide gate valve.

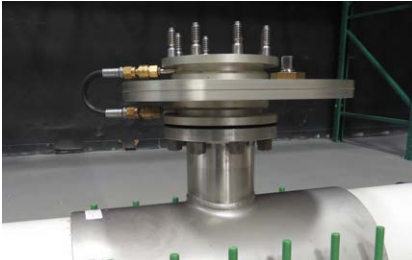



<p>❑ Release pressure from the dome by opening blow down valve.</p>	
<p>❑ Unbolt the drilling dome from the slide gate valve.</p>	
<p>❑ Disassemble the tapping tool.</p> <p>Use the hook wrench to remove tapping device from drilling dome.</p> <p>Remove cutter and pilot drill from drilling rod.</p> <p>The cutter should contain the drilling coupon. Use the necessary tools [Coupon Remover - 13605135] to remove the coupon from the cutter.</p> <p>The coupon MUST be removed immediately after tapping PE. A needle nose pliers can also be used to remove shavings from inside the cutter. Use silicone spray to assist pushing the coupon out.</p>	 
<p>❑ After tapping steel pipe, to remove steel shavings from interior of pipe, use the magnetic spindle in combination with the drilling dome to clean the interior of the pipe. To remove the majority of the shavings, it may take multiple insertions.</p>	 
<p>❑ NOTE: Remember to reconnect the equalization hose to equalize pressure above and below slide gate valve before opening valve. Disconnect equalization hose to blow down tapping dome before removal.</p>	
<p>❑ Clean and store tapping tool in its case.</p>	

## 7.0 Stopping Operation:

- Attach the appropriate gauges on the appropriate couplings at the top of the stopper rod.

Each gauge has a specific function. The gold connection gauge will indicate the pressure inside the pipeline in front of the MDS Stopper. The silver connection gauge indicates the inflation pressure of the inflatable stopper.

system / pipeline pressure

internal / inflation pressure

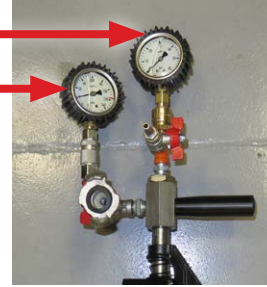

- Verify that the coupling on the bottom of the stopper rod contains a gasket.

The gasket should be in good visual condition. The condition of the gasket can be verified when conducting the vacuum test on the stopper prior to inserting the stopper into the gas system.

NOTE: Extra stopper rod gaskets should always be available.

Never use the stopping tool if the gasket is not inside the coupling.

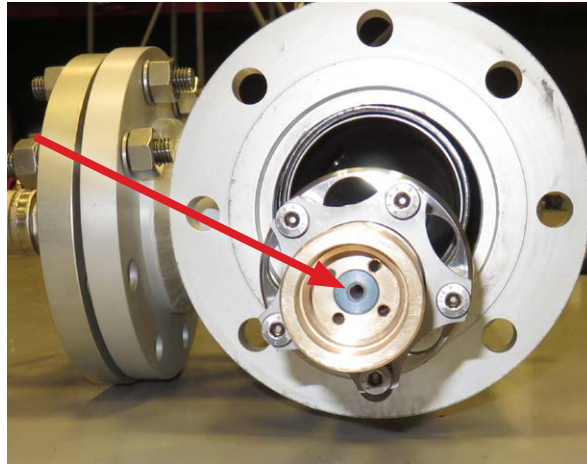

- Take the stopper you selected from the chart in Section 4.0 and visually inspect that the stopper is in good condition without weak spots or concern for integrity.

(If the condition of the stopper is uncertain, refer to Appendix A for additional stopper testing and verification.)

Pre-bend the hose of the MDS Stopper as this will facilitate the positioning of the stopper into the pipeline through the chute.

NEVER pre-bend the MDS Stopper on the frame!!! This can damage the frame and it will not help as the internal frame is rigid.

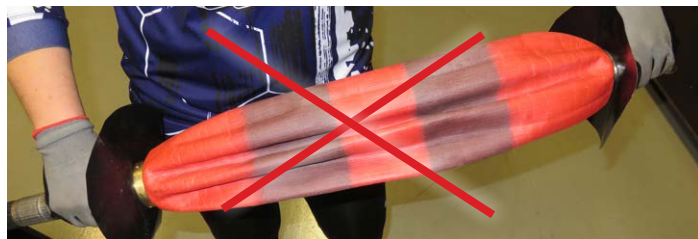



❑ Push the stopper rod downward to expose the connecting end.

Attach the proper size of MDS Stopper onto the stopper rod.

Tighten the connection by means of a pair of wrenches. Always use two wrenches to ensure tight connection and seal.

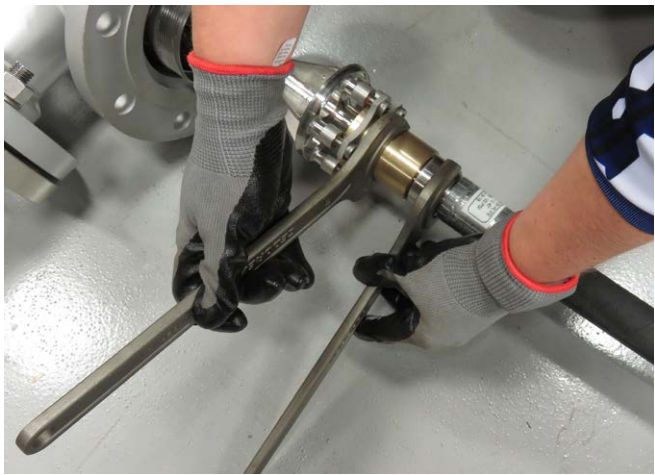

❑ Attach hand pump adapter to inflation pressure port. (This is the offset connection.)



❑ Connect hand pump to hand pump adapter.

❑ With the valve open, pull a vacuum of -15 psi on the stopper to make it as compact as possible.

❑ Close the valve after evacuation.

Tip: Use 2 operators to pull the negative. One operator should pull the negative while the other will assist in hand folding the stopper.



❑ Verify negative pressure is maintained for 5 minutes to ensure seal and integrity of MDS Stopper and complete stopper rod.

This is what a well evacuated MDS Stopper looks like!



❑ **ADDITIONAL STOPPER TESTING BY INFLATION:**  
 If additional stopper testing is desired, insert the stopper into a piece of pipe within the stopper's pipe ID range.

(Make certain the test set up is in a safe place where the open end of the test pipe is pointed away from people.)

Pull a negative of -15 psi on the stopper and maintain for 5 minutes to ensure integrity of the stopper.

Inflate the stopper to the maximum allowable pressure either by using the stopper rod or a MDS Stopper Test Adapter [12242200].

After the stopper stabilizes, wait a minimum of 10 minutes to make certain the same pressure is maintained within the MDS Stopper.

**NOTE: Do not inflate the stopper outside of a pipe as it can damage the stopper.**

*Using rod:*



*Using MDS Stopper Test Adapter:*



❑ For proper MDS Stopper insertion into the pipeline, use Kleiss silicone spray to lubricate the stopper.







❑ Spray the back of the stopper at the conical connection.

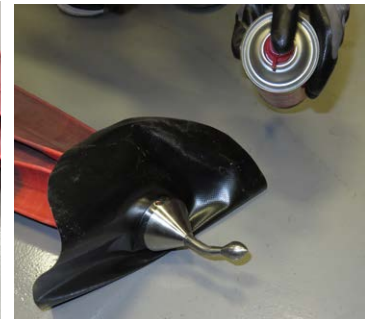

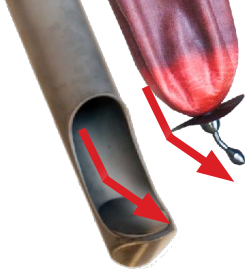
❑ Spray the front of the stopper around the nose.

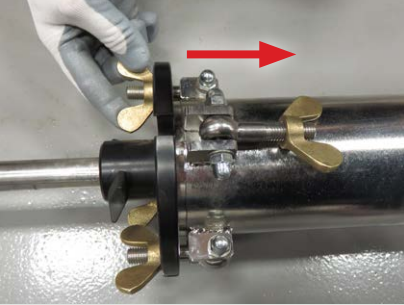

<p>❑ NOTE: For larger stoppers with extended metal tips, make certain the stopper tip is rotated so the rounded curve of the stopper tip will slide along angled part of chute when deployed. The metal tip should be going the same direction as arrow on tower.</p>	
<p>❑ Pull stopper up into tower.</p>	
<p>❑ <b>ALTERNATE STOPPER ATTACHMENT:</b> Stopper may be attached to stopper rod and inserted through the top of the tower instead of being pulled up into the tower like previously noted.</p>	
<p>❑ After selecting the appropriate stopper, begin to take the stopper rod out of the tower by loosening the four wing nuts on the black cap and flipping the bolts off from the black cap as pictured.</p>	
<p>❑ With some force, pull black cap off from tower until stopper rod is completely exposed.</p>	

❑ If assistance is needed, use the stopper rod removal tool to push the black cap up.



❑ With the stopper rod out, follow previous steps to attach the stopper, pull a vacuum, and spray the stopper with silicone spray.

❑ Next, push the stopper into the tower until black cap is flush with the tower.



❑ Flip the bolts to the top of the black cap and tighten wing nuts.

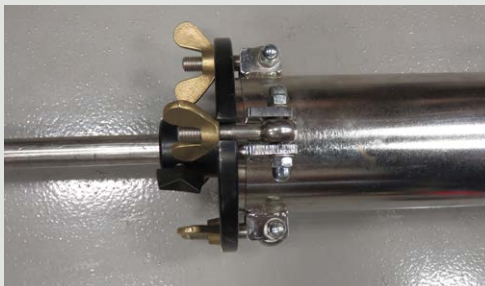

❑ Lock the stopper rod by tightening the black thumb screws onto the rod.

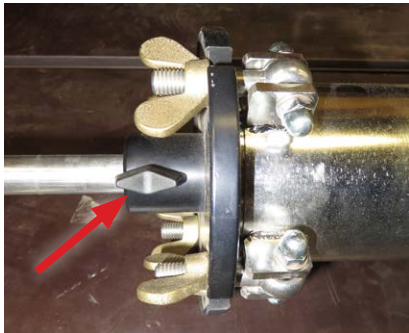

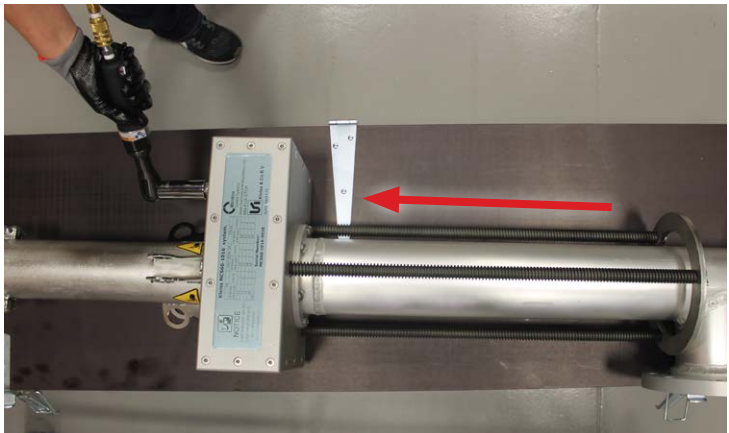

❑ Attach gear box air ratchet to flow stopping tower gear box.



❑ Using the gear box air ratchet, drive the threaded rods down through the gear box. This allows the chute attachment component to be visible at bottom of flow stopping tower.

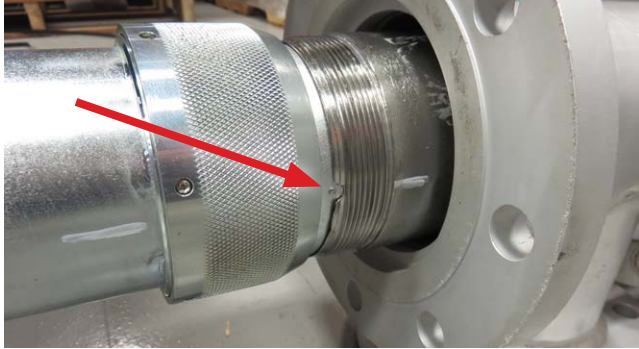

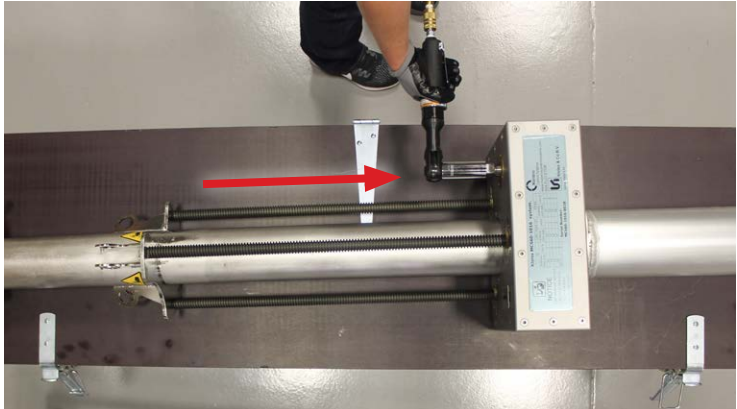
<p>❑ Select proper chute from the sizing table in Section 4.0.</p>	
<p>❑ Unthread protective end from the bottom of the tower.</p>	
<p>❑ Connect the chute into the bottom of the stopping tower.  (There is only one way to connect the chute properly and that is to match the pin and the indent in the tower.)</p>	
<p>❑ Using the same Kleiss silicone spray you used on the stopper, lightly spray the open end of the chute.</p>	
<p>❑ Using the gear box air ratchet, drive the threaded rods up through the gear box to completely retract the chute into the tower.</p>	
<p>❑ Grease stopper rod with Kleiss silicone grease.</p>	

❑ With gasket in place, set complete flow stopping tool on top of slide gate valve positioning stopper tower in correct orientation to deploy stopper.

(Use the arrow indicator on tool to verify direction of stopper insertion.)

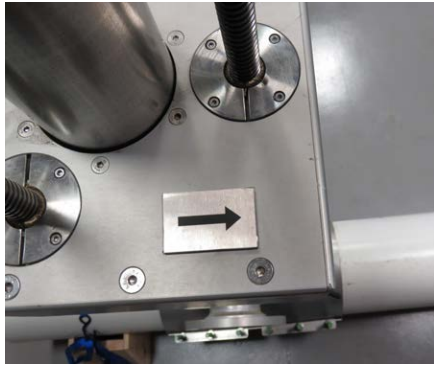

❑ Attach flow stopping tool to top of slide gate valve using nuts and washers.

Check gasket.

❑ Attach by-pass / vent port, with gasket in place, to the side of the flow stopping tool using stud bolts. Make certain port is closed. Check gasket.



❑ Open slide gate valve and check for any leaks in the stopping tower. Use leak soap if necessary.

Correct any blow-by or leaks before continuing stopping operation.

❑ Make sure equalization hose is connected to the slide gate valve to equalize pressure above and below the slide gate valve.





- ❑ Using the gear box air ratchet, drive the threaded rods down through the gear box until 3 threads are showing above the gear box. This positions the chute into the main.



- ❑ Unlock the stopper rod by loosening the black thumb screws.



- ❑ Push the stopper rod downwards. You may need to use a little force to do so. **Try NOT to rotate the stopper rod when inserting.**

Stop pushing the stopper rod downwards when the depth indicator mark is at the black cap.

Depth Indicators:

Use top line for 12” to 18” pipe

Use bottom line for 10” pipe





- ❑ Lock the stopper rod by tightening the black thumb screws.



- ❑ *Recommended:* If needed or applicable, attach By-Pass Gauge Tree [BPGT-1] to by-pass / vent port.

NOTE: Additional options are available in the 4.0 Accessories section.



<p><input type="checkbox"/> Prior to stopper inflation, verify system / pipeline pressure is displaying on proper gauge (not more than 60 psi).</p> <p>The MDS Stopper inflation pressure gauge will be indicating a negative pressure.</p>	
<p><input type="checkbox"/> Inflate the stopper to 120 psi via air compressor or nitrogen source. Inflate stopper as rapidly as possible to ensure the best seal on pipeline wall.</p> <p>NOTE: If 120 psi is not obtainable, then inflate to a minimum of 2 times system pressure to achieve stop off.</p>	
<p><input type="checkbox"/> Install safety fitting on inflation pressure port.</p>	
<p><input type="checkbox"/> Allow the stopper to stabilize inside the pipeline for at least 10 minutes.</p>	
<p><input type="checkbox"/> Evacuate or purge pipeline work area. Use the bypass / vent port on tower and vent stack, if desired. (Do this in accordance with your gas company procedures.)</p>	
<p><input type="checkbox"/> Verify inflation pressure and system pressure remains stable.</p>	
<p><input type="checkbox"/> You may now start your work on the pipeline.</p> <p>NOTE: Continue to monitor gauges on stopping towers.</p>	

## 8.0 Retrieving MDS Stopper:

- ❑ **NOTE: Always equalize pressure on both sides of the stopper before deflation or removal.**

After the work on the pipeline is complete, equalize the pressure behind the MDS Stopper and in front of the MDS Stopper.

This can be done in a variety of ways. Refer to examples in Section 3.0 of this manual and your gas company procedures.

**\* ALWAYS EQUALIZE PRESSURE \***

- ❑ Remove safety fitting from inflation pressure port.



- ❑ Attach hand pump adapter to inflation pressure port.



- ❑ Once pressure is equalized, open the inflation valve of the MDS Stopper to deflate the stopper. Pressure inside the pipeline will assist with the evacuation.

- ❑ Connect the hand pump to the hand pump adapter and pull a vacuum on the stopper to make it as compact as possible.



- ❑ Unlock the stopper rod by loosening the black thumb screws.



- ❑ Pull the stopper rod completely upwards. You may need to use some force to do this.

Hint: If you feel some resistance, use the jack assist until the pressure has lessened, then continue to pull up by hand.





❑ JACK ASSIST INSTRUCTIONS:

Slide the jack assist down the stopper rod to the top of the tower.

Do this by placing the jacking handle in the retraction divot (as shown) and lifting up to compress the spring. Then push the jack assist to slide it along the stopper rod.

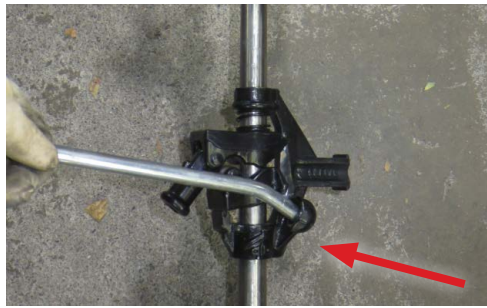





Once on top of the tower, insert the jacking handle as shown and begin jacking until the pressure has lessened, then continue to pull up by hand.





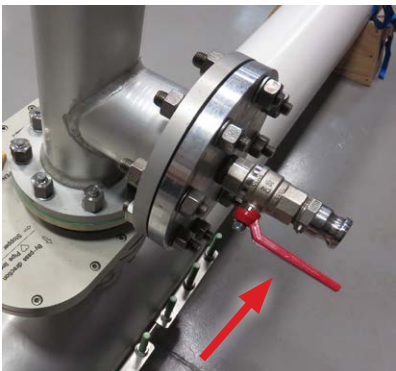

❑ Lock the stopper rod by tightening the black thumb screws.

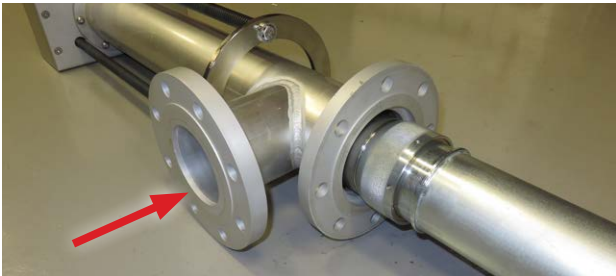
❑ Using the gear box air ratchet, drive the threaded rods up through the gear box to completely retract the chute into the tower.



<p>❑ Close slide gate valve.</p>	
<p>❑ Disconnect equalization hose from bottom connection on slide gate valve.</p>	
<p>❑ Open the by-pass / vent port in order to evacuate the stopping tool.</p>	
<p>❑ Disconnect flow stopping tool from the slide gate valve.</p>	
<p>❑ Remove by-pass / vent port.</p>	

<p>❑ Remove the chute from the stopping tool. (Crank gear assembly to the lowest position to expose the chute.)</p>	
<p>❑ Reattach protective end on bottom of tower.</p>	
<p>❑ Slide the jack assist to the highest most position on the stopper rod.</p>	
<p>❑ Disconnect the MDS Stopper from the stopping tool. (Push stopper rod to lowest position to expose the stopper connection.)</p>	

<p><input type="checkbox"/> Clean and store MDS Stopper in transportation case. Do not leave it on the ground.</p> <p>Inspect the stopper for damages.</p> <p>Clean the stopper with a cloth.</p> <p>Place a protection cap over the thread.</p>	
<p><input type="checkbox"/> Remove gauges.</p>	
<p><input type="checkbox"/> Clean and store stopping tool in its cases.</p>	



## 9.0 Plugging Operation:

- Bolt completion plug to plug spindle rod.  
(Steel and stainless steel fittings are the locking plug style. PE fittings are a threaded plug style.)



- Then insert plug spindle rod through drilling dome, and attach completion tool adapter to top of dome.

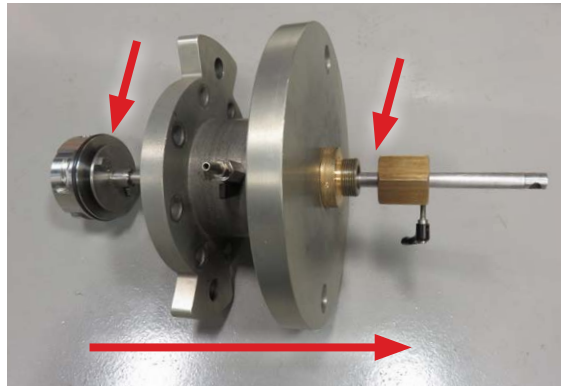

- Pull plug up in to drilling dome.

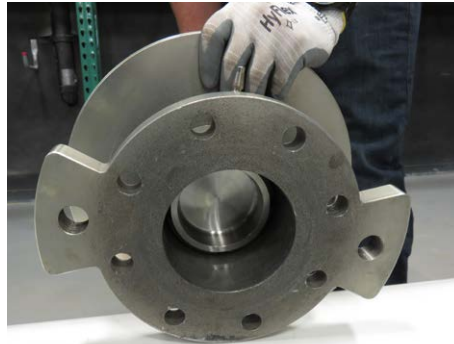

- With gasket in place, attach drilling dome using nuts and washers. Check gasket.



- Attach handle.





❑ Reconnect equalization hose to equalize pressure above and below slide gate valve.



❑ Open slide gate valve.



❑ For locking plug:  
Push down plug spindle assembly until it reaches the top mark.  
  
Turn plug spindle assembly clockwise 1/4 turn.  
  
Pull up on the plug so bottom mark is showing to make sure plug is set.



❑ For threaded plug:  
Push down plug spindle assembly through valve and onto fitting.  
  
Turn clockwise to thread plug onto fitting.  
  
Continue until it bottoms out.



❑ Test to make sure there is seal by opening the blow down valve on the dome and relieving the pressure in the dome.



❑ Remove handle.





❑ After the plug seal has been verified, unbolt the drilling dome and remove the dome up and over the completion tool.



❑ Unbolt the slide gate valve and remove the valve up and over the completion tool.



<ul style="list-style-type: none"> <li>❑ Remove plugging assembly by unbolting the assembly from the plug.</li> </ul>	
<ul style="list-style-type: none"> <li>❑ Prior to bolting on the blind flange, inspect the plug again for any leaks.</li> </ul>	
<ul style="list-style-type: none"> <li>❑ Attach the blind flange, with gasket in place, to fitting using stud bolts. Check gasket.</li> </ul>	
<ul style="list-style-type: none"> <li>❑ Disassemble the plugging tool.</li> </ul>	
<ul style="list-style-type: none"> <li>❑ Clean and store the completion tool and valve in their respective cases.</li> </ul>	

## 10.0 General Maintenance:

**All equipment should be cleaned and inspected for wear after each job to prolong the life of the equipment and ensure the safety of the operators.**

<input type="checkbox"/>	Inventory all system components (refer to Section 4.0 Equipment)
<input type="checkbox"/>	Visually inspect the cutters and pilot drills
<input type="checkbox"/>	PE cutter - no missing or chipped teeth (13100100)
<input type="checkbox"/>	PE pilot drill - looks to be in good condition (13200727)
<input type="checkbox"/>	Steel and cast iron cutter - looks to be in good condition (13200725)
<input type="checkbox"/>	Steel and cast iron pilot drill - looks to be in good condition (14300010)
<input type="checkbox"/>	NOTE: The best indication of the condition of the cutter and pilot drill is the coupon removed from the pipe. Smooth cuts indicate good condition and jagged / rough cuts indicate wear of the cutter and pilot drill.
<input type="checkbox"/>	Grease the tapping device, if needed (10310800)
<input type="checkbox"/>	Inspect gauges for any damage and ensure they are reading zero and function properly
<input type="checkbox"/>	Inspect stopper rod for bends and/or damage
<input type="checkbox"/>	Check to make sure the gear box is operating freely with no binding or grinding
<input type="checkbox"/>	Clean ALL threads and quick connections
<input type="checkbox"/>	Inspect and clean all chutes (quantity 3)
<input type="checkbox"/>	Inspect to make sure slide gate valve is opening and closing smoothly and functioning properly
<input type="checkbox"/>	Inspect all bolts, screws, and joints
<input type="checkbox"/>	Inspect MDS Stoppers for any excessive wear and replace if necessary (refer to Appendix A)
<input type="checkbox"/>	Make sure protective cap is on the stopper to protect the threads
<input type="checkbox"/>	Thoroughly clean off any dirt, debris, and grease on all tools and stoppers with a lint free cloth and water (well-maintained equipment extends the life)

**NOTE: MCS recommends that the complete set of tools be inspected, serviced, and tested by an authorized MCS service center on a two year rotation or sooner.**

## APPENDIX A: Stopper Testing and Verification

- Visually inspect the stopper for weak spots and integrity.  
Discard stopper if weak spots are found.  
Continue with inspection if everything looks OK.

*OK Examples:*  
Coating is coming off, but individual threads are not showing.



*Bad Examples:*

Discard stoppers shown below since individual threads are exposed, starting to fray, and loose from coating.

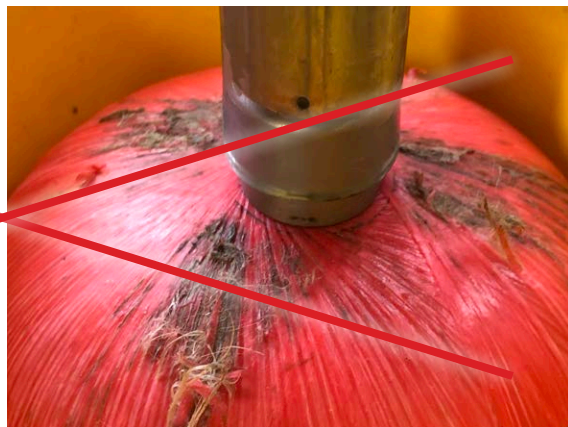
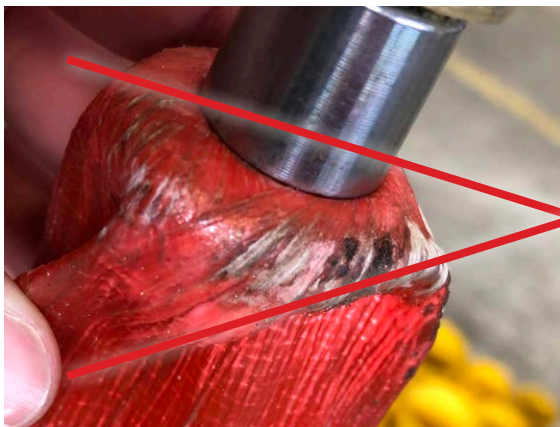



- ❑ Verify internal spring mechanism is still working.



- ❑ Pull a vacuum (negative pressure) on the stopper.

This can be done on the complete stopper rod of the tower (to ensure complete system is intact before a job) or using the MDS Stopper Test Adapter [12242200].

Verify fiber gasket in either device is intact.

Verify negative pressure is maintained for 5 minutes.

*Using rod:*



*Using MDS Stopper Test Adapter:*



- ❑ If the condition of the stopper is still uncertain or additional stopper testing is desired, insert the stopper into a piece of pipe within the stopper's pipe ID range.

(Make certain the test set up is in a safe place where the open end of the test pipe is pointed away from people.)

Inflate the stopper to the maximum allowable pressure either by using the stopper rod or a MDS Stopper Test Adapter as noted in the previous step.

After the stopper stabilizes, wait a minimum of 10 minutes to make certain the same pressure is maintained within the MDS Stopper.

**NOTE: Do not inflate the stopper outside of a pipe as it can damage the stopper.**

*Using rod:*



*Using MDS Stopper Test Adapter:*



## APPENDIX B: Tower Positioning and Distances

### Example I – Stoppers Positioned Towards Each Other [Illustration of One Side of Work Area]

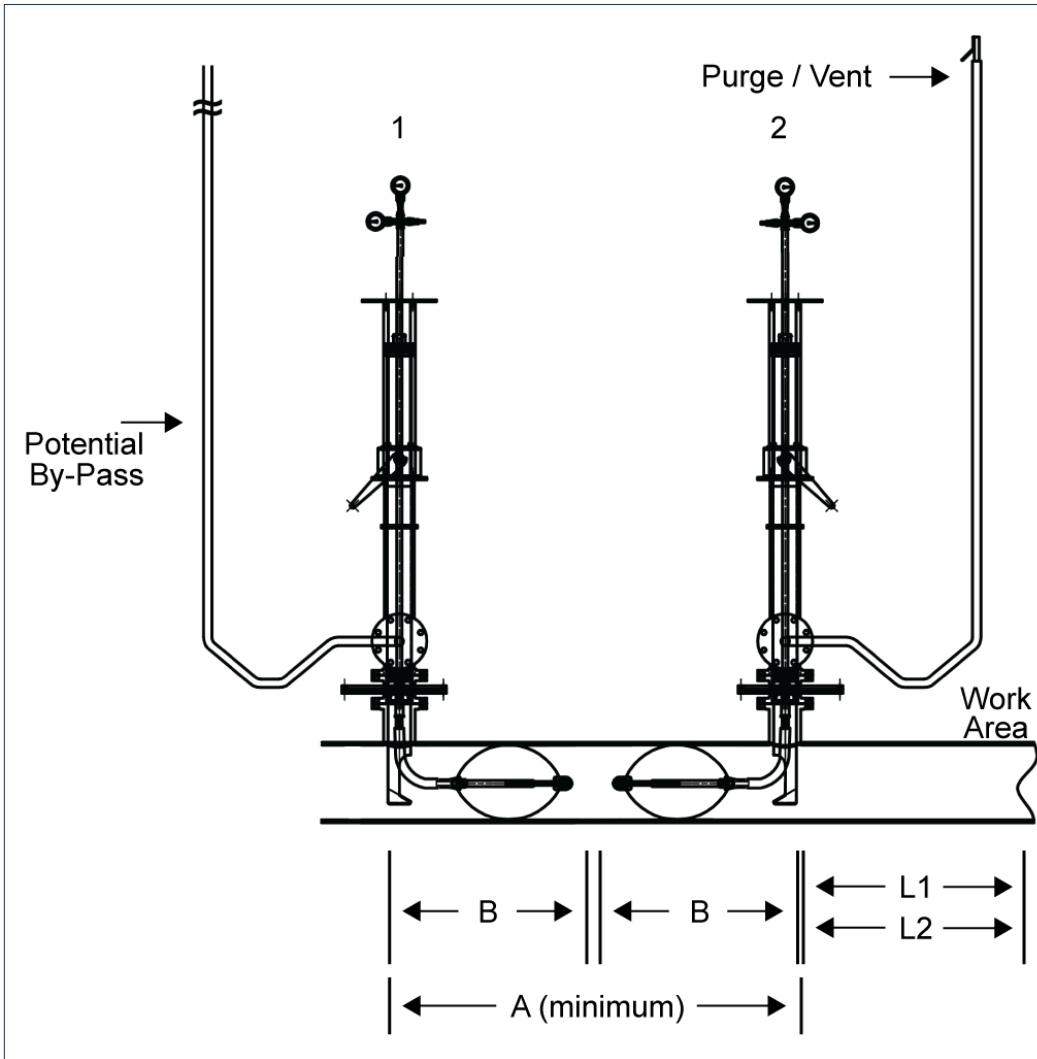

#### STOPPING TOWER DISTANCES

Nominal Pipe Size	A (minimum)	B	L1* = Steel Welding	L2** = PE, CI, and Mechanical
10"	88"	44"	40"	30"
12"	106"	53"	40"	36"
14"	106"	53"	40"	42"
16"	114"	57"	40"	48"
18"	114"	57"	N/A	54"

*A = minimum distance between towers*

*B = stopper length*

*L1\* = distance from stopper/tower to work area - use standard industry & company practices to minimize heat transfer & sparks reaching the inflatable stopper*

*L2\*\* = distance from stopper/tower to work area - measurement is a guide only, follow manufacturer's fitting recommendations*

NOTE: Always inflate stopper #2 first, if possible.

**Example II – Both Stoppers Positioned Away From Work Area  
[Illustration of One Side of Work Area]**

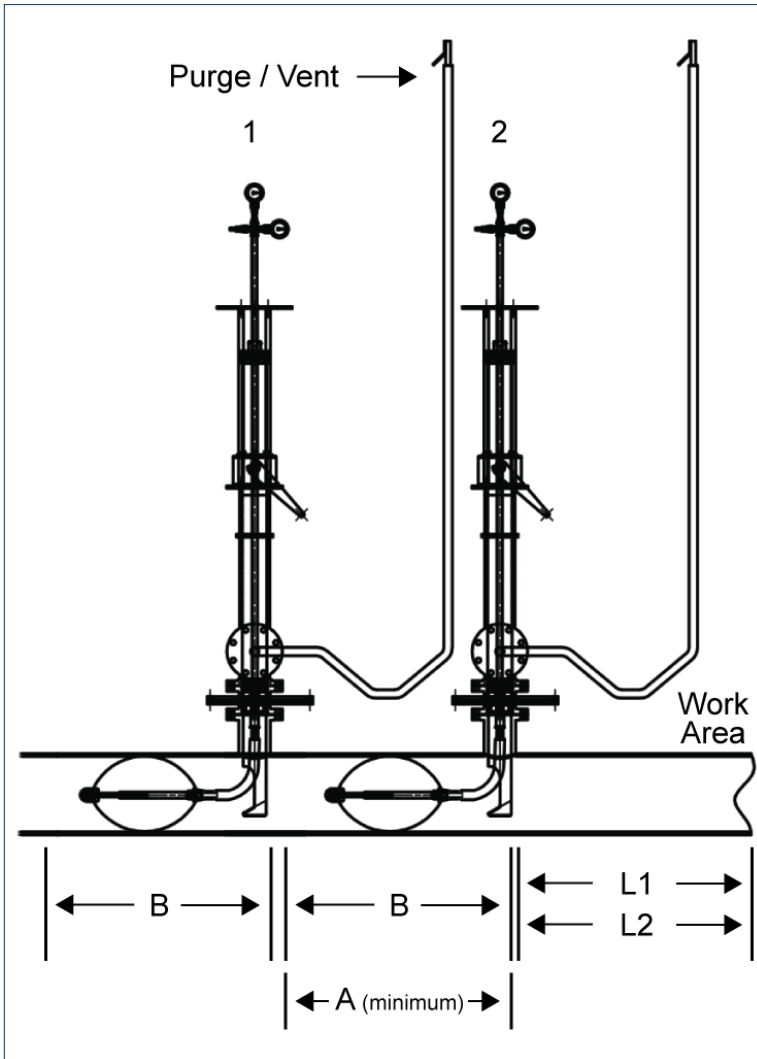

**STOPPING TOWER DISTANCES**

Nominal Pipe Size	A (minimum)	B	L1* = Steel Welding	L2** = PE, CI, and Mechanical
10"	44"	44"	40"	30"
12"	53"	53"	40"	36"
14"	53"	53"	40"	42"
16"	57"	57"	40"	48"
18"	57"	57"	N/A	54"

*A = minimum distance between towers*

*B = stopper length*

*L1\* = distance from stopper/tower to work area - use standard industry & company practices to minimize heat transfer & sparks reaching the inflatable stopper*

*L2\*\* = distance from stopper/tower to work area - measurement is a guide only, follow manufacturer's fitting recommendations*

**Example III – Stoppers Positioned Away From Each Other**  
**[Illustration of One Side of Work Area]**

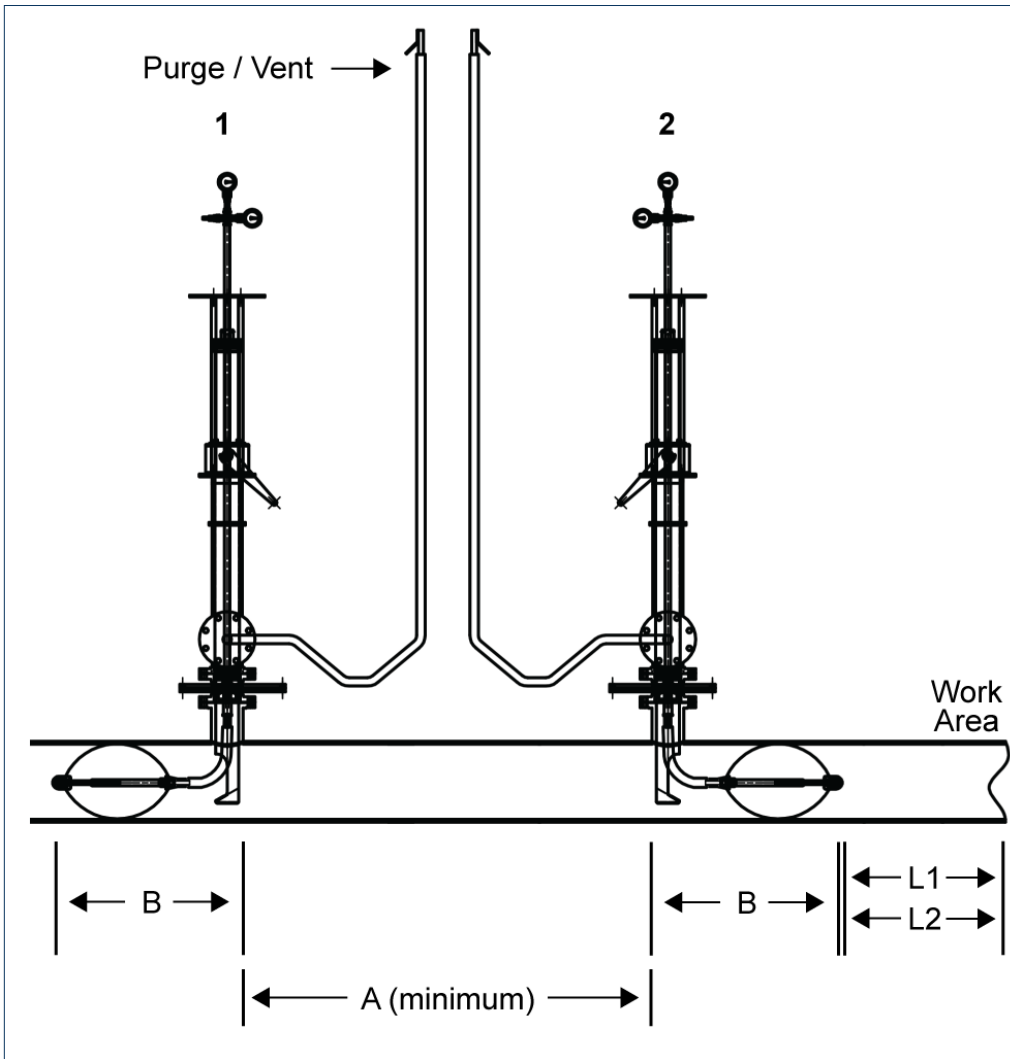

**STOPPING TOWER DISTANCES**

Nominal Pipe Size	A (minimum)	B	L1* = Steel Welding	L2** = PE, CI, and Mechanical
10"	24"	44"	40"	30"
12"	24"	53"	40"	36"
14"	24"	53"	40"	42"
16"	24"	57"	40"	48"
18"	24"	57"	N/A	54"

*A = minimum distance between towers*

*B = stopper length*

*L1\* = distance from stopper/tower to work area - use standard industry & company practices to minimize heat transfer & sparks reaching the inflatable stopper*

*L2\*\* = distance from stopper/tower to work area - measurement is a guide only, follow manufacturer's fitting recommendations*

**Example IV – Both Stoppers Positioned Towards Work Area  
[Illustration of One Side of Work Area]**

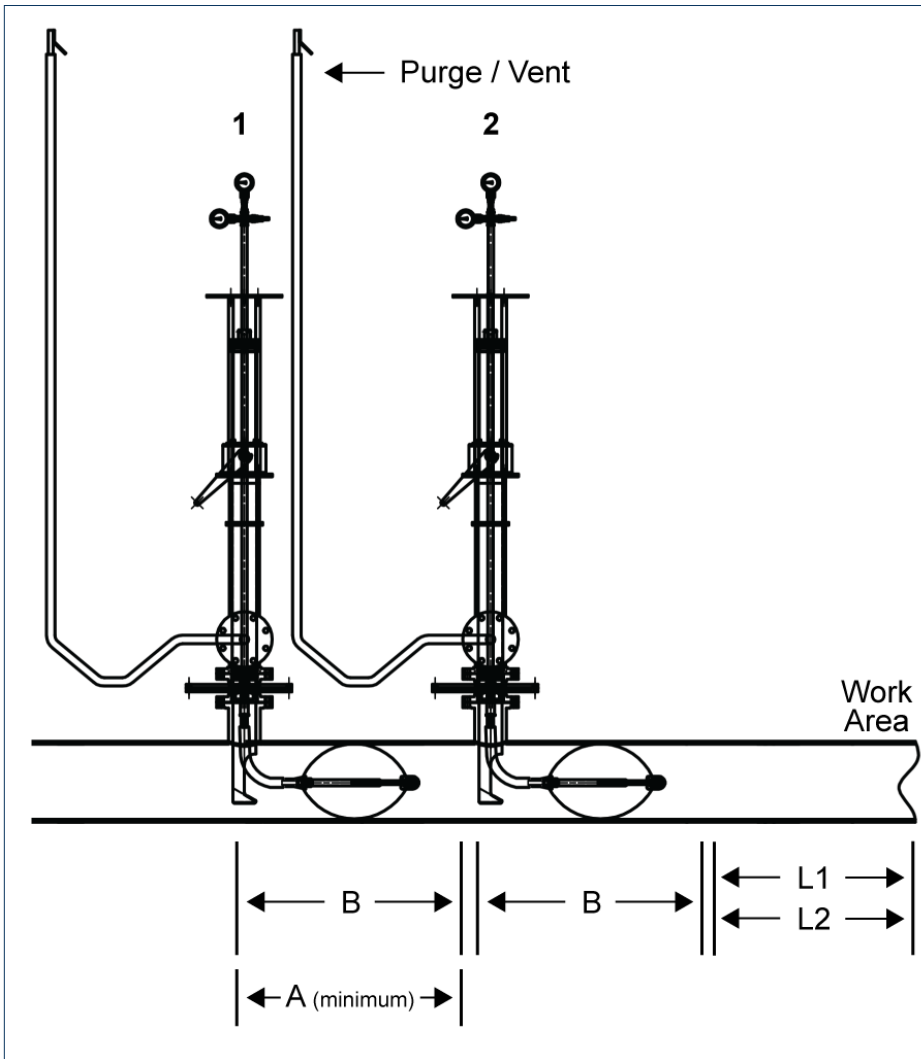

**STOPPING TOWER DISTANCES**

Nominal Pipe Size	A (minimum)	B	L1* = Steel Welding	L2** = PE, CI, and Mechanical
10"	44"	44"	40"	30"
12"	53"	53"	40"	36"
14"	53"	53"	40"	42"
16"	57"	57"	40"	48"
18"	57"	57"	N/A	54"

*A = minimum distance between towers*

*B = stopper length*

*L1\* = distance from stopper/tower to work area - use standard industry & company practices to minimize heat transfer & sparks reaching the inflatable stopper*

*L2\*\* = distance from stopper/tower to work area - measurement is a guide only, follow manufacturer's fitting recommendations*



## APPENDIX C: Manual Updates

### *V15 June 2020*

- 1) Added new pilot drill (14300054) and adapter (10310785) as new standard pilot drill
- 2) Added additional pilot drills to accessories page (13200726, 14300053) adapter (10310785)
- 3) Edited cast iron pipe sizing/equipment table (Section 4.0) from nominal pipe size to OD range
- 4) Updated part numbers for chutes with more robust swifels
- 5) Updated steel welding distance (L1\*) in table in Section 3.0 and Appendix B
- 6) Tapping operation
  - a) Added step to rotate drilling rod clockwise to assist in retracting cutter
  - b) Added steps for connection and disconnection of equalization hose on slide gate valve
- 7) Stopping tower operation
  - a) Added new step of greasing stopper rod
  - b) Added steps for connection and disconnection of equalization hose on slide gate valve
- 8) Added air motor guidelines

### *V16 January 2021*

- 1) Added By-Pass vent port part number (12242112)
- 2) Added version and date to every page of the manual

### *V17 January 2024*

- 1) Updated pilot drill part number throughout manual
- 2) Added to Section 3.0 and Section 5.0 - avoid launching or inflating stopper near fittings, joints, or other obstructions
- 3) Updated part numbers in Section 4.0
- 4) Removed legacy accessories from Section 4.0
- 5) Added notes to PE cutter prep in Section 6.0
- 6) Added note to PE coupon removal in Section 6.0
- 7) Added tip for pulling a negative in Section 7.0
- 8) Removed note not to spray stopper body in Section 7.0

