



SIT ProFlame I (GTMF) System
Intermittent Pilot Ignition System
System Overview & Troubleshooting Guide

Contents

IPI System Overview	Pg 2
Proflame I Components	Pg 3 - 6
Remote Control Function	Pg 7 - 9

Troubleshooting

DFC Lock Outs and Reset	Pg 10
Remote Not Learning	Pg 11
Specific Issues	Pg 12 - 14
Multimeter Images	Pg 15 - 18
Wiring Diagram	Pg 19-20

In order to troubleshoot any product it is important to understand the basic operation and functions of that product. The following information will assist you through this process.

Kozy Heat welcomes your questions while you are at the job site. 800-253-4904

This guide is ONLY intended for professional or trained technicians.

System Overview:

The primary components that are included in the SIT Proflame I GTMFS System



Gas Valve

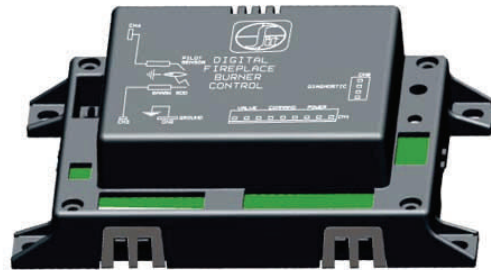

Digital Fireplace Burner Control Board (DFC)



Receiver Box



Fan Control Module (FCM)

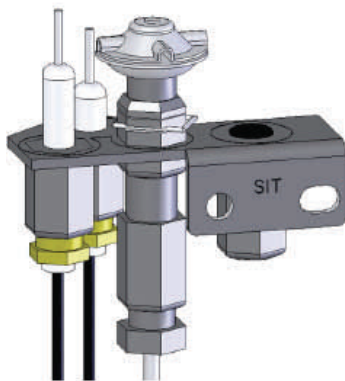

SIT Pilot Assembly



Transmitter (remote control) (GTMF model)

SIT Proflame GTMF Gas Valve

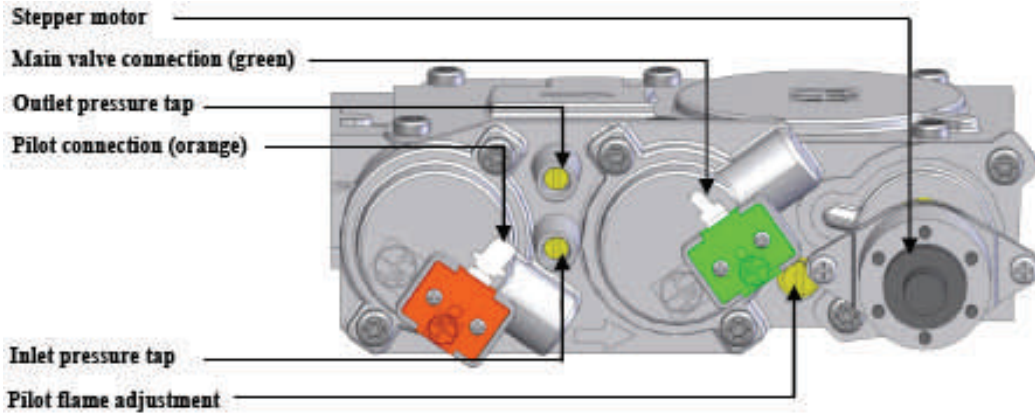

Solenoids on Valve:

EV1 (Pilot Connection Coil):

- Opens and closes to release gas to the pilot
- Orange in color furthest from step motor
- 5VDC and drops to 1.0VDC (test image shown on pg 16)

EV2 (Main Burner Coil):

- Opens and closes to release gas to the burner (needs rectification at pilot before voltage)
- Green in color closest to step motor
- 5VDC and drops to 1.0VDC (test image shown on pg 16)

Gas Pressure: **Very Important for the Function of an IPI Pilot Assembly**

Inlet Pressure Test Point

- Measures amount of gas coming into the valve
- NG 5.0" WC to 7.0" WC
- LP 11.0"WC to 13" WC
- Critical to check this with all gas appliances on in house (Full Load Check)

Outlet Pressure Test Point

- Measures amount of gas leaving the valve to burner orifices
- Need to have EV2 energized or burner turned on to verify

Pilot Adjustment Screw:

- Do not adjust as this is factory set by the valve manufacturer.

Digital Fireplace Burner Control (DFC Module)

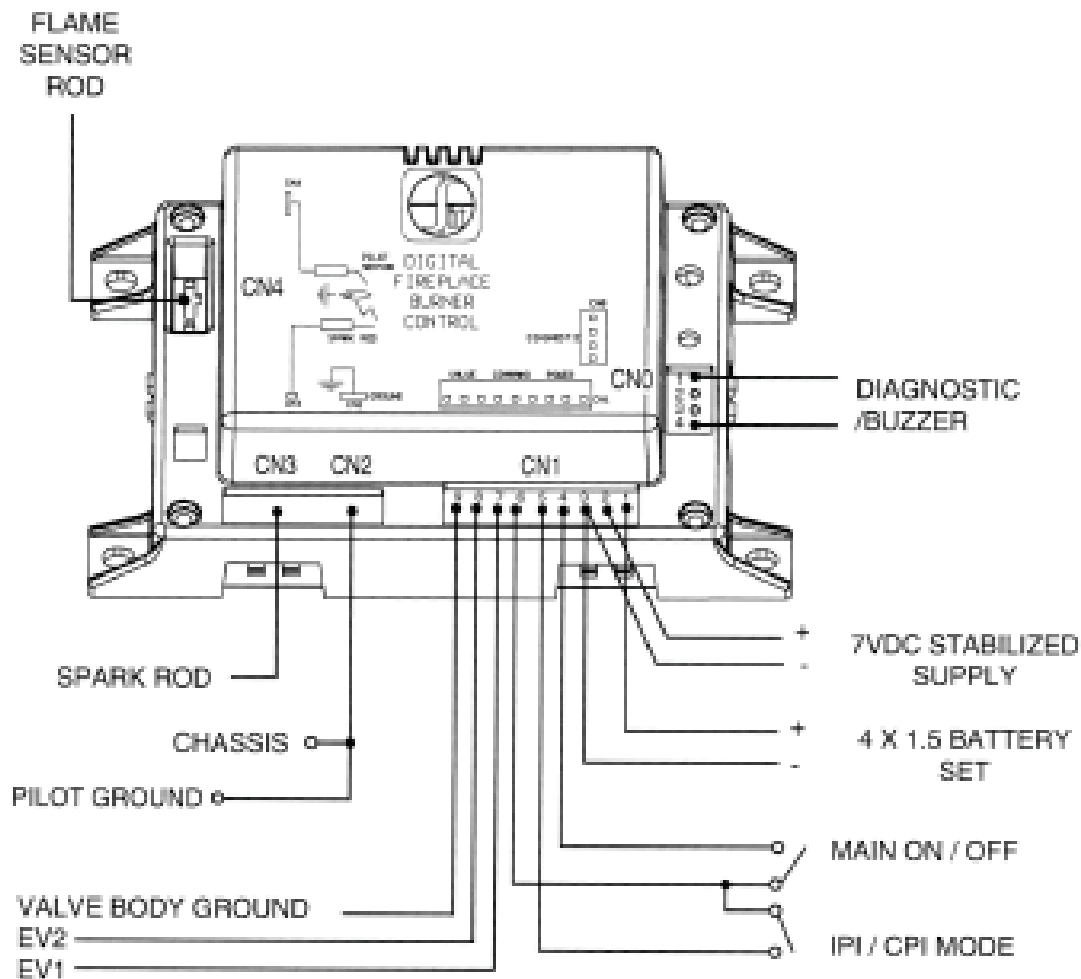

The DFC module:

- Acts as the “brain” of the IPI system sending commands to specific areas
- Powered by 120VAC through the Fan Control Module (FCM) via specific wiring harness using the receiver batteries for back up.

Testing Power Voltage:

- AC Power (Pins red and black) would be about 6.5VAC (See test images on pg 15)

Diagnostic/Buzzer:

- This connection is used for an LED Indicator Light, which provides the technician with lockout codes.
- The LED is not on all models, but if you carry a spare it could be plugged in for a reading.
- For more information on LED Indicator Light and Lockout codes see page 10.

Fan Control Module (FCM)



The Fan Control Module offers the added ability to control the fan speed from off through six speeds, a remotely actuated 120V outlet (lights), and a constantly powered 120V outlet.

Note: The 120V OUT outlet is not to be used or plug any tools into as the amperage of that tool could blow the fuse in the module.

The FCM provides DC power (communication bus shown above) to the receiver allowing the batteries to be used only in the event of line power loss. If equipped: Fans and lights would not function on battery back-up.

Receiver

Function is to act as control box when using remote or manually running the fireplace.

The receiver slider switch can operate in three positions.

3 Position Slider

- On (Manual Override)
- Remote (Remote Control)
- Off



- Shown with cover plate. PRG in upper left, need paperclip to press in.



- Shown with cover plate off. Back-up battery bay is located across bottom

The receiver holds four AA type batteries for battery backup. When receiver batteries are low, no “beep” will be emitted from receiver when it receives on/off command from transmitter. This is an alert to change batteries in receiver box.

Pilot Assembly

Pilot Assembly is comprised of three parts

- Pilot Hood
 - Splits the flame into two for burner and flame sensor.
- Igniter
 - provides spark to the pilot hood
- Flame Sensor
 - Rectifies the pilot is lit and carries the voltage to the DFC module to stop sparking and allow main burner to open.
 - Without rectification igniter will still spark and burner will not turn on.

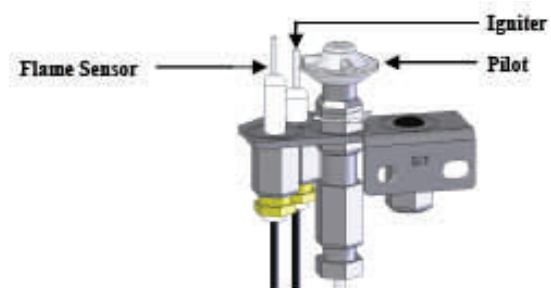

Remote Control

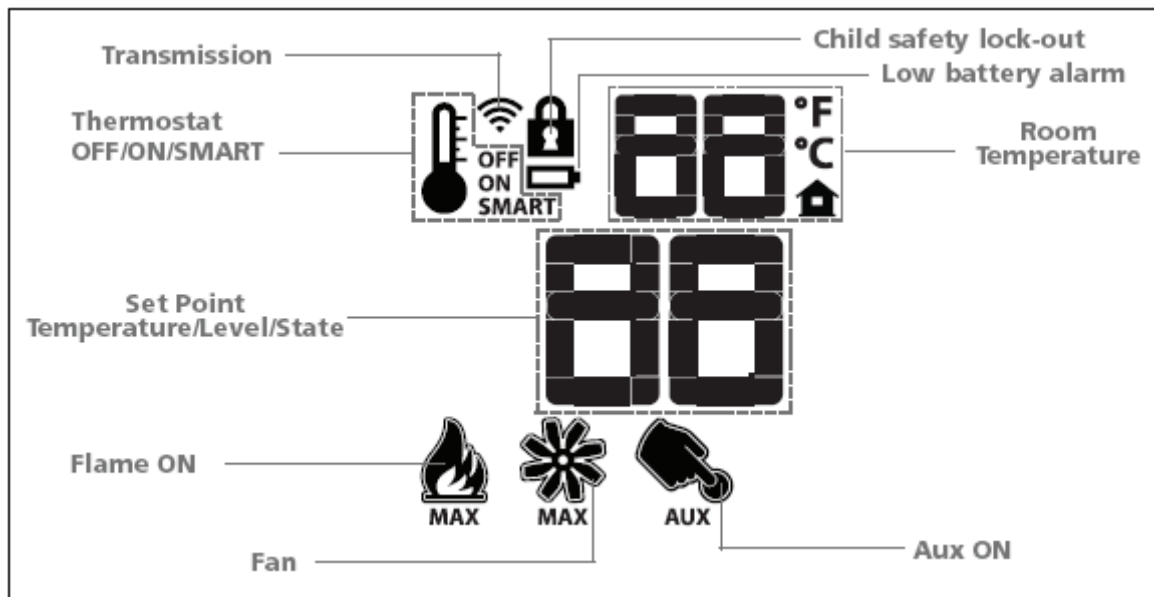

The Proflame transmitter uses radio frequency to communicate information to the receiver box located in the fireplace.

The transmitter is powered by three (3) AAA batteries. As these batteries begin to wear down the blue backlight feature on the remote will deactivate indicating the batteries as beginning to lower. Approximately after this happens the homeowner has about 2 - 3 weeks to change out batteries.

There is also an indicator on the display to indicate low battery in transmitter.

Remote Control Button Function



ON/OFF Key

- Pressing this button one time will turn the fireplace ON in manual mode. Pressing it once more will turn the fireplace off.

Note: The thermostat image on the left should read OFF for fireplace to run manually.



THERMOSTAT Key

3 Settings

- ON
 - Fireplace will operate in thermostat mode with ability to manually set the flame height.
- OFF
 - Thermostat is off, but will operate manually from remote using ON/OFF key.
- SMART
 - Works just the same as ON thermostat, but the SMART function will modulate the flame height as the fireplace nears the set temperature.

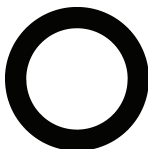

MODE Key

Pressing the MODE key will cycle the display screen from flame modulation, to fan modulation, to light kit on/off.

Use the UP/DOWN Arrow Key to adjust each setting accordingly.

Remote Control Display Icons

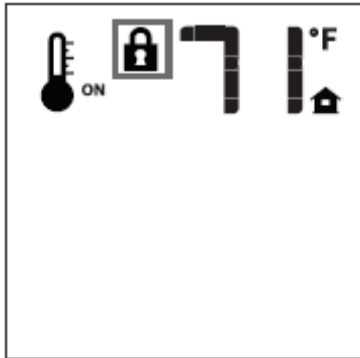

Key Lock

To activate child lock, press the Mode Key and the Up Arrow Key at the same time.

To deactivate press the same button sequence.

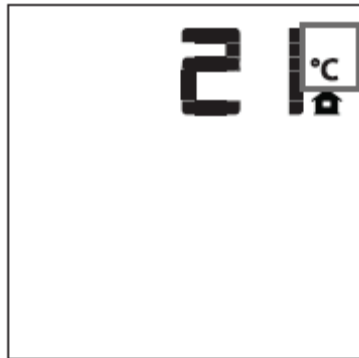
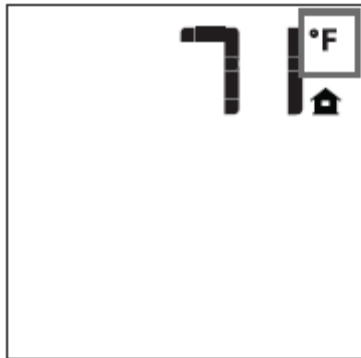

Fahrenheit / Celsius Adjustment:

With the system in the OFF position, press the Thermostat Key and the Mode Key at the same time.

SIT Proflame DFC Module Ignition and Reset Information

Ignition Sequence:

Starting from OFF, press the remote power button. Approximately four seconds after it is pushed the DFC module will send spark to the pilot hood. It will spark for 60 seconds.

If there is no flame ignition (rectification) during the first try for ignition, the DFC module will stop sparking for approximately 35 seconds and then it will begin sparking again. The second attempt will spark for another 60 seconds.

If there is no positive rectification after the second sequence the DFC module will go into a Lock Out and the LED Indicator Light (if equipped) will blink three times in intervals until the system is reset.

LED Indicator Light: Based on the fireplace model and design it may be located in the component housing behind the lower grill or behind the left access panel.

If the LED light is not equipped one supplied by Kozy Heat could be plugged into the diagnostic port to provide the light indicator.

In Summary:

- 1) Ignition sequence is 60 seconds spark, 35 second wait, 60 second spark and then lock out if flame is not rectified.
- 2) Lock Out blink on the LED Indicator Light is 3 blinks in sequence

Resetting Proflame DFC Module When In Lock Out:

Reset Using the Transmitter ON/OFF power button:

Turn the system off by pressing the remote power button. After approximately 2 seconds press it again.

Reset Using the Remote Flame Adjustment buttons:

In the manual mode, use the down arrow to lower the flame all the way to OFF. Wait 2 seconds and then use the up arrow to turn the flame back on.

Reset Using Receiver Switch:

With the remote off, move the ON-REMOTE-OFF switch to the OFF position on the receiver box. Wait approximately 2 seconds and slide back to ON position. (Note: You will need to move to REMOTE if you prefer to turn on via remote).

Additional Diagnostic Indication Information:

Low Battery Condition (<4V): LED Indicator will blink one time in continuous interval. Replace batteries in backup.

Pilot Flame Error Condition: LED Indicator will blink twice in continuous interval. Reason for error is pilot is called to turn on and the flame sensor already detects there is a flame present. Using multimeter you can troubleshoot to determine if the module is still sending voltage to the EV1 and in that case module would be our focus. If there is no voltage present and gas is still flowing it would likely be a valve that is stuck open. See later troubleshooting for how to test voltage on EV1.

System Lock Out Condition: LED Indicator will blink three times. Follow later troubleshooting steps for pilot not lighting.

Remote Not Learning to Receiver

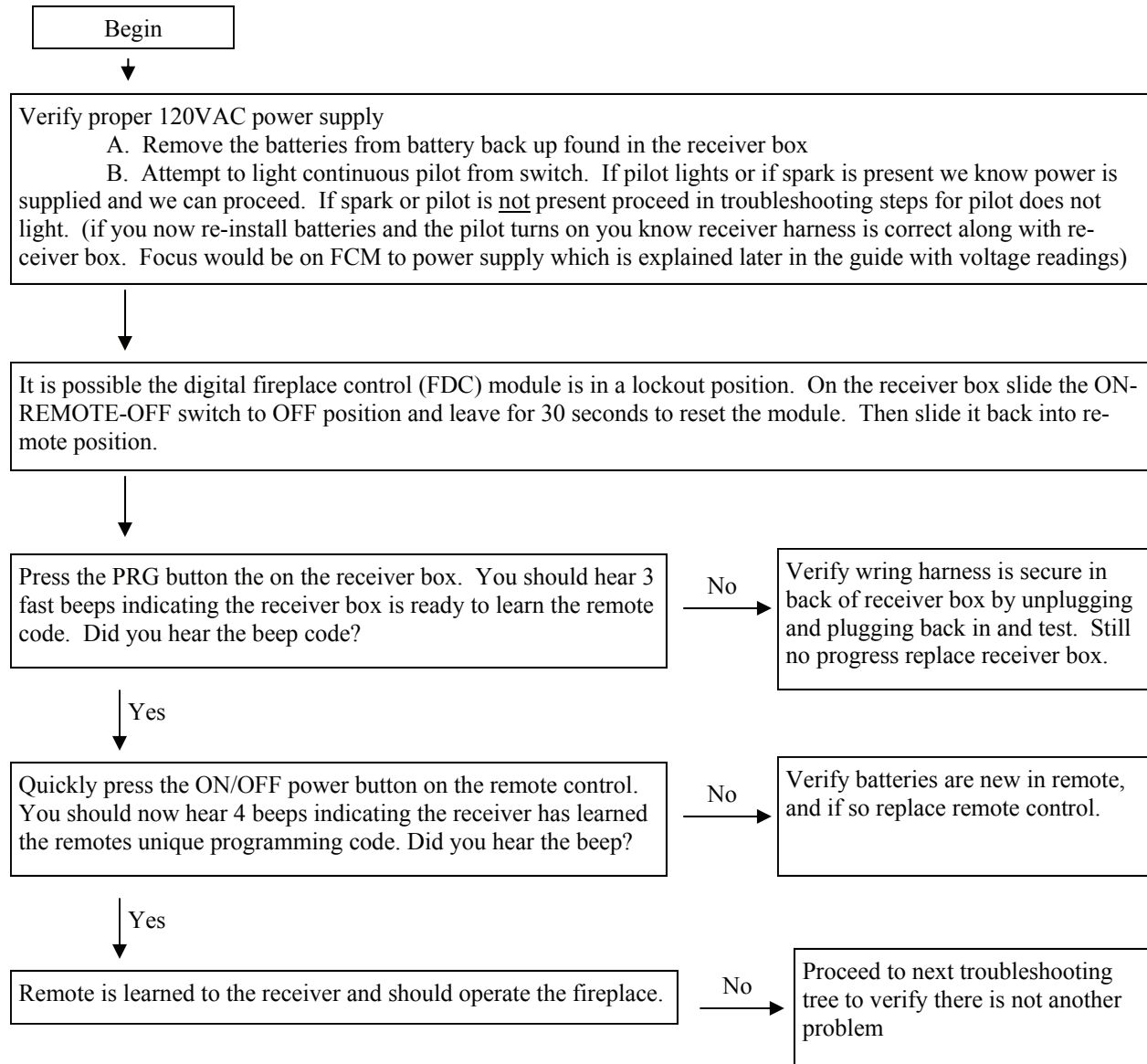

Troubleshooting

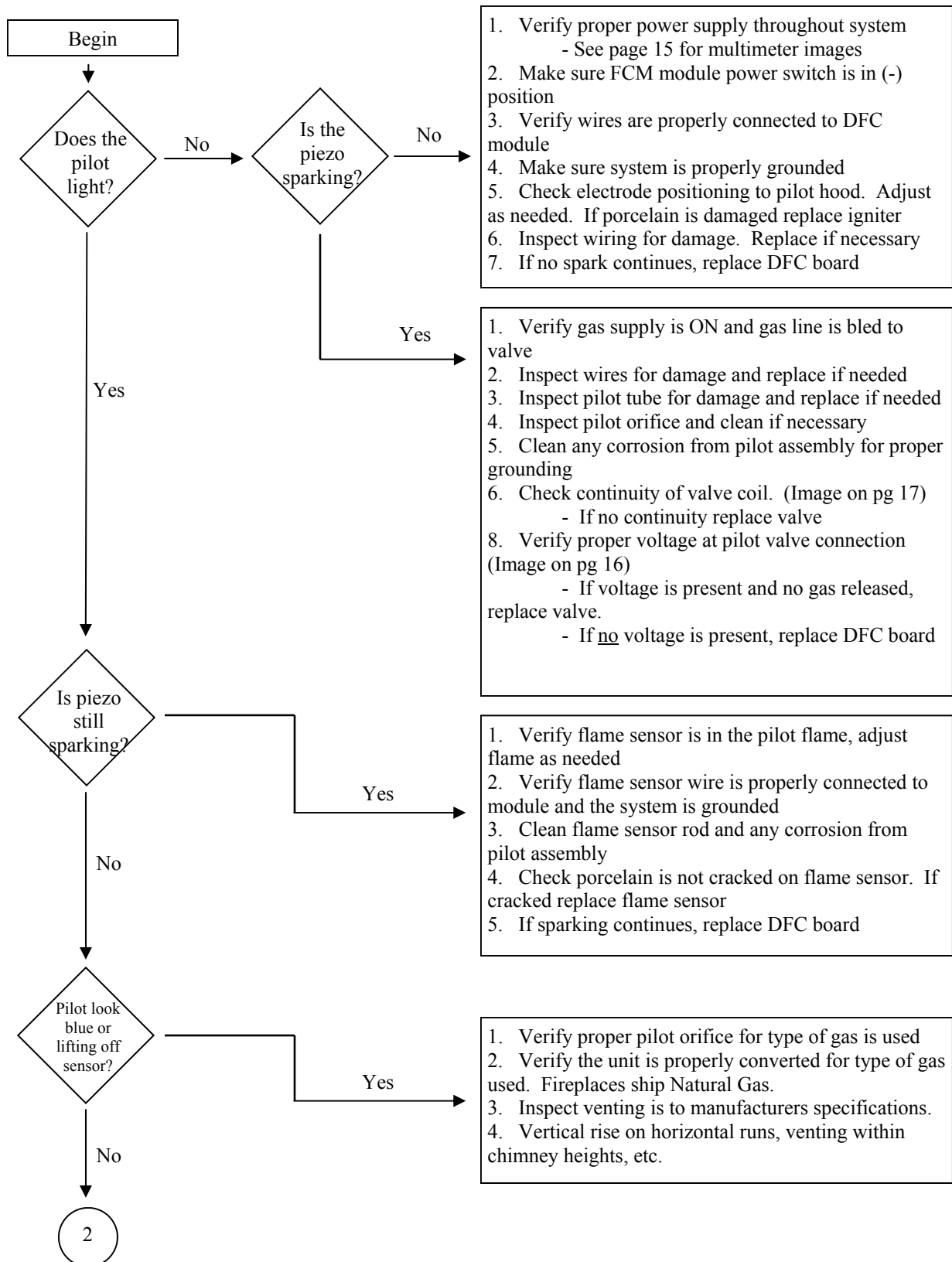

Troubleshooting

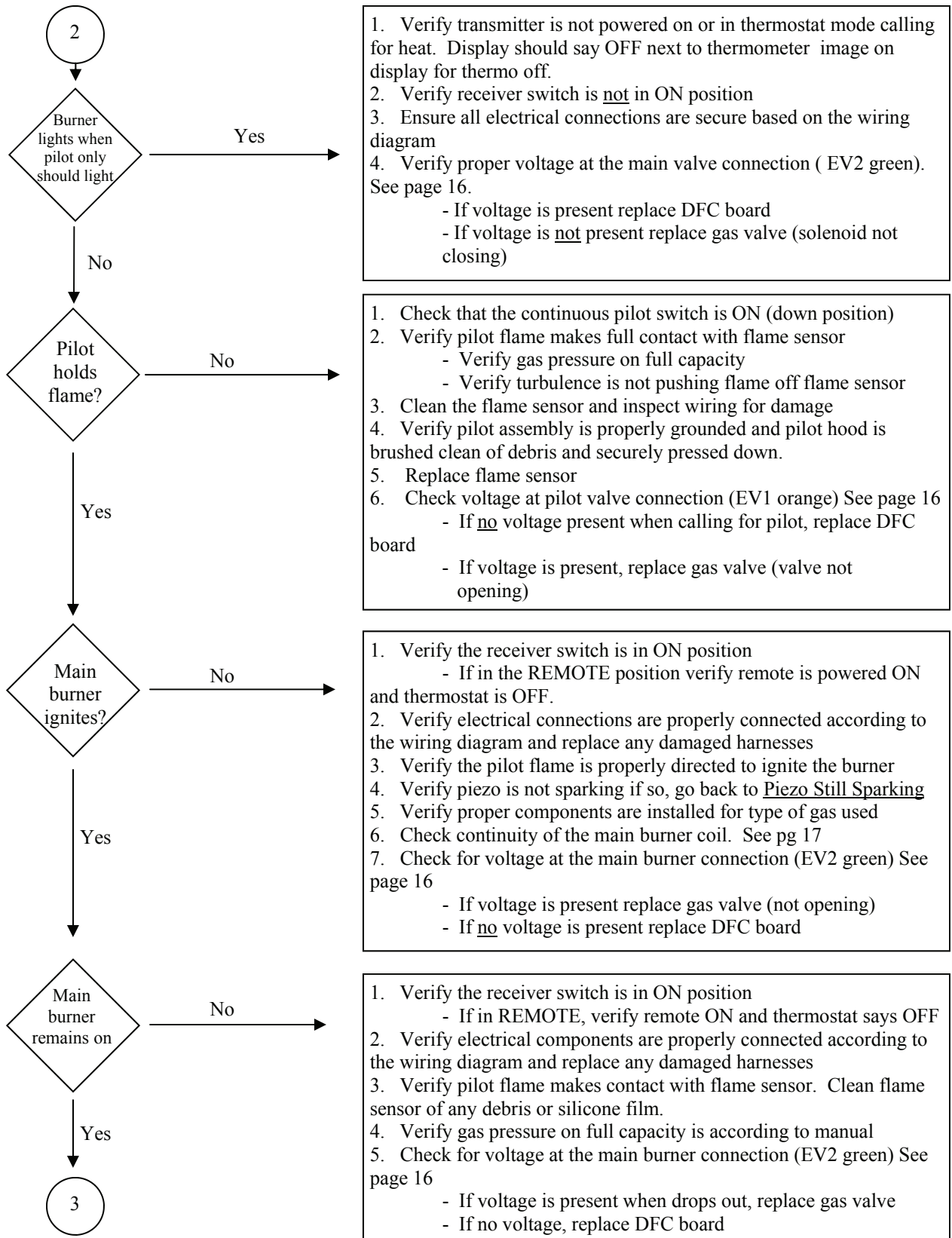

Troubleshooting

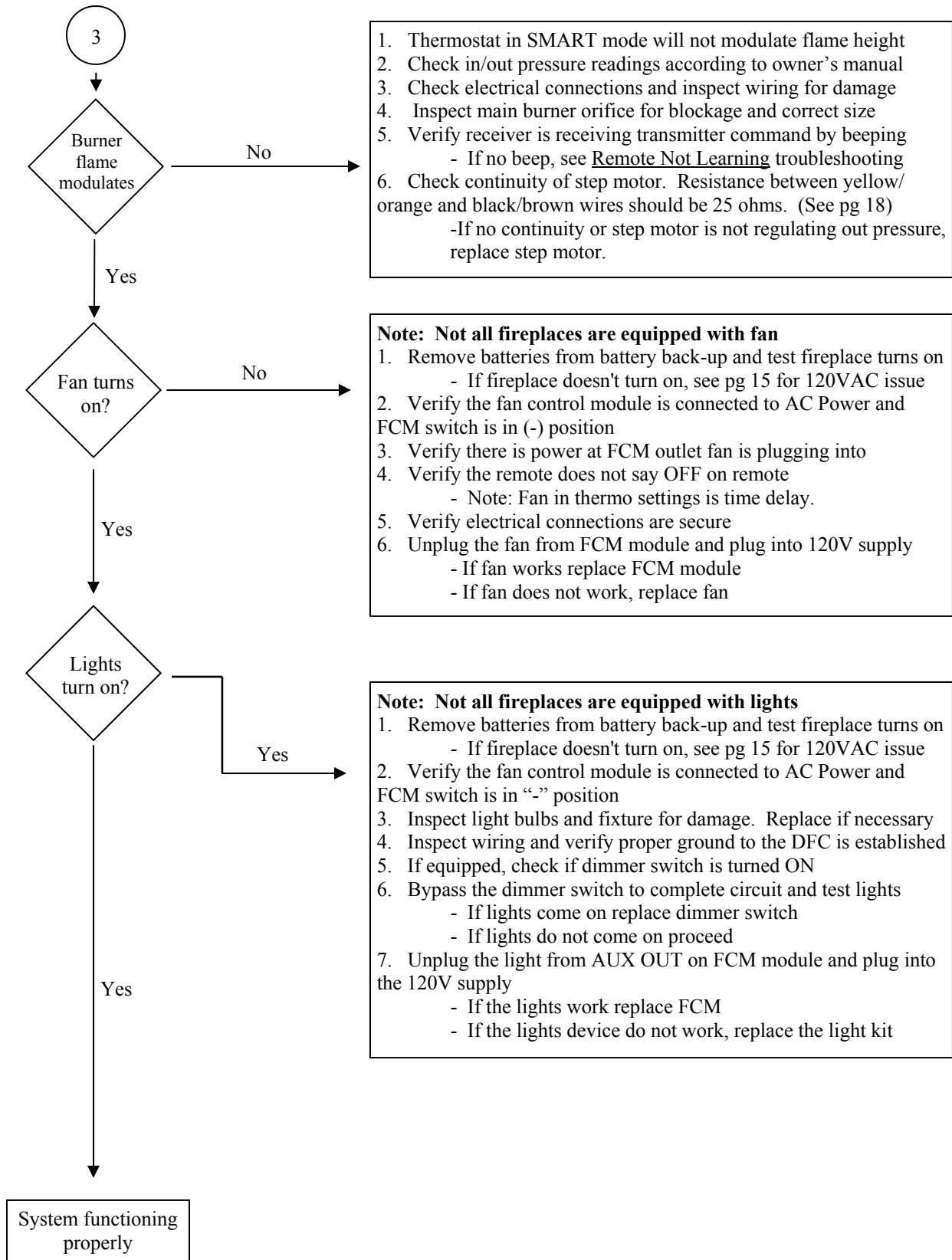

Verifying Power Supply off DFC Supply and off DFC Harness

The following images are a series of tests to determine if 120V is supplied throughout the system.

Figure 1.1 displays how to test if 120VAC is supplied to the FCM module. Take note that if you are getting 0VAC out of this test, make sure the POWER switch is on the (-) position and if so test the outlet the FCM is plugged into for power.

Note: This test will be a VAC reading

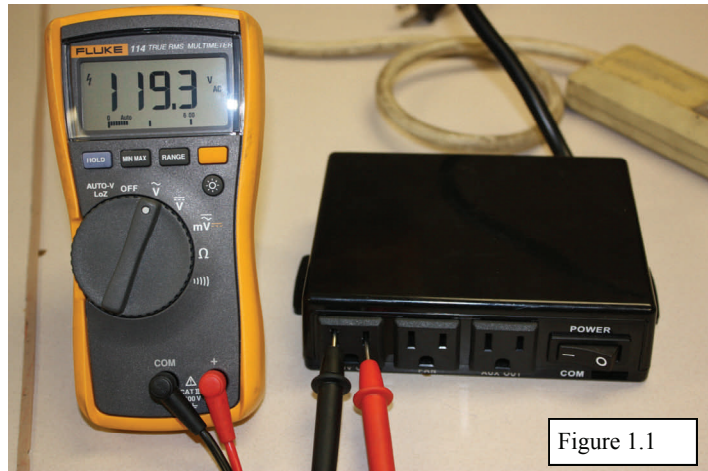

Figure 1.1

Figure 1.2 would be the next step if we have power at the FCM module to determine if the harness is supplying power. Location of this connection will vary on the model of fireplace, however following the red/black wires off the the DFC harness will lead to the DFC supply connection.

Note: This test will be a VDC reading

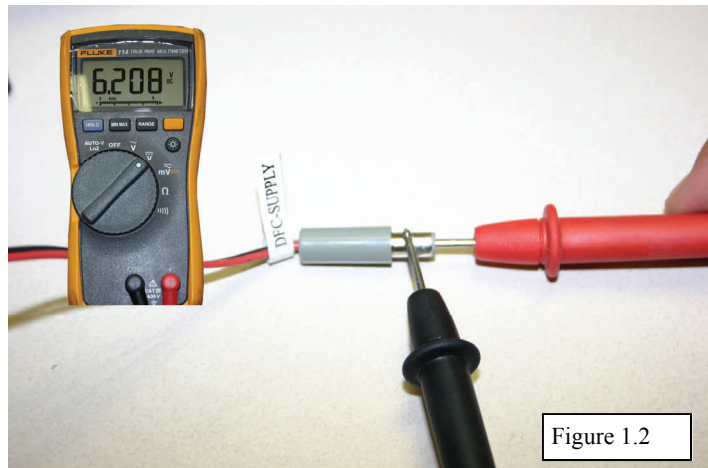

Figure 1.2

Figure 1.3 would be the final power supply test prior to the DFC module. It is important to get your multimeter pins on the contacts for an accurate reading.

Note: This test will be a VDC reading

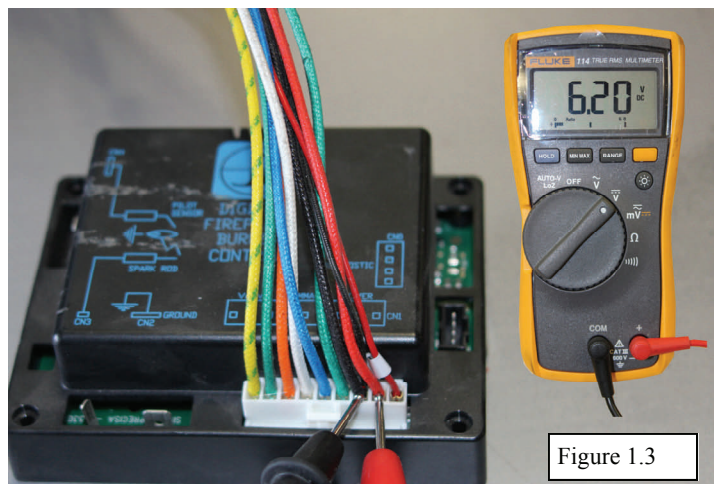

Figure 1.3

Verifying Voltage on Solenoids (EV1 and EV2)

This test performed would be done if we wanted to know if the DFC module is supplying power to the Pilot solenoid (EV1) telling it to open.

Multimeter would be in VDC.

EV1 Solenoid

One multimeter pin would be placed on the ground at the top of the valve where yellow/green wire connect, while the other pin would be placed on the spade connection where the Orange wire connects to the EV1 solenoid.

Initially when you turn on the pilot you will get a reading of about 4.292VDC (Figure 2.1) and drop to about 0.940 (Figure 2.2).

This reading tells us the DFC module is sending power through the harness to open the corresponding solenoid.

If you are getting power and valve is still not supplying gas our focus would be is gas turned on, pilot lined crimped, or bad valve. (see troubleshooting tree for complete steps)

EV2 Solenoid

To test Burner solenoid (EV2) follow the same process, but connect multimeter pins to ground and to the green solenoid and NOT the orange.

Important: To test the Burner Solenoid (EV2) there would need to be a proven/rectified pilot flame.

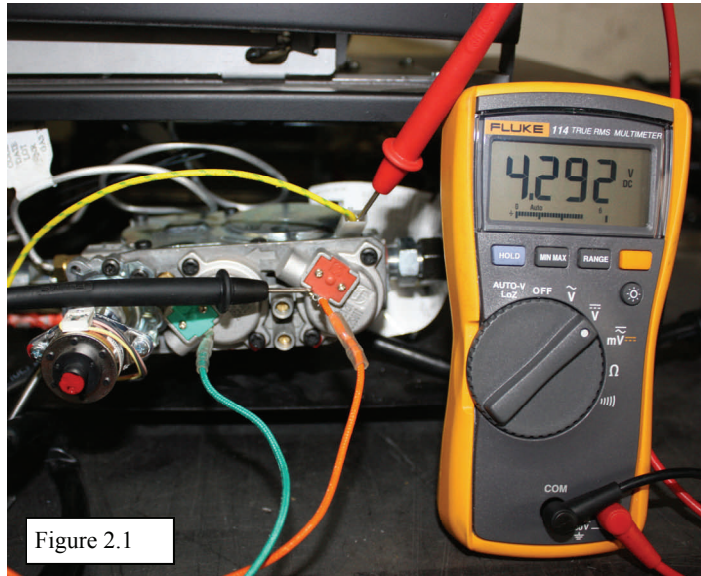

Figure 2.1

Voltage will drop

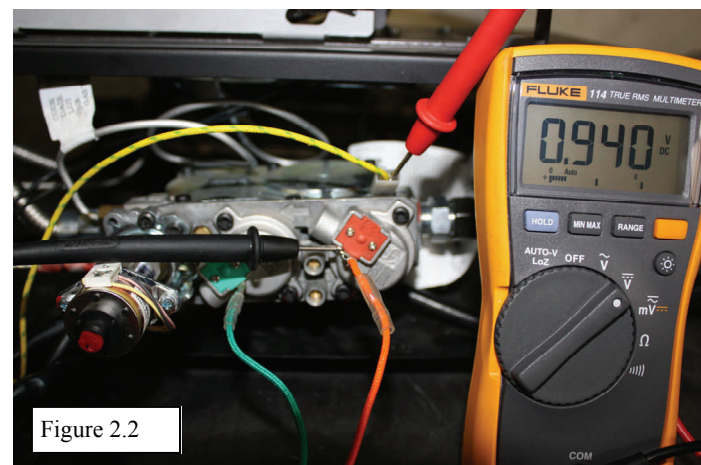

Figure 2.2

Performing Ohms Reading of Valve Solenoids

This test performed in Figures 3.1 and 3.2 are a continuity test of the valve solenoids. Your multimeter would need to be in the Ohms position and disconnect the wiring harness from EV1 and EV2.

Using one multimeter pin on the solenoid and the other on the ground your reading should be approximately 331.4 ohms.

Same process is conducted for either EV1 or EV2, just need to touch the corresponding spade connector.

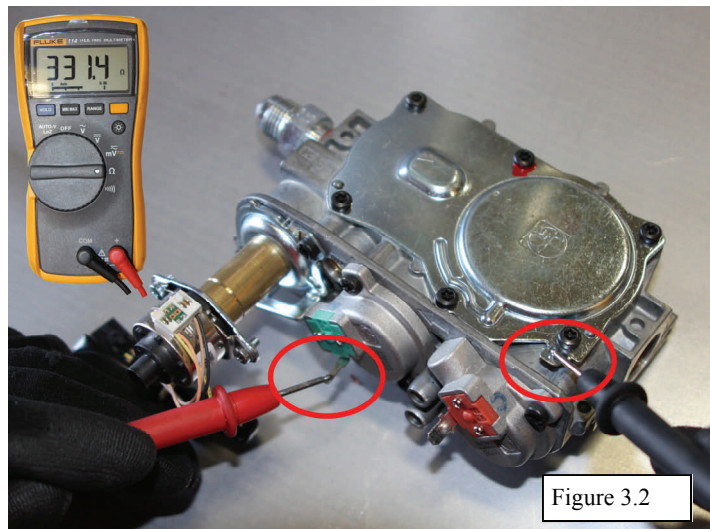
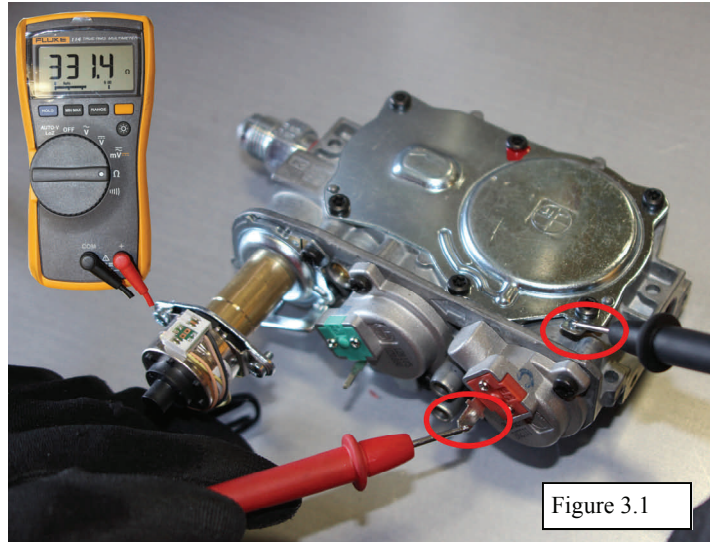

Performing Ohms Reading on Step Motor

This test performed in Figure 4.1 is a continuity test of the step motor. Your multimeter would need to be in the Ohms position and disconnect wiring harness from the step motor to expose the leads.

Using a multimeter place the two pins on the two leads of the connector. Your reading should be approximately 25.4 ohms.



Figure 4.1

**Proflame System Hussong
Configuration:
885 - GTMF
Illustrated Wire Diagram**

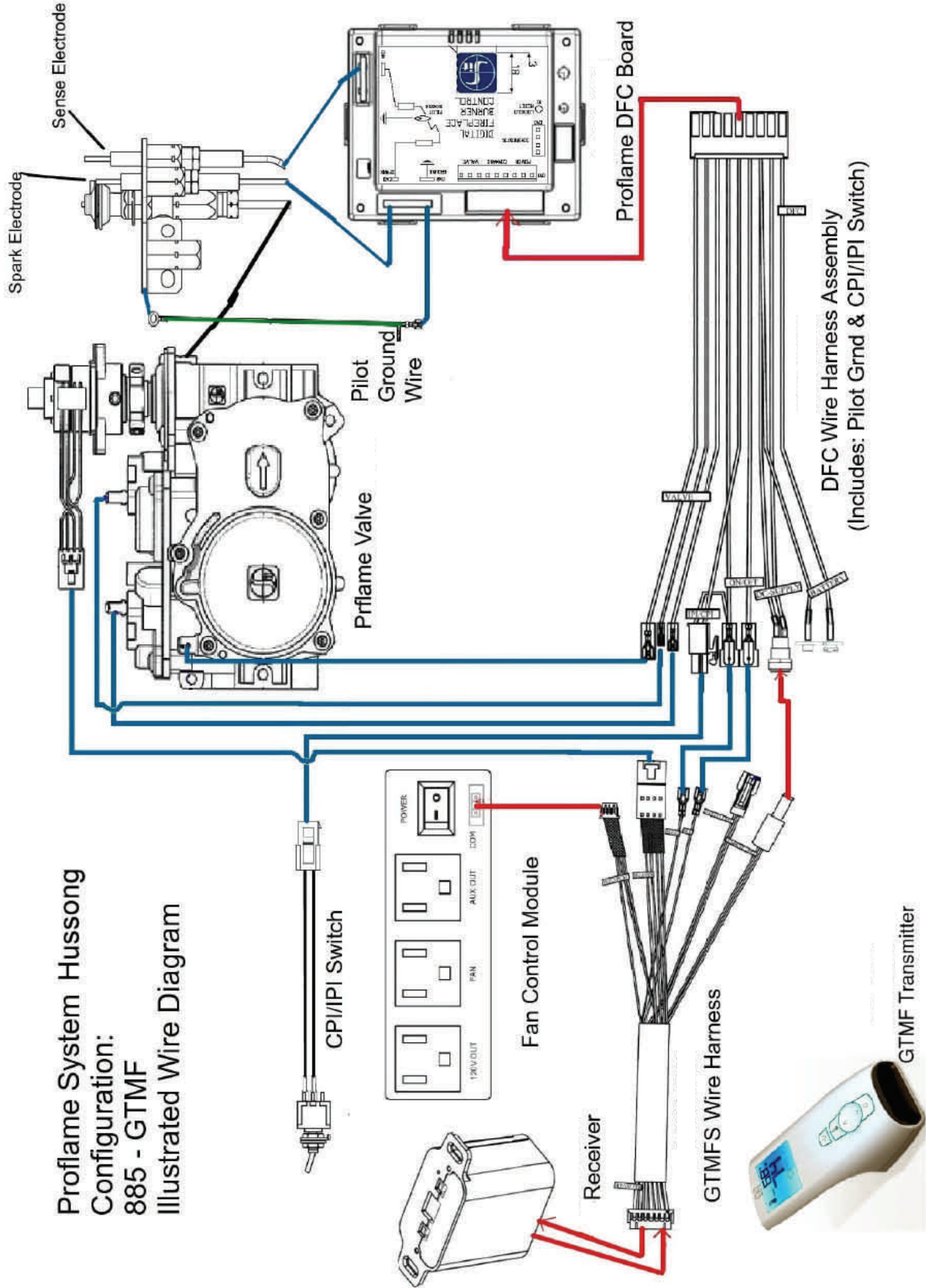

Harness Connections Not Used in GTMF Proflame I Setup

This battery connection will not be used in the GTMF wiring setup. It is on the harness if the receiver and remote would ever be removed, then the battery back up would connect here.

However, since we use a remote the battery back-up is located in the receiver box.

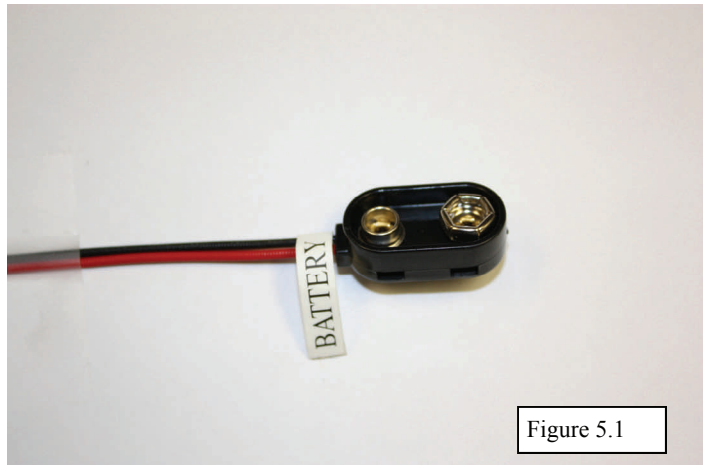

Figure 5.1

This connection is an optional split flow, which allows the rear burner to turn off on fireplaces that have two burner orifices.

The Kozy Heat fireplaces did not include this technology on any of their fireplaces, therefore this connection would be unused.

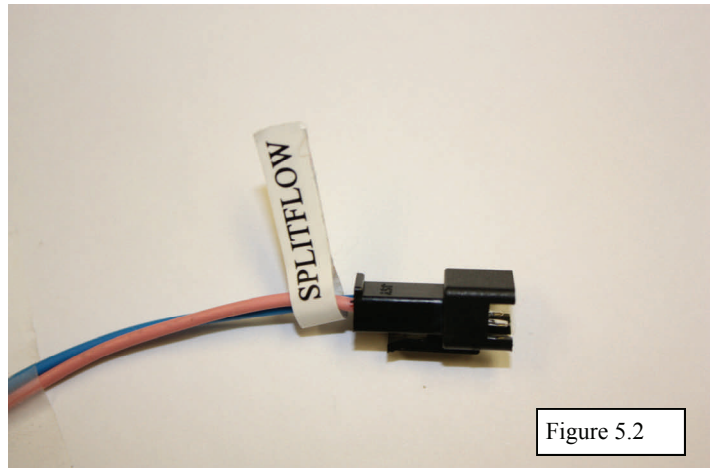

Figure 5.2