

# PHYSICS

# INVESTIGATORY

# PROJECT

Name -

Class -

Roll no. -

---



# TOPIC



# Electromagnetic













# Induction

---

# Index

---

CONTENT	Page no.
 CERTIFICATE	1
 ACKNOWLEDGEMENT	2
 AIM OF PROJECT	3
 INTRODUCTION	4-5
 THEORY	6-11
 OBSERVATION	12
 CONCLUSION	13
 APPLICATIONS OF EMI	14
 PRECAUTIONS	15
 BIBLIOGRAPHY	16

# CERTIFICATE

This is to certify that Abhishek kumar of class XII-A has successfully completed the investigatory project on the topic **“ELECTROMAGNETIC INDUCTION”** under my guidance during the year 2015-2016 in the partial fulfillment of the physics practical examination conducted by CBSE .

Teacher's signature

Principal 's signature

---

# ACKNOWLEDGEMENT

I would like to sincerely and profusely thank my Physics teacher **Mr. Kuldeep** , for his able guidance and support in completing my project.

I would also like to extend my gratitude to the principal for providing me with all the facility that was required.

Last but not the least, I would extend my gratitude towards all teaching and non teaching staff of Tulips international school and towards my friends who has supported me to complete this project.

Abhishek kumar

---

# AIM

To study the phenomenon of electromagnetic induction.

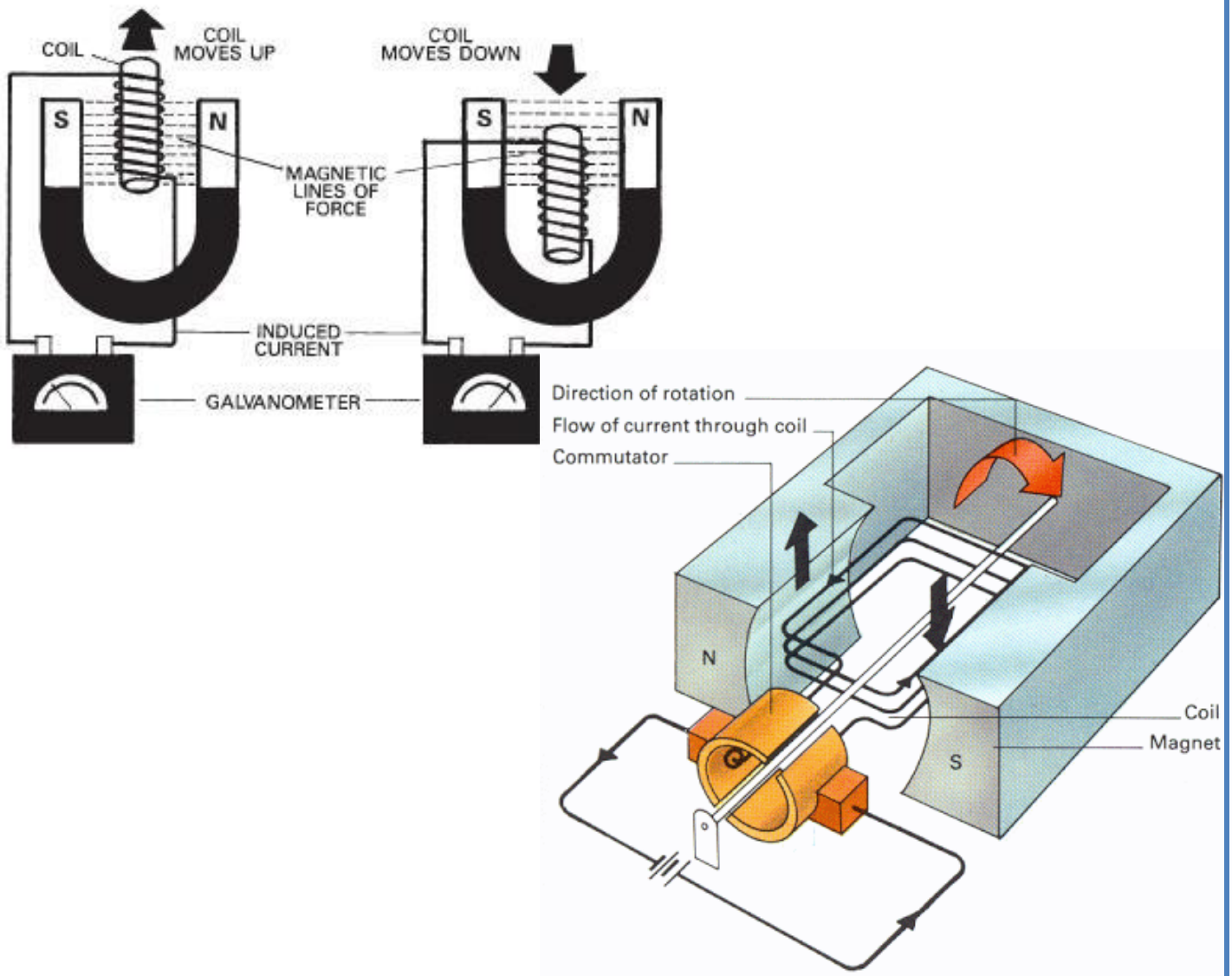



# INTRODUCTION

## **Electro Magnet:**

An electromagnet is a type of magnet in which the magnetic field is produced by electric current. The magnetic field disappears when the current is turned off.

## **Induction:**

This process of generating current in a conductor by placing the conductor in a changing magnetic field is called induction.

## **Electromagnetic Induction:**

Electromagnetic induction is the production of a potential difference (voltage) across a conductor when it is exposed to a varying magnetic field.

Electromagnetic induction is when an electromagnetic field causes molecules in another object to flow. Induction can produce electricity (in coils), heat (in ferrous metals), or waves (in a radio transmitter).

Finally it is refers to the phenomenon where an emf is induced when the magnetic flux linking a conductor changes.

**Magnetic Flux** is defined as the product of the magnetic flux density and the area *normal* to the field through which the field is passing. It is a scalar quantity and its S.I. unit is the weber (Wb).

$$\phi = B A$$

---

**Principle:**

Electromagnetic induction (or sometimes just induction) is a process where a conductor placed in a changing magnetic field (or a conductor moving through a stationary magnetic field) causes the production of a voltage across the conductor. This process of electromagnetic induction, in turn, causes an electrical current - it is said to induce the current.

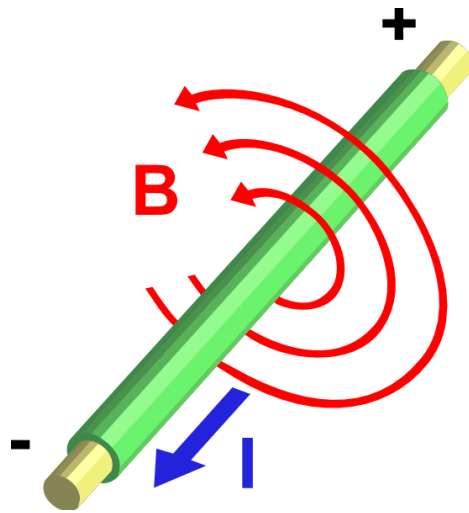





# THEORY

## Invention:

Michael Faraday is generally credited with the discovery of induction in 1831 though it may have been anticipated by the work of Francesco Zantedeschi in 1829. Around 1830 to 1832, Joseph Henry made a similar discovery, but did not publish his findings until later

## *Induced e.m.f.s:*

If magnetic flux through a coil is altered then an e.m.f. will be generated in the coil. This effect was first observed and explained by Ampere and Faraday between 1825 and 1831. Faraday discovered that an e.m.f. could be generated either by, (a) moving the coil or the source of flux relative to each other or by (b) changing the magnitude of the source of magnetic flux in some way. Note that the e.m.f. is only produced while the flux is changing.

For example, consider two coils as shown in Figure 1.

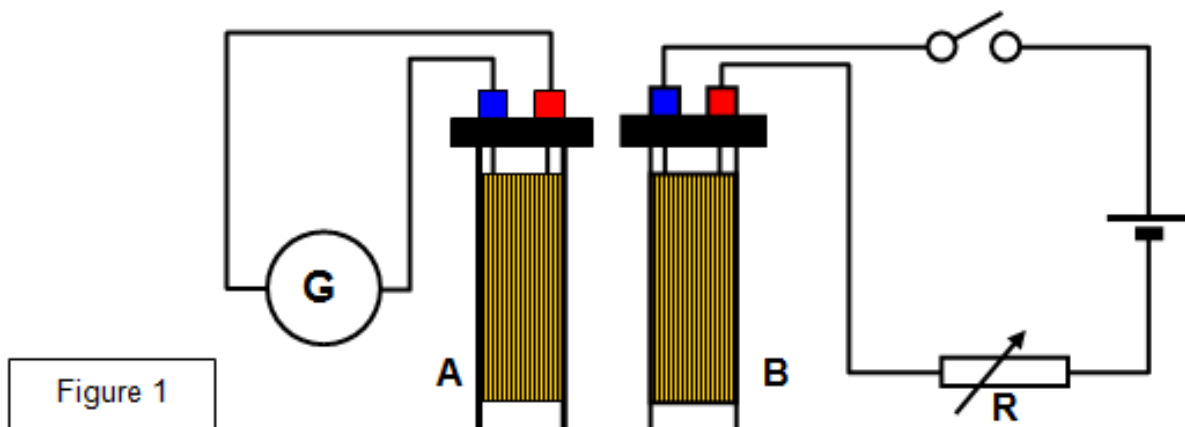

Figure 1

Coil A is connected to a galvanometer and coil B is connected to a battery and has direct current flowing through it. Coil A is within the magnetic field produced by B and an e.m.f. can be produced in A by moving the coils relative to each other or by changing the size of the current in B. This can be done by using the rheostat R, switching the current on or off, or (c) using an a.c. supply for B.

(An e.m.f. could also be produced in coil A by replacing coil B with a permanent magnet and moving this relative to coil A.)

### **Representation:**

Electromagnetic induction is the production of a potential difference (voltage) across a conductor when it is exposed to a varying magnetic field.

### **Working and Construction:**

Current is produced in a conductor when it is moved through a magnetic field because the magnetic lines of force are applying a force on the free electrons in the conductor and causing them to move. This process of generating current in a conductor by placing the conductor in a changing magnetic field is called induction. This is called induction because there is no physical connection between the conductor and the magnet. The current is said to be induced in the conductor by the magnetic field.

One requirement for this electromagnetic induction to take place is that the conductor, which is often a piece of wire, must be perpendicular to the magnetic lines of force in order to produce the maximum force on the free electrons. The direction that the induced current flows is determined by the direction of the lines of force and by the direction the wire is moving in the field. In the animation above the ammeter (the instrument used to measure current) indicates when there is current in the conductor.

---

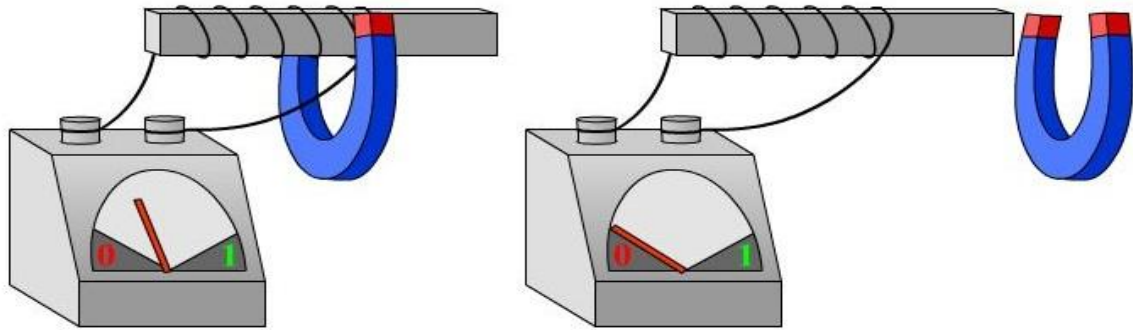

If an AC current is fed through a piece of wire, the electromagnetic field that is produced is constantly growing and shrinking due to the constantly changing current in the wire. This growing and shrinking magnetic field can induce electrical current in another wire that is held close to the first wire. The current in the second wire will also be AC and in fact will look very similar to the current flowing in the first wire.

It is common to wrap the wire into a coil to concentrate the strength of the magnetic field at the ends of the coil. Wrapping the coil around an iron bar will further concentrate the magnetic field in the iron bar. The magnetic field will be strongest inside the bar and at its ends (poles).

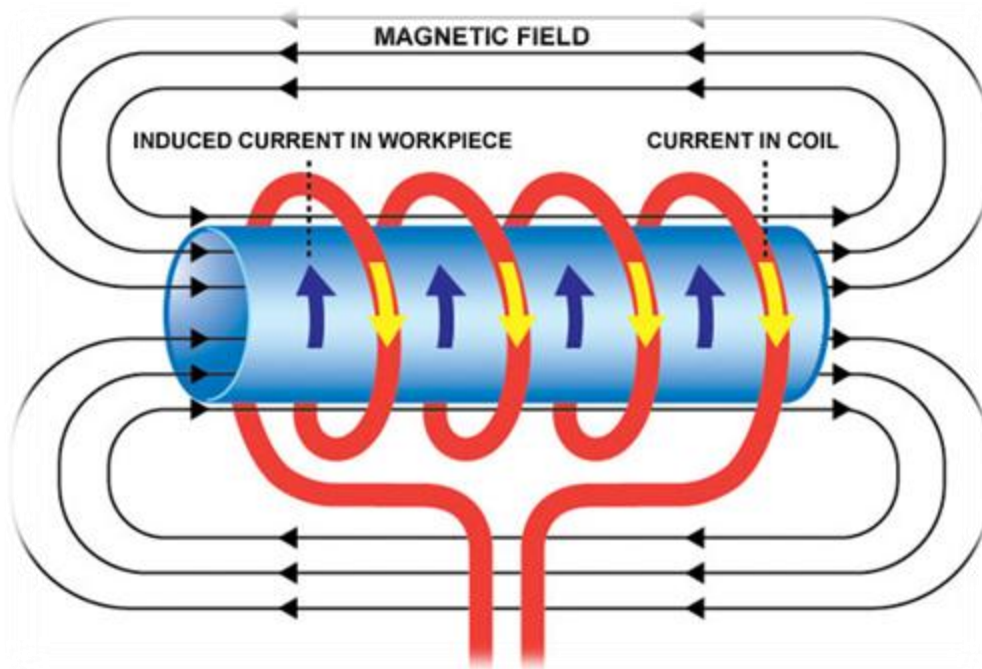

## Lenz's Law:

When an emf is generated by a change in magnetic flux according to Faraday's Law, the polarity of the induced emf is such that it produces a current whose magnetic field opposes the change which produces it. The induced magnetic field inside any loop of wire always acts to keep the magnetic flux in the loop constant. In the examples below, if the B field is increasing, the induced field acts in opposition to it. If it is decreasing, the induced field acts in the direction of the applied field to try to keep it constant.

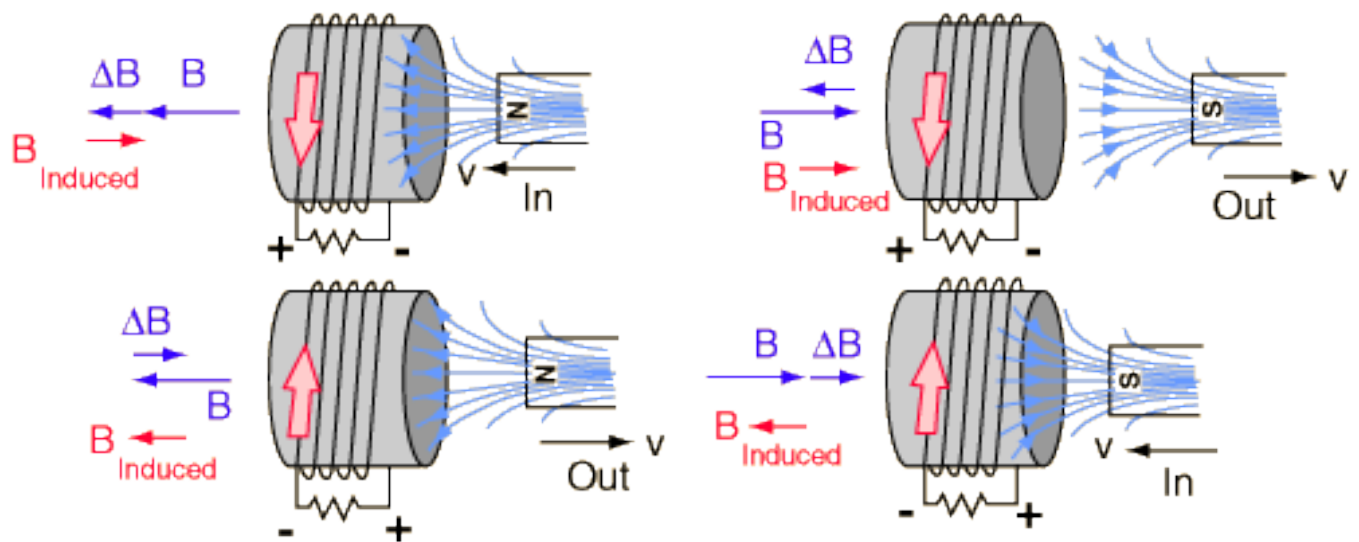

## Applications of electromagnetic Induction

### Electrical Generator:

The EMF generated by Faraday's law of induction due to relative movement of a circuit and a magnetic field is the phenomenon underlying electrical generators. When a permanent magnet is moved relative to a conductor, or vice versa, an electromotive force is created. If the wire is connected through an electrical load, current will flow, and thus electrical energy is generated, converting the mechanical energy of motion to electrical energy

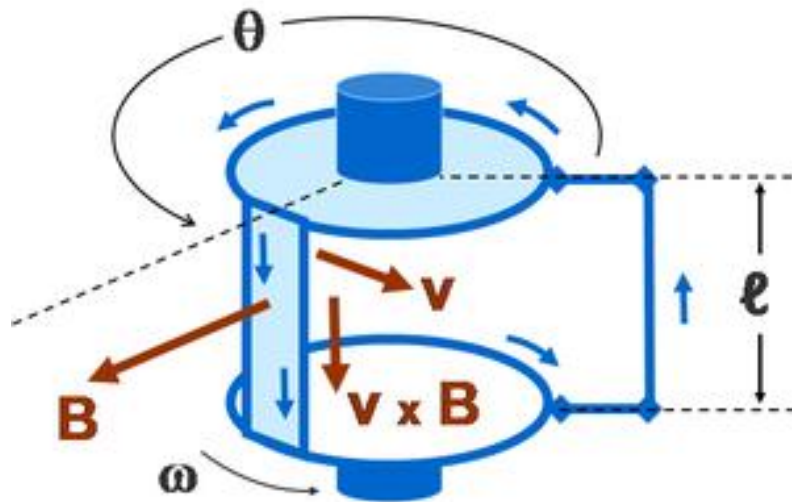

### Electrical transformer

The EMF predicted by Faraday's law is also responsible for electrical transformers. When the electric current in a loop of wire changes, the changing current creates a changing magnetic field. A second wire in reach of this magnetic field will experience this change in magnetic field as a change in its coupled magnetic flux,  $d\Phi_B / dt$ . Therefore, an electromotive force is set up in the second loop called the induced EMF or transformer EMF. If the two ends of this loop are connected through an electrical load, current will flow.

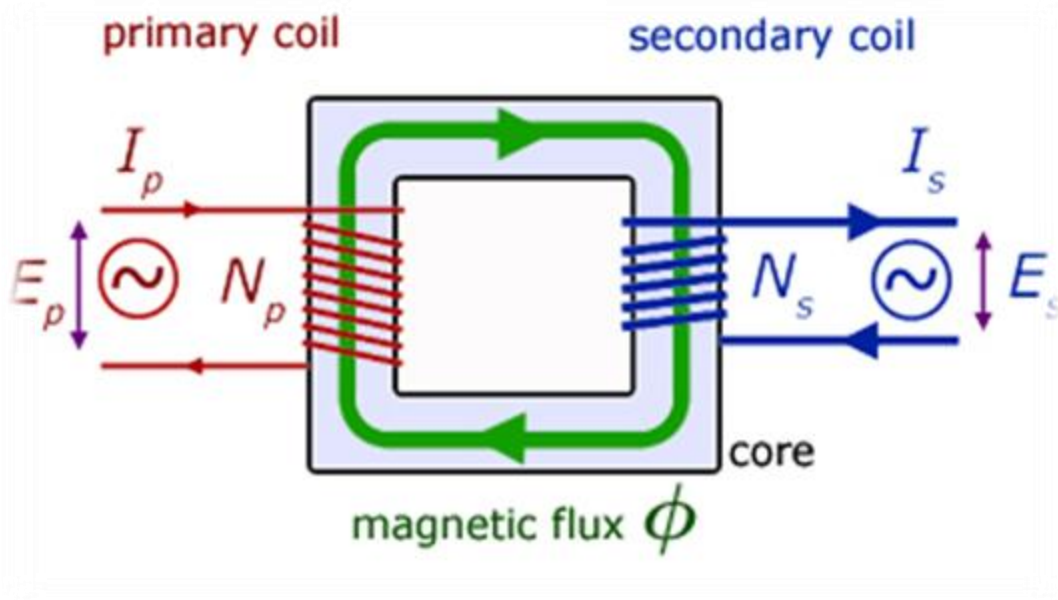

### Magnetic flow meter:

Faraday's law is used for measuring the flow of electrically conductive liquids and slurries. Such instruments are called magnetic flow meters. The induced voltage  $\mathcal{E}$  generated in the magnetic field  $B$  due to a conductive liquid moving at velocity  $v$  is thus given by:

$$\mathcal{E} = -Blv,$$

where  $\ell$  is the distance between electrodes in the magnetic flow meter.

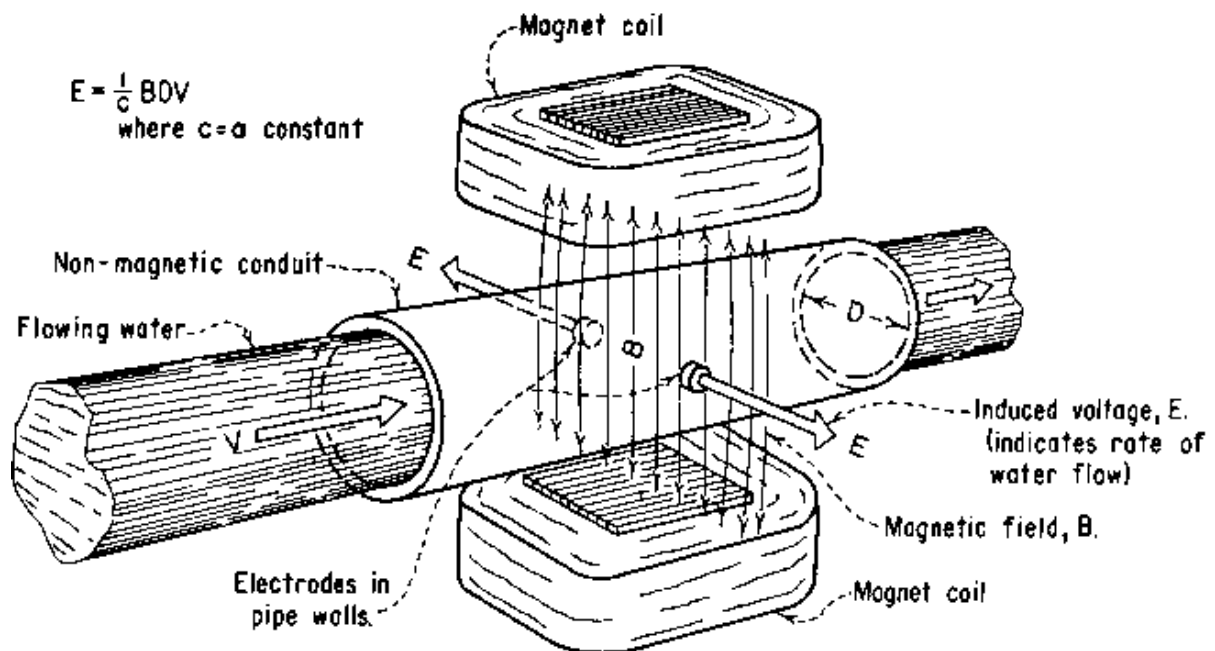



# OBSERVATION

## □ First observation

- Magnet is moved at certain rate and certain voltage is produced
- Magnet is moved at faster rate and creating a greater induced voltage.
- Magnet is moved at same speed through coil that has greater number of turn and greater voltage is induced

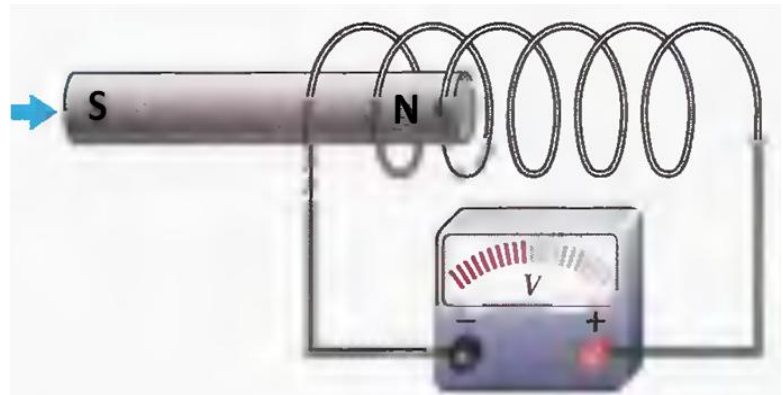

(a) As the magnet moves slowly to the right, its magnetic field is changing with respect to coil, and a voltage is induced.

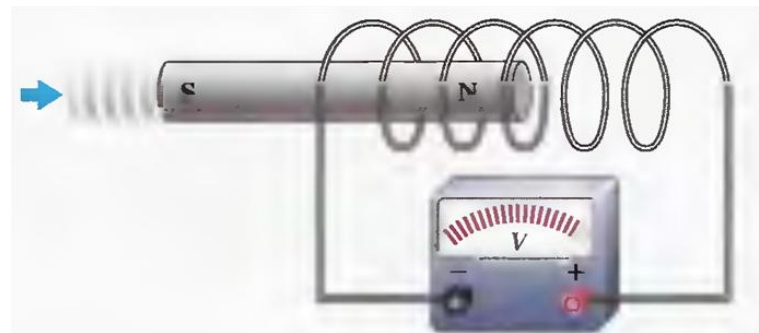

(b) As the magnet moves more rapidly to the right, its magnetic field is changing more rapidly with respect to coil, and a greater voltage is induced.

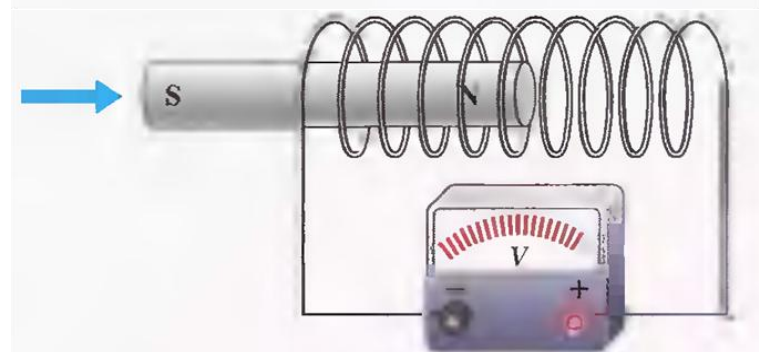

(b) Magnet moves at same rate through a coil with more turns (loops) and induces a greater voltage.



# CONCLUSION

Faraday's Law of Electromagnetic Induction, first observed and published by Michael Faraday in the mid-nineteenth century, describes a very important electro-magnetic concept. Although its mathematical representations are cryptic, the essence of Faraday's is not hard to grasp: it relates an induced electric potential or voltage to a dynamic magnetic field. This concept has many far-reaching ramifications that touch our lives in many ways: from the shining of the sun, to the convenience of mobile communications, to electricity to power our homes. We can all appreciate the profound impact Faraday's Law has on us.

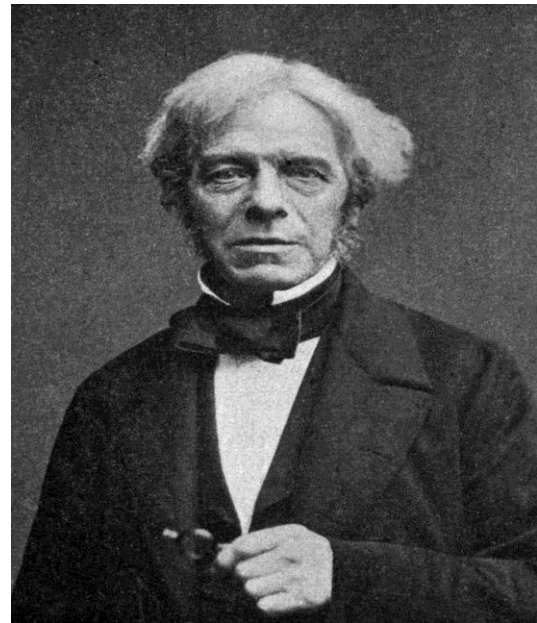





# APPLICATIONS

The principles of electromagnetic induction are applied in many devices and systems, including:

- Electrical generators
- Induction motors
- Induction sealing
- Inductive charging
- Transformers
- Wireless energy transfer

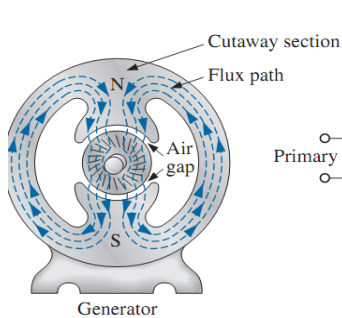



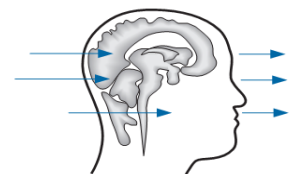
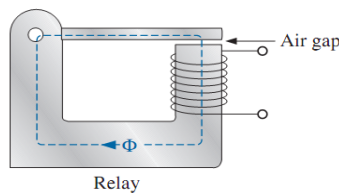
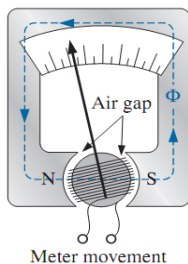
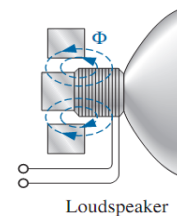
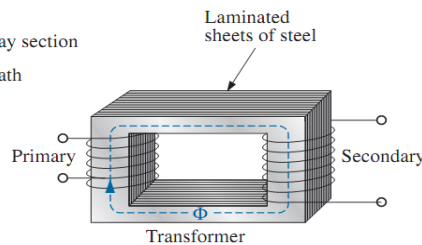

Generator

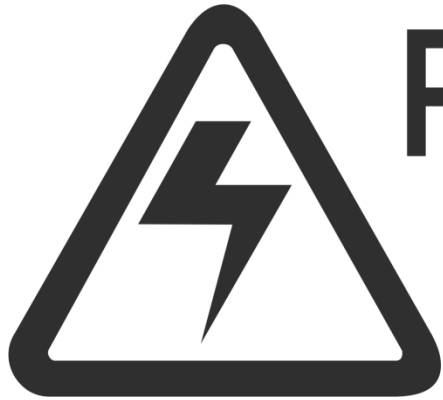

Medical Applications: Magnetic resonance imaging.



# PRECAUTION

-  Keep yourself safe from high voltage.
  -  Use & handle lab instruments with care.
  -  Do not scratch insulated copper wire while making loop.
  -  Do not use digital voltmeter for above demonstration .
-

# BIBLIOGRAPHY

- [Wikipedia.com](https://www.wikipedia.com)
- Google search engine
- Physics Ncert book for class XII

