



MASS PHYSICS
EDUCATION

STUDY MATERIAL
CLASS XI
PHYSICS (042)
Session 2024-25



MASS PHYSICS
EDUCATION



MASS
PHYSICS

BY THE BLESSINGS OF KALI MATA THOUSANDS OF STUDENTS
GET PROPER GUIDENCE AND REACHES THE SKY DONT
WASTE TIME AND ENROLL NOW.....

rohini sector 7 DELHI

EDUCATION CONCEPT

FOCUS CBSE NCERT
TILL NOVEMBER

- Special NCERT based modules
- example on each topic for understanding
- weekly and unit tests
- full functioning practical lab

FOCUS NEET/JEE
TILL entrance exam

- specially designed topicwise modules
- latest Questions from NEET/JEE exams
- weekly and unit tests



WHY US?

Making physics simple & scoring ✓

FROM LAST 18 YEARS MASS PHYSICS EDUCATION IS A POPULAR INSTITUTE IN ROHINI FOR MAKING PHYSICS INTERESTING AND SCORING .. THE UNIQUE STYLE OF PRABHAKAR SIR MAKES STUDENTS VERY EASY TO UNDERSTAND PHYSICS

Professional Teacher ✓

PRABHAKAR SIR MAKE PHYSICS LIVE WITH GENERAL DAY TO DAY SITUATION SO THAT STUDENTS RELATE TOPICS TO PRACTICAL KNOWLEDGE .. AT MASS PHYSICS WE LIVE PHYSICS

Affordable & Trusted ✓

INSTITUTES TOUCHING SKY IN FEE AND GROUND IN EDUCATION BUT MASS PHYSICS IS MOST AFFORDABLE AND REASONABLE INSTITUTE WHICH PROVIDE QUALITY EDUCATION IN THIS ERA



MASS PHYSICS

CONTACT

 9818033370

www.massphysics.com

BY THE BLESSINGS OF KALI MATA THOUSANDS OF STUDENTS GET PROPER GUIDANCE AND REACHES THE SKY DONT WASTE TIME AND ENROLL NOW.....

rohini sector 7 DELHI

MAY KALI MATA BLESS YOU ALL



MASS INSTITUTE

CUSTOMIZED CLASSES FOR SCIENCE STUDENTS

INDEX

S.No	Content	Page No.
1	Syllabus	5-11
2	Units and Measurements	12-16
3	Motion in a Straight Line	17-23
4	Motion in a Plane	24-29
5	Laws of Motion	30-42
6	Work, Energy and Power	43-54
7	System of Particles and Rotational Motion	55-63
8	Gravitation	64-83
9	Mechanical Properties of Solids	84-92
10	Mechanical Properties of Fluids	93-100
11	Thermal Properties of Matter	101-108
12	Thermodynamics	109-112
13	Behavior of Perfect Gases and Kinetic Theory of Gases	113-122
14	Oscillations & Waves	123-139
15	Sample question Paper with Blue Print and Answer key	140-150

SYLLABUS

PHYSICS

Class XI- (Code No.42)(2022-23)

Senior Secondary stage of school education is a stage of transition from general education to discipline-based focus on curriculum. The present updated syllabus keeps in view the rigor and depth of disciplinary approach as well as the comprehension level of learners. Due care has also been taken that the syllabus is comparable to the international standards. Salient features of the syllabus include:

- Emphasis on basic conceptual understanding of the content.
- Emphasis on use of SI units, symbols, nomenclature of physical quantities and formulations as per international standards.
- Providing logical sequencing of units of the subject matter and proper placement of concepts with their linkage for better learning.
- Reducing the curriculum load by eliminating overlapping of concepts/content within the discipline and other disciplines.
- Promotion of process-skills, problem-solving abilities and applications of Physics concepts.

Besides, the syllabus also attempts to

- Strengthen the concepts developed at the secondary stage to provide firm foundation for further learning in the subject.
- Expose the learners to different processes used in Physics-related industrial and technological applications.
- Develop process-skills and experimental, observational, manipulative, decisionmaking and investigatory skills in the learners.
- Promote problem solving abilities and creative thinking in learners.
- Develop conceptual competence in the learners and make them realize and appreciate the interface of Physics with other disciplines.

PHYSICS (Code No. 042)
COURSE STRUCTURE

Class XI – 2022-23 (Theory)

Time: 3 hrs.

Max Marks: 70

		No. of Periods	Marks
Unit-I	Physical World and Measurement	08	23
	Chapter-2: Units and Measurements		
Unit-II	Kinematics	24	
	Chapter-3: Motion in a Straight Line		
	Chapter-4: Motion in a Plane		
Unit-III	Laws of Motion	14	
	Chapter-5: Laws of Motion		
Unit-IV	Work, Energy and Power	14	
	Chapter-6: Work, Energy and Power		
Unit-V	Motion of System of Particles and Rigid Body	18	
	Chapter-7: System of Particles and Rotational Motion		
Unit-VI	Gravitation		12
	Chapter-8: Gravitation		
Unit-VII	Properties of Bulk Matter	24	
	Chapter-9: Mechanical Properties of Solids		
	Chapter-10: Mechanical Properties of Fluids		
	Chapter-11: Thermal Properties of Matter		
Unit-VIII	Thermodynamics	12	
	Chapter-12: Thermodynamics		
Unit-IX	Behaviour of Perfect Gases and Kinetic Theory of Gases	08	
	Chapter-13: Kinetic Theory		
Unit-X	Oscillations and Waves	26	
	Chapter-14: Oscillations		
	Chapter-15: Waves		
Total		160	70

Unit I: Physical World and Measurement**08 Periods****Chapter–2: Units and Measurements**

Need for measurement: Units of measurement; systems of units; SI units, fundamental and derived units. significant figures. Dimensions of physical quantities, dimensional analysis and its applications.

Unit II: Kinematics**24 Periods****Chapter–3: Motion in a Straight Line**

Frame of reference, Motion in a straight line, Elementary concepts of differentiation and integration for describing motion, uniform and non- uniform motion, and instantaneous velocity, uniformly accelerated motion, velocity - time and position-time graphs. Relations for uniformly accelerated motion (graphical treatment).

Chapter–4: Motion in a Plane

Scalar and vector quantities; position and displacement vectors, general vectors and their notations; equality of vectors, multiplication of vectors by a real number; addition and subtraction of vectors, Unit vector; resolution of a vector in a plane, rectangular components, Scalar and Vector product of vectors.

Motion in a plane, cases of uniform velocity and uniform acceleration- projectile motion, uniform circular motion.

Unit III: Laws of Motion**14 Periods****Chapter–5: Laws of Motion**

Intuitive concept of force, Inertia, Newton's first law of motion; momentum and Newton's second law of motion; impulse; Newton's third law of motion.

Law of conservation of linear momentum and its applications.

Equilibrium of concurrent forces, Static and kinetic friction, laws of friction,rolling friction, lubrication.

Dynamics of uniform circular motion: Centripetal force, examples of circular motion (vehicle on a level circular road, vehicle on a banked road).

Unit IV: Work, Energy and Power**14 Periods****Chapter–6: Work, Energy and Power**

Work done by a constant force and a variable force; kinetic energy, work- energy theorem, power.

Notion of potential energy, potential energy of a spring, conservative forces: non-conservative forces, motion in a vertical circle; elastic and inelastic collisions in one and two dimensions.

Unit V: Motion of System of Particles and Rigid Body**18Periods****Chapter–7: System of Particles and Rotational Motion**

Centre of mass of a two-particle system, momentum conservation and Centre of mass motion. Centre of mass of a rigid body; centre of mass of a uniform rod.

Moment of a force, torque, angular momentum, law of conservation of angular momentum and its applications.

Equilibrium of rigid bodies, rigid body rotation and equations of rotational motion, comparison of linear and rotational motions.

Moment of inertia, radius of gyration, values of moments of inertia for simple geometrical objects (no derivation).

Unit VI: Gravitation**12 Periods****Chapter–8: Gravitation**

Kepler's laws of planetary motion, universal law of gravitation. Acceleration due to gravity and its variation with altitude and depth.

Gravitational potential energy and gravitational potential, escape velocity, orbital velocity of a satellite.

Unit VII: Properties of Bulk Matter**24 Periods****Chapter–9: Mechanical Properties of Solids**

Elasticity, Stress-strain relationship, Hooke's law, Young's modulus, bulk modulus, shear modulus of rigidity (qualitative idea only), Poisson's ratio; elastic energy.

Chapter–10: Mechanical Properties of Fluids

Pressure due to a fluid column; Pascal's law and its applications (hydraulic lift and hydraulic brakes), effect of gravity on fluid pressure.

Viscosity, Stokes' law, terminal velocity, streamline and turbulent flow, critical velocity, Bernoulli's theorem and its simple applications.

Surface energy and surface tension, angle of contact, excess of pressure across a curved surface, application of surface tension ideas to drops, bubbles and capillary rise.

Chapter–11: Thermal Properties of Matter

Heat, temperature, thermal expansion; thermal expansion of solids, liquids and gases, anomalous expansion of water; specific heat capacity; C_p , C_v - calorimetry; change of state - latent heat capacity.

Heat transfer-conduction, convection and radiation, thermal conductivity, qualitative ideas of Blackbody radiation, Wein's displacement Law, Stefan's law .

Unit VIII: Thermodynamics**12 Periods****Chapter–12: Thermodynamics**

Thermal equilibrium and definition of temperature zeroth law of thermodynamics, heat, work and internal energy. First law of thermodynamics,

Second law of thermodynamics: gaseous state of matter, change of condition of gaseous state -isothermal, adiabatic, reversible, irreversible, and cyclic processes.

Unit IX: Behavior of Perfect Gases and Kinetic Theory of Gases 08Periods**Chapter–13: Kinetic Theory**

Equation of state of a perfect gas, work done in compressing a gas.

Kinetic theory of gases - assumptions, concept of pressure. Kinetic interpretation of temperature; rms speed of gas molecules; degrees of freedom, law of equi-partition of energy (statement only) and application to specific heat capacities of gases; concept of mean free path, Avogadro's number.

Unit X: Oscillations and Waves**26 Periods****Chapter–14: Oscillations**

Periodic motion - time period, frequency, displacement as a function of time, periodic functions and their application.

Simple harmonic motion (S.H.M) and its equations of motion; phase; oscillations of a loaded spring- restoring force and force constant; energy in S.H.M. Kinetic and potential energies; simple pendulum derivation of expression for its time period.

Chapter–15: Waves

Wave motion: Transverse and longitudinal waves, speed of travelling wave, displacement relation for a progressive wave, principle of superposition of waves, reflection of waves, standing waves in strings and organ pipes, fundamental mode and harmonics, Beats.

PRACTICALS

Total Periods: 60

The record, to be submitted by the students, at the time of their annual examination, has to include:

- Record of at least 8 Experiments [with 4 from each section], to be performed by the students.
- Record of at least 6 Activities [with 3 each from section A and section B], to be performed by the students.
- Report of the project carried out by the students.

EVALUATION SCHEME

Time 3 hours

Max. Marks: 30

Topic	Marks
Two experiments one from each section	7+7
Practical record (experiment and activities)	5
One activity from any section	3
Investigatory Project	3
Viva on experiments, activities and project	5
Total	30

SECTION–A

Experiments

1. To measure diameter of a small spherical/cylindrical body and to measure internal diameter and depth of a given beaker/calorimeter using Vernier Callipers and hence find its volume.
2. To measure diameter of a given wire and thickness of a given sheet using screw gauge.
3. To determine volume of an irregular lamina using screw gauge.
4. To determine radius of curvature of a given spherical surface by a spherometer.
5. To determine the mass of two different objects using a beam balance.
6. To find the weight of a given body using parallelogram law of vectors.
7. Using a simple pendulum, plot its $L-T^2$ graph and use it to find the effective length of second's pendulum.
8. To study variation of time period of a simple pendulum of a given length by taking bobs of same size but different masses and interpret the result.
9. To study the relationship between force of limiting friction and normal reaction and to find the coefficient of friction between a block and a horizontal surface.
10. To find the downward force, along an inclined plane, acting on a roller due to gravitational pull of the earth and study its relationship with the angle of inclination θ by plotting graph between force and $\text{Sin}\theta$.

Activities

1. To make a paper scale of given least count, e.g., 0.2cm, 0.5 cm.
2. To determine mass of a given body using a metre scale by principle of moments.
3. To plot a graph for a given set of data, with proper choice of scales and error bars.
4. To measure the force of limiting friction for rolling of a roller on a horizontal plane.
5. To study the variation in range of a projectile with angle of projection.
6. To study the conservation of energy of a ball rolling down on an inclined plane (using a double inclined plane).
7. To study dissipation of energy of a simple pendulum by plotting a graph between square of amplitude and time.

SECTION-B

Experiments

1. To determine Young's modulus of elasticity of the material of a given wire.
2. To find the force constant of a helical spring by plotting a graph between load and extension.
3. To study the variation in volume with pressure for a sample of air at constant temperature by plotting graphs between P and V, and between P and $1/V$.
4. To determine the surface tension of water by capillary rise method.
5. To determine the coefficient of viscosity of a given viscous liquid by measuring terminal velocity of a given spherical body.
6. To study the relationship between the temperature of a hot body and time by plotting a cooling curve.
7. To determine specific heat capacity of a given solid by method of mixtures.
8. To study the relation between frequency and length of a given wire under constant tension using sonometer.
9. To study the relation between the length of a given wire and tension for constant frequency using sonometer.
10. To find the speed of sound in air at room temperature using a resonance tube by two resonance positions.

Activities

1. To observe change of state and plot a cooling curve for molten wax.
2. To observe and explain the effect of heating on a bi-metallic strip.
3. To note the change in level of liquid in a container on heating and interpret the observations.
4. To study the effect of detergent on surface tension of water by observing capillary rise.
5. To study the factors affecting the rate of loss of heat of a liquid.
6. To study the effect of load on depression of a suitably clamped metre scale loaded at (i) its end (ii) in the middle.
7. To observe the decrease in pressure with increase in velocity of a fluid.

UNITS AND MEASUREMENT

Physical quantities:

All those quantities which can be measured directly or indirectly are called physical quantities.

Unit:

The unit is a standard quantity of the same kind with which a physical quantity is compared for measuring it. Fundamental units are all those units which are independent of any other unit.

Derived units are all those units which are obtained by multiplying and/or dividing one or more fundamental units.

Systems of Units:

A complete set of units which is used for measuring all kinds of physical quantities. They are CGS, FPS, MKS and SI unit systems.

SI Units – Fundamental Units

S.No	Physical quantity	SI Unit	Symbol
1	Mass	kilogram	kg
2	Length	metre	m
3	Time	second	s
4	Electric current	ampere	A
5	Temperature	kelvin	K
6	Luminous intensity	candela	Cd
7	Amount of substance	mole	mol

Supplementary Units

1	Plane angle	radian	rad
2	Solid angle	steradian	sr

Significant figures:

Significant figures in the measured value of a physical quantity is the sum of the reliable digits and the first uncertain digit.

Significant figures in the product, quotient, sum or difference of two numbers should be reported with same number of decimal places as that of the number with minimum number of decimal places.

Dimensions

The dimensions of a physical quantity are the powers (or exponents) to which the base quantities are raised to represent that quantity.

Dimensional equations are the equations, which represent the dimensions of a physical quantity in terms of the base quantities. For example, the dimensional equations of speed $[v]$, force $[F]$ and density $[\rho]$ are expressed as, $[v] = [M^0L^1T^{-1}]$ $[F] = [M^1L^1T^{-2}]$ $[\rho] = [ML^3T^0]$

Principle of homogeneity of dimensions: A physical equation will be correct if the dimensions of all the terms occurring on both sides of the equation are the same.

Applications of dimensional analysis:

1. To check the correctness of a physical equation.
2. To derive the relationship between different physical quantities.
3. To convert a physical quantity from one system of units to other.

Limitations of dimensional analysis:

1. Dimensionless constants cannot be obtained by this method.
2. It fails when the physical quantity is the sum or difference of two or more quantities
3. It does not distinguish between the physical quantities having same dimensions.
4. It fails to derive the relationships which involve trigonometric, logarithmic or exponential functions

I. MULTIPLE CHOICE QUESTIONS:

- The base quantity among the following is,
a) Speed b) area c) length d) weight
- Which of the following is not the unit of time
a) second b) minute c) month d) light year
- The number of significant figures in the number 0.0028 is,
a) 2 b) 3 c) 4 d) 5
- Average distance of the Sun from the Earth
a) light year b) astronomical unit c) fermi d) parsec
- Dimensional analysis can be applied to
a) to check the correctness of a physical equation.
b) to derive the relationship between different physical quantities.
c) to convert a physical quantity from one system of units to other.
d) All of the above
- Which of the following is dimensionless
a) force/acceleration b) velocity/acceleration c) volume/area d) energy/work
- The pair of the quantities having the same dimensions is
a) displacement, velocity b) time, frequency c) wavelength, focal length d) force, acceleration
- The dimensions of universal gravitational constant is
a) $[M^{-1}L^3T^{-2}]$ b) $[M^1L^1T^{-2}]$ c) $[M^{-1}L^2T^{-2}]$ d) $[M^1L^{-1}T^{-1}]$
- Which of the following physical quantity has the dimensional formula $[M^1L^2T^{-3}]$
a) work b) power c) work d) impulse
- If $x = a + bt + ct^2$, where x is in metre and t in second, then what is the unit of 'c'?
a) m/s b) m/s^2 c) kgm/s d) m^2/s

II. ASSERTION -- REASON QUESTIONS

- Two statements are given-one labelled Assertion (A) and the other labelled Reason (R).
Select the correct answer to these questions from the codes (a), (b), (c) and (d) as given below.**
- a) Both A and R are true and R is the correct explanation of A**
b) Both A and R are true and R is NOT the correct explanation of A
c) A is true but R is false
d) A is false and R is also false

- ASSERTION: Radian is the SI unit of plane angle.
REASON : One radian is the angle subtended at the centre of the circle by an arc whose length is equal to the radius of the circle.
- ASSERTION: When we change the unit of measurement of a quantity, it's numerical value changes.
REASON : Smaller the unit of measurement smaller is its numerical value.
- ASSERTION: AU is much bigger than \AA
REASON : AU is astronomical unit and \AA is angstrom
- ASSERTION: Sum of 7.21, 12.141 and 0.0028 is 19.35
REASON : Significant figures in the sum or difference of two numbers should be reported with the same number of decimal places as that of the number with minimum number of decimal places.
- ASSERTION: Special functions such as trigonometric, logarithmic and exponential functions are notdimensionless
REASON : A pure number, ratio of similar physical quantities such as angle and refractive index has some dimensions.
- ASSERTION: The units of some physical quantities can be expressed as combination of the base units
REASON : We need large number of units for expressing the derived physical quantities.
- ASSERTION: Force cannot be added with pressure.
~~REASON~~ : The dimensions of force and pressure are different.

8. ASSERTION: Displacement of a harmonic oscillator is given by $y = A \sin(\omega t + \phi)$ which cannot be derived by dimensional analysis.
 REASON : Dimensionless constants cannot be obtained by this method.
9. ASSERTION: 16.4 cm, 0.164 m and 0.000164 km all have three significant figures.
 REASON : The number of significant figures does not depend on the system of units.
10. ASSERTION: π and e are dimensional constants.
 REASON : The constant quantities having dimensions are called dimensionless variables.

III. CASE STUDY QUESTIONS

1. MEASUREMENT

All engineering phenomena deal with definite and measured quantities and so depend on the making of the measurement. We must be clear and precise in making these measurements. To make a measurement, magnitude of the physical quantity (unknown) is compared.

The record of a measurement consists of three parts, i.e. the dimension of the quantity, the unit which represents a standard quantity and a number which is the ratio of the measured quantity to the standard quantity.

- (i) A device which is used for measurement of length to an accuracy of about 10^{-5} m is,
 (a) screw gauge (b) spherometer (c) vernier callipers (d) Either (a) or (b)
- (ii) The system of units which is at present internationally accepted for measurement is,
 (a) CGS (b) FPS (c) SI (d) MKS
- (iii) Very large and small distances are measured by,
 (a) direct methods (b) indirect methods (c) Neither (a) or (b) (d) Either (a) or (b)
- (iv) The responsibility of maintenance and improvement of physical standards in our country is taken care by the institution,
 (a) NPL (b) NCL (c) CSIR (d) CECRI

2. DIMENSIONS

The nature of a physical quantity is described by its dimensions. All the physical quantities represented by derived units can be expressed in terms of some combination of seven fundamental or base quantities. We shall call these base quantities as the seven dimensions of the physical world, which are denoted with square brackets []. Thus, length has the dimension [L], mass [M], time [T], electric current [A], thermodynamic temperature [K], luminous intensity [cd], and amount of substance [mol]. The dimensions of a physical quantity are the powers (or exponents) to which the base quantities are raised to represent that quantity. Note that using the square brackets [] round a quantity means that we are dealing with 'the dimensions of' the quantity. In mechanics, all the physical quantities can be written in terms of the dimensions [L], [M] and [T]. For example, the volume occupied by an object is expressed as the product of length, breadth and height, or three lengths. Hence the dimensions of volume are $[L] \times [L] \times [L] = [L^3]$.

- (i) Dimensional formula of surface tension
 (a) $[M^1L^0T^{-2}]$ (b) $[M^0L^1T^{-2}]$ (c) $[M^1L^1T^0]$ (d) $[M^1L^1T^{-2}]$
- (ii) Which of the following quantity is dimensionless
 (a) Area (b) Angle (c) velocity (d) force
- (iii) Which of the following equation is dimensionally not correct,
 (a) $\frac{1}{2}mv^2 = mgh$ (b) $v = u + at$ (c) $p = ma$ (d) $F = ma$
- (iv) The value of gravitational constant in CGS system is 6.67×10^{-8} dyne cm^2g^{-2} . The value of the same in SI unit system is,
 (a) 6.67×10^{-12} $\text{Nm}^2\text{kg}^{-2}$ (b) 6.67×10^{-11} $\text{dynem}^2\text{kg}^2$ (c) 6.67×10^{-11} $\text{Nm}^2\text{kg}^{-2}$ (d) 6.67×10^{-12} $\text{dynem}^2\text{kg}^2$

3. SIGNIFICANT FIGURES

Significant figures in the measured value of a physical quantity tell the number of digits in which we have confidence. Larger the number of significant figures obtained in a measurement, greater is the accuracy of measurement and vice-versa. In addition or subtraction, the number of decimal places in the result should equal

the smallest number of decimal places in any term in the operation.

In multiplication and division, the number of significant figures in the product or in the quotient is the same as the smallest number of significant figures in any of the terms.

With the help of the above comprehension, choose the most appropriate alternative for each of the following questions:

- (i) Add 3.8×10^{-6} to 4.2×10^{-5} with regard to significant figures.
(a) 4.6×10^{-5} (b) 4.6×10^{-6} (c) 4.58×10^{-5} (d) 4.580×10^{-5}
- (ii) Subtract 2.6×10^4 from 3.9×10^5 with regard to significant figures.
(a) 3.64×10^5 (b) 3.7×10^5 (c) 3.6×10^5 (d) 3.65×10^6
- (iii) The area enclosed by a circle of diameter 1.06 m with correct number of significant figures is,
(a) 0.88m^2 (b) 0.882m^2 (c) 1.88m^2 (d) 0.882026m^2
- (iv) The mass of a body is 275.32 g and its volume is 36.41 cm³. Express its density up to appropriate significant figures.
(a) 7.5616 gcm^{-3} (b) 7.56 gcm^{-3} (c) 7.6 gcm^{-3} (d) 7.562 gcm^{-3}

IV. SHORT ANSWER QUESTIONS (2 MARKS)

1. Name the different unit systems.
2. Name the supplementary base quantities along with their units and symbols.
3. Name the special units to measure very large and very small lengths.
4. Define dimensions of a physical quantity.
5. State the principle of homogeneity of dimensions.
6. Distinguish between dimensional variables dimensionless variables.
7. Distinguish between dimensional constants dimensionless constants.
8. Define the terms: i) light year ii) astronomical unit
9. Write the SI unit and dimensional formula of the following:
(i) Pressure (ii) power (iii) density (iv) angle
10. Check the correctness of the given equations by dimensional analysis
(i) $S = ut + \frac{1}{2} at^2$ (ii) $mgh = \frac{1}{2} mv^2$
11. The distance covered by a particle in time t is given by $X = a+bt+ct^2+dt^3$ find the dimensions of a,b,c and d.
12. Find the dimensions of axb in the equation $E = \frac{b-x^2}{at}$; where E is energy, x is distance and t is time.
13. Find the dimensions of a/b in the equation $P = \frac{a-t^2}{hx}$; where P is pressure, x is distance and t is time.
14. Convert 5J into ergs using dimensional analysis.
15. If the unit of force is 1kN, unit of length 1km and the unit of time is 100s, what will be the unit of mass?

V. SHORT ANSWER QUESTIONS (3 MARKS)

1. List the fundamental physical quantities in SI unit system along with their units.
2. List the practical units used to measure a) very small lengths and b) very large distances.
3. Check the following equation for dimensional consistency $h = \frac{2s \cos \theta}{r \rho g}$.
h= height, S = surface tension, ρ = density, r = radius and g = acceleration due to gravity.
4. The wave length λ associated with a moving electron depends on its mass m, velocity v and Plank's constant h. Prove dimensionally that $\lambda \propto h/mv$.
5. By the method of dimensions, obtain an expression for the centripetal force **F** acting on a particle of mass **m** moving with a velocity **v** in a circle of radius **r**. Take dimensionless constant **K** = 1.
6. Reynold number N_R (a dimensionless quantity) determines the condition of laminar flow of a viscous liquid through a pipe. N_R is a function of the density of the fluid 'ρ', its average speed 'v' and coefficient of viscosity 'η'. Given that N_R is also directly proportional to 'D' (the diameter of the pipe), show from dimensional considerations that $N_R = \frac{\rho v D}{\eta}$.

7. Derive by the method of dimensions, an expression for the volume of a liquid flowing out per second through a narrow pipe. Assume that the rate of flow of liquid depends on
- the coefficient of viscosity ' η '
 - the radius ' r ' of the pipe and
 - the pressure gradient (p/l) along the pipe. Take $K = \pi/8$.
8. The frequency ' ν ' of vibration of a stretched string depends upon:
- the length ' l ' of the string
 - its mass per unit length ' m ' and
 - the tension T in the string.
- Obtain dimensionally an expression for the frequency ' ν '
9. By the method of dimensions obtain an expression for the surface tension ' S ' of a liquid rising in a capillary tube. Assume that the surface tension depends upon mass m of the liquid, pressure P of the liquid and the radius ' r ' of the capillary tube.
10. The depth x to which a bullet penetrates a human body depends upon
- coefficient of elasticity ' η ' and
 - kinetic energy E_k
- by the method of dimensions show that: $x \propto [E_k / \eta]^{1/3}$.

VI. LONG ANSWER QUESTIONS (5 MARKS)

- What is a unit?
 - Name the unit system in practice at present all over the world?
 - What are fundamental and derived units?
 - List the fundamental units in SI unit system along with their symbols.
 - Write the SI units for the following physical quantities, angular velocity, Planck's constant
- What are significant figures? State the rules to determine the number of significant figures with examples.
- Define dimensional formula.
 - Give the uses of dimensional analysis.
 - Write down the limitations of dimensional analysis.

VII. NUMERICALS

- Deduce the dimensional formula for the following physical quantities:
Gravitational constant, Surface tension, coefficient of viscosity and Young's modulus.
 - Show that the angular momentum has the same dimensions as the Plank's constant h which is given by the relation $E = h\nu$
 - If the atmospheric pressure is 10^6 dyne cm^{-2} , find its value in SI units.
 - When 1m , 1kg and 1min are taken as the fundamental units, the magnitude of the force is 36 units. What will be the value of this force in CGS system?
 - Check by the method of dimensions whether the following equations are correct:
 - $E = mc^2$
 - $T = 2\pi \sqrt{l/g}$
 - State the number of significant figures in the following measurements:
 - 0.009m^2
 - 5.049 N/m^2
 - $1.80 \times 10^{11}\text{kg}$
 - 5.308 J
-

SCORING KEY

I. MULTIPLE CHOICE QUESTIONS

Qn.No	1	2	3	4	5	6	7	8	9	10
Answer	c	d	a	b	d	d	c	a	b	b

II. ASSERTION – REASON

Qn.No	1	2	3	4	5	6	7	8	9	10
Answer	b	c	c	a	d	c	a	b	a	d

III. CASE STUDY

Qn.No	i	ii	iii	iv
1	d	c	b	a
2	a	b	c	c
3	a	c	b	d

VI. NUMERICALS

Qn.No	ANSWER
1	$[G] = [M^1L^2T^{-3}]$, $[S] = [M^1L^0T^{-2}]$, $[\eta] = [M^1L^{-1}T^{-1}]$, $[Y] = [M^1L^{-1}T^{-2}]$
2	Hint: $L = mvr$, $h = E/v$
3	10^5 Nm^{-2}
4	10^3 dyne
5	Both are correct
6	(a)1 (b) 4 (c) 3 (d) 4

MOTION IN A STRAIGHT LINE

MOTION

An object is said to be in motion if its position changes with time”.

The concept of motion is a relative one and a body that may be in motion relative to one reference system, may be at rest relative to another.

There are two branches in physics that examine the motion of an object.

(i) Kinematics: It describes the motion of objects, without looking at the cause of the motion.

(ii) Dynamics: It relates the motion of objects to the forces which cause them.

Point Object

If the length covered by the objects are very large in comparison to the size of the objects, the objects are considered point objects.

Based on these, motion can be classified as:

(i) One dimensional motion. A particle moving along a straight-line or a path is said to undergo one dimensional motion. For example, motion of a train along a straight line, freely falling body under gravity etc.

(ii) Two dimensional motion. A particle moving in a plane is said to undergo two dimensional motion. For example, motion of a shell fired by a gun, carrom board coins etc.

(iii) Three dimensional motion. A particle moving in space is said to undergo three dimensional motion. For example, motion of a kite in sky, motion of aeroplane etc.

Displacement

Displacement of a particle in a given time is defined as the change in the position of particle in a particular direction during that time. It is given by a vector drawn from its initial position to its final position.

• Factors Distinguishing Displacement from Distance

—> Displacement has direction. Distance does not have direction.

—> The magnitude of displacement can be both positive and negative.

—> Distance is always positive. It never decreases with time.

—> $\text{Distance} \geq |\text{Displacement}|$

Uniform Speed and Uniform Velocity

Uniform Speed. An object is said to move with uniform speed if it covers equal distances in equal intervals of time, howsoever small these intervals of time may be.

Uniform Velocity. An object is said to move with uniform velocity if it covers equal displacements in equal intervals of time, howsoever small these intervals of time may be.

Variable Speed and Variable Velocity

Variable Speed. An object is said to move with variable speed if it covers unequal distances in equal intervals of time, howsoever small these intervals of time may be.

Variable Velocity. An object is said to move with variable velocity if it covers unequal displacements in equal intervals of time, howsoever small these intervals of time may be.

Average Speed and Average Velocity

Average Speed. It is the ratio of total path length traversed to the total time taken.

Instantaneous Speed and Instantaneous Velocity

“Instantaneous speed is the limit of the average speed as the time interval becomes infinitesimally small”.

Instantaneous velocity

“Instantaneous velocity or simply velocity is defined as the limit of the average velocity as the time interval Δt becomes infinitesimally small.”

$$v = \lim_{\Delta t \rightarrow 0} \frac{\Delta s}{\Delta t}$$

Uniform Acceleration

If an object undergoes equal changes in velocity in equal time intervals it is called uniform acceleration.

Average Acceleration.

It is the change in the velocity divided by the time-interval during which the change occurs.

Instantaneous Acceleration. It is defined as the limit of the average acceleration as the time-interval Δt goes to zero.

$$a = \lim_{\Delta t \rightarrow 0} \frac{\Delta v}{\Delta t}$$

Kinematical Graphs

The ‘displacement-time’ and the ‘velocity-time’ graphs of a particle are often used to provide us with a visual representation of the motion of a particle. The ‘shape’ of the graphs depends on the initial ‘coordinates’ and the ‘nature’ of the acceleration of the particle (Fig.)

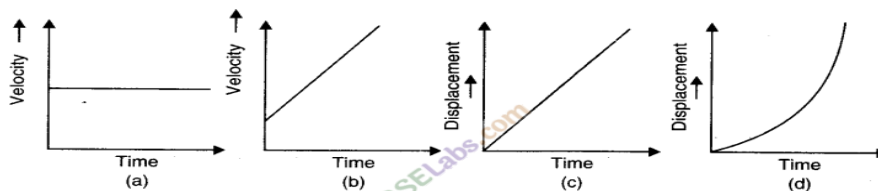

Fig. Curves (a) and (c) represent motion with a constant speed u . Curves (b) and (d) represent motion with a uniform acceleration a starting with an initial speed u .

the following general results are always valid

- (i) The slope of the displacement-time graph at any instant gives the speed of the particle at that instant.
- (ii) The slope of the velocity-time graph at any instant gives the magnitude of the acceleration of the particle at that instant.
- (iii) The area enclosed by the velocity-time graph, the time-axis and the two co-ordinates at time instants t_1 to t_2 gives the distance moved by the particle in the time-interval from t_1 to t_2 .

I. MULTIPLE CHOICE QUESTIONS

1. A bullet is dropped from the same height when another bullet is fired horizontally. They will hit the ground
(a) one after the other (b) simultaneously (c) depends on the observer (d) None of these
2. A particle is moving with a constant speed along a straight-line path. A force is not required to
(a) change its direction (b) decrease its speed
(c) keep it moving with uniform velocity (d) Increase its momentum
3. What is the ratio of the average acceleration during the intervals OA and AB in the velocity-time graph as

shown below?

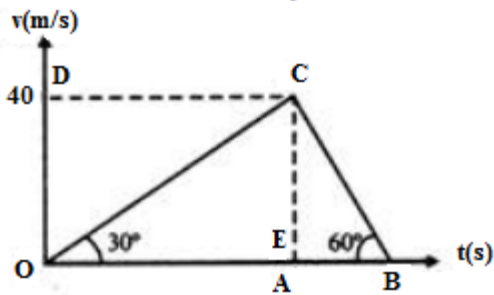

- (a) $\frac{1}{2}$ (b) $\frac{1}{3}$ (c) 1 (d) 3

4. For the motion with uniform velocity, the slope of the velocity-time graph is equal to
 (a) 1 m/s (b) Zero (c) Initial velocity (d) Final velocity
5. A spring with one end attached to a mass and the other to a rigid support is stretched and released.
 a. Magnitude of acceleration, when just released is maximum.
 b. Magnitude of acceleration, when at equilibrium position, is maximum.
 c. Speed is maximum when mass is at equilibrium position.
 d. Magnitude of displacement is always maximum whenever speed is minimum..
6. Which is the formula for motion in a straight line

- (a) $v = u + at$ (b) $v = u - at$ (c) $u = 2at + v$ (d) $v = 2at + u$

7. The point of intersection of three axes X, Y and Z is called as

- a) Origin O b) Reference point c) Both a and b d) None

Answers: 1 (b) 2 (b) 3 (b) 4(b) 5 (a and c) 6a 7 (a and b)

II. ASSERTION AND REASONING TYPE QUESTIONS

Here two statements are given- one labeled Assertion(A) and the other labeled as Reason(R). Select the correct answer to these questions from the codes (a), (b), (c) and (d) as given below:

- a) Both A and R are true and R is the correct explanation of A
 b) Both A and R are true and R is NOT the correct explanation of A
 c) A is true but R is false
 d) A is false and R is also false

1. Assertion: A particle having constant acceleration must always move on a straight line.
 Reason: When magnitude of acceleration is constant, then speed of particle may remain constant.
2. Assertion : Displacement of a body may be zero when distance travelled by it is not zero
 Reason : The displacement is the longest distance between initial and final position.
3. Assertion : The position-time graph of a uniform motion, in one dimension of a body cannot have negative slope.
 Reason : In one – dimensional motion the position does not reverse, so it cannot have a negative slope.
4. Assertion: For the uniform motion, the slope of position time graph will be constant.
 Reason: The slope of position time graph represent velocity of the object and for uniform motion it is constant

5. Assertion: A body having non zero acceleration can have a constant velocity.
Reason: Acceleration is the rate of change of velocity.
6. Assertion: The average speed of a body over a given interval of time is equal to the average velocity of the body in the same interval of time if a body moves in a straight line in one direction.
Reason: Because, in this case distance travelled by a body is equal to the displacement of the body.
7. Assertion: Position-time graph of a stationary object is a straight line parallel to the axis.
Reason: For a stationary object, position does not change with time.

Answer -	1 (d)	2 (c)	3(c)	4(a)	5(c)	6 (a)	7 (a)
-----------------	--------------	--------------	-------------	-------------	-------------	--------------	--------------

III. CASE BASED QUESTIONS

1. When an object moves along a straight line with uniform acceleration, it is possible to relate its velocity, acceleration during motion and the distance covered by it in a certain time interval by a set of equations known as the equations of motion. For convenience, a set of three such equations are given below:

$$v = u + at \quad s = ut + \frac{1}{2} at^2 \quad 2a s = v^2 - u^2$$

Where u is the initial velocity of the object which moves with uniform acceleration a for time t , v is the final velocity and s is the distance travelled by the object in time t .

- Equation of motions are applicable to motion with
 - uniform acceleration
 - constant velocity
 - non uniform acceleration
 - none of these
- The distance travelled by a body is directly proportional to the square of time taken its acceleration
 - increases
 - decreases
 - becomes zero
 - remains constant
- The brakes applied to a car produce an acceleration of 10 m/s^2 in the opposite direction to the motion. If the car takes 1 s to stop after the application of brakes, calculate the distance traveled during this time by car.
- An object is dropped from a tower falls with a constant acceleration of 10 m/s^2 . Find its speed 10 s after it was dropped.
- A bullet hits a target with a velocity of 10 m/s and penetrates it up to a distance of 5 cm . Find the deceleration of the bullet in the target

2. The average velocity tells us how fast an object has been moving over a given time interval but does not tell us how fast it moves at different instants of time during that interval. For this, we define instantaneous velocity or simply velocity v at an instant t . The velocity at an instant is defined as the limit of the average velocity as the time interval dt becomes infinitesimally small.

In other words $v = \text{Limit}_{\Delta t \rightarrow 0} \Delta s / \Delta t$, $v = ds/dt$

The variation in velocity with time for an object moving in a straight line can be represented by a velocity-time graph. In this graph, time is represented along the x -axis and the velocity is represented along the y -axis. The area enclosed by velocity-time graph and the time axis will be equal to the magnitude of the displacement and slope of velocity time graph represents acceleration of object.

Answer the following questions based on paragraph given.

- The area under velocity time graph gives
 - Displacement over given time interval
 - Velocity
 - Acceleration
 - None of these
- Slope of velocity time graph gives
 - Acceleration
 - Distance
 - Velocity
 - Displacement.

- iii) A body is thrown up. What will be velocity and acceleration at the top
 a) $v=0, a=-g$ b) $v=0, a=g$ c) $v = \text{maximum}, g=0$ d) $v=0, g=0$
- iv) Draw velocity time graph for an object, starting from rest. Acceleration is constant and positive.
- v) Is it possible to have negative value in speed and displacement?

Answer 1.	i)a	ii) d	iii) 5m	iv) 100m/s	v) -10m/s^2
2.	i)a	ii) a	iii) b		

IV. TWO MARK QUESTIONS

1. Define average velocity and average acceleration. And its formulas
2. A body thrown vertically upwards. Draw its i) velocity time graph ii) acceleration time graph
3. Define instantaneous acceleration and its formula
4. What are positive and negative acceleration in a straight line motion?
5. Can a body have zero velocity and still be accelerating? if yes give an example.
6. Give position time graph for one object moving with negative velocity, moving with positive velocity and at rest.
7. What is common between the two graphs shown in the fig. below



V. THREE MARK QUESTIONS

1. From a velocity time graph, Explain how do you calculate the average acceleration of a moving body
2. Draw the v-t graph for motions with constant acceleration.
 - a) Motion in positive direction with positive acceleration
 - b) Motion in negative direction with negative acceleration
 - c) Motion of an object with negative acceleration that changes direction. at time.
3. Define the following terms
 - i) Instantaneous acceleration
 - ii) Average acceleration
 - iii) Non uniform acceleration.
4. Draw the following graphs for an object under free fall
 - i) Variation of acceleration with respect to time
 - ii) variation of velocity with respect to time
 - iii) variation of distance with respect to time

VI. FIVE MARK QUESTIONS

1. Derive the second equation of motion by using velocity time graph with neat diagram.
2. Derive position velocity relation for uniformly accelerated motion from v-t graph.

VII. NUMERICALS

1. A body starts from point P and moves to Q. If the body returns to the same point(P), find i) displacement ii) distance iii) velocity iv) average speed

Ans i) zero ii) twice iii) zero iv) $v \text{ m/s}$

2. A man runs across the roof top of a tall building and jumps horizontally with the hope of landing on the roof top of the next building which is of lower height than the first. If his speed is 9m/s , the horizontal distance between the two buildings is 10m and the height difference is 9m , will he be able to land on the next building take $g = 10\text{m/s}^2$

Ans $x = 12.06x$, So he can able to land on next building

3. On a 60 km straight road, a bus travels the first 30km with uniform speed of 30km/hr. How fast must the bus travel the next 30km so as to have average speed of 40km/hr for the entire trip

Ans : 60km/hr

4. The acceleration of a particle is given by $a = 3t^2 + 2t + 2$, where time t is in second. If the particle starts with a velocity $v = 2\text{m/s}$ at $t = 0$, then find the velocity at the end of 2s.

Ans : 18m/s

5. A body covers 200cm in the first 2 seconds and 220cm in next 2 seconds. What will be its velocity at the end of 7 seconds? Also find the displacement in 7 seconds.

Ans 33.75m.

6. The velocity time graph of an object moving along a straight line is as shown

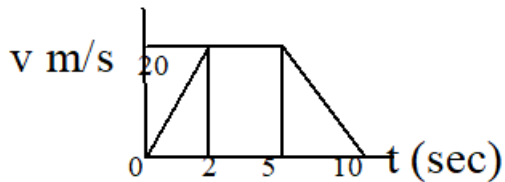

Calculate the distance covered by object between

i) $t = 0$ to $t = 5$ sec.

ii) $t = 0$ to $t = 10$ sec.

Ans i) 80m ii) 130m

MOTION IN A PLANE

Motion in a plane is called as motion in two dimensions e.g., projectile motion, circular motion etc. For the analysis of such motion our reference will be made of an origin and two co-ordinate axes X and Y.

Scalar and Vector Quantities

Scalar Quantities. The physical quantities which are completely specified by their magnitude or size alone are called scalar quantities.

Examples. Length, mass, density, speed, work, etc.

Vector Quantities. Vector quantities are those physical quantities which are characterised by both magnitude and direction.

Examples. Velocity, displacement, acceleration, force, momentum, torque etc.

Unit Vector

A unit vector is a vector of unit magnitude and points in a particular direction. It is used to specify the direction only. Unit vector is represented by putting a cap (^) over the quantity

A unit vector is a vector of unit magnitude and points in a particular direction. It is used to specify the direction only. Unit vector is represented by putting a cap (^) over the quantity.

The unit vector in the direction of \vec{A} is denoted by \hat{A} and defined by

$$\hat{A} = \frac{\vec{A}}{|\vec{A}|} = \frac{\vec{A}}{A} \text{ or } \vec{A} = A \hat{A}$$

Equal Vectors

Vectors \vec{A} and \vec{B} are said to be equal if $|\vec{A}| = |\vec{B}|$ as well as their directions are same.

Zero Vector

A vector with zero magnitude and an arbitrary direction is called a zero vector. It is represented by $\vec{0}$ and also known as null vector.

Coplanar Vectors

Vectors are said to be coplanar if they lie in the same plane or they are parallel to the same plane, otherwise they are said to be non-coplanar vectors.

Displacement Vector

Position Vector

Position vector is a vector to represent any position of a body. The straight line joining the origin and the point represents the position vector. It is represented by both magnitude and direction.

It is represented by $\vec{r} = \overline{OP} = x\hat{i} + y\hat{j}$ where \hat{i} and \hat{j} are the unit vectors along x and y axis respectively.

If position vector \vec{r} is in three dimensions, then it is given by $\vec{r} = x\hat{i} + y\hat{j} + z\hat{k}$ where, \hat{i} , \hat{j} and \hat{k} are the unit vectors along x, y and z co-ordinates respectively.

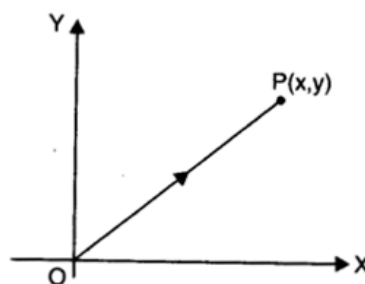

$$|\vec{r}| = \sqrt{x^2 + y^2 + z^2}$$

Multiplication of Vectors

(i) Scalar product (Dot product). Scalar product of two vectors is defined as the product of the magnitude of two vectors with cosine of smaller angle between them.

Displacement Vector

The displacement vector is a vector which gives the position of a point with reference to a point other than the origin of the co-ordinate system.

Displacement vector $\vec{r}_{12} = \vec{r}_2 - \vec{r}_1$.

Parallelogram Law of Vector Addition

If two vectors, acting simultaneously at a point, can be represented both in magnitude and direction by the two adjacent sides of a parallelogram drawn from a point, then the resultant is represented completely both in magnitude and direction by the diagonal of the parallelogram passing through that point.

If \vec{A} and \vec{B} be two adjacent sides of a parallelogram, inclined at angle θ , then the magnitude of resultant vector is given as

$$R = \sqrt{A^2 + B^2 + 2AB \cos \theta}$$

Direction of resultant \vec{R} . Let α be the angle made by resultant \vec{R} with vector \vec{A} . Then

$$\alpha = \tan^{-1} \frac{B \sin \theta}{A + B \cos \theta}$$

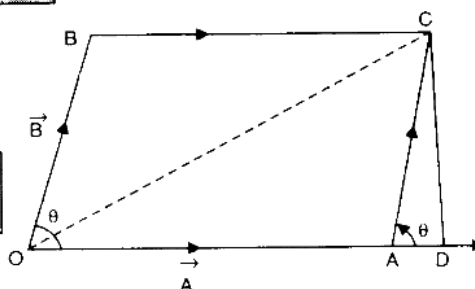

Resolution of Vectors

It is a process of splitting a single vector into two or more vectors in different directions which together produce the same effect as is produced by the single vector alone.

The vectors into which the given single vector is splitted are called component of vectors. In fact, the resolution of a vector is just opposite to composition of vectors.

(i) If a vector \vec{A} makes an angle θ with x -axis then magnitude of its rectangular components in x - y plane are given by $A_x = A \cos \theta$ and $A_y = A \sin \theta$, where,

$$A = \sqrt{A_x^2 + A_y^2}$$

(ii) If a vector \vec{A} lie in free space and subtends an angle α with x -axis, angle β with y -axis and angle γ with z -axis then the magnitudes of its rectangular components along the three axes are given as $A_x = A \cos \alpha$, $A_y = A \cos \beta$ and $A_z = A \cos \gamma$.

where
$$A = \sqrt{A_x^2 + A_y^2 + A_z^2}$$

(iii) A vector \vec{A} may be expressed in terms of its rectangular components as:

$$\vec{A} = A_x \hat{i} + A_y \hat{j} + A_z \hat{k}$$

where, \hat{i} , \hat{j} and \hat{k} are the unit vectors along x , y and z axis respectively.

Projectile Motion

The projectile is a general name given to an object that is given an initial inclined velocity and which subsequently follows a path determined by the gravitational force acting on it and by the frictional resistance of the air. The path followed by a projectile is called its trajectory.

Equation of projectile motion. The general case of projectile motion corresponds to that of an object that has been given an initial velocity u at some angle θ above (or below) the horizontal. The horizontal and vertical displacements x and y are given by

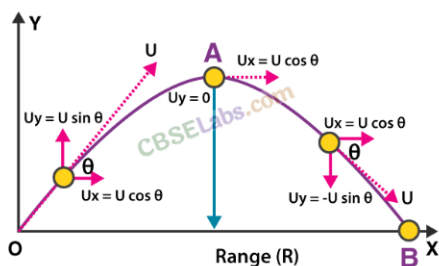

Maximum Height. The maximum vertical distance travelled by the projectile during its journey is called the maximum height attained by the projectile.

It is given by

$$H = \frac{u^2 \sin^2 \theta}{2g}$$

Projectile Given Horizontal Projection:

(i) Equation of path $y = kx^2$, which is a parabola

(ii) Time of flight $T = \sqrt{\frac{2h}{g}}$

(iii) Horizontal Range $R = u \sqrt{\frac{2h}{g}}$

(iv) Velocity at any time t is $v = \sqrt{u^2 + g^2 t^2}$ and angle made by resultant velocity with horizontal $\beta = \tan^{-1} \left(\frac{gt}{u} \right)$.

(v) Velocity of projectile when it hits the ground $v = \sqrt{u^2 + 2gh}$.

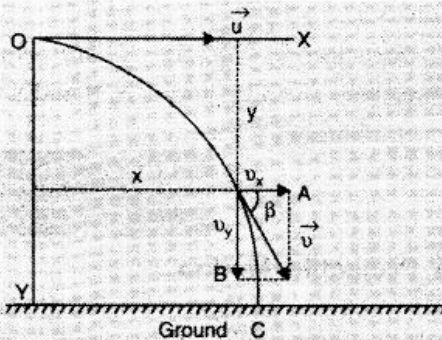

Angular Displacement Angular displacement of the object moving around a circular path is defined as the angle traced out by the radius vector at the centre of the circular path in a given time.

$$\theta \text{ (angle)} = \text{arc}/\text{radius}$$

$\theta \rightarrow$ the magnitude of angular displacement. It is expressed in radians (rad).

Angular Velocity

Angular velocity of an object in circular motion is defined as the time rate of change of its angular displacement.

Uniform Circular Motion

When a body moves in a circular path with a constant speed, then the motion of the body is known as uniform circular motion.

The time taken by the object to complete one revolution on its circular path is called time period. For circular motion, the number of revolutions completed per unit time is known as the frequency (ν). Unit of frequency is 1 Hertz (1 Hz). It is found that F acts inwards towards centre

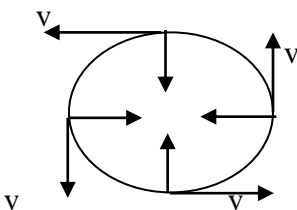

I. MULTIPLE CHOICE QUESTIONS

1. A vector quantity with both magnitude and direction obeys
 - a) triangle law addition
 - b) law of momentum
 - c) law of inertia
 - d) none
2. The angle of projection, for which the horizontal range and the maximum height of a projectile are equal, is:
 - (a) 45°
 - (b) $T = \tan^{-1}(0.25)$
 - (c) $T = \tan^{-1}(4)$
 - (d) none of these
3. Which of the following is the essential characteristic of a projectile?
 - (a) Zero velocity at the highest point
 - (b) Initial velocity inclined to the horizontal
 - (c) Constant acceleration perpendicular to the velocity
 - (d) None of these
4. The direction of the angular velocity vector is along
 - (a) the tangent to the circular path
 - (b) the outward radius
 - (c) the inward radius
 - (d) the axis of rotation

5. Which represents addition two vectors **A** and **B**.

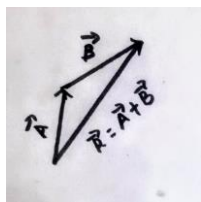
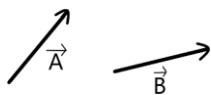

(a)

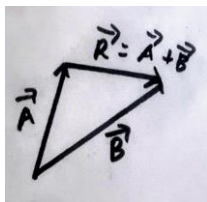

(b)

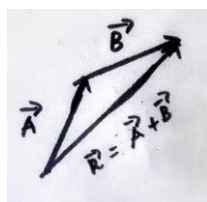

(c)

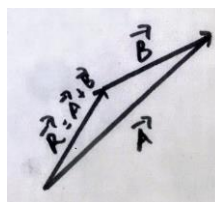

(d)

6. A particle moves in a plane with a constant acceleration in a direction different from the initial velocity. the path of the particle is a/an

- (a) ellipse (b) straight (c) arc of a circle (d) parabola

7. The time of flight of the projectile motion is given by

- a) $2u \cos \theta / g$ b) $u \sin \theta / g$ c) $2 u \sin \theta / g$ d) $4 \cos \theta / g$

Answers: 1(a) 2(c) 3(c) 4(a) 5(a) 6(d) 7(c)

II . ASSERTION AND REASONING TYPE QUESTIONS

Here two statements are given- one labeled Assertion(A) and the other labeled as Reason(R). Select the correct answer to these questions from the codes (a), (b), (c) and (d) as given below:

- a) Both A and R is true, and R is the correct explanation of the assertion.
 b) Both A and R is true, but R is not the correction explanation of the assertion.
 c) A is true, but R is false.
 d) A is false, R is also false.

1. Assertion: The scalar product of two vectors can be zero.

Reason: If two vectors are perpendicular to each other, their scalar product will be zero

2. Assertion: In the motion of projectile the horizontal component of velocity remains constant

Reason: The force on the projectile is gravitational force which acts only in vertically downwards direction.

3. Assertion: Horizontal range is same for angle of projection θ and $(90 - \theta)$.

Reason: Horizontal range is independent of angle of projection.

4. Assertion : A scalar quantity is one that is conserved in a process

Reason : Scalar quantity depends on direction

5. Assertion : If dot product and cross product of A and B are zero, it implies that one of the vector A and B must be Null vector

Reason : Null vector is a vector of zero magnitude

6. Assertion : If there were no gravitational force, the path of the projected body always be straight line

Reason: Gravitational force makes the path of projected body always parabolic

Answers: 1. (a) 2(a) 3(c) 4(d) 5(b) 6 (c)

III .CASE BASED QUESTIONS

1. Physical quantities which have a sense of direction are known as vectors. Resolution of a vector is the splitting of a single vector into two or more vectors in different directions which together produce a similar effect as is produced by a single vector itself. The vectors formed after splitting are called component vectors.

i) Vectors cannot be added algebraically. The statement is

- a) always true b) always false c) not always true d) None of the above

ii) A vector which has zero magnitude and arbitrary direction is known as ...

iii) The scalar product of two vectors $\vec{A} = 3\hat{i} - 4\hat{j} + 5\hat{k}$ and $\vec{B} = -2\hat{i} + \hat{j} - 3\hat{k}$ is

- a) 25 b) 35 c) -35 d) -25

iv) Resolve and name the components of u in the fig. given below

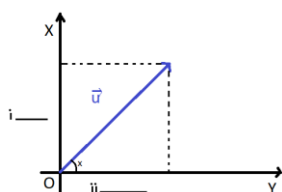

2. When an object follows a circular path at a constant speed, the motion of the object is called uniform circular motion. The word “uniform” refers to the speed, which is uniform (constant) throughout the motion. Suppose an object is moving with uniform speed v in a circle of radius R . Since the velocity of the object is changing continuously in direction, the object undergoes acceleration. Let us find the magnitude and the direction of this acceleration. Thus, the acceleration of an object moving with speed v in a circle of radius R has a magnitude v^2/R and is always directed towards the centre. This is why this acceleration is called centripetal acceleration (a term proposed by Newton).

i) SI unit of angular velocity is

- a) rev/sec b) m/s c) m/s^2 d) None of these

ii) A centripetal acceleration is not a constant vector. True or false?

- a) True b) False

iii) Name the physical quantity which remains same in an uniform circular motion

iv) Centripetal acceleration can be mathematically expressed as

- a) $a_c = \frac{\omega^2}{R}$ b) $a_c = \omega/R^2$ c) $a_c = R^2/\omega$ d) $a_c = \omega^2 R$

v) If both speed of a body and radius of the circular path are doubled, what will be the change in centripetal force ?

Answers: 1. i) c ii) null vector iii) -25 iv) $u \sin \theta$ and $u \cos \theta$

2. i) a ii) a iii) K.E and speed d iv) d v) doubled

IV .TWO MARK QUESTIONS

1. Under what condition, the resultant of two vectors will be equal to either of them.

2. Is circular motion possible at constant speed or at constant velocity ? Explain

3. Why the magnitude of the rectangular component of a vector can't be greater than the magnitude of vector itself. (Hint $A_x = A \cos \theta$)

4. A body is thrown with a velocity v from a tower of height H . After how much time and what distance from the base of the tower will the body strike the ground ? Ans $t = \sqrt{2H/g}$, $x = v\sqrt{2H/g}$

5. Obtain relation between angular velocity and linear velocity.

V .THREE MARK QUESTIONS

1. Prove that maximum horizontal range is four times the maximum height attained by the projectile.
2. Define uniform circular motion .Derive expression for centripetal acceleration.
3. Find the resultant vector of the summation of two vectors A and B having D between them.
4. If both the speed of a body and radius of its circular path are doubled, what will happen to centripetal acceleration?
5. A projectile is fired at an angle θ with the horizontal with velocity v .Derive the expression for maximum height attained by it.
6. If the time of flight of a projectile projected with velocity u at an angle θ is $(2u \sin \theta) / g$, write the condition for maximum range and find its expression.

VI .FIVE MARK QUESTIONS

- 1.State and prove parallelogram law of vector addition. Hence derive the expression for magnitude and direction of resultant vector.
- 2.What is projectile motion ? Prove that trajectory of projectile projected at an angle θ with the horizontal is a parabola. Hence derive its time of flight and horizontal range .

VII .NUMERICALS

- 1 If $|\vec{A} \times \vec{B}| = \vec{A} \cdot \vec{B}$ what is the angle between two vectors
2. Determine a unit vector which is perpendicular to both $\vec{A} = 2\hat{i} + \hat{j} + \hat{k}$ and $\vec{B} = \hat{i} - \hat{j} + 2\hat{k}$
- 3.A stone falls from a building that is descending at a uniform rate of 12m/s.The displacement of the stone from the point of release after 10 sec is
- 4.Find the direction for an umbrella when rain falls vertically with a speed 20m/sand the wind blows from east to west with a speed of 15m/s.
5. A cyclist starts from centre O of a circular park of radius 1km and moves along a path OPRQO as shown.If he maintains constant speed of 10m/s ,what is his acceleration at point R in magnitude and direction ?

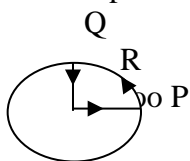

- 6.Two bodies are thrown with the same initial velocity at angle θ and $(90^\circ - \theta)$ to the horizontal.Determine the ratio of maximum heights reached by the bodies.
7. The sum of two forces acting at a point is 16N and their resultant force is 8N and its direction is perpendicular to a smaller force .Calculate the two forces.
8. An aeroplane travelling at a speed of 500km/hr tilts at an angle of 30° as it makes a turn.What is the radius of the curve?

Answers:

1. $\theta = 120^\circ$
2. $s = 610\text{m}$
3. $\theta = 37^\circ$
4. 0.1m/s^2 along RQO
5. $\tan^2\theta$
6. $A = 6\text{N}$ $B = 10\text{N}$
7. $r = 3.41 \times 10^3\text{m}$

LAWS OF MOTION

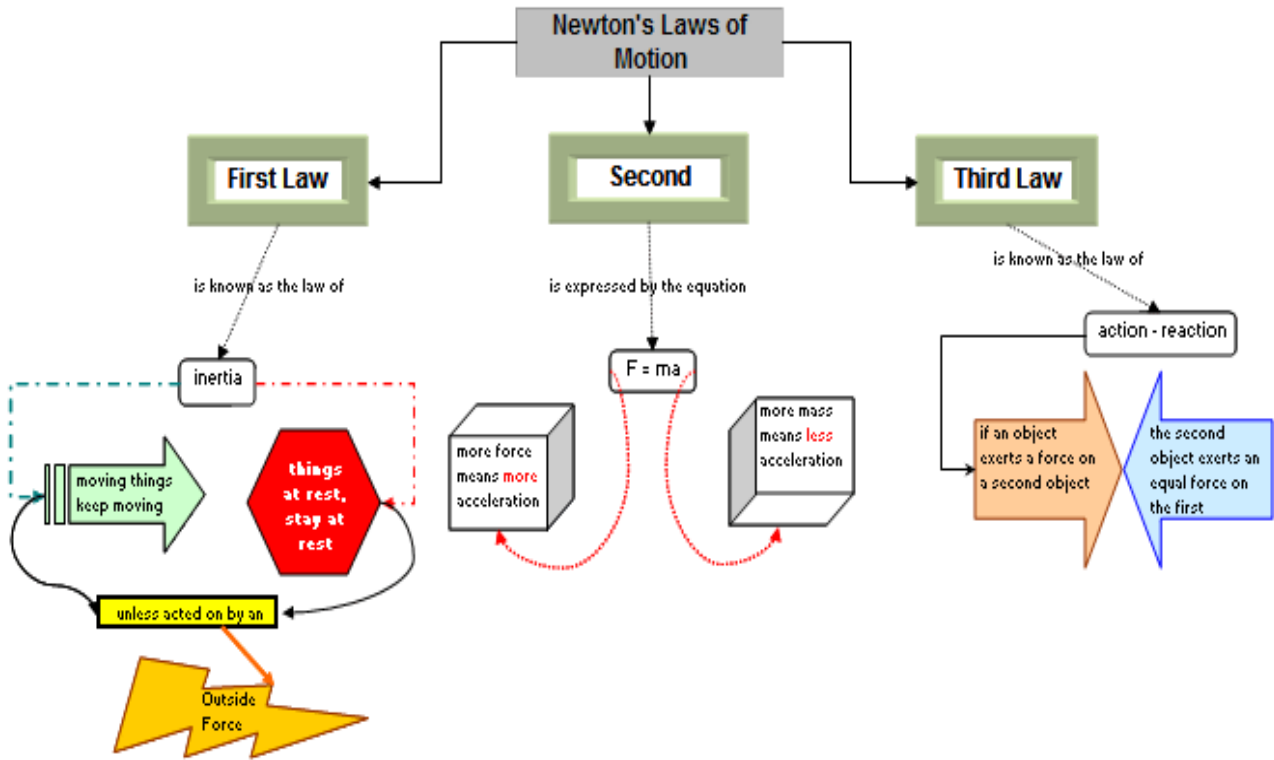

Force : It is an external agency which changes or tries to change the state of rest or motion of a body or the direction of motion of the body. It is a vector quantity. Its SI unit is newton (N).

Dimensionally $F = [MLT^{-2}]$.

Some important forces in nature are:

- (a) Gravitational force
- (b) Electrostatic force
- (c) Electromagnetic force
- (d) Interatomic or intermolecular forces
- (5) Nuclear force

Inertia: It is the property of a body by which it continues to be in state of rest or uniform motion along a straight path unless an external unbalanced force acts on the body. Inertia is of three types:

- (a) Inertia of rest
- (b) Inertia of motion
- (c) Inertia of direction

Inertia to linear motion is measured by the mass of the body. Larger the mass; greater is the inertia of the body i.e. it is more difficult to change the state of rest or uniform motion of the body.

In absence of friction between a passenger and the bus, the passenger will not move with the bus when it starts. As a result, he will hit the back of the bus (Inertia of rest).

Likewise, when the brakes are applied to the moving bus in above situation, the passenger will hit the front of the bus (Inertia of motion).

If the bus takes a turn to left, the passenger will be thrown towards right (Inertia of direction). This is because the directional inertia of the body of the passenger.

Linear Momentum: It is the quantity of motion present in a body. Mathematically, it is measured as product of mass and velocity v of the body.

Momentum $p = m v$

It is a vector in the direction of velocity. Its SI unit is $kg\ ms^{-1}$ or Ns . Dimensionally momentum is MLT^{-1} .

Newton's First Law of Motion

It states that everybody continues to be in a state of rest or uniform motion along a straight line unless an external unbalanced force is applied to change its state. The law gives qualitative definition of force.

Here the significance of the words external and unbalanced must be clearly understood. Internal forces are forces exerted on one another by the bodies making the system. The external forces are forces exerted on the system by everything else, except the system, known as surroundings. There is no overall motion of a system due to internal forces. For example, it is not possible to move a car by pushing it when we are sitting inside the car. The force in this case is internal force.

Similarly, an individual may not be able to move a loaded truck by pushing or pulling if. The force applied in this case is balanced by an equal and opposite force (or friction) which is apparently not visible.

Newton's Second Law of Motion

According to second law the rate of change of linear momentum of a body is directly proportional to the net external applied force. The change in momentum takes place in the direction of the force.

The law gives a relation between force and momentum. It also gives a quantitative definition or measure of the force.

Mathematically,

$$F = dp/dt = d/dt(mv) = m dv/dt \text{ (for a system with constant mass)}$$

$$F = ma$$

Where, $a = dv/dt$ is Instantaneous acceleration of body.

- For a constant mass and changing velocity, $F = m dv/dt$
- For constant velocity and changing mass, $F = v dm/dt$

Newton's Third Law of Motion:

It states: To every action, there is an equal and opposite reaction. Mathematically, $F_{BA} = (-)F_{AB}$

Where F_{BA} is force on B due to A and F_{AB} is force on A due to B.

The forces of action and reaction do not cancel each other because they act on different bodies.

Units of Force: Absolute unit of force in SI system is newton. $1N = 1 \text{ kg} \cdot \text{m/s}^2$

The gravitational unit of force in kg wt or kg f.

$$1 \text{ kg wt} = 1 \text{ kg f} = 9.8 \text{ kg m/s}^2 = 9.8N$$

Impulse of a Force: A large force acting for a small-time interval is said to impart an impulse to the object. The impulse of a force is numerically equal to the product of the force (F) applied and the time Δt for which it acts, i.e. Impulse = $F \Delta t$

- The impulse of a force is equal to the change in momentum of the body.

Impulse = Force \times Time = Change in momentum

- The change in momentum of a body is large if a larger force is applied or if the force is applied for a larger duration of time.
- Impulse is a vector quantity in the direction of force.
- Impulse $J = F \cdot t$; if force is constant
- $J = \int F \cdot dt$; if the force is variable
- $J = p_2 - p_1 = m(v - u)$
- Impulse of a force can also be measured as the area under the force time graph.

A large force acting for a short duration is called impulsive force (See figure). The shaded area gives the impulse of the force applied.

The SI Unit of impulse is $N\text{-s}$ or kg ms^{-1} .

Dimensionally impulse is MLT^{-1} .

- Impulse and momentum have same dimensional formula and same units

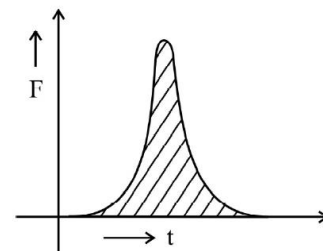

Apparent Weight of a Body in a Lift

In a lift at rest or in uniform motion (upwards or downwards) i.e. when $\mathbf{a} = 0$; the weight of a body is its true weight.

We have $\mathbf{R} = m\mathbf{g}$

When a lift moves upwards with uniform acceleration 'Q', apparent weight of a body in the lift increase.

We have $\mathbf{R} - m\mathbf{g} = m\mathbf{a}$

$\mathbf{R} = m(\mathbf{g} + \mathbf{a}) > m\mathbf{g}$

When a lift moves downwards with a uniform acceleration 'a'; apparent weight of a body is less than its actual weight.

From the figure: $\mathbf{F} + \mathbf{F}_{\text{fic}} = m\mathbf{a}$; $\mathbf{R} = m(\mathbf{g} - \mathbf{a}) < m\mathbf{g}$

In a lift falling freely, we have $\mathbf{a} = \mathbf{g}$

$\mathbf{R} = m(\mathbf{g} - \mathbf{g}) = 0$; The body experience weightlessness

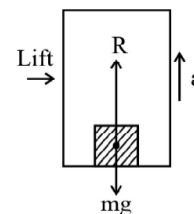

Note-When a person of mass m climbs up a rope suspended from a rigid support with acceleration 'a'; the tension in the rope is $\mathbf{T} = m(\mathbf{g} + \mathbf{a})$

When the person climbs down the rope with acceleration 'a'; the tension in the rope is $\mathbf{T} = m(\mathbf{g} - \mathbf{a})$.

If the rope supports the weight of the man (with man neither climbing up nor down); the tension in the rope equals his weight i.e. $\mathbf{T} = m\mathbf{g}$

Law of Conservation of Linear Momentum

According to this Law, the total linear momentum, of a given system, remains conserved if the net external force acting on this system is zero.

If $\mathbf{F}_{\text{ext}} = 0$, We have,

$\mathbf{p}_1 + \mathbf{p}_2 + \dots + \mathbf{p}_n = \text{a constant}$

or $m_1\mathbf{v}_1 + m_2\mathbf{v}_2 + \dots + m_n\mathbf{v}_n = \text{a constant}$

For a system of two bodies, undergoing a collision, we have,

$m_1\mathbf{u}_1 + m_2\mathbf{u}_2 = m_1\mathbf{v}_1 + m_2\mathbf{v}_2$

Let us apply this law to a bullet and the gun system. Here the system is at rest to start with.

Hence, when a bullet is fired from a gun we have,

Initial momentum = zero

So, Final momentum of the bullet & gun system must again be zero.

$m\mathbf{v} + M\mathbf{V} = 0$

Hence, Recoil velocity of the gun.

$\mathbf{V} = - (m/M) \mathbf{v}$

Concurrent Forces

The forces acting at the same point of a body are called concurrent forces.

Equilibrium of Concurrent Forces: For a number of concurrent forces acting on a body in equilibrium, the forces can be represented by a closed polygon taken in order or the resultant force is zero.

$\mathbf{F}_1 + \mathbf{F}_2 + \mathbf{F}_3 + \dots + \mathbf{F}_n = 0$

The Free Body Diagrams

A diagram for each body in a system indicating all the forces exerted on the body by the remaining parts of the system and the external agents is called free-body diagram.

In mechanics, we usually come across systems consisting of a number of bodies / particles under the action of a number of forces due to their mutual interaction; gravitational forces, frictional force, force due to strings, springs (called tension); supports etc.

Solution of such problems can be simplified by using the following steps:

1. Draw a diagram showing various parts of the system with links, supports etc.
2. Select any convenient part of the system.
3. Draw a separate diagram for the part selected above showing all the forces on it by the remaining parts of the system and also by external agents. This diagram is called the free body diagram.
4. Remember to include the information about the magnitude and direction of forces which are given

and which you are sure of. The remaining forces are treated as unknown. Use Newton's second law of motion to get an equation of motion for the chosen part i.e. equate the net force acting in a particular direction to the product of mass and acceleration of the body in that particular direction.

5. Follow the same procedure for any other part of the system to get more equations. You need as many independent equations to solve the problem as the number of unknowns.
6. Solve the equations obtained for different parts of the system to obtain the values of the desired unknowns or to get a desired equation.

Following points must be kept in mind while drawing the free body diagram (FBD)

- The reaction force (called normal reaction) always acts normal to the surface in contact or on which the body is placed. (See diagram below)

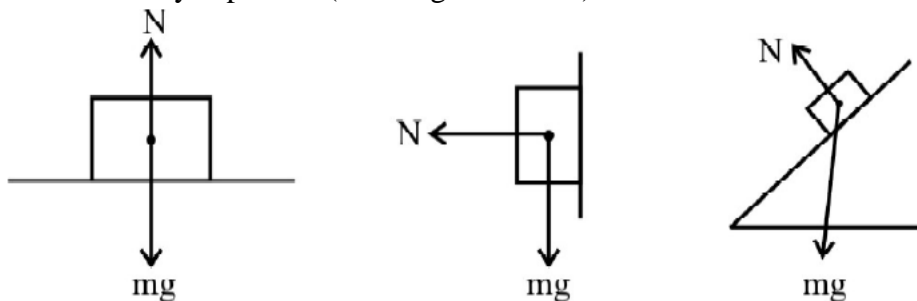

Tension in a string arises due to the restoring forces caused by intermolecular forces of interaction. It is the force exerted by one part of the string on the other part. The tension in each branch of the string must form action - reaction pair. It always acts towards the support (Hand / pulley).

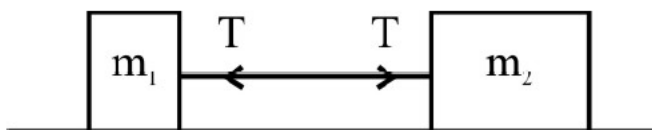

In the above system, tension on m_1 is towards m_2 and that on m_2 is towards m_1 .

- A pulley is used to change the direction of force to a more convenient direction. For a light (massless); frictionless pulley with an inextensible string passing over it without any kinks, the tension on either side of the string is the same.
- In a FBD; take into account all the forces acting on the body.

Inter Connected Bodies

(i) Bodies in Contact

When three masses m_1 ; m_2 and m_3 are placed in contact on a smooth horizontal surface and pushed with a force F applied on m_1 as shown, we have acceleration.

$$a = \frac{F}{m_1 + m_2 + m_3}$$

$$\text{Force on } m_1 = F_1 = F.$$

$$\text{We have acceleration } a = \frac{F}{m_1 + m_2 + m_3}$$

The weights are balanced by the normal reaction on the bodies.

$$\text{Force on } m_1 = F_1 = (m_1 + m_2 + m_3) a = F$$

$$\text{Force on } m_2 = F_2 = (m_2 + m_3) a$$

$$= \frac{(m_1 + m_2) F}{(m_1 + m_2 + m_3)}$$

$$\text{Force on } m_3 = F_3 = m_3 a$$

$$= \frac{m_3 F}{m_1 + m_2 + m_3}$$

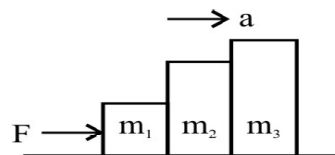

(ii) Inter Connected Bodies suspended from a Rigid support

When two masses m_1 and m_2 are suspended vertically from a rigid, non-yielding support using strings as shown and a pulling force F is applied to pull the mass m_2 down, we have

$$T_2 = F + m_2g$$

$$\text{and } T_1 = F + (m_1 + m_2)g$$

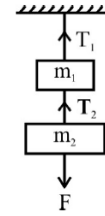

(iii) For two interconnected bodies with a rope passing over a smooth support or smooth light pulley;

$$a = \frac{(m_2 - m_1)g}{(m_1 + m_2)}$$

$$T = \frac{2m_1m_2g}{m_1 + m_2}$$

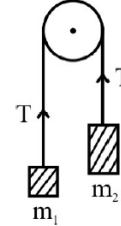

Note that $a < g$ for the system.

(iv) For two masses m_1 and m_2 attached to the ends of a string passing over a smooth pulley with mass m_2 on a smooth horizontal surface, we have.

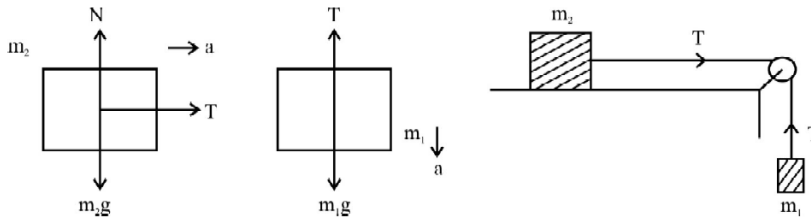

$$a = \frac{m_1g}{m_1 + m_2} \quad (< g)$$

$$T = \frac{m_1m_2}{m_1 + m_2} g$$

Equation of motion of m_1 in $m_2g - T = m_1a$

Equation of motion of m_2 is $T = m_2a$

(v) For a body on a smooth inclined plane, acceleration down the plane is given by

$$a = g \sin \theta$$

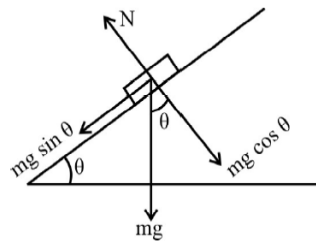

Friction:

Whenever a body moves or tends to move over the surface of another body, a force comes into play to opposes their relative motion. This force is known as force of friction. It opposes motion and acts parallel to the surface of contact of bodies.

Frictional force may sometimes act in the direction of motion of the body. The following examples illustrate the situations where the force of friction ‘acts’ in the direction of motion of the object.

For a man walking due north, the frictional force also acts due north.

In a bicycle; the driving forces are connected to the rear wheel. The direction of frictional force on the rear wheel at point of contact with the ground is in the direction of motion whereas that on the front wheel is opposite to the direction of motion.

Static Friction:

The force of friction which comes into play between two bodies before one object actually begins to move over the other is called static friction (f_s). Static friction is a self adjusting force (both in magnitude as well as direction). It is always equal and opposite to the applied force as long as there is no relative motion.

Limiting Friction:

The maximum force of static friction which comes into play when a body just starts moving over the surface of another body is called limiting friction or the maximum force of static friction f_s^{\max} . The force of friction never exceeds f_s^{\max} .

Kinetic Friction:

The force of friction which comes into play when a body is in motion over the surface of another body is called kinetic or dynamic friction. It is denoted by f_k and is less than limiting friction.

Laws of Limiting Friction

- (1) The force of limiting friction depends on the nature of the two surfaces in contact and their state of roughness.
- (2) The force of limiting friction acts tangential to the surfaces in contact and in a direction opposite to that of the applied force.
- (3) The force of limiting friction between any two surfaces is independent of the shape and the area of contact so long as the normal reaction remains unchanged.
- (4) The force of limiting friction between two given surfaces is directly proportional to the normal reaction between the surfaces.

f is directly proportional to N or $f = \mu_s N$; where μ_s is coefficient of limiting friction.

coefficient of limiting friction = Limiting Friction (f_s^{\max}) / Normal Reaction (N)

and coefficient of kinetic friction $\mu_k = f_k / N$

We have $\mu_k < \mu_s$ because f_k is always less than f_s^{\max} .

Angle of Friction

It is the angle which the resultant of the force of limiting friction and the normal reaction makes with the normal reaction.

$$\begin{aligned} \text{We have } \tan \theta &= \frac{f_s^{\max}}{N} \\ &= \mu_s \end{aligned}$$

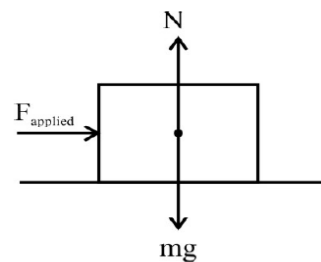
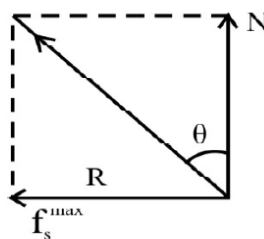

Angle of Repose

It is the minimum angle that an inclined plane makes with the horizontal when a body placed on it just begins to slide down the plane. Fig. shows forces acting on a body of mass m about to slide down the inclined plane.

$$\text{We have, } f_{ms} = mg \sin \phi$$

$$N = mg \cos \phi$$

$$\therefore \frac{f_{ms}}{N} = \mu_s = \tan \phi$$

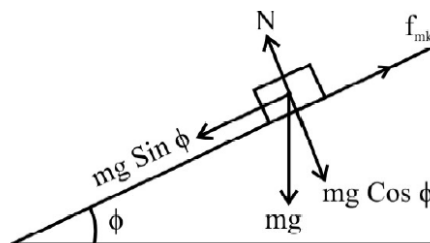

Body on Level Circular Road:

The friction between the tyres and the road provides the centripetal force.

We have,

$$Mv^2/r = \mu mg$$

$$\text{or } v = \sqrt{\mu rg}$$

which gives maximum safe speed of a vehicle on road for negotiating a curve of radius 'r'. (Without skidding).

Banking of Roads (Tracks):

Curved roads and tracks are banked to reduce the role of friction for providing centripetal force on curves. For a track / road of radius 'r' banked at an angle θ ; the maximum safe speed at which a vehicle can negotiate a curve is given by

$$v = \sqrt{gr \tan \theta}$$

The above max safe speed does not take into account the friction between the tyres and the road.

If the force of friction is also taken into account; we have,

$$V = \sqrt{rg(\mu + \tan \theta) / (1 - \mu \tan \theta)}$$

Bending of a Cyclist:

In order to negotiate a circular turn of radius 'r' at a speed v; a cyclist must bend at an angle θ with the vertical such that $\tan \theta = v^2 / rg$

I. MULTIPLE CHOICE QUESTIONS :

1. 'Net force acting on an object is found to be zero.' It can be inferred that the object
 - a) May be at rest
 - b) May be in uniform motion
 - c) May be in uniformly accelerated motion
 - d) Both a) & b)
2. Inertia is the property of a body linked to tendency of a body
 - (a) to change its position
 - (b) to change its direction
 - (c) to change the momentum
 - (d) to resist any change in its state
3. Newton's first law of motion describes the
 - (a) energy
 - (b) work
 - (c) inertia
 - (d) moment of inertia
4. A ball is travelling with uniform translatory motion. This means that
 - (a) it is at rest.
 - (b) the path can be a straight line or circular and the ball travels with uniform speed.
 - (c) all parts of the ball have the same velocity (magnitude and direction) and the velocity is constant.
 - (d) the centre of the ball moves with constant velocity and the ball spins about its centre uniformly.
5. According to Galileo's experiment for a double inclined plane, if slope of second plane is zero and planes are smooth, then a ball is released from rest on one of the planes rolls down and move on the second plane ...X... distance. Here, X is
 - (a) zero
 - (b) infinite
 - (c) equal to length of first plane
 - (d) None of these
6. No force is required for
 - (a) an object moving in straight line with constant velocity
 - (b) an object moving in circular motion
 - (c) an object moving with constant acceleration
 - (d) an object moving in elliptical path.
7. Impulse equals
 - (a) rate of change of momentum
 - (b) change in momentum
 - (c) momentum multiplied by time
 - (d) rate of change of force

8. The direction of impulse is
(a) same as that of the net force (b) opposite to that of the net force
(c) same as that of the final velocity (d) same as that of the initial velocity
9. China wares are wrapped in straw of paper before packing. This is the application of concept of
(a) impulse (b) momentum (c) acceleration (d) mass
10. Which one of the following is not a force?
(a) Impulse (b) Tension (c) Thrust (d) Air resistance
11. If the net external force on a body is ...X..., its acceleration is zero. Acceleration can be ...Y... only, if there is a net external force on the body. Here, X and Y refer to
(a) zero, zero (b) zero, non-zero (c) non-zero, zero (d) non-zero, non-zero
12. The same change in momentum in ...X... time needs ...Y... force applied. Here, X and Y refer to
(a) longer, lesser (b) shorter, greater (c) both (a) and (b) (d) longer, greater
13. Newton's second and third laws of motion lead to the conservation of
(a) linear momentum (b) angular momentum
(c) potential energy (d) kinetic energy
14. A cannon after firing recoils due to
(a) conservation of energy (b) Newton's second law of motion
(c) Newton's third law of motion (d) Newton's first law of motion
15. Identify the correct statement.
(a) Static friction depends on the area of contact
(b) Kinetic friction depends on the area of contact
(c) Coefficient of kinetic friction does not depend on the surfaces in contact
(d) Coefficient of kinetic friction is less than the coefficient of static friction
16. Frictional force that opposes relative motion between surfaces in contact is called
(a) static friction (b) kinetic friction (c) kinetic friction (d) static friction
17. The coefficient of static friction between two surfaces depends upon
(a) the normal reaction (b) the shape of the surface in contact
(c) the area of contact (d) None of the these
18. If μ_s , μ_k and μ_r are coefficients of static friction, kinetic friction and rolling friction, then
(a) $\mu_s < \mu_k < \mu_r$ (b) $\mu_k < \mu_r < \mu_s$ (c) $\mu_r < \mu_k < \mu_s$ (d) $\mu_r = \mu_k = \mu_s$
19. It is difficult to move a cycle with brakes on because
(a) rolling friction opposes motion on road
(b) sliding friction opposes motion on road
(c) rolling friction is more than sliding friction
(d) sliding friction is more than rolling friction
20. Which of the following statements about friction is true?
(a) Friction can be reduced to zero
(b) Frictional force cannot accelerate a body
(c) Frictional force is proportional to the area of contact between the two surfaces
(d) Kinetic friction is always greater than rolling friction
21. When a car moves on a level road, then the centripetal force required for circular motion is provided by ____
(a) weight of the car (b) normal reaction
(c) component of friction between the road & tyres along the surface. (d) All of these

22. On a banked road, which force is essential to provide the necessary centripetal force to a car to take a turn while driving at the optimum speed?
- (a) Component of normal reaction (b) Component of frictional force
(c) Both (a) & (b) (d) None of these
23. A particle revolves round a circular path. The acceleration of the particle is inversely proportional to
- (a) radius (b) velocity (c) mass of particle (d) both (b) and (c).
24. A cyclist taking turn bends inwards while a car passenger taking the same turn is thrown outwards. The reason is
- (a) car is heavier than cycle
(b) car has four wheels while cycle has only two
(c) difference in the speed of the two
(d) cyclist has to counteract the centrifugal force while in the case of car only the passenger is thrown by this force
25. A cyclist bends while taking turn in order to
- (a) reduce friction (b) provide required centripetal force
(c) reduce apparent weight (d) reduce speed
26. Which of the following is a self- adjusting force?
- (a) Static friction (b) Rolling friction (c) sliding friction (d) Dynamic friction
27. A constant force acts on a body of mass 5 kg and changes its speed from 5m/s to 10 m/s in 10 seconds, without changing the direction of motion. The force acting on the body is
- (a) 1.5 N (b) 2N (c) 2.5 N (d) 5 N
28. One end of a string of length l is connected to a particle of mass m and the other to a small peg on a smooth horizontal table. If the particle moves in a circle with speed v , the net force on the particle is
- (a) T (b) $T - mv^2/l$ (c) $T + mv^2/l$ (d) 0
29. A body subjected to three concurrent forces is found to be in equilibrium. The resultant of any two forces
- (a) is equal to third force (b) is opposite to third force
(c) is collinear with the third force (d) All of these
30. The mass of bicycle rider along with the bicycle is 100 kg. He wants to cross over a circular turn of radius 100m with a speed of 10 m/s. If the coefficient of friction between the tyres and the road is 0.6, the frictional force required by the rider to cross the turn is
- (a) 300 N (b) 600 N (c) 1200 N (d) 150 N

ANSWER KEY[MCQS SECTION]

1.d	2.d	3.c	4.c	5.b	6.a	7.b	8.a	9.a	10.a	11.b	12.c	13.a	14.c
15.d	16.c	17.a	18.c	19.d	20.d	21.c	22.a	23.a	24.d	25.b	26.a		
27.c	28.a	29.d	30.b										

II .ASSERTION-REASON TYPE QUESTIONS:

Directions : Each of these questions contain two statements, Assertion and Reason. Each of these questions also has four

alternative choices, only one of which is the correct answer. You have to select one of the codes (a), (b), (c) and (d) given below.

(a) Assertion is correct, reason is correct; reason is a correct explanation for assertion.

(b) Assertion is correct, reason is correct; reason is not a correct explanation for assertion

(c) Assertion is correct, reason is incorrect

(d) Assertion is incorrect, reason is correct.

1. **Assertion :** Mass is a measure of inertia of the body in linear motion.
Reason : Greater the mass, greater is the force required to change its state of rest or of uniform motion.
 2. **Assertion :** If the net external force on the body is zero, then its acceleration is zero.
Reason : Acceleration does not depend on force.
 3. **Assertion :** Impulse of force and momentum are same physical quantities.
Reason : Both quantities have same unit.
 4. **Assertion:** A cricketer moves his hands forward to catch a ball so as to catch it easily without hurting.
Reason: He tries to decrease the distance travelled by the ball so that it hurts less.
 5. **Assertion:** Same force applied for the same time causes the same change in momentum for different bodies
Reason: The total momentum of an isolated system of interacting bodies remains conserved.
 6. **Assertion :** A rocket works on the principle of conservation of linear momentum.
Reason : Whenever there is change in momentum of one body, the same change occurs in the momentum of the second body of the same system but in the opposite direction.
 7. **Assertion :** A block placed on a table is at rest, because action force cancels the reaction force on the block.
Assertion : The net force on the block is zero.
 8. **Assertion :** On a rainy day, it is difficult to stop a moving car or bus at high speed.
Reason : The value of coefficient of friction is lowered due to wetting of the surface.
 9. **Assertion:** Friction is a necessary evil
Reason: Though friction dissipates power, but without friction we cannot walk.
 10. **Assertion:** There is a stage when frictional force is not needed at all to provide the necessary centripetal force on a banked road.
Reason: On a banked road, due to its inclination the vehicle tends to remain inwards without any chances of skidding.
 11. **Assertion :** Linear momentum of a body changes even when it is moving uniformly in a circle.
Reason : In uniform circular motion, velocity remains constant.
 12. **Assertion :** No external force is required to keep a body in uniform motion.
Reason : If the net external force is zero, a body at rest continues to remain at rest and the body in motion continues to move with a uniform velocity.
 13. **Assertion:** It is difficult to move a cycle along the road with brakes on.
Reason: Sliding friction is greater than rolling friction.
 14. **Assertion:** The apparent weight of a body in an elevator moving with some downward acceleration is less than the actual weight of the body.
Reason: The part of the weight of the body is spent in producing downward acceleration, when body is in elevator.
 15. **Assertion:** A horse has to pull the cart harder during first few steps of his motion.
Reason: The first few steps are always difficult.
-

16. Assertion : Use of ball-bearing between two moving parts of a machine is common practice.

Reason: Ball bearing reduces vibrations and provides good stability.

ANSWER KEY [ASSERTION-REASON SECTION]

1.a 2.c 3.d 4.d 5.b 6.a 7.d 8.a 9.a 10.c 11.c 12.a 13.a 14.a
15.c 16.c

III . CASE STUDY BASED QUESTIONS

1. **Friction** between any two surfaces in contact is the force that opposes the relative motion between them. The force of limiting friction (F) between any two surfaces in contact is directly proportional to the normal reaction (R) between them i.e., $F \propto R$ or $F = \mu_s R$, where μ_s is coefficient of limiting friction, then $\mu_s = \tan \theta$

With the help of above comprehension, choose the most appropriate alternative for each of the following questions:

1. A force of 49N is just able to move a block of wood weighing 10kg on a rough horizontal surface. The coefficient of friction is

- (a) 0.5 (b) 4.9 (c) 10/49 (d) 49/9.8

2. The angle of friction in the above question is

- (a) $34^{\circ}26'$ (b) 30° (c) $26^{\circ}34'$ (d) 45°

3. A horizontal force of 1.2kg is applied on a 1.5 kg block, which rests on a horizontal surface. If the coefficient of friction is 0.3, force of friction is

- (a) 0.45 kg f (b) 1.2kg f (c) 1.5kg f (d) 0.3kg f

4. The acceleration produced in the block in the above question is

- (a) 9.8m/s^2 (b) 0.3m/s^2 (c) 1.5m/s^2 (d) 4.9m/s^2

2. **According to Newton's second law of motion**, $F = m \cdot a$, where F is the force required to produce an acceleration a in a body of mass m. If $a = 0$ then $F = 0$, i.e., no external force is required to move a body uniformly along a straight line. If a force F acts on a body for t seconds, the effect of the force is given by impulse = $F \times \Delta t =$ change in linear momentum of the body.

1. A cricket ball of mass 150g is moving with a velocity of 12m/s and is hit by a bat so that the ball is turned back with a velocity of 20m/s. If duration of contact between the ball and the bat is 0.01 sec. The impulse of the force is

- (a) 7.4Ns (b) 1.2Ns (c) 4.8Ns (d) 4.7Ns

2. Average force exerted by the bat is

- (a) 480N (b) 120N (c) 1200N (d) 840N

3. The retardation of the ball is

- (a) 1600m/s^2 (b) 320m/s^2 (c) 3200m/s^2 (d) 160m/s^2

4. An impulsive force of 100N acts on a body for 1s. What is the change in its linear momentum?

- (a) 10Ns (b) 100Ns (c) 1000Ns (d) 1Ns

3 .BANKING OF ROADS

The maximum permissible velocity with which a vehicle can go round a level curved road without skidding depends on μ , the coefficient of friction between the tyres and the road. The value of μ decreases when road is smooth or tyres of the vehicle are worn out or the road is wet and so on. Thus force of friction is not a reliable source for providing the required centripetal force to the vehicle. A safer course of action would be to do the 'banking' of such roads.

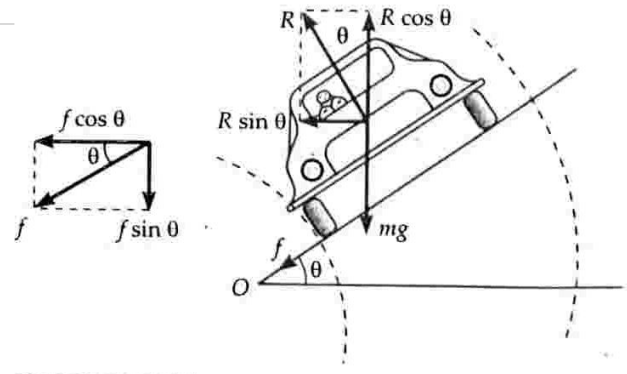

- The phenomenon of raisingof the curved road above the inner edge is called banking of roads
 (a) Inner edge (b)Centre (c)Outer edge (d)None of these
- Normal reaction R of the banked road acts
 (a) Along the surface of contact (b)Opposite to the weight w
 (c) Perpendicular to the surface of contact (d)Any arbitrary direction
- Centripetal force in case of a car moving on a banked circular road is provided by the following components of various forces
 (a) $R \sin\theta, f \cos\theta$ (b) $R \cos\theta, f \sin\theta$ (c) R, f (d) R, weight
- The speed at which a banked road can be rounded even when there is no friction
 (a). $(rg / \tan \theta)^{1/2}$ (b) $(rg \tan \theta)^{1/2}$ (c)Zero (d)Infinity
- A circular race track of radius 300m is banked at an angle of 15degrees. If the co-efficient of friction between wheels and the road is 0.2, what is the optimum speed of the race car to avoid wear and tear on its tyres
 (a) . $10\sqrt{(30 \tan 15)}$ m/s (b) $10\sqrt{(30 / \tan 15)}$ m/s (c) 300m/s (d)15m/s

ANSWER-KEY[Case Study Based Questions]

- | | | | | | |
|------|-----|-----|-----|-----|-----|
| I) | 1.A | 2.c | 3.a | 4.d | |
| II) | 1.b | 2.a | 3.c | 4.b | |
| III) | 1.c | 2.c | 3.a | 4.b | 5.a |

IV .TWO MARK QUESTIONS:

- Name the physical quantity which gives a measure of quantity of motion contained in a moving body. Also draw the graph showing the variation of this physical quantity with velocity for an object with constant mass.
- Give two important applications of Newton's second law.
- What do you understand by impulse? Use it to explain why does a cricket player lower his hands while catching a ball?
- State and explain Newton's third law. Identify the action-reaction pairs in case of firing of a gun.
- Comment on -"Newton's first law is contained in Second law".
- State the law of conservation of linear momentum and derive it by using Newton's second law.
- Derive an expression to show that the recoil velocity of gun is directly proportional to the velocity of the bullet.
- A balloon with mass M is descending down with an acceleration a, where $a < g$. What mass m of its contents must be removed so that it starts moving up with acceleration a? [Ans: $2Ma/(g+a)$]

9. What are concurrent forces? Write the condition under which the body will be said to be in equilibrium.
10. Two masses M and m are connected at the two ends of an inextensible string. The string passes over a frictionless pulley. Calculate the acceleration of the masses.
11. What is friction. A heavy box is kept (at rest) on a table. Will there be friction in the given case, if yes, name the type of the friction involved here.
12. Explain why the static friction is called as self-adjusting force.
13. Using the knowledge of different types of friction, draw a plot to show the variation of force of friction with the applied force.
14. A physical quantity X is obtained when limiting friction is numerically divided by the normal reaction. Identify the quantity X and write its SI unit.
15. Define angle of Repose and hence deduce its relation with co-efficient of static friction.
16. The distance travelled by a moving body is directly proportional to time. Is any external force acting on it?

V .THREE MARK QUESTIONS:

1. A vehicle is moving on a horizontal road with speed v . If the coefficient of friction between the tyres and the road is μ , show that the shortest distance in which the vehicle can be stopped is $v^2/2\mu g$.
2. Find the expression for the work done against friction when a body is made to slide up an inclined plane.
3. By giving three advantages and disadvantages, show that the friction is a necessary evil.
4. Why is it easier to pull a roller than to push it? Explain.
5. Explain why (i) China wares are wrapped in straw papers before packing (ii) shockers are used in vehicles.
6. Why does a cyclist lean inward when moving along a curved path. Determine the angle through which the cyclist bends from the vertical to negotiate a curve.
7. A horse has to apply more force to start a cart than to keep it moving explain.

VI .THREE MARK QUESTIONS:

1. What is meant by banking of roads? Explain the need for it. Obtain an expression for the maximum speed with which a vehicle can safely negotiate a curved road banked at angle θ . The coefficient of friction between road and wheels is μ .
2. (i) Find the expression for the recoil velocity of a gun.
(ii) A person of mass m is standing in a lift. Write expression for his apparent weight when the lift is
(a) moving upward with uniform acceleration 'a' (b) moving downward with uniform acceleration 'a' ($a < g$) and (c) falls freely.

VII . NUMERICALS

1. Forces of $5\sqrt{2}N$ and $6\sqrt{2}N$ are acting on a body of mass $1000kg$ at an angle 60° to each other. Find the acceleration and distance covered of the mass after $10s$.
[Ans: $0.01349m/s^2$; $0.6745m$]
2. A body of mass m moves along X-axis such that its position coordinate at any instant t is $x=at^4-bt^3+ct$; where a,b,c are constants. What is the force acting on the particle at any time t .
3. A bullet of mass $100g$ moving with $20m/s$ strikes a wooden plank and penetrates upto $20cm$. calculate the resistance (reaction force) offered by the wooden plank. [Ans: $100N$]
4. A batsman hits back a ball straight in the direction of bowler without changing its initial speed of $12m/s$. If the mass of the ball is $0.15kg$, determine the impulse imparted to the ball (assuming linear motion).
[Ans: $-3.6Ns$]
5. A ball moving with a momentum p strikes against a wall at an angle of 45° and is reflected at the same angle. Calculate the change in momentum. [Ans: $-2p \cos 45^\circ$]
6. The velocity of a $2 kg$ object initially moving at $(-2i+3j-5k) m/s$ changes to $(i+3j+4k) m/s$ after $3 s$. Calculate the magnitude of force acting on the body. [Ans: $2\sqrt{10}N$]
7. A force of $49N$ is just sufficient to pull a block of wood weighing $10kg$ on a rough horizontal surface. Calculate the coefficient of friction and angle of friction. [Ans: 0.5 ; 26°]

8. A block slides down an incline of 30degree with an acceleration equal to $g/4$. Find the coefficient of kinetic friction. [Ans: $1/(2\sqrt{3})$]
9. Find the maximum speed at which a car can take turn round a curve of 30m radius on a level road, if the coefficient of friction between tyres and road is 0.4. [Ans: 11m/s]
10. For traffic moving at 60kmph, what should be the correct angle of banking of the road if the radius of the curve is 0.1km. [Ans: 15.5 degrees]
11. 6. An object of mass 3 kg is at rest. Now a force of $F = 6t^2i + 4tj$ is applied on the object. Calculate the velocity of object at $t = 3s$. [Ans: $18i+6j$]
12. A body of mass M hits normally a rigid wall with velocity V and bounces back with the same velocity. The impulse experienced by the body is..... [Ans: 2MV]
13. One end of string of length l is connected to a particle of mass m and the other end is connected to a small peg on a smooth horizontal table. If the particle moves in circle with speed v, what will be the net force on the particle (directed towards centre;T represents the tension in the string). [Ans: T]
14. A person of mass 60 kg is inside a lift of mass 940 kg and presses the button on control panel. The lift starts moving upwards with an acceleration 1.0 m/s^2 . If $g = 10 \text{ m/s}^2$, calculate the tension in the supporting cable. [Ans: 11000N]
15. A man weighs 80 kg. He stands on a weighing scale in a lift which is moving upwards with a uniform acceleration of 5 m/s^2 . What would be the reading on the scale ? ($g = 10 \text{ m/s}^2$) [Ans: 1200N]
16. A mass of 1 kg is suspended by a thread. It is (i) lifted up with an acceleration 4.9 m/s^2 (ii) lowered with an acceleration 4.9 m/s^2 . Find the ratio of the tensions. [Ans: 3:1]
17. A man standing on a weighing machine in a lift records his weight in the machine as under:
 - (i) w_1 when the lift acceleration upwards at 5 m/s^2
 - (ii) w_2 when the lift acceleration downwards at 5 m/s^2
 - (iii) w_3 when the lift moves up at 5 m/s
 - (iv) w_4 when the lift moves down at 5 m/s
 Write the correct relation between their relative values [Ans: $w_1 > (w_3 = w_4) > w_2$]

WORK ENERGY AND POWER

Work done by a constant force and a variable force;

The work done by the force is defined to be the product of the component of the force in the direction of the displacement and the magnitude of this displacement.

$$W = (F \cos\theta) d \\ = \mathbf{F} \cdot \mathbf{d}$$

We see that if there is no displacement, there is no work done even if the force is large. Thus, when you push hard against a rigid brick wall, the force you exert on the wall does no work.

Unit of Work

- SI unit of work is joule (J),
- CGS unit is erg.
- $1 \text{ J} = 10^7 \text{ erg}$

No work is done if

- The displacement is zero. (A weightlifter holding a 150 kg mass steadily on his shoulder for 30 s does no work on the load during this time).
- The force is zero. (A block moving on a smooth horizontal table is not acted upon by a horizontal force, but may undergo a large displacement).
- The force and displacement are mutually perpendicular. [since, for $\theta = \pi/2 \text{ rad} (= 90^\circ)$, $\cos(\pi/2) = 0$].
- Work done by a variable force is given by

$$W = \int \mathbf{F} \cdot d\mathbf{s}$$

It is equal to the area under the force-displacement graph along with the proper sign.

Kinetic Energy

- kinetic energy K of an object of mass m is given as
- $K = \frac{1}{2} mv^2$
- It is a scalar quantity.
- It is a measure of the work an object can do by the virtue of its motion.

Work- Energy theorem

- It states that work done by a force acting on a body is equal to the change produced in the kinetic energy of the body.
- $K_f - K_i = W$
- This theorem is valid for a system in presence of all types of forces (external or internal, conservative or non-conservative).

Power

- Power of a body is defined as the rate at which the body can do the work.
- Average power (P_{av}) = W/t
- The instantaneous power is defined as the limiting value of the average power as time interval approaches zero,
- $P = dW/dt$
- The work dW done by a force F for a displacement dr is
- $dW = F \cdot dr$
- The instantaneous power can also be expressed as

- $P = F \cdot dr/dt$
 $= \mathbf{F} \cdot \mathbf{v}$ (where v is the instantaneous velocity when the force is F).
- Dimension: $[P] = [ML^2T^{-3}]$
- Units: watt or joule/sec [S.I.]
- Practical Units: Kilowatt (kW), Megawatt (MW) and Horsepower (hp)
- Relations between different units: $1 \text{ watt} = 1 \text{ joule/sec}$
 $= 10^7 \text{ erg/sec}$
 $1 \text{ hp} = 746 \text{ watt}$

Notion of potential energy, potential energy of a spring

- The energy possessed by a body by virtue of its position or condition is known as its potential energy.
- There are two common forms of potential energy: gravitational and elastic.
- Gravitational potential energy of a body is the energy possessed by the body by virtue of its position above the surface of the earth.
- It is given by
- $(U)P.E. = mgh$
- where $m \rightarrow$ mass of a body
- $g \rightarrow$ acceleration due to gravity on the surface of earth.
- $h \rightarrow$ height through which the body is raised.
- When an elastic body is displaced from its equilibrium position, work is needed to be done against the restoring elastic force. The work done is stored up in the body in the form of its elastic potential energy.
- If an elastic spring is stretched (or compressed) by a distance x from its equilibrium position, then its elastic potential energy is given by
- $U = 1/2 kx^2$
- where, $k \rightarrow$ force constant of given spring

Conservative Forces:

- The force is called conservative if work done by the force is dependent only on the initial and final position of the body, not on the path followed by the body.
- The work done by the conservative force in the close path is zero.
- For example, Gravitational Force, Electrostatic Force

Non-conservative forces:

- The force is called non-conservative force if work done by the force is dependent on the path followed by the body.
- The work done by the non-conservative force in a closed path is not zero.
- For example, Frictional Force

Collisions:

- Collision between two or more particles is the interaction for a short interval of time in which they apply relatively strong forces on each other.
- In a collision physical contact of two bodies is not necessary.
- There are two types of collisions:

Elastic collision - The collisions in which both the momentum and the kinetic energy of the system remains conserved are called elastic collisions. In an elastic collision all the involved forces are conservative forces. Total energy remains conserved.

Inelastic collision

Collisions in which only the momentum remains conserved but kinetic energy does not remain conserved are called inelastic collisions.

In an inelastic collision some or all the involved forces are non-conservative forces. Total energy of the system remains conserved.

- If the colliding molecules displace along the same straight-line path both before and after the collision, the collision is said to be one dimensional.
- In a one-dimensional elastic collision, the relative velocity of approach before collision is equal to the relative velocity of separation after collision.

- If two objects of mass m_1 and m_2 displacing with velocities u_1 and u_2 resp. collide head on such that v_1 and v_2 be their respective velocities after collision, then,

$$v_1 = \frac{(m_1 - m_2)u_1 + 2m_2u_2}{m_1 + m_2}$$

$$v_2 = \frac{(m_2 - m_1)u_2 + 2m_1u_1}{m_1 + m_2}$$

I.MULTIPLE CHOICE QUESTIONS

- The rate of doing work is called _____.
 - Force
 - Acceleration
 - Power
 - Displacement
- Which is the type of collision in which both the linear momentum and the kinetic energy of the system remain conserved?
 - Inelastic Collision
 - Elastic Collision
 - Destructive collision
 - None of the options
- Find the potential energy stored in a ball of mass 5 kg placed at a height of 3 m above the ground.
 - 121 J
 - 147 J
 - 227 J
 - 182 J
- What is the power utilised when work of 1000 J is done in 2 seconds?
 - 100 W
 - 200 W
 - 20 W
 - 500 W
- An electric heater of rating 1000 W is used for 5 hrs per day for 20 days. What is the electrical energy utilized?
 - 100 kWh
 - 200 kWh
 - 120 kWh
 - 500 kWh
- A ball moves in a frictionless inclined table without slipping. The work done by the table surface on the ball is
 - Negative
 - Zero
 - Positive
 - None of the options
- No work is done if
 - displacement is zero
 - force is zero
 - force and displacement are mutually perpendicular
 - All of these
- When the force retards the motion of body, the work done is
 - zero
 - negative
 - positive
 - Positive or negative depending upon the magnitude of force and displacement

9. Work is always done on a body when
- a force act on it
 - it moves through a certain distance
 - it experiences an increase in energy through a mechanical influence
 - None of these
10. According to work-energy theorem, the work done by the net force on a particle is equal to the change in its
- kinetic energy
 - potential energy
 - linear momentum
 - angular momentum
11. If a light body and heavy body have same kinetic energy, then which one has greater linear momentum?
- Lighter body
 - Heavier body
 - Both have same momentum
 - Can't be predicted
12. A light and a heavy body have equal momentum. Which one has greater K.E.?
- The lighter body
 - The heavier body
 - Both have equal K.E.
 - Data given is incomplete
13. A bullet is fired and gets embedded in a block kept on a table. If table is frictionless, then
- kinetic energy gets conserved
 - potential energy gets conserved
 - momentum gets conserved
 - both (a) and (c)
14. Unit of energy is
- kwh
 - joule
 - electron volt
 - All of these
15. Which of the following is not a conservative force?
- Gravitational force
 - Frictional force
 - Spring force
 - None of these
16. The speed of an object of mass m dropped from an inclined plane (frictionless), at the bottom of the plane, depends on:
- height of the plane above the ground
 - angle of inclination of the plane
 - mass of the object
 - All of these
17. A particle is taken round a circle by application of force. The work done by the force is
- positive non-zero
 - negative non-zero
 - Zero
 - None of the above
18. Four particles given, have the same momentum. Which has maximum kinetic energy
- Proton
 - Electron
 - Deuteron
 - Alpha-particles
19. If two particles are brought near one another, the potential energy of the system will
- increase
 - decrease
 - remains the same
 - equal to the K.E
-

20. When two spheres of equal masses undergo perfect inelastic collision with one of them at rest, after collision they will move
- opposite to one another
 - in the same direction
 - together
 - at right angle to each other
21. In an inelastic collision
- momentum is not conserved
 - momentum is conserved but kinetic energy is not conserved
 - both momentum and kinetic energy are conserved
 - neither momentum nor kinetic energy is conserved
22. The potential energy of a system increases if work is done
- upon the system by a non-conservative force
 - by the system against a conservative force
 - by the system against a non-conservative force
 - upon the system by a conservative force
23. In an elastic collision, what is conserved?
- Kinetic energy
 - Momentum
 - Both (a) and (b)
 - Neither (a) nor (b)
24. A vehicle is moving on a rough road in a straight line with uniform velocity. Then
- no force is acting on the vehicle
 - a force must act on the vehicle
 - an acceleration is being produced in the vehicle
 - no work is being done on the vehicle
25. A body projected vertically from the earth reaches a height equal to earth's radius before returning to the earth. The power exerted by the gravitational force is greatest
- at the instant just before the body hits the earth
 - at the highest position of the body
 - it remains constant all through
 - at the instant just after the body is projected.

II. ASSERTION AND REASON TYPE QUESTIONS:

In the following questions, a statement of assertion (A) is followed by a statement of reason(R).

Mark the correct choice as:

- If both assertion and reason are true and the reason is the correct explanation of the assertion.
- If both assertion and reason are true but reason is not the correct explanation of the assertion.
- If the assertion is true but the reason is false.
- If the assertion and reason both are false.
- If the assertion is false but the reason is true.

- Assertion:** When a body moves along a circular path, no work is done by the centripetal force.
Reason: The centripetal force is used in moving the body along the circular path and hence no work is done.
- Assertion:** When the force retards the motion of a body, the work done is zero.
Reason: Work done depends on angle between force and displacement.
- Assertion:** The work done in bringing a body down from the top to the base along a frictionless incline plane is the same as the work done in bringing it down the vertical side.
Reason: The gravitational force on the body along the inclined plane is the same as that along the vertical side.

4) **Assertion:** If momentum of a body increases by 50% its kinetic energy will increase by 125%.

Reason: Kinetic energy is proportional to square of velocity.

III. CASE STUDY QUESTIONS

1. Potential Energy of Spring

There are many types of spring. Important among these are helical and spiral springs.

Usually, we assume that the springs are massless. Therefore, work done is stored in the spring in the form of elastic potential energy of the spring. Thus, potential energy of a spring is the energy associated with the state of compression or expansion of an elastic spring.

(i) The ratio of spring constants of two springs is 2: 3. What is the ratio of their potential energy, if they are stretched by the same force?

- (a) 2: 3 (b) 3: 2 (c) 4: 9 (d) 9: 4

(ii) The potential energy of a body is increases in which of the following cases?

- (a) If work is done by conservative force
(b) If work is done against conservative force
(c) If work is done by non-conservative force
(d) If work is done against non- conservative force

(iii) The potential energy, i.e., $U(x)$ can be assumed zero when

- (a) $x = 0$ (b) gravitational force is constant
(c) infinite distance from the gravitational source (d) All of the above

(iv) The potential energy of a spring when stretched through a distance x is 10 J. What is the amount of work done on the same spring to stretch it through an additional distance x ?

- (a) 10 J (b) 20 J (c) 30 J (d) 40 J

(v) The potential energy of a spring increases by 15 J when stretched by 3 cm. If it is stretched by 4 cm, the increase in potential energy is

- (a) 27 J (b) 30 J (c) 33 J (d) 36 J

2. Potential energy is the energy stored within an object, due to the object's position, arrangement or state.

Potential energy is one of the two main forms of energy, along with kinetic energy. Potential energy depends on the force acting on the two objects.

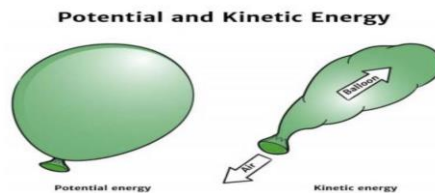

(i) A body is falling freely under the action of gravity alone in vacuum. Which of the following quantities remain constant during the fall?

- (a) kinetic energy (b) potential energy (c) mechanical energy (d) none of these

(ii) When does the potential energy of a spring increase?

- (a) only when spring is stretched (b) only when spring is compressed
(c) both a and b (d) none of these

(iii) What is the dimension of k/m where k is the force constant and m is the mass of the oscillating object?

- (a) $[T^2]$ (b) $[T^{-2}]$ (c) $[T^1]$ (d) $[T^{-1}]$

(iv) A vehicle of mass 5000kg climbs up a hill of 10 m. The potential energy gained by it

- (a) 5 J (b) 500 J (c) 5×10^4 J (d) 5×10^5 J

3. Collision is an isolated event in which a strong force acts between two or more bodies for a short time as a result of which the energy and momentum of the interacting particle change.

In collision particles may or may not come in real touch e.g. in collision between two billiard balls or a ball and bat, there is physical contact while in collision of alpha particle by a nucleus (i.e. Rutherford scattering experiment) there is no physical contact.

(A) Momentum conservation: In a collision, the effect of external forces such as gravity or friction are not taken into account as due to small duration of collision (Δt) average impulsive force responsible for collision is much larger than external force acting on the system and since this impulsive force is 'Internal' therefore the total momentum of system always remains conserved.

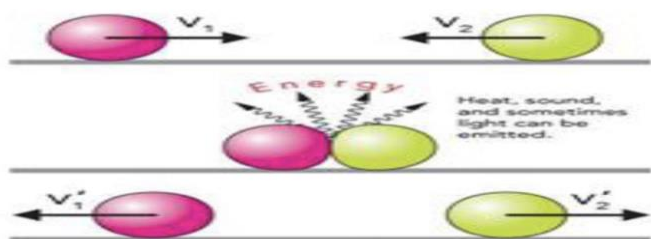

(B) Energy conservation: In a collision 'total energy' is also always conserved. Here total energy includes all forms of energy such as mechanical energy, internal energy, excitation energy, radiant energy or even mass energy.

These laws are the fundamental laws of physics and applicable for any type of collision but this is not true for conservation of kinetic energy. An elastic collision is a collision in which there is no net loss in kinetic energy in the system as a result of the collision. Both momentum and kinetic energy are conserved quantities in elastic collisions.

(i) In which motion, momentum changes but K.E does not?

- (a) circular motion (b) parabolic motion (c) straight line motion (d) none of these

(ii) Two balls at the same temperature collide. What is conserved?

- (a) momentum (b) velocity (c) kinetic energy (d) none of these

(iii) Momentum of two objects moving with the same speed but in opposite direction upon collision is

- (a) increased (b) decreased (c) zero (d) none of these

(iv) In elastic collision, the relative speed of approach and separation is:

- (a) equal (b) unequal (c) zero (d) infinite

IV. TWO MARK QUESTIONS

- 1) What are conservative forces?
- 2) Give the conditions for a collision to be elastic and inelastic.
- 3) How much work is done by a coolie walking on a horizontal platform with a load on his head? Explain.
- 4) Comets move around the sun in highly elliptical orbits. The gravitational force on the comet due to the sun is not normal to the comet's velocity in general. Yet the work done by the gravitational force over every complete orbit of the comet is zero. Why?
- 5) An artificial satellite orbiting the earth in a very thin atmosphere loses its energy gradually due to dissipation against atmospheric resistance, however small. Why then does its speed increase progressively as it comes closer and closer to the earth?
- 6) In Fig.(i), the man walks 2 m carrying a mass of 15 kg on his hands. In Fig. (ii), he walks the same distance pulling the rope behind him. The rope goes over a pulley, and a mass of 15 kg hangs at its other end. In which case is the work done greater?

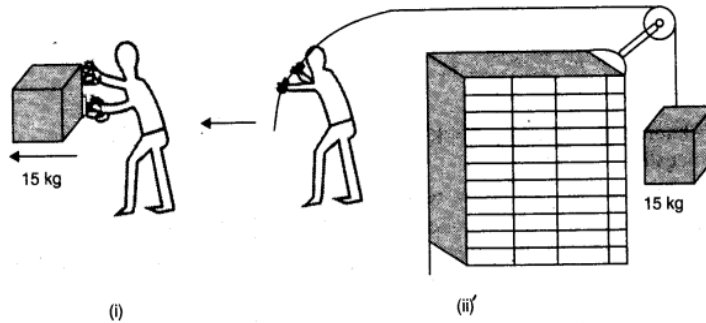

- 7) Write the differences between conservative and non-conservative forces. Give two examples each.

V . THREE MARK QUESTIONS

- 1) State and prove work energy theorem.
- 2) Explain with graphs the difference between work done by a constant force and by a variable force.
- 3) What is inelastic collision? In which way it is different from elastic collision.
- 4) What is an elastic collision? Show that in case of elastic collision in one dimension of two bodies, the relative velocities of the bodies after collision are equal to the relative velocities of the two bodies before the collision.

VI . FIVE MARK QUESTIONS

- 1) How does a perfectly inelastic collision differ from a perfectly elastic collision? Two particles of mass m_1 and m_2 having velocities U_1 and U_2 respectively make a head on collision. Derive the relation for their final velocities. Discuss the following special cases.
 - (i) $m_1 = m_2$
 - (ii) $m_1 \gg m_2$ and $U_2 = 0$
 - (iii) $m_1 \ll m_2$ and $U_1 = 0$
- 2) A block of mass 1 kg is pushed up a surface inclined to horizontal at an angle of 30° by a force of 10 N parallel to the inclined surface. The coefficient of friction between block and the incline is 0.1. If the block is pushed up by 10m along the incline, calculate
 - (i) work done against gravity.
 - (ii) work done against force of friction.
 - (iii) increase in potential energy.
 - (iv) increase in kinetic energy
 - (v) work done by applied force.
- 3) Define spring constant, Write the characteristics of the force during the elongation of a spring. Derive the relation for the PE stored when it is elongated by X . Draw the graphs to show the variation of P.E. and force with elongation.

VII . NUMERICALS

- 1) Calculate the work done by a car against gravity in moving along a straight horizontal road. The mass of the car is 400 kg and the distance moved is 2m.
- 2) Calculate the power of a crane in watts, which lifts a mass of 100 kg to a height of 10 m in 20 seconds.
- 3) A 10 kg ball and 20 kg ball approach each other with velocities 20 m/s and 10 m/s respectively. What are their velocities after collision if the collision is perfectly elastic?
- 4) An object of mass 0.4kg moving with a velocity of 4m/s collides with another object of mass 0.6kg moving in the same direction with a velocity of 2m/s. If the collision is perfectly inelastic, what is the loss of K.E. due to impact?

- 5) A trolley of mass 200 kg moves with a uniform speed of 36 km/h on a frictionless track. A child of mass 20 kg runs on the trolley from one end to the other (10 m away) with a speed of 4 m/s relative to the trolley in a direction opposite to its motion, and jumps out of the trolley. What is the final speed of the trolley? How much has the trolley moved from the time the child begins to run?
- 6) A pump on the ground floor of a building can pump up water to fill a tank of volume 30 m³ in 15 min. If the tank is 40 m above the ground, and the efficiency of the pump is 30%, how much electric power is consumed by the pump?
- 7) The bob of a pendulum is released from a horizontal position. If the length of the pendulum is 1.5 m, what is the speed with which the bob arrives at the lowermost point, given that it dissipated 5% of its initial energy against air resistance?
- 8) A body moving along the Z – axis of a co – ordinate system is subjected to a constant force F given by $\mathbf{F} = -i + 2j + 3k$ N. where i, j, k are unit vectors along the x, y and z – axis of the system respectively. What is the work done by this force in moving the body a distance of 4m along the Z – axis?

ANSWER KEY

MCQ

- 1) (c) Power
- 2) (b) Elastic Collision
- 3) (b) 147 J
- 4) (d) 500 W
- 5) (a) 100 kWh
- 6) (b) Zero
- 7) (d) All of these
- 8) (b) negative
- 9) (c) it experiences an increase in energy through a mechanical influence
- 10) (a) kinetic energy
- 11) (b) Heavier body
- 12) (a) The lighter body
- 13) (a) kinetic energy gets conserved
- 14) (d) All of these
- 15) (b) Frictional force
- 16) (a) height of the plane above the ground
- 17) (c) Zero
- 18) (b) Electron
- 19) (a) increase
- 20) (c) together
- 21) (b) momentum is conserved but kinetic energy is not conserved
- 22) (b) by the system against a conservative force
- 23) (c) Both (a) and (b)
- 24) (b) a force must act on the vehicle
- 25) (a) at the instant just before the body hits the earth

Assertion reason questions

- 1) C) the assertion is true but the reason is false.
- 2) A) both assertion and reason are true and the reason is the correct explanation of the assertion.
- 3) C) the assertion is true but the reason is false.
- 4) A) both assertion and reason are true and the reason is the correct explanation of the assertion.

Case study

- 1) b, b, d, c, a
- 2) c, c, b, d
- 3) a, a, c, a

Numericals

1) $WD = Fs \cos \theta$

$$WD = Fs \cos 90^\circ = 0$$

Hence, the work done by the car against the gravity is zero.

2) $m=100 \text{ kg}; g=10 \text{ m/s}^2; h=10 \text{ m}; t=20 \text{ s}$

$$W=mgh$$

$$=100 \times 10 \times 10$$

$$=10000 \text{ J}$$

$$P=W/t$$

$$=10000/20$$

$$=500 \text{ W}$$

3)

Here, $m_1 = 10 \text{ kg}, m_2 = 20 \text{ kg}$

$$u_1 = 20 \text{ m/s}, u_2 = -10 \text{ m/s}, v_1 = ?, v_2 = ?$$

As the collision is perfectly elastic,

$$v_1 = \frac{(m_1 - m_2)u_1}{m_1 + m_2} + \frac{2m_2u_2}{m_1 + m_2}$$

$$v_1 = \frac{(10 - 20)20}{10 + 20} + \frac{2 \times 20(-10)}{10 + 20}$$

$$v_1 = \frac{-200}{30} - \frac{400}{30} = \frac{-600}{30} = -20 \text{ m/s}$$

$$v_2 = \frac{2m_1u_1}{m_1 + m_2} + \frac{(m_2 - m_1)u_2}{m_1 + m_2}$$

$$v_2 = \frac{2 \times 10 \times 20}{10 + 20} + \frac{(20 - 10)(-10)}{10 + 20} = \frac{300}{30} = 10 \text{ m/s}$$

$$\text{Loss in K.E. } (\Delta K) = K_1 - K_2 = 4.4 - 3.92 = 0.48 \text{ J}$$

4)

$$\text{Final momentum} = Mv' + m(v' - 4)$$

$$= 200v' + 20v' - 80$$

$$= 220v' - 80$$

As per the law of conservation of momentum:

$$\text{Initial momentum} = \text{Final momentum}$$

$$2200 = 220v' - 80$$

$$\therefore v' = \frac{2280}{220} = 10.36 \text{ m/s}$$

Length of the trolley, $l = 10 \text{ m}$

Speed of the boy, $v'' = 4 \text{ m/s}$

Time taken by the boy to run,

$$t = \frac{10}{4} = 2.5 \text{ s}$$

\therefore Distance moved by the trolley =

$$v'' \times t = 4 \times 2.5 = 10 \text{ m}$$

5) Here, Volume of water = 30 m^3

$$t=15 \text{ min}=15 \times 60 \text{ s}=900 \text{ s}; \text{ Height } h=40 \text{ m}$$

Efficiency, $\eta=30\%$

$$\text{Density of water} = 10^3 \text{ kg m}^{-3}$$

$$\therefore \text{Mass of water pumped} = \text{Volume} \times \text{Density}$$

$$=(30 \text{ m}^3)(10^3 \text{ kg m}^{-3})=3 \times 10^4 \text{ kg}$$

$$P_{\text{output}}=W/t$$

$$=mgh/t$$

$$=(3 \times 10^4 \text{ kg})(10 \text{ m s}^{-2})(40 \text{ m})/900 \text{ s}$$

$$=4/3 \times 10^4 \text{ W}$$

$$\text{Efficiency, } \eta = P_{\text{input}} / P_{\text{output}}$$

$$P_{\text{input}} = \eta P_{\text{output}}$$

$$=44.4 \times 10^3 \text{ W}$$

$$=44.4 \text{ kW.}$$

6)

Given

$$\mathbf{F} = -\hat{i} + 2\hat{j} + 3\hat{k} \text{ N}$$

Work done is given by,

$$W = \vec{F} \cdot \vec{s}$$

$$W = (-\hat{i} + 2\hat{j} + 3\hat{k}) \cdot (4\hat{k}) = 12\text{J}$$

SYSTEM OF PARTICLES AND ROTATIONAL MOTION

Centre of Mass

Centre of mass of a system is the point that behaves as whole mass of the system is concentrated at it and all external forces are acting on it.

For rigid bodies, centre of mass is independent of the state of the body i.e., whether it is in rest or in accelerated motion centre of mass will remain same.

Centre of Mass of System of n Particles If a system consists of n particles of masses $m_1, m_2, m_3, \dots, m_n$ having position vectors $r_1, r_2, r_3, \dots, r_n$. then position vector of centre of mass of

Centre of Mass of Two Particle System

$$\text{the system, } \mathbf{r}_{\text{CM}} = \frac{m_1 \mathbf{r}_1 + m_2 \mathbf{r}_2 + m_3 \mathbf{r}_3 + \dots + m_n \mathbf{r}_n}{m_1 + m_2 + m_3 + \dots + m_n} = \frac{\sum_{i=1}^n m_i \mathbf{r}_i}{\sum m_i}$$

In terms of coordinates,

$$x_{\text{CM}} = \frac{m_1 x_1 + m_2 x_2 + \dots + m_n x_n}{m_1 + m_2 + \dots + m_n} = \frac{\sum_{i=1}^n m_i x_i}{\sum m_i}$$

$$y_{\text{CM}} = \frac{m_1 y_1 + m_2 y_2 + \dots + m_n y_n}{m_1 + m_2 + \dots + m_n} = \frac{\sum_{i=1}^n m_i y_i}{\sum m_i}$$

$$z_{\text{CM}} = \frac{m_1 z_1 + m_2 z_2 + \dots + m_n z_n}{m_1 + m_2 + \dots + m_n} = \frac{\sum_{i=1}^n m_i z_i}{\sum m_i}$$

Choosing O as origin of the coordinate axis.

(i) Then, position of centre of mass from $m_1 = \frac{m_2 d}{m_1 + m_2}$

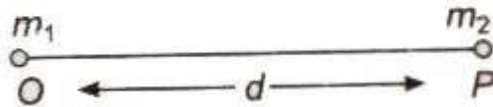

(ii) Position of centre of mass from $m_2 = (m_1 d) / m_1 + m_2$

iii) If position vectors of particles of masses m_1 and m_2 are r_1 and r_2 respectively, then

$$\mathbf{r}_{\text{CM}} = \frac{m_1 \mathbf{r}_1 + m_2 \mathbf{r}_2}{m_1 + m_2}$$

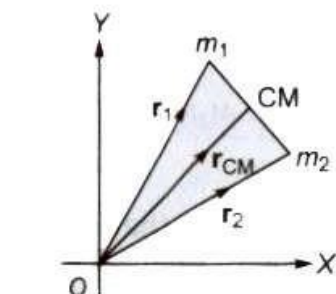

(iv) If in a two particle system, particles of masses m_1 and m_2 moving with velocities v_1 and v_2 respectively, then velocity the centre of mass

$$\mathbf{v}_{\text{CM}} = \frac{m_1 \mathbf{v}_1 + m_2 \mathbf{v}_2}{m_1 + m_2}$$

(v) If accelerations of the particles are a_1 , and a_2 respectively, then acceleration of the centre of mass

$$\mathbf{a}_{\text{CM}} = \frac{m_1 \mathbf{a}_1 + m_2 \mathbf{a}_2}{m_1 + m_2}$$

(vi) Centre of mass of an isolated system has a constant velocity.

(vii) It means isolated system will remain at rest if it is initially rest or will move with a same velocity if it is in motion initially.

(viii) The position of centre of mass depends upon the shape, size and distribution of the mass of the body.

(ix) The centre of mass of an object need not to lie with in the object.

(x) In symmetrical bodies having homogeneous distribution mass the centre of mass coincides with the geometrical centre the body.

(xi) The position of centre of mass of an object changes translatory motion but remains unchanged in rotatory motion, Translational Motion

A rigid body performs a pure translational motion, if each particle the body undergoes the same displacement in the same direction in given interval of time.

Rotational Motion

A rigid body performs a pure rotational motion, if each particle of the body moves in a circle, and the centre of all the circles lie on a straight line called the axes of rotation.

Rigid Body

If the relative distance between the particles of a system do not changes on applying force, then it called a rigid body. General motion of a rigid body consists of both the translational motion and the rotational motion.

Moment of Inertia

The inertia of rotational motion is called moment of inertia. It is denoted by L .

Moment of inertia is the property of an object by virtue of which it opposes any change in its state of rotation about an axis.

The moment of inertia of a body about a given axis is equal to the sum of the products of the masses of its constituent particles and the square of their respective distances from the axis of rotation.

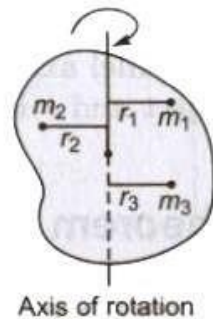

Moment of inertia of a body

$$I = m_1 r_1^2 + m_2 r_2^2 + m_3 r_3^2 + \dots = \sum_{i=1}^n m_i r_i^2$$

Its unit is kg.m^2 and its dimensional formula is $[\text{ML}^2]$. The

moment of inertia of a body depends upon

- position of the axis of rotation
- orientation of the axis of rotation
- shape and size of the body
- distribution of mass of the body about the axis of rotation.

The physical significance of the moment of inertia is same in rotational motion as the mass in linear motion.

Radius of Gyration

The root mean square distance of its constituent particles from the axis of rotation is called the radius of gyration of a body.







It is denoted by K .

The product of the mass M of the body about its axis of rotation and its radius gyration (K) gives the same moment of inertia of the body about the axis.

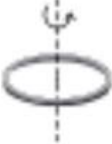
$$I = M K^2$$

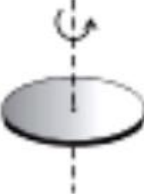
Therefore, moment of inertia $I = M K^2 \Rightarrow K = \sqrt{I/M}$

Moments of inertia for simple geometrical objects

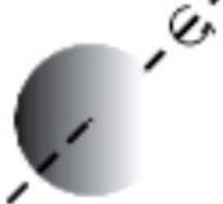
Z	Body	Axis	Figure	I
(1)	Thin circular ring, radius R	Perpendicular to plane, at centre		MR^2
(2)	Thin circular ring, radius R	Diameter		$MR^2/2$
(3)	Thin rod, length L	Perpendicular to rod, at mid point		$ML^2/12$
(4)	Circular disc, radius R	Perpendicular to disc at centre		$MR^2/2$
(5)	Circular disc, radius R	Diameter		$MR^2/4$
(6)	Hollow cylinder, radius R	Axis of cylinder		MR^2
(7)	Solid cylinder, radius R	Axis of cylinder		$MR^2/2$
(8)	Solid sphere, radius R	Diameter		$2MR^2/5$

Equations of Rotational Motion

(i) $\omega = \omega_0 + \alpha t$

(ii) $\theta = \omega_0 t + 1/2 \alpha t^2$

(iii) $\omega^2 = \omega_0^2 + 2\alpha\theta$

where θ is displacement in rotational motion, ω_0 is initial velocity, ω is final velocity and α is acceleration.

Torque

Torque or moment of a force about the axis of rotation $\tau = r \times F$
 $= rF \sin\theta \hat{n}$

It is a vector quantity.

If the nature of the force is to rotate the object clockwise, then torque is called negative and if rotate the object anticlockwise, then it is called positive.

Its SI unit is 'newton-metre' and its dimension is $[ML^2T^{-2}]$.

In rotational motion, torque, $\tau = I\alpha$

where α is angular acceleration and I is moment of inertia.

Angular Momentum

The moment of linear momentum is called angular momentum.

It is denoted by L .

Angular momentum, $L = I\omega = mvr$

In vector form, $L = I\omega = r \times mv$

Its unit is 'joule-second' and its dimensional formula is $[ML^2T^{-1}]$. Torque, τ

$= dL/dt$

Conservation of Angular Momentum

If the external torque acting on a system is zero, then its angular momentum remains conserved.

If $\tau_{\text{ext}} = 0$, then $L = I(\omega) = \text{constant} \Rightarrow I_1\omega_1 = I_2\omega_2$

Angular Impulse

Total effect of a torque applied on a rotating body in a given time is called angular impulse. Angular impulse is equal to total change in angular momentum of the system in given time. Thus, angular impulse

$$J = \int_0^{\Delta L} \tau dt = L_f - L_i$$

I.MULTIPLE CHOICE QUESTIONS

1. Three identical balls each of radius 10cm and mass 1kg each are placed touching each other on a horizontal surface. Where is their C.M. located?
- (a) At the centre of one ball. (b) On the horizontal surface.
(c) At the point of contact of any two spheres. (d) None of these.
2. A body rolls without slipping. The radius of gyration of the body about an axis passing through its centre of mass is K . If radius of the body be R , then what is the ratio of its rotational K.E. to translational K.E.?
- (a) K^2 / R^2 (b) $K^2 / (K^2 + R^2)$ (c) $R^2 / (K^2 + R^2)$ (d) $K^2 + R^2$
3. A body is under the action of two equal and oppositely directed forces and the body is rotating with constant acceleration. Which of the following cannot be the separation between the lines of action of the forces?
- (a) zero (b) 0.25m (c) 0.4m (d) 1.0m
4. A body of mass M slides down an inclined plane and reaches the bottom with velocity v . If a ring of same mass rolls down the same inclined plane, what will be its velocity on reaching the bottom?
- (a) v^2 (b) $v/\sqrt{2}$ (c) v (d) $\sqrt{2}v$
5. A ring of radius R slides down an inclined plane and reaches the bottom with speed v . If the radius of the ring is doubled keeping its M.I. constant, the speed at the bottom of the inclined plane will be
- (a) v (b) $2v$ (c) $\sqrt{2}v$ (d) $v/\sqrt{2}$
6. A uniform rod of length l is rotating horizontally with uniform angular speed ω about a vertical axis passing through its one end. The force exerted on the rod is
- (a) $ml\omega^2$ (b) $ml^2\omega^2$ (c) $12 ml^2\omega^2$ (d) $12 ml\omega$
7. The pendulum consists of a sphere of mass m suspended with a flexible wire of length l . If the breaking strength of the wire is $2mg$, then the angular displacement that can be given to the pendulum is
- (a) 30° (b) 45° (c) 60° (d) 90°
8. A string of length l fixed at one end carries a mass M at the other end. The string makes 2π revolutions per second around a vertical axis through the fixed end. The tension in the string is
- (a) Ml (b) $2Ml$ (c) $4Ml$ (d) $16Ml$
9. A wheel has radius 10cm and is coupled by a belt to another wheel of radius 30cm. The smaller wheel increases its speed from rest at a uniform rate of π rads⁻². The speed of larger wheel become 100 rpm after
- (a) 2s (b) 5s (c) 20s (d) 10s
10. Three thin iron rods each of mass M and length l are welded so as to form an equilateral triangle. The M.I. about the axis passing through the C.M. and perpendicular to its plane is
- (a) Ml^2 (b) $Ml^2/3$ (c) $Ml^2/2$ (d) $Ml^2/4$
11. If the rods in Q.10 are joined to form letter H, then M.I. of the system about one of sides of H will be
- (a) $Ml^2/3$ (b) $Ml^2/4$ (c) $2Ml^2/3$ (d) $4/3 Ml^2$
12. In Q. 11, M.I. about side joining the outer sides will be
- (a) $Ml^2/6$ (b) $Ml^2/4$ (c) $Ml^2/3$ (d) $Ml^2/12$

II. ASSERTION - REASON TYPE QUESTIONS

Directions : Each of these questions contain two statements, Assertion and Reason. Each of these questions also has four alternative choices, only one of which is the correct answer. You have to select one of the codes (a), (b), (c) and (d) given below.

- (a) Assertion is correct, reason is correct; reason is a correct explanation for assertion.
- (b) Assertion is correct, reason is correct; reason is not a correct explanation for assertion
- (c) Assertion is correct, reason is incorrect
- (d) Assertion is incorrect, reason is correct.

1. Assertion : The centre of mass of a body may lie where there is no mass.
Reason : Centre of mass of body is a point, where the whole mass of the body is supposed to be concentrated.
2. Assertion : The earth is slowing down and as a result the moon is coming nearer to it.
Reason : The angular momentum of the earth moon system is conserved
3. Assertion : When you lean behind over the hind legs of the chair, the chair falls back after a certain angle.
Reason : Centre of mass lying outside the system makes the system unstable.
4. Assertion : The centre of mass of system of n particles is the weighted average of the position vector of the n particles making up the system.
Reason : The position of the centre of mass of a system is independent of coordinate system.
5. Assertion: Centre of mass of a ring lies at its geometric centre though there is no mass.
Reason: Centre of mass is independent of mass.
6. Assertion : The centre of mass of an isolated system has a constant velocity.
Reason : If centre of mass of an isolated system is already at rest, it remains at rest.
7. Assertion : The position of centre of mass of body depend upon shape and size of the body.
Reason : Centre of mass of a body lies always at the centre of the body
8. Assertion : If no external force acts on a system of particles, then the centre of mass will not move in any direction.
Reason : If net external force is zero, then the linear momentum of the system remains constant
9. Assertion : A particle is moving on a straight line with a uniform velocity, its angular momentum is always zero.
Reason : The momentum is not zero when particle moves with a uniform velocity.
10. Assertion : The centre of mass of a two particle system lies on the line joining the two particle, being closer to the heavier particle.
Reason : Product of mass of particle and its distance from centre of mass is numerically equal to product of mass of other particle and its distance from centre of mass.

V. CASE STUDY QUESTIONS

1. The cross product of two vectors is given by Vector $\mathbf{C} = \mathbf{A} \times \mathbf{B}$. The magnitude of the vector defined from cross product of two vectors is equal to product of magnitudes of the vectors and sine of angle between the vectors. Direction of the vectors is given by right hand corkscrew rule and is perpendicular to the plane containing the vectors.

$$\therefore |\text{vector } \mathbf{C}| = AB\sin\theta \text{ and } \text{Vector } \mathbf{C} = AB\sin\theta \mathbf{n}$$

Where, \hat{n} is the unit vector perpendicular to the plane containing the vectors A and B. Following are properties of vector product

- Cross product does not obey commutative law. But its magnitude obeys commutative law.
- It obeys distributive law
- The magnitude cross product of two vectors which are parallel is zero. Since $\theta = 0$;
vector $|A \times B| = AB \sin 0^\circ = 0$
- For perpendicular vectors, $\theta = 90^\circ$, vector $|A \times B| = AB \sin 90^\circ |\hat{n}| = AB$
 $\hat{i} \times \hat{i} = \hat{j} \times \hat{j} = \hat{k} \times \hat{k} = 0$
 $\hat{i} \times \hat{j} = \hat{k}$; $\hat{j} \times \hat{k} = \hat{i}$; $\hat{k} \times \hat{i} = \hat{j}$
 $\hat{j} \times \hat{i} = -(\hat{i} \times \hat{j}) = -\hat{k}$; $\hat{k} \times \hat{j} = -(\hat{j} \times \hat{k}) = -\hat{i}$; $\hat{i} \times \hat{k} = -(\hat{k} \times \hat{i}) = -\hat{j}$
- The expression for $a \times b$ can be put in a determinant form which is easy to remember

Answer the following questions from above case study.

- If θ is angle between two vectors then resultant vector is maximum when θ is
(a) 0 b) 90 c) 180 d) None of these
- Cross product is operation performed between
a) Two scalar numbers b) One scalar other vector c) 2 vectors d) None of these
- Define cross product of two vectors
- State right hand screw rule for finding out direction of resultant after cross product of two vectors.
- Give properties of cross product of parallel vector.

Answer key-1 1) a 2) c

VI. TWO MARK QUESTIONS

- What will be the effect on the day-length if the polar ice caps of the planet melt?
- Suppose you have been given two spheres of the same mass and radius, one is solid and the other is hollow. Which of them has a larger moment of inertia about its diameter?
- What is a rigid body?
- Distinguish between internal and external forces.
- What are the advantages of concept of centre of mass?
- Why are spokes fitted in the cycle wheel?
- Why cannot a single force balance the torque?
- What is the physical significance of M.I.?
- Is the centre of mass a reality?
- Why should we prefer to use a wrench of longer arm?

VII. THREE MARK QUESTIONS

- Using the expression of power and K.E. of rotational motion, derive the relation $\tau = I\alpha$.
- Define Torque. What is its physical significance?
- Derive the expression for radius of gyration?
- What is the difference between centre of gravity and C.M.?

VIII. NUMERICALS

1. A rope of negligible mass is wound round a hollow cylinder of mass 3 kg and radius 40 cm. What is the angular acceleration of the cylinder if the rope is pulled with a force of 30 N? What is the linear acceleration of the rope? Assume that there is no slipping.

Answer: Here, $M = 3$ kg, $R = 40$ cm = 0.4 m

Moment of inertia of the hollow cylinder about its axis.

$$I = MR^2 = 3(0.4)^2 = 0.48 \text{ kg}$$

Force applied $F = 30$ N

\therefore Torque, $\tau = F \times R = 30 \times 0.4 = 12$ N-m.

If α is angular acceleration produced, then from $\tau = I\alpha$

$$\alpha = \frac{\tau}{I} = \frac{12}{0.48} = 25 \text{ rad s}^{-2}$$

Linear acceleration, $a = R\alpha = 0.4 \times 25 = 10 \text{ ms}^{-2}$.

2. To maintain a rotor at a uniform angular speed of 200 rad s⁻¹, an engine needs to transmit a torque of 180 Nm. What is the power required by the engine?

Note: Uniform angular velocity in the absence of friction implies zero torque. In practice, applied torque is needed to counter frictional torque). Assume that the engine is 100 efficient.

Answer: Here, $\omega = 200$ rad s⁻¹; Torque, $\tau = 180$ N-m

Since, Power, $P = \text{Torque } (\tau) \times \text{angular speed } (\omega)$

$= 180 \times 200 = 36000$ watt = 36 KW.

ANSWERS - MULTIPLE CHOICE QUESTIONS

Qn.no	1	2	3	4	5	6	7	8	9	10	11	12
Answer	B	A	A	B	A	D	C	D	D	C	D	A

ANSWERS - ASSERTION AND REASON TYPE

Qn.no	1	2	3	4	5	6	7	8	9	10
Answer	A	D	C	B	B	B	C	A	D	A

GRAVITATION

Gist of Lesson

- Gravitation and gravity
- Properties of gravitational force
- Newton's law of gravitation
- Acceleration due to gravity
- Variation of acceleration due to gravity with altitude, depth and latitude
- Inertial and gravitational mass
- Gravitational field and gravitational field intensity
- Gravitational potential energy and gravitational potential
- Kepler's laws of Planetary motion.
- Escape and Orbital Velocity
- Time period, height and energy of a satellite
- Formula and Flow chart

Gravitation is the acting force between two bodies. On the other hand, gravity is the force occurring between an object and the very big object earth.

Gravitation represents that this force is directly proportional to the product of the masses of both objects. And, also it is inversely proportional to the square of the distance between them.

Usually, **gravity** is being considered as the natural property of earth, due to which the objects are attracted towards earth

Properties of Gravitational Force

- 1: The gravitational force is a long-range force, which exists between two particles, regardless of the medium that separates them.
- 2: The gravitational force is directly proportional to the product of the mass of the two bodies. This means a larger mass will yield a larger force.
- 3: The force obeys the inverse square law. The force is inversely proportional to the square of the distance between them.
- 4: On the surface of the earth, the gravitational force produces a constant acceleration, $g = 9.8 \text{ m/s}^2$.
- 5: Gravitational force always acts as a force of attraction. It tries to pull masses together, it never pushes them apart.
- 6: It is independent of the intervening medium.
- 7: Gravitational force is the weakest of the four fundamental forces.
- 8: It acts along the line joining the centre of the two objects. Therefore, it is called the central force.
- 9: Gravitational force is directly proportional to the weight.
- 10: Gravitational force acts even when the objects are not in touch.

Newton's law of gravitation:

Every particle of matter in this universe attracts every other particle with a force which varies directly as the product of masses of two particles and inversely as the square of the distance between them.

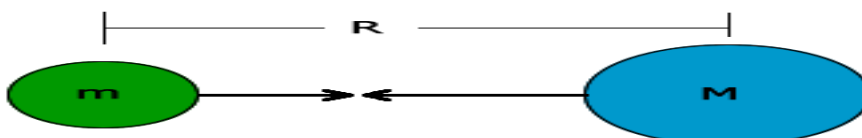

$$F = GMm/R^2$$

Here, G is universal gravitational constant. $G = 6.67 \times 10^{-11} \text{ Nm}^2 / \text{kg}^2$

Dimensional formula of G: $G = Fr^2/Mm = [MLT^{-2}] [L^2]/[M^2] = [M^{-1}L^3T^{-2}]$

Weight: Gravitational force with which a body is attracted towards the centre of the earth.



Acceleration due to gravity (g): Acceleration produced in a body due to gravitational pull of the earth. $g = GM/R^2$

Variation of g with altitude:

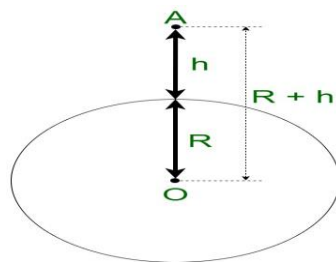

$g' = g(1 - 2h/R)$, if $h \ll R$. Here R is the radius of earth and h is the height of the body above the surface of earth. The value of acceleration due to gravity decreases with the increase in height.

Variation of g with depth:

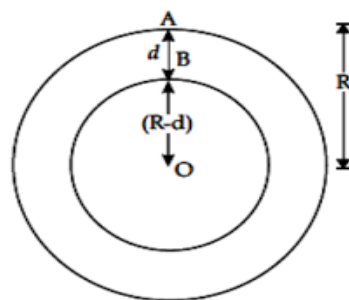

$g' = g(1 - d/R)$. Here g' be the value of acceleration due to gravity at the depth d. The value of acceleration due to gravity decreases with the increase in depth.

Variation with latitude:

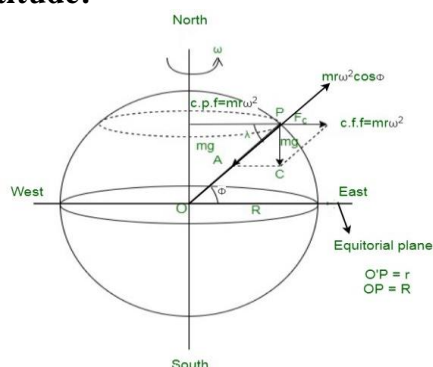

At poles:- $\Phi = 90^\circ$, $g' = g$

At equator:- $\Phi = 0^\circ$, $g' = g(1 - \omega^2 R/g)$

Here ω is the angular velocity.

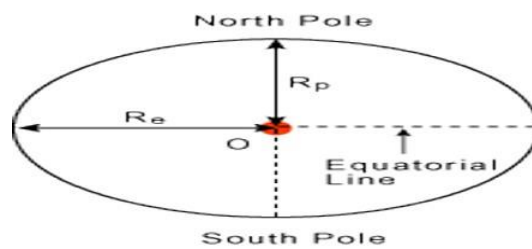

As $g = GM_e/R_e^2$, therefore $g_{\text{pole}} > g_{\text{equator}}$

$$g_{\lambda} = g - R\omega^2 \cos^2 \Phi$$

Mass is defined as the amount of matter contained in a body. mass of a body can be found by two different methods. Those are

Inertial mass: The property of a body to measure its resistance to acceleration is called its inertial mass.

Gravitational mass: The property of a body responsible for the gravitational force it exerts on another body is called gravitational mass.

Gravitational Mass: - $m = FR^2/GM$

Gravitational field: Around a body within which its gravitational force of attraction can be experienced.

Gravitational field intensity: Force experienced by a unit mass of an object placed at that point

$$E = F/m$$

$$= GM/r^2$$

Gravitational intensity on the surface of earth (E_s):

$$E_s = 4/3 (\pi R\rho G)$$

Here R is the radius of earth, ρ is the density of earth and G is the gravitational constant.

Gravitational potential energy (U): Amount of work done in bringing a body from infinity to a given point in the gravitational field of the other.

$$U = -GMm/r$$

(a) Two particles: $U = -Gm_1m_2/r$

(b) Three particles: $U = -Gm_1m_2/r_{12} - Gm_1m_3/r_{13} - Gm_2m_3/r_{23}$

Gravitational potential (V): Amount of work done in bringing a body of unit mass from infinity to that point.

$$V(r) = -GM/r$$

At surface of earth,

$$V_s = -GM/R$$

Here R is the radius of earth.

Kepler's laws of planetary motion:

Kepler's first law (law of elliptical orbit): A planet moves round the sun in an elliptical orbit with sun situated at one of its foci.

Kepler's second law (law of areal velocities): A planet moves round the sun in such a way that its areal velocity is constant.

Kepler's third law (law of time period): A planet moves round the sun in such a way that the square of its period is proportional to the cube of semi major axis of its elliptical orbit.

- $T^2 \propto R^3$
- Here R is the radius of orbit.
- $T^2 = (4\pi^2/GM) R^3$

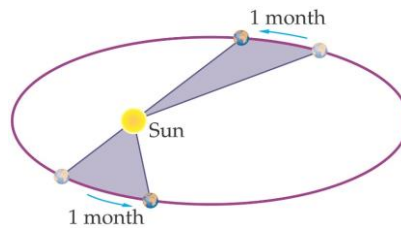

Escape velocity (v_e): Escape velocity is, in astronomy and space exploration, the velocity needed for a body to escape from a gravitational centre of attraction without undergoing any further acceleration.

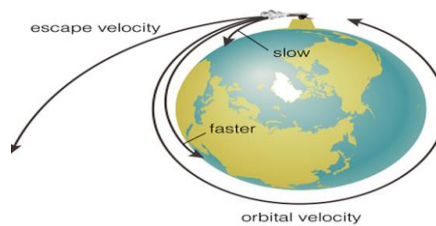

It is defined as the least velocity with which a body must be projected vertically upward in order that it may just escape the gravitational pull of earth.

$$v_e = \sqrt{\frac{2GM}{R}}$$

$$\text{or, } v_e = \sqrt{2gR} = \sqrt{gD}$$

Here R is the radius of earth and D is the diameter of the earth.

Escape velocity (v_e) in terms of earth's density:- $v_e = R\sqrt{\frac{8\pi G\rho}{3}}$

Orbital velocity (v_0):

$$v_0 = \sqrt{\frac{GM}{r}}$$

If a satellite of mass m revolves in a circular orbit around the earth of radius R and h be the height of the satellite above the surface of the earth, then,

$$r = R+h$$

$$\text{So, } v_0 = \sqrt{\frac{GM}{R+h}} = R \sqrt{\frac{g}{R+h}}$$

In the case of satellite, orbiting very close to the surface of earth, then orbital velocity will be,

$$v_0 = \sqrt{gR}$$

Relation between escape velocity v_e and orbital velocity v_0 :- $v_0 = v_e/\sqrt{2}$ (if $h \ll R$)

Time period of Satellite: Time period of a satellite is the time taken by the satellite to complete one revolution around the earth.

$$T = 2\pi \sqrt{(R+h)^3/GM} = (2\pi/R)\sqrt{(R+h)^3/g}$$

$$\text{If } h \ll R, T = 2\pi \sqrt{R/g}$$

$$\text{Height of satellite: } h = [gR^2T^2/4\pi^2]^{1/3} - R$$

Energy of satellite:

$$\text{Kinetic energy, } K = \frac{1}{2} mv_0^2 = \frac{1}{2} (GMm/r)$$

$$\text{Potential energy, } U = - GMm/r$$

$$\text{Total energy, } E = K+U$$

$$= \frac{1}{2} (GMm/r) + (- GMm/r)$$

$$= -\frac{1}{2} (GMm/r)$$

Gravitational force in terms of potential energy:- $F = - (dU/dR)$

Acceleration on moon:

$$g_m = GM_m/R_m^2 = 1/6 g_{\text{earth}}$$

Here M_m is the mass of moon and R_m is the radius of moon.

FORMULA AND FLOW CHART

BRAIN MAP

GRAVITATION

CLASS XI

Newton's Law of Gravitation

Gravitational force (F) between two bodies is directly proportional to product of masses and inversely proportional to square of the distance between them.

$$\vec{F} = -\frac{Gm_1m_2}{r^2} \cdot \hat{r}$$

Law of orbits : Every planet revolves around the sun in an elliptical orbit and the sun is situated at one of its foci.

Kepler's Laws of Planetary Motion

Law of areas : The areal velocity of the planet around the sun is constant
i.e., $\frac{dA}{dt} = \text{a constant}$

Law of periods : The square of the time period of revolution of a planet is directly proportional to the cube of semi major axis of the elliptical orbit.
 $T^2 \propto a^3$

Acceleration due to gravity

- For a body falling freely under gravity, the acceleration in the body is called acceleration due to gravity.
- Relationship between g and G
 $g = \frac{GM_e}{R_e^2} = \frac{4}{3}\pi GR_e\rho$
where G = gravitational constant
 ρ = density of earth
 M_e and R_e be the mass and radius of earth

Characteristics of gravitational force

- It is always attractive.
- It is independent of the medium.
- It is a conservative and central force.
- It holds good over a wide range of distance.

Gravitational potential

Work done in bringing a unit mass from infinity to a point in the gravitational field.
 $V = \frac{-GM}{r}$

Gravitational Potential Energy

Work done in bringing the given body from infinity to a point in the gravitational field.
 $U = -GMm/r$

Escape speed

The minimum speed of projection of a body from surface of earth so that it just crosses the gravitational field of earth.
 $v_e = \sqrt{\frac{2GM}{R}}$

Variation of acceleration due to gravity (g)

Due to altitude (h)

$$g_h = g \left(1 - \frac{2h}{R_e}\right)$$

The value of g goes on decreasing with height.

Due to depth (d)

$$g_d = g \left(1 - \frac{d}{R_e}\right)$$

The value of g decreases with depth.

Due to rotation of earth

$$g_\lambda = g - R_e \omega^2 \cos^2 \lambda$$

At equator, $\lambda = 0^\circ$

$$g_{\lambda_{\min}} = g - R_e \omega^2$$

At poles, $\lambda = 90^\circ$

$$g_{\lambda_{\max}} = g_p = g$$

Types of Satellite

Polar satellite

- Time period : 100 min
- Revolves in polar orbit around the earth.
- Height : 500-800 km.
- Uses : Weather forecasting, military spying

Geostationary satellite

- Time period : 24 hours
- Same angular speed in same direction with earth.
- Height : 36000 km.
- Uses : GPS, satellite communication (TV)

Earth's Satellite

Orbital speed of satellite

The minimum speed required to put the satellite into a given orbit.

$$v_o = R_e \sqrt{\frac{g}{R_e + h}}$$

For satellite orbiting close to the earth's surface

$$v_o = \sqrt{gR_e}$$

Time period of satellite

$$T = \frac{2\pi}{R_e} \sqrt{\frac{(R_e + h)^3}{g}}$$

For satellite orbiting close to the earth's surface

$$T = 2\pi \sqrt{\frac{R_e}{g}} = 84.6 \text{ min}$$

Energy of satellite

- Kinetic energy $K = \frac{GM_e m}{2(R_e + h)}$
- Potential energy $U = \frac{-GM_e m}{R_e + h}$
- Total energy
 $E = K + U = -\frac{GM_e m}{2(R_e + h)}$

I .MULTIPLE CHOICE QUESTIONS

- 1.What is the name of attractive force which act between any two bodies in our universe?
A: Gravitational force. B: Coulomb attractive force C: Nuclear force D: Magnetic force
- 2.What is the value of Universal Gravitational Constant (G) in C.G.S unit?
A: $6.67 * 10^{-6}$ cgs unit. B: $6.67 * 10^{-7}$ cgs unit. C: $6.67 * 10^{-8}$ cgs unit D: $6.67 * 10^{-10}$ cgs unit
- 3.What is the unit of Universal Gravitational Constant in SI unit?
A: N-m-Kg B: N/m-Kg. C: N-m/Kg². D: N/m²-Kg
- 4.What is the value of gravitational acceleration on Earth?
A: 9.8 m-s^{-2} B: 9.8 m/s^2 C: 8.9 m-s^{-2} D: 8.9 m/s^2
- 5.The value of gravitational acceleration is –
A: increases as height increase form the earth. B: decreases as height increase from the earth.
C: remains constant. D: None of the above
- 6.Where the value of gravitational acceleration is less due to the diurnal motion of earth?
A: At Polar region. B: At equator.C: Tropic of Cancer or Tropic of Capricorn D: None of this
- 7.In which region of earth the weight of a body is slightly greater?
A: At Polar region B: At equator. C: Tropic of Cancer or Tropic of Capricorn D: None of this
- 8.If speed of rotation of earth increases then what would be the value of weight of a body?
A: Weight of a body will increases. B: Weight of a body will decreases
C: Weight of a body remain constant. D: Cannot be answered
- 9.What is the approximate mass of Sun?
A: $2 * 10^{34}$ kg. B: $2 * 10^{32}$ kg. C: $2 * 10^{30}$ kg. D: $2 * 10^{28}$ kg
- 10.What is the approximate mass of earth?
A: $3 * 10^{24}$ kg. B: $4 * 10^{24}$ kg. C: $5 * 10^{24}$ kg. D: $6 * 10^{24}$ kg
- 11.What is escape velocity?
A: Velocity of moon. B: Velocity of earth
C: Velocity of a body that allow it to go outside the earth D: Tangential velocity of equator.
- 12.What is the value of escape velocity of earth?
A: 9.8 km/sec. B: 10 km/sec C: 11.2 km/sec. D: 12 km/sec
- 13.Does time period of artificial satellite depend on its mass?
A: Yes. B: No
- 14.What would be the height of an artificial satellite so that it can be observed at same position with respect to earth?
A: 36000 km above the earth surface. B: 40000 km above the earth surface
C: 26000 km above the earth surface. D: 63000 km above the earth surface
- 15.How much time a polar satellite take to complete one revolution around earth?
A: 1 hour 30 min. B: 2 hours. C: 2 hour 20 min D: 3 hour
- 16.What is the weight of a body inside an artificial satellite of earth?
A: It depends on the mass of the body. B: It depends on the velocity of satellite
C: Product of its mass and gravitational acceleration D: Zero

17. Does the gravitational force same for two objects inside and outside the water?

A: Yes. B: No

18. What is the weight of a body of mass 1 kg?

A: 1 kg. B: 9.8 kg. C: 9.8 Kg-m/Sec² D: 9.8 N

19. Weight of free fall object is

A: mass of the object \times gravitational acceleration. B: Zero
C: greater than rest object. D: less than rest object

20. Does escape velocity of a body depend on its mass?

A: Yes. B: No

21. Let the escape velocity of earth is V_e . What would be the escape velocity of a planet whose mass and radius is double from earth?

A: V_e . B: $2 V_e$. C: $4 V_e$. D: $16 V_e$

22. If the radius of earth is decrease keeping mass constant, then the length of day will

A: decrease. B: Increase. C: remain same. D: cannot say

23. If the earth stop rotating then the weight of an object on north pole will

A: Increase. B: decrease. C: remain same. D: be zero

24. If a stone bring back to earth from moon then its

A: mass will be changed. B: mass and weight will be changed
C: Weight never be changed. D: mass remain constant but weight will be changed

25. Suppose an object is thrown upward with an angle θ providing velocity equal to escape velocity (V_e). The magnitude of escape velocity will be..

A: V_e . B: $V_e \cos\theta$. C: $V_e \sin\theta$. D: $V_e \tan\theta$

26. While revolving an artificial satellite around earth, the required centripetal force is provided by –

A: fuel contained in the satellite. B: gravitational force due to sun
C: gravitational force due to earth. D: Thrust produced by burning fuel

27. In case of planet's motion –

A: velocity remain constant in its orbit. B: angular velocity remain constant
C: total angular momentum remain constant. D: radius of orbit remain constant.

28. An artificial satellite revolving around earth in a circular orbit. Its

A: linear velocity is constant. B: acceleration is constant
C: acceleration is changing. D: angular velocity constant

29. What is the value of gravitational acceleration inside the earth?

A: 9.8 m-s^{-2} B: Infinite. C: Zero. D: Cannot be calculated

30. In case of free fall the gravitational acceleration on a spherical object depends on__

A: The mass of the object B: The radius of the object
C: The density of the object. D: None of the above

31. Gravitation force between two masses m_1 and m_2 is proportional to –

A: m_1+m_2 . B: m_1-m_2 . C: $m_1 \div m_2$. D: $m_1 \times m_2$

32. Two masses m_1 and m_2 are kept at a distance R. Gravitation force between them is proportional to –

A: R. B: $1/R$. C: $1/R^2$ D: R^2

33. Observe the following figures and answer the question.

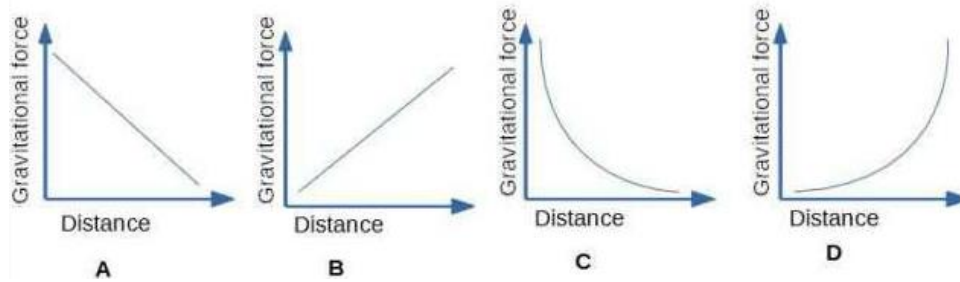

Which figure showing gravitational vs distance graph is correct?

A: option A. B: option B. C: option C. D: option D

34. Gravitational potential is –

A: proportional to distance. B: inversely proportional to distance
 C: proportional to the square of the distance. D: inversely proportional to the square of the distance

35. What is the escape velocity of moon?

A: 2.00 Km/sec. B: 2.38 km/sec. C: 3.28 km/sec. D: 2.83 km/sec

36. What is the escape velocity of sun?

A: 618 km/sec. B: 200 km/sec. C: 322 km/sec. D: 465 km/sec

37. If we throw a ball upward then gravitational acceleration on the ball will be –

A: zero. B: positive. C: negative. D: negligible

38. If we double the distance between two objects, gravitational force will be

A: double. B: half. C: one fourth. D: 4 times greater

39. Which of the following statement(s) is/are correct?

1. value of gravitational acceleration decreases with height or depth from earth's surface.
 2. gravitational acceleration is maximum at pole.
 3. value of gravitational acceleration increase due to rotation of earth.
 4. If angular speed of earth become 17 times its present value, a body on the equator becomes weightless.
 A: Only option 1 is correct; B: Options 1 and 2 are correct;
 C: Option 1, 2 and 3 are correct; D: options 1, 2 and 4 are correct;

40. If we double the mass of an artificial satellite then its orbital speed –

A: will be double; B: will be half of its initial speed;
 C: will be one fourth of its initial speed; D: is independent of its mass;

41. If the masses of the Earth and Sun suddenly double, the gravitational force between them will

(A) remain the same. (B) increase 2 times. (C) increase 4 times (D) decrease 2 times

42. According to Kepler's second law, the radial vector to a planet from the Sun sweeps out equal areas in equal intervals of time. This law is a consequence of

(A) conservation of linear momentum. (B) conservation of angular momentum
 (C) conservation of energy. (D) conservation of kinetic energy

43. The gravitational potential energy of the Moon with respect to Earth is

(A) always positive. (B) always negative. (C) can be positive or negative. (D) always zero

44. The work done by the Sun's gravitational force on the Earth is

(A) always zero. (B) always positive (C) can be positive or negative (D) always negative

45. If the acceleration due to gravity becomes 4 times its original value, then escape speed

- (A) remains same. (B) 2 times of original value
(C) becomes halved (D) 4 times of original value

ANSWER KEY : MULTIPLE CHOICE QUESTIONS

1	A	2	C	3	C	4	B	5	A	6	B	7	A	8	B	9	C
10	D	11	C	12	C	13	B	14	A	15	B	16	D	17	A	18	C&D
19	B	20	B	21	B	22	A	23	C	24	D	25	A	26	C	27	B
28	C	29	C	30	D	31	D	32	C	33	C	34	B	35	B	36	A
37	C	38	C	39	D	40	D	41	C	42	B	43	B	44	C	45	B

II. ASSERTION AND REASON TYPE QUESTIONS

Directions: In each of the following questions, a statement of Assertion is given and a corresponding statement of Reason is given just below it. Of the statements, given below, mark the correct answer as:

- (a) Both assertion and reason are true and reason is the correct explanation of assertion.
(b) Both assertion and reason are true but reason is not the correct explanation of assertion.
(c) Assertion is true but reason is false.
(d) Both Assertion and Reason are false.

1. Assertion : Universal gravitational constant G is a scalar quantity.

Reason : The value of G is same throughout the universe.

2. Assertion : When distance between two bodies is doubled and also mass of each body is doubled, then the gravitational force between them remains the same.

Reason : According to Newton's law of gravitation, product of force is directly proportional to the product mass of bodies and inversely proportional to square of the distance between them.

3. Assertion : A man is sitting in a boat which floats on a pond. If the man drinks some water from the pond, the level of water in the pond will decrease.

Reason : The weight of the liquid displaced by the body is greater than the weight of the body.

4. Assertion: During a journey from the earth to the moon and back, maximum fuel is spent to overcome the earth's gravity at take-off.

Reason : Earth's mass is much greater than that of the moon.

5. Assertion : Any two objects in the universe attract each other by a force called gravitation force.

Reason : The force of gravitation exerted by the earth is called gravity.

6. Assertion : An object floats if it displaces an amount of liquid whose weight is greater than the actual weight of the object.

Reason : During floatation an object experiences no net force in the downward direction.

7. Assertion : Weight of a body on earth is equal to the force with which the body is attracted towards the earth.

~~**Reason :** Weight of a body is independent of the mass of the body.~~

8. Assertion : If we drop a stone and a sheet of paper from a balcony of first floor, then stone will reach the ground first.

Reason : The resistance due to air depends on velocity only.

9. Assertion : The density of a liquid depends upon the nature and temperature of the liquid.

Reason : The volume of the liquid depends upon temperature.

10. Assertion : The value of acceleration due to gravity changes with the height, depth and shape of the earth.

Reason : Acceleration due to gravity is zero at the centre of the earth.

11. Assertion : It is the gravitational force exerted by the sun and the moon on the sea water that causes to the formation of tides in the sea.

Reason : Gravitational force of attraction is a strong force.

12. Assertion: The time period of geostationary satellite is 24 hours.

Reason: Geostationary satellite must have the same time period as the time taken by the earth to complete one revolution about its axis.

13. Assertion: Smaller the orbit of the planet around the sun, shorter is the time it takes to complete one revolution.

Reason: According to Kepler's third law of planetary motion, square of time period is proportional to cube of mean distance from sun.

ANSWERS TO ASSERTION AND REASON TYPE QUESTIONS

1	a	2	a	3	d	4	a	5	B	6	b	7	C
8	C	9	a	10	b	11	C	12	c	13	c		

III. CASE STUDY TYPE QUESTIONS

QUESTION : 1

LAW OF ORBIT: The orbit of every planet is an ellipse around the sun with sun at one of the two foci of ellipse.

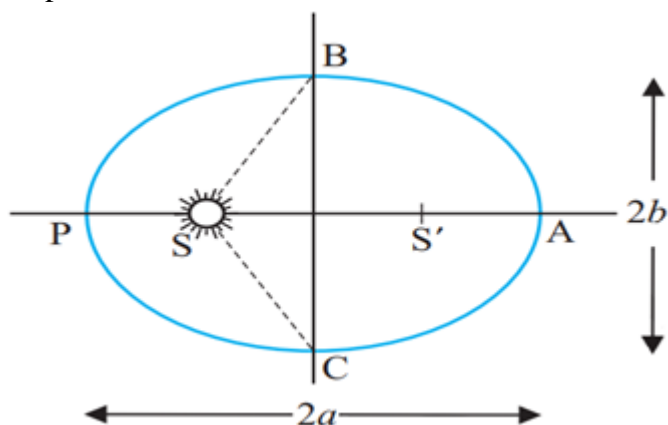

LAW OF AREAS: The line that joins a planet to the sun sweeps out equal areas in equal intervals of time. Area covered by the planet while revolving around the sun will be equal in equal intervals of time. This means the rate of change of area with time is constant.

LAW OF PERIOD: According to this law the square of time period of a planet is directly proportional to the cube of the semi-major axis of its orbit.

Suppose earth is revolving around the sun then the square of the time period (time taken to complete one revolution around sun) is directly proportional to the cube of the semi major axis.

It is known as Law of Periods as it is dependent on the time period of planets. Answer the following.

- 1) Kepler's second law is known as
a) Law of period. b) Law of area. c) Law of gravity d) None of these
- 2) Kepler's third law is known as
a) Law of period. b) Law of area. c) Law of gravity. d) None of these
- 3) The velocity of a planet is constant throughout its elliptical trajectory in an orbit.
a) True. b) False. c) None of these
- 4) Two objects of masses 5kg and 10 kg separated by distance 10m. What is gravitational force between them?

Answer Key : 1)c. 2) a. 3) a 4) $F=3.33 \times 10^{-11}N$

QUESTION : 2

Satellites in a circular orbits around the earth in the equatorial plane with $T = 24$ hours are called Geostationary Satellites. Clearly, since the earth rotates with the same period, the satellite would appear fixed from any point on earth. It takes very powerful rockets to throw up a satellite to such large heights above the earth but this has been done in view of the several benefits of much practical application. Weight of an object is the force with which the earth attracts it. We are conscious of our own weight when we stand on a surface, since the surface exerts a force opposite to our weight to keep us at rest. The same principle holds good when we measure the weight of an object by a Spring balance hung from a fixed point e.g. the ceiling. The object would fall down unless it is subject to a force opposite to gravity. This is exactly what the spring exerts on the object. This is because the spring is pulled down a little by the gravitational pull of the object and in turn the spring exerts a force on the object vertically upwards. Now, imagine that the top end of the balance is no longer held fixed to the top ceiling of the room. Both ends of the spring as well as the object move with identical acceleration g . The spring is not stretched and does not exert any upward force on the object which is moving down with acceleration g due to gravity. The reading recorded in the spring balance is zero since the spring is not stretched at all. If the object were a human being, he or she will not feel his weight since there is no upward force on him. Thus, when an object is in free fall, it is weightless and this phenomenon is usually called the phenomenon of weightlessness. In a satellite around the earth, every part and parcel of the satellite has acceleration towards the centre of the earth which is exactly the value of earth's acceleration due to gravity at that position. Thus in the satellite everything inside it is in a state of free fall. This is just as if we were falling towards the earth from a height. Thus, in a manned satellite, people inside experience no gravity. Gravity for us defines the vertical direction and thus for them there are no horizontal or vertical directions, all directions are the same.

- 1) Astronaut experiences weightlessness in space because
a) Acceleration due to gravity is zero. b) Actual weight of astronaut is zero
c) They are going with same acceleration due to gravity. d) None of these
- 2) Weighing machine measures
a) Mass of the person. b) Normal reaction exerted by machine on person
c) Both a and b. d) None of these
- 3) What is geostationary satellite?
- 4) What is weight? How it is measured?
- 5) What is weightlessness astronaut in satellite experienced by ?

Answer key : 1) c. 2) b

3) Satellites in a circular orbits around the earth in the equatorial plane with $T = 24$ hours are called Geostationary Satellites. Clearly, since the earth rotates with the same period, the satellite looks like stationary object from earth.

4) Weight of an object is the force with which the earth attracts it. It is measured with the help of spring balance.

5) Weightlessness is condition in which acceleration due to gravity is balanced by satellite as it is moving and astronaut don't feel any weight hence called weightlessness. In a satellite around the earth, every part and parcel of the satellite has acceleration towards the centre of the earth which is exactly the value of earth's acceleration due to gravity at that position. Thus in the satellite everything inside it is in a state of free fall. Thus, in a manned satellite, people inside experience no gravity.

QUESTION : 3

If a stone is thrown by hand, we see it falls back to the earth. Of course using machines we can shoot an object with much greater speeds and with greater and greater initial speed, the object scales higher and higher heights. A natural query that arises in our mind is the following: can we throw an object with such high initial speeds that it does not fall back to the earth ?

Thus, minimum speed required to throw object to infinity away from earth's gravitational field is called escape velocity = $\sqrt{2gr}$

Where g is acceleration due to gravity and r is radius of earth and after solving v_e 11.2 km/s. This is called the escape speed, sometimes loosely called the escape velocity. This applies equally well to an object thrown from the surface of the moon with g replaced by the acceleration due to Moon's gravity on its surface and r replaced by the radius of the moon. Both are smaller than their values on earth and the escape speed for the moon turns out to be 2.3 km/s, about five times smaller. This is the reason that moon has no atmosphere. Gas molecules if formed on the surface of the moon having velocities larger than this will escape the gravitational pull of the moon.

Earth satellites are objects which revolve around the earth. Their motion is very similar to the motion of planets around the Sun and hence Kepler's laws of planetary motion are equally applicable to them. In particular, their orbits around the earth are circular or elliptic. Moon is the only natural satellite of the earth with a near circular orbit with a time period of approximately 27.3 days which is also roughly equal to the rotational period of the moon about its own axis.

1.) Time period of moon is

- a) 27.3 days. b) 20 days. c) 85 days. d) None of these

2. Escape velocity from earth is given by

- a) 20 km/s. b) 11.2 km/s c) 2 km/s. d) None of these

3. Define escape velocity. Give its formula

4. Why moon don't have any atmosphere?

5. What is satellite? Which law governs them?

Answer key: 1) a. 2) b

3) Minimum speed required to throw object to infinity away from earth's gravitational field is called escape velocity = $\sqrt{2gr}$

Where g is acceleration due to gravity and r is radius of earth and after solving v_e 11.2 km/s. This is called the escape speed, sometimes loosely called the escape velocity.

4) The escape speed for the moon turns out to be 2.3 km/s, about five times smaller than that of earth. Therefore all atmospheric gas can go easily out of atmosphere of moon. This is the reason that moon has no atmosphere.

5) Earth satellites are objects which revolve around the earth. Their motion is very similar to the motion of planets around the Sun and hence Kepler's laws of planetary motion are equally applicable to them.

QUESTION : 4

Satellites in a circular orbits around the earth in the equatorial plane with $T = 24$ hours are called Geostationary Satellites. Clearly, since the earth rotates with the same period, the satellite would appear fixed from any point on earth. It takes very powerful rockets to throw up a satellite to such large heights above the earth but this has been done in view of the several benefits of many practical applications. Thus radio waves broadcast from an antenna can be received at points far away where the direct wave fails to reach on account of the curvature of the earth. Waves used in television broadcast or other forms of communication have much higher frequencies and thus cannot be received beyond the line of sight. A Geostationary satellite, appearing fixed above the broadcasting station can however receive these signals and broadcast them back to a wide area on earth. The INSAT group of satellites sent up by India is one such group of geostationary satellites widely used for telecommunications in India.

Another class of satellites is called the Polar satellites. These are low altitude (500 to 800 km) satellites, but they go around the poles of the earth in a north-south direction whereas the earth rotates around its axis in an east-west direction. Since its time period is around 100 minutes it crosses any altitude many times a day. However, since its height h above the earth is about 500-800 km, a camera fixed on it can view only small strips of the earth in one orbit. Adjacent strips are viewed in the next orbit, so that in effect the whole earth

can be viewed strip by strip during the entire day. These satellites can view polar and equatorial regions. at close distances with good resolution. Information gathered from such satellites is extremely useful for remote sensing, meteorology as well as for environmental studies of the earth.

- 1) Time period of geostationary satellite is
 - a) 24 hours. b) 48 hours. c) 72 hours. d) None of these
- 2) Polar satellites are approximately revolving at height of
 - a) 500 to 800km. b) 1500 to 2000 km c) 3000 to 4000 km d) None of these
- 3) Which satellite used to view polar and equatorial regions?
- 4) Write note on polar satellites
- 5) Write a note on geostationary satellite. Give its applications.

Answer Key: 1) a. 2) a

3) Polar satellites are used to view polar and equatorial regions as they rotate on poles of earth.

4) Polar satellites are low altitude (500 to 800 km) satellites, but they go around the poles of the earth in a north-south direction. Since its time period is around 100 minutes it crosses any altitude many times a day. Information gathered from such satellites is extremely useful for remote sensing, meteorology as well as for environmental studies of the earth.

5) Satellites in circular orbits around the earth in the equatorial plane with time period same as earth are called Geostationary Satellites.

Applications:- Radio waves broadcast. Satellites widely used for telecommunications in India. GPS system, navigation system , defence etc.

QUESTION : 5

We know that the earth attracts every object with a certain force and this force depends on the mass (m) of the object and the acceleration due to the gravity (g). The weight of an object is the force with which it is attracted towards the earth. Mathematically

Where, W = weight of object m = mass of object g = acceleration due to the gravitational force

As the weight of an object is the force with which it is attracted towards the earth, the SI unit of weight is the same as that of force, that is, Newton (N). The weight is a force acting vertically downwards; it has both magnitude and direction. We have learnt that the value of g is constant at a given place. Therefore at a given place, the weight of an object is directly proportional to the mass, say m , of the object, that is, $W \propto m$. It is due to this reason that at a given place, we can use the weight of an object as a measure of its mass. Answer the following questions.

- 1) Dimensions of acceleration due to the gravity (g) is
 - a) $[ML^1 T^{-2}]$. b) $[ML^{-1} T^{-2}]$. c) $[ML^1 T^{-3}]$. d) None of these
- 2) SI unit of weight is same as
 - a) Force. b) Mass. c) Acceleration due to gravity d) None of these
- 3) Which of the following has same unit?
 - a) Mass and weight. b) Weight and force. c) Pressure and stress. d) Both b and c
- 4) Whether weight is scalar quantity or vector quantity? Justify your answer.
- 5) Differentiate between mass and weight.

Answer key: 1) b. 2) a. 3) b

4) Weight is vector quantity as it has magnitude as well as direction which is always towards centre of a earth.

5) Difference between mass and weight is given below

No	Mass	Weight
1	Mass is amount of matter in a body.	Weight is the measure of force acting on a mass due to acceleration due to gravity.
2	it is a scalar quantity	it is a vector quantity

3	SI unit of mass is Kilogram (Kg).	SI unit of weight is Newton (N).
4.	Mass can never be zero	Weight can be zero where gravity is zero.

QUESTION : 6

Every object in the universe attracts every other object with a force which is proportional to the product of their masses ($m_1 \cdot m_2$) and inversely proportional to the square of the distance (d^2) between them. The force is along the line joining the centres of two objects.

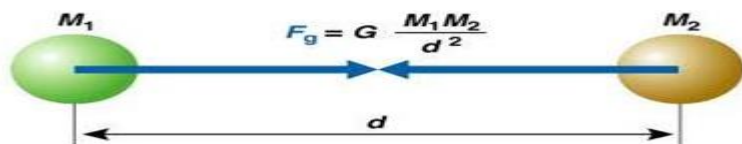

(i) Gravitational force does not depend on

- (a) Masses of objects. (b) Separation between objects (c) Charges on objects (d) None of these

(ii) Force of gravitation varies with masses of object as

- (a) Product of masses. (b) Sum of masses. (c) Difference of masses (d) None of these

(iii) When mass of one body is doubled then force of gravitation will become

- (a) Force will remain same. (b) Force will become double
(c) Force will become halved. (d) None of these

(iv) What is universal gravitational constant? What is its SI unit?

Answer key : (i) c. (ii) a. (iii) b

(iv) The force of attraction between any two unit masses separated by a unit distance is called universal gravitational constant denoted by G measured in Nm^2/kg^2 .

IV ONE MARK QUESTIONS

- Why is gravitational potential energy always negative?
- At what height above the surface of the earth value of acceleration due to gravity is reduced to one fourth of its value on the surface of the earth?
- Name two factors which determine whether a planet has atmosphere or not?
- A body is weightless at the centre of earth. Why?
- Where will a body weigh more at Delhi or at Shimla? Why?
- On which fundamental law of physics is Kepler's second law is based?
- The mass of moon is nearly 10% of the mass of the earth. What will be the gravitational force of the earth on the moon, in comparison to the gravitational force of the moon on the earth?
- Why does one feel giddy while moving on a merry round?
- Name two factors which determine whether a planet would have atmosphere or not.
- The force of gravity due to earth on a body is proportional to its mass, then why does a heavy body not fall faster than a lighter body?
- A body of mass 5 kg is taken to the centre of the earth. What will be its (i) mass (ii) weight there.
- Why is gravitational potential energy negative?
- A satellite revolves close to the surface of a planet. How is its orbital Velocity related with escape velocity of that planet.
- Does the escape Velocity of a body from the earth depend on (i) mass of the body (ii) direction of projection.
- Identify the position of sun in the following diagram if the linear speed of the planet is greater at C than at D.

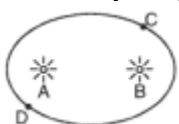

16. A satellite does not require any fuel to orbit the earth. Why?
17. Is it possible to place an artificial satellite in an orbit so that it is always Visible Over New Delhi.
18. If the density of a planet is doubled without any change in its radius, how does "g" change on the planet.
19. Write one important use of (i) geostationary satellite (ii) polar satellite.
20. A binary star system consists of two stars A and B which have time periods T_A and T_B , radius R_A and R_B and masses m_A and m_B which of the three quantities are same for the stars. Justify.

SOLUTIONS TO 1 MARK QUESTIONS

1. Gravitational potential energy is always negative because gravitational force is always attractive in nature.

$$2. \quad g_h = g/4 = g \left(\frac{R}{R+h} \right)^2$$

$$\frac{R}{R+h} = \frac{1}{\sqrt{4}} = \frac{1}{2}$$

$$R = h$$

$$2R - R = h$$

3. (1) Acceleration due to gravity at the surface of planet (2) Surface temperature of the planet.

4. At the centre of the earth $g = 0$

$$\therefore w = mg = 0$$

5. A body will weigh more at Delhi because at higher altitudes the value of g decreases.

6. Law of conservation of angular momentum.

7. Both forces will be equal in magnitude as gravitational force is a mutual force between the two bodies.

8. When moving in a merry go round, our weight appears to decrease when we move down and increases when we move up, this change in weight makes us feel giddy.

9. (i) Value of acceleration due to gravity (ii) surface temperature of planet.

$$\therefore F = \frac{GMm}{R^2} \quad F \propto m \quad \text{but} \quad g = \frac{Gm}{R^2}$$

10. and does not depend on "m" hence they bodies fall with same "g".

11. Mass does not change.

12. Because it arises due to attractive force of gravitation.

$$13. \quad v_s = \sqrt{2} v_o \quad \therefore v_s = \sqrt{\frac{2GM}{R}} \quad v_o = \sqrt{\frac{GM}{R}} \quad \text{When } r = R$$

$$14. \quad \text{No,} \quad v_s = \sqrt{\frac{2GM}{R}}$$

15. Sun should be at B as speed of planet is greater when it is closer to sun.

16. The gravitational force between satellite and earth provides the necessary centripetal force for the satellite to orbit the earth.

17. No, A satellite will be always visible only if it revolves in the equatorial plane, but New Delhi does not lie in the region of equatorial plane.

18. "g" gets doubled as $g \propto \rho$ (density)

19. Geostationary satellite are used for tele communication and polar satellite for remote sensing.

$$20. \quad \text{Angular velocity of binary stars are same is } \omega_A = \omega_B, \quad \frac{2\pi}{T_A} = \frac{2\pi}{T_B} \Rightarrow T_A = T_B$$

V TWO MARK QUESTIONS

1. What is Kepler's law of periods? Show it mathematically?

2. With two characteristics of gravitational force?

3. Assuming earth to be a uniform sphere finds an expression for density of earth in terms of g and G?

4. State two essential requisites of geostationary satellite?

5. Does the escape speed of a body from the earth depend on

- (a) the mass of the body, (b) the location from where it is projected,

- (c) the direction of projection, (d) the height of the location from where the body is launched?

6. Two satellites are at different heights from the surface of earth which would have greater velocity.

- Compare the speeds of two satellites of masses m and 4m and radii. 2R and R respectively.

7. What is (i) inertial mass, (ii) gravitational mass. Are the two different?

8. Why the space rockets are generally launched West to East?

9. The figure shows elliptical orbit of a planet m about the sun S . The shaded area of SCD is twice the shaded area SAB . If t_1 is the time for the planet to move from D to C and t_2 is time to move from A to B , what is the relation between t_1 and t_2 ?

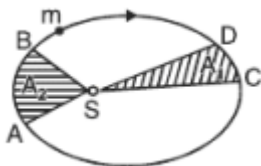

10. State universal law of gravitation. How the force between the two bodies is affected if the distance between them is tripled?

SOLUTIONS TO TWO MARK QUESTIONS

1. It states that the square of the period of revolution of a planet around the sun is proportional of a planet to the cube of the semi-major axis of the elliptical orbit.

i.e. $T^2 \propto R^3$

$T^2 = KR^3$

where T is time period of revolution

R is the length of semi major axis

K is constant for all planets

2. (1) It is a central force (2) It is a conservation force

(3) It obeys inverse square law. (4) It is a universal force and is always attractive in nature.

$$\frac{GM}{R^2}$$

3. Since $g = \frac{GM}{R^2}$

If earth is uniform sphere of mean density P

$$g = \frac{G}{R^2} \left(\frac{4}{3} \pi R^3 P \right)$$

$$g = \frac{4}{3} \pi G R P$$

$$\Rightarrow P = \frac{3g}{4\pi GR}$$

4. (1) The period of revolution of a satellite around the earth should be same as that of earth about its own axis ($T=24$ hrs)

(2) The sense of rotation of satellite should be same as that of the earth about its own axis i.e. from west to east in anti-clockwise direction

5. (a) No. (b) No. (c) No. (d) Yes

$$v_o = \sqrt{\frac{GM}{R+h}}$$

6.

$$\therefore \frac{v_{o1}}{v_{o2}} = \left(\frac{1}{\sqrt{2}} \right), \text{ where } M \text{ is mass of the planet,}$$

v_o is independent of mass of the satellite.

$$= m_i = \frac{F}{a}$$

7. Inertial mass is the measure of inertia of the body

Gravitational mass of a body determine the gravitational pull between earth and the body.

$$m_g = \frac{FR^2}{GM}$$

Both inertial mass and gravitational mass are not different but are equivalent.

8. Since the earth revolves from West to east, so when the rocket is launched from west to east the relative velocity of the rocket increases which helps it to rise without much consumption of fuel.

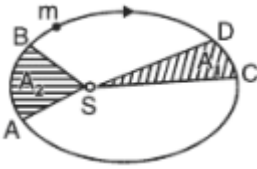

9. According to Kepler's second law areal velocity for the planet is constant

$$\therefore \frac{A_1}{t_1} = \frac{A_2}{t_2} \quad A_1 = 2A_2$$

$$\therefore \frac{2A_2}{t_1} = \frac{A_2}{t_2}$$

$$t_1 = 2t_2$$

VI THREE MARK QUESTIONS

1. A satellite is revolving in a circular path close to a planet of density P . Find an expression for its period of revolution?
2. How far away from the surface of earth does the value of g is reduced to 4% of its value on the surface of the earth
Given radius of earth = 6400km
3. Obtain an expression showing variation of acceleration due to gravity with height?
4. Find expressions for (1) potential energy (2) kinetic energy (3) total energy for an artificial satellite.
5. Suppose there existed a planet that went around the sun twice as fast as the earth. What would be its orbital size as compared to that of the earth?
6. Define gravitational potential at a point in the gravitational field. Obtain a relation for it. What is the position at which it is (i) maximum (ii) minimum.
7. Briefly explain the principle of launching an artificial satellite. Explain the use of multistage rockets in launching a satellite.
8. Mention at least three conditions under which weight of a person can become Zero.
9. If the distance between two bodies is increased by 4 times, by what factor should the mass of the bodies be altered so that gravitational force between them remains the same?
10. What is the force between two spheres each weighing 20 kg and separated by 50 cm.

VII FIVE MARK QUESTIONS

1. Define and derive the expression for gravitational potential energy.
2. Derive an expression for escape velocity and orbital velocity.
3. Explain the variation of g with latitude.
4. Explain the variation of g with altitude and with depth from the Earth's surface.

VIII . NUMERICALS

1. The gravitational force between two blocks is F what would happen if a mass of both the blocks as well as distance between them is doubled?
2. Which is greater the attraction of the earth for 1 kg of aluminium or aluminium or attraction of 1kg of aluminium for the earth?
3. Distance between two bodies is increased to three times its original value. What is the effect on the gravitational force between them?
4. The gravitational force between two bodies is 1 N if the distance between them is doubled, What will be the force between them?
5. The time period of the satellite of the earth is 5 hr. If the separation between earth and satellite is increased to 4 times the previous value, then what will be the new time period of satellite.
6. If radius of earth is 6400km, what will be the weight of 1 quintal body if taken to the height of 1600 km above the sea level?

7. The distance of the planet Jupiter from the sun is 5.2 times that of the earth. Find the period of the Jupiter's revolution around the sun?
8. Two planets of radii r_1 , and r_2 are made from the same material. Calculate the ratio of the acceleration due to gravity on the surface of the planets.
9. If earth has a mass 9 times and radius 4 times than that of a planet "P". Calculate the escape velocity at the planet "P" if its value on earth is 11.2 km s^{-1} .
10. At what height from the surface of the earth will the value of "g" be reduced by 36% of its value at the surface of earth.
11. Which planet of the solar system has the greatest gravitational field strength? What is the gravitational field strength of a planet where the weight of a 60 kg astronaut is 300 N.

ANSWER KEY TO NUMERICALS

$$1. \text{ We know } F = \frac{Gm_1m_2}{r^2}$$

Here $m_1 = m_2 = 2m$

$$r_1 = r_2 = 2r$$

$$\Rightarrow F = \frac{G(2m)(2m)}{4r^2} = \frac{Gm^2}{r^2}$$

i.e. force will remain the same.

2. In accordance with the universal law of gravitation both the forces are equal and opposite.

$$3. \text{ Since } F \propto \frac{1}{r^2} \quad r_1 \rightarrow 3r \quad \text{Force will be decreased to } 1/9 \text{ times}$$

$$4. F = \frac{F}{4}$$

$$5. \frac{T_2^2}{T_1^2} = \left(\frac{R_2}{R_1}\right)^3 \Rightarrow T_2^2 = 64 \times 25 \Rightarrow T_2 = 40 \text{ hr}$$

$$6. R = 6400 \text{ km} = 6400 \times 10^3 \text{ m}$$

$$h = 1600 \text{ km}$$

$$w = mg = 1 \text{ quintal} = 100 \text{ kg} = 100 \times 9.8 \text{ N}$$

$$\text{weight (w)} = mgh$$

$$w = mg \left(\frac{R}{R+h}\right)^2$$

$$w = 100 \times 9.8 \left(\frac{6400}{1600+6400}\right)^2$$

$$w = 64 \times 9.8 \text{ N} = 64 \text{ kg}$$

$$7. T_e = 1 \text{ year} \quad R_J = 5.2 R_e$$

$$\left(\frac{T_J}{T_e}\right)^2 = \left(\frac{R_J}{R_e}\right)^3$$

$$T_J = (5.2)^{3/2} \times 1 \text{ year}$$

$$T_J = 11.86 \text{ year}$$

$$8. g = \frac{GM}{r^2} = \frac{G\rho \frac{4}{3}\pi r^3}{r^2} = \frac{4\pi}{3} G\rho r$$

$$g \propto r$$

$$\therefore \frac{g_1}{g_2} = \frac{r_1}{r_2}$$

$$9. \quad v_e = \sqrt{\frac{2GM}{R_e}} \quad v_p = \sqrt{\frac{2GM_p}{R_p}} \quad M_p = \frac{M}{9}, \quad R_p = \frac{R_e}{4}$$

$$\therefore v_p = \sqrt{2G \frac{M}{9} \times \frac{4}{R_e}} = \frac{2}{3} \sqrt{\frac{2GM}{R_e}} = \frac{2}{3} \times 11.2 = \frac{22.4}{3}$$

$$= 7.47 \text{ km/sec}$$

$$10. \quad g' = 64\% \text{ of } g = \frac{64}{100} g$$

$$g' = g \frac{R^2}{(R+h)^2} = \frac{64}{100} g$$

$$\therefore \frac{R}{R+h} = \frac{8}{10}$$

$$h = \frac{R}{4} = 1600 \text{ km}$$

11. Jupiter has maximum gravitational field strength

$$= \frac{F}{m} = \frac{300}{60}$$

$$= 5 \text{ N kg}^{-1}$$

PROPERTIES OF BULK MATTER

MECHANICAL PROPERTIES OF SOLIDS

Elasticity, Stress-strain relationship, Hooke's law, Young's modulus, bulk modulus, shear modulus of rigidity (qualitative idea only), Poisson's ratio; elastic energy.

Deleted portions for 2022-23

Chapter	Page .No	Dropped topics/Chapters
Chapter–09: Mechanical Properties of solids	236	9.2 Elastic behavior of solids
	241	9.6.2 Determination of Youngs Modulus of the material of a wire.
	249	Exercises 9.17-9.21

GIST OT THE LESSON (with key points)

1. Solid bodies are not perfectly rigid.
2. A solid has definite shape and size. To change (or deform) the shape or size of a body, a force is required.
3. The property of a body, by virtue of which it tends to regain its original size and shape when the applied force is removed, is known as **elasticity** and the deformation caused is known as elastic deformation.
4. Some substances have no gross tendency to regain their previous shape, and they get permanently deformed. Such substances are called plastic and this property is called **plasticity**. Putty and mud are close to ideal plastics.

5. STRESS AND STRAIN

- i). The restoring force is equal in magnitude but opposite in direction to the applied force. The restoring force per unit area is known as stress. Magnitude of the stress = F/A . The SI unit of stress is $N\ m^{-2}$ or pascal (Pa) and its dimensional formula is $[ML^{-1}T^{-2}]$.
- ii). Strain is the fractional change in dimension.
- iii). Three types of stresses (a) tensile stress (associated with stretching) or compressive stress (associated with compression) as longitudinal stress (b) shearing stress, and (c) hydraulic stress.
- iv) The restoring force per unit area in stretching or compressing a solid like cylinder is called tensile stress or compressive stress. Tensile or compressive stress can also be termed as longitudinal stress.
- v) The restoring force per unit area developed due to the applied tangential force is known as tangential or shearing stress.
- vi) A solid sphere placed in the fluid under high pressure is compressed uniformly on all sides. The force applied by the fluid acts in perpendicular direction at each point of the surface and the body is said to be under hydraulic compression. This leads to decrease in its volume without any change of its geometrical shape. The internal restoring force per unit area in this case is known as hydraulic stress

- vii). Longitudinal strain = $\frac{\Delta L}{L}$, Shearing strain = $\frac{\Delta x}{L} = \tan \theta$, Volume strain = $\frac{\Delta V}{V}$

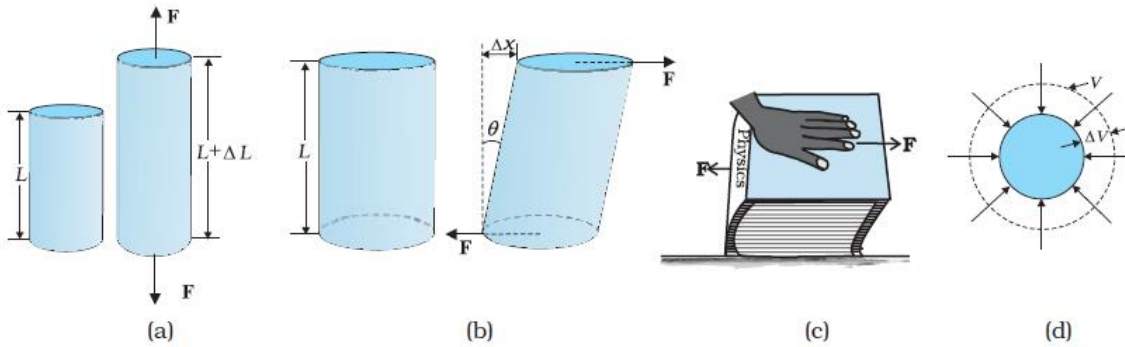

(a) Cylinder subjected to tensile stress stretches it by an amount ΔL . (b) A cylinder subjected to shearing (tangential) stress deforms by an angle θ . (c) A book subjected to a shearing stress. (d) A solid sphere subjected to a uniform hydraulic stress shrinks in volume by an amount ΔV .

6. For small deformations, stress is directly proportional to the strain for many materials. This is known as **Hooke's law**. The constant of proportionality is called modulus of elasticity.

7. Stress strain curve for a metal

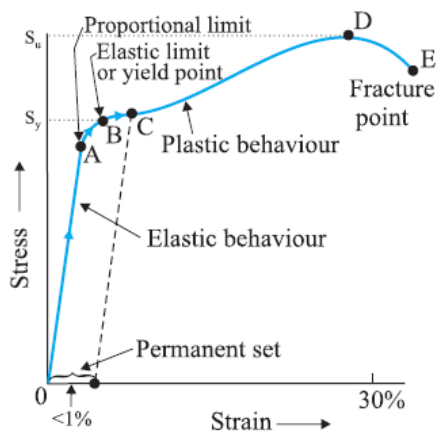

A typical stress-strain curve for a metal.

Discussions on the Curve

- i) In figure, in the region O to A, the curve is linear i.e., Hooke's law (stress \propto strain) is valid in this region. Here the solid behaves as an elastic body.
- ii) In the region A to B, the stress and strain are not proportional. However, if we remove the load, the body returns to its original dimension.
- iii) The point B in the curve is the yield point or the elastic limit and the corresponding stress is the yield strength (s_y) of the material.
- iv) Once the load is increased further, the strain increases rapidly even for a small change in the stress as in the region from B to D.
- v) If the load is removed at a point C, between B and D, the body does not regain its original dimension. Hence, even when the stress is zero, the strain is not zero, material is said to have a permanent set and the deformation is called plastic deformation.
- vi) Further the point D is the ultimate tensile strength (s_u) of the material. Hence, if any additional strain is produced beyond this point, a fracture can occur (at point E).
- vii) If the ultimate strength and fracture points are close to each other (points D and E), then the material

is brittle.

viii) If the ultimate strength and fracture points are far apart (points D and E), then the material is ductile.

ix) In the following graph

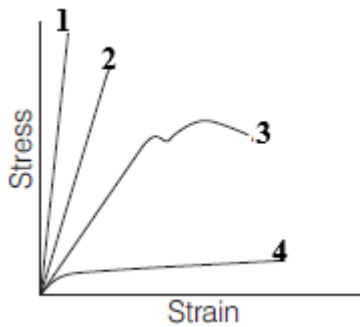

- 1 A brittle material
2. A strong material which is not ductile
3. A ductile material
4. A plastic material

x)

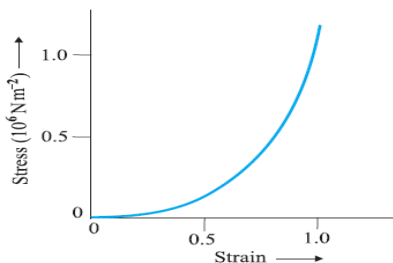

Stress-strain curve for the elastic tissue of Aorta, the large tube (vessel) carrying blood from the heart. Although elastic region is very large, the material does not obey Hooke's law over most of the region. Secondly, there is no well defined plastic region. Substances like tissue of aorta, rubber etc. which can be stretched to cause large strains are called elastomers. ie A class of solids called elastomers does not obey Hooke's law.

8. Three elastic moduli viz., Young's modulus, shear modulus and bulk modulus are used to describe the elastic behaviour of objects

*Materials which offer more resistance to external deforming forces have higher value of modulus of elasticity.

Young's Modulus of Elasticity

$$Y = \frac{F/A}{\Delta l/l} = \frac{Fl}{A \Delta l}$$

Steel is more elastic than copper, brass and aluminium. For this reason that steel is preferred in heavy-duty machines and in structural designs. Wood, bone, concrete and glass have rather small Young's moduli.

Bulk Modulus of Elasticity

$$B = \frac{F/A}{\Delta V/V} = - \frac{\Delta p}{\Delta V/V}$$

The negative sign indicates the fact that with an increase in pressure, a decrease in volume occurs..

The reciprocal of the bulk modulus is called **compressibility** and is denoted by k . It is defined as the fractional change in volume per unit increase in pressure.

$$k = (1/B) = - (1/\Delta p) \times (\Delta V/V)$$

Bulk moduli for solids \gg than for liquids, which are again \gg than for gases (air). Thus solids are least compressible whereas gases are most compressible.

Shear Modulus of Elasticity or Modulus of Rigidity

$$G = (F/A)/\theta = F/(A \times \theta)$$

*Solids have all three moduli of elasticities, Young's modulus, bulk modulus and shear modulus whereas liquids and gases have only bulk modulus.

9. APPLICATIONS OF ELASTIC BEHAVIOUR OF MATERIALS

If a beam is fixed at its ends and loaded with weight at its middle (as shown below), then depression at the centre,

$$\delta = W l^3 / (4bd^3Y)$$

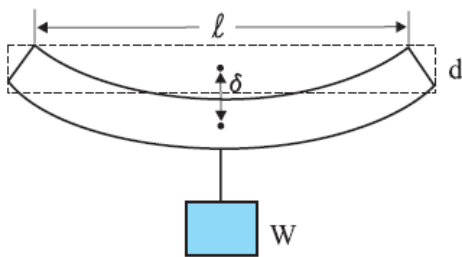

where, Y = Young's modulus, w = weight of beam, l = length of beam, b = breadth of beam and d = thickness of beam.

10. Poisson's Ratio

. The strain perpendicular to the applied force is called lateral strain.

Within the elastic limit, the ratio of the lateral strain to the longitudinal strain in a stretched wire is called

$$\text{Poisson's ratio } \sigma = \frac{\text{Lateral contraction strain}}{\text{Longitudinal elongation strain}} = \frac{\Delta d/D}{\Delta l/l}$$

where, Δd = change in diameter, D = original diameter, Δl = change in length and l = original length.

It is a pure number and has no dimensions or units. Its value depends only on the nature of material.

For steels, its value is between 0.28 and 0.30 and for aluminum alloys, it is about 0.33.

11. Elastic Potential Energy in a Stretched Wire

When a wire is put under a tensile stress, work is done against the inter-atomic forces. This work is stored in the wire in the form of elastic potential energy.

The amount of work done (W) in increasing the length of the wire from L to L + l, that is from l = 0 to l = l is

$$W = \int_0^l \frac{YAl}{L} dl = \frac{YA}{2} \times \frac{l^2}{L} \quad W = \frac{1}{2} \times Y \times \left(\frac{l}{L}\right)^2 \times AL$$

$W = \frac{1}{2} \times \text{Young's modulus} \times \text{strain}^2 \times \text{volume of the wire}$

$W = \frac{1}{2} \times \text{stress} \times \text{Strain} \times \text{volume of the wire}$

This work is stored in the wire in the form of elastic potential energy (U).

Therefore the **elastic potential energy per unit volume** of the wire (u) is $u = \frac{1}{2} \sigma \epsilon = \frac{1}{2} \text{ stress} \times \text{strain}$.

I. MULTIPLE CHOICE QUESTIONS

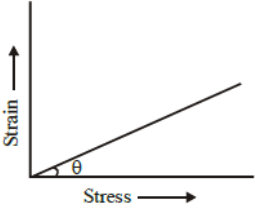
1	Elastomers are the materials which (a) are not elastic at all (c) do not obey Hooke's law (b) have very small elastic range (d) None of these
2	Which of the following has no dimensions ? (a) strain (b) angular velocity (c) momentum (d) angular momentum
3	Which one of the following is not a unit of Young's modulus ? (a) Nm^{-1} (b) Nm^{-2} (c) dyne cm^{-2} (d) mega pascal
4	The value of $\tan(90 - \theta)$ in the graph gives  (a) Young's modulus of elasticity (b) compressibility (c) shear strain (d) tensile strength
5	According to Hooke's law of elasticity, if stress is increased, then the ratio of stress to strain (a) becomes zero (b) remains constant (c) decreases (d) increases
6	The length of an iron wire is L and area of cross-section is A. The increase in length is l on applying the force F on its two ends. Which of the statement is correct? (a) Increase in length is inversely proportional to its length (b) Increase in length is proportional to area of cross-section (c) Increase in length is inversely proportional to area of cross-section (d) Increase in length is proportional to Young's modulus
7	A and B are two wires. The radius of A is twice that of B. They are stretched by the same load. Then the stress on B is (a) equal to that on A (b) four times that on A (c) two times that on A (d) half that on A
8	Hooke's law defines (a) stress (b) strain (c) modulus of elasticity (d) elastic limit
9	In case of steel wire (or a metal wire), the limit is reached when (a) the wire just break (b) the load is more than the weight of wire (c) elongation is inversely proportional to the tension (d) None of these
10	When an elastic material with Young's modulus Y is subjected to stretching stress S, elastic energy stored per unit volume of the material is (a) YS / 2 (b) $S^2 Y / 2$ (c) $S^2 / 2Y$ (d) $S / 2Y$

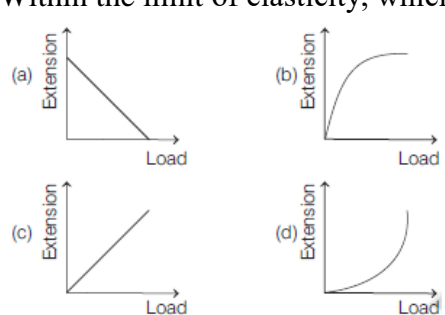
	The ratio of shearing stress to the corresponding shearing strain is called
11	(a) bulk modulus (b) Young's modulus (c) modulus of rigidity (d) None of these
12	A force of 10^3 newton, stretches the length of a hanging wire by 1 millimetre. The force required to stretch a wire of same material and length but having four times the diameter by 1 millimetre is (a) 4×10^3 N (b) 16×10^3 N (c) $\frac{1}{4} \times 10^3$ N (d) $\frac{1}{16} \times 10^3$ N
13	There are two wire of same material and same length while the diameter of second wire is two times the diameter of first wire, then the ratio of extension produced in the wires by applying same load will be (a) 1 : 1 (b) 2 : 1 (c) 1 : 2 (d) 4 : 1
14	The compressibility of water is 4×10^{-5} per unit atmospheric pressure. The decrease in volume of 100 cm^3 of water under a pressure of 100 atmosphere will be (a) 0.4 cm^3 (b) $4 \times 10^{-5} \text{ cm}^3$ (c) 0.025 cm^3 (d) 0.004 cm^3
15	A beam of metal supported at the two edges is loaded at the centre. The depression at the centre is proportional to (a) Y^2 (b) Y (c) $1/Y$ (d) $1/Y^2$
16	Elasticity is the property of the body, in which (a) it does not regain its original size (b) it regain its original size and shape (c) its shape changed but size remains same (d) None of the above
17	A wire is stretched to double of its length. The strain is (a) 2 (b) 1 (c) zero (d) 0.5
18	Within the limit of elasticity, which of the following graph obey Hooke's law? 
19	A copper and a steel wire of the same diameter are connected end to end. A deforming force F is applied to this composite wire which causes a total elongation of 1 cm. The two wires will have (a) the same stress and strain (b) the same stress but different strain (c) the same strain but different stress (d) different strains and stress
20	A uniform cube is subjected to volume compression. If each side is decreased by 1%, then bulk strain is (a) 0.01 (b) 0.06 (c) 0.02 (d) 0.03
21	The linear portion of a stress-strain curve obeys Hooke's law. The upper limit of this linear curve represents (a) yield point (b) permanent set (c) fracture point (d) proportional limit
22	Over bridges are constructed with steel but not with aluminium because steel is (a) more elastic than aluminium (b) less elastic than aluminium (c) more plastic than aluminium (d) less plastic than aluminium
II. ASSERTION- REASON TYPE QUESTIONS	
Direction <i>In the following questions, a statement of Assertion is followed by a corresponding statement of Reason. Of the following statements, choose the correct one.</i>	
(a) Both Assertion and Reason are correct and Reason is the correct explanation of Assertion. (b) Both Assertion and Reason are correct but Reason is not the correct explanation of Assertion. (c) Assertion is correct but Reason is incorrect. (d) Assertion is incorrect but Reason is correct.	
23	Assertion: For rubber, strain is more as compared to steel.

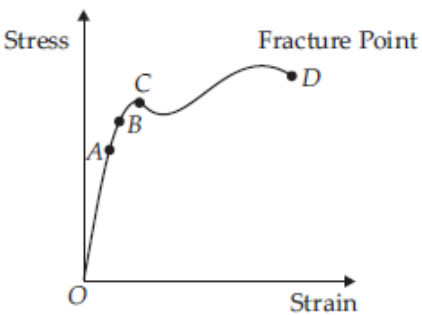
	Reason: Rubber is less elastic than steel.
24	Assertion: When a solid sphere is placed in the fluid under high pressure, then it is compressed uniformly on all sides. Reason :The force applied by fluids acts in perpendicular direction at each point of surface.
25	Assertion: Elongation produced in a body is directly proportional to the applied force. Reason :Within the elastic limit, stress is inversely proportional to the strain.
26	Assertion: Young’s modulus for a perfectly plastic body is zero. Reason: For a perfectly plastic body, restoring force is zero.
27	Assertion: Gases have large compressibility. Reason: Compressibility is defined as the fractional change in volume per unit decrease in pressure.
28	Assertion: Ropes are always made of a number of thin wires braided together. Reason: It helps to ease in manufacturing, flexibility and strength.
29	Assertion: Maximum height of a mountain on earth is ~ 10 km. Reason: A mountain base is not under uniform compression and provides some shearing stress to rock under which it can flow.
30	Assertion: Spring balance shows incorrect readings after using it for a long time. Reason :Spring in the spring balance loses its elastic strength over the period of time.
	<p>III. CASE BASED Questions</p> <p>Read the passage given below and answer the following questions from 31 to 35.</p> <p>Stress-Strain Curve</p> <p>The graph shown below shows qualitatively the relation between the stress and the strain as the deformation gradually increases. Within Hooke’s limit for a certain region stress and strain relation is linear. Beyond that up to a certain value of strain the body is still elastic and if deforming forces are removed the body recovers its original shape.</p> 
31	If deforming forces are removed up to which point the curve will be retraced? (a) upto OA only (b) upto OB (c) upto C (d) Never retraced its path
32	In the above question, during loading and unloading the force exerted by the material are conservative up to (a) OA only (b) OB only (c) OC only (d) OD only
33	During unloading beyond B , say C , the length at zero stress is now equal to (a) less than original length (b) greater than original length (c) original length (d) can’t be predicted
34	The breaking stress for a wire of unit cross section is called (a) yield point (b) elastic fatigue (c) tensile strength (d) Young’s modulus
35	Substances which can be stretched to cause large strains are called (a) isomers (b) plastomers (c) elastomers (d) polymers
36	<p>IV. Short answer questions (2 marks)</p> <p>The stress-strain graphs for materials A and B are shown in figure.</p>

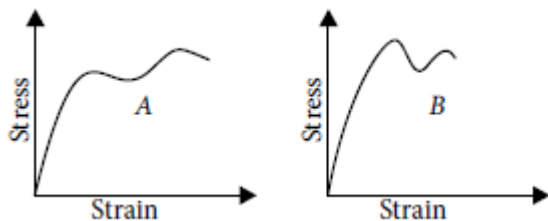

The graphs are drawn to the same scale. (a) Which is more brittle? (b) Which of the two is the stronger material?

37 A cable is replaced by another cable of the same length and material but twice the diameter. How will this affect the elongation under a given load?

38 What is the percentage increase in the length of a wire of diameter 2.5 mm stretched by a force of 100 kgf? Young's modulus of elasticity of the wire is 12.5×10^{11} dyne cm^{-2} .

39 Elasticity has different meaning in physics and in our daily life. Comment.

40 A heavy wire is suspended from a roof but no weight is attached to its lower end. Is it under stress? Justify

41 Steel is more elastic than rubber explain why?

V. Short answer questions (3 marks)

42 Define the terms stress and strain and give their si units. Draw stress vs strain graph for a metallic wire, when stretched upto a breaking point.

43 Define young's modulus, bulk modulus and rigidity modulus. Give their si units.

44 Prove that elastic energy density is equal to $\frac{1}{2}$ stress X strain.

V. Long answer questions (5 marks)

45 Define young's modulus of elasticity, normal stress and longitudinal strain. Give units of each of them. Derive an expression for the elastic potential energy of a wire, when it stretched.

VI. NUMERICALS

46 A truck is pulling a car out of a ditch by means of a steel cable that is 9.1 m long and has a radius of 5 mm. When the car just begins to move, the tension in the cable is 800 N. How much has the cable stretched? (Young's modulus for steel is 2×10^{11} Nm^{-2} .)

Figure shows the strain-stress curve for a given material. What are (a) Young's modulus, and (b) approximate yield strength for this material ?

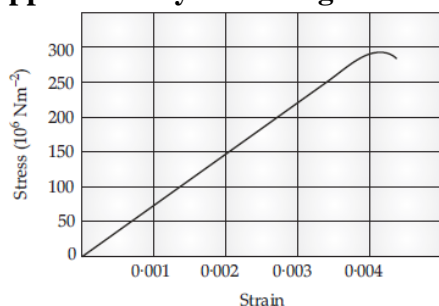

48 A steel wire of length 4.7 m and cross-sectional area 3.0×10^{-5} m^2 stretches by the same amount as a copper wire of length 3.5 m and cross-sectional area of 4.0×10^{-5} m^2 under a given load. What is the ratio of the Young's modulus of steel to that of copper?

49 Four identical hollow cylindrical columns of mild steel support a big structure of mass 50,000 kg. The inner and outer radii of each column are 30 and 60 cm respectively. Assuming the load distribution to be uniform, calculate the compressional strain of each column.

50 A steel cable with a radius of 1.5 cm supports a chairlift at a ski area. If the maximum stress is not to exceed 10^8 N m^{-2} , what is the maximum load the cable can support ?

ANSWER KEY.

1	2	3	4	5	6	7	8	9	10	11	12	13	14	15	16
c	a	a	a	b	c	b	c	d	c	c	b	d	a	c	b
17	18	19	20	21	22	23	24	25	26	27	28	29	30	31	32
b	c	b	d	a	a	a	a	c	a	a	a	a	a	b	b
33	34	35													
b	c	c													

38. Ans 0.16%

46 Ans 4.64×10^{-4} m

47 Ans. 7.5×10^{10} Nm⁻²

48. Ans 1.79:1

49. Ans 7.22×10^{-7}

50. Ans 7.065×10^4 N

MECHANICAL PROPERTIES OF FLUIDS

Pressure due to a fluid column; Pascal's law and its applications (hydraulic lift and hydraulic brakes), effect of gravity on fluid pressure.

Viscosity, Stokes' law, terminal velocity, streamline and turbulent flow, critical velocity, Bernoulli's theorem and its simple applications.

Surface energy and surface tension, angle of contact, excess of pressure across a curved surface, application of surface tension ideas to drops, bubbles and capillary rise.

Deleted portions(for 2022-23)

Chapter	Page .No	Dropped topics/Chapters
Chapter–10: Mechanical Properties of Fluids	260	10.4.2 Venturimeter
	261	10.4.3 Blood flow and heart attack
	269	10.6.6 Detergents and surface tension
	276-277	Exercises 10.21-10.31
	274-275	Appendix 10.1

GIST OT THE LESSON (with key points)

1. Fluids- Liquids and gases can flow are called as fluids. A fluid has no definite shape of its own. Solids and liquids have a fixed volume, whereas a gas fills the entire volume of its container. Solids and liquids have much lower compressibility as compared to gases. Fluids offer very little resistance to shear stress; their shape changes by application of very small shear stress.

2. Pressure and Pascal's Law

Smaller the area on which the force acts, greater is the impact. This concept is known as pressure.

When an object is submerged in a fluid at rest, the fluid exerts a force on its surface. This force is always normal to the object's surface.

The force exerted by a liquid at rest per unit area of the surface in contact with the liquid is called as **pressure**.

$$\text{Pressure} = \frac{F}{A}$$

It is a scalar quantity and its SI unit is Nm^{-2} .

3. Density is the ratio of the mass of a body to its volume.. It is a scalar quantity and its SI unit is kg m^{-3}

4. Pascal's law -The change in pressure at one point of the enclosed liquid in equilibrium at rest is transmitted equally to all other points of the liquid in all directions.

(or) the pressure in a fluid at rest is the same at all points if they are at the same height.

5. Pressure exerted by a liquid column,

$$p = \rho gh$$

where, h = height of liquid column, g = acceleration due to gravity and ρ = density of liquid.

6. Variation of Pressure with Depth

The pressure p at depth below the surface of a liquid open to the atmosphere is greater than atmospheric pressure p_a by an amount ρgh .

i.e. Pressure $p = p_a + \rho gh$

The excess of pressure, $p - p_a$ at depth h is called a **gauge pressure**.

The liquid pressure is the same at all points at the same horizontal level (same depth). The result is appreciated through the example of hydrostatic paradox.

The pressure of the atmosphere (**atmospheric pressure**) at any point is equal to the weight of a column of air of unit cross-sectional area extending from that point to the top of the atmosphere.

Atmospheric pressure is measured with mercury barometer accurately. The mercury column in the barometer has a height of about 76 cm at sea level equivalent to one atmosphere (1 atm).

$$1 \text{ atm} = 1.013 \times 10^5 \text{ Pa}$$

$$1 \text{ torr} = 133 \text{ Pa}, \quad 1 \text{ bar} = 10^5 \text{ Pa}$$

An open tube manometer is a useful instrument for measuring pressure differences.

7. Hydraulic Machines

When external pressure is applied on any part of a fluid contained in a vessel, it is transmitted undiminished and equally in all directions is **Pascal's law**

Hydraulic lift and **hydraulic brakes** are based on the Pascal's law, in which fluids are used for transmitting pressure.

Hydraulic lift is used to support or lift heavy objects based on the application of Pascal's law. It is a force multiplying device with a multiplication factor equal to the ratio of the areas of the two pistons.

8. Flow of Liquids

steady or **streamline flow**.- If the velocity of fluid particles at any time does not vary with time,

streamlines.- The path followed by a fluid particle in streamline flow

Velocity of particles in streamline is along the tangent to the curve at that point.

Turbulent flow- Steady flow is achieved at low flow speeds. Beyond a limiting value, called **critical speed**, this flow loses steadiness and becomes **turbulent**.

In **turbulent flow**-velocity of all particles crossing a given point is not same and the motion of the fluid is irregular

laminar flow - If the liquid flows over a horizontal surface in the form of layers of different velocities,

Equation of continuity states that "when an incompressible and non-viscous fluid flows steadily through a tube of non-uniform cross-section, then the product of area of cross-section and velocity of flow is same at every point in the tube, i.e. $A_1v_1 = A_2v_2$

where, A = area of cross-section and v = velocity of flow.

9. Bernoulli's Principle

According to this principle, 'if an ideal fluid (incompressible, non viscous, and irrotational) is flowing in streamlined flow, then total energy, i.e. sum of pressure energy, kinetic energy and potential energy per unit volume of the liquid remains constant at every cross-section of the tube.'

$$P_1 + \left(\frac{1}{2}\right) \rho v_1^2 + \rho gh_1 = P_2 + \left(\frac{1}{2}\right) \rho v_2^2 + \rho gh_2$$

$$P + \left(\frac{1}{2}\right) \rho v^2 + \rho gh = \text{constant}$$

$$\frac{p}{\rho g} + \frac{v^2}{2g} + h = \text{constant}$$

Where $\frac{p}{\rho g}$ = pressure head, $\frac{v^2}{2g}$ = velocity head and ρgh = gravitational head.

Bernoulli's equation ideally applies to fluids with zero viscosity or non-viscous fluids. /

10. Speed of Efflux : Torricelli's Law

The outflow of a fluid is called efflux and the speed of the fluid coming out is called speed of efflux. When tank as shown below is closed, the speed of efflux is given by P_a

$$V_1 = \sqrt{2gh + \frac{2(P-P_a)}{\rho}}$$

where, ρ = density of liquid.

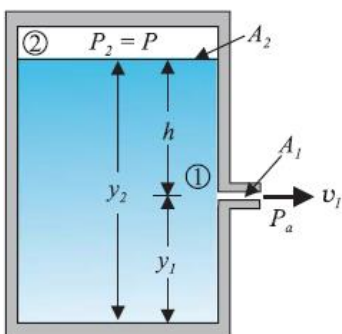

Special case

When the tank is open to the atmosphere, then

$$p - p_a = 0$$

$$v_1 = \sqrt{2gh}$$

This is also the speed of a freely falling body and this equation represents **Torricelli's law**.

The horizontal distance covered by the liquid coming out of the hole is called **range** and is given by

$$R = 2\sqrt{h(y_2 - y_1)}$$

11. Dynamic Lift

It is the force that acts on a body, such as airplane wing, a hydrofoil or a spinning ball by virtue of its motion through a fluid. can be explained on the basis of Bernoulli's principle.

(i) **When ball is moving without spin in air**, then speed of air above and below to the ball is streamline, hence pressure difference above and below the ball is zero. The air, therefore exerts no upward or downward force on the ball.

(ii) **When ball is moving with spin in air**, then speed of air above and below to the ball is not streamline, hence pressure difference above and below the ball is not zero. Due to difference in velocities of fluid (air) exerts, a net upward force on the ball.

Magnus Effect When a ball is moving in air with spin, then due to difference in the velocities of air results in the pressure difference between the lower and upper faces and there is net upward force on the ball. This dynamic lift due to spinning is called Magnus effect.

Aerofoil or Lift on Aircraft Wing An aerofoil is solid piece shaped to provide an upward dynamic lift when it moves horizontally through air. The cross-section of the wings of an aeroplane looks like the aerofoil.

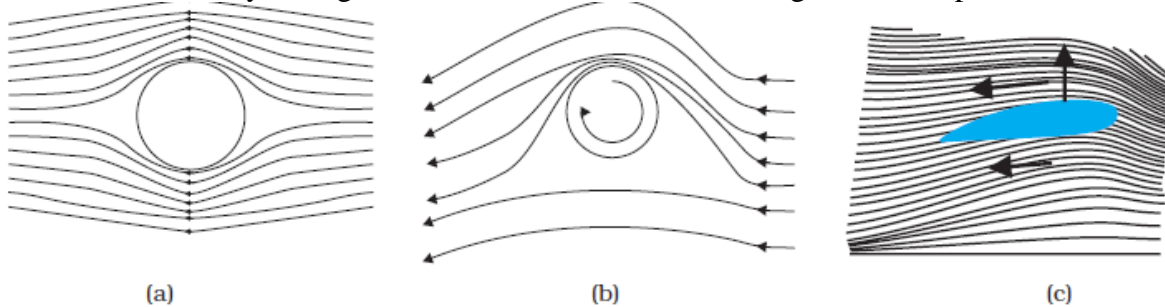

(a) Fluid streaming past a static sphere. (b) Streamlines for a fluid around a sphere spinning clockwise. (c) Air flowing past an aerofoil.

12. Viscosity

The property of a fluid by virtue of which an internal frictional force acts between its different layers, which opposes their relative motion is called viscosity. The **coefficient of viscosity** for a fluid is defined as the ratio of shearing stress to the strain rate.

$$\eta = \frac{F/A}{V/l} = \frac{Fl}{VA}$$

Its SI unit is poiseuille (PI).

The **viscosity of liquids decreases with temperature, while it increases in the case of gases**.

Stokes' Law There is a viscous drag force F on a sphere of radius r moving with velocity v through a fluid of viscosity h . It can be expressed as $F = 6\pi\eta av$

Terminal Velocity The maximum constant velocity acquired by the body while falling through a viscous

fluid is called terminal velocity. $V_t = \frac{2a^2(\rho - \sigma)g}{9\eta}$

where, a = radius of the spherical body, V_t = terminal velocity

η = coefficient of viscosity of fluid, a = density of the spherical body and σ = density of fluid.

13. Surface Tension

It is the property of liquid at rest by virtue of which a liquid surface tends to occupy a minimum surface area and behaves like a stretched membrane.

Surface energy is the amount of work done in increasing the area of the surface film through unity. It is expressed as Surface energy = Work done in increasing surface area

Surface tension and Surface energy Surface tension is force per unit length (or surface energy per unit area) acting in the plane of the interface between the plane of the liquid and any other substance. It is also the extra energy that the molecules at the interface have as compared to molecules in the interior. The value of surface tension depends on temperature.

Like viscosity, the surface tension of a liquid usually falls with temperature.

Angle of Contact

The angle subtended between the tangent drawn at liquid's surface and tangent drawn at solid surface inside the liquid at the point of contact is called angle of contact.

At the line of contact, the surface forces between three media as shown in Figs. (i) and (ii) must be in equilibrium,

if

$$S_{la} \cos \theta + S_{sl} = S_{sa}$$

where,

S_{la} = surface force of liquid-air interface,

S_{sl} = surface force of solid-liquid interface

and S_{sa} = surface force of solid-air interface.

Different shapes of water drops with interfacial tensions (a) on a lotus leaf (b) on a clean plastic plate.

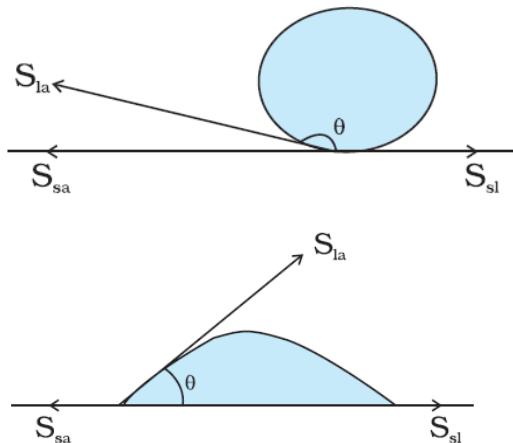

(i) If $S_{sl} S_{la} > S_{sa}$, i.e. angle of contact is an obtuse angle for solid-liquid interface, then liquid does not wet the solid.

(ii) If $S_{sl} S_{la} < S_{sa}$, i.e. angle of contact is an acute angle for solid-liquid interface, then liquid wets the solid.

(iii) If $S_{sl} S_{la} = S_{sa}$, i.e. angle of contact is right angle for solid-liquid interface.

14. Drops and Bubbles

One consequence of surface tension is that, the pressure inside p_i a spherical drop is more than the pressure outside p_o . Excess pressure inside a liquid drop,

$$p_i - p_o = \frac{2S}{R}$$

Excess pressure inside a soap bubble,

$$p_i - p_o = \frac{4S}{R}$$

15. Capillary Rise

The phenomenon of rising or falling of liquid in a capillary tube is called **capillarity**.

The height of liquid column in a capillary tube is given by

$$h = \frac{2S \cos \theta}{r \rho g}$$

where, r is the radius of the capillary tube, θ is the angle of contact and ρ is density of liquid.

In capillary, there arises following cases

(i) When the angle of contact between the liquid and glass is acute, then surface of liquid in the capillary is concave. The pressure of the liquid inside the tube, just at the meniscus (air-liquid interface) is less than the atmospheric pressure.

(ii) When the angle of contact between the liquid and glass is obtuse, then surface of liquid in the capillary is convex. The pressure of liquid inside the tube, just at the meniscus (air-liquid interface) is greater than the atmospheric pressure.

(iii) When the angle of contact between the liquid and glass is right angle, the surface of liquid in the capillary tube is plane.

The pressure of liquid inside the tube, just at the meniscus (air-liquid interface) is equal to the atmospheric pressure.

I. MULTIPLE CHOICE QUESTIONS

1	Which of the following is a unit of pressure? (a) atm (b) pascal (c) bar (d) All of these
2	Liquid pressure depends upon (a) area of the liquid surface (b) shape of the liquid surface (c) height of the liquid column (d) directions
3	Hydraulic lifts and hydraulic brakes are based on (a) Archimedes' principle (b) Bernoulli's principle (c) Stoke's law (d) Pascal's law
4	Which liquid is used in an open-tube manometer for measuring small pressure differences? (a) Oil (b) Mercury (c) Water (d) None of these
5	Smaller the area on which the force acts, greater is the impact. This concept is known as (a) impulse (b) pressure (c) surface tension (d) magnus effect
6	Pressure in a fluid at rest is same at all points which are at the same height. This is known as (a) Archimedes' Principle (b) Bernoulli's principle (c) Stoke's law (d) Pascal's law
7	The excess pressure at depth below the surface of a liquid open to the atmosphere is called (a) atmospheric pressure (b) hydrostatic paradox (c) gauge pressure (d) None of these
8	Pressure applied to enclosed fluid is (a) increased and applied to every part of the fluid (b) diminished and transmitted to wall of container (c) increased in proportion to the mass of the fluid and then transmitted (d) transmitted unchanged to every portion of the fluid and wall of containing vessel.
9	The pressure at the bottom of a tank containing a liquid does not depend on (a) acceleration due to gravity (b) height of the liquid column (c) area of the bottom surface (d) nature of the liquid
10	Beyond the critical speed, the flow of fluids becomes (a) streamline (b) turbulent (c) steady (d) very slow
11	For flow of a fluid to be turbulent (a) fluid should have high density (b) velocity should be large (c) reynold number should be less than 2000 (d) both (a) and (b)
12	In a stream line (laminar flow) the velocity of flow at any point in the liquid (a) does not vary with time (b) may vary in direction but not in magnitude (c) may vary in magnitude but not in direction (d) may vary both in magnitude and direction
13	In Bernoulli's theorem which of the following is conserved? (a) Mass (b) Linear momentum (c) Energy (d) Angular momentum
14	If ratio of terminal velocity of two drops falling in air is 3 : 4, then what is the ratio of their surface area? (a) $\frac{2}{3}$ (b) $\frac{3}{4}$ (c) $\frac{4}{3}$ (d) $\frac{3}{2}$
15	Paint-spray gun is based on (a) Bernoulli's theorem (b) Archimedes' principle (c) Boyle's law (d) Pascal's law
16	If two forces in the ratio 1 : 7 act on two pistons of areas in the ratio 3 : 2, then the pressure exerted by the forces is in ratio (a) 2 : 21 (b) 3 : 14 (c) 6 : 7 (d) 4 : 21
17	A liquid is allowed to flow into a tube of truncated cone shape. Identify the correct statement from the following: (a) the speed is high at the wider end and high at the narrow end. (b) the speed is low at the wider end and high at the narrow end. (c) the speed is same at both ends in a stream line flow.

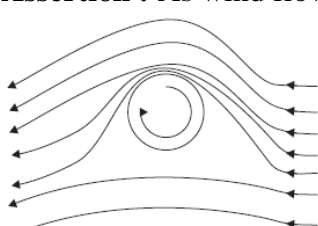
	(d) the liquid flows with uniform velocity in the tube.
18	Toricelli's theorem is used to find (a) the velocity of efflux through an orifice. (b) the velocity of flow of liquid through a pipe. (c) terminal velocity (d) critical velocity
19	After terminal velocity is reached, the acceleration of a body falling through a fluid is (a) equal to g (b) zero (c) less than g (d) greater than g
20	According to stokes law, the relation between terminal velocity (v_t) and viscosity of the medium (η) is (a) $v_t = \eta$ (b) $v_t \propto \eta$ (c) $v_t \propto \frac{1}{\eta}$ (d) v_t is independent of η
21	Surface tension of a liquid is due to (a) gravitational force between molecules (b) electrical force between molecules (c) adhesive force between molecules (d) cohesive force between molecules
22	Due to capillary action, a liquid will rise in a tube if angle of contact is (a) acute (b) obtuse (c) 90° (d) zero
23	For which of the following liquids, the liquid meniscus in the capillary tube is, convex? (a) Water (b) Mercury (c) Both (a) & (b) (d) None of these
24	Kerosene oil rises up in a wick of a lantern because of (a) diffusion of the oil through the wick (b) capillary action (c) buoyant force of air (d) the gravitational pull of the wick
	II. ASSERTION- REASON TYPE QUESTIONS Directions : Each of these questions contain two statements, Assertion and Reason. Each of these questions also has four alternative choices, only one of which is the correct answer. You have to select one of the codes (a), (b), (c) and (d) given below. (a) Assertion is correct, reason is correct; reason is a correct explanation for assertion. (b) Assertion is correct, reason is correct; reason is not a correct explanation for assertion (c) Assertion is correct, reason is incorrect (d) Assertion is incorrect, reason is correct
25	Assertion : Pascal's law is the working principle of a hydraulic lift. Reason : Pressure is equal to the thrust per unit area.
26	Assertion: The pressure of water reduces when it flows from a narrow pipe to a wider pipe. Reason: Since for wider pipe area is large, so flow of speed is small and pressure also reduces proportionately
27	Assertion : As wind flows right to left and a ball is spinned as shown, there will be a lift of the ball.  Reason : Decreased velocity of air below the ball increases the pressure more than that above the ball.
28	Assertion : The velocity of flow of a liquid is smaller when pressure is larger and vice-versa. Reason : According to Bernoulli's theorem, for the stream line flow of an ideal liquid, the total energy per unit mass remains constant
29	Assertion : The blood pressure in humans is greater at the feet than at the brain Reason : Pressure of liquid at any point is proportional to height, density of liquid and acceleration due to gravity.
30	Assertion : Hydrostatic pressure is a vector quantity. Reason : Pressure is force divided by area, and force is vector quantity.
	III. CASE BASED QUESTIONS Read the passage given below and answer the following questions from 31 to 34.

	<p>Suppose that an incompressible fluid is flowing through the pipe of varying cross-sectional area, in a steady flow. Its velocity must change as a consequence of equation of continuity. A force is required to produce this acceleration, which is caused by the fluid surrounding it, the pressure must be different in different regions.</p> <p>Bernoulli's equation is a general expression that relates the pressure difference between two points in a pipe to both velocity changes (kinetic energy change) and elevation (height) changes (potential energy change).</p> <p>The statement of Bernoulli's relation is: As we move along a streamline the sum of the pressure (P), the kinetic energy per unit volume and the potential energy per unit volume (ρgh) remains a constant. Note that in applying the energy conservation principle, there is an assumption that no energy is lost due to friction. In practice, it has a large number of useful applications and can help explain a wide variety of phenomena for low viscosity incompressible fluids.</p>
31	<p>Bernoulli's equation for steady, non-viscous, incompressible flow expresses the</p> <p>(a) conservation of linear momentum (b) conservation of angular momentum (c) conservation of mass (d) conservation of energy</p>
32	<p>Applications of Bernoulli's theorem can be seen in</p> <p>(a) dynamic lift of aeroplane (b) dynamic lift due to spinning cricket ball (c) Paint spray gun. (d) in all (a),(b), and (c)</p>
33	<p>Bernoulli's equation holds good</p> <p>(a)for non-steady (b)in that situation, velocity and pressure are constantly fluctuating in time (c) in that situation velocity and pressure are not constantly fluctuating in time (d)In all the cases of (a),(b), and (c)</p>
34	<p>Bernoulli's equation ideally applies to fluids with</p> <p>(a) with zero viscosity (b) with high viscosity (c) both (a) and (b) (d) None of the above</p>
35	<p>IV TWO MARK QUESTIONS On what principle working of hydraulic brakes are based? State that principle.</p>
36	<p>Why the passengers are advised to remove the ink from their fountain pens while going up in an aeroplane?</p>
37	<p>Why two streamlines cannot intersect each other?</p>
38	<p>Why a small drop of mercury is spherical but bigger drops are oval in shape?</p>
39	<p>Why the tip of the nib of your writing pen split? Explain</p>
40	<p>What makes a waterproof raincoat waterproof.?</p>
41	<p>Teflon is coated on the surface of non sticking pans. Explain why?</p>
42	<p>In order to increase the surface area of a liquid, work has to be done. Is it against the law of conservation of energy?</p>
43	<p>Hotter liquids flows speeder than colder ones. Explain</p>
44	<p>A bigger raindrop falls faster than a smaller ones. explain</p>
45	<p>Bernouilles theorem holds good for incompressible, non viscous fluids. What will happen if the viscosity of the fluid is not negligible.</p>
46	<p>During severe wind time , light roofs are blown off. Why?</p>
47	<p>Why does the speed of a liquid increase, when the liquid passes through a constriction in a pipe.</p>
48	<p>V. THREE MARK QUESTIONS Derive an expression for excess pressure inside a soap bubble.</p>
49	<p>What is the phenomenon of capillarity?Derive ascent formula for rise of liquid in a capillary tube.</p>
50	<p>State the principal of a hydraulic lift and explain its working.</p>
51	<p>Define terminal velocity . Derive an expression for the terminal velocity of a sphere falling through a</p>

	viscous fluid
52	VI FIVE MARK QUESTIONS State and prove Bernouilles theorem for a liquid having streamline flow. Give one practical application
53	VII NUMERICALS A U-tube contains water and methylated spirit separated by mercury. The mercury columns in the two arms are in level with 10.0 cm of water in one arm and 12.5 cm of spirit in the other. What is the specific gravity of spirit ?
54	A 50 kg girl wearing high heel shoes balances on a single heel. The heel is circular with a diameter 1.0 cm. What is the pressure exerted by the heel on the horizontal floor ?
55	A hydraulic automobile lift is designed to lift cars with a maximum mass of 3000 kg. The area of cross-section of the piston carrying the load is 425 cm ² . What maximum pressure would the smaller piston have to bear ?

ANSWER KEY

1	2	3	4	5	6	7	8	9	10	11	12	13	14	15
d	c	d	a	b	d	c	d	c	b	d	a	c	b	a
16	17	18	19	20	21	22	23	24	25	26	27	28	29	30
a	b	a	b	c	d	a	b	b	b	d	a	a	a	d
31	32	33	34											
d	d	c	a											

53 Ans: 0.8

54 Ans: 6.2×10^6 Pa.

55 Ans: 6.92×10^5 Pa.

THERMAL PROPERTIES OF MATTER

Gist of the Lesson

I. **Temperature and heat** : Temperature is the degree of hotness or coldness of an object. Heat is a form of energy which is transferred between two (or more) systems or a system and its surroundings by virtue of temperature difference.

II. **MEASUREMENT OF TEMPERATURE : Celsius, Fahrenheit and Kelvin scales :**

III. The convenient fixed points chosen for Celsius and Fahrenheit scales are ice point steam point . The process of melting and boiling depends on pressure. Kelvin scale is based on the absolute temperature which is a convenient fixed point and it is obtained by using Ideal gas equation.

IV. **THERMAL EXPANSION** : Most substances expand on heating and contract on cooling. A change in the temperature of a body causes change in its dimensions. The expansion in length is called linear expansion. The expansion in area is called area expansion. The expansion in volume is called volume expansion .

V. Gases, at ordinary temperature, expand more than solids and liquids. Water exhibits an anomalous behaviour on expansion. The maximum density of water is at 4°C which is crucial for the existence of aquatic life.

VI. **Specific heat capacity** : The amount of heat absorbed or given off to change the temperature of unit mass of it by one unit. SI unit is $\text{J kg}^{-1} \text{K}^{-1}$. If the amount of substance is specified in terms of moles, then it is known as molar specific heat capacity.

VII. **Change of state** : Matter normally exists in three states: solid, liquid and gas. A transition from one of these states to another is called a change of state. The change of state from solid to liquid is called melting and from liquid to solid is called fusion. The melting point decreases with pressure and boiling point increases with pressure .

VIII. **Latent heat** : The amount of heat transferred during change of state

IX. **Modes of heat transfer** : Conduction , Convection and Radiation. Conduction is the mechanism of transfer of heat between two adjacent parts of a body because of their temperature difference. Conduction takes place in metals. Convection is a mode of heat transfer by actual motion of matter. It is the mode heat transfer in fluids. Sea breeze, land breeze and trade wind are due to the convection. Radiation is the heat transfer without a material medium. Example : heat carried by the electromagnetic wave.

X. **Blackbody radiation** : The relation between temperature and wave length of thermal radiation for which energy is maximum is given by Wein's displacement law: $\lambda_m T = \text{constant}$

I. MULTIPLE CHOICE QUESTIONS

- In the case of a hot cup of tea, heat transfer takes place
 - From surrounding to cup till equilibrium establishes
 - From cup to surrounding till equilibrium establishes
 - In both ways
 - No heat transfer takes place
- The temperature of an object measured with Fahrenheit scale as 50° F. What will be the temperature if Celsius scale is used?
 - 30°C
 - 20°C
 - 10°C
 - 25°C
- The absolute zero is
 - 273.15 °C
 - 273.15 °C
 - 100 °C

(d) 180.15°C

4. 100°C in kelvin is
- (a) 473.15 K
 - (b) 100 K
 - (c) 0 K
 - (d) 373.15 K
5. In order to obtain absolute zero ,
- (a) Volume of a gas kept constant and temperature is measured in terms of pressure
 - (b) Pressure of a gas kept constant and temperature is measured in terms of volume
 - (c) Temperature of a gas kept constant and volume is measured in terms of pressure
 - (d) None of the above
6. Which one of the following is a reliable standard fixed point?
- (a) Boiling point of water
 - (b) Melting point of ice
 - (c) Trippl point of water
 - (d) None of the above
7. The Pyrex glass is suitable for making thermometers than ordinary glass, because
- (a) It has greater coefficient of volume expansion
 - (b) It has smaller Coefficient of volume expansion
 - (c) Not easy to break
 - (d) Cheaply available in market
8. Coefficient of volume expansion is
- (a) Equal to the coefficient of linear expansion
 - (b) 2 times the coefficient of linear expansion
 - (c) Smaller than coefficient of linear expansion
 - (d) 3 times the coefficient of linear expansion
9. Water has the maximum density at
- (a) 4°C
 - (b) 100°C
 - (c) 0°C
 - (d) 10°C
10. Co-efficient of volume expansion ofis independent of temperature
- (a) Gas
 - (b) Solid
 - (c) Liquid
 - (d) None of the above
11. For an ideal gas, co-efficient of volume expansion is
- (a) $1/T$
 - (b) $1/3T$
 - (c) $1/2T$
 - (d) $1/5T$
12. The graph of density against temperature for water is correctly illustrated by

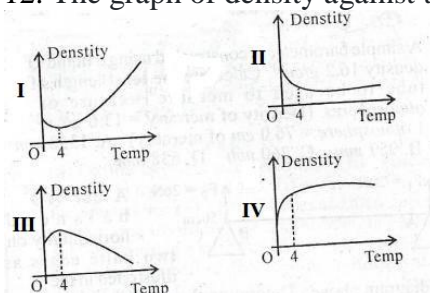

- (a) I
- (b) II
- (c) III
- (d) IV

13. Consider four sealed bottles with tightly screwed lids made up of Aluminum, Brass, Iron and copper. The given metals can be arranged as Aluminum > Brass > Copper > Iron in terms of their co-efficient of linear expansion. If they are immersed in hot water of same temperature, which lid will get most loosened?
- Copper
 - Brass
 - Iron
 - Aluminum
14. The specific heat capacities ($\text{J kg}^{-1}\text{K}^{-1}$) of water and edible oil are given as 4186 and 1965 respectively. Chose the correct answer from the options given below.
- Edible oil can be used as a better coolant in automobile radiators
 - Water can be used as a better coolant in automobile radiators
 - Both Water and edible oil give same performance as coolants
 - None of the above
15. The SI unit of specific heat capacity is
- $\text{J kg}^{-1}\text{K}^{-1}$
 - $\text{J kg}^{-1}\text{K}^{-2}$
 - $\text{J kg}^{-2}\text{K}^{-1}$
 - $\text{J}^{-1} \text{kgK}^{-1}$
16. Regelation refers to
- Refreezing on withdrawal of pressure
 - Melting of ice by the application of pressure
 - Boiling of water
 - Change of state from Solid to vapour
17. During change of state
- Temperature remains constant
 - Temperature changes
 - Mass changes
 - Density remains constant
18. The SI unit of latent heat is
- $\text{J kg}^{-1}\text{K}^{-2}$
 - J kg^{-1}
 - J kg
 - $\text{J kg}^{-2}\text{K}^{-1}$
19. During phase change,
- The heat energy supplied is used to rise the temperature only
 - The heat energy supplied is used to rise the temperature and phase change
 - The heat energy supplied is used for changing the state only
 - None of the above statement is correct
20. The latent heat of vaporisation of water and gold are given as 22.6 and 15.8 ($\times 10^5 \text{ J kg}^{-1}$) respectively. Which means....
- Water needs more heat than gold to change from liquid to vapor state
 - Gold needs more heat than to change from liquid to vapor state
 - Both need same amount of heat to undergo liquid to vapor phase change
 - Latent heat is not related to change of state
21. Which of the following substances is a sublime ?
- Water
 - Oil
 - Dry ice
 - Gold
22. The heat transfer from one end to other end of a metallic rod is due to the
- Radiation
 - Convection
 - Both radiation and convection
 - Conduction

23. The mode of heat transfer in convection is
- Without the actual motion of matter
 - By the actual motion of matter
 - Without a material medium
 - None of the above
24. Which of the following is correct about sea breeze and land breeze ?
- Sea breeze is from sea to the land at day time and land breeze is from land to sea at night time
 - Sea breeze is from land to the sea at day time and land breeze is from land to sea at night time
 - Sea breeze is from sea to the land at night time and land breeze is from land to sea at day time
 - Sea breeze is from land to the sea at night time and land breeze is from sea to land at day time
25. By Wein's displacement law,
- $\lambda_m T^2 = \text{constant}$
 - $\lambda_m T^3 = \text{constant}$
 - $\lambda_m T = \text{constant}$
 - $\lambda_m T^4 = \text{constant}$
26. If the temperature of a blackbody is increased to $2T$ from T . Then the wave length of thermal radiation with maximum energy will be ...
- λ_m
 - $2 \lambda_m$
 - $\lambda_m/4$
 - $\lambda_m/2$
27. The change from solid state to vapour state without passing through the liquid state is called as
- Vaporisation
 - Melting
 - Boiling
 - Sublimation

Answer Key:

1	2	3	4	5	6	7	8	9	10	11	12	13	14	15
a	c	b	d	a	c	b	d	a	c	a	c	d	b	a
16	17	18	19	20	21	22	23	24	25	26	27	28	29	30
a	a	b	c	a	c	d	b	a	c	d	d			

II .ASSERTION REASON QUESTION

Two statements are given-one labelled Assertion (A) and the other labelled Reason (R). Select the correct answer to these questions from the codes (a), (b), (c) and (d) as given below.

- Both A and R are true and R is the correct explanation of A
- Both A and R are true and R is NOT the correct explanation of A
- A is true but R is false
- A is false and R is also false

1. **Assertion :** Land heats up faster than sea

Reason : Specific heat of land is greater than water

2. **Assertion :** A wire placed on an ice slab with two blocks at the end pass through ice slab

Reason : Melting point increases with pressure

3. **Assertion :** Co efficient of volume expansion of liquids dependent on temperature

Reason : Co efficient of volume expansion of liquids independent on temperature

4. **Assertion :** Food gets cooked well in a pressure cooker

Reason : Boiling point of water increases with pressure

5. **Assertion :** A brass disc is just fitted in a hole in a steel plate. The system must be cooled to loosen the disc from the hole.

Reason : The coefficient of linear expansion for brass is greater than the coefficient of linear expansion for steel.

6. **Assertion :** The temperature at which Centigrade and Fahrenheit thermometers read the same is – 40
Reason : There is no relation between Fahrenheit and Centigrade temperature.
7. **Assertion :** There is no relation between Fahrenheit and Centigrade temperature.
Reason : Coefficient of superficial expansion is twice that of linear expansion where as coefficient of volume expansion is three time of linear expansion.

Answer Key

1	2	3	4	5	6	7
a	c	d	a	a	c	a

III .CASE STUDY QUESTIONS

1. Matter normally exists in three states: solid, liquid and gas. A transition from one of these states to another is called a change of state. Two common changes of states are solid to liquid and liquid to gas. These changes can occur when the exchange of heat takes place between the substance and its surroundings. When ice is heated , it starts melting without any change in temperature till the melting completes. Then temperature starts rising and it becomes steady at 100° C. The graph shows change of state from ice to vapour.

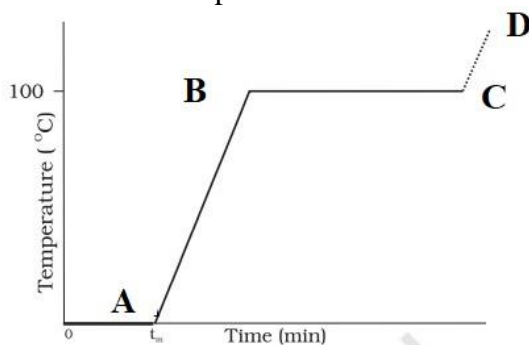

Explain

- (i) OA
 - (ii) AB
 - (iii) BC
 - (iv) t_m
2. The earth's surface is a source of thermal radiation as it absorbs energy received from the Sun. The wavelength of this radiation lies in the long wavelength region. But a large portion of this radiation is absorbed by some gases. This heats up the atmosphere which, in turn, gives more energy to earth, resulting in warmer surface. Concentration of gases responsible for this effect has enhanced due to human activities, making the earth warmer.
- (i) The warming of earth surface by the continuous absorption of radiation by the gases and earth is known as ?
 - (ii) Which electromagnetic radiation transmits more heat ?
 - (iii) Name two gases which is responsible for heat absorption mentioned in the paragraph?
 - (iv) What is the consequence of this effect ?
3. Heat energy transfer from one system to another or from one part of a system to another part, arising due to temperature difference. There are three distinct modes of heat transfer: conduction, convection and radiation. The conduction of heat takes place in metals, convection in fluids and there is no material medium required for radiation. Answer the following questions based on the subject discussed in the paragraph
- (i) Give three factors affect the rate of flow of heat in a metal bar ?
 - (ii) If the Length of the metal bar is doubled without changing area of cross-section, the rate of heat flow will become?

- (iii) The mode of heat transfer in Sea breeze and land breeze is
- (iv) Which mode/modes of heat conduction is responsible for heat loss in thermos bottle ?

4. A graph between the temperature T and the Pressure P of the substance is called a phase diagram or $P - T$ diagram. Figure shows $P-T$ graph of CO_2 . Such a phase diagram divides the $P - T$ plane into a solid-region, the vapour-region and the liquid-region. The regions are separated by the curves such as sublimation curve, fusion curve and vaporisation curve. Answer the following questions based on the diagram.

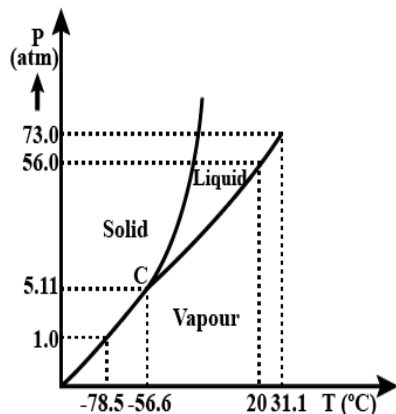

- (i) At what temperature and pressure can the solid, liquid and vapour phases of CO_2 co-exist in equilibrium?
- (ii) What is the effect of the decrease of pressure on the fusion and boiling point of CO_2 ?
- (iii) What are the critical temperature and pressure for CO_2 ? What is their significance?
- (iv) Is CO_2 solid, liquid or gas at (a) -70°C under 1 atm, (b) -60°C under 10 atm, (c) 15°C under 56 atm?

Answer key

- (i) Melting of ice. Both the solid and the liquid states of the substance coexist in thermal equilibrium

(ii) The heat supplied is being utilised to change water from liquid state to vapour or gaseous state.

(iii) Vaporisation. Both the liquid and the vapour states of the substance coexist in thermal equilibrium

(iv) Melting point
 - (i) Green house effect

(ii) Infrared

(iii) CO_2 and Methane

(iv) Increase in earth's global temperature
 - (i) Length, Area of cross-section and Temperature difference of two ends

(ii) Half

(iii) Convection

(iv) Radiation
 - (i) C is the triple point of the CO_2 phase diagram. This means that at the pressure and temperature corresponding to this point (i.e., at -56.6°C and 5.11 atm), the solid phase, liquid phase, and vaporous phases of CO_2 coexist in equilibrium.

(ii) The fusion and boiling points of CO_2 decrease with a decrease in pressure.

(iii) The critical temperature and critical pressure of CO_2 are 31.1°C and 73 atm respectively. Even if it is compressed to a pressure greater than 73 atm, CO_2 will not liquefy above the critical temperature.
- (iv). It can be concluded from the $P-T$ phase diagram of CO_2 that: (a) CO_2 is gaseous at -70°C , under 1 atm pressure (b) CO_2 is solid at -60°C , under 10 atm pressure (c) CO_2 is liquid at 15°C , under 56 atm pressure

IV .TWO MARK QUESTIONS

1. Why boiling point of water and melting point of ice cannot be considered as standard fixed points?
2. Show that the coefficient of area expansion, $(\Delta A/A)/\Delta T$, of a rectangular sheet of the solid is twice its linear expansion, α_l
3. Explain Regelation?
4. State Newton's law of cooling and write express it mathematically?
5. State Wein's displacement law?
6. Why modern arctic clothing has a shiny metallic layer next to skin?

V .THREE MARK QUESTIONS

1. Why cooking is difficult in Hilly areas?
2. Explain the sea breeze, land breeze and trade wind ?

VI .FIVE MARK QUESTIONS

1. (a) Explain anomalous behaviour of water with the temperature- density graph of water? How it is helpful for the existence of aquatic life in Antarctic region ?(b) Prove that $\alpha_v = 3\alpha_l$?

VII . NUMERICALS

1. Two absolute scales A and B have triple points of water defined to be 200 A and 350 B. What is the relation between T_A and T_B ?
2. A hole is drilled in a copper sheet. The diameter of the hole is 4.24 cm at 27.0 °C. What is the change in the diameter of the hole when the sheet is heated to 227 °C ? Coefficient of linear expansion of copper = $1.70 \times 10^{-5} K^{-1}$.
3. The triple points of neon and carbon diode are 24.57 K and 216.55 K, respectively. Express these temperatures on the Celsius and Fahrenheit scales.
4. A pan filled with hot food cools from 94 °C to 86 °C in 2 minutes when the room temperature is at 20 °C. How long will it take to cool from 71 °C to 69 °C?
5. The coefficient of volume expansion of glycerin is $49 \times 10^{-5} K^{-1}$. What is the fractional change in its density for a 30 °C rise in temperature?

ANSWER KEY.

1. **Hint:** The temperature of 273.15 K on the Kelvin scale is equivalent to 200 A on absolute scale A.

$$A = \frac{273.15}{200}$$

Similarly,

$$B = \frac{273.15}{350}$$

Let T_A and T_B triple points on scales A and B respectively, then

$$A T_A = B T_B$$

$$\frac{\text{Change in area } (\Delta A)}{\text{Original area } (A)} = \beta \Delta T$$

2. **Hint :**

β = Co-efficient of area expansion

$$\beta = 2\alpha$$

3. **Hint :** The maximum heat lost by copper = $m_1 C \Delta T$

Heat gained by ice = m_2L

And $m_1C\Delta T = m_2L$

4. Hint : The relation between Absolute temperature and Celsius scale is given by

$$T_k = T_c + 273.15$$

The relation between Fahrenheit and Celsius scale is given by

$$T_F = \frac{9}{5}T_c + 32$$

$$\frac{\text{Change in temperature}}{\text{Time}} = K\Delta T$$

5. Hint:

6. Hint :

$$\frac{\Delta V}{V} = \alpha_v \Delta T$$

$$\frac{\rho_1 - \rho_2}{\rho_2} = \alpha_v \Delta T$$

THERMODYNAMICS

Gist of the Lesson

THERMODYNAMICS : Thermodynamics is the branch of physics that deals with the concepts of heat and temperature and the inter-conversion of heat and other forms of energy.

The state of a gas in thermodynamics is specified by macroscopic variables such as pressure, volume, temperature, mass and composition

Thermodynamic Equilibrium : The state of a system is an equilibrium state if the macroscopic variables that characterise the system do not change in time.

Adiabatic wall : An insulating wall (can be movable) that does not allow flow of energy (heat) from one to another.

Diathermic wall : A conducting wall that allows energy flow (heat) from one to another.

ZEROth LAW OF THERMODYNAMICS : Two systems in thermal equilibrium with a third system separately are in thermal equilibrium with each other

It implies that, if A and B are two systems separately in equilibrium with system C, $T_A = T_C$ and $T_B = T_C$. Then $T_A = T_B$ or the systems A and B are also in thermal equilibrium.

Temperature: Is a thermodynamic variable which is equal for two systems in equilibrium

Thermodynamic state variable : A variable which depends on the state of the system not on the path taken to arrive at that state.

Internal energy : The sum of molecular kinetic and potential energies in the frame of reference relative to which the centre of mass of the system is at rest. Internal energy is a thermodynamic state variable.

FIRST LAW OF THERMODYNAMICS : The heat energy (ΔQ) supplied to the system goes in partly to increase the internal energy of the system (ΔU) and the rest in work on the environment (ΔW).

$$\Delta Q = \Delta U + \Delta W$$

$$\Delta W = P\Delta V$$

Specific heat capacity at constant volume (C_v) and Specific heat capacity at constant pressure (C_p):

$$C_p - C_v = R, \quad R \text{ is the universal gas constant}$$

Quasi static process : It is an imaginary process for non-equilibrium states. processes that are sufficiently slow and do not involve accelerated motion of the piston, large temperature gradient, etc., are reasonably approximation to an ideal quasi-static process.

Isothermal process : Process in which the temperature of the system is kept fixed throughout.

$$\text{Work done in an isothermal process is given by } \mu R T \ln \frac{V_2}{V_1}$$

Isobaric process : Process in which pressure is constant

$$\text{Work done in an isobaric process is given by } \mu R (T_2 - T_1)$$

Isochoric process : Process in which volume is constant

Adiabatic process : If the system is insulated from the surroundings and no heat flows between the system and the surroundings, then the process is adiabatic

$$\text{Work done in adiabatic process is given by } \frac{\mu R (T_1 - T_2)}{\gamma - 1}$$

HEAT ENGINES : Heat engine is a device by which a system is made to undergo a cyclic process that results in conversion of heat to work. It consist of a working substance which absorbs heat from an external hot reservoir, a part of which gets converted to work.

Refrigerator :

A refrigerator is the reverse of a heat engine. Working substance absorb heat from a cold reservoir and some work done on it.

SECOND LAW OF THERMODYNAMICS :

Kelvin-Planck statement

No process is possible whose sole result is the absorption of heat from a reservoir and the complete conversion of the heat into work.

Clausius statement

No process is possible whose sole result is the transfer of heat from a colder object to a hotter object.

I. MULTIPLE CHOICE QUESTIONS

- By the Zeroth law of Thermodynamics, the thermodynamic variable whose value is equal for two systems in thermal equilibrium is
(a) Mass (b) Pressure (c) Volume (d) Temperature
- Which of the following variables is a thermodynamic state variable
(a) Work (b) heat (c) Internal energy (d) None of these
- If a system goes from initial to final state without changing internal energy, then the heat supplied to system.....
(a) Is fully utilised for doing work
(b) Is partially utilised for doing work by the system
(c) Is partially utilised for doing work on the system
(d) Not used for doing work
- In an isobaric process.....
(a) Volume is constant
(b) Pressure is constant
(c) Temperature is constant
(d) No heat flow
- Which of the following is NOT true about isothermal expansion of an ideal gas
(a) There is no change in internal energy
(b) Heat supplied to the gas equals work done
(c) The ideal gas equation for the process is $\frac{PV}{T} = \text{constant}$
(d) The ideal gas equation for the process is $PV = \text{constant}$
- Work done in an adiabatic process is
(a) $\mu R(T_2 - T_1)$ (b) $\mu RT \ln \frac{V_2}{V_1}$ (c) $\frac{\mu R(T_1 - T_2)}{\gamma - 1}$ (d) $\frac{\mu R(T_1 - T_2)}{\gamma}$
- When steam is converted into water, internal energy of the system
(a) increases (b) decreases (c) remains constant (d) becomes zero
- Tell which of the following phenomenon are reversible?
(a) Water fall. (b) Charging of a battery. (c) Rusting of iron by chemical change.
(d) Production of heat by rubbing of hands.
- The specific heat at constant pressure is more than that at constant volume due to the fact that:
(a) molecular oscillations are more violent at constant pressure.
(b) additional work need to be done for allowing expansion of gas at constant pressure.
(c) there is more intermolecular attraction at constant pressure.
(d) there is some reason other than those given above.

ANSWER KEY: (1) d (2) d (3) a (4) b (5) c (6) c (7) b (8) b (9) b

II. ASSERTION REASON QUESTION

Two statements are given-one labelled Assertion (A) and the other labelled Reason (R). Select the correct answer to these questions from the codes (a), (b), (c) and (d) as given below.

- e) Both A and R are true and R is the correct explanation of A
f) Both A and R are true and R is NOT the correct explanation of A
g) A is true but R is false
h) A is false and R is also false Assertion(A) :
8. **Assertion** : In the case of refrigerator, some external work is done on it.
Reason : The working substance extract heat from cold reservoir
9. **Assertion** : In a cyclic process, there is no change in internal energy
Reason : Internal energy is a state variable and the entire heat converted into work
10. **Assertion** : Irreversibility arises due to the dissipative forces
Reason : Spontaneous processes are reversible
11. **Assertion** : A quasi-static process deals with process in equilibrium
Reason : It is not a good approximation for non-equilibrium process
12. **Assertion** : In isothermal process whole of the heat energy supplied to the body is converted into internal energy.
Reason : According to the first law of thermodynamics $\Delta Q = \Delta U$
13. **Assertion** : Zeroth law defines the temperature
Reason : Temperature is a state variable
14. **Assertion** : Air quickly leaking out of a balloon becomes cool
Reason : The leaking air undergoes adiabatic expansion.

ANSWER KEY : 1. (a) 2. (a) 3. (c) 4. (d) 5. (d) 6. (b) 7. (a)

III. CASE STUDY QUESTIONS

1. Two cylinders A and B of equal capacity are connected to each other via a stopcock. A contains a gas at standard temperature and pressure. B is completely evacuated. The entire system is thermally insulated. The stopcock is suddenly opened. Answer the following the following questions based on the paragraph
- (i) What is the final pressure of the gas in A and B ?
(ii) What is the change in internal energy of the gas ?
(iii) What is the change in the temperature of the gas ?
(iv) Do the intermediate states of the system (before settling to the final equilibrium state) lie on its P-V-T surface ?
2. For an isothermal process, pressure of a given mass of gas varies inversely as its volume. There is no change in the internal energy of an ideal gas in an isothermal process. In an adiabatic process, the system is insulated from the surroundings and heat absorbed or released is zero. The P-V curve for Isothermal and Adiabatic process of an ideal gas is given below. Answer the following question

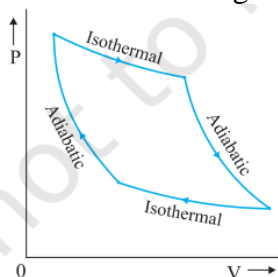

- (i) What is the formula for work done in an isothermal process ?
(ii) The above curve is known as
(iii) Which state variables do change during adiabatic process?
(iv) When work done will be positive in the case of adiabatic process?

Answer key

- (i) 0.5 atm
(ii) Zero
(iii) Zero
(iv) No

- (i) $\mu RT \ln \frac{V_2}{V_1}$
(ii) Isotherm
(iii) pressure and volume
(iv) $T_2 < T_1$

IV .TWO MARK QUESTIONS

- What is the significance of second law of thermodynamics ?
- Give two examples for irreversible process ?
- Differentiate heat and temperature ?
- What are the conditions for Work done to be (a) negative and (b) positive in an Adiabatic process?
- Differentiate isobaric and isochoric processes ?
- State Zeroth law of thermodynamics ?
- What is temperature by Zeroth law of thermodynamics?

V .THREE MARK QUESTIONS

- Explain the relation between heat, work and internal energy ?
- Draw a schematic diagram of a system doing work without changing internal energy?. State the law governs it ?

VI .THREE MARK QUESTIONS

- Explain in detail with necessary derivations (a) isothermal process (b) Adiabatic process (c) Isobaric process (d) Isochoric process ?

VII .NUMERICALS

- A cylinder contains hydrogen at standard temperature and pressure. The walls of the cylinder are made of a heat insulator, and the piston is insulated by having a pile of sand on it. By what factor does the pressure of the gas increase if the gas is compressed to half its original volume ? Take $\gamma = 1.4$
- In changing the state of a gas adiabatically from an equilibrium state A to another equilibrium state B, an amount of work equal to 22.3 J is done on the system. If the gas is taken from state A to B via a process in which the net heat absorbed by the system is 9.35 cal, how much is the net work done by the system in the latter case ? (Take 1 cal = 4.19 J)
- What amount of heat must be supplied to 2.0×10^{-2} kg of nitrogen (at room temperature) to raise its temperature by 45 °C at constant pressure ? (Molecular mass of $N_2 = 28$; $R = 8.3 \text{ J mol}^{-1} \text{ K}^{-1}$.)
- A steam engine delivers 5.4×10^8 J of work per minute and services 3.6×10^9 J of heat per minute from its boiler. What is the efficiency of the engine? How much heat is wasted per minute?

Answer key

- Hint :** $V_2 ==> \frac{V_1}{2}$
 $\frac{P_2}{P_1} = \frac{V_1^\gamma}{(\frac{V_1}{2})^\gamma}$
- Hint :** $\Delta Q=0$, for an adiabatic process, And
Use the first law of thermodynamics

- Hint :** $C_p = \frac{7}{2}R$
 $\Delta Q = nC_p\Delta T$

- Hint :** $\text{Efficiency} = \frac{\text{Output energy}}{\text{Input energy}}$

Energy wasted = Heat supplied – Work done

BEHAVIOUR OF GASES AND KINETIC THEORY OF GASES

i) Gist of the Lesson

• Equation of state of a perfect gas

The relationship between pressure P, volume V and absolute temperature T of a gas is called its equation of state. The equation of state of an ideal gas

$$PV = nRT$$

where n is the number of moles of the enclosed gas and R is the molar gas constant which is the same for all gases and its value is

$$R = 8.314 \text{ JK}^{-1} \text{ mol}^{-1}$$

• Kinetic theory of gases - assumptions

1. All gas molecules constantly move in random directions.
2. The size of molecules is very less than the separation between the molecules
3. The molecules of the sample do not exert any force on the walls of the container during the collision when the gas sample is contained.
4. It has a very small time interval of collision between two molecules, and between a molecule and the wall.
5. Collisions between molecules and wall and even between molecules are elastic in nature.
6. Newton's laws of motion can be seen in all the molecules in a certain gas sample.
With due course of time, a gas sample comes to a steady state. The molecule's distribution and the density of molecules do not depend on the position, distance and time.

• Kinetic Theory and Gas Pressure

The pressure of a gas is the result of continuous bombardment of the gas molecules against the walls of the container. According to the kinetic theory, the pressure P exerted by an ideal gas on the walls of the container is given by

$$P = \frac{1}{3} \rho \bar{c}^2$$

where ρ and \bar{c} are density and rms speed of the gas molecules

• Kinetic interpretation of temperature

The total average kinetic energy of all the molecules of a gas is proportional to its absolute temperature (T). Thus, the temperature of a gas is a measure of the average kinetic energy of the molecules of the gas.

$$U = \frac{3}{2} RT$$

According to this interpretation of temperature, the average kinetic energy U is zero at $T = 0$, i.e., the motion of molecules ceases altogether at absolute zero.

• Root mean square speed of gas molecules is defined as the square root of the mean of the squares of the speeds of gas molecules.

An ideal gas or a perfect gas is that gas which strictly obeys gas laws such as Boyle's law, Charles's law, Gay Lussac's law etc.

An ideal gas has following characteristics:

- (i) Molecule of an ideal gas is a point mass with no geometrical dimensions.
- (ii) There is no force of attraction or repulsion amongst the molecules of the gas.

• Degrees of Freedom

The total number of independent co-ordinates required to specify the position of a molecule or the number of independent modes of motion possible with any molecule is called degree of freedom. Mono-, di-, and polyatomic (N) molecules have, 3, 5 or (3 N - K) number of degrees of freedom where K is the number of constraints [restrictions associated with the structure].

- **Law of Equipartition of Energy**

For a dynamic system in thermal equilibrium, the energy of the system is equally distributed amongst the various degrees of freedom and the energy associated with each degree of freedom per molecule is $\frac{1}{2} kT$, where k is Boltzman constant.

- **Mean Free Path**

Mean free path of a molecule in a gas is the average distance travelled by the molecule between two successive collisions

- **Avogadro's Law**

Equal volumes of all gases under S.T.P. contain the same number of molecules equalling 6.023×10^{23}

I. MULTIPLE CHOICE QUESTIONS

1. Which of the following can be the basis of separating a mixture of gases?
(a) Graham's law of diffusion (b) Avogadro's law
(c) Charle's law (d) Boyle's law
2. In the equation, $PV = RT$, the V refers to the volume of:
(a) 1 g of a gas (b) 1 mole of a gas
(c) 1 kg of gas (d) any amount of gas
3. Gases deviate from perfect gas behaviour because their molecules
(a) are polyatomic (b) are of very small size
(c) don't attract each other (d) interact with each other through intermolecular forces
4. The law of equipartition of energy is applicable to the system whose constituents are:
(a) in orderly motion (b) at rest
(c) in random motion (d) moving with constant speed
5. The monoatomic molecules have only three degrees of freedom because they can possess
(a) only translatory motion (b) only rotatory motion
(c) both translatory and rotatory motion (d) translatory, rotatory and vibratory motion
6. In kinetic theory of gases, it is assumed that:
(a) the collisions are not perfectly elastic.
(b) the molecular collisions change the density of the gas.
(c) the molecules don't collide with each other on the well.
(d) between two collisions the molecules travel with uniform velocity.
7. What is the number of degrees of freedom of an ideal diatomic molecule at ordinary temperature?
(a) 3 (b) 5 (c) 7 (d) 6
8. A man is climbing up a spiral type of staircase. His degrees of freedom are:
(a) 1 (b) 2 (c) 3 (d) more than 3
9. The energy associated with each degree of freedom of a gas molecule is
(a) zero (b) $\frac{1}{2} kT$ (c) kT (d) $\frac{3}{2} kT$
10. The mean K.E. of a monoatomic gas molecule is
(a) zero (b) $\frac{1}{2} kT$ (c) kT (d) $\frac{3}{2} kT$

MCQ ANSWER KEY: 1. (a) 2. (b) 3. (d) 4. (c) 5. (a) 6. (d) 7. (b) 8 (c) 9. (b) 10. (d)

II. ASSERTION REASON TYPE QUESTIONS

Choose the correct option from the following:

- (a) Both A and R are true and R is the correct explanation of A
- (b) Both A and R are true but R is NOT the correct explanation of A
- (c) A is true but R is false

(d) A is false and R is also false

1. **Assertion (A) :** The number of degrees of freedom of a linear triatomic molecule is 7.
Reason (R) : The number of degree of freedom depends on number of particle in the system.
2. **Assertion (A) :** Absolute zero is not the temperature corresponding to zero energy.
Reason (R) : The temperature at which no molecular motion ceases is called absolute zero temperature.
3. **Assertion (A) :** The ratio of specific heat of a gas at constant pressure and specific heat at constant volume for a diatomic gas is more than that for a monatomic gas.
Reason (R) : The molecules of a monatomic gas have more degree of freedom than those of a diatomic gas.
4. **Assertion (A) :** Air pressure in a car tyre increases during driving.
Reason (R) : Absolute zero degree temperature is not zero energy temperature.
5. **Assertion (A) :** Specific heat of a gas at constant pressure is greater than its specific heat at constant volume.
Reason (R) : At constant pressure, some heat is spent in expansion of the gas.
6. **Assertion (A) :** The total translational kinetic energy of all the molecules of a given mass of an ideal gas is 1.5 times the product of its pressure and its volume.
Reason (R) : The molecules of a gas collide with each other and the velocities of the molecules change due to collision.
7. **Assertion (A) :** Mean free path of gas molecules varies inversely as density of the gas.
Reason (R) : Mean free path of gas molecules is defined as the average distance travelled by a molecule between two successive collisions.
8. **Assertion (A) :** Vibrational energy of diatomic molecule corresponding to each degree of freedom is $k_B T$.
Reason (R) : For every molecule, vibrational degree of freedom is 2.
9. **Assertion (A) :** An undamped spring-mass system is simplest free vibration system.
Reason (R) : It has three degrees of freedom.
10. **Assertion(A) :** The kinetic energy of an oxygen molecule will be equal to the kinetic energy of a hydrogen molecule.
Reason (R) : Oxygen and hydrogen gases at the same temperature.

ASSERTION AND REASON ANSWER KEY:

1 (b) 2. (a) 3. (d) 4. (b) 5. (a) 6. (b) 7. (b) 8. (c) 9. (c) 10. (a)

III . CASE STUDY QUESTIONS

Case Study – 1

Boyle's law is a gas law which states that the pressure exerted by a gas (of a given mass, kept at a constant temperature) is inversely proportional to the volume occupied by it. In other words, the pressure and volume of a gas are inversely proportional to each other as long as the temperature and the quantity of gas are kept constant. For a gas, the relationship between volume and pressure (at constant mass and temperature) can be expressed mathematically as follows.

$P \propto (1/V)$ Where P is the pressure exerted by the gas and V is the volume occupied by it. This proportionality can be converted into an equation by adding a constant, k.

Charles law states that the volume of an ideal gas is directly proportional to the absolute temperature at constant pressure. The law also states that the Kelvin temperature and the volume will be in direct proportion when the pressure exerted on a sample of a dry gas is held constant. Charles law and Boyle's law applied to low density gas only. The total pressure of a mixture of ideal gases is the sum of partial pressures. This is Dalton's law of partial pressures

- 1) Boyle's law is obeyed by high as well as low density gases. True or False?
a) True b) False

2) Charles law states that volume of an ideal gas is directly proportional to temperature at constant

- a) Temperature b) Pressure c) Volume d) None of these

- 3) State Dalton's law of partial pressures
4) State Boyle's law
5) State Charles law

ANSWER KEY :

- 1) a 2) b

3) The total pressure of a mixture of ideal gases is the sum of partial pressures exerted by all the molecules of gas. This is Dalton's law of partial pressures.

4) Boyle's law is a gas law which states that at constant temperature the pressure exerted by a gas is inversely proportional to the volume occupied by it. In other words, the pressure and volume of a gas are inversely proportional to each other as long as the temperature and the quantity of gas are kept constant. For a gas, the $P \propto (1/V)$ Where P is the pressure exerted by the gas and V is the volume occupied by it. This proportionality can be converted into an equation by adding a constant k.

5) Charles law states that the volume of an ideal gas is directly proportional to the absolute temperature at constant pressure.

Case Study – 2

Pressure of an Ideal Gas: according to kinetic theory of gases pressure is given by

$$P = \frac{1}{3} \frac{nm}{V} v^2$$

where, n is number of molecules, V the volume, m is mass, nm is the density and v^2 is mean squared speed. Though we choose the container to be a cube, the shape of the vessel really is immaterial.

The average kinetic energy of a molecule is proportional to the absolute temperature of the gas; it is independent of pressure, volume or the nature of the ideal gas. This is a fundamental result relating temperature, a macroscopic measurable parameter of a gas (a thermodynamic variable as it is called) to a molecular quantity, namely the average kinetic energy of a molecule. The two domains are connected by the Boltzmann constant and given by $E = k_B T$.

Where k_B is Boltzmann constant having value of 1.38×10^{-23} joule per Kelvin.

We have seen that in thermal equilibrium at absolute temperature T, for each translational mode of motion, the average energy is $\frac{1}{2} k_B T$. The most elegant principle of classical statistical mechanics (first proved by Maxwell) states that this is so for each mode of energy: translational, rotational and vibrational. That is, in equilibrium, the total energy is equally distributed in all possible energy modes, with each mode having an average energy equal to $\frac{1}{2} k_B T$. This is known as the law of equipartition of energy.

Accordingly, each translational and rotational degree of freedom of a molecule contributes $\frac{1}{2} k_B T$ to the energy, while each vibrational frequency contributes $2 \times \frac{1}{2} k_B T = k_B T$, since a vibrational mode has both kinetic and potential energy modes.

- 1) Boltzmann constant has value of
 a) 1.38×10^{-23} joule per Kelvin. b) 1.38×10^{-28} joule per Kelvin.
 c) 1.38×10^{-30} joule per Kelvin. d) None of these
- 2) SI unit of Boltzmann constant is given by
 a) Joules per meter b) Joules per Kelvin
 c) Joules per Newton d) None of these
- 3) According to kinetic theory, give the formula for pressure of an ideal gas.
 4) According to kinetic theory what is average kinetic energy of molecules of ideal gas ?
 5) What is law of equipartition of energy ?

ANSWER KEY :

1) a 2) b

3) According to kinetic theory of gases pressure is given by $P = \frac{1}{3} \frac{nm}{V} \bar{v}^2$ Where, n is number of molecules, V the volume, m is mass of each molecule and \bar{v}^2 is mean squared speed. Though we choose the container to be a cube, the shape of the vessel really is immaterial.

4) **The average kinetic energy** of a molecule is proportional to the absolute temperature of the gas; it is independent of pressure, volume or the nature of the ideal gas and given by $E = \frac{3}{2} k_B T$.

Where k_B is Boltzmann constant having value of 1.38×10^{-23} joule per Kelvin.

5) For each translational mode of motion, the average energy is $\frac{1}{2} k_B T$. Classical statistical mechanics states that in equilibrium, the total energy is equally distributed in all possible energy modes, with each mode having an average energy equal to $\frac{1}{2} k_B T$. This is known as the law of equipartition of energy. Accordingly, each translational and rotational degree of freedom of a molecule contributes $\frac{1}{2} k_B T$ to the energy, while each vibrational frequency contributes

$2 \times \frac{1}{2} k_B T = k_B T$, since a vibrational mode has both kinetic and potential energy modes.

Case Study – 3

SPECIFIC HEAT CAPACITY

Monatomic Gases: The molecule of a monatomic gas has only three translational degrees of freedom. Thus, the average energy of a molecule at temperature T is

$(\frac{3}{2}) k_B T$. The total internal energy of a mole of such a gas is $U = (\frac{3}{2}) RT$.

The molar specific heat at constant volume c_v is given by $C_v = dU/dT = (\frac{3}{2}) R$

For an ideal gas, $C_p - C_v = R$

where C_p is the molar specific heat at constant pressure. Thus, $C_p = (\frac{5}{2}) R$

The ratio of specific heats is $\gamma = c_p/c_v = 5/3$.

Diatomic Gases: a diatomic molecule treated as a rigid rotator, like a dumbbell, has 5 degrees of freedom: 3 translational and 2 rotational. Using the law of equipartition of energy, the total internal energy of a mole of such a gas is $U = (\frac{5}{2}) RT$.

The molar specific heat at constant volume c_v is given by $C_v = dU/dT = (\frac{5}{2}) R$

For an ideal gas, $C_p - C_v = R$

where C_p is the molar specific heat at constant pressure. Thus, $C_p = (\frac{7}{2}) R$

The ratio of specific heats is γ (for rigid diatomic) = $c_p/c_v = 7/5$.

For non rigid diatomic molecules they have additional mode of vibrations. Therefore

$$\gamma = c_p/c_v = 9/7$$

Polyatomic Gases: In general a polyatomic molecule has 3 translational, 3 rotational degrees of freedom and a certain number (f) of vibrational modes. According to the law of equipartition of energy, it is easily seen that one mole of such a gas has

$$C_v = (3+f) R \text{ and } C_p = (4+f) R \text{ and } \gamma = (4+f)/(3+f).$$

1) For monatomic molecules ratio of specific heats is γ

a) 5/3

b) 7/5

c) 9/5

d) None of these

2) For diatomic rigid molecules ratio of specific heats is γ

a) 5/3

b) 7/5

c) 9/5

d) None of these

3) For diatomic non rigid molecules ratio of specific heats is γ is

a) 5/3

b) 7/5

c) 9/7

d) None of these

4) Give c_p and c_v values and ratio of specific heat for monoatomic gas molecules.

5) Give c_p and c_v values and ratio of specific heat for polyatomic gas molecules

ANSWER KEY :

1) a 2) b 3) c

4) Monatomic Gases: The molecule of a monatomic gas has only three translational degrees of freedom. Thus, the average energy of a molecule at temperature T is $(3/2)k_B T$. The total internal energy of a mole of such a gas is $U = (3/2) RT$. The molar specific heat at constant volume C_v is given by $C_v = dU/dT = (3/2) R$

For an ideal gas, $C_p - C_v = R$

where C_p is the molar specific heat at constant pressure. Thus, $C_p = (5/2) R$

The ratio of specific heats is $\gamma = c_p/c_v = 5/3$.

5) Polyatomic Gases: In general a polyatomic molecule has 3 translational, 3 rotational degrees of freedom and a certain number (f) of vibrational modes. According to the law of equipartition of energy, it is easily seen that one mole of such a gas has

$$C_v = (3+f) R \text{ and } C_p = (4+f) R \text{ and } \gamma = (4+f)/(3+f).$$

IV . TWO MARK QUESTIONS

1. Given Samples of 1 cm^3 of Hydrogen and 1 cm^3 of oxygen, both at N. T. P. which sample has a larger number of molecules?
2. What is Mean free path?
3. A tank of volume 0.3 m^3 contains 2 moles of Helium gas at 20°C . Assuming that helium behaves as an ideal gas, Find the total internal energy of the system.
4. Air pressure in a car tyre increases during driving? Why?

Answer key (Two mark questions)

1. Equal volumes of all gases, at equivalent temperatures and pressures, contain the same number of molecules, according to Avogadro's hypothesis. As a result, the number of molecules in both samples is the same. As a result, the number of molecules in both samples is the same.
2. Mean free path of a molecule in a gas is the average distance travelled by the molecule between two successive collisions
3. Given, $n = \text{No. of moles} = 2$, Temperature $T = 273 + 20 = 293 \text{ K}$
 $R = \text{Universal Gas constant} = 8.31 \text{ J / mole}$. So we know that, Total energy of the system $E = \frac{3}{2} nRT$
Hence, $E = \frac{3}{2} \times 2 \times 8.31 \times 293 = 7.30 \times 10^3 \text{ J}$
4. Because of the action, the temperature of the air inside the tyre rises during driving. According to Charles's law, as the temperature rises, the pressure inside the tyres rises as well.

V .THREE MARK QUESTIONS

1. If a system of nine particles have speeds of 5,8,12,12,12,14,14,17 and 20 m / s .
Find 1) the average speed of the particles 2) their rms speed
2. Determine the volume of 1 mole of any gas at S. T. P., assuming it behaves like an ideal gas?
3. Estimate the total number of air molecules (inclusive of oxygen, nitrogen, water vapour and other constituents) in a room of capacity 25.0 m^3 at a temperature of 27°C .

Answer key (Three mark questions)

1. The **average speed** is the sum of their speeds divided by the total number of particles. Hence,

$$\text{Average speed} = \frac{5+8+12+12+12+14+14+17+20}{9} = 12.7 \text{ m/s}$$

The **rms speed** is the square root of the mean of the squares of the speeds of the particles.

$$\overline{v^2} = \frac{5^2+8^2+12^2+12^2+12^2+14^2+14^2+17^2+20^2}{9} = \frac{1602}{9} = 178 \text{ m}^2/\text{s}^2$$

$$v_{rms} = \sqrt{178} = 13.3 \text{ m/s}$$

2. Using the ideal gas equation, $PV = nRT$

P = Pressure, V = Volume, n = No. of moles of gas R = Universal Gas Constant ,

T = Temperature

$$V = nRT / P .$$

Given n = 1 mole; R = 8.31 J / mol / K ; T = 273 K , P = 1.01 x 10⁵ N/ m²

$$V = 1 \times (8.31) \times 273 / 1.01 \times 10^5 .$$

$$V = 22.4 \times 10^{-3} \text{ m}^3$$

Hence V = 22.4l . Since 1 litre = 1000 cm³ = 10⁻³ m³

i.e. at S.T.P., any gas has a volume of 22.4l. (Standard Temperature & Pressure)

3. Given, Volume of the room, V = 25 m³, Temperature of the room, T = 27° C = 300 K

Pressure in the room, P = 1atm = 1.013 x 10⁵ Pa

The ideal gas equation relating pressure (P), Volume (V), and absolute temperature (T) can be written as:

$$PV = Nk_B T$$

where k_B is the Boltzmann constant 1.38 x 10⁻²³ J/K

N is the number of air molecules in the room

$$N = PV/k_B T$$

$$= \frac{1.01 \times 10^5 \times 25}{1.38 \times 10^{-23} \times 300} = 6.11 \times 10^{26} \text{ molecules}$$

VI .FIVE MARK QUESTIONS

1. What are the assumptions of kinetic theory of gas? Derive an expression for the pressure exerted by an ideal gas.

Answer key (Five mark questions)

1. The following are the assumptions of the kinetic theory of gases:

(i) A gas is made up of a vast number of molecules that should be elastic spheres and identical.

(ii) The molecules of a gas are in a constant state of rapid and unpredictable mobility.

(iii) The molecules are extremely small in comparison to the distance between them.

(iv) There is no attraction or repulsion between the molecules.

(v) The collisions of the molecules with one another and with the walls of the vessel are perfectly elastic.

Consider an ideal gas confined in a cubical container with capacity on each side a.

Volume of the container V = a³ = ((Side)³ = volume of cube)

Pressure exerted by the gas molecules moving with a velocity v_x along the X direction,

$$P_x = \frac{nm}{V} v_x^2$$

where, n = number of molecules of the gas, m = Mass of each molecule

Pressure exerted by the gas molecules along the Y direction,

$$P_y = \frac{nm}{V} v_y^2$$

Pressure exerted by the gas molecules along the Z direction,

$$P_z = \frac{nm}{V} v_z^2$$

Total pressure exerted by the gas molecules, $P = \frac{1}{3}(P_x + P_y + P_z)$

$$P = \frac{1}{3} \frac{nm}{V} (\overline{v_x^2}) + \frac{1}{3} \frac{nm}{V} (\overline{v_y^2}) + \frac{1}{3} \frac{nm}{V} (\overline{v_z^2}),$$

where $\overline{v_x^2}, \overline{v_y^2}, \overline{v_z^2}$, is the average of v_x^2, v_y^2, v_z^2

$$P = \frac{1}{3} \frac{nm}{V} \overline{v^2}, \text{ where } \overline{v^2} = \overline{v_x^2} + \overline{v_y^2} + \overline{v_z^2}$$

Or $P = \frac{1}{3} \rho \overline{v^2}$, where ρ is the density of the gas.

VII . NUMERICALS

1. Estimate the fraction of molecular volume to the actual volume occupied by oxygen gas at STP.' Take the diameter of an oxygen molecule to be 3 Å.

Answer: Diameter of an oxygen molecule, $d = 3 \text{ Å} = 3 \times 10^{-10} \text{ m}$. Consider one mole of oxygen gas at STP, which contain 6.023×10^{23} molecules.

Actual molecular volume of 6.023×10^{23} oxygen molecules

$$\begin{aligned} V_{\text{actual}} &= \frac{4}{3} \pi r^3 \cdot N_A \\ &= \frac{4}{3} \times 3.14 \times (1.5)^3 \times 10^{-3} \times 6.02 \times 10^{23} \text{ m}^3 \\ &= 8.51 \times 10^{-6} \text{ m}^3 \\ &= 8.51 \times 10^{-3} \text{ litre} \end{aligned} \quad [\because 1 \text{ m}^3 = 10^3 \text{ litre}]$$

\therefore Molecular volume of one mole of oxygen

$$V_{\text{actual}} = 8.51 \times 10^{-3} \text{ litre}$$

At STP, the volume of one mole of oxygen

$$V_{\text{molar}} = 22.4 \text{ litre}$$

$$\frac{V_{\text{actual}}}{V_{\text{molar}}} = \frac{8.51 \times 10^{-3}}{22.4} = 3.8 \times 10^{-4} \approx 4 \times 10^{-4}.$$

2. Molar volume is the volume occupied by 1 mol of any (ideal) gas at standard temperature and pressure (STP : 1 atmospheric pressure, 0 °C). Show that it is 22.4 litres.

Answer:

For one mole of an ideal gas, we have

$$PV = RT \Rightarrow V = \frac{RT}{P}$$

Putting $R = 8.31 \text{ J mol}^{-1} \text{ K}^{-1}$, $T = 273\text{K}$ and $P = 1 \text{ atmosphere} = 1.013 \times 10^5 \text{ Nm}^{-2}$

$$\begin{aligned} \therefore V &= \frac{8.31 \times 273}{1.013 \times 10^5} = 0.0224 \text{ m}^3 \\ &= 0.0224 \times 10^6 \text{ cm}^3 = 22400 \text{ ml} \end{aligned} \quad [1 \text{ cm}^3 = 1\text{ml}]$$

3. An Oxygen cylinder of volume 30 Hire has an initial gauge pressure of 15 atmosphere and a temperature of 27 °C. After some oxygen is withdrawn from the cylinder, the gauge pressure drops to 11 atmosphere and its temperature drops to 17 °C. Estimate the mass of oxygen taken out of the cylinder. ($R = 8.31 \text{ J mol}^{-1} \text{ K}^{-1}$, molecular mass of $\text{O}_2 = 32 \text{ u}$.)

Answer: _____

Initial volume, $V_1 = 30 \text{ litre} = 30 \times 10^3 \text{ cm}^3$
 $= 30 \times 10^3 \times 10^{-6} \text{ m}^3 = 30 \times 10^{-3} \text{ m}^3$

Initial pressure, $P_1 = 15 \text{ atm}$
 $= 15 \times 1.013 \times 10^5 \text{ N m}^{-2}$

Initial temperature, $T_1 = (27 + 273) \text{ K} = 300 \text{ K}$

Initial number of moles,

$$\mu_1 = \frac{P_1 V_1}{RT_1} = \frac{15 \times 1.013 \times 10^5 \times 30 \times 10^{-3}}{8.31 \times 300} = 18.3$$

Final pressure, $P_2 = 11 \text{ atm}$
 $= 11 \times 1.013 \times 10^5 \text{ N m}^{-2}$

Final volume, $V_2 = 30 \text{ litre} = 30 \times 10^{-3} \text{ cm}^3$

Final temperature, $T_2 = 17 + 273 = 290 \text{ K}$

Final number of moles,

$$\mu_2 = \frac{P_2 V_2}{RT_2} = \frac{11 \times 1.013 \times 10^5 \times 30 \times 10^{-3}}{8.31 \times 290} = 13.9$$

Number of moles taken out of cylinder

$$= 18.3 - 13.9 = 4.4$$

Mass of gas taken out of cylinder

$$= 4.4 \times 32 \text{ g} = 140.8 \text{ g} = 0.141 \text{ kg.}$$

4. Three vessels of equal capacity have gases at the same temperature and pressure. The first vessel contains neon (monoatomic), the second contains chlorine (diatomic), and the third contains uranium hexafluoride (polyatomic). Do the vessels contain equal number of respective molecules? Is the root mean square speed of molecules the same in the three cases? If not, in which case is v_{rms} the largest?

Answer: Equal volumes of all the gases under similar conditions of pressure and temperature contains equal number of molecules (according to Avogadro's hypothesis). Therefore, the number of molecules in each case is same.

The rms velocity of molecules is given by

$$v_{\text{rms}} = \sqrt{\frac{3kT}{m}}$$

Clearly $v_{\text{rms}} \propto \frac{1}{\sqrt{m}}$

Since neon has minimum atomic mass m , its rms velocity is maximum.

5. An air bubble of volume 1.0 cm^3 rises from the bottom of a lake 40 m deep at a temperature of 12°C . To what volume does it grow when it reaches the surface, which is at a temperature of 35°C .

Answer:

Volume of the bubble inside, $V_1 = 1.0 \text{ cm}^3 = 1 \times 10^{-6} \text{ m}^3$

Pressure on the bubble, $P_1 = \text{Pressure of water} + \text{Atmospheric pressure}$

$$= pgh + 1.01 \times 10^5 = 1000 \times 9.8 \times 40 + 1.01 \times 10^5$$

$$= 3.92 \times 10^5 + 1.01 \times 10^5 = 4.93 \times 10^5 \text{ Pa}$$

Temperature, $T_1 = 12 \text{ }^\circ\text{C} = 273 + 12 = 285 \text{ K}$

Also, pressure outside the lake, $P_2 = 1.01 \times 10^5 \text{ N m}^{-2}$

Temperature, $T_2 = 35 \text{ }^\circ\text{C} = 273 + 35 = 308 \text{ K}$, volume $V_2 = ?$

Now
$$\frac{P_1 V_1}{T_1} = \frac{P_2 V_2}{T_2}$$

$$\therefore V_2 = \frac{P_1 V_1}{T_1} \cdot \frac{T_2}{P_2} = \frac{4.93 \times 10^5 \times 1 \times 10^{-6} \times 308}{285 \times 1.01 \times 10^5} = 5.3 \times 10^{-6} \text{ m}^3$$

6. Estimate the average thermal energy of a helium atom at (i) room temperature ($27 \text{ }^\circ\text{C}$), (ii) the temperature on the surface of the Sun (6000 K), (iii) the temperature of 10 million kelvin (the typical core temperature in the case of a star)

Answer:

(i) Here, $T = 27 \text{ }^\circ\text{C} = 27 + 273 = 300 \text{ K}$

$$\text{Average thermal energy} = \frac{3}{2} kT = \frac{3}{2} \times 1.38 \times 10^{-23} \times 300 = 6.2 \times 10^{-21} \text{ J.}$$

(ii) At $T = 6000 \text{ K}$,

$$\text{Average thermal energy} = \frac{3}{2} kT = \frac{3}{2} \times 1.38 \times 10^{-23} \times 6000 = 1.24 \times 10^{-19} \text{ J.}$$

(iii) At $T = 10 \text{ million K} = 10^7 \text{ K}$

$$\text{Average thermal energy} = \frac{3}{2} kT = \frac{3}{2} \times 1.38 \times 10^{-23} \times 10^7 = 2.1 \times 10^{-16} \text{ J}$$

.....

OSCILLATIONS AND WAVES

OSCILLATIONS

- Different types of motion
- Simple harmonic motion
- Important terms like oscillation, amplitude, time period, angular frequency, phase difference
- Displacement, velocity and acceleration in SHM
- Energy in SHM : kinetic and potential
- Oscillations due to a spring
- Oscillations of a loaded spring
- Simple pendulum
- Free, damped and maintained oscillations
- Forced, Resonant and coupled oscillations
- Wave motion
- Longitudinal and transverse waves
- Speed of longitudinal waves
- Newton's formula and Laplace correction
- Factors affecting speed of sound in a gas
- Displacement relation for a progressive wave
- Principle of superposition of waves
- Stationary waves
- Stationary waves in a string fixed at both ends
- Beats and its applications

Periodic Motion: A motion which repeats itself over and over again after a regular interval of time.

Oscillatory Motion: A motion in which a body moves back and forth repeatedly about a fixed point.

Periodic function: A function that repeats its value at regular intervals of its argument is called periodic function. The following sine and cosine functions are periodic with period T.

$$f(t) = \sin \frac{2\pi t}{T} \quad \text{and} \quad g(t) = \cos \frac{2\pi t}{T}$$

These are called Harmonic Functions.

Note: - All Harmonic functions are periodic but all periodic functions are not harmonic.

One of the simplest periodic functions is given by

$$f(t) = A \cos \omega t \quad [\omega = 2\pi/T]$$

If the argument of this function ωt is increased by an integral multiple of 2π radians, the value of the function remains the same. The function $f(t)$ is then periodic and its period, T is given by

$$T = \frac{2\pi}{\omega}$$

➤ **Simple Harmonic Motion (SHM):** A particle is said to execute SHM if it moves to and fro about a mean position under the action of a restoring force which is directly proportional to its displacement from mean position and is always directed towards mean position.

Restoring Force \propto Displacement

$$F \propto x$$

$$F = -kx$$

Where 'k' is force constant.

Amplitude: Maximum displacement of oscillating particle from its mean position.

$$x_{Max} = \pm A$$

Time Period: Time taken to complete one oscillation.

Frequency: $= \frac{1}{T}$. Unit of frequency is Hertz (Hz).

$$1 \text{ Hz} = 1 \text{ s}^{-1}$$

Angular Frequency: $\omega = \frac{2\pi}{T} = 2\pi\nu$

$$\text{S.I unit } \omega = \text{rad s}^{-1}$$

Phase:

1. The Phase of Vibrating particle at any instant gives the state of the particle as regards its position and the direction of motion at that instant.

It is denoted by ϕ .

2. **Initial phase or epoch:** The phase of particle corresponding to time $t = 0$.

It is denoted by ϕ_0 .

Displacement in SHM :

$$x = A \cos(\omega t + \phi_0)$$

Where, x = Displacement,

A = Amplitude

ωt = Angular Frequency

ϕ_0 = Initial Phase.

Case 1: When Particle is at mean position $x = 0$

$$v = -\omega\sqrt{A^2 - 0^2} = -\omega A$$

$$v_{\max} = \omega A = \frac{2\pi}{T} A$$

Case 2: When Particle is at extreme position $x = \pm A$

$$v = -\omega\sqrt{A^2 - A^2} = 0$$

Acceleration

Case 3: When particle is at mean position $x = 0$,

$$\text{acceleration} = -\omega^2(0) = 0.$$

Case 4: When particle is at extreme position then

$$x = A \quad \text{acceleration} = -\omega^2 A$$

Formula Used :

1. $x = A \cos(\omega t + \phi_0)$

2. $v = \frac{dx}{dt} = -\omega\sqrt{A^2 - x^2}$, $v_{\max} = \omega A$.

3. $a = \frac{dv}{dt} = \omega^2 A \cos \cos(\omega t + \phi_0) = -\omega^2 x$

$$a_{\max} = \omega^2 A$$

4. Restoring force $F = -kx = -m\omega^2 x$

Where $k =$ force constant & $\omega^2 = \frac{k}{m}$

5. Angular freq. $\omega = 2\pi\nu = \frac{2\pi}{T}$

6. Time Period $T = 2\pi\sqrt{\frac{\text{Displacement}}{\text{Acceleration}}} = 2\pi\sqrt{\frac{x}{a}}$

7. Time Period $T = 2\pi\sqrt{\frac{\text{Inertia Factor}}{\text{Spring Factor}}} = 2\pi\sqrt{\frac{m}{k}}$

8. P.E at displacement 'y' from mean position

$$E_P = \frac{1}{2}ky^2 = \frac{1}{2}m\omega^2 y^2 = \frac{1}{2}m\omega^2 A^2 \sin^2 \omega t$$

9. K.E. at displacement 'y' from the mean position

$$E_K = \frac{1}{2}k(A^2 - y^2) = \frac{1}{2}m\omega^2(A^2 - y^2) \\ = \frac{1}{2}m\omega^2 A^2 \cos^2 \omega t$$

10. Total Energy at any point

$$E_T = \frac{1}{2}kA^2 = \frac{1}{2}m\omega^2 A^2 = 2\pi^2 mA^2 \nu^2$$

11. Spring Factor $K = F/y$

12. Period Of oscillation of a mass 'm' suspended from a mass less spring of force constant 'k'

$$T = 2\pi\sqrt{\frac{m}{k}}$$

For two springs of spring factors k_1 and k_2 connected in parallel effective spring factor

$$k = k_1 + k_2 \quad \therefore T = 2\pi\sqrt{\frac{m}{k_1 + k_2}}$$

13. For two springs connected in series, effective spring factor 'k' is given as

$$\frac{1}{k} = \frac{1}{k_1} + \frac{1}{k_2} \quad \text{Or} \quad k = \frac{k_1 k_2}{k_1 + k_2}$$

$$T = 2\pi \sqrt{\frac{m(k_1 + k_2)}{k_1 k_2}}$$

14. Oscillation of simple pendulum

$$T = 2\pi \sqrt{\frac{l}{g}} \quad v = \frac{1}{2\pi} \sqrt{\frac{g}{l}}$$

15. For a liquid of density ρ contained in a U-tube up to height 'h'

$$T = 2\pi \sqrt{\frac{h}{g}}$$

16. For a body dropped in a tunnel along the diameter of earth $T = 2\pi \sqrt{\frac{R}{g}}$ where **R** = Radius of earth

17. Resonance: If the frequency of driving force is equal to the natural frequency of the oscillator itself, the amplitude of oscillation is very large then such oscillations are called resonant oscillations and phenomenon is called resonance.

WAVES

Angular wave number: It is phase change per unit distance.

$$k = \frac{2\pi}{\lambda}$$

i.e. λ , S.I unit of k is radian per meter.

Relation between velocity, frequency and wavelength is given as :- $V = \nu \lambda$

Velocity of Transverse wave:-

(i) In solid molecules having modulus of rigidity ' η ' and density ' ρ ' is $v = \sqrt{\frac{\eta}{\rho}}$

(ii) In string for mass per unit length 'm' and tension 'T' is $v = \sqrt{\frac{T}{m}}$

Velocity of longitudinal wave:-

(i) in solid $v = \sqrt{\frac{Y}{\rho}}$, Y= young's modulus

(ii) in liquid $v = \sqrt{\frac{K}{\rho}}$, K= bulk modulus

(iii) in gases $v = \sqrt{\frac{K}{\rho}}$, K= bulk modulus

According to Newton's formula: When sound travels in gas then changes take place in the medium are

isothermal in nature. $v = \sqrt{\frac{P}{\rho}}$

According to Laplace: When sound travels in gas then changes take place in the medium are adiabatic in nature.

$$V = \sqrt{\frac{P\gamma}{\rho}} \quad \text{Where } \gamma = \frac{C_p}{C_v}$$

Factors effecting velocity of sound :-

(i) Pressure – No effect

(ii) Density – $V \propto \frac{1}{\sqrt{\rho}}$ or $\frac{V_1}{V_2} = \sqrt{\frac{\rho_2}{\rho_1}}$

(iii) Temp- $V \propto \sqrt{T}$ or $\frac{V_1}{V_2} = \sqrt{\frac{T_1}{T_2}}$

Effect of humidity :- sound travels faster in moist air

(iv) Effect of wind – velocity of sound increasing along the direction of wind.

Wave equation:- if wave is travelling along + x-axis

(i) $Y = A \sin(\omega t - kx)$, Where, $k = \frac{2\pi}{\lambda}$

(ii) $Y = A \sin 2\pi \left(\frac{t}{T} - \frac{x}{\lambda} \right)$

(iii) $Y = A \sin \frac{2\pi}{T} (vt - x)$

If wave is travelling along –ve x- axis

(iv) $Y = A \sin(\omega t + kx)$, Where, $k = \frac{2\pi}{\lambda}$

(v) $Y = A \sin 2\pi \left(\frac{t}{T} + \frac{x}{\lambda} \right)$

(vi) $Y = A \sin \frac{2\pi}{T} (vt + x)$

Phase and phase difference

Phase is the argument of the sine or cosine function representing the wave. $\phi = 2\pi \left(\frac{t}{T} - \frac{x}{\lambda} \right)$

Relation between phase difference ($\Delta\phi$) and time interval (Δt) is $\Delta\phi = -\frac{2\pi}{T} \Delta t$

Relation between phase difference ($\Delta\phi$) and path difference (Δx) is $\Delta\phi = -\frac{2\pi}{\lambda} \Delta x$

Equation of stationary wave:-

$$(1) Y_1 = a \sin 2\pi \left(\frac{t}{T} - \frac{x}{\lambda} \right) \text{ (incident wave)}$$

$$Y_2 = \pm a \sin 2\pi \left(\frac{t}{T} + \frac{x}{\lambda} \right) \text{ (reflected wave)}$$

Stationary wave formed

$$Y = Y_1 + Y_2 = \pm 2a \cos \frac{2\pi x}{\lambda} \sin \frac{2\pi t}{T}$$

(2) For (+ve) sign antinodes are at $x = 0, \frac{\lambda}{2}, \lambda, \frac{3\lambda}{2}, \dots$

And nodes at $x = \frac{\lambda}{4}, \frac{3\lambda}{4}, \frac{5\lambda}{4}, \dots$

(3) For (-ve) sign antinodes are at $x = \frac{\lambda}{4}, \frac{3\lambda}{4}, \frac{5\lambda}{4}, \dots$

Nodes at $x = 0, \frac{\lambda}{2}, \lambda, \frac{3\lambda}{2}, \dots$

(4) Distance between two successive nodes or antinodes are $\frac{\lambda}{2}$ and that between nodes and nearest

antinodes is $\frac{\lambda}{4}$.

(5) Nodes-point of zero displacement-

Antinodes- point of maximum displacement-

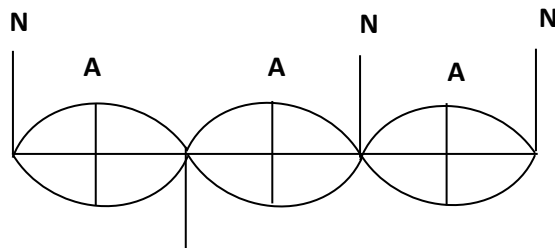

A = Antinodes

Mode of vibration of strings:-

$$a) v = \frac{p}{2L} \sqrt{\frac{T}{m}} \text{ Where } T = \text{Tension}$$

M = mass per unit length

ν = frequency, V = velocity of second, $p = 1, 2, 3, \dots$

b) When stretched string vibrates in P loops $v_p = \frac{p}{2L} \sqrt{\frac{T}{m}} = p\nu$

c) For string of diameter D and density ρ

$$v = \frac{1}{LD} \sqrt{\frac{T}{\pi\rho}}$$

$$v \propto \frac{1}{L}, \quad vL = \text{constant}$$

d) Law of length

Beats formation

1. Beat frequency = No. of beats per second = Difference in frequency of two sources.

$$v_2 = v_1 \pm b$$

2. If the prong of tuning fork is filed, its frequency increases. If the prong of a tuning fork is loaded with a little way, its frequency decreases. These facts can be used to decide about + or – sign in the above equation.

ONE MARK QUESTIONS :

- Which of the following relationships between the acceleration ‘a’ and the displacement ‘x’ of a particle involve simple harmonic motion?
(a) $a=0.7x$ (b) $a=-200x^2$ (c) $a = -10x$ (d) $a=100x^3$
- Can a motion be periodic and not oscillatory?
- Can a motion be periodic and not simple harmonic? If your answer is yes, give an example and if not, explain why?
- A girl is swinging in the sitting position. How will the period of the swing change if she stands up?
- The maximum velocity of a particle, executing S.H.M with amplitude of 7mm is 4.4 m/s. What is the period of oscillation?
- Why the longitudinal wave are also called pressure waves?
- How does the frequency of a tuning fork change, when the temperature is increased?
- An organ pipe emits a fundamental note of a frequency 128Hz. On blowing into it more strongly it produces the first overtone of the frequency 384Hz. What is the type of pipe –Closed or Open?
- All harmonic are overtones but all overtones are not harmonic. How?
- What is the factor on which pitch of a sound depends?

Answer Key:

- Ans: - (c) represent SHM.
- Ans: - Yes, for example, uniform circular motion is periodic but not oscillatory.
- Ans:- Yes, when a ball is dropped from a height on a perfectly elastic surface ,the motion is oscillatory
but not simple harmonic as restoring force $F=mg=\text{constant}$ and not $F \propto -x$, which is an essential condition for S.H.M.

$$T = 2\pi \sqrt{\frac{l}{g}}$$

- Ans:-The girl and the swing together constitute a pendulum of time period
as the girl stands up her centre of gravity is raised. The distance between the point of suspension and the centre of gravity decreases i.e. length ‘l’ decreases .Hence the time period ‘T’ decreases.

$$5. \text{ Ans: - } v_{\max} = \frac{2\pi A}{T} A, \quad T = \frac{2\pi A}{v_{\max}} = \frac{2 \times 22 \times .007}{7 \times 4.4} = 0.01s$$

- Ans: - Longitudinal wave travel in a medium as series of alternate compressions and rare fractions i.e. they travel as variations in pressure and hence are called pressure waves.

7. **Ans:** -As the temperature is increased, the length of the prong of a tuning fork increased. This increased the wavelength of a stationary waves set up in the tuning fork. As frequency,

$$v = \frac{1}{\lambda}, \text{ So the frequency of tuning fork decreases.}$$

8. **Ans:** - The organ pipe must be closed organ pipe, because the frequency the first overtone is three times the fundamental frequency.
9. **Ans:** -The overtones with frequencies which are integral multiple of the fundamental frequency are called harmonics. Hence all harmonic are overtones. But overtones which are non-integrals multiples of the fundamental frequency are not harmonics.
10. **Ans:** - The pitch of a sound depends on its frequency.

TWO MARK QUESTIONS

- A simple pendulum consisting of an inextensible length 'l' and mass 'm' is oscillating in a stationary lift. The lift then accelerates upwards with a constant acceleration of 4.5 m/s². Write expression for the time period of simple pendulum in two cases. Does the time period increase, decrease or remain the same, when lift is accelerated upwards?
- All trigonometric functions are periodic, but only sine or cosine functions are used to define SHM. Why?
- The Length of a simple pendulum executing SHM is increased by 2.1%. What is the percentage increase in the time period of the pendulum of increased length?
- An open organ pipe produces a note of frequency 5/2 Hz at 150C, calculate the length of pipe. Velocity of sound at 00C is 335 m/s.
- An incident wave is represented by $Y(x, t) = 20\sin(2x - 4t)$. Write the expression for reflected wave
 - From a rigid boundary
 - From an open boundary.
- Explain why
 - in a sound wave a displacement node is a pressure antinode and vice-versa
 - The shape of pulse gets- distorted during propagation in a dispersive medium.

Answer Key:

1. **Ans.** When the lift is stationary, $T = 2\pi\sqrt{\frac{l}{g}}$

When the lift accelerates upwards with an acceleration of 4.5 m/s²

$$T = 2\pi\sqrt{\frac{l}{g+4.5}}$$

Therefore, the time period decreases when the lift accelerates upwards.

2. **Ans.** All trigonometric functions are periodic. The sine and cosine functions can take value between -1 to +1 only. So they can be used to represent a bounded motion like SHM. But the functions such as tangent, cotangent, secant and cosecant can take value between 0 and ∞ (both negative and positive). So these functions cannot be used to represent bounded motion like SHM.

3. **Ans.** Time Period, $T = 2\pi\sqrt{\frac{l}{g}}$ i.e. $T \propto \sqrt{l}$.

The percentage increase in time period is given by

$$\frac{\Delta T}{T} \times 100 = \frac{1}{2} \frac{\Delta l}{l} \times 100 \text{ (for small variation)}$$

$$= \frac{1}{2} \times 2.1\%$$

$$= 1.05\%$$

4. Ans. Velocity of sound at 15°C

$V = V_0 + 0.61 \times t = 335 + 0.61 \times 15 = 344.15 \text{ m/s}$. (Thermal coefficient of velocity of sound wave is $.61/^\circ\text{C}$)

Fundamental frequency of an organ pipe

$$v = \frac{V}{4L}, \therefore L = \frac{V}{4v} = \frac{344.15}{4 \times 512} = 0.336 \text{ m}$$

5. Ans. (i) The wave reflected from a rigid boundary is

$$Y(x, t) = -20 \sin(2x + 4t)$$

(i) The wave reflected from an open boundary is

$$Y(x, t) = 20 \sin(2x + 4t)$$

6. Ans. (i) At a displacement node the variations of pressure is maximum. Hence displacement node is the a pressure antinode and vice-versa.

(ii) When a pulse passes through a dispersive medium the wavelength of wave changes. So, the shape of pulse changes i.e. it gets distorted.

THREE MARK QUESTIONS

- The speed of longitudinal wave 'V' in a given medium of density ρ is given by the formula, use this formula to explain why the speed of sound in air.
(a) is independent at pressure
(b) increases with temperature and
(c) increases with humidity
- Write any three characteristics of stationary waves.
- The equation of a plane progressive wave is, $y = 10 \sin 2\pi(t - 0.005x)$ where y & x are in cm & t in second. Calculate the amplitude, frequency, wavelength & velocity of the wave.
- Write displacement equation respecting the following condition obtained in SHM.
Amplitude = 0.01m
Frequency = 600Hz
Initial phase = $\frac{\pi}{6}$
- The amplitude of oscillations of two similar pendulums similar in all respect are 2cm & 5cm respectively. Find the ratio of their energies of oscillations.
- What is the condition to be satisfied by a mathematical relation between time and displacement to describe a periodic motion?
- Which of the following function of time represent, (a) simple harmonic (b) periodic but not SHM and (c) non periodic ?

(i) $\sin \omega t - \cos \omega t$ (ii) $\sin^3 \omega t$ (iii) $3 \cos(\frac{\pi}{2} - 2\omega t)$ (iv) $\exp(-\omega^2 t^2)$

Answer Key:

- The speed of longitudinal wave 'V' in a given medium of density ρ is given by the formula, use this formula to explain why the speed of sound in air.
- (a) is independent at pressure
(b) increases with temperature and
(c) increases with humidity
- Ans. (i) in stationary waves, the disturbance does not advance forward. The conditions of crest and trough merely appear and disappear in fixed position to be followed by opposite condition after every half time period. (ii) The distance between two successive nodes or antinodes is equal to half the wavelength. (iii) The amplitude varies gradually from zero at the nodes to the maximum at the antinodes.

4. **Ans.** Given, $y = 10\sin 2\pi(t - 0.005x)$ (1)

Standard equation for harmonic wave is, $y = A \sin 2\pi(\frac{t}{T} - \frac{x}{\lambda})$ (2)

Comparing eqn (1) & (2), $A = 10$, $\frac{1}{T} = 1$, $\frac{1}{\lambda} = 0.005$

(i) Amplitude $A = 10\text{cm}$

(ii) Frequency $\nu = \frac{1}{T} = 1\text{Hz}$

(iii) Wavelength $\lambda = \frac{1}{0.005} = 200\text{cm}$

(iv) Velocity $v = \nu \lambda = 1 \times 200 = 200\text{cm/s}$

5. **Ans.** $Y = A \sin (2\pi\nu t + \phi_0)$

$= 0.01 \sin (1200\pi t + \frac{\pi}{6})$

6. **Ans.** $\frac{E_1}{E_2} = (\frac{A_1}{A_2})^2 = (\frac{2}{3})^2 = 4:25$

7. **Ans.** A periodic motion repeats after a definite time interval T. So,

$$y(t) = y(t + T) = y(t + 2T) \text{ etc.}$$

7. **Ans.** (i) $x(t) = \sin \omega t - \cos \omega t = \sqrt{2} \sin(\omega t - \frac{\pi}{2})$, so the function is in SHM.

(ii) $(t) = \sin^3 \omega t = \frac{1}{4}(3\sin \omega t - \sin 3\omega t)$, represent two separate SHM motion but their combination does not represent SHM.

(iii) $(t) = 3 \cos(\frac{\pi}{4} - 2\omega t) = 3 \cos(2\omega t - \frac{\pi}{4})$, represent SHM.

(iv) $\exp \exp(-\omega^2 t^2) = \text{non periodic.}$

FIVE MARK QUESTIONS

- Discuss Newton's formula for velocity of sound in air. What correction was made to it by Laplace and why?
- (a) What are beats? Prove that the number of beats per second is equal to the difference between the frequencies of the two superimposing wave.
(b) Draw fundamental nodes of vibration of stationary wave in (i) closed pipe, (ii) in an open pipe.
- Discuss the formation of harmonics in a stretched string. Show that in case of a stretched string the first four harmonics are in the ratio 1:2:3:4.
- For a travelling harmonic wave, $y = 2\cos(10t - 0.008x + 0.35)$ where x & y are in cm and t in second. What is the phase difference between oscillatory motions at two points separated by a distance of

- (i) 4cm (ii) 0.5m (iii) $\lambda/2$ (iv) $3\lambda/4$

- (i) A steel rod 100 cm long is clamped at its middle. The fundamental frequency of longitudinal vibrations of the rod is given to be 2.53 kHz. What is the speed of sound in steel?
(ii) A pipe 20 cm long is closed at one end. Which harmonic mode of the pipe is resonantly excited by a 430 Hz source? Will this same source be in resonance with the pipe if both ends are open? (Speed of sound = 340 m/s).
- Show that for a particle in linear S.H.M., the average kinetic energy over a period of oscillation is equal to the average potential energy over the same period. At what distance from the mean position is the kinetic energy in simple harmonic oscillator equal potential energy?

Answer Key:

1. Ans. According to Newton the change in pressure & volume in air is an isothermal process. Therefore he calculated,

$$v = \sqrt{\frac{p}{\rho}}$$

on substituting the required value he found, the velocity of sound was not in close agreement with the observation value. Then Laplace pointed out the error in Newton's formula. According to Laplace the change in

pressure and volume is an adiabatic process. So he calculated the value of sound as, $v = \sqrt{\frac{\gamma r}{\rho}}$ on putting the required value he found velocity of sound as 332 m/s very close to observed theory.

2. (a) What are beats? Prove that the number of beats per second is equal to the difference between the frequencies of the two superimposing waves.

(b) Draw fundamental nodes of vibration of stationary wave in (i) closed pipe, (ii) in an open pipe.

3. Discuss the formation of harmonics in a stretched string. Show that in case of a stretched string the first four harmonics are in the ratio 1:2:3:4.

5. Ans. $y = 2 \cos(10t - 0.008x + 0.35)$ (i)

We know, $y = A \cos\left(\frac{2\pi t}{T} - \frac{2\pi x}{\lambda} + \phi\right)$ (ii)

From (i) & (ii), $\frac{2\pi}{\lambda} = 0.008$, $\lambda = \frac{2\pi}{0.008} \text{ cm} = \frac{2\pi}{0.80} \text{ m}$.

Phase difference, $\Delta\phi = \frac{2\pi}{\lambda} * \text{path difference} = \frac{2\pi}{\lambda} * \Delta x$.

When $\Delta x = 4 \text{ cm}$, $\Delta\phi = \frac{2\pi}{2\pi} * 0.80 * 4 = 3.2 \text{ rad}$.

When $\Delta x = 0.5 \text{ m}$, $\Delta\phi = \frac{2\pi}{2\pi} * 0.80 * 0.5 = 0.40 \text{ rad}$.

When $\Delta x = \frac{\lambda}{2}$, $\Delta\phi = \frac{2\pi}{\lambda} * \frac{\lambda}{2} = \pi \text{ rad}$.

When $\Delta x = \frac{3\lambda}{4}$, $\Delta\phi = \frac{2\pi}{\lambda} * \frac{3\lambda}{4} = \frac{3\pi}{2} \text{ rad}$.

6. Ans. (i) For the fundamental mode,

$$\lambda = 2L = 2 \times 100 = 200 \text{ cm} = 2 \text{ m}.$$

$$\text{Frequency } v = 2.53 \text{ kHz} = 2530 \text{ Hz}$$

$$\text{Speed of sound, } v = v\lambda = 2530 \times 2 = 5060 \text{ m/s} \\ = 5.06 \text{ km/s}$$

- (ii) Length of pipe $L = 20 \text{ cm} = 0.2 \text{ m}$

$$\text{Speed of sound } v = 340 \text{ m/s}$$

Fundamental frequency of closed organ pipe

$$v = v/4L = \frac{340}{4 \times 0.2} = 425 \text{ Hz} \text{ sw can be excited}$$

Fundamental frequency of open organ pipe

$$v' = \frac{v}{2L} = \frac{340}{2 \times 0.2} = 850 \text{ Hz}$$

Hence source of frequency 430 Hz will not be in resonance with open organ pipe.

CASE BASED QUESTIONS :

1. When we speak, the sound moves outward from us, without any flow of air from one part of the medium to another. The disturbances produced in air are much less obvious and only our ears or a microphone can detect them. These patterns, which move without the actual physical transfer or flow of matter as a whole, are called waves. The most familiar type of waves such as waves on a string, water waves, sound waves, seismic waves, etc. is the so-called mechanical waves. These waves require a medium for propagation, they cannot propagate through vacuum. They involve oscillations of constituent particles and depend on the elastic properties of the medium. The electromagnetic waves that you will learn in Class XII are a different type of wave.

Electromagnetic waves do not necessarily require a medium – they can travel through vacuum. Light, radio waves, X-rays, are all electromagnetic waves. We have seen that motion of mechanical waves involves oscillations of constituents of the medium. If the constituents of the medium oscillate perpendicular to the direction of wave propagation, we call the wave a transverse wave. If they oscillate along the direction of wave propagation, we call the wave a longitudinal wave. In transverse waves, the particle motion is normal to the direction of propagation of the wave. Therefore, as the wave propagates, each element of the medium undergoes a shearing strain. Transverse waves can, therefore, be propagated only in those media, which can sustain shearing stress, such as solids and not in fluids. Fluids, as well as, solids can sustain compressive strain; therefore, longitudinal waves can be propagated in all elastic media.

For example, in medium like steel, both transverse and longitudinal waves can propagate, while air can sustain only longitudinal waves. Answer the following.

1) Air can sustain

- a) Transverse waves b) longitudinal waves c) both a and b d) none of these

2) The electromagnetic waves can pass through

- a) Solids only b) Fluids only c) Any medium even through vacuum d) None of these

3) Define Transverse waves

4) Define longitudinal waves

5) Differentiate between Transverse waves and longitudinal waves

Answer key-1

1) b 2) c

3) If the constituents of the medium oscillate perpendicular to the direction of wave propagation, wave is called as transverse wave.

4) If oscillations of constituents of the medium are along the direction of wave propagation that is parallel to direction of propagation we call the wave a longitudinal wave.

5) Following are differentiation points

Sr No.	Transverse waves	longitudinal waves
1	If the constituents of the medium oscillate perpendicular to the direction of wave propagation, wave is called as transverse wave	If oscillations of constituents of the medium are along the direction of wave propagation that is parallel to direction of propagation we call the wave a longitudinal wave.
2	Can pass through solids only	Can pass through both solids and fluids
3	Example electromagnetic waves	Example sound wave

Case Study – 2

What happens if a pulse or a wave meets a boundary? If the boundary is rigid, pulse travelling along a stretched string and being reflected by the boundary. Assuming there is no absorption of energy by the boundary, the reflected wave has the same shape as the incident pulse i.e. crest is reflected as crest and trough as trough but it suffers a phase change of π or 180° on reflection. This is because the boundary is rigid and the disturbance must have zero displacement at all times at the boundary. By the principle of superposition, this is possible only if the reflected and incident waves differ by a phase of π , so that the resultant displacement is zero. This reasoning is based on boundary condition on a rigid wall. If on the other hand, the boundary point is not rigid but completely free to move (such as in the case of a string tied to a freely moving ring on a rod), the reflected pulse has the same phase and amplitude (assuming no energy dissipation) as the incident pulse.

The net maximum displacement at the boundary is then twice the amplitude of each pulse. An example of non-rigid boundary is the open end of an organ pipe. To summaries, a travelling wave or pulse suffers a phase change of π on reflection at a rigid boundary and no phase change on reflection at an open boundary. We considered above reflection at one boundary. But there are familiar situations (a string fixed at either end or an air column in a pipe with either end closed) in which reflection takes place at two or more boundaries. In a string, for example, a wave travelling in one direction will get reflected at one end, which in turn will travel and get reflected from the other end. This will go on until there is a steady wave pattern set up on the string. Such wave patterns are called standing waves or stationary waves.

- 1) A travelling wave or pulse suffers a phase change of π on reflection at
 - a) a rigid boundary
 - b) open boundary
- 2) A travelling wave or pulse suffers no phase change on reflection at
 - a) a rigid boundary
 - b) open boundary
- 3) What are stationary waves?
- 4) Write a note on reflection of travelling wave from rigid boundary.
- 5) Write a note on reflection of travelling wave from open boundary.

Answer key – 2

- 1) a 2) b

3) A wave travelling in one direction will get reflected at one end, which in turn will travel and get reflected from the other end. This will go on until there is a steady wave pattern set up on the string. This wave remains steady in medium and does not travel further such wave patterns are called standing waves or stationary waves.

4) If the boundary is rigid, a pulse travelling along a stretched string and being reflected by the boundary. The reflected wave has the same shape as the incident pulse i.e. crest is reflected as crest and trough as trough but it suffers a phase change of π or 180° on reflection. This is because the boundary is rigid and the disturbance must have zero displacement at all times at the boundary. By the principle of superposition, this is possible only if the reflected and incident waves differ by a phase of π , so that the resultant displacement is zero. This reasoning is based on boundary condition on a rigid wall.

5) If the boundary point is not rigid but completely free to move the reflected pulse has the same phase and amplitude (assuming no energy dissipation) as the incident pulse. The net maximum displacement at the boundary is then twice the amplitude of each pulse. An example of non-rigid boundary is the open end of an organ pipe

Case Study – 3

Beats is an interesting phenomenon arising from interference of waves. When two harmonic Sound waves of slightly different frequencies and comparable amplitude are heard at the same time, we hear a sound of similar frequency (the average of two close frequencies), but we hear something else also. We hear audibly distinct waxing and waning of the intensity of the sound, with a frequency equal to the difference in the two close frequencies. Beat frequency is given by

$$f = f_1 - f_2$$

Artists use this phenomenon often while tuning their instruments with each other. They go on tuning until their sensitive ears do not detect any beats.

Doppler Effect is a wave phenomenon, it holds not only for sound waves but also for electromagnetic waves. However, here we shall consider only sound waves. Doppler Effect is defined as increase or decrease in frequency of sound due to relative motion between source of sound and observer. Frequency increases when source and observer comes towards each other and frequency decreases when source and observer go away from each other. For sound the observed frequency n is given in terms of the source frequency ν_0 by

$$v = v_0 \frac{v + v_0}{v + v_s}$$

Here v is the speed of sound through the medium, v_0 is the velocity of observer relative to the medium, and v_s is the source velocity relative to the medium. In using this formula, velocities in the direction OS should be treated as positive and those opposite to it should be taken to be negative. The change in frequency caused by a moving object due to Doppler Effect is used to measure their velocities in diverse areas such as military, medical science, astrophysics, etc. It is also used by police to check over-speeding of vehicles. A sound wave or electromagnetic wave of known frequency is sent towards a moving object. Some part of the wave is reflected from the object and its frequency is detected by the monitoring station. This change in frequency is called Doppler shift. It is used at airports to guide aircraft, and in the military to detect enemy aircraft. Astrophysicists use it to measure the velocities of stars. Doctors use it to study heart beats and blood flow in different parts of the body. Here they use ultrasonic waves, and in common practice, it is called sonography. Ultrasonic waves enter the body of the person, some of them are reflected back, and give information about motion of blood and pulsation of heart valves, as well as pulsation of the heart of the foetus. In the case of heart, the picture generated is called echo cardiogram.

Answer the following

- 1) Beats are heard after superposition of two waves with beat frequency
 - a) $v = v_1 - v_2$
 - b) $v = v_1 + v_2$
 - c) $v = (v_1 - v_2)/2$
 - d) None of these
- 2) When source and observer comes towards each other then frequency heard will
 - a) increase
 - b) decrease
 - c) remains same
 - d) None of these
- 3) Define beats
- 4) Define Doppler effect in sound
- 5) Note on applications of Doppler Effect in sound.

Answer key – 3

- 1) a 2) a

3) Beats is an interesting phenomenon arising from interference of waves. When two harmonic Sound waves of slightly different frequencies and comparable amplitude are heard at the same time, we hear audibly distinct waxing and waning of the intensity of the sound, with a frequency equal to the difference in the two close frequencies. Beat frequency is given by $v = v_1 - v_2$

b) It is also used by police to check over-speeding of vehicles.

c) A sound wave or electromagnetic wave of known frequency is sent towards a moving object. Some part of the wave is reflected from the object and its frequency is detected by the monitoring station. This change in frequency is called Doppler shift. It is used at airports to guide aircraft, and in the military to detect enemy aircraft.

d) Astrophysicists use it to measure the velocities of stars. Doctors use it to study heart beats and blood flow in different parts of the body.

e) Doctors use it to study heart beats and blood flow in different parts of the body. Here they use ultrasonic waves, and in common practice, it is called sonography. Ultrasonic waves enter the body of the person, some of them are reflected back, and give information about motion of blood and pulsation of heart valves, as well as pulsation of the heart of the foetus. In the case of heart, the picture generated is called echo cardiogram

ASSERTION AND REASON QUESTIONS - WAVES

Directions:

- (a) If both assertion and reason are true and the reason is the correct explanation of the assertion.
- (b) If both assertion and reason are true but reason is not the correct explanation of the assertion.
- (c) If assertion is true but reason is false.
- (d) If the assertion and reason both are false.

- Q.1. Assertion : Two persons on the surface of moon cannot talk to each other.
Reason : There is no atmosphere on moon.
Answer (a)
- Q.2. Assertion : The velocity of sound increases with increase in humidity.
Reason : Velocity of sound does not depend upon the medium.
Answer (c)
- Q.3. Assertion : Ocean waves hitting a beach are always found to be nearly normal to the shore.
Reason : Ocean waves are longitudinal waves.
Answer (c)
- Q.4. Assertion : Transverse waves are not produced in liquids and gases.
Reason : Light waves are transverse waves.
Answer (b)
- Q.5. Assertion : Compression and rarefaction involve changes in density and pressure.
Reason : When particles are compressed, density of medium increases and when they are rarefied, density of medium decreases.
Answer (a)
- Q.6. Assertion : Sound would travel faster on a hot summer day than on a cold winter day.
Reason : Velocity of sound is directly proportional to the square of its absolute temperature.
Answer (d)
- Q.7. Assertion : The basic of Laplace correction was that, exchange of heat between the region of compression and rarefaction in air is not possible.
Reason : Air is a bad conductor of heat and velocity of sound in air is large.
Answer (d)
- Q.8. Assertion : The flash of lightening is seen before the sound of thunder is heard.
Reason : Speed of sound is greater than speed of light
Answer (c)
- Q.9. Assertion : When we start filling an empty bucket with water, the pitch of sound produced goes on decreasing.
Reason : The frequency of man voice is usually higher than that of woman.
Answer (d)
- Q.10. Assertion : A tuning fork is made of an alloy of steel, nickel and chromium.
Reason : The alloy of steel, nickel and chromium is called elinvar.
Answer (b)

ASSERTION AND REASON QUESTIONS - OSCILLATIONS

Directions:

- (a) If both assertion and reason are true and the reason is the correct explanation of the assertion.
 - (b) If both assertion and reason are true but reason is not the correct explanation of the assertion.
 - (c) If assertion is true but reason is false.
 - (d) If the assertion and reason both are false.
-

- Q.1. Assertion : Sine and cosine functions are periodic functions.
Reason : Sinusoidal functions repeats its values after a definite interval of time.
Answer (a)
- Q.2. Assertion : Simple harmonic motion is a uniform motion.
Reason : Simple harmonic motion is not the projection of uniform circular motion.
Answer (c)
- Q.3. Assertion : Acceleration is proportional to the displacement. This condition is not sufficient for motion in simple harmonic.
Reason : In simple harmonic motion direction of displacement is also considered.
Answer (a)
- Q.4. Assertion : The graph between velocity and displacement for a harmonic oscillator is a parabola.
Reason : Velocity changes uniformly with displacement in harmonic motion.
Answer (d)
- Q.5. Assertion : When a simple pendulum is made to oscillate on the surface of moon, its time period increases.
Reason : Moon is much smaller as compared to earth.
Answer (b)
- Q.6. Assertion : All oscillatory motions are necessarily periodic motion but all periodic motion are not oscillatory.
Reason : Simple pendulum is an example of oscillatory motion.
Answer (b)
- Q.7. Assertion : Resonance is special case of forced vibration in which the natural frequency of vibration of the body is the same as the impressed frequency of external periodic force and the amplitude of forced vibration is maximum.
Reason : The amplitude of forced vibrations of a body increases with an increase in the frequency of the externally impressed periodic force.
Answer (b)
- Q.8. Assertion : The graph of total energy of a particle in SHM w.r.t., position is a straight line with zero slope.
Reason : Total energy of particle in SHM remains constant throughout its motion.
Answer (a)
- Q.9. Assertion : The frequency of a second pendulum in an elevator moving up with an acceleration half the acceleration due to gravity is 0.612 s^{-1} .
Reason : The frequency of a second pendulum does not depend upon acceleration due to gravity.
Answer (c)
- Q.10. Assertion : Damped oscillation indicates loss of energy.
Reason : The energy loss in damped oscillation may be due to friction, air resistance etc.
Answer (a)

SELF EVALUATION TEST

M.M-20

- Q1. What is the condition to be satisfied by a mathematical relation between time and displacement to describe a periodic motion? 1
- Q2. Define force constant and give its dimensional formula? 1
- Q3. What is the basic condition for the motion of a particle to be SHM? 1
- Q4. Why are stationary waves called so? 1
- Q5. Why does sound travel faster in solids than in gases? 1
- Q6. Find an expression for the total energy of a particle executing SHM. 2
- Q7. State the principle of superposition of waves. 2
-

Q8. A wave travelling along a string is given by $Y(x,t)=0.005\sin(80x-3t)$ where the numerical values are in SI units. Symbols have their usual meanings. Calculate: Frequency of the wave, Velocity of the wave, Amplitude of particle .

Q9. Draw the graphical representation of simple harmonic motion ,showing the

a) displacement-time curve.

b) velocity – time curve.

c) acceleration- time curve.

3

Q10. a) Explain the formation of beats.

b) When a tuning fork of unknown frequency is sounded with another tuning fork whose frequency is 384 Hz, 6beats per second are produced. When wax is attached to the first fork, then on sounding it with the sound, 4 beats per second are produced. Determine the unknown frequency.

5

SAMPLE QUESTION PAPER

SEE (BLUE PRINT) 2022-23

XI (PHYSICS)

MAXIMUM MARKS -70

S.NO.	CHAPTER	MCQ (1M)	A/R (1M)	VSA Q (2M)	SAQ (3M)	LAQ (5M)	CASE STUDY (4M)	TOTAL MARK S	WEIGHTAGE AS PER CURRICULUM 2022-23
1	UNITS AND MEASUREMENT	1		1				3	23
2	MOTION IN A STRAIGHT LINE	1		1			1	7	
3	MOTION IN A PLANE	1		1*		1		6	
4	LAWS OF MOTION	2		1	1			7	
5	WORK ENERGY AND POWER		1	1	1			6	17
6	SYSTEM OF PARTICLES AND ROTATIONAL MOTION	1				1		6	
7	GRAVITATION	1	1		1	1*		5	
8	MECHANICAL PROPERTIES OF SOLIDS	1		1				3	20
9	MECHANICAL PROPERTIES OF FLUIDS	1	1	1				4	
10	THERMAL PROPERTIES OF MATTER	1			1			4	
11	THERMODYNAMICS	1			1			4	
12	KINETIC THEORY OF GASES	1			1*		1	5	
13	OSCILLATION	2		1				4	10
14	WAVES	1				1		6	
Total no. of questions		15	3	7	5	3	2	70	70

NOTE:

- *Questions are not considered for mark split up (choice questions)
- Number mentioned within the bracket of the title of the tabular form represents mark allotted for each question.
- Number mentioned inside the columns of tabular form represents No. of questions asked as per the title.

KENDRIYA VIDYALAYA CHENNAI REGION

SESSION : 2022-2023

SAMPLE QUESTION PAPER

Class: XI

Maximum Marks: 70

SUBJECT: PHYSICS

Time Allowed: 3 hours

General Instructions:

- (1) There are 35 questions in all. All questions are compulsory
- (2) This question paper has five sections: Section A, Section B, Section C, Section D and Section E. All the sections are compulsory.
- (3) Section A contains eighteen MCQ of 1 mark each(including assertion and reason type), Section B contains seven questions of two marks each, Section C contains five questions of three marks each, section D contains three long questions of five marks each and Section E contains two case study based questions of 4 marks each.
- (4) There is no overall choice. However, an internal choice has been provided in section B, C, D and E. You have to attempt only one of the choices in such questions.
- (5) Use of calculators is not allowed. Logarithms may be used if necessary.

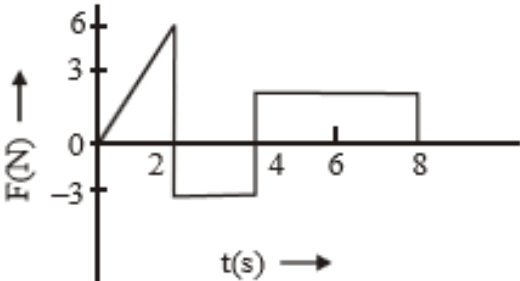
Q NO.	QUESTIONS	MARKS
SECTION A		
1	The physical quantity with dimensional formula $[M^0L^0T^{-1}]$ is	1
	A Force	
	B Energy	
	C Stress	
2	The numerical ratio of displacement to distance for a moving object is	1
	A always less than 1	
	B always equal to 1	
	C always more than 1	
3	A bullet is dropped from the same height when another bullet is fired horizontally. They will hit the ground	1
	A one after the other	
	B Simultaneously	
	C depends on the observer	
4	The force 'F' acting on a particle of mass 'm' is indicated by the force-time graph shown below. The change in momentum of the particle over the time interval from zero to 8 s is :	1
		
A	24 Ns	

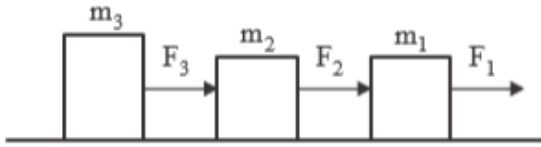
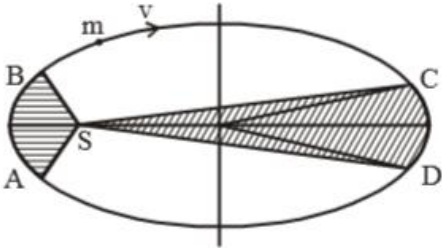
	B	20 Ns	
	C	12 Ns	
	D	6 Ns	
5		For the system shown in figure, the correct expression is 	1
	A	$F_3 = F_1 + F_2$	
	B	$F_3 = \frac{m_3 F}{F_1 + F_2 + F_3}$	
	C	$F_3 = \frac{m_3 F}{m_1 + m_2 + m_3}$	
	D	$F_3 = \frac{m_3 F}{m_1 + m_2}$	
6		A man stands at one end of a boat which is stationary in water. Neglect water resistance. The man now moves to the other end of the boat and again becomes stationary. The centre of mass of the 'man plus boat' system will remain stationary with respect to water	1
	A	in all cases	
	B	only when the man is stationary initially and finally	
	C	only if the man moves without acceleration on the boat	
	D	only if the man and the boat have equal masses	
7		The figure shows elliptical orbit of a planet m about the sun S . The shaded area SCD is twice the shaded area SAB . If t_1 is the time for the planet to move from C to D and t_2 is the time to move from A to B then 	1
	A	$t_1 = 4t_2$	
	B	$t_1 = 2t_2$	
	C	$t_1 = t_2$	
	D	$t_1 > t_2$	
8		The Young's modulus of a perfectly rigid body is	1
	A	Unity	
	B	Zero	
	C	Infinity	
	D	Some finite non-zero constant	
9		When the temperature increases, the viscosity of	1
	A	gases decreases and liquid increases	
	B	gases increases and liquid decreases	
	C	gases and liquids increases	
	D	gases and liquids decreases	
10		If α , β and γ are coefficient of linear, superficial and volume expansion respectively, then	1
	A	$\gamma = 3\alpha$	
	B	$\alpha = 3\gamma$	
	C	$\beta = 3\alpha$	
	D	$\gamma = 3\beta$	

		The area under P V graph in a thermodynamic process represents	
11	A	Work done	1
	B	Heat absorbs	
	C	Heat ejected	
	D	None of these	
12		If the pressure and the volume of certain quantity of ideal gas are halved, then its temperature	1
	A	is doubled	
	B	becomes one-fourth	
	C	remains constant	
13		The physical quantity which remains constant in simple harmonic motion is	1
	A	Kinetic energy	
	B	Potential energy	
	C	Restoring force	
14		The phase difference between the instantaneous velocity and acceleration of a particle executing simple harmonic motion is	1
	A	π	
	B	0.707π	
	C	Zero	
15		For a travelling harmonic wave, $y = 2\cos(10t - 0.008x + 0.35)$ where x & y are in cm and t in second. What is the distance between two points which are at the phase difference of π	1
	A	4 cm	
	B	0.5 cm	
	C	$\lambda/2$	
16		Two statements are given-one labeled Assertion (A) and the other labelled Reason (R). Select the correct answer to these questions from the codes (a), (b), (c) and (d) as given below. a) Both A and R are true and R is the correct explanation of A b) Both A and R are true and R is NOT the correct explanation of A c) A is true but R is false d) A is false and R is also false ASSERTION (A): A force applied on the body always does work on the body REASON: (R) : If a force applied on a body displaces the body along the direction of force work done will be minimum.	1
17		Two statements are given-one labelled Assertion (A) and the other labelled Reason (R). Select the correct answer to these questions from the codes (a), (b), (c) and (d) as given below. a) Both A and R are true and R is the correct explanation of A b) Both A and R are true and R is NOT the correct explanation of A c) A is true but R is false d) A is false and R is also false ASSERTION (A) : Escape velocity is independent on the angle of projection. REASON: (R) : Escape velocity from the surface of earth is $\sqrt{2gR}$ where R is radius of earth.	1

18	<p>Two statements are given-one labelled Assertion (A) and the other labelled Reason (R). Select the correct answer to these questions from the codes (a), (b), (c) and (d) as given below.</p> <p>a) Both A and R are true and R is the correct explanation of A b) Both A and R are true and R is NOT the correct explanation of A c) A is true but R is false d) A is false and R is also false</p> <p>ASSERTION (A) : Pascal's law is the working principle of a hydraulic lift. REASON: (R) : Pressure is equal to the thrust per unit area.</p>	1
SECTION B		
19	If $X = a + bt^2$, where X is in meter and t is in second. Find the units of a and b ?	2
20	State and prove work energy theorem for a variable force acting on a body.	2
21	The motion of a car along y -axis is given by $v(t) = -12t + 12$ where velocity v is in m/s and time t in seconds. Find the instantaneous position of the car as a function of time if at $t = 0$, it was at 5 m.	2
22	A particle is executing SHM. What fraction of its energy is kinetic when the displacement is half the amplitude?	2
23	State and write the relation to find the resultant of two vectors in it's magnitude using parallelogram law of vector addition (OR) Show that the elastic potential energy stored per unit volume of a stretched wire is equal to $1/2 \times \text{stress} \times \text{strain}$.	2
24	(a) Draw a neat and labelled diagram of Bernoulli's principle for an ideal fluid. (b) Write mathematical form of Bernoulli's principle.	2
25	A constant force acting on a body of mass 3 kg changes its velocity from $2m/s$ to $3.5m/s$ in $25s$. The direction of the motion of the body remains unchanged. What is the magnitude and direction of the force?	2
SECTION C		
26	Consider a mass ' m ' attached to a string of length ' l ' performing vertical circle. With the help of labelled diagram find the expression for (a) velocity at the top most point of the vertical circular motion. (b) minimum velocity at lowermost point to complete vertical circle	3
27	(a) State the first law of thermodynamics. (b) What is meant by isochoric process? (c) Write the relation between C_p and C_v	3
28	Prove that the pressure exerted by a gas is $P = 1/3 \rho c^2$ where ρ is the density and c is the root mean square velocity. OR Name the three modes of transfer of heat from one medium to other and explain in detail with an example for each	3
29	(a) Write the relation between linear momentum and kinetic energy (b) If the linear momentum is increased by 50% , What is the percentage change in its kinetic energy?	3
30	Show that the value of acceleration due to gravity decreases as we go inside the earth surface, by deducing the expression for the same and hence find the value of acceleration due to gravity at the centre of earth.	3
SECTION D		
31	(a) Find the torque of a force $7\hat{i} + 3\hat{j} - 5\hat{k}$ N about the origin acts on a particle whose position vector is $\hat{i} - \hat{j} + \hat{k}$ (b) Write the required condition for a body to be in i) translational equilibrium ii) rotational equilibrium	5

	(c) Write the relation between torque (τ) angular acceleration (α) and moment of inertia (I)	
32	<p>A displacement wave is represented by $y = 0.25 \times 10^{-3} \sin(500t + 0.025z)$. where y, t and z are in cm, sec and m respectively.</p> <p>Deduce</p> <ol style="list-style-type: none"> the direction of propagation of the wave. wave frequency wavelength the wave speed maximum particle velocity 	5
33	<p>(a) A body is projected with velocity u at an angle θ upward from the horizontal. Deduce the expression for</p> <ol style="list-style-type: none"> Time of flight Maximum height attained Horizontal range <p>(b) Prove that for a given velocity of projection, the horizontal range is same for θ and $(90^\circ - \theta)$</p> <p style="text-align: center;">(OR)</p> <p>(a) Define the term gravitational potential energy. (b) Is gravitational potential energy scalar or vector? (c) Prove that ratio of escape velocity of an object and its orbital velocity from the given point on the surface of earth is $\sqrt{2} : 1$</p>	5
SECTION E		
34	<p>CASE STUDY:</p> <p>Read the following paragraph and answer the questions.</p> <p>The average velocity tells us how fast an object has been moving over a given time interval but does not tell us how fast it moves at different instants of time during that interval. For this, we define instantaneous velocity or simply velocity v at an instant t. The velocity at an instant is defined as the limit of the average velocity as the time interval dt becomes infinitesimally small. In other words</p> $V = \lim_{dt \rightarrow 0} dx/dt$ $V = dx/dt$ <p>The variation in velocity with time for an object moving in a straight line can be represented by a velocity-time graph. In this graph, time is represented along the x-axis and the velocity is represented along the y-axis. We know that the product of velocity and time give displacement of an object moving with uniform velocity.</p> <p>The variation in distance with time for an object moving in a straight line can be represented by a position-time graph. In this graph, time is represented along the x-axis and the displacement is represented along the y-axis.</p> <ol style="list-style-type: none"> The area under velocity time graph gives _____ Slope of velocity time graph gives _____ 	4

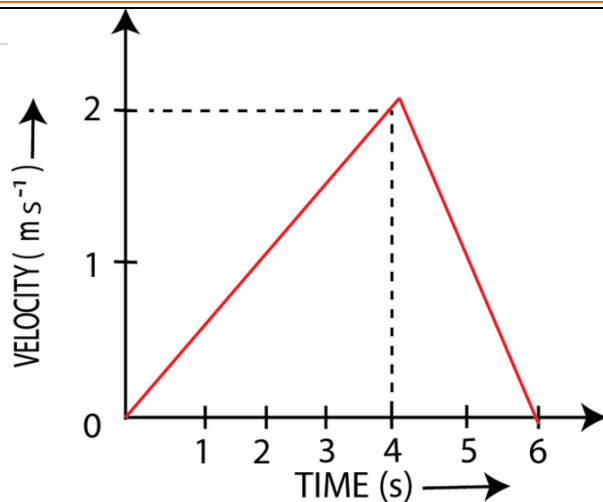

3) . The acceleration during the time interval 0 to 4 sec from the given graph is _____

(or)

Draw velocity-time graph and acceleration-time graph for freely falling body

CASE STUDY:

Read the following paragraph and answer the questions:

Boyle's law is a gas law which states that the pressure exerted by a gas (of a given mass, kept at a constant temperature) is inversely proportional to the volume occupied by it. In other words, the pressure and volume of a gas are inversely proportional to each other as long as the temperature and the quantity of gas are kept constant. Isothermal process is a thermodynamic process in which product of pressure and volume remains constant at constant temperature. Adiabatic process is a thermodynamic process in which pressure, volume and temperature of a gas change maintaining constant heat. Degrees of freedom is the total no. of independent coordinates required to specify the position of a molecule

5

4

1) Boyle's law is obeyed at high temperature and low pressure by real gases. (State **True/False**)

2) Charles law states that volume of an ideal gas is directly proportional to temperature at constant _____

3) State law of equi-partition of energy and how it is used to find the relation for the total internal energy of a mole of mono atomic gases

(OR)

3) A perfect gas at 27°C is heated at constant pressure so as to double its volume then it's temperature of the gas will be _____

Session Ending Examination -2022-23

Class - XI

Subject - Physics

Q. NO.	Description	Weightage
1	(d) Angular velocity $\omega = \frac{\theta}{t} = [M^0L^0T^{-1}]$	1
2	(d) $\frac{\text{Displacement}}{\text{distance}} \leq 1$	1
3	(b) In both the cases, the initial velocity in the vertical downward direction is zero. So they will hit the ground simultaneously	1
4	(c) Change in momentum, $\Delta p = \int F dt$ = Area of F-t graph = ar of Δ - ar of \square + ar of \square $= \frac{1}{2} \times 2 \times 6 - 3 \times 2 + 4 \times 3$ = 12 N-s	1
5	(c) Common acceleration of system is $a = \frac{F}{m_1 + m_2 + m_3}$ $\therefore \text{Force on } m_3 \text{ is } F_3 = m_3 \times a = \frac{m_3 F}{m_1 + m_2 + m_3}$	1
6	A	1
7	(b) According to Kepler's law, the areal velocity of a planet around the sun always remains constant. SCD : $A_1 - t_1$ (areal velocity constant) SAB : $A_2 - t_2$ $\frac{A_1}{t_1} = \frac{A_2}{t_2},$ $t_1 = t_2 \cdot \frac{A_1}{A_2}, \quad (\text{given } A_1 = 2A_2)$ $= t_2 \cdot \frac{2A_2}{A_2} \quad \therefore t_1 = 2t_2$	1
8	(c) For a perfectly rigid body strain produced is zero for the given force applied, so $Y = \text{stress/strain} = \infty$	1
9	B	1

10	<p>(a) $V + \Delta V = (L + \Delta L)^3 = (L + \alpha L \Delta T)^3$ $= L^3 + (1 + 3\alpha \Delta T + 3\alpha^2 \Delta T^2 + \alpha^3 \Delta T^3)$ $\Rightarrow \alpha^2$ and α^3 terms are neglected. $\therefore V(1 + \gamma \Delta T) = V(1 + 3\alpha \Delta T)$ $1 + \gamma \Delta T = 1 + 3\alpha \Delta T$ $\therefore \gamma = 3\alpha.$</p>	1
11	(a)	1
12	<p>(b) According to ideal gas law $\frac{P_1 V_1}{T_1} = \frac{P_2 V_2}{T_2}$ or $T_2 = T_1 \frac{P_2 V_2}{P_1 V_1}$ $\therefore T_2 = \frac{T \left(\frac{P}{2}\right) \left(\frac{V}{2}\right)}{PV} T_2 = \frac{T}{4}$</p>	1
13	(D) In simple harmonic motion, frequency remains constant and else changes with time.	1
14	<p>(d) Let $y = A \sin \omega t$ $v_{\text{inst}} = \frac{dy}{dt} = A\omega \cos \omega t = A\omega \sin(\omega t + \pi/2)$ Acceleration = $-A\omega^2 \sin \omega t$ $= A\omega^2 \sin(\pi + \omega t)$ $\therefore \phi = \frac{\pi}{2} = 0.5\pi$</p>	1
15	(c)	1
16	(D) Work done may be zero, even if F is not zero. $W = Fs \cos 0^\circ = Fs$ (maximum).	1
17	A	1
18	(B)	1
19	unit of a is m and unit of b is m/sec^2 .	1 + 1
20	Correct statement and proof	1 + 1
21	$x(t) = \int v dt = \int (-12t + 12) dt$ $= -12 \frac{t^2}{2} + 12t + c$ $= -6t^2 + 12t + c$	2

	<p>Since, at $t = 0$, $x(0) = 5$, therefore, $c = 5$</p> <p>Therefore, $x(t) = -6t^2 + 12t + 5 \text{ m}$</p>	
22	$K = \frac{1}{2} m \omega^2 \left[A^2 - \left(\frac{A}{2} \right)^2 \right]$ $= \frac{1}{2} m \omega^2 \left(\frac{3}{4} A^2 \right)$ $= \frac{3}{4} E$	2
23	<p>Correct statement Correct relation only (OR) Derivation with correct steps</p>	1+1
24	<p>Correct diagram and expression $P + \frac{1}{2} \rho v^2 + \rho g h = \text{constant}$</p>	1 + 1
25	<p>Given, to find , formulae</p> <p>Calculation with steps $F=ma=m(v-u)/t$ $F=0.18\text{N}$ FORCE IS ALONG THE DIRECTION OF MOTION</p>	1/2 + 1 + 1/2
26	<p>Derivation with necessary steps for deriving (a) $V = \sqrt{gl}$ (b) $V_1 = \sqrt{5gl}$</p>	2 + 1/2 + 1/2
27	<p>(a) Correct statement of first law (b) $\Delta V = 0$ (c) $C_P - C_V = R$</p>	1 + 1 + 1
28	<p>Diagram with explanation Derivation with necessary steps and correct expression $P = \frac{1}{3} \rho c^2$ or Meaning of conduction , convection, and radiation and an example for each</p>	1 + 2
29	<p>Correct relation $K = p^2/2m$</p> <p>Calculation with steps Percentage increase in $k=125\%$</p>	1 + 2
30	<p>Diagram , Deriving the relation of g with respect to depth Value of g at centre of earth = 0</p>	2 + 1
31	<p>(a) $\vec{F} = 7\hat{i} + 3\hat{j} - 5\hat{k}$, $\vec{r} = \hat{i} - \hat{j} + \hat{k}$</p> $\vec{\tau} = \vec{r} \times \vec{F}$ $= \begin{vmatrix} \hat{i} & \hat{j} & \hat{k} \\ 1 & -1 & 1 \\ 7 & 3 & -5 \end{vmatrix}$ $= (5 - 3)\hat{i} + (5 + 7)\hat{j} + (3 + 7)\hat{k} \quad \vec{\tau} = 2\hat{i} + 12\hat{j} + 10\hat{k}$ <p>(b) a) net force is zero b) net torque is zero</p>	2 + 3

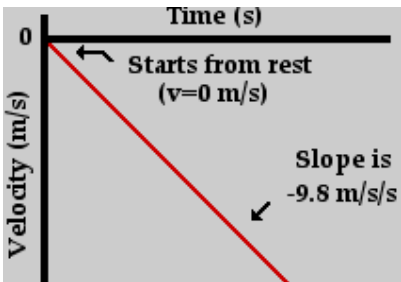
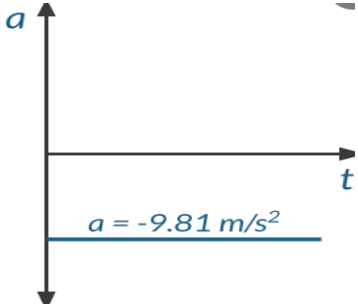
	(c) $\tau = I\alpha$	
32	<p>(i) -z direction</p> <p>(ii) $f = \frac{\omega}{2\pi} = \frac{500}{2\pi} = \frac{250}{\pi}$ Hz</p> <p>(iii) $\lambda = \frac{2\pi}{R}$ $= \frac{2\pi}{0.025} = 80\pi$ m</p> <p>(iv) $v = \frac{\omega}{R}$ $= \frac{500}{0.025} = 2 \times 10^4$ m/s</p> <p>(v) $v_{pmax} = \omega A$ $= 0.25 \times 10^{-3} \times 500 = 0.125$ cm/s</p>	1m for each
33	<p>(a) Diagram derivation with necessary steps Arriving to final expression</p> <p>(b) Proving the relation for θ and $90 - \theta$ (OR)</p> <p>(a) Correct definition (b) scalar (c) Diagram Derivation with necessary steps for both escape and orbital velocities and arriving to the ratio $\sqrt{2} : 1$</p>	3 + 2 2+3
34	<p>1) Displacement over given time interval 2) Acceleration 3) $a = dv/dt = 0.5$ m/s²</p> <p>(OR)</p> <div style="display: flex; align-items: center; justify-content: center;">  <div style="margin-left: 20px;">  </div> </div>	1 + 1 + 2
35	<p>1) True 2) pressure 3) correct statement arriving to the expression $\frac{3}{2} K_b T$ using the concept of equipartition of energy and degrees of freedom</p> <p>(OR)</p> <p>using charles law temperature becomes twice hint: $V/T = \text{Const.}$ getting $T=327^\circ\text{C}$</p>	1 + 1 + 2