

User Manual

[www.accuniq.com](http://www.accuniq.com)



**ACCUNIQ**

Adding accuracy to healthcare

## User Manual BC310



**selvas**   
Healthcare



The device bears the CE label in accordance with the provisions of Medical Device Directive 93/42/EEC.

THE PERSONS RESPONSIBLE FOR PLACING DEVICES ON THE EC MARKET UNDER MDD 93/42/EEC



SELVAS Healthcare, Inc.

155, Shinseong-ro, Yuseong-gu, Daejeon, 34109 Republic of Korea

TEL: 82-42-879-3000, FAX: 82-42-864-4462



VITAKO Sp. z o.o.

ul. Stanisława Żaryna 7c 02-593 Warszawa, POLAND

TEL: +48 505 522 888

# CONTENTS

|  |    |
|--|----|
| INTRODUCTION .....                                       | 5  |
| 1. INTENDED USE .....                                    | 5  |
| 2. WORD DEFINITIONS .....                                | 5  |
| 3. CLASSIFICATION AND COMPLIANCE .....                   | 6  |
| 4. SAFETY PRECAUTIONS .....                              | 6  |
| 5. SAFETY SYMBOLS AND INFORMATION .....                  | 10 |
| 6. Guidance for Electromagnetic compatibility(EMC) ..... | 12 |
| <br>   |    |
| ABOUT BODY COMPOSITION .....                             | 17 |
| TERM AND FUNCTION OF EACH PART .....                     | 19 |
| 1. Main Body .....                                       | 19 |
| 2. Basic Package .....                                   | 27 |
| 1) ACCUNIQ BC310 (For whole body) .....                  | 27 |
| 2) ACCUNIQ BC310 (For upper body) .....                  | 28 |
| 3) ACCUNIQ BC310 (For lower body) .....                  | 29 |
| 3. Options .....   | 30 |
| <br>   |    |
| INSTALLATION .....                                       | 31 |
| 1. Basic Installation of product .....                   | 31 |
| 2. Peripheral Device Installation .....                  | 32 |
| 1) Connecting PC .....                                   | 32 |
| 2) Connecting Printer (Option) .....                     | 33 |
| 3) Connecting EXTERNAL DEVICE (Option) .....             | 33 |
| 4) Replacing Thermal Paper .....                         | 34 |
| 5) The troubleshooting of thermal paper jam .....        | 35 |
| 3. Installation of Column (Option) .....                 | 36 |
| <br>   |    |
| SYSTEM SETUP .....                                       | 42 |
| 1. Entering SYSTEM SETUP .....                           | 42 |
| 2. Menu in SYSTEM SETUP .....                            | 42 |
| 3. Selecting a Menu in SYSTEM SETUP .....                | 42 |
| 4. Moving to SYSTEM SETUP .....                          | 43 |
| 5. Exiting SYSTEM SETUP .....                            | 43 |
| 6. Setup .....   | 44 |

|   |    |
|---|----|
| MEASUREMENT AND ANALYSIS .....                                    | 48 |
| 1. Precautions for Measurement .....                              | 48 |
| 2. Correct Posture .....  | 50 |
| 1) How to Touch Plate Electrodes .....                            | 50 |
| 2) How to Touch Handle Electrodes .....                           | 50 |
| 3) Measuring Posture .....  | 51 |
| 3. Measuring Procedure .....                                      | 52 |
| 1) Basic Analysis .....   | 52 |
| A. The automatic measurement .....                                | 52 |
| B. The manual measurement .....                                   | 55 |
| C. The measurement by Manager program .....                       | 57 |
| 2) Analysis Using Blood Pressure Monitor / Software program ..... | 59 |
| RESULT INTERPRETATION .....                                       | 60 |
| STORAGE & MAINTENANCE .....                                       | 65 |
| ERROR & REPAIR .....  | 66 |
| 1. Kinds of Error & Repair .....                                  | 66 |
| 2. Error Occurrence & Repair .....                                | 68 |
| AFTER SERVICE .....   | 69 |
| 1. AFTTER SERVICE .....   | 69 |
| 2. PACKING AND TRANSPORT .....                                    | 69 |
| SPECIFICATION .....   | 70 |
| WARRANTY .....  | 72 |

# INTRODUCTION

We highly appreciate that you chose our company's product.

You are kindly requested to be familiar with these directions before using this product and always keep it together with the product. In case you are not sure about any directions or problems arising while using the product, please contact our service center.

We will provide you with detailed instructions.

## 1. INTENDED USE

This device measures impedance by bioelectrical impedance analysis method and provides lots of information using measured impedance and inputted personal data (height, age, gender, weight).

It shows body composition of MBF, LBM, TBW, etc. and information to BMI, PBF, BMR, abdominal analysis, segmental analysis, etc.

## 2. WORD DEFINITIONS

To ensure safe operation and long term performance stability, it is essential that you fully understand the functions, operating and maintenance instructions by reading this manual before operating your unit.

Particular attention must be paid to all warnings, cautions and notes incorporated herein.

The following conventions are used throughout the manual to denote information of special emphasis.

### Warning



"Warning" indicates important information to the presence of a hazard which may cause severe personal injury, death or substantial property damage if the warning is ignored.

### Caution



"Caution" indicates important information to the presence of a hazard which may cause minor personal injury or property damage if the caution is ignored.

### Note



"Notice" indicates important information to notify installation, operation or maintenance of this device. "Notice" is important but not hazard-related. Hazard warnings are not included here.

### 3. CLASSIFICATION AND COMPLIANCE

- 1) This device is classified as;
  - Class 1 type-BF against electric shock
  - Ordinary equipment without protection against ingress of water
  - Equipment not suitable for use in presence of a flammable anesthetic mixture by standard of EN 60601-1:1998+A1: 1991:1995(Safety of Medical Electrical Equipment)
- 2) This device is complied with Class A for Noise-Emission, Level B for Noise-immunity, by standard of IEC 60601-1-2:2001(Electromagnetic Compatibility Requirements).

### 4. SAFETY PRECAUTIONS

This device is designed and manufactured with consideration of the safety of the operator and subject and also the reliability of the unit.

The following warnings, precautions and notes must be observed for safety;

#### Warning



During measurement of the body composition, a microcurrent of 180 $\mu$ A flows through the body. Individuals who have any kind of implanted active medical devices, such as pacemakers, should not use this equipment because the microcurrent can cause malfunction in the implanted device.

#### Warning



To prevent fire hazard, use only a correctly wired (100-240VAC) outlet, and do not use a MSO(Multiple Socket Outlet) that is not in compliance with IEC 60601-1.

#### Warning



To reduce the risk of electric shock or product damage, never plug-in or plug-out with wet hands.

#### Warning



Physically disabled persons should not attempt to take measurements alone, but instead should have their caretakers assist them in using the device.

#### Caution



The unit must be operated only by, or under supervision of a qualified person with our company or our distributors.

**Caution**

If you have experienced any trouble with the unit, switch it off immediately, and contact our company or its authorized dealer for assistance.

**Caution**

If you plan to connect any device from other manufacturers electrically or mechanically to the unit, contact our company or its authorized dealer for instructions before doing so.

When you connect computer or other system to the unit (RS-232C), the attached systems should be those certified by IEC 950 or equivalent standards for data processing equipment.

Configurations shall comply with the system standard EN 60601-1:2006.

Everybody who connects additional equipment to the signal input part or signal output part configures a medical system by standard EN 60601-1:2006.

If in doubt, consult the A/S department of local distributor.

**Caution**

Avoid the following environments for storage;

- Where the ambient temperature falls below -25°C or exceeds 70°C.
- Where the atmospheric pressure falls below 70kPa (700mbar) or exceeds 106kPa (1060mbar).
- Where the humidity is over 93% non-condensing.
- Where the unit is exposed to spray or splashing water.
- Where the unit is exposed to dust.
- Where the unit is exposed to water vapor.
- Where the unit is exposed to salty atmosphere.
- Where the unit is exposed to explosive gas.
- Where the unit is exposed to excessive shocks or vibrations.
- Where the angle of inclination of mounting surface exceeds 10 degrees.
- Where the unit is exposed to direct sunlight.

**Caution**

This device needs special precautions regarding EMC and needs to be installed and put into service according to the EMC information provided in the ACCOMPANYING DOCUMENTS.

**Caution**

Cross contamination is possible because this equipment is used with bare hands and feet. Refer to the cleaning and disinfecting methods in this manual.

**Caution**

Measurements may be impaired if this device is used near televisions, microwave ovens, X-ray equipment or other devices with strong electrical fields. To prevent such interference, use the meter at a sufficient distance from such devices or turn them off.

**Prohibition**

Do not disassemble or alter the device under any circumstances, as this could result in electric shock or injury as well as adversely affect the precision of measurements.

This device is specified as Class 1 type BF unit under the standard EN 60601-1: 2006(Basic safety and essential performance of Medical Electrical Equipment). Therefore, patients must not touch or handle inner side of the system at any time.

**Prohibition**

Do not touch signal input, signal output or other connectors, and the patient simultaneously.

**Prohibition**

The unit has previously been adjusted in the factory for optimum performance.

Do not attempt to adjust switches or any other things except those specified in this manual for operation.

**Prohibition**

Never pour any liquid directly on the scale platform, as it may leak and cause internal damage.

**Prohibition**

Never jump on the Weighing Platform, there may be a risk of stumbling and malfunction of the equipment.



**Note**

This equipment has been tested and found to comply with the limits for medical devices according to IEC 60601-1-2:2007. These limits are designed to provide reasonable protection against harmful interference in a typical medical installation. This equipment generates uses and can radiate radio frequency energy and, if not installed and used in accordance with the instructions, may cause harmful interference to other devices in the vicinity. However, there is no guarantee that interference will not occur in a particular installation. If this equipment does cause harmful interference to other devices, which can be determined by turning the equipment off and on, the user is encouraged to try to correct the interference by one or more of the following measures:

- Reorient or relocate the receiving device.
- Increase the separation between the equipment.
- Connect the equipment into an outlet on a circuit different from that to which the other device(s) are connected.
- Consult the manufacturer or field service technician for help.

**Note**

Place the Weighing Platform on a level and stable surface. If the equipment is used when the Weighing Platform is unstable because not all feet are on the surface, there may be a risk of stumbling or inaccurate measurement.

**Note**

Note that portable and mobile RF communications equipment can affect MEDICAL ELECTRICAL EQUIPMENT.

**Note**

Consult a physician or a trained health professional for interpretation of measurement results.

**Note**

In case of patients who have certain diseases, the estimates might be different.

## Note

Incorrect operation or failure of user to maintain the unit spares the manufacturer or his agent of the responsibility for system's non-compliance with specifications or responsibility for any damage or injury.

This manual is made for informational purposes and this manual and product are not meant to be a substitute for the advice provided by your own physician or other medical expert. You should not use the information contained in the product for diagnosis or treatment of health problems or prescription of medication by yourself. If you have or suspect that you have a medical problem, consult with your physician promptly.







Defective units or accessories must be packed in the replacement cartons to be shipped off from you to our company.











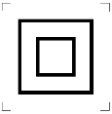

Shipping and insurance costs for return of defective unit must be prepaid by the users.



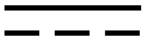

## 5. SAFETY SYMBOLS AND INFORMATION

The International Electrotechnical Commission (IEC) has established a set of symbols for medical electrical equipment which classifies a connection or warning of any potential hazard.

The classifications and symbols are shown below. Save these instructions for your safety.

|   |  |
|---|--|
|  | Degree of protection against electric shock: TYPE BF |
|  | Please observe operating instructions                |
|  | General warning sign                                 |
|  | General prohibition sign                             |
|  | General mandatory action sign                        |
|  | Caution  |

|   |   |
|---|---|
|    | <p>Waste Electrical and Electronic Equipment (WEEE)</p> <p>The device could be sent back to the manufacturer for recycling or proper disposal after their useful lives. Alternatively the device shall be disposed in accordance with national laws after their useful lives.</p> |
|    | <p>"ON / OFF" key : Turn the power ON / OFF</p>   |
|    | <p>Class II equipment</p>   |
|    | <p>This symbol is used inside system.</p> <p>Identifies the point where the safety ground of the system is fastened to the chassis.</p>   |
|   | <p>Do not open. This is for factory only.</p>   |
|  | <p>Alternating current</p>  |
|  | <p>Direct current</p>   |
|  | <p>Date of manufacture</p>  |
|  | <p>Manufacturer</p>   |
|  | <p>Non-ionizing radiation</p>   |
|  | <p>This product complies with the Council Directive 93/42/EC regarding medical devices, which bears the mark CE 0197 (TUV Rheinland GmbH). Units with CE marks are subject to quality system audits in accordance with this Directive.</p>  |
|  | <p>Serial No.</p>   |

|   |  |
|---|--|
|  | Authorized representative in the European community. |
|  | Keep dry   |
|  | For indoor use only                                  |
|  | RoHS2  |

## 6. Guidance for Electromagnetic compatibility (EMC)

Details about the electromagnetic compatibility (EMC) of the ACCUNIQ BC310 are given below. Before using the ACCUNIQ BC310, be sure to read and understand the following information.

### 1) Guidance and manufacturer's declaration – electromagnetic emissions

The ACCUNIQ BC310 is intended for use in the electromagnetic environment specified below. The customer or the user of the ACCUNIQ BC310 should assure that it is used in such an environment.

| Emissions test  | Compliance | Electromagnetic environment – guidance   |
|---|------------|--|
| RF emissions<br>CISPR 11                                    | Group 1    | The ACCUNIQ BC310 is suitable for use in all establishments, including domestic establishments and those directly connected to the public low-voltage power supply network that supplies buildings used for domestic purposes. |
| RF emissions<br>CISPR 11                                    | Class B    |  |
| Harmonic emissions<br>IEC 61000-3-2                         | Class A    |  |
| Voltage fluctuations/<br>flicker emissions<br>IEC 61000-3-3 | Compliance |  |

## 2) Guidance and manufacturer's declaration – electromagnetic immunity

The ACCUNIQ BC310 is intended for use in the electromagnetic environment specified below. The customer or the user of the ACCUNIQ BC310 should assure that it is used in such an environment.

| Immunity test   | IEC 60601 test level  | Compliance level   | Electromagnetic environment-guidance   |
|---|---|--|--|
| Electrostatic discharge(ESD)<br>IEC 61000-4-2                                   | ±6kV: Contact<br>±8kV: Air  | ±6kV: Contact<br>±8kV: Air   | Floors should be wood, concrete or ceramic tile. If floors are covered with synthetic material, the relative humidity should be at least 30 %.   |
| Electrical fast transition/burst<br>IEC 61000-4-4                               | ±2kV: Power supply lines<br>±1kV: Input/output lines  | ±2kV: Power supply lines<br>±1kV: Input/output lines   | Mains power quality should be that of a typical commercial or hospital environment.  |
| Surge<br>IEC 61000-4-5  | ±1 kV differential mode<br>±2 kV common mode  | ±1 kV differential mode<br>±2 kV common mode   | Mains power quality should be that of a typical commercial or hospital environment.  |
| Voltage drops, dips, and fluctuations of input power supply line IEC 61000-4-11 | <5 % <i>UT</i><br>(>95 % dip in <i>UT</i> )<br>for 0,5 cycle<br>40 % <i>UT</i><br>(60 % dip in <i>UT</i> )<br>for 5 cycles<br>70 % <i>UT</i><br>(30 % dip in <i>UT</i> )<br>for 25 cycles<br><5 % <i>UT</i><br>(>95 % dip in <i>UT</i> )<br>for 5 sec | <5 % <i>UT</i><br>(>95 % dip in <i>UT</i> )<br>for 0,5 cycle<br>40 % <i>UT</i><br>(60 % dip in <i>UT</i> )<br>for 5 cycles<br>70 % <i>UT</i><br>(30 % dip in <i>UT</i> )<br>for 25 cycles<br><5 % <i>UT</i><br>(>95 % dip in <i>UT</i> ) | Mains power quality should be that of a typical commercial or hospital environment. If the user of the ACCUNIQ BC310 requires continued operation during power mains interruptions, it is recommended that the ACCUNIQ BC310 be powered from an uninterruptible power supply or a battery. |

|  |       |           |   |
|--|-------|-----------|---|
|  |       | for 5 sec |   |
| Magnetic field of commercial frequency (50/60Hz) IEC 61000-4-8 | 3 A/m | 3 A/m     | Power frequency magnetic fields should be at levels characteristic of a typical location in a typical commercial or hospital environment. |

|   |  |
|---|--|
| <b>Note</b>   |  |
|  | <i>U<sub>T</sub></i> is the a.c. mains voltage prior to application of the test level. |

### 3) Guidance and manufacturer's declaration – electromagnetic immunity 2

The ACCUNIQ BC310 is intended for use in the electromagnetic environment specified below. The customer or the user of the ACCUNIQ BC310 should assure that it is used in such an environment.

| Immunity test                 | IEC 60601 test level        | Compliance level | Electromagnetic environment-guidance   |
|-------------------------------|-----------------------------|------------------|--|
| Conducted RF<br>IEC 61000-4-6 | 3 Vrms<br>150 kHz to 80 MHz | 3 Vrms           | Portable and mobile RF communications equipment should be used no closer to any part of the ACCUNIQ BC310, including cables, than the recommended separation distance calculated from the equation applicable to the frequency of the transmitter.<br><br><b>Recommended separation distance</b> |
| Radiated RF<br>IEC 61000-4-3  | 3 V/m<br>80 MHz to 2,5 GHz  | 3 V/m            | $d = 1.2\sqrt{P}$ $d = 1.2\sqrt{P} \quad 80 \text{ MHz to } 900 \text{ MHz}$ $d = 2.3\sqrt{P} \quad 900 \text{ MHz to } 2,5 \text{ GHz}$ <p>where <math>P</math> is the maximum output power rating of the transmitter in watts (W) according to the</p>   |



#### 4) Recommended separation distances between portable and mobile RF communications equipment and the ACCUNIQ BC310

The ACCUNIQ BC310 is intended for use in an electromagnetic environment in which radiated RF disturbances are controlled. The customer or the user of the ACCUNIQ BC310 can help prevent electromagnetic interference by maintaining a minimum distance between portable and mobile RF communications equipment (transmitters) and the ACCUNIQ BC310 as recommended below, according to the maximum output power of the communications equipment.

| Rated maximum output power of transmitter<br>W | Separation distance according to frequency of transmitter<br>m |  |   |
|--|--|--|---|
|  | 150 kHz to 80 MHz<br>$d = 1.2\sqrt{P}$                         | 80 MHz to 900 MHz<br>$d = 1.2\sqrt{P}$ | 900 MHz to 2,5 GHz<br>$d = 1.2\sqrt{P}$ |
| 0.01   | 0.12   | 0.12                                   | 0.23                                    |
| 0.1  | 0.38   | 0.38                                   | 0.73                                    |
| 1  | 1.2  | 1.2                                    | 2.3                                     |
| 10   | 3.8  | 3.8                                    | 7.3                                     |
| 100  | 12   | 12                                     | 23                                      |

For transmitters rated at a maximum output power not listed above, the recommended separation distance  $d$  in meters (m) can be estimated using the equation applicable to the frequency of the transmitter, where  $P$  is the maximum output power rating of the transmitter in watts (W) according to the transmitter manufacturer.

#### Note



1. At 80 MHz and 900 MHz, the separation distance for the higher frequency range applies.
2. These guidelines may not apply in all situations. Electromagnetic propagation is affected by absorption and reflection from structures, objects and people.



# ABOUT BODY COMPOSITION

## 1. Body Composition

Human body consists of body fat and lean body. Lean body means non-fat constituents of human body like body water, muscles, bones, etc.

Body water is divided into intra- and extra-cellular water and the ratio between them is controlled and maintained within a certain range. Body fat is piled beneath the skin and between abdominal organs. Body fat is hydrolyzed to make energy needed to normal physiological function when energy supply through food intake is not sufficient, but excessive fat in the body itself is a kind of disease and causes lifestyle diseases.

Healthy people maintain the balance of body composition in a steady proportion but unhealthy people persons fail to keep this balance. When the balance in body composition is broken, diseases like obesity, malnutrition, osteoporosis, etc. can be caused.

## 2. Obesity

Various methods can be used to assess obesity but the key factor in obesity assessment is the amount of fat accumulated in the body.

In general, obesity is defined as the state of not only excessive weight compared with height (visible obese) but also excessive body fat compared with weight (invisible or visible obese). Strictly speaking obesity is the state that body fat occupies considerably high ratio to weight.

## 3. Necessity of Body Composition Analysis

Body Composition Analysis is a good indicator to find possible health problems. Body composition analysis enables professionals to find obesity or imbalance in body composition at early stage and helps subjects keep their body healthy. Body composition analyzer is a useful preventive diagnostic device.

## 4. Waist to hip ratio

Waist to hip ratio (W.H.R.) shows the distribution of fat stored in one's abdomen and hip. It is simple but useful to assess body fat distribution. Body fat is stored in two distinct ways. They are often called 'apple' and 'pear' type. Apple type shows bigger girth of waist than hip and pear type has bigger girth of hip than waist. If body fat in abdomen increases more, the risk to cardiovascular diseases, diabetes, etc. becomes higher.

## 5. Abdominal Fatness

Body fat is divided into subcutaneous fat and visceral fat. Visceral obesity is considered to be a critical risk factor along with Percent of body fat.

Lipoprotein lipase can be easily activated in visceral fat, and it cause visceral fat to be dissolved easily. Dissolved visceral fat goes into liver through the vessel and it cause fatty liver or increasing lipid in the blood. It also elevates the risk of hyperinsulinemia, hypertension, and cardiovascular disease.

Visceral fat generally occupies 10 ~ 20 % of body fat and visceral obesity is assessed based on the indicators below.

- the cross sectional fat area between L4 ~ L5 is 100 cm<sup>2</sup> and over
- the visceral fat to subcutaneous fat ratio is 0.4 and over
- the waist to hip ratio (W.H.R.) is over 0.9 (male) / 0.85 (female)
- the circumference of waist is over 102 cm (male) / 88 cm (female)

Visceral fat increases after their 30s in men and after Menopause in women. It is more common in men than women and the old than the young. Visceral fat tends to increase with aging. Because the combustion rate per minute of visceral fat is higher than that of subcutaneous fat, visceral fat can be easily reduced by exercise or dietary control in case of abdominal obesity. W.H.R. is the ratio of waist to hip circumference and has relation to one's figure.

## 6. Segmental Analysis

This device analyzes lean body mass of five body parts; trunk, right arm, left arm, right leg, and left leg. This function can be used as an assessment tool to evaluate the result of exercise or rehabilitation treatment.

# TERM AND FUNCTION OF EACH PART

## 1. Main Body

### 1) Front Part

- ① ACCUNIQ BC310 (For whole body / upper body)

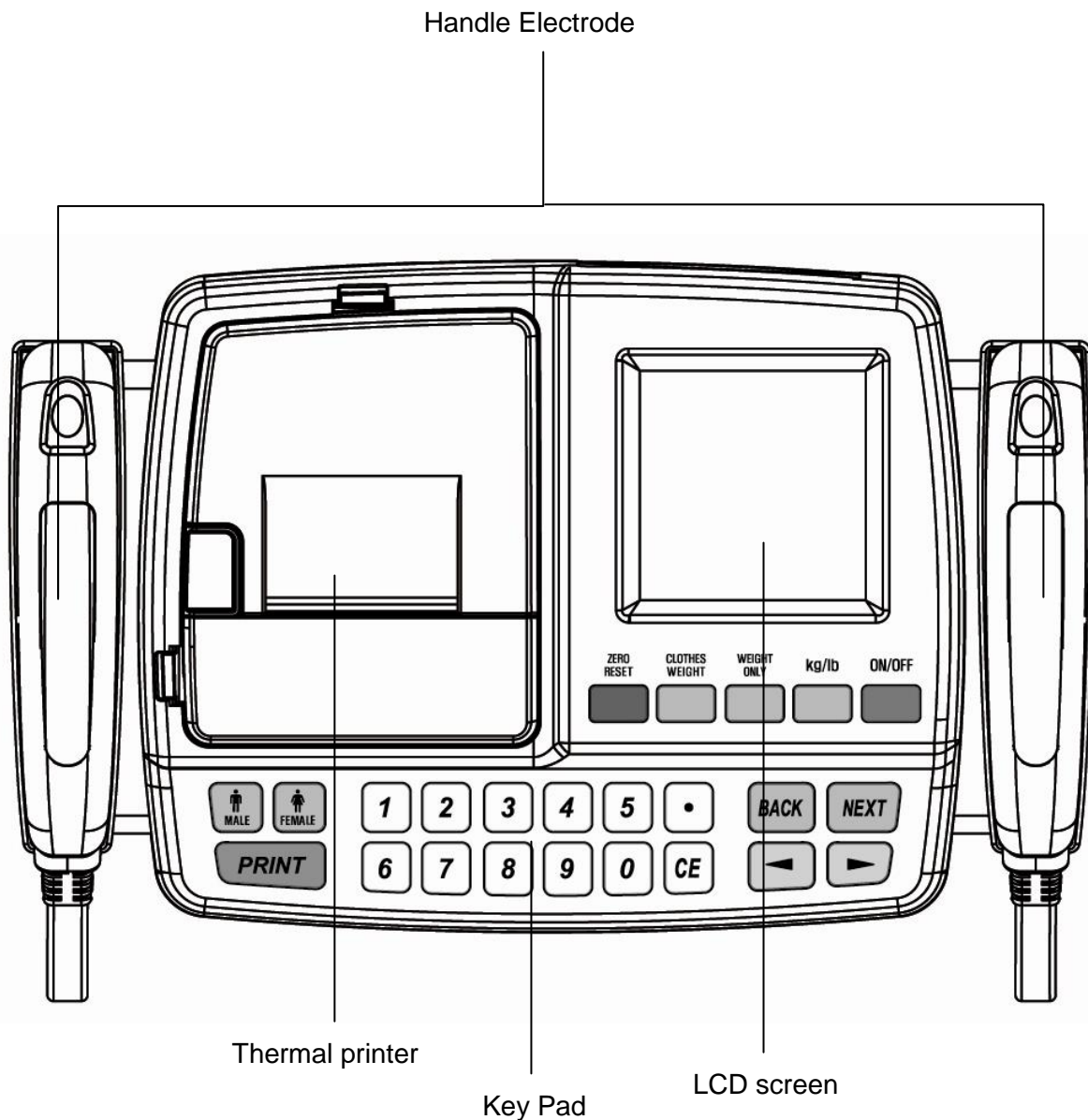

Handle Electrode measure the impedance by sending harmless electric current to the body. Hold them with the hands during measurement.

- LCD screen

It displays the procedure and results.

- Handle Electrode

Handle Electrode measure the impedance by sending harmless electric current to the body.

Hold them with the hands during measurement.

- Key pad

The keypad consists of the function keys ;'ZERO RESET', 'CLOTH WEIGHT',' WEIGHT ONLY', 'kg/lb', 'ON/OFF', 0 to 9, Alphabet, 'MALE', 'FEMALE', 'Print', '•', 'CE', '◀', '▶', 'BACK' , 'NEXT' and the numeric button.

- Thermal Printer

In-built printer allows the speedy and convenient printing.

② ACCUNIQ BC310 (For lower body)

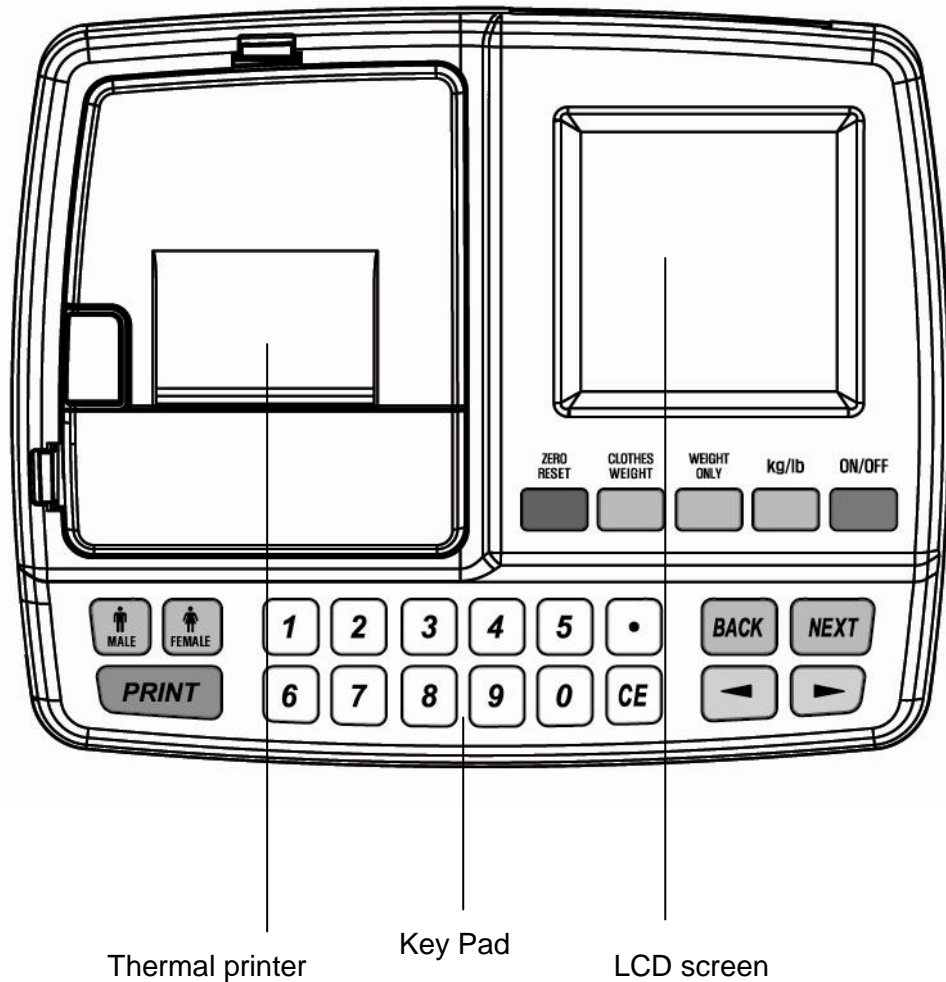

- LCD screen  
It displays the procedure and results.
- Key pad  
The keypad consists of the function keys ;'ZERO RESET', 'CLOTH WEIGHT',' WEIGHT ONLY', 'kg/lb', 'ON/OFF', 0 to 9, Alphabet, 'MALE', 'FEMALE', 'Print', '.', 'CE', '◀', '▶', 'BACK', 'NEXT' and the numeric button.
- Thermal Printer  
In-built printer allows the speedy and convenient printing.

## 2) Rear Part

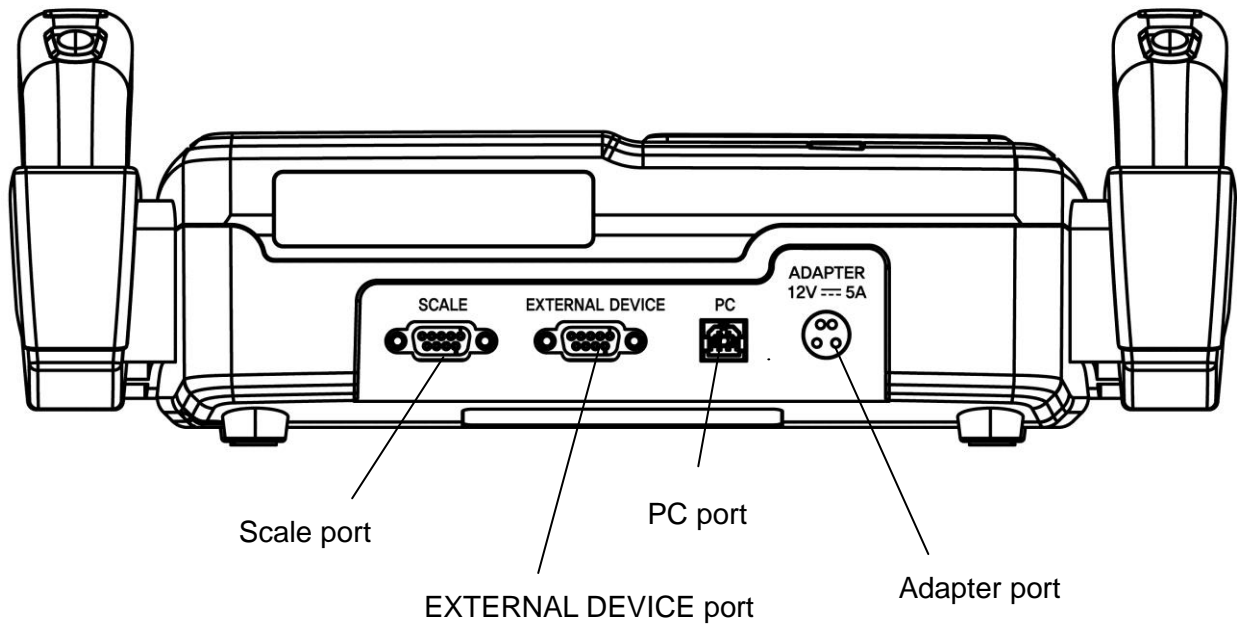

- SCALE port: Connecting the scale.
- EXTERNAL DEVICE port: Connecting External device manufactured by SELVAS Healthcare, Inc.
- PC port: Connecting a computer.
- ADAPTER port: Connecting the adapter.

### Note



Rear port is same for all three machines;  
whole body / upper body / lower body

### 3) Base Part

① ACCUNIQ BC310 (For whole body / lower body)

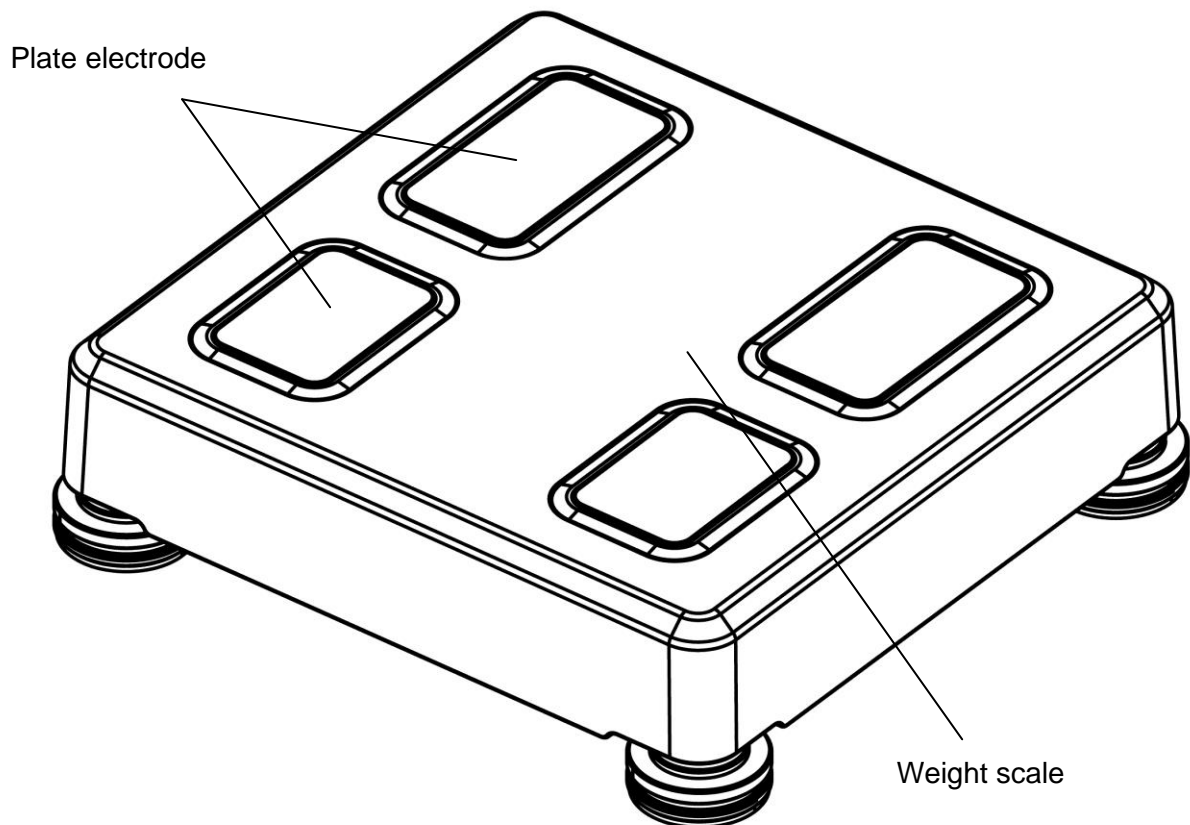

- Weight scale: It consists of four plate electrodes and it measures weight.
- Plate electrode: It measures the impedance. The user should step it in bare feet.

② ACCUNIQ BC310 (For upper body)

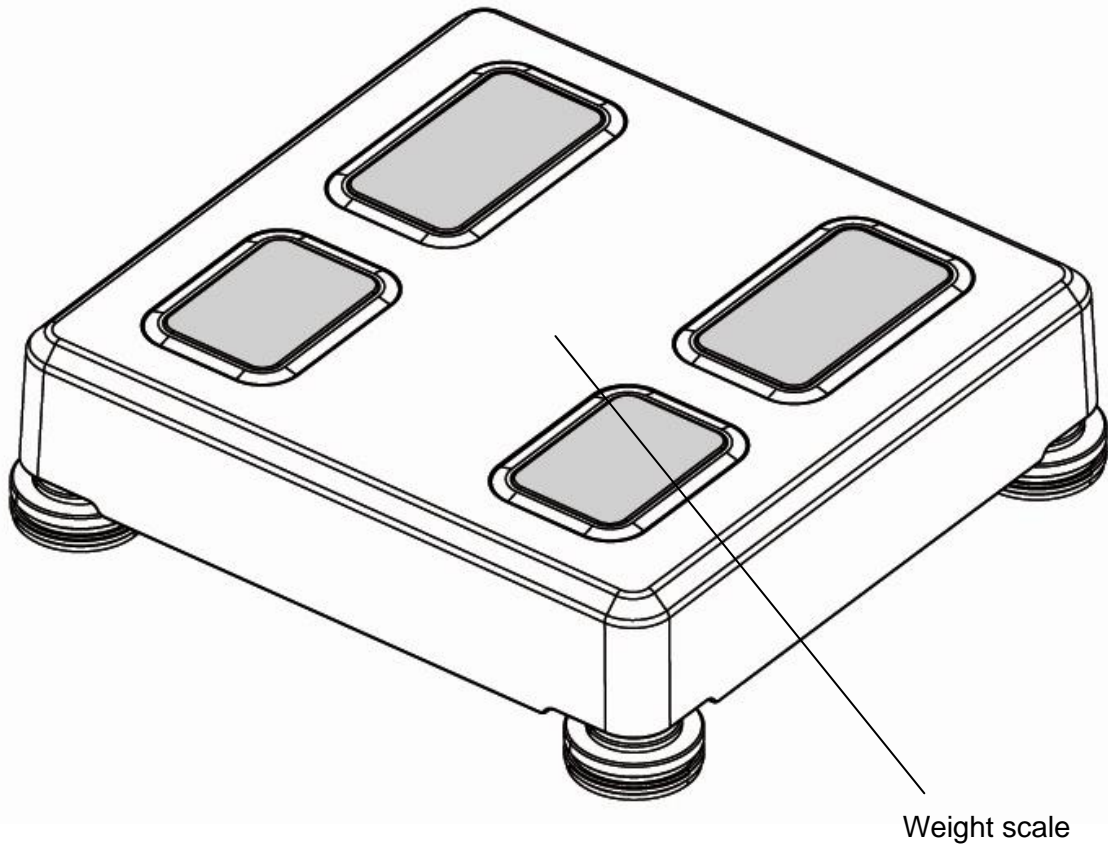

- Weight scale: It consists of four plate electrodes and it measures weight.



#### 4) Handle electrode

It measures the impedance of body by flowing harmless electric current.

Hold them with hands during measurement.

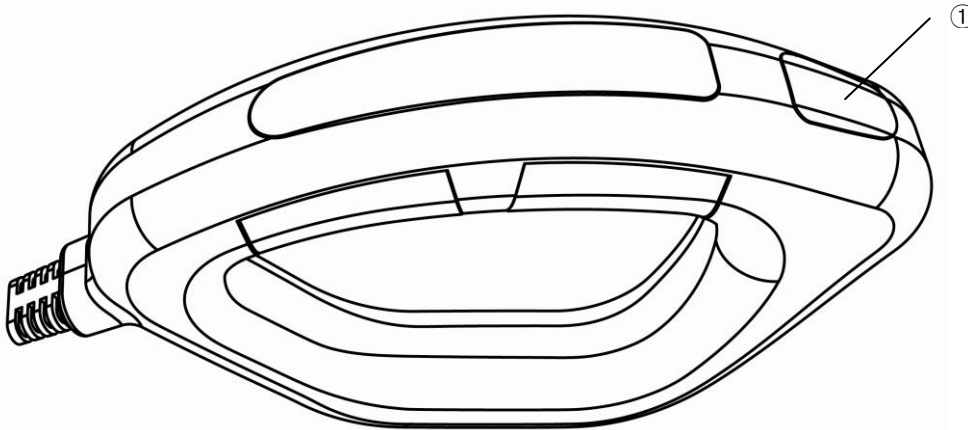

① Start button: Start button after input of personal data

#### 5) Key Pad -1

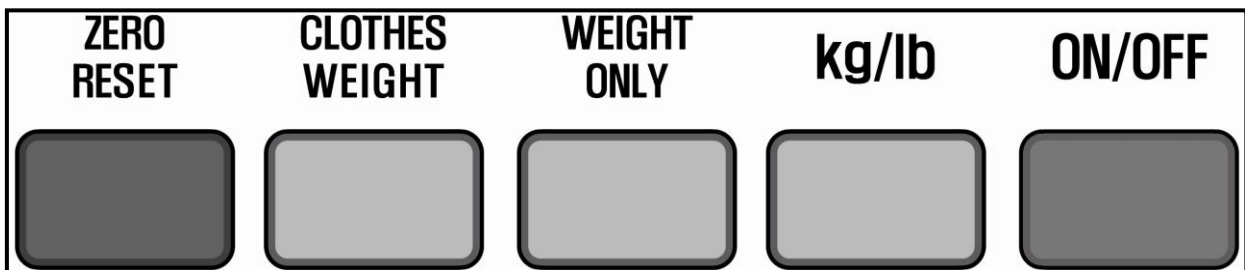

- ZERO RESET: It adjusts the scale to '0' point.
- CLOTHES WEIGHT: The user can input the weight of the clothes. (0~ -9.9kg)
- WEIGHT ONLY: It allows the device to operate in scale mode.

Press the button for 2sec.It will be displayed BCA or SCALE on the screen.

- kg/lb: The capacity graduation of weight is either in kg or lb.
- ON/OFF: It can be used to turn on/off the power.

## 6) Key Pad-2

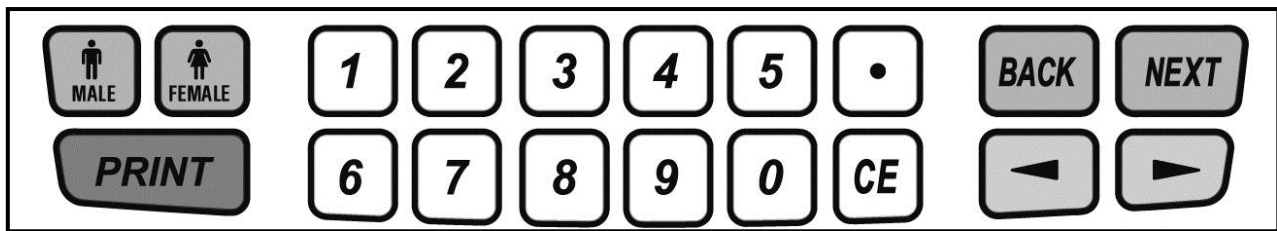





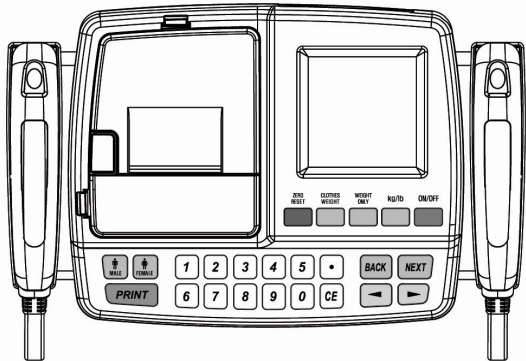
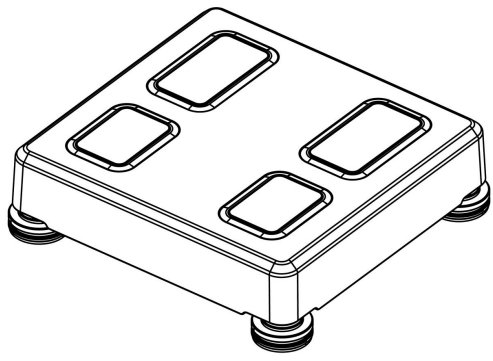

- MALE/FEMALE: Select gender.
- PRINT: It prints the result.
- Numeric Keys & CE button: Numeric Keys are used for entering personal data (Height, Age).  
The input data can be deleted by CE button.
- BACK/NEXT: It moves forward/backward to the next/previous step during the System setting or during the measurement.
- ◀/▶: It can be used to move forward/ backward to the next step during the System setting.

## 2. Basic Package

### 1) ACCUNIQ BC310 (For whole body )

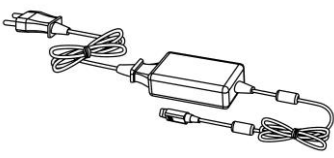
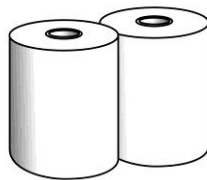
|                      |                           |
|----------------------|---------------------------|
| ① Head Part          | ② Weight scale(Base part) |
| ③ User manual        | ④ Body Pass Plus (CD)     |
| ⑤ USB / Serial cable | ⑥ Power cable and adapter |
| ⑦ Thermal printer    | ⑧ Roller                  |
| ⑨ Column             |                           |

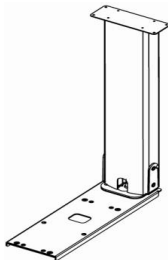
|   |   |   |  |
|---|---|---|--|
|   |   |    |  |
| ① Head Part   |   | ② Weight scale(Base part)   |  |
|  |  |  |  |
| ③ User manual   | ④ Body Pass Plus  | ⑤ USB / Serial cable  |  |
|  |  |  |  |
| ⑥ Power cable and adapter   | ⑦ Thermal printer   | ⑧ Roller  |  |
|  |   |   |  |
| ⑨ Column  |   |   |  |

※ The model or specification are subject to change according to the market demand.

**2) ACCUNIQ BC310 (For upper body)**

|                      |                           |
|----------------------|---------------------------|
| ① Head Part          | ② Weight scale(Base part) |
| ③ User manual        | ④ Body Pass Plus (CD)     |
| ⑤ USB / Serial cable | ⑥ Power cable and adapter |
| ⑦ Thermal printer    | ⑧ Roller                  |

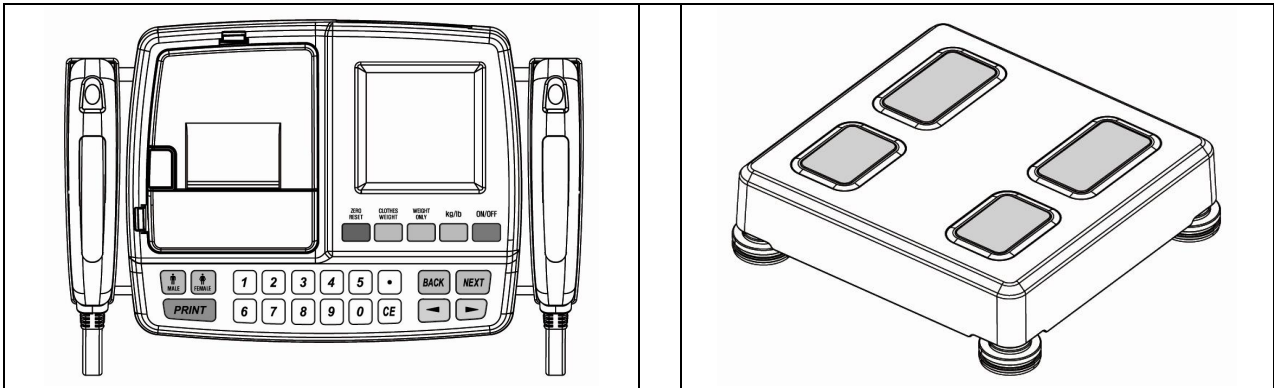

|             |                           |
|-------------|---------------------------|
| ① Head Part | ② Weight scale(Base part) |
|-------------|---------------------------|



|               |                  |                      |
|---------------|------------------|----------------------|
| ③ User manual | ④ Body Pass Plus | ⑤ USB / Serial cable |
|---------------|------------------|----------------------|

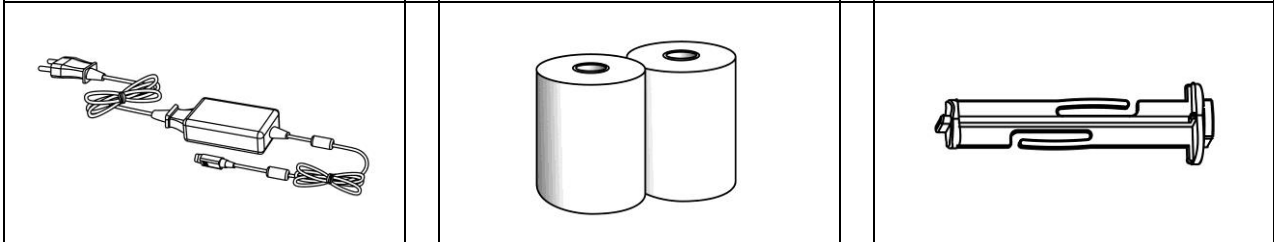





|                           |                   |          |
|---------------------------|-------------------|----------|
| ⑥ Power cable and adapter | ⑦ Thermal printer | ⑧ Roller |
|---------------------------|-------------------|----------|

※ The model or specification are subject to change according to the market demand.

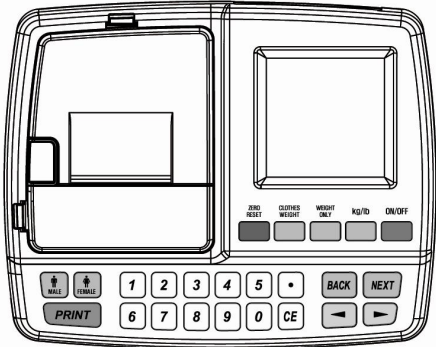
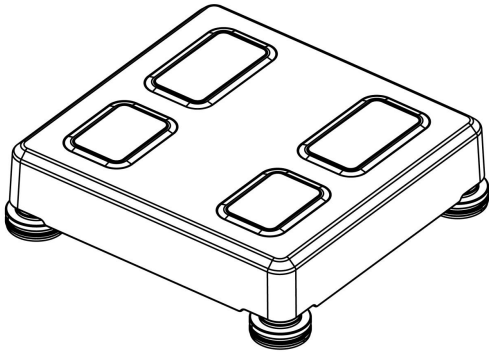
### 3) ACCUNIQ BC310 (For lower body)

|                      |                           |
|----------------------|---------------------------|
| ① Head Part          | ② Weight scale(Base part) |
| ③ User manual        | ④ Body Pass Plus (CD)     |
| ⑤ USB / Serial cable | ⑥ Power cable and adapter |
| ⑦ Thermal printer    | ⑧ Roller                  |

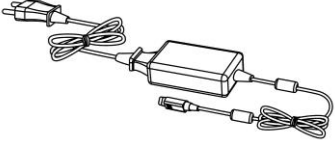
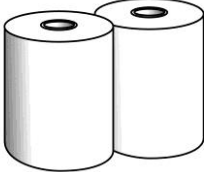
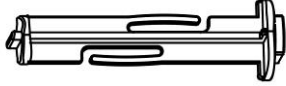
|   |   |   |  |
|---|---|---|--|
|    |   |     |  |
| ① Head Part   |   | ② Weight scale(Base part)   |  |
|  |  |  |  |
| ③ User manual   | ④ Body Pass Plus  | ⑤ USB / Serial cable  |  |
|  |  |  |  |
| ⑥ Power cable and adapter   | ⑦ Thermal printer   | ⑧ Roller  |  |

※ The model or specification are subject to change according to the market demand.

### 3. Options

1) Professional health counseling software, Easy Body Plus (CD)

This program helps managing body composition easily and systematically. It shows the core items needed to control body composition. The items include measured body composition, dietary control plan, exercise plan, etc. If the device is connected to blood pressure monitor, it also indicates the measurer's blood pressure.



2) Automatic Blood Pressure Monitor

If SELVAS's automatic blood pressure monitor for hospital is connected to this device, the measurer can easily check his/her blood pressure. Especially the patient with the hypertension can manage his/her blood pressure efficiently through body weight control.

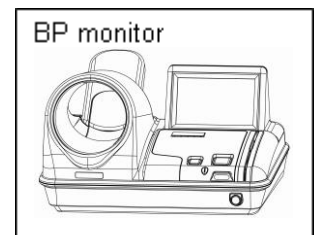

3) Cart for Blood Pressure Monitor

Cart is provided to place a blood pressure monitor. Assembly manual is supplied with this cart.



4) A4 Result Sheet

The results are indicated systematically and anyone can easily understand the results.

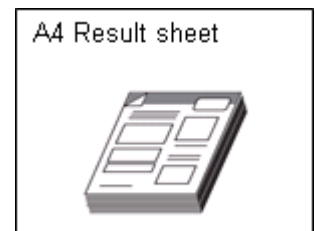

5) Column

It attaches to the head part with base part.

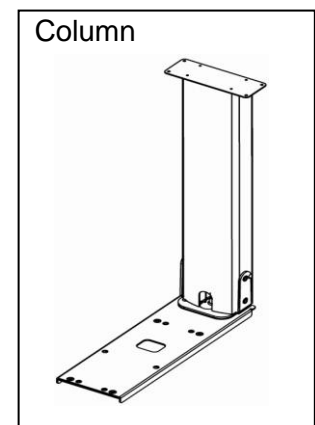

6) Wireless Communication

The result can be transmitted to PC through wireless communication.

# INSTALLATION

## 1. Basic Installation of product

### 1) Connecting the power supply and the scale cable

Connect the adapter to the adapter port placed on the rear panel of this device. After the cables are connected to each port, turn on the power switch on the keypad.

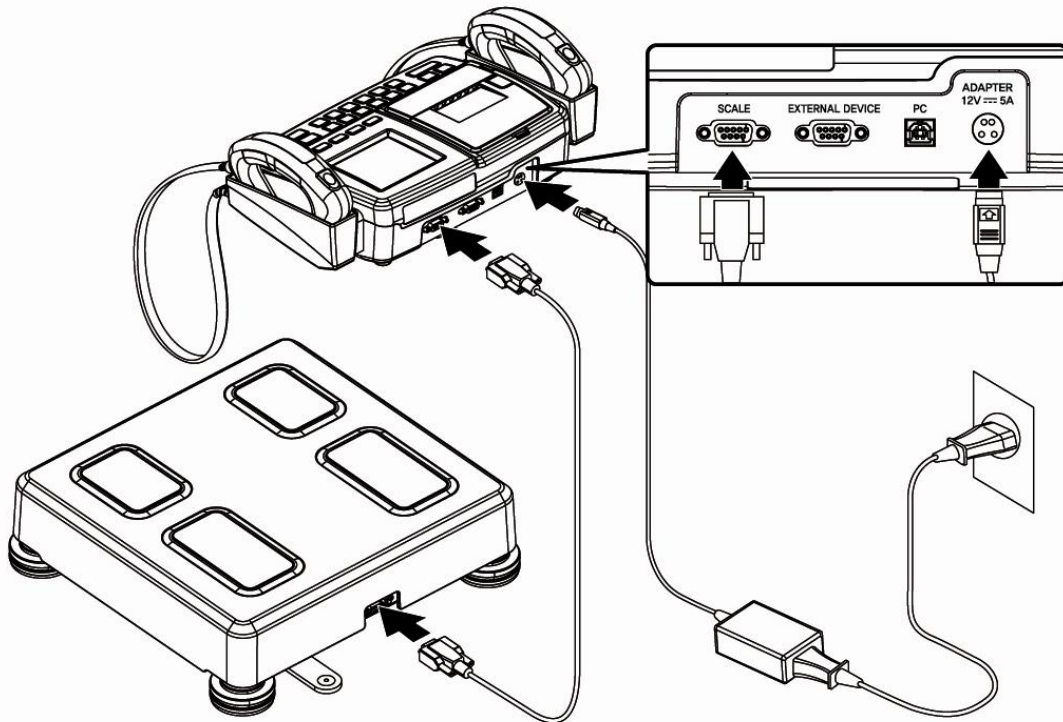

### 2) Leveling

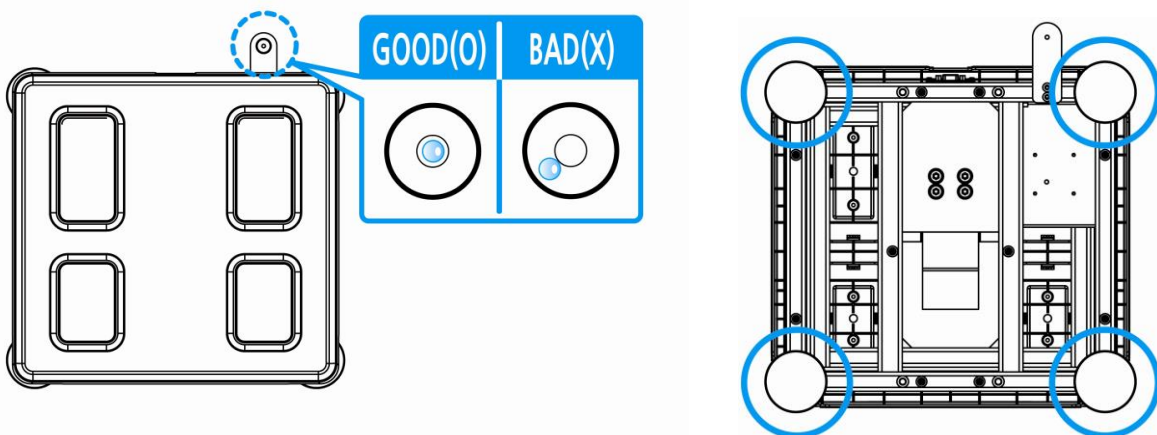

- ① Make sure that the scale is placed on a flat and level surface.
- ② Ensure a level by turning a wheel.

## 2. Peripheral Device Installation

### 1) Connecting PC

Connect the device to PC with USB cable.

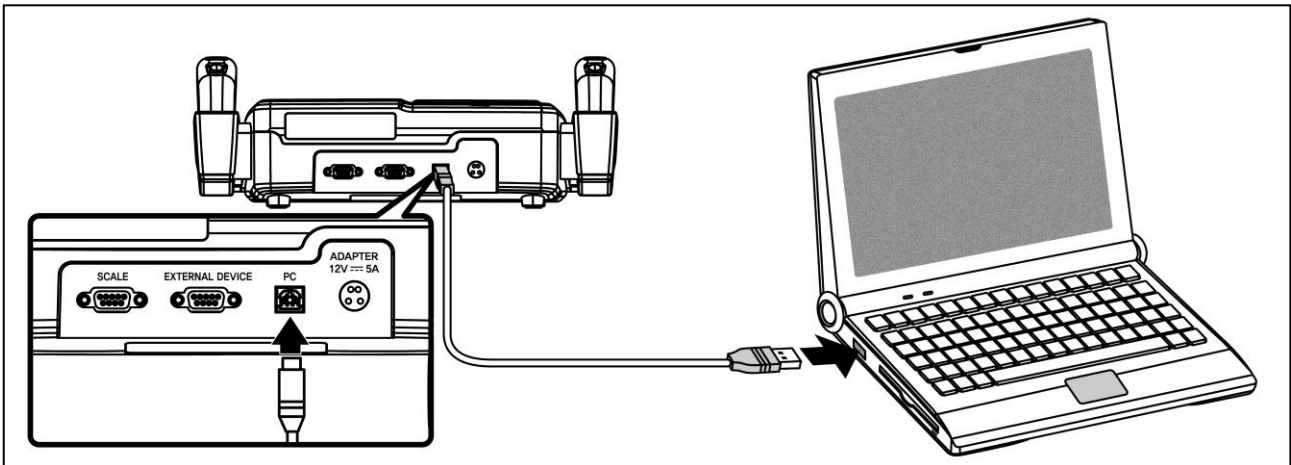

### Note



1. In order to save, search, and retrieve subject's data, the device should be connected to PC in which Body Pass Plus is installed. The result sheet can be printed from the printer connected to the PC
2. Professional consulting software, Easy Body Plus (option) easily assesses and explains body composition analysis. This program helps managing body composition easily and systematically. It can help the measurer to analyze his/her body composition at a glance.
3. For the installation of Body Pass Plus and Easy Body Plus, refer to its User's manual.



## 2) Connecting Printer (Option)

- ① Connect the device, PC, and the printer.

Connect the device to PC with USB cable. The USB port is placed on the rear panel of the device.

Connect the printer to the PC with printer cable. The result sheet can be printed out from the printer.

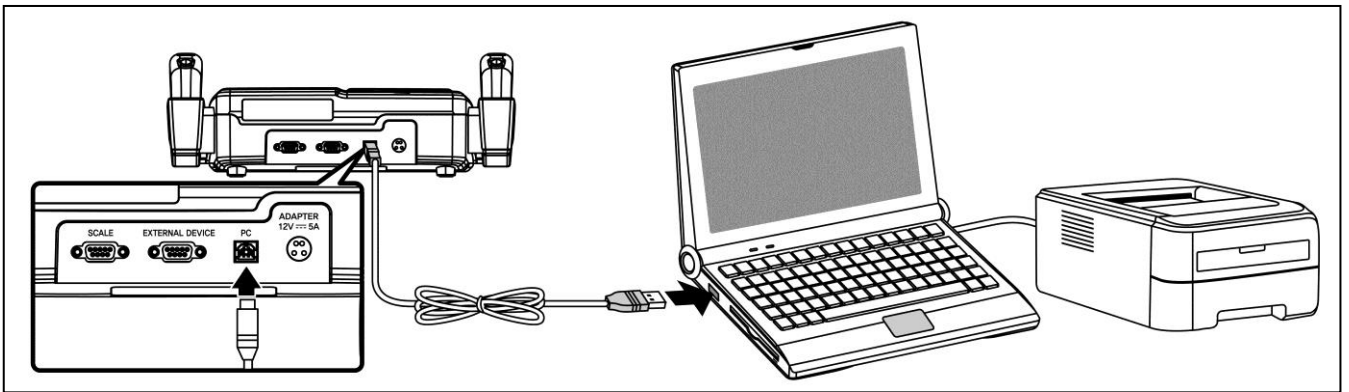

## 3) Connecting EXTERNAL DEVICE:

EXTERNAL DEVICE can be connected to the device. (Option) Connect a blood pressure monitor to "EXTERNAL DEVICE" port placed on the rear panel of the device with blood pressure monitor cable.

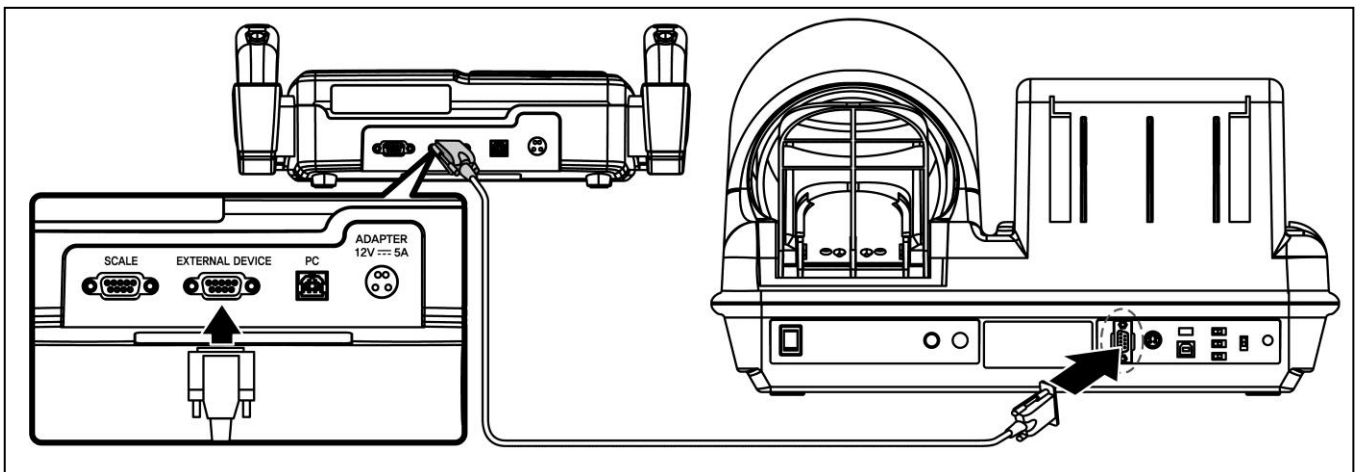

#### 4) Replacing Thermal Paper

Replace thermal paper while the power is on.

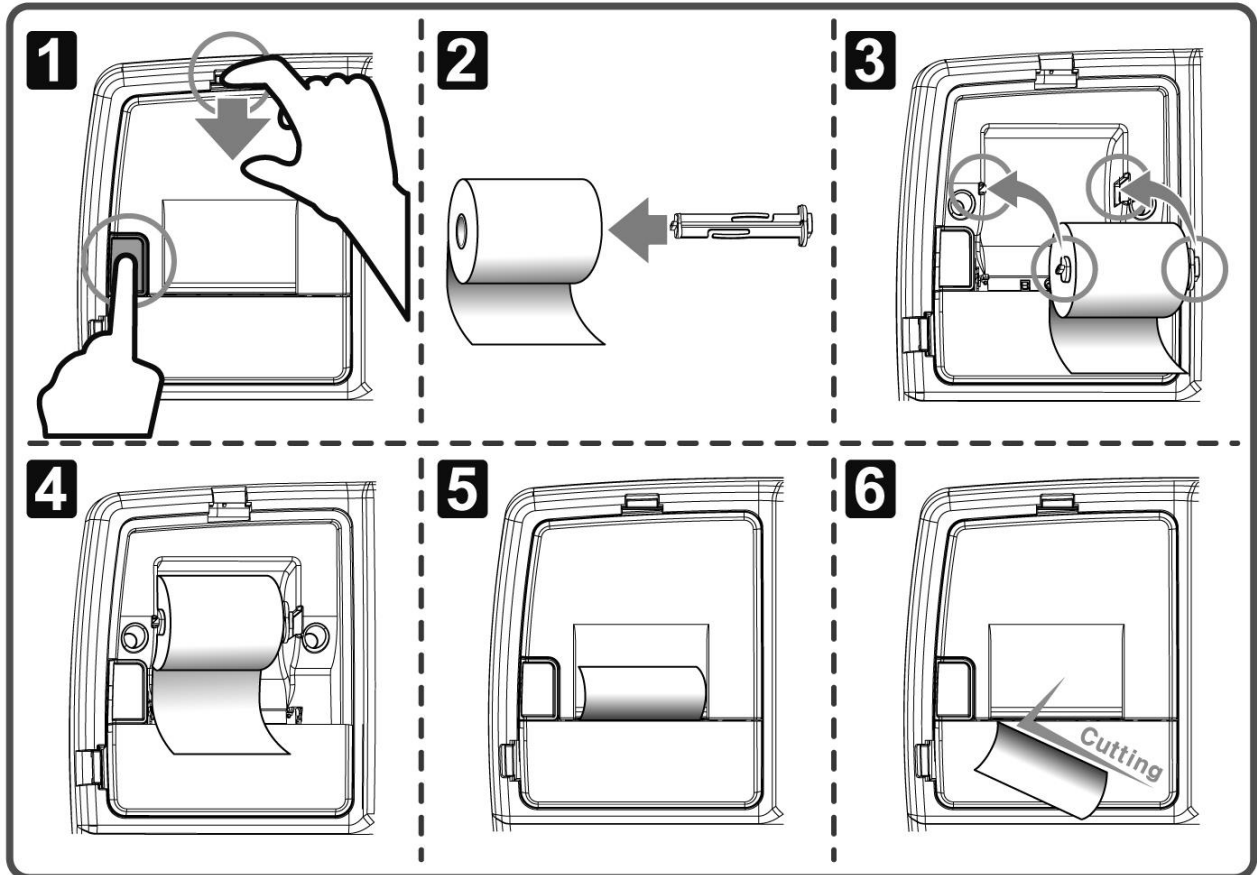

- ① Pull the Top button up. Then press the Side button. Open the upper printer cover.
- ② Put the roller into the center hole of the thermal paper.
- ③ Insert the thermal paper with the roller into the holder as shown in the picture.
- ④ Take the edge of the paper out.
- ⑤ Close the cover.
- ⑥ It automatically cuts the paper.

5) The trouble shooting when the thermal paper is jammed.

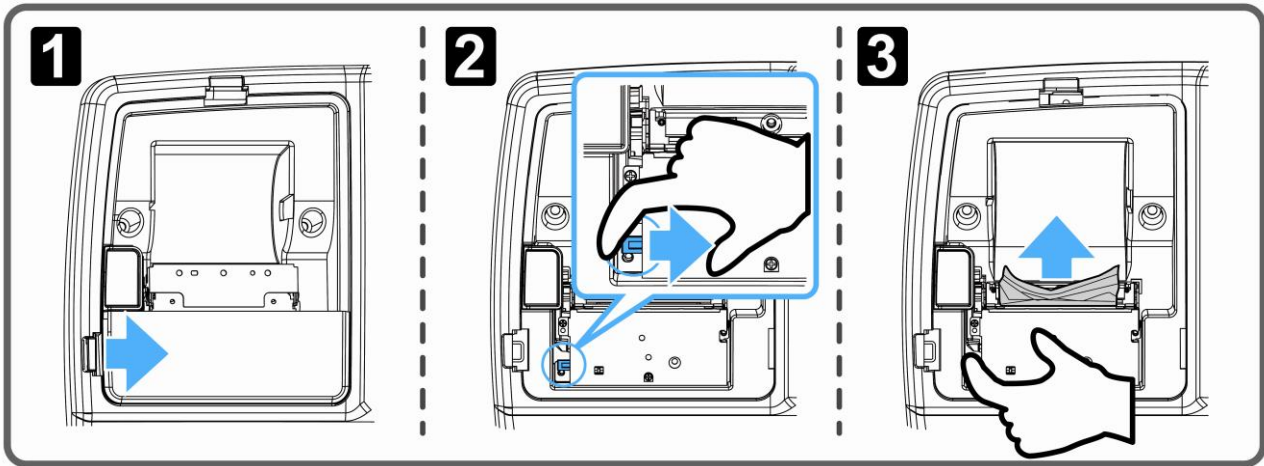

- ① Pull the lower printer cover up as shown in the picture.
- ② Press the Jam button located inside the printer.
- ③ Remove the jammed paper.

### 3. Installation of Column (Option)

1) The components for installing the body

#### Note



Please arrange (+)/(-) screw drivers. The screw drivers are not included in the package.

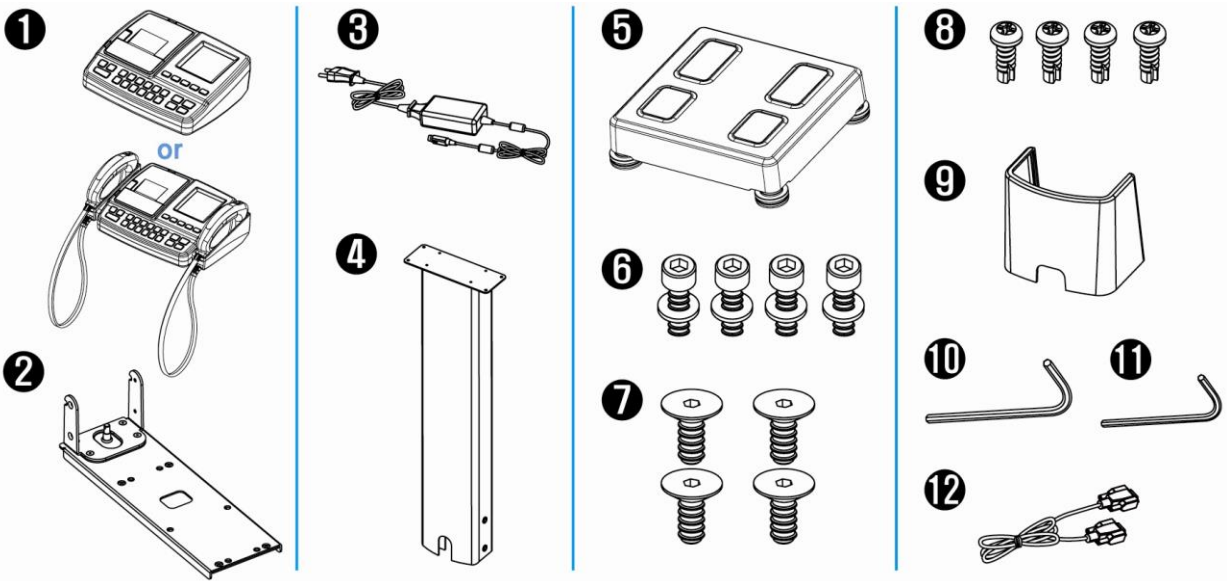

① HEAD(Main body): 1ea

② BRACKET :1ea

③ ADAPTER and POWER CABLE: 1ea

④ Column: 1ea

⑤ Weight scale : 1ea

⑥ M6 wrench bolt: 4ea

⑦ M6 FH bolt for wrench : 4ea

⑧ M4 bolt : 4ea

⑨ Body cover : 1ea

⑩ 5mm six angles L type wrench : 1ea

⑪ 4mm six angles L type wrench : 1ea

⑫ Weight scale's cable : 1ea

#### Caution



For the installation, work in the team of minimum two people to ensure the security.

#### Note



The Column is an optional part.

## 2) Connecting weight scale cable

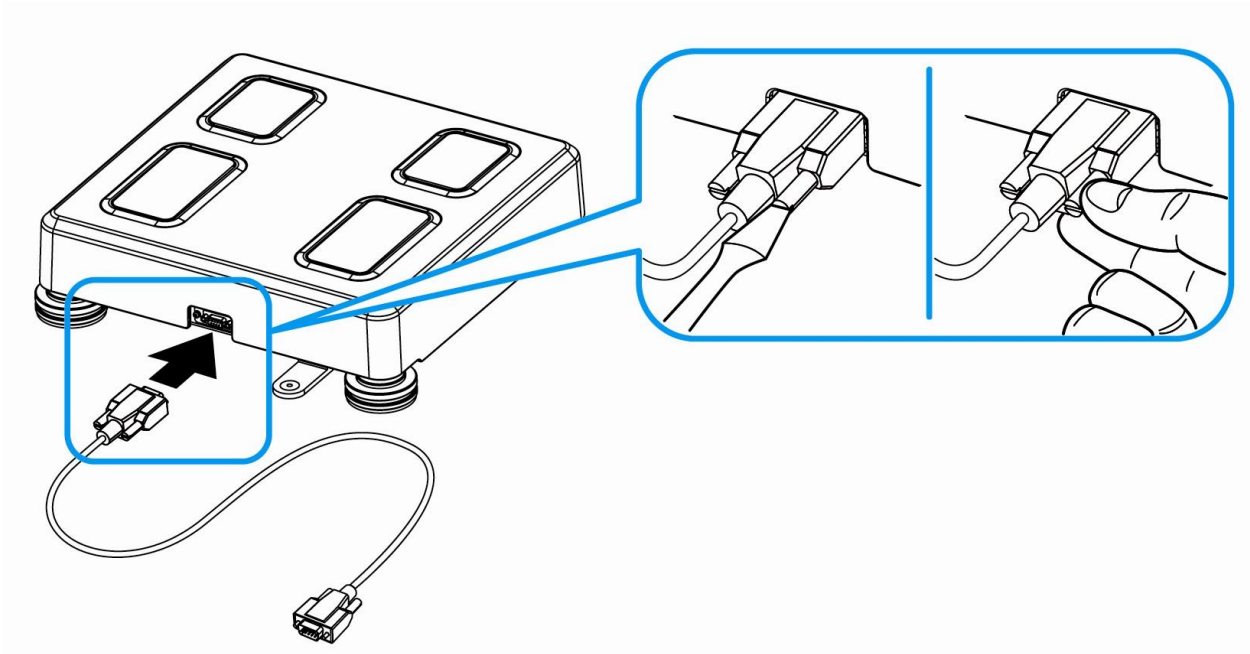

- ① Connect the weight scale with cable as shown in the picture.  
Fasten the two bolts by hands or (-)screw driver.

### Note



Connect the opposite side of the cable to the port located at the back of Head.

### 3) Assembling the bracket.

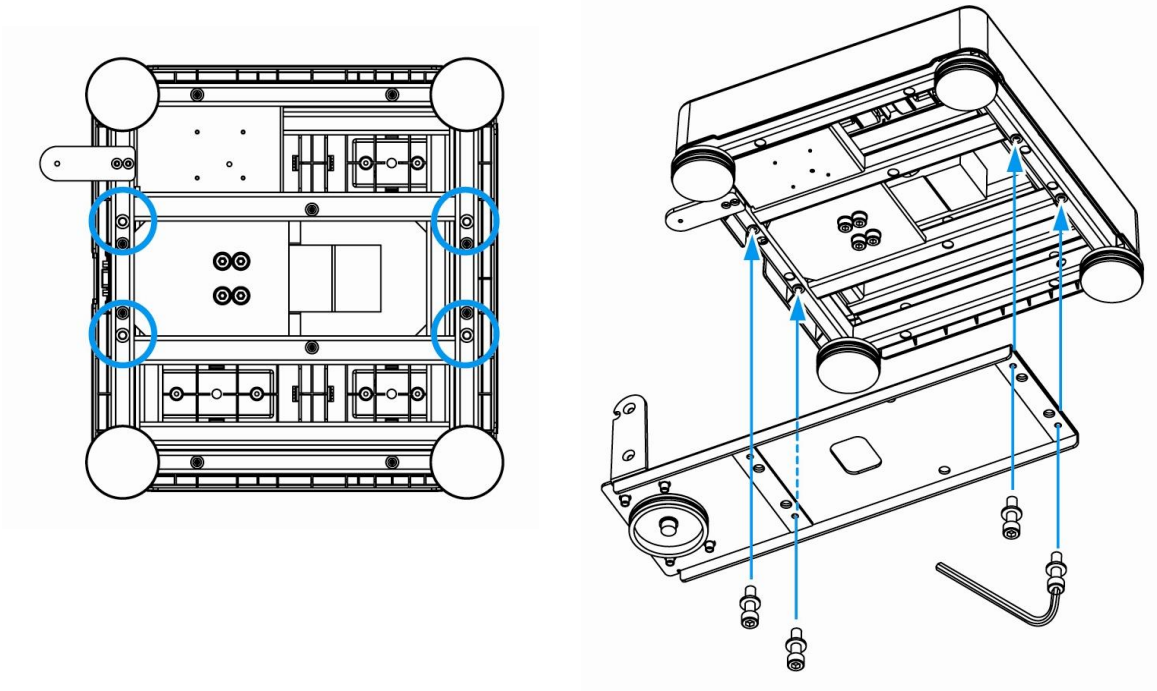

- ① Please check the bolt holes located at the bottom of the weight scale.
- ② Using a 5mm six angles L type wrench, fix the body bracket with 4 pcs of M6 wrench bolts.

### 4) Body assembly –Step 1.

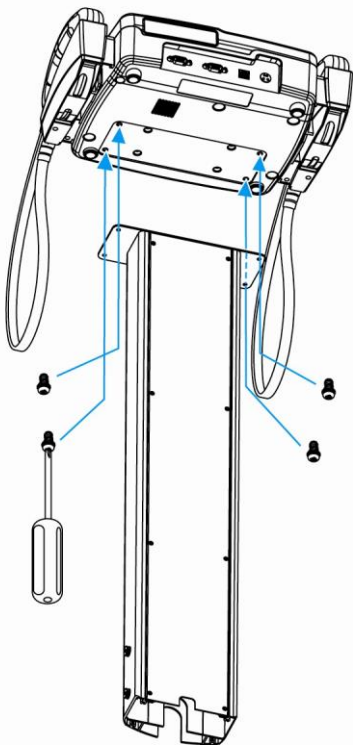

- ① Using (+)screw driver, fix the head with 4 pcs of M4 bolts.

5) Body assembly –Step 2.

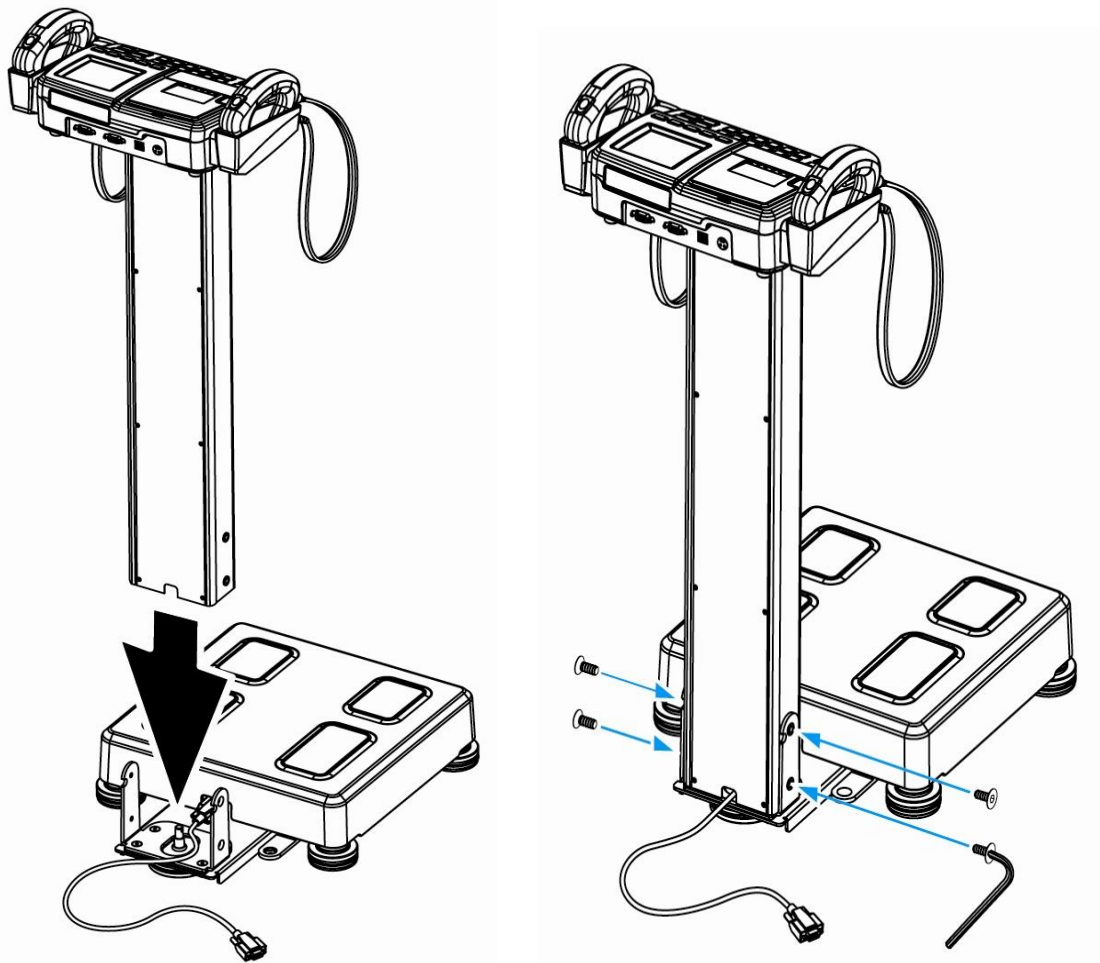

- ① Place the scale on a flat and level surface.
- ② Insert the column into the bracket. Make sure that the cable is out of the column as shown in the picture.
- ③ Insert M6 plate bolts into the holes of the column as shown in the picture.  
Fasten the bolts by 4mm six angles L type wrench.

## 6) Body cover assembly

Insert the Body cover as shown in the picture.

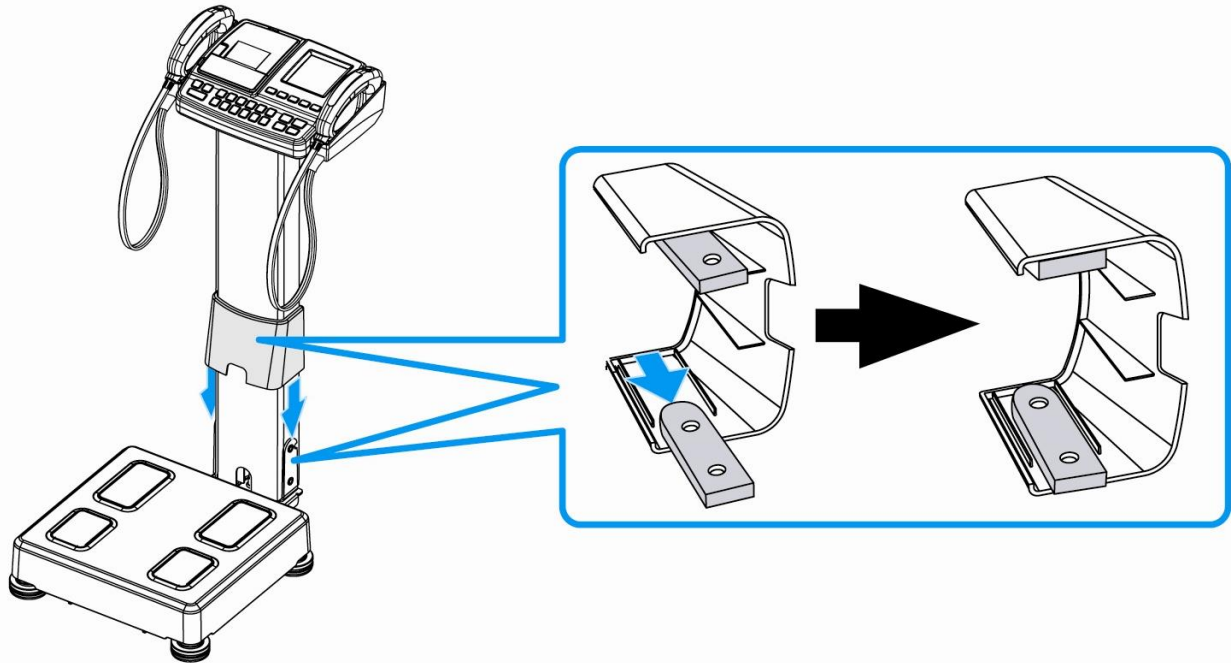

## 7) Leveling

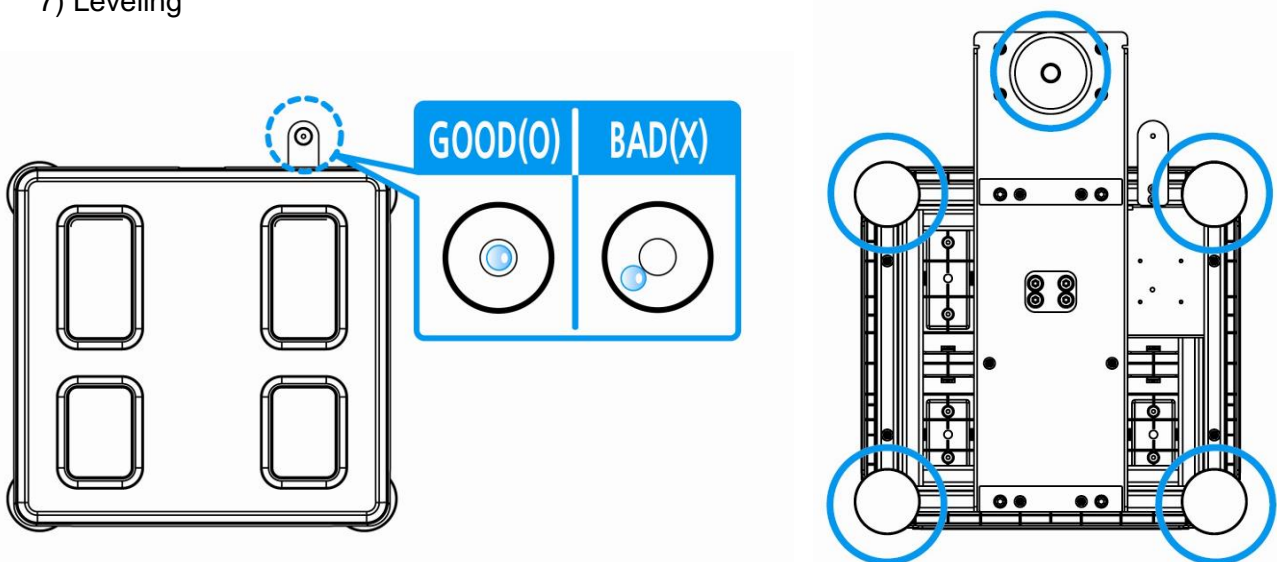

- ① Make sure that the scale is placed on a flat and level surface.
- ② Ensure a level by turning a wheel.



## 8) Connecting the power supply and the scale cable

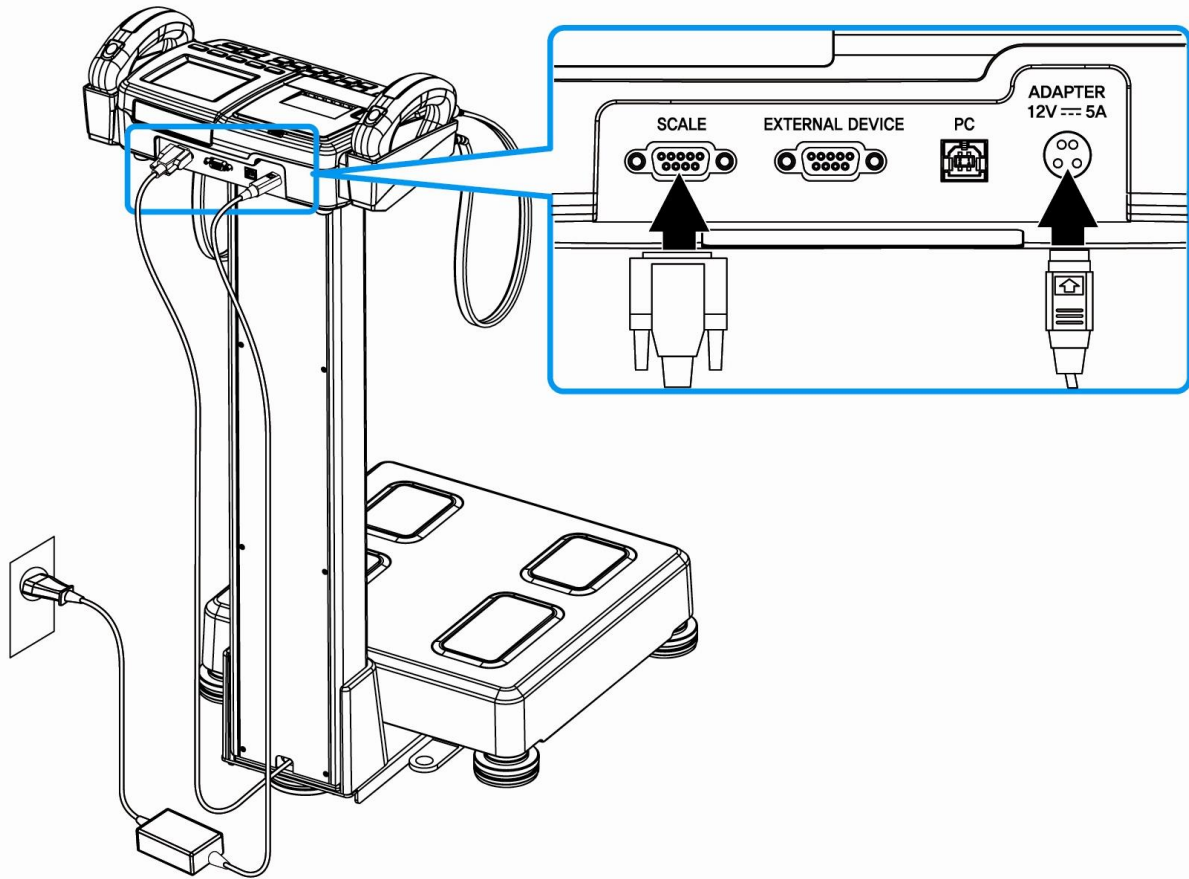

- ① Connect the scale cable to the scale port placed on back of head.  
Fasten the cable bolts.
- ② Connect the adapter cable to the adapter port.  
Plug the power cord into a power outlet.

### Caution



1. Before connecting a peripheral device to this device, the power should be turned off.  
Otherwise this device can malfunction or be damaged due to electric shock.
2. Power should be supplied from this device to ensure safe operation and durable performance.
3. This device should be powered with only the adapter and cable supplied by our company.
4. Be careful not to touch the base part of the device when the power switch is turned ON. Error occurs to the zero point of the scale.

# SYSTEM SETUP

SYSTEM SETUP allows the users to change the setting of operational parameters.

## Note



The contents in SYSTEM SETUP of this device can be changed for improvement.

### 1. Entering SYSTEM SETUP

At initial display, press '◀ → 1 → 2 → 3 → 4 → ▶' button in key pad to enter 'SYSTEM SETUP' screen.

### 2. Menu in SYSTEM SETUP

The function of each menu item is as follows.

- |               |                        |
|---------------|------------------------|
| 1. DATE /TIME | 7. GOAL SETTER         |
| 2. VOLUME     | (ACCUNIQ BC310 F ONLY) |
| 3. CONTRAST   | 8. KEY SOUND           |
| 4. BACKLIGHT  | 9. THERMAL PRINTER     |
| 5. ABDOMINAL  | 10. THERMAL LOGO       |
| 6. DATE TYPE  |                        |



### 3. Selecting a Menu in SYSTEM SETUP

Select the menu by pressing '◀' and '▶' button and press NEXT button in key pad.

(BACK button act as 'CLOSE' button in SYSTEM SETUP and NEXT button act as 'SET' button.)

---

#### **4. Moving to SYSTEM SETUP**

Press BACK button on selected item. SYSTEM SETUP screen appears.

#### **5. Exiting SYSTEM SETUP**

Press BACK button on SYSTEM SETUP screen. The initial screen appears.

## 6. Setup

### < DATE / TIME >

This is to set date and time (year, month, day, hour, and minute).

- Select DATE / TIME on SYSTEM SETUP screen by pressing '◀' and '▶' button. Once it is selected, press NEXT button in key pad.
- Pre-set: The date of the device released from the manufacturer's factory.
- Set the number with '◀' and '▶' button in key pad.
- Choose MONTH by pressing NEXT in key pad. Set correct date and time in the same way;
- Press NEXT button in key pad to save date and time.
- Return to SYSTEM SETUP screen by pressing BACK button in key pad.

|               |
|---------------|
| •DATE / TIME• |
| YEAR   _____  |
| MONTH   _____ |
| DAY   _____   |
| HOUR   _____  |
| MIN   _____   |

### Note



1. If NEXT button is pressed before finishing setup of date and time, the date and time inputted at that time is saved and SYSTEM SETUP screen appears. To cancel any changes attempted, press BACK button. The device returns to the previous setting and SYSTEM SETUP screen appears.
2. When Body Pass Plus or Easy Body Plus is used in data management, measured date is automatically saved as the date set in this device. Therefore the date and time set in the device should be checked before use.

### < VOLUME >

It adjusts the volume of voice guidance.

- Select VOLUME on SYSTEM SETUP screen by pressing '◀' and '▶' button, and press NEXT button in key pad.
- Pre-set: 3
- Range: 0 ~ 9
- Adjust the volume with '◀' and '▶' button in key pad.
- Press NEXT button in key pad to save the setting.
- Return to SYSTEM SETUP screen by pressing BACK button in key pad.

|   |
|---|
| •VOLUME•  |
|  |
|  |
| 1 2 3 4 5 6   |

### < CONTRAST >

It adjusts the brightness of the screen.

- Default Setting: 0
- Range: -3 ~ +3
- Adjust the brightness by pressing '◀' and '▶' on the screen.
- Press NEXT button to save the setting.
- Press BACK button to return to SYSTEM SETUP screen.

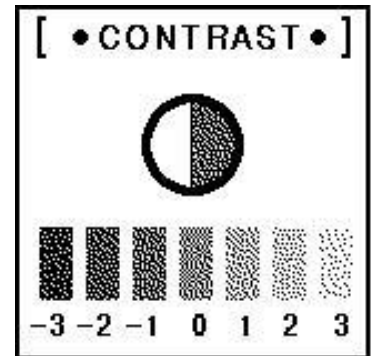

### < BACKLIGHT >

It adjusts the backlight of the screen.

- Default Setting: 0
- Range: -3 ~ +3
- Adjust the brightness by pressing '◀' and '▶' on the screen.
- Press NEXT button to save the setting.
- Press BACK button to return to SYSTEM SETUP screen.

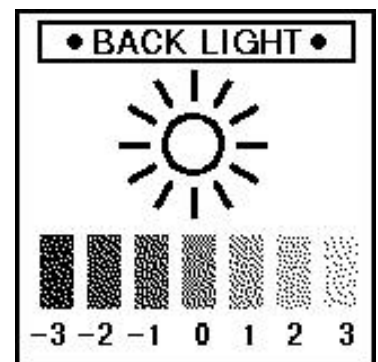

### < ABDOMINAL >

It sets the analysis of abdominal fatness under 18yrs.

- Select abdominal fatness on SYSTEM SETUP screen by pressing '◀' and '▶' button. Press NEXT button in key pad.
- Pre-set: NO
- Choose YES or NO by pressing '◀' and '▶' button in key pad.
- If YES is chosen, abdominal analysis is displayed to all age.
- If NO is chosen, abdominal analysis is not displayed to the patients below 18 years old.
- Press NEXT button to save the change.
- Return to SYSTEM SETUP screen by pressing BACK button in key pad.

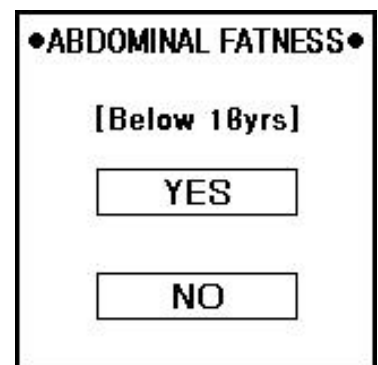

### <GOAL SETTER >

It choose whether using GOAL SETTER MODE

- Select GOAL SETTER MODE on SYSTEM SETUP screen by pressing '◀' and '▶' button. Press NEXT button in key pad.
- Pre-set: ON
- Choose ON or OFF by pressing '◀' and '▶' button in key pad.
- Press NEXT button to save the change.
- Return to SYSTEM SETUP screen by pressing BACK button in key pad.

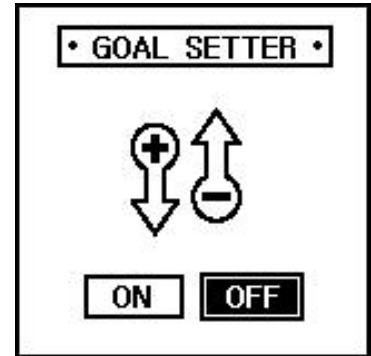

### Note



It has no 'Goal setter' in the ACCUNIQC BC310 (For upper body /lower body).

### < DATE TYPE >

This is to set the format of the date.

- Select DATE TYPE on SYSTEM SETUP screen by pressing '◀' and '▶' button. Once it is selected, press NEXT button in key pad.
- Pre-set: YY-MM-DD
- Choose one by pressing '◀' and '▶' button in key pad.
- Press NEXT button in key pad to save it.
- Return to SYSTEM SETUP screen by pressing BACK button in key pad.

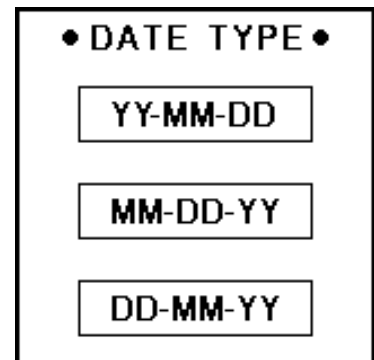

### < KEY SOUND >

It choose the sound of keys when the data is input.

- Select SOUND on SYSTEM SETUP screen by pressing '◀' and '▶' button, and press NEXT button in key pad.
- 'ELEC' is electronic sounds, 'VOICE' is human sounds.
- Choose the sound with '◀' and '▶' button on key pad.
- Press NEXT button in key pad to save selected value.
- Return to SYSTEM SETUP screen by pressing BACK button in key pad.

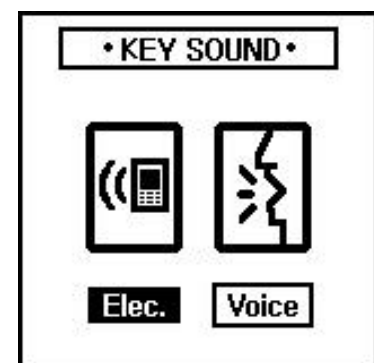

### < THERMAL PRINT >

It selects the printing mode of thermal printer. (Thermal printer is an option.)

- Select THERMAL PRINT on SYSTEM SETUP screen by pressing '◀' and '▶' button. Press NEXT button in key pad.
- Pre-set: OFF
- ON/OFF: Select either ON or OFF by pressing '1' in key pad.
- Choose 'AUTO', 'MANUAL' or 'OFF' by pressing '◀' and '▶' button
- PRINT TYPE: Choose PRINT TYPE by pressing '2'.

Select the paper format either HORIZONTAL TYPE or VERTICAL TYPE.

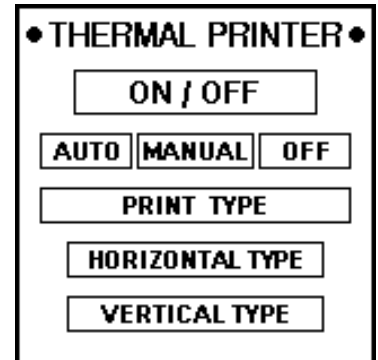

### < THERMAL LOGO >

It choose whether using thermal logo.

- Select THERMAL LOGO on SYSTEM SETUP screen by pressing '◀' and '▶' button. Press NEXT button in key pad.
- Choose ON or OFF by pressing '◀' and '▶' button in key pad.
- Press NEXT button to save the change.
- Return to SYSTEM SETUP screen by pressing BACK button in key pad.

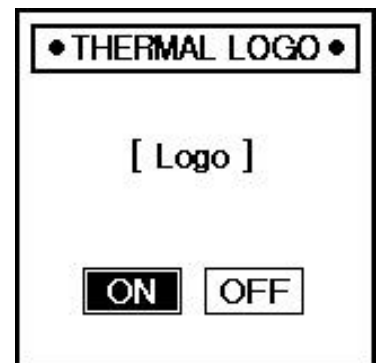

# MEASUREMENT AND ANALYSIS

## 1. Precautions for Measurement

The reliability of the results can be assessed by its accuracy. The "Accuracy" of the device is determined by comparing the actual body composition and the results from Body Composition Analyzer. The "Reproducibility" is determined when the device gives the identical results under the same condition. In order to maintain the accuracy of the results, the following guidelines should be kept.

- ① Water volume increases after a meal. Therefore, measure on an empty stomach.
  - Measure 3 ~ 4 hours after a meal.
  - Avoid the beverages containing caffeine or the beverages functioning as diuretics 4 hours before the measurement.
  - Drink 2 cups of water 2 hours before the measurement.
- ② Before the measurement, the subject should be in a stable condition.
  - Measure 3 ~ 4 hours after a bath, a sauna, exercise or activity that sweats a lot.
  - Or measure before these actions.
- ③ Avoid drinking alcohol 24 hours before the measurement
- ④ Wear clothes as light as possible.
- ⑤ Once the subject is on the scale, avoid sudden movement from sitting to standing position. Body fluid goes down to the lower body and it affects the results. Thus subjects should be measured after maintaining standing position for 5 minutes.
- ⑥ Clean both the electrodes and measuring body parts.
- ⑦ Changes in room temperature may affect the results. Measurement should be done in a temperature around 20 °C.
- ⑧ Body composition and weight varies even during a day. Therefore, the measurement should be performed at the same time every day. For a person who stands for a long period of time during a day, it is advised to measure in the morning.
- ⑨ Go to bathroom before measurement.
- ⑩ Maintain correct position and posture during the measurement.



---

In order to keep one's health and the balance of body composition, check the changes of body composition through the continuous analysis and compare the results. Make sure that the body composition should be measured under the same physical and environmental conditions. If the condition before the measurement such as volume of a meal, meal time, and activities (exercise, sauna, drinking lots of beverage, urination, etc.) are kept same, the reproducibility of a device is obtained. Therefore, the data can be used to evaluate the change of body composition.

## 2. Correct Posture

### 1) How to Touch Plate Electrodes

- Make sure that the plate electrodes are clean.
- Take off the socks or stockings then, stand on the plate electrodes.
- Remove sweat or foreign matters on the soles.
- Fairly place the bare feet on the plate electrodes. Make sure that the clothes are not between the soles and the plate electrodes.

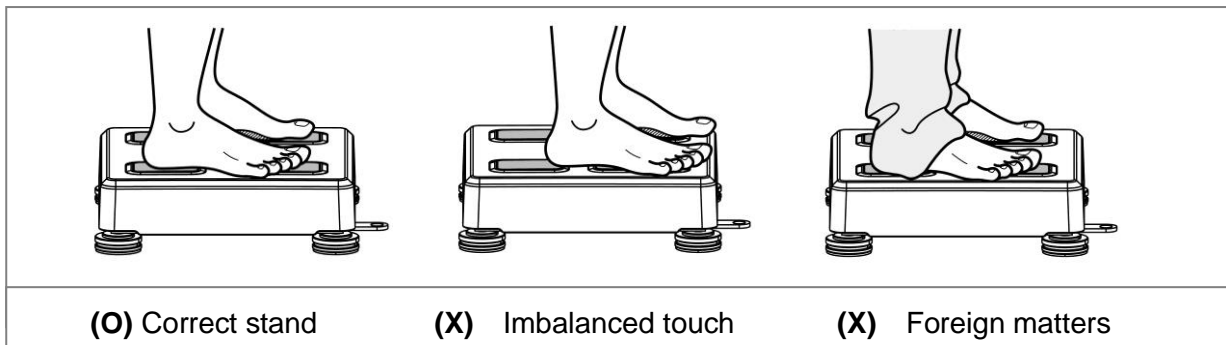

### 2) How to Touch Handle Electrodes

- Grip handle electrodes with fingers and palms.
- 4 electrodes should be touched impartially.
- Stretch both arms and spread them 30° from the body.

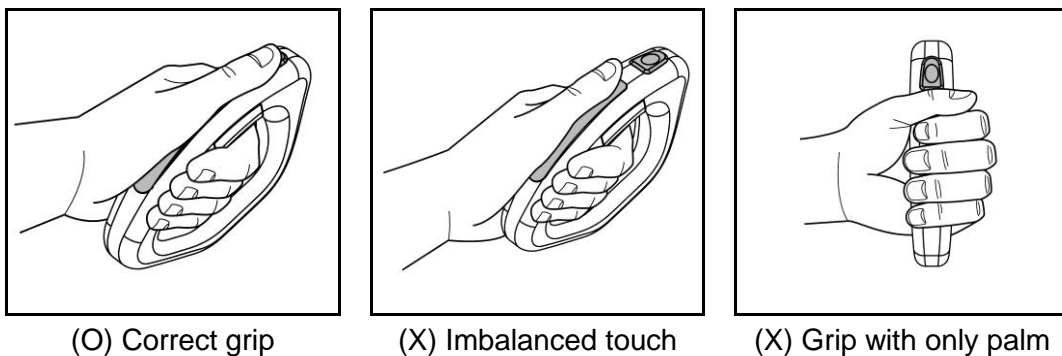

### Note



1. When a subject has small hands or feet and cannot cover all electrodes sufficiently, please pay attention to touch all electrodes fairly. The way to touch the electrodes will affect the reliability of the results.
2. During the measurement, the subject should not be touched by others or conductive materials.
3. If all eight electrodes are not perfectly touched during measurement, measurement will be stopped or the result is not reliable.

### 3) Measuring Posture

- Step the scale in the bare feet. Stretch both arms and spread them 30° from the body.
- Press start buttons with thumbs for 2 ~ 3 seconds to start the measurement. Once it starts, release the start button and hold the same posture until the measurement is over.
- Do not speak or move the body until the measurement is completed.
- Do not bend or shake the arms until the measurement is completed.
- The measurement will be stopped if all eight electrodes are not fairly touched.

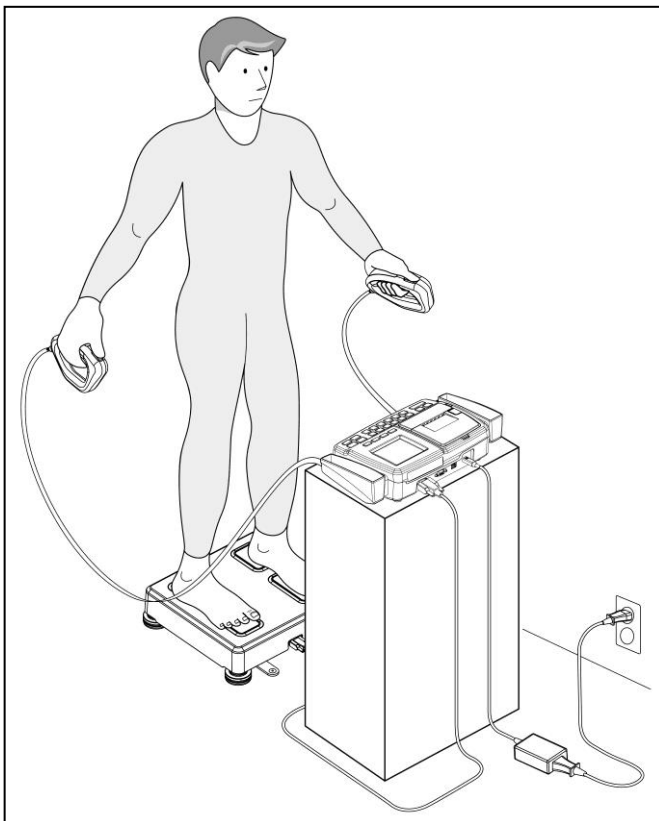

<Measuring posture for Whole and Upper body>

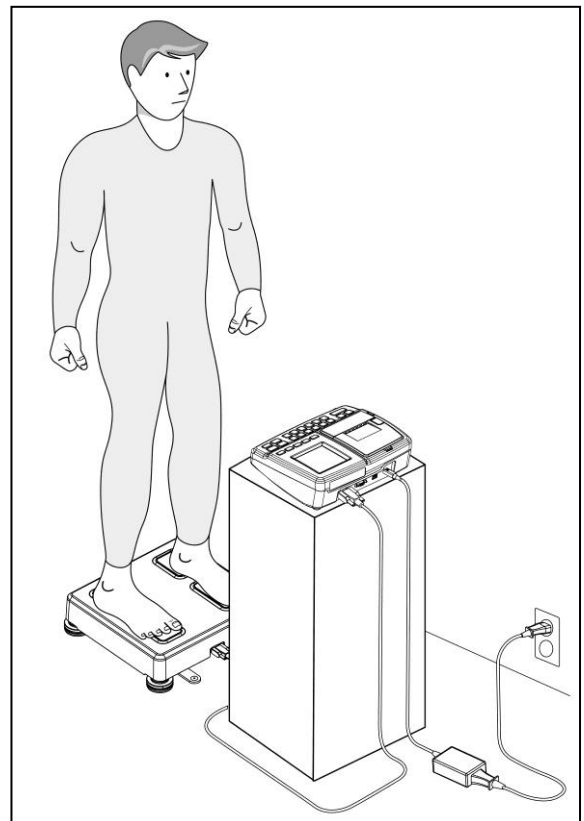

<Measuring posture for lower body>

### 3. Measuring Procedure

#### 1) Basic Analysis

##### A. ACCUNIQ BC310 (For whole body)

###### ① Weight measurement

- When the subject steps on the scale, the screen changes with a chime bell.
- Do not move or speak until the measurement is completed.
- The measured weight is displayed on the screen.

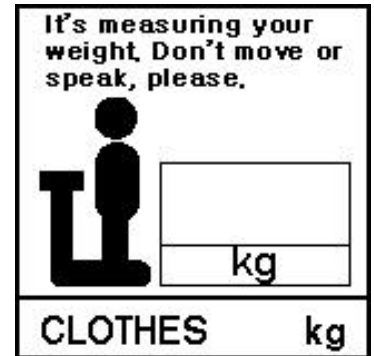

###### ② After the weight measurement, input the personal data.

###### ③ Personal information

Input the following information in a order gender, age, and height. Confirm input data. Press NEXT button to the next step.

##### ▪ Select gender

- The following message appears. "Select your gender."
- Select either MALE or FEMALE from the keypad.



##### ▪ Input age

- The following message appears. "Input your age."
- Input age using the numerical buttons on the keypad.
- Press 'NEXT' button.

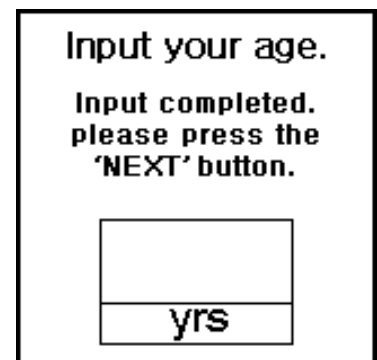

- Input height
  - The following message appears. "Input your height."
  - Input height using the numerical buttons on the keypad.
  - Press the 'NEXT' button.



- Input goal Body fat%
  - The following message appears. "Input goal P.B.F."
  - Input goal P.B.F using the numerical buttons on the keypad.
  - The possible input range is 3~30%.
  - Press the 'NEXT' button



### Note



When you set OFF 'Goal setter', this screen will not be displayed.

#### ④ Measurement posture

Once the input is completed, the screen appears as shown in the picture.

- Hold the handle electrodes and stand up rightly.
- Press the start button to start.
- Do not move or speak during the measurement.



⑤ During the measurement, the screen appears as shown in the picture.

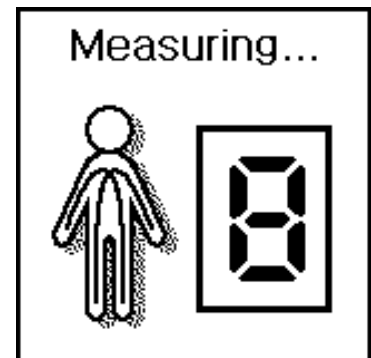

**Note**



1. Do not move or bend the arms until the measurement is completed. Measuring time is within 1 minute.
2. When the measurement is wrong,
  - Error message appears on the screen.
  - Refer to ERROR & REPAIR part for the detail.

⑦ Result screen

- After measurement is completed, the result is displayed on the screen.
- The result is presented in graph and numerical value.
- Check the results and press PRINT or NEXT button.

| RESULT   |                   |
|----------|-------------------|
| •B.M.I.: | kg/m <sup>2</sup> |
| •P.B.F.: | %                 |
| •L.B.M.: |                   |
| •W.H.R.: |                   |

⑧ Print the results and Restart

- Once the result is displayed on the display, it can be printed out in pre-printed result sheet.
- After confirming the result, press NEXT button if you want to measure again.
- The device returns to the initial screen after one minute.

**Note**



1. If Automatic printing is selected at SYSTEM SETUP, the result sheet is automatically printed after the measurement. If 'PRINT' button is pressed, the same result sheet can be printed more.
2. When the program is installed in a computer connected to the device, the result can be viewed at PC, and it can be printed. Refer to the program CD for the detail.

## B. ACCUNIQ BC310 (For upper body)

### ① Weight measurement

- When the subject steps on the scale, the screen changes with a chime bell.
- Do not move or speak until the measurement is completed.
- The measured weight is displayed on the screen.

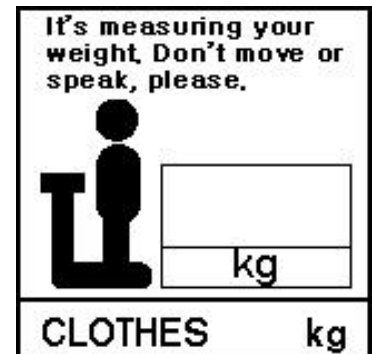

### ② After the weight measurement, input the personal data.

### ③ Personal information

Input the following information in a order gender, age, and height. Confirm input data. Press NEXT button to the next step.

#### ▪ Select gender

- The following message appears. "Select your gender."
- Select either MALE or FEMALE from the keypad.

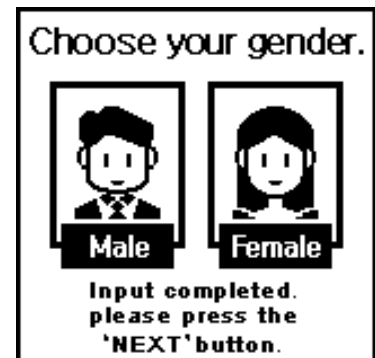

#### ▪ Input age

- The following message appears. "Input your age."
- Input age using the numerical buttons on the keypad.
- Press 'NEXT' button.

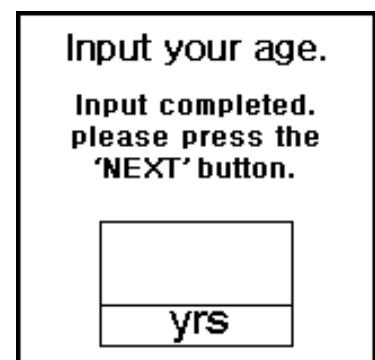

▪ Input height

- The following message appears. "Input your height."
- Input height using the numerical buttons on the keypad.
- Press the 'NEXT' button.

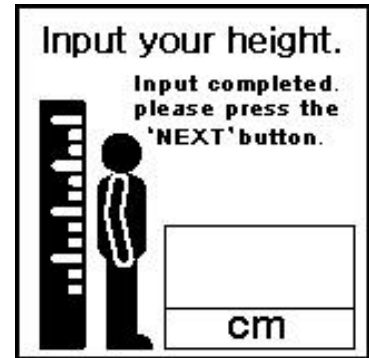

④ Measurement posture

Once the input is completed, the screen appears.

- Press the 'NEXT' button.
- Hold the handle electrodes and stand up rightly.
- Do not move or speak during the measurement.



⑤ During the measurement, the screen appears as shown in the picture.

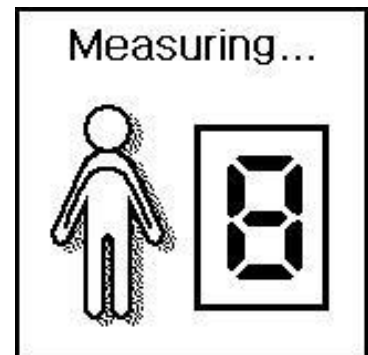

⑥ Result screen

- After measurement is completed, the result is displayed on the screen.
- The result is presented in graph and numerical value.
- Check the results and press PRINT or NEXT button.

| RESULT   |                   |
|----------|-------------------|
| •B.M.I.: | kg/m <sup>2</sup> |
| •P.B.F.: | %                 |
| •L.B.M.: |                   |



### C. ACCUNIQ BC310 (For lower body)

① Weight measurement

- When the subject steps on the scale, the screen changes with a chime bell.
- Do not move or speak until the measurement is completed.
- The measured weight is displayed on the screen.

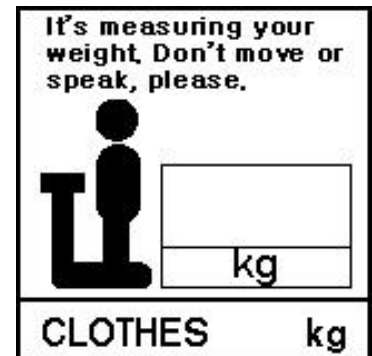

② After the weight measurement, input the personal data.

③ Personal information

Input the following information in a order gender, age, and height. Confirm input data. Press NEXT button to the next step.

▪ Select gender

- The following message appears. "Select your gender."
- Select either MALE or FEMALE from the keypad.

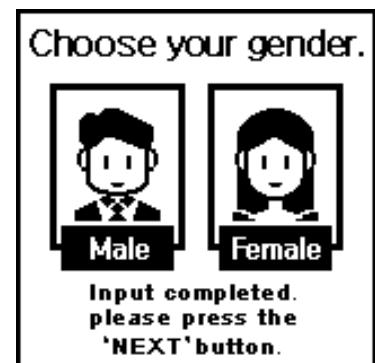

▪ Input age

- The following message appears. "Input your age."
- Input age using the numerical buttons on the keypad.
- Press 'NEXT' button.

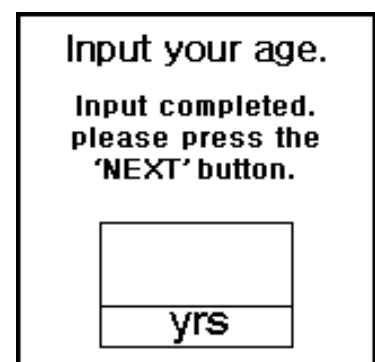

▪ Input height

- The following message appears. "Input your height."
- Input height using the numerical buttons on the keypad.
- Press the 'NEXT' button.

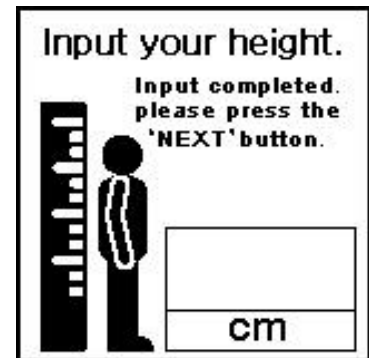

④ During the measurement, the screen appears as shown in the picture.

- Stand up rightly.
- Measuring impedance is start.
- Do not move or speak during the measurement.

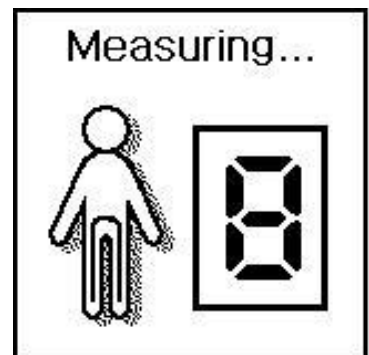

⑤ Result screen

- After measurement is completed, the result is displayed on the screen.
- The result is presented in graph and numerical value.
- Check the results and press PRINT or NEXT button.

| RESULT   |                   |
|----------|-------------------|
| •B.M.I.: | kg/m <sup>2</sup> |
| •P.B.F.: | %                 |
| •L.B.M.: |                   |
|          |                   |

## 2) Analysis Using Blood Pressure Monitor/Software Program

The blood pressure monitor from SELVAS Healthcare, Inc. can be connected to the device as an option.

In this way, the blood pressure can be monitored together with weight control. It helps to manage the body fat while checking the blood pressure simultaneously. The measuring procedure is as follows.

- ① Connect a Blood Pressure Monitor to the device.
- ② Connect the device to a computer in which Body Pass Plus or Easy Body Plus is installed.
- ③ Turn on the power of BPM and the computer. Turn on the device.
- ④ Input personal data to create a new ID or input ID which already registered.
- ⑤ Measure blood pressure first.
- ⑥ Measure body composition.
- ⑦ The results of blood pressure and body composition are immediately displayed on the computer screen after the completion of body composition analysis.
- ⑧ Save the data or print it out.

### Note



1. Blood pressure should be measured before body composition analysis. Refer to the user manual of blood pressure monitor for more detail.
2. The result of blood pressure can be printed on the result sheet or reviewed at the program.

# RESULT INTERPRETATION

Here's the explanation and the criteria of the printed results.

## 1. Personal Data

The subject's name / ID, date, height, weight, age and gender are indicated on the result sheet.

## 2. Logo

The user can input LOGO such as name of hospital, sports center, or obesity clinic, telephone number, address, contact person, etc.

Refer to the manual of Body Pass Plus or Easy Body Plus for logo insertion.

## 3. Body Composition Analysis

The body composition analysis is indicated in the ratio based on the subject's weight.

- ① Weight: It is the sum of total body water, mineral, protein, and body fat in the table.
- ② M.B.F. (Mass of Body Fat): It is calculated by subtracting lean body mass from weight.
- ③ L.B.M. (Lean Body Mass): It is calculated by subtracting mass of body fat from body weight.  
Lean body mass consists of fat free mass of body such as muscle, organs, blood and water.
- ④ S.L.M.: (Soft Lean Mass): It composes of body water and protein.
- ⑤ Mineral: It composes of bone and electrolyte.
- ⑥ Protein: this is a major element that composes soft lean mass together with body water.
- ⑦ T.B.W. (Total Body Water): It consists of intra-cellular and extra-cellular water. For healthy adults, body water is 45 ~ 65% of body weight even though it varies between persons.  
Assessment of Under, Optimal, and Over in the table is assessed by the optimal range based on standard weight of the subject.

## 4. Obesity Assessment

This assessment help to control the subject's body composition and weight. Body composition analysis result is compared with ideal body composition reflecting age and gender of the subject. The result is displayed in a bar graph. Optimal range of weight and soft lean mass is calculated on the basis of standard weight.

1) Percent Body Fat (P.B.F., %): It is the ratio (%) of the body fat based on the subject's weight.

|       |              |           |           |           |              |
|-------|--------------|-----------|-----------|-----------|--------------|
|       | low-fat      | normal    | over-fat  | obese     | severe obese |
| Men   | less than 15 | 15 ~ ≤ 20 | 20 ~ ≤ 25 | 25 ~ ≤ 30 | over 30      |
| Women | less than 20 | 20 ~ ≤ 30 | 30 ~ ≤ 35 | 35 ~ ≤ 40 | over 40      |

2) Body Mass Index (B.M.I., Quetlet's Index: kg/m<sup>2</sup>): for adults

\*EAST ASIA

|        |             |            |         |
|--------|-------------|------------|---------|
| thin   | normal      | overweight | obese   |
| < 18.5 | 18.5 ~ ≤ 23 | 23 ~ ≤ 25  | over 25 |

\* EU and etc.

|        |             |            |         |
|--------|-------------|------------|---------|
| thin   | normal      | overweight | obese   |
| < 18.5 | 18.5 ~ ≤ 25 | 25 ~ ≤ 30  | over 30 |

3) Obesity degree(%):

Indicates the degree of obesity of the current weight against the standard weight.

Fatness = {(current weight - Standard weight) / Standard weight} X 100 (%)

| Division | Very weak      | Weak        | normal      | A little obese | obesity       |
|----------|----------------|-------------|-------------|----------------|---------------|
|          | Less than -20% | -20% ~ -10% | -10% ~ +10% | +10% ~ +20%    | + 20% or more |

\* Standard weight = height (m)<sup>2</sup> X 22

4) Abdominal circumference:

Circumference around the umbilicus

| Division | Korea          | Japan          | China          | Outside Europe  | USA              |
|----------|----------------|----------------|----------------|-----------------|------------------|
| Male     | Less than 90cm | Less than 85cm | Less than 85cm | Less than 102cm | Less than 40inch |
| Female   | Less than 80cm | Less than 90cm | Less than 80cm | Less than 88cm  | Less than 35inch |

## 5. Abdominal Analysis

Abdominal fatness is divided into subcutaneous type and visceral type. When it comes to body fat, experts say that it is important not only the amount of fat but also the distribution of it. If visceral fat area is over  $100 \text{ cm}^2$ , it is classified as "visceral obesity" regardless of P.B.F., W.H.R. or Body weight.

Waist-to-hip ratio (W.H.R.) shows the distribution of fat stored in one's abdomen and hip. It is simple but useful to assess fat distribution. Body fat is stored in two distinct ways. They are often called 'apple' and 'pear' type. Apple type shows bigger girth of waist than hip and pear type has bigger girth of hip than waist. If body fat in abdomen increases more, the risk to cardiovascular diseases, diabetes, etc. becomes higher.

### 1) W.H.R. (Waist to Hip Ratio)

W.H.R. is calculated by dividing waist girth by hip girth. When W.H.R. is below 0.9 (male) / 0.85 (female), the risk of visceral obesity is low.

## 6. Comprehensive Evaluation

### ① Body Type

Body type is determined by B.M.I and P.B.F. Body type is classified into 9 types; Low fat Low weight, Low fat Muscular, Athletic, Low weight, Standard, Over Weight Muscular, Thin fat, Over fat, Obese.

### ② Biological Age

It is the estimated physical age of the subject considering body composition analysis result, gender, and biological age. This is calculated by comparing the optimal body composition based on the gender and biological age of the subject with the actual analyzed body composition. It can be used to evaluate the subject's health and body development.

### ③ Basal Metabolic Rate (B.M.R.)

B.M.R. is the calories to maintain human body's basic function such as movement of heart, brain, neural transmission, regulating body temperature and so on. B.M.R. is in proportion to S.L.M. because body fat stores energy while muscle consumes energy. Therefore, even if the weight is same between persons, the person with more muscle has greater B.M.R.

④ T.E.E. (Total Energy Expenditure)

It is the sum of basal metabolic rate and calories needed for daily activity. Generally it is calculated by multiplying B.M.R. by PAL (Physical Activity Level).

## 7. Control guide

① muscle regulation

This is the control target to achieve the appropriate muscle mass based on the current measurement.

If the muscle is more than the right value, the adjustment value is displayed as +0.0.

② Fat regulation

This is the control target value for proper body fat amount based on the present measurement value.

③ Weight control

This is the total body weight control target combined with fat control and muscle control.

(-), increase it if it is positive (+).

④ Recommended weight

If you add (+) or subtract (-) the total weight adjustment to your current weight, you will gain the recommended weight.

## 8. Setting Goal

Input a goal Body fat%. It provides goal weight, goal P.B.F, Body Fat % to be controlled.  
When you input "0", goal Body Fat % will not be printed.

① Goal weight: It indicates a goal weight.

$$*\text{Predicted Weight} = \text{LBM} / \{1 - (\text{TARGET PBF}/100)\}$$

② Goal Mass of Body Fat: It indicates goal M.B.F.

$$*\text{Predicted Fat Mass} = \text{MBF} - \text{control}$$

③ Weight to be controlled: It indicates the weight to be controlled by subtracting standard weight from current weight.

$$*\text{Control} = \text{Weight} - \text{Predicted Weight}$$

## 11. Segmental Assessment

Soft lean mass and body fat of five body parts (left and right arms, left and right legs, and trunk) are indicated in a diagram.

## 9. Impedance

It is the resistance of human body to the electric current that flows through the body. Impedance value can be used in monitoring the function of this device and checking body change of the subject.



## STORAGE & MAINTENANCE

- 1) Pay attention to the allowable value to electric current.
- 2) Avoid direct sunlight, humidity, dust, thick oil and salty or extreme changes in temperature.
  - ⊗ 3) Do not install or store the device in a place where any chemicals or gas is stored.
  - ⊗ 4) Do not use the device in any unstable, vibrating, or impact-giving area.
- 5) Connect the earth placed on the backside of this device to terminal plate to prevent any electric shock from leakage current or a potential difference.
  - ⊗ 6) Do not put or drop anything on the device and avoid strong impact.
  - ⊗ 7) Do not disassemble or remodel the device.
- 8) If this unit has not been used for a long time, use this after confirming by an expert if all function and appearance are in good condition.
  - ⊗ 9) Do not splash any fluid on this device or insert any foreign substances.
- 10) In case of inserting foreign substances or exposing to particular environment, this device must be examined by an expert before use.
- 11) Use the power cable, plug, and fuse that are offered by our company.

At this time, confirm the covering of cable, the state of plug connection, and other check points to the things below.

  - RS 232C cable
  - USB port
  - Adapter
- 12) When pulling out the power cable, turn off the power switch first and then pull the plug out.
- 13) Storage ambient: Temperature -20 ~ 60 °C, Humidity lower than 95 % (non condensing)
- 14) Operation ambient: Temperature 10 ~ 40 °C, Humidity 30 ~ 75 % (non condensing)
  - ⊗ 15) Do not store or use this device under 70 kPa (700 mbar) or over 106 kPa (1060 mbar) of atmospheric pressure.
- 16) Cleaning & Disinfection
  - ① Cleaning: When cleaning, use a soft cloth but do not use volatile solvent like benzene and alcohol or a wet cloth. Wipe out minute dust once per 2 ~ 3 days with a dry cloth.
  - ② Disinfection: Spray alcoholic water of glutaraldehyde disinfect solution. Then, wipe the enclosure with a soft lint.
- 17) Refer to "SAFETY PRECAUTIONS."
  - ⊗ **18) Do not to diagnose or treat any medical condition.**

# ERROR & REPAIR

## 1. Kinds of Error & Repair

| Error   | Cause   | Repair  |
|---|---|---|
| Out of range of impedance                               | <ul style="list-style-type: none"> <li>• When the subject's body impedance is deviated from the limit</li> <li>- Insufficient touch to electrodes</li> <li>- Impedance is out of range</li> <li>- Range: 100 ~ 950 <math>\Omega</math></li> </ul> | <ul style="list-style-type: none"> <li>• Clean the measuring parts (the electrodes, palms, and soles) and try again.</li> <li>• Measure again with correct posture.</li> <li>• Do not move during measurement.</li> <li>• If the same error is repeated, please contact our company or its local distributor where this device is purchased.</li> </ul> |
| Out of range of body fat                                | <ul style="list-style-type: none"> <li>• When the subject's P.B.F. is deviated from the limit</li> <li>- Incorrect input of personal data</li> <li>- P.B.F. is out of range</li> </ul>  | <ul style="list-style-type: none"> <li>• Clean the Handle electrodes and try again.</li> <li>• If the same error is repeated, please contact our company or its local distributor where this device is purchased.</li> </ul>  |
| Out of range of measurement                             | <ul style="list-style-type: none"> <li>• When the subject's fatness is deviated from the limit</li> <li>- Mechanical error</li> </ul>   | <ul style="list-style-type: none"> <li>• Input height correctly.</li> <li>• Check the weight is correct and try again.</li> <li>• If the same error is repeated, please contact our company or its local distributor where this device is purchased.</li> </ul>   |
| Problem is detected in the internal communication port. | <ul style="list-style-type: none"> <li>• There's a problem in the internal communication port.</li> </ul>   | <ul style="list-style-type: none"> <li>• Turn off the power and turn on.</li> <li>• If the problem remains, please contact our company or its local distributor where the device is purchased.</li> </ul>   |
| Can't measure the weight                                | <ul style="list-style-type: none"> <li>• When the subject's weight is deviated from the limit</li> <li>- Measuring error</li> <li>- Moving during the measurement</li> </ul>  | <ul style="list-style-type: none"> <li>• Measure weight again. If the subject's weight is out of range, weight can't be measured.</li> </ul>  |

| Error   | Cause  | Repair  |
|---|--|---|
| No printing paper.                              | <ul style="list-style-type: none"> <li>• There is no thermal paper.</li> </ul>         | <ul style="list-style-type: none"> <li>• Insert the thermal paper.</li> </ul>   |
| Printer cover is opened.                        | <ul style="list-style-type: none"> <li>• Printer cover is opened.</li> </ul>           | <ul style="list-style-type: none"> <li>• Check the cover is firmly closed.</li> </ul>   |
| Problem is detected in Auto-cut of the printer. | <ul style="list-style-type: none"> <li>• Auto-cut blade is shown outward.</li> </ul>   | <ul style="list-style-type: none"> <li>• Open the cover of Printer-Cut.<br/>Turn the plastic Phillips-head screws clockwise and push the blade back.</li> <li>• If the problem remains, please contact our company or its local distributor where the device is purchased.</li> </ul> |
| Problem is detected in the printer.             | <ul style="list-style-type: none"> <li>• Thermal printer has some problems.</li> </ul> | <ul style="list-style-type: none"> <li>• Power is automatically turned off by safety unit.</li> <li>• Turn the power after few minutes. If the problem remains, please contact our company or its local distributor where the device is purchased.</li> </ul>                         |

## 2. Error Occurrence & Repair

| Error   | Cause   | Repair  |
|---|---|---|
| P.B.F. is measured too low or too high                          | <ul style="list-style-type: none"> <li>- Measure in unstable condition such as right after the exercise, bath, sweat, or drinking lots of water.</li> <li>- Moving or speaking during the measurement</li> <li>- Handle electrodes or measuring parts are dirty.</li> </ul> | <ul style="list-style-type: none"> <li>• Measure again in a stable condition with the correct posture.</li> <li>• Do not move or speak during the measurement.</li> <li>• Clean handle electrodes with soft gauze and try again.</li> <li>• Clean hands and soles and try again.</li> <li>• Make sure there are no foreign substances between electrodes and measuring body parts.</li> </ul> |
| It does not work even when start buttons are correctly pressed. | <ul style="list-style-type: none"> <li>- Defective cable between the head and the scale</li> <li>- Start buttons are defective.</li> </ul>  | <ul style="list-style-type: none"> <li>• Contact our company or its local distributor where this device is purchased.</li> </ul>  |
|   | <ul style="list-style-type: none"> <li>- Bad connection between the head and the scale</li> <li>- Handle electrodes are defective.</li> </ul>   | <ul style="list-style-type: none"> <li>• Check whether the handle electrodes are connected tightly to the head.</li> <li>• If the same error is repeated, please contact our company or its local distributor where this device is purchased.</li> </ul>  |

# AFTER SERVICE

## 1. AFTER SERVICE

- ❗ If there is any problem with the unit, please follow the steps below;
- ※ Contact our company's Overseas Service Department immediately.  
After gathering the model name, Serial Number, date of purchase and description of the problem, contact our company with information shown below.
- ※ Try to solve the problem over the phone with the personnel of local service department.  
If the problem cannot be solved over the phone, just return to service department directly.
- ※ Our company or local distributor will make available on-request circuit diagrams, component part list, descriptions, calibration or other information which will assist your appropriately qualified technical personnel to repair those parts of unit which are designated by our company as repairable.

How to contact our company

Write us at:

SELVAS Healthcare, Inc.

155, shinseong-ro, Yuseong-gu, Daejeon, 34109 Republic of Korea

TEL: 82-42-879-3000

FAX: 82-42-864-4462

(You can also contact the following representative or your local distributor)

## 2. PACKING AND TRANSPORT

Our company wraps this device up with the most suitable method to protect it from any impact or damage during shipping and transporting. This device can be damaged during delivery if it is packed with other ways except the one our company uses. Please handle this device carefully without any impact in packing and delivering it.

If this device needs to be transported wrap this device up again and transport it as follows.

- ① Turn off the power.
- ② Turn off the power of the peripheral devices and disconnect all cables.
- ③ Disassemble the device in reverse order of assembly.
- ④ Pack the device with the original packing materials.
- ⑤ Transport it carefully.

## SPECIFICATION

|                     |  |  |  |
|---------------------|--|--|--|
| Model               | ACCUNIQ BC310  |  |  |
| Measuring method    | BIA via tetra-polar electrode method using 8 touch electrodes.   |  |  |
| Frequency Range     | 5, 50, 250 kHz   |  |  |
| Measuring site      | ACCUNIQ BC310<br>(for whole body)  | ACCUNIQ BC310<br>(for upper body)  | ACCUNIQ BC310<br>(for lower body)                  |
| Main items          | ACCUNIQ BC310<br>(For whole body )   | ACCUNIQ BC310<br>(For upper/lower body)  |  |
|                     | Weight, Standard weight, Mass of Body Fat, Lean Body Mass, Total Body Water, Intra Cellular Water, Extra Cellular Water, Body Mass Index, Percent of Body Fat, Waist to Hip Ratio, Segmental analysis (lean body mass of arms, legs, and trunk), Body Type, Ratio of E.C.W./T.B.W., Basal Metabolic Rate, Impedance, Target PBF(%), Predicted weight, predicted MBF& Control | Weight, Standard weight, Mass of Body Fat, Lean Body Mass, Total Body Water, Intra Cellular Water, Extra Cellular Water, Body Mass Index, Percent of Body Fat, Body Type, Basal Metabolic Rate, Impedance, Target PBF(%), Predicted weight, predicted MBF& Control |  |
| Current             | Less than 280 $\mu$ A  |  |  |
| Power supply        | Input-AC 100~240V, 50-60Hz, 1.5A<br>Output-DC 12V, 5A, 60VA ADAPTER  |  |  |
| Display             | 4.5 Inch Graphic LCD (160 x 160 pixel)   |  |  |
| Input device        | Key pad, PC remote control   |  |  |
| Transmitting device | USB port, RS-232 Cable   |  |  |
| Printing device     | thermal printer  |  |  |
| Dimension           | Head: 350 x 605 x 870 mm (W x D x H, $\pm$ 10 mm) *Included column   | Head: 350 x 216.5 x 125 mm (W x D x H, $\pm$ 10 mm)  | Head: 267 x 216.5 x 90 mm (W x D x H, $\pm$ 10 mm) |
|                     | Weight scale: 371 x 355 x 105 mm (W x D x H, $\pm$ 10 mm)  |  |  |
| Weight              | About 13.5kg<br>(Included column)  | About 11.5kg   | About 11kg   |
| Measuring range     | 100 ~ 950 $\Omega$   |  |  |
| Measuring time      | Within 1 minute  |  |  |
| Input height        | 50~220 cm  |  |  |

|                   |   |
|-------------------|---|
| Measuring weight  | 10~200 kg   |
| Applicable age    | 1 ~ 99 years old  |
| Operation ambient | Temperature: 5~40℃, Humidity: 15~93% (non condensing)           |
| Storage ambient   | Temperature: -25~70℃, Humidity: lower than 93% (non condensing) |

※ For purpose of improvement, specifications and design are subject to change without notice.

# WARRANTY

## Warranty

|                    |   |      |  |
|--------------------|---|------|--|
| Name of product    | Body Composition Analyzer                   |      |  |
| Name of model      | ACCUNIQ BC310                               |      |  |
| Serial number      |   |      |  |
| Period of warranty | Within 2 years from the date of manufacture |      |  |
| Date of purchase   |   |      |  |
| Customer           | Add.  | Name |  |
|                    |   | Tel. |  |
| Dealer (market)    | Add.  | Name |  |
|                    |   | Tel. |  |

### Note



- When you receive this warranty, make sure that the name of the dealer and the month, day and year of purchase are all completed.
- This warranty will not be reissued, please keep it in a safe place.



## Periodic Check List

Management No. \_\_\_\_\_

| Item                    |   | Inspection Subject | Requirements                            | Judgment    | Remarks |
|-------------------------|---|--------------------|---|-------------|---------|
| <b>Visual Check</b>     |   |                    |   |             |         |
| Mainframe               | 1 | Enclosure          | No scratch, crack, deformation and rust | Pass/Fail   |         |
|                         | 2 | Labels and panels  | No peeling and dust                     | Pass/Fail   |         |
|                         | 3 | LCD                | No damage                               | Pass/Fail   |         |
|                         | 4 | Electrode          | No scratch and damage                   | Pass/Fail   |         |
| Accessories             | 1 | Power cord         | No scratch and damage                   | Pass/Fail   |         |
|                         | 2 | User manual        | Kept in proper place                    | Pass/Fail   |         |
| <b>Mechanical Check</b> |   |                    |   |             |         |
| Mainframe               | 1 | Keys               | Smooth operation                        | Pass/Fail   |         |
|                         | 2 | Recorder           | Smooth operation with no abnormal sound | Pass/Fail   |         |
|                         | 3 | Touch Screen       | Smooth operation                        | Pass/Fail   |         |
| Accessories             | 1 | Power cord         | Smooth operation and removal            | Pass/Fail   |         |
| <b>Electrical Check</b> |   |                    |   |             |         |
| Performance             | 1 | Power supply       | Screen display upon power-on            | Pass/Fail   |         |
|                         | 2 | Display            | No abnormality and flickering           | Pass/Fail   |         |
|                         | 3 | Printing           | printing possible                       | Pass/Fail   |         |
|                         | 4 | Measurement        | Proper measurement                      | Pass/Fail   |         |
| General Judgment        |   |                    |   | Pass/Fail   |         |
| Model                   |   | ACCUNIQ BC310      |   | Serial No.  |         |
| Installation place      |   |                    | Date of purchase                        |             |         |
| Check date              |   | Checked by         |   | Approved by |         |

Copy this sheet for use

If repair is required, write down so in the Remarks column.

## Daily Check List

Management No. \_\_\_\_\_

| Item                    |   | Inspection Subject | Requirements                            | Judgment   | Remarks |
|-------------------------|---|--------------------|---|------------|---------|
| <b>Visual Check</b>     |   |                    |   |            |         |
| Mainframe               | 1 | Enclosure          | No scratch, crack, deformation and rust | Pass/Fail  |         |
|                         | 2 | Labels and panels  | No peeling and dust                     | Pass/Fail  |         |
|                         | 3 | LCD                | No damage                               | Pass/Fail  |         |
|                         | 4 | Electrode          | No scratch and damage                   | Pass/Fail  |         |
| Accessories             | 1 | Power cord         | No scratch and damage                   | Pass/Fail  |         |
|                         | 2 | User manual        | Kept in proper place                    | Pass/Fail  |         |
| <b>Mechanical Check</b> |   |                    |   |            |         |
| Mainframe               | 1 | Touch Screen       | Smooth operation                        | Pass/Fail  |         |
|                         | 2 | Recorder           | Smooth operation with no abnormal sound | Pass/Fail  |         |
| Accessories             | 1 | Power cord         | Smooth operation and removal            | Pass/Fail  |         |
| <b>Electrical Check</b> |   |                    |   |            |         |
| Performance             | 1 | Power supply       | Screen display upon power-on            | Pass/Fail  |         |
|                         | 2 | Display            | No abnormality and flickering           | Pass/Fail  |         |
|                         | 3 | Printing           | Waveform printing possible              | Pass/Fail  |         |
|                         | 4 | Measurement        | Proper measurement                      | Pass/Fail  |         |
| Other                   | 1 | Clock              | Present date/time                       | Pass/Fail  |         |
| General Judgment        |   |                    |   | Pass/Fail  |         |
| Model                   |   | ACCUNIQ BC310      |   | Serial No. |         |
| Installation place      |   |                    | Date of purchase                        |            |         |
| Check date              |   | Checked by         | Approved by                             |            |         |

Copy this sheet for use

If repair is required, write down so in the Remarks column.



SELVAS Healthcare, Inc.

HEADQUARTERS:

155, Shinseong-ro, Yuseong-gu, Daejeon, 34109 Republic of Korea

TEL:82-42-879-3000 FAX:82-42-864-4462

SEOUL OFFICE (Sales):

20F Daerung Techno Town 18th, 19, Gasan digital 1-ro, Geumcheon-gu, Seoul, 08594, Republic of Korea

TEL:82-2-587-4056 FAX:82-2-588-1937

EUROPEAN REPRESENTATIVE:

VITAKO Sp. z o.o.

ul. Stanisława Żaryna 7c 02-593 Warszawa, POLAND

TEL: +48 505 522 888

If the problems continue, call the service center. When you ask for service, the manufacturer's label, serial number, date of original purchase and explanation of malfunction will be required.

**Service center**

TEL : 02-587-4056  
042-879-3000

※ For purposes of improvement, specifications and design are subject to change without notice.



BC310E-20170918 Rev2.0