



SAN GIORGIO S.E.I.N.

MARINE INSTRUMENTS AND SENSORS SINCE 1960

www.sangiorgiosein.com - info@sangiorgiosein.com

USER MANUAL

UNS10193

Multifunction Display 7"

M200203 - Rev. 1.01 - 29/10/20

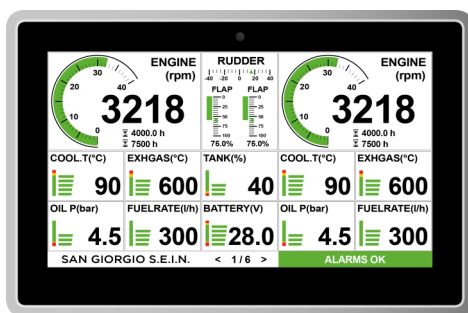

Via Pedullà 59 - 16165 Genova - Ph. +39 010 8301222

BEFORE BEGINNING INSTALLATION OF THIS PRODUCT:

- A visual inspection of this product for damage during shipping is recommended before mounting.
- It is your responsibility to have a qualified person install this unit.
 - Read and follow all installation instructions.
 - Disconnect all electrical power to the instruments.
- Make sure the instruments cannot operate during installation.
- Follow all safety warnings of the instruments manufacturer.
- Contact SAN GIORGIO S.E.I.N. if you have any questions.



The instrument is a maintenance free product, no spare parts are available. At the end of its life cycle the tachometer must be disposed according the electronics disposal rules in force. For technical assistance please contact your dealer.

Introduction

The new multifunction system offers a 7 "touch screen display with integrated ambient light sensor and special software designed for visibility in any light and operating condition. A selection of analog inputs and digital outputs allow direct acquisition of measure sensors without any additional signal converters. Two J1939 CAN Bus ports, one also compatible with NMEA2000 standard, can be used to interface multifunction navigation systems. It can be customised and programmed via USB interface. The system can be controlled remotely via our UNS10400 CAN Bus keyboard.

The unit is supplied already programmed and ready to work according to the client application, but for experienced users it is also possible to easily customize the data acquisition and layout using a simple installation text file.

3

Package content

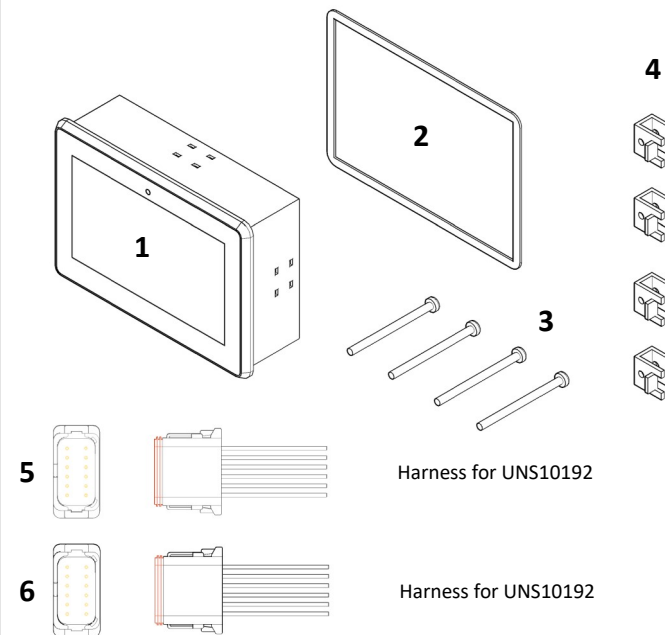

The basic package includes :

- 1) UNS10193 panel
 - 2) Rubber gasket for panel installation (GUA80247)
 - 3) N.4 Mounting screws 4 x 50mm (VIT80323/1)
 - 4) N.4 Mounting brackets (STA80195)
- Optional :
- 5) Connector A - DEUTSCH - DT06-12SA (CON70214/4) + W12S (CON70214/6)
 - 6) Connector B - DEUTSCH - DT06-12SB (CON70905) + W12S (CON70214/6)

5

Connection

The unit uses 2 male connectors. Optional wiring with female connectors is also available.

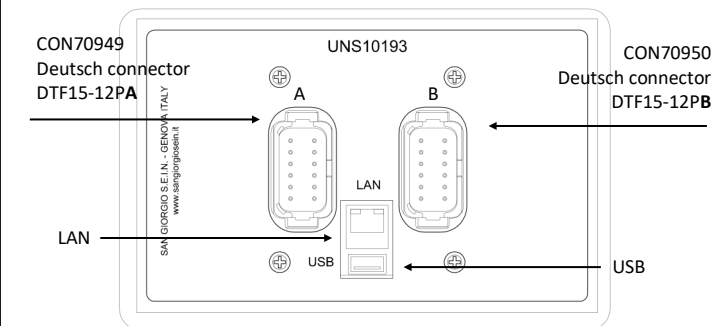

ATTENTION! A-B connectors are not interchangeable. Each connector (male and female counterpart in optional harness) is marked with a letter from A to B and is polarized using a special slot to prevent a wrong connection.

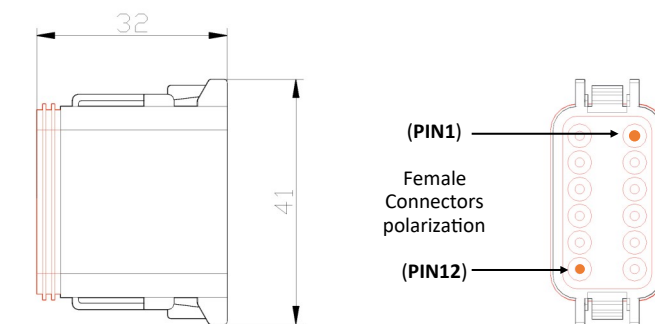

7

Technical features

Display	7" TFT LCD, high brightness
Resolution	800 x 480 pixel
Nits	700
Touch screen	Capacitive
Inputs / Outputs	No.4 Analog inputs 0-10V / 4..20mA (shunt) No.4 Analog inputs 0-300Ohm No.1 Frequency input alternator W / Pickup No.5 Digital inputs / outputs
Communication ports	No.2 CAN Bus 2.0B No.1 NMEA0183 No.1 RS232/485 No.1 USB OTG
Power supply	12/24 V - <500mA 2A external fast fuse required
Dimension	188 x 123 x 69 mm
Mounting hole	178 x 114 mm
Operating temperature	-20 +70 °C
Protection grade	IP65
Weight	840g

Documentation

This documentation is provided attached to the instruments for installation and use:

D190410 - Dimensional connection and technical features

Technical drawing available on website : www.sangiorgiosein.com

2

Introduction

The unit must be installed inside a console that protects the rear of the unit and provides the desired IP protection. The back of the unit is not water resistant and serious damage to the unit and external connection may occur in case of contact with water, moisture or condensation .

The console must provide protection against direct sunlight and an appropriate cover when the unit is not in use, failing to do so will cause display wear/damage.

IMPORTANT: Exposure to extreme direct sunlight can cause a considerable increase unit temperature , and lead to over temperature and damage. This event should be avoided by correct bridge design (shade, distance from the windows, ventilation).

The console must have a correct inclination, generally 30 degrees, to allow water drainage and to reduce viewing angle.

IMPORTANT: the unit uses a capacitive touchscreen technology that is not designed to work if it is covered by water : moderate rain drops are tolerated but if outdoor operation under heavy rain is requested please use an auxiliary external keyboard/controller.

The console must provide enough space and ventilation, inside temperature must be kept as low as possible, always below 55°C.

The console must provide enough space for access and maintenance the rear connectors of the unit including an USB port that may be needed to update the firmware and download logger data.

Identifications

The unit has an identification label on the back panel where it is possible to read:
-Date of manufacture in YYMMDD format, for example 171205

4

Installation

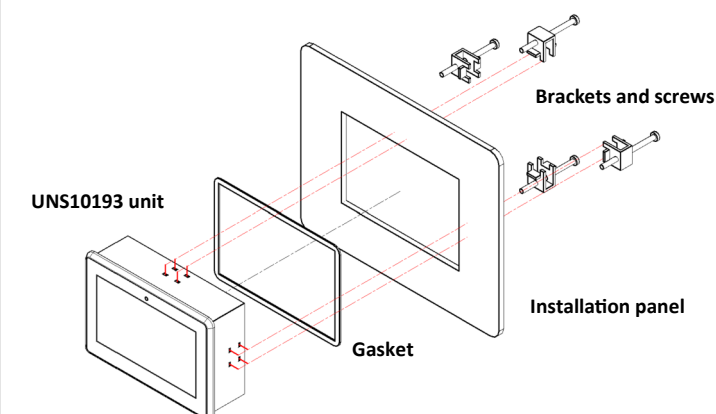

The console must have a correct inclination, generally 30 degrees, to allow water drainage and to reduce viewing angle.

The unit has to be installed in a console with "cutout" of 178 x 114mm , this measure has to be as accurate as possible due to the unit small border profile 188 x 123mm.

Reserve a depth below unit not smaller than 50 mm for connector and cable clearance.

Please use the two bracket and screws as shown in the picture above to secure the unit to the panel leaving the gasket correctly compressed : with the standard screws the panel maximum thickness is 25mm.

The unit is equipped with an gasket, If the material of the panel or the application require a more appropriate sealing method please do apply.



The installer is responsible for a correct waterproof installation and if necessary to replace the gasket provided with another suitable sealant method.

6

Connection list

The Deutsch connectors version are designed for digital (CANBUS) application when only a small selection of analogue inputs. It has 2 x deutsch connectors as seen in the picture below :

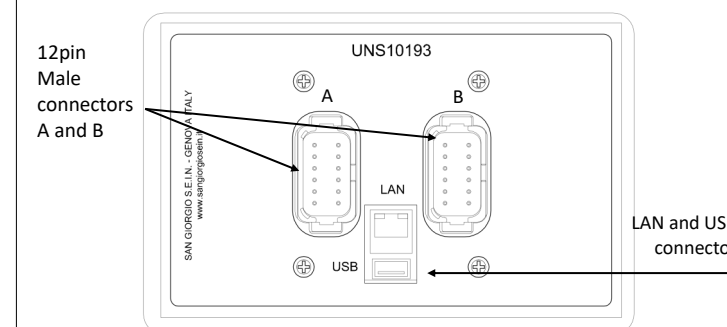

Connector A
(Deutsch DTF15-12PA - CON70949)

- 1) -Power Supply
- 2) +Power Supply
- 3) CAN-L 2
- 4) CAN-H 2
- 5) GND CAN
- 6) NMEA Input
- 7) CAN-L 1
- 8) CAN-H 1
- 9) RS485A / RS232 RX
- 10) RS485B / RS232 TX
- 11) Digital input D1 / Output DO1
- 12) Analog input 1 (Custom, 0..3000Q)

Connector B
(Deutsch DTF15-12PB - CON70950)

- 1) Analog input 2 (Custom, 0..3000Q)
- 2) Analog input 3 (Custom, 0..3000Q)
- 3) Analog input 4 (Custom, 0..3000Q)
- 4) Analog input 5 (Custom, 0..32V)
- 5) Analog input 6 (Custom, 0..32V)
- 6) Analog input 7 (Custom, 0..32V)
- 7) Analog input 8 (Custom, 0..32V)
- 8) Frequency input 1 (W)
- 9) Digital input D2 / Output DO2
- 10) Digital input D3 / Output DO3
- 11) Digital input D4 / Output DO4
- 12) Digital input D5 / Output DO5 / Frequency input 2 (W)

8

Operation

The unit is powered on/ off with an external key switch or or engine main power supply.

After the startup sequence the unit show the main monitoring page as explained below.

The user interface is organized in "pages" designed to simulate a virtual cockpit. On a standard application there are generally from 2 to 10 monitoring pages. After power on the unit shows the first monitoring page , other pages are accessible with touch commands. The layout of each monitoring page varies according the application and may display different type of analogue or gauges .

In the images below You'll find two common pages for engine monitoring application.

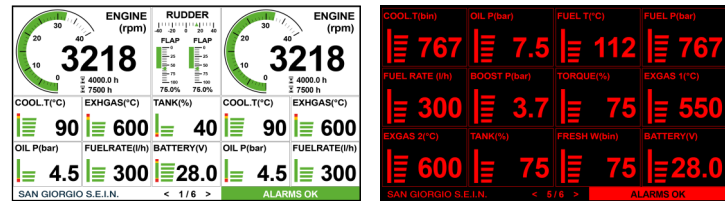

Page with bar indicators in day mode

Page with bar indicators in night mode

Gauges layout

Monitoring pages contain virtual gauges designed to "mimic" original physical gauges in a cockpit. Depending on the application the following standard gauge types can be used :

- Circular or vertical bar gauge, used for analogue and frequency measures.
- Digital (LED) gauge, used for digital on/off measure or status condition
- Databox gauge, used to group multiple information in numeric format.

Circular bar gauge

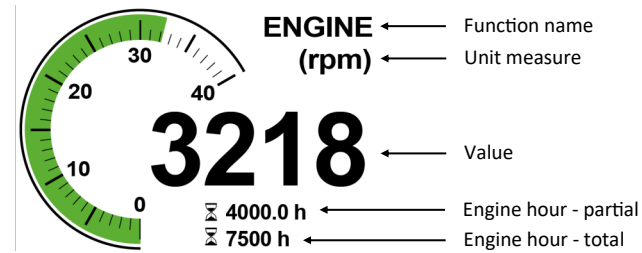

Vertical bar gauge

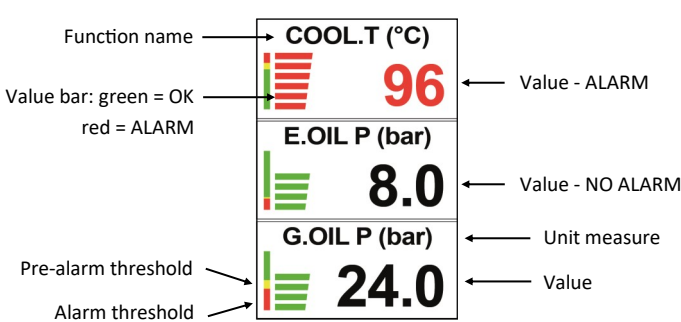

Login

To enter the "Setup" page you have to point your finger at the top of the screen and drag it down, this will open the settings page.

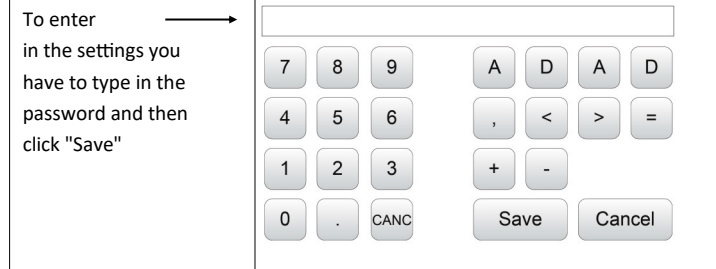
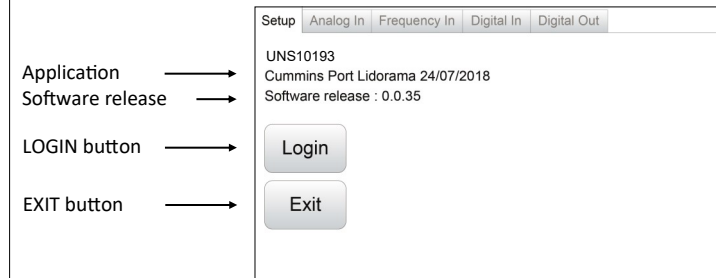
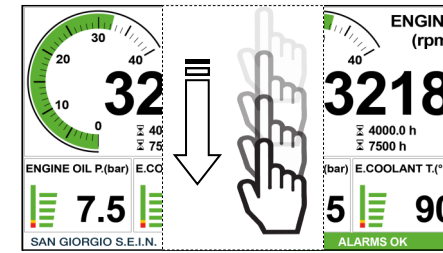

Alarms page

The management of alarm is accessible by the user in the **alarm page**:

The active alarm window is presented to the user immediately after any new alarm is detected and can be shown again by pressing the "Alarms" button in each monitoring page.

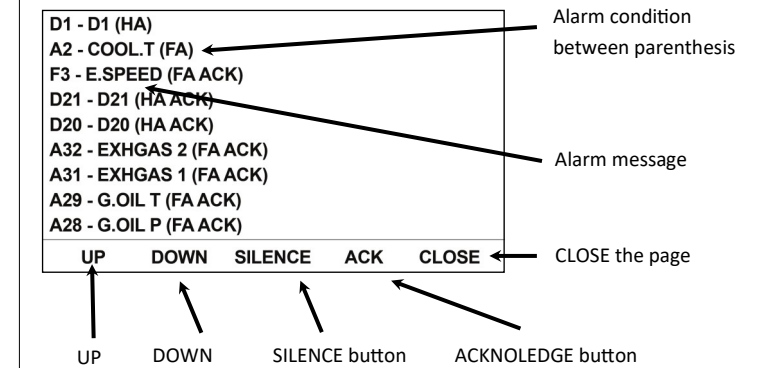

Each alarm is presented in a single line with the following format :

"Alarm description" ("Alarm Status"), for example : A29 - G.OIL T (FA ACK)

The **alarm description** generally contains the source of alarm (for example analogue input "A49"), the alarm message (for example "COOLANT T.") and the status of the alarm itself (for example HPA = high pre alarm).

Operation

Scroll from right to left to increase page number

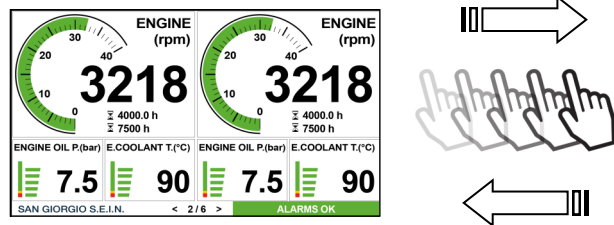

Scroll from right to left to decrease page number

The **alarm status panel** shows the current number of alarms : the colour test is **white** on a green background in case of no alarms and **white** on a red background in case of one or more active alarms.



The **page number** can be changed also using the two buttons in the control panel.

Day / night mode

The monitoring page is optimized for both day and night operation. The panel automatically adjust brightness and visual presentation.

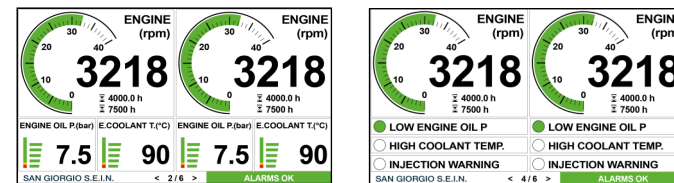

Day mode has maximum backlight brightness and draws gauges with white background and black fonts in order to enhance contrast and visibility in direct sunlight.

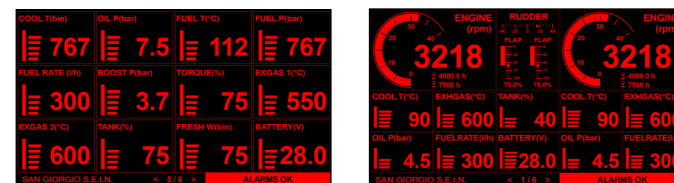

Night mode reduces display backlight brightness and draws gauges with black background and red font in order to avoid dazzling and help night vision adaptation.

Setup

As soon as you enter the settings you can customize the parameters of the following inputs / outputs:

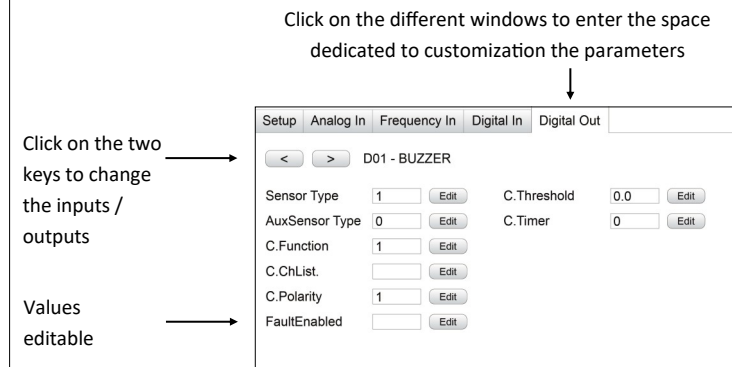
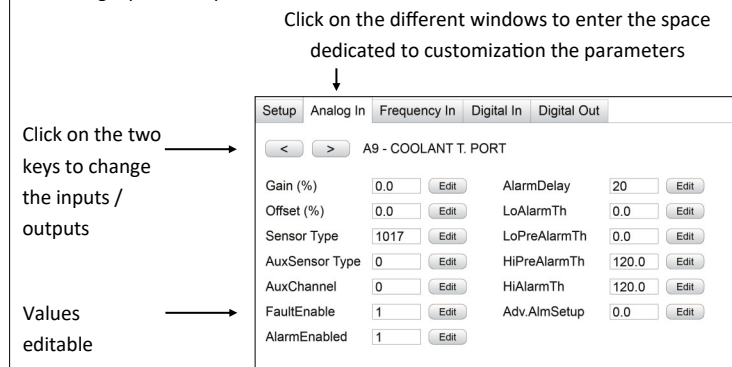

To save press the "Edit" button, enter the value and then press "Save".

To exit the "Setup" page you have to point your finger at the top or bottom of the screen and drag it down or up, this will close the settings page.

Notes to update firmware and configuration

- 1) Make sure that the files "UNS10193.s19" and/or "UNS10193.ini" are present on the USB drive respectively firmware and module configuration.
- 2) When the module is turned off insert the key into the USB port on the back.
- 3) Power up the module and wait until it restarts.
- 4) Disconnect the USB flash drive from the back.

Contacts

SAN GIORGIO S.E.I.N. s.r.l.
Via Pedullà 59 - 16165 Genova - Italy
Ph. +39 010 8301222
info@sangiorgiosein.com

Visit our website www.sangiorgiosein.com

You'll find more information about our products with additional technical features and download PDF documents



The information in this manual is believed to be accurate at the time of publication but no responsibility, direct or consequential, can be accepted for damage resulting from the use of this document.