



GLASSCRAFTERS INC.

2022 STANDARD MIRRORED CABINETS PRICE SHEETS

Price sheet includes, frameless and framed cabinets

Issued 6/1/22

GlassCrafters offers a non-beveled standard mirror or a 3/4" beveled mirror option for each of the five decorative framed styles. All cabinets feature rust-proof Satin Anodized aluminum construction. Each GlassCrafters' cabinet features Blum hinges and soft close cushions. All doors are precisely mitered eliminating plastic seals and vinyls. Decorative framed doors are manufactured with satin aluminum interior door frames to best complement our five decorative finishes. Surface mounted and semi-recessed cabinets require the purchase of side mirror kits.

CONTENTS

MIRRORED CABINET ACCESSORIES - page 1
ELECTRIC OPTION - pages 2, 3

FRAMELESS CABINETS

FRAMELESS FLAT MIRROR - pages 4-12
FRAMELESS BEVELED MIRROR - pages 4-12
FULL-LENGTH CABINETS - pages 11-12
TRI-VIEW CABINETS - page 13
VERTICAL TIER CABINETS - page 14

FRAMED CABINETS

DECO - pages 7-10
LEXINGTON - pages 4-12
PARK AVE - pages 4-12
SOHO - pages 7-10
TRINITY - pages 4-12

CABINET PARTS LIST - pages 15-17

CABINET ORDER FORM - page 30

BATH LIGHTING

CHELSEA ILLUMINATED FRAMELESS & FRAMED MIRRORS - pages 25, 26, 27
VERTICAL LED TASK LIGHTS - pages 28, 29

Note: Individual mirrored cabinet product specifications and installation instruction sheets are available for download at www.GlassCraftersMirroredCabinets.com.



GLASSCRAFTERS INC.

2022 STANDARD WALL MIRRORS PRICE SHEETS

Price sheet includes, frameless and framed wall mirrors

Issued 6/1/22

GlassCrafters offers decorative frameless and framed mirrors to compliment any design, Traditional, Contemporary or Transitional. The decorative wall mirrors include all the necessary installation hardware. Custom sizes available, consult GlassCrafters for size, price and availability.

CONTENTS

DECORATIVE FRAMELESS MIRRORS / CENTER MIRRORS

FLAT MIRRORS - pages 18, 19

ARCHED FLAT MIRRORS - pages 18, 19

BEVELED MIRRORS - pages 18, 19

ARCHED BEVELED MIRRORS - pages 18, 19

DECORATIVE FRAMED MIRRORS

DECO - pages 22, 23

LEXINGTON - pages 20-23

PARK AVE - pages 20-23

SOHO - pages 22, 23

TRINITY - pages 20-23

ACCESSORIES

CENTER MIRROR GLASS SHELF - page 24

MIRROR ORDER FORM - page 31

Note: Individual wall mirror product specifications and installation instruction sheets are available for download at www.GlassCraftersMirroredCabinets.com.

NEW **MIRRORED CABINET ACCESSORIES**

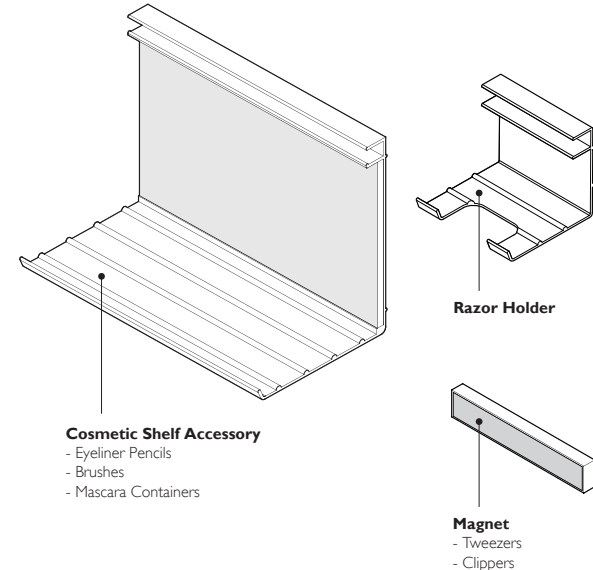
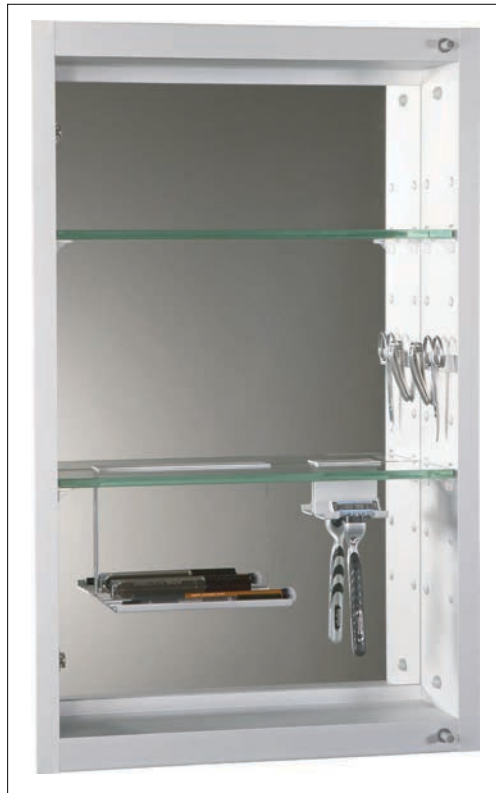

- Customized Storage
- Reduced Clutter
- Enhanced Functionality

GlassCrafters' mirrored cabinet storage accessories provide convenience and enhanced organization. Storage accessory kits combine a cosmetic shelf for neatly storing brushes and mascara containers, a razor holder, and a magnet for holding metal tweezers and clippers. Accessory kits come standard with GlassCrafters' 4" and 6" deep mirrored cabinet offerings, not including GlassCrafters' Full-Length mirrored cabinets.

GlassCrafters' Mirrored Cabinet Storage Accessories are included with the following 4" & 6" deep frameless and framed Mirrored Cabinets: GC1624, GC1630, GC1636, GC2030, GC2036, GC2430, GC2436, GC3630-TRI, GC3636-TRI, GC4830-TRI, and GC4836-TRI.

Note: Storage accessory kit model codes are GCMCA-04-01 for 4" deep cabinets and GCMCA-06-01 for 6" deep cabinets.

Note: Product specifications and installation instruction sheets for all product models are available for download at www.GlassCraftersMirroredCabinets.com.

MIRRORED CABINET ELECTRIC OPTION includes 3X Magnification Mirror Accessory

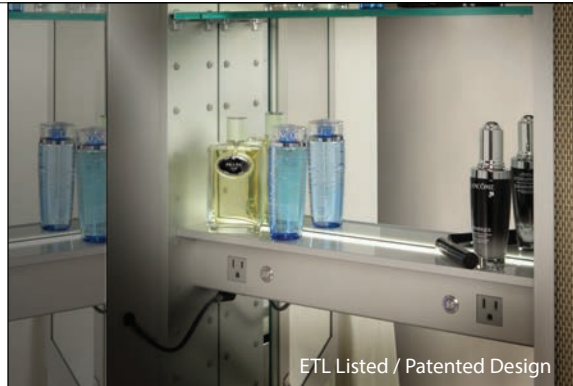

ELECTRIC option features:

- 2 Electrical AC Outlets
- Integral LED Light
- Heated Door Defogger
- Illuminated Indicator Switches

Available with the following 4" & 6" deep frameless and framed Mirrored Cabinets including:

GC1630, GC1636, GC2030, GC2036, GC2430, GC2436

Not currently available for GC1624, Tri-View, Full-Length or custom size cabinets.

Pricing: Based on the desired cabinet model, add an additional \$389.00 to the standard Mirrored Cabinet list price for total cost of cabinet with Electric Option.

All Mirrored Cabinets with the Electric Option come with a handed door available with left or right sided hinges. (Add "EL" or "ER" to model code)

Refer to GlassCrafters' Mirrored Cabinet Electric Option installation instructions for all electrical requirements prior to purchase. Installation instructions are available online at www.GlassCraftersMirroredCabinets.com and with the purchased cabinet. All wiring should be done by a qualified licensed electrician.

MIRRORED CABINETS with ELECTRIC OPTION includes 3X Magnification Mirror Accessory

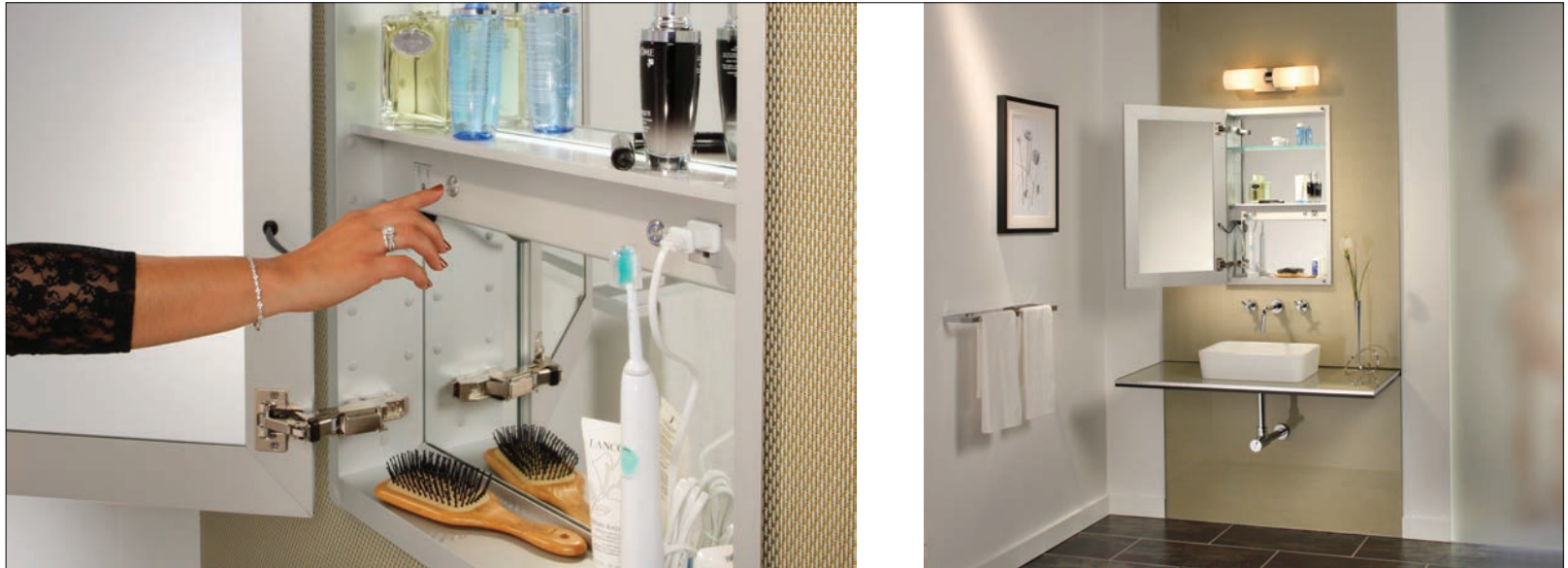

The above images feature GlassCrafters' GC2030-4-SC-BM-EL Mirrored Cabinet with Electric option and left side hinged door

EXAMPLE ORDERING NUMBER DETAILS	GC	20	30	—	4	—	SC	—	TR	—	BM	—	PC	—	EL*
		↓ Width	↓ Height		↓ Depth		↓ Cabinet Finish Satin Chrome		↓ Trinity Frame		↓ Beveled Mirror		↓ Polished Chrome Finish		↓ Electric Option with Left Side Hinged Door

Electric option is available with the following 4" & 6" deep frameless and framed Mirrored Cabinets including: GC1630, GC1636, GC2030, GC2036, GC2430, GC2436.

*For left or right sided door hinges, add "EL" or "ER" to model code.

All wiring should be done by a qualified licensed electrician in a manner that conforms to the National Electric code. For information concerning wiring requirements, see installation instructions prior to purchase.

DECORATIVE FINISHES



Plated Polished Chrome (PC)

[Plated - Polished / Mirror Like Finish]



Plated Polished Nickel (PN)

[Plated - Polished / Mirror Like Finish]

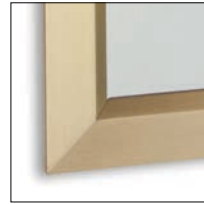

Satin Brass (SB)

[Satin Finish]



Brushed Nickel (BN)

[Brushed / Matte Finish]



Brushed Bronze (BB)

[Brushed / Matte Finish]



Iron-Black (IB)

[Powder Coated / Durable - Matte Finish]



Oil Rubbed Bronze (OR)

[Powder Coated / Durable - Matte Finish]

GC1624 16" Width x 24" Height 4" Depth - Rough Opening: 14 3/8" x 23 3/8"

	Overall Dimension Width x Height	Model	List Price					Electric Option (EL, ER)	Side Mirror Kit - Surface Mount	
			Frameless Mirror	SB, IB	PC, PN	BN, OR	BB			
FLAT MIRROR	15" x 24"	GC1624-4-SC-FM	\$593					N/A	SMK4-24	+ \$100
BEVELED MIRROR	15" x 24"	GC1624-4-SC-BM	\$662					N/A	SMK4-24	+ \$100
LEXINGTON	15 1/8" x 24 1/8"	GC1624-4-SC-LE		\$1,135	\$1,020	\$956	\$956	N/A	SMK4-24	+ \$100
LEXINGTON 3/4" BEVEL	15 1/8" x 24 1/8"	GC1624-4-SC-LE-BM		N/A	\$1,508	\$1,444	\$1,444	N/A	SMK4-24	+ \$100
PARK AVE	15 1/4" x 24 1/4"	GC1624-4-SC-PA		\$1,168	\$1,054	\$971	N/A	N/A	SMK4-24	+ \$100
PARK AVE 3/4" BEVEL	15 1/4" x 24 1/4"	GC1624-4-SC-PA-BM		N/A	\$1,541	\$1,459	N/A	N/A	SMK4-24	+ \$100
TRINITY	15 1/8" x 24 1/8"	GC1624-4-SC-TR		\$1,135	\$1,020	\$956	\$956	N/A	SMK4-24	+ \$100
TRINITY 3/4" BEVEL	15 1/8" x 24 1/8"	GC1624-4-SC-TR-BM		N/A	\$1,508	\$1,444	\$1,444	N/A	SMK4-24	+ \$100

Note: Product specifications and installation instruction sheets for all product models are available for download at www.GlassCraftersMirroredCabinets.com.

For custom size cabinet orders, please contact GlassCrafters Inc. directly at sales@glasscraftersinc.com concerning delivery times and pricing.

Electric Option is not currently available for custom size cabinets. All sales for custom size cabinets are final.



GLASSCRAFTERS INC.

2022 STANDARD MIRRORED CABINETS PRICE SHEETS

Price sheet includes, frameless and framed cabinets

Issued 6/1/22

GC1630 16" Width x 30" Height 4" Depth - Rough Opening: 14 3/8" x 29 3/8"

Add \$424.00 to list price for Electric Option. See pages 1 and 2 for more details.

	Overall Dimension Width x Height	Model	Frameless Mirror	List Price					Electric Option (EL, ER)	Side Mirror Kit - Surface Mount	
				SB, IB	PC, PN	BN, OR	BB				
FLAT MIRROR	15" x 30"	GC1630-4-SC-FM	\$692						\$424	SMK4-30	+ \$100
BEVELED MIRROR	15" x 30"	GC1630-4-SC-BM	\$742						\$424	SMK4-30	+ \$100
LEXINGTON	15 1/8" x 30 1/8"	GC1630-4-SC-LE		\$1,261	\$1,147	\$1,074	\$1,074	\$424		SMK4-30	+ \$100
LEXINGTON 3/4" BEVEL	15 1/8" x 30 1/8"	GC1630-4-SC-LE-BM		N/A	\$1,637	\$1,564	\$1,564	\$424		SMK4-30	+ \$100
PARK AVE	15 1/4" x 30 1/4"	GC1630-4-SC-PA		\$1,300	\$1,186	\$1,091	N/A	\$424		SMK4-30	+ \$100
PARK AVE 3/4" BEVEL	15 1/4" x 30 1/4"	GC1630-4-SC-PA-BM		N/A	\$1,676	\$1,581	N/A	\$424		SMK4-30	+ \$100
TRINITY	15 1/8" x 30 1/8"	GC1630-4-SC-TR		\$1,261	\$1,147	\$1,074	\$1,074	\$424		SMK4-30	+ \$100
TRINITY 3/4" BEVEL	15 1/8" x 30 1/8"	GC1630-4-SC-TR-BM		N/A	\$1,637	\$1,564	\$1,564	\$424		SMK4-30	+ \$100

GC1630 16" Width x 30" Height 6" Depth - Rough Opening: 14 3/8" x 29 3/8"

Add \$424.00 to list price for Electric Option. See pages 1 and 2 for more details.

	Overall Dimension Width x Height	Model	Frameless Mirror	List Price					Electric Option (EL, ER)	Side Mirror Kit - Semi Recessed / Surface Mount	
				SB, IB	PC, PN	BN, OR	BB				
FLAT MIRROR	15" x 30"	GC1630-6-SC-FM	\$1,067						\$424	SRMK2-30 / SMK6-30	+ \$100
BEVELED MIRROR	15" x 30"	GC1630-6-SC-BM	\$1,109						\$424	SRMK2-30 / SMK6-30	+ \$100
LEXINGTON	15 1/8" x 30 1/8"	GC1630-6-SC-LE		\$1,636	\$1,522	\$1,449	\$1,449	\$424		SRMK2-30 / SMK6-30	+ \$100
LEXINGTON 3/4" BEVEL	15 1/8" x 30 1/8"	GC1630-6-SC-LE-BM		N/A	\$2,005	\$1,932	\$1,932	\$424		SRMK2-30 / SMK6-30	+ \$100
PARK AVE	15 1/4" x 30 1/4"	GC1630-6-SC-PA		\$1,675	\$1,561	\$1,466	N/A	\$424		SRMK2-30 / SMK6-30	+ \$100
PARK AVE 3/4" BEVEL	15 1/4" x 30 1/4"	GC1630-6-SC-PA-BM		N/A	\$2,044	\$1,949	N/A	\$424		SRMK2-30 / SMK6-30	+ \$100
TRINITY	15 1/8" x 30 1/8"	GC1630-6-SC-TR		\$1,636	\$1,522	\$1,449	\$1,449	\$424		SRMK2-30 / SMK6-30	+ \$100
TRINITY 3/4" BEVEL	15 1/8" x 30 1/8"	GC1630-6-SC-TR-BM		N/A	\$2,005	\$1,932	\$1,932	\$424		SRMK2-30 / SMK6-30	+ \$100

Note: Product specifications and installation instruction sheets for all product models are available for download at www.GlassCraftersMirroredCabinets.com.

For custom size cabinet orders, please contact GlassCrafters Inc. directly at sales@glasscraftersinc.com concerning delivery times and pricing.

Electric Option is not currently available for custom size cabinets. All sales for custom size cabinets are final.



GLASSCRAFTERS INC.

2022 STANDARD MIRRORED CABINETS PRICE SHEETS

Price sheet includes, frameless and framed cabinets

Issued 6/1/22

GC1636 16" Width x 36" Height 4" Depth - Rough Opening: 14 3/8" x 35 3/8"

Add \$424.00 to list price for Electric Option. See pages 1 and 2 for more details.

	Overall Dimension Width x Height	Model	Frameless Mirror	List Price					Electric Option (EL, ER)	Side Mirror Kit - Surface Mount	
				SB, IB	PC, PN	BN, OR	BB				
FLAT MIRROR	15" x 36"	GC1636-4-SC-FM	\$820						\$424	SMK4-36	+ \$110
BEVELED MIRROR	15" x 36"	GC1636-4-SC-BM	\$869						\$424	SMK4-36	+ \$110
LEXINGTON	15 1/8" x 36 1/8"	GC1636-4-SC-LE		\$1,417	\$1,303	\$1,220	\$1,220		\$424	SMK4-36	+ \$110
LEXINGTON 3/4" BEVEL	15 1/8" x 36 1/8"	GC1636-4-SC-LE-BM		N/A	\$1,791	\$1,709	\$1,709		\$424	SMK4-36	+ \$110
PARK AVE	15 1/4" x 36 1/4"	GC1636-4-SC-PA		\$1,462	\$1,347	\$1,240	N/A		\$424	SMK4-36	+ \$110
PARK AVE 3/4" BEVEL	15 1/4" x 36 1/4"	GC1636-4-SC-PA-BM		N/A	\$1,836	\$1,728	N/A		\$424	SMK4-36	+ \$110
TRINITY	15 1/8" x 36 1/8"	GC1636-4-SC-TR		\$1,417	\$1,303	\$1,220	\$1,220		\$424	SMK4-36	+ \$110
TRINITY 3/4" BEVEL	15 1/8" x 36 1/8"	GC1636-4-SC-TR-BM		N/A	\$1,791	\$1,709	\$1,709		\$424	SMK4-36	+ \$110

GC1636 16" Width x 36" Height 6" Depth - Rough Opening: 14 3/8" x 35 3/8"

Add \$424.00 to list price for Electric Option. See pages 1 and 2 for more details.

	Overall Dimension Width x Height	Model	Frameless Mirror	List Price					Electric Option (EL, ER)	Side Mirror Kit - Semi Recessed / Surface Mount	
				SB, IB	PC, PN	BN, OR	BB				
FLAT MIRROR	15" x 36"	GC1636-6-SC-FM	\$1,197						\$424	SRMK2-36 / SMK6-36	+ \$110
BEVELED MIRROR	15" x 36"	GC1636-6-SC-BM	\$1,244						\$424	SRMK2-36 / SMK6-36	+ \$110
LEXINGTON	15 1/8" x 36 1/8"	GC1636-6-SC-LE		\$1,793	\$1,679	\$1,597	\$1,597		\$424	SRMK2-36 / SMK6-36	+ \$110
LEXINGTON 3/4" BEVEL	15 1/8" x 36 1/8"	GC1636-6-SC-LE-BM		N/A	\$2,166	\$2,084	\$2,084		\$424	SRMK2-36 / SMK6-36	+ \$110
PARK AVE	15 1/4" x 36 1/4"	GC1636-6-SC-PA		\$1,838	\$1,724	\$1,616	N/A		\$424	SRMK2-36 / SMK6-36	+ \$110
PARK AVE 3/4" BEVEL	15 1/4" x 36 1/4"	GC1636-6-SC-PA-BM		N/A	\$2,211	\$2,104	N/A		\$424	SRMK2-36 / SMK6-36	+ \$110
TRINITY	15 1/8" x 36 1/8"	GC1636-6-SC-TR		\$1,793	\$1,679	\$1,597	\$1,597		\$424	SRMK2-36 / SMK6-36	+ \$110
TRINITY 3/4" BEVEL	15 1/8" x 36 1/8"	GC1636-6-SC-TR-BM		N/A	\$2,166	\$2,084	\$2,084		\$424	SRMK2-36 / SMK6-36	+ \$110

Note: Product specifications and installation instruction sheets for all product models are available for download at www.GlassCraftersMirroredCabinets.com.

For custom size cabinet orders, please contact GlassCrafters Inc. directly at sales@glasscraftersinc.com concerning delivery times and pricing.

Electric Option is not currently available for custom size cabinets. All sales for custom size cabinets are final.



2022 STANDARD MIRRORED CABINETS PRICE SHEETS

Price sheet includes, frameless and framed cabinets

Issued 6/1/22

GC2030 20" Width x 30" Height 4" Depth - Rough Opening: 18 3/8" x 29 3/8"

Add \$424.00 to list price for Electric Option. See pages 1 and 2 for more details.

	Overall Dimension Width x Height	Model	Frameless Mirror	List Price					Electric Option (EL, ER)	Side Mirror Kit - Surface Mount	
				SB, IB	PC, PN	BN, OR	BB				
FLAT MIRROR	19" x 30"	GC2030-4-SC-FM	\$744						\$424	SMK4-30	+ \$100
BEVELED MIRROR	19" x 30"	GC2030-4-SC-BM	\$794						\$424	SMK4-30	+ \$100
DECO	19 1/8" x 30 1/8"	GC2030-4-SC-DE		N/A	\$1,260	\$1,157	\$1,157		\$424	SMK4-30	+ \$100
DECO 3/4" BEVEL	19 1/8" x 30 1/8"	GC2030-4-SC-DE-BM		N/A	\$1,749	\$1,647	\$1,647		\$424	SMK4-30	+ \$100
LEXINGTON	19 1/8" x 30 1/8"	GC2030-4-SC-LE		\$1,332	\$1,217	\$1,139	\$1,139		\$424	SMK4-30	+ \$100
LEXINGTON 3/4" BEVEL	19 1/8" x 30 1/8"	GC2030-4-SC-LE-BM		N/A	\$1,707	\$1,628	\$1,628		\$424	SMK4-30	+ \$100
PARK AVE	19 1/4" x 30 1/4"	GC2030-4-SC-PA		\$1,374	\$1,260	\$1,157	N/A		\$424	SMK4-30	+ \$100
PARK AVE 3/4" BEVEL	19 1/4" x 30 1/4"	GC2030-4-SC-PA-BM		N/A	\$1,749	\$1,647	N/A		\$424	SMK4-30	+ \$100
SOHO	19 1/8" x 30 1/8"	GC2030-4-SC-SO		N/A	\$1,260	\$1,157	\$1,157		\$424	SMK4-30	+ \$100
SOHO 3/4" BEVEL	19 1/8" x 30 1/8"	GC2030-4-SC-SO-BM		N/A	\$1,749	\$1,647	\$1,647		\$424	SMK4-30	+ \$100
TRINITY	19 1/8" x 30 1/8"	GC2030-4-SC-TR		\$1,332	\$1,217	\$1,139	\$1,139		\$424	SMK4-30	+ \$100
TRINITY 3/4" BEVEL	19 1/8" x 30 1/8"	GC2030-4-SC-TR-BM		N/A	\$1,707	\$1,628	\$1,628		\$424	SMK4-30	+ \$100

GC2030 20" Width x 30" Height 6" Depth - Rough Opening: 18 3/8" x 29 3/8"

Add \$424.00 to list price for Electric Option. See pages 1 and 2 for more details.

	Overall Dimension Width x Height	Model	Frameless Mirror	List Price					Electric Option (EL, ER)	Side Mirror Kit - Semi Recessed / Surface Mount	
				SB, IB	PC, PN	BN, OR	BB				
FLAT MIRROR	19" x 30"	GC2030-6-SC-FM	\$1,120						\$424	SRMK2-30 / SMK6-30	+ \$100
BEVELED MIRROR	19" x 30"	GC2030-6-SC-BM	\$1,170						\$424	SRMK2-30 / SMK6-30	+ \$100
DECO	19 1/8" x 30 1/8"	GC2030-6-SC-DE		N/A	\$1,636	\$1,533	\$1,533		\$424	SRMK2-30 / SMK6-30	+ \$100
DECO 3/4" BEVEL	19 1/8" x 30 1/8"	GC2030-6-SC-DE-BM		N/A	\$2,126	\$2,023	\$2,023		\$424	SRMK2-30 / SMK6-30	+ \$100
LEXINGTON	19 1/8" x 30 1/8"	GC2030-6-SC-LE		\$1,708	\$1,594	\$1,515	\$1,515		\$424	SRMK2-30 / SMK6-30	+ \$100
LEXINGTON 3/4" BEVEL	19 1/8" x 30 1/8"	GC2030-6-SC-LE-BM		N/A	\$2,083	\$2,005	\$2,005		\$424	SRMK2-30 / SMK6-30	+ \$100
PARK AVE	19 1/4" x 30 1/4"	GC2030-6-SC-PA		\$1,750	\$1,636	\$1,533	N/A		\$424	SRMK2-30 / SMK6-30	+ \$100
PARK AVE 3/4" BEVEL	19 1/4" x 30 1/4"	GC2030-6-SC-PA-BM		N/A	\$2,126	\$2,023	N/A		\$424	SRMK2-30 / SMK6-30	+ \$100
SOHO	19 1/8" x 30 1/8"	GC2030-6-SC-SO		N/A	\$1,636	\$1,533	\$1,533		\$424	SRMK2-30 / SMK6-30	+ \$100
SOHO 3/4" BEVEL	19 1/8" x 30 1/8"	GC2030-6-SC-SO-BM		N/A	\$2,126	\$2,023	\$2,023		\$424	SRMK2-30 / SMK6-30	+ \$100
TRINITY	19 1/8" x 30 1/8"	GC2030-6-SC-TR		\$1,708	\$1,594	\$1,515	\$1,515		\$424	SRMK2-30 / SMK6-30	+ \$100
TRINITY 3/4" BEVEL	19 1/8" x 30 1/8"	GC2030-6-SC-TR-BM		N/A	\$2,083	\$2,005	\$2,005		\$424	SRMK2-30 / SMK6-30	+ \$100

Note: Product specifications and installation instruction sheets for all product models are available for download at www.GlassCraftersMirroredCabinets.com.

For custom size cabinet orders, please contact GlassCrafters Inc. directly at sales@glasscraftersinc.com concerning delivery times and pricing.

Electric Option is not currently available for custom size cabinets. All sales for custom size cabinets are final.



GLASSCRAFTERS INC.

2022 STANDARD MIRRORED CABINETS PRICE SHEETS

Price sheet includes, frameless and framed cabinets

Issued 6/1/22

GC2036 20" Width x 36" Height 4" Depth - Rough Opening: 18 3/8" x 35 3/8"

Add \$424.00 to list price for Electric Option. See pages 1 and 2 for more details.

	Overall Dimension Width x Height	Model	Frameless Mirror	List Price					Electric Option (EL, ER)	Side Mirror Kit - Surface Mount	
				SB, IB	PC, PN	BN, OR	BB				
FLAT MIRROR	19" x 36"	GC2036-4-SC-FM	\$872						\$424	SMK4-36	+ \$110
BEVELED MIRROR	19" x 36"	GC2036-4-SC-BM	\$921						\$424	SMK4-36	+ \$110
DECO	19 1/8" x 36 1/8"	GC2036-4-SC-DE		N/A	\$1,421	\$1,306	\$1,306		\$424	SMK4-36	+ \$110
DECO 3/4" BEVEL	19 1/8" x 36 1/8"	GC2036-4-SC-DE-BM		N/A	\$1,910	\$1,794	\$1,794		\$424	SMK4-36	+ \$110
LEXINGTON	19 1/8" x 36 1/8"	GC2036-4-SC-LE		\$1,487	\$1,373	\$1,285	\$1,285		\$424	SMK4-36	+ \$110
LEXINGTON 3/4" BEVEL	19 1/8" x 36 1/8"	GC2036-4-SC-LE-BM		N/A	\$1,862	\$1,774	\$1,774		\$424	SMK4-36	+ \$110
PARK AVE	19 1/4" x 36 1/4"	GC2036-4-SC-PA		\$1,535	\$1,421	\$1,306	N/A		\$424	SMK4-36	+ \$110
PARK AVE 3/4" BEVEL	19 1/4" x 36 1/4"	GC2036-4-SC-PA-BM		N/A	\$1,910	\$1,794	N/A		\$424	SMK4-36	+ \$110
SOHO	19 1/8" x 36 1/8"	GC2036-4-SC-SO		N/A	\$1,421	\$1,306	\$1,306		\$424	SMK4-36	+ \$110
SOHO 3/4" BEVEL	19 1/8" x 36 1/8"	GC2036-4-SC-SO-BM		N/A	\$1,910	\$1,794	\$1,794		\$424	SMK4-36	+ \$110
TRINITY	19 1/8" x 36 1/8"	GC2036-4-SC-TR		\$1,487	\$1,373	\$1,285	\$1,285		\$424	SMK4-36	+ \$110
TRINITY 3/4" BEVEL	19 1/8" x 36 1/8"	GC2036-4-SC-TR-BM		N/A	\$1,862	\$1,774	\$1,774		\$424	SMK4-36	+ \$110

GC2036 20" Width x 36" Height 6" Depth - Rough Opening: 18 3/8" x 35 3/8"

Add \$424.00 to list price for Electric Option. See pages 1 and 2 for more details.

	Overall Dimension Width x Height	Model	Frameless Mirror	List Price					Electric Option (EL, ER)	Side Mirror Kit - Semi Recessed / Surface Mount	
				SB, IB	PC, PN	BN, OR	BB				
FLAT MIRROR	19" x 36"	GC2036-6-SC-FM	\$1,249						\$424	SRMK2-36 / SMK6-36	+ \$110
BEVELED MIRROR	19" x 36"	GC2036-6-SC-BM	\$1,297						\$424	SRMK2-36 / SMK6-36	+ \$110
DECO	19 1/8" x 36 1/8"	GC2036-6-SC-DE		N/A	\$1,797	\$1,682	\$1,682		\$424	SRMK2-36 / SMK6-36	+ \$110
DECO 3/4" BEVEL	19 1/8" x 36 1/8"	GC2036-6-SC-DE-BM		N/A	\$2,286	\$2,170	\$2,170		\$424	SRMK2-36 / SMK6-36	+ \$110
LEXINGTON	19 1/8" x 36 1/8"	GC2036-6-SC-LE		\$1,864	\$1,749	\$1,661	\$1,661		\$424	SRMK2-36 / SMK6-36	+ \$110
LEXINGTON 3/4" BEVEL	19 1/8" x 36 1/8"	GC2036-6-SC-LE-BM		N/A	\$2,238	\$2,150	\$2,150		\$424	SRMK2-36 / SMK6-36	+ \$110
PARK AVE	19 1/4" x 36 1/4"	GC2036-6-SC-PA		\$1,912	\$1,797	\$1,682	N/A		\$424	SRMK2-36 / SMK6-36	+ \$110
PARK AVE 3/4" BEVEL	19 1/4" x 36 1/4"	GC2036-6-SC-PA-BM		N/A	\$2,286	\$2,170	N/A		\$424	SRMK2-36 / SMK6-36	+ \$110
SOHO	19 1/8" x 36 1/8"	GC2036-6-SC-SO		N/A	\$1,797	\$1,682	\$1,682		\$424	SRMK2-36 / SMK6-36	+ \$110
SOHO 3/4" BEVEL	19 1/8" x 36 1/8"	GC2036-6-SC-SO-BM		N/A	\$2,286	\$2,170	\$2,170		\$424	SRMK2-36 / SMK6-36	+ \$110
TRINITY	19 1/8" x 36 1/8"	GC2036-6-SC-TR		\$1,864	\$1,749	\$1,661	\$1,661		\$424	SRMK2-36 / SMK6-36	+ \$110
TRINITY 3/4" BEVEL	19 1/8" x 36 1/8"	GC2036-6-SC-TR-BM		N/A	\$2,238	\$2,150	\$2,150		\$424	SRMK2-36 / SMK6-36	+ \$110

Note: Product specifications and installation instruction sheets for all product models are available for download at www.GlassCraftersMirroredCabinets.com.

For custom size cabinet orders, please contact GlassCrafters Inc. directly at sales@glasscraftersinc.com concerning delivery times and pricing.

Electric Option is not currently available for custom size cabinets. All sales for custom size cabinets are final.



GLASSCRAFTERS INC.

2022 STANDARD MIRRORED CABINETS PRICE SHEETS

Price sheet includes, frameless and framed cabinets

Issued 6/1/22

GC2430 24" Width x 30" Height 4" Depth - Rough Opening: 22 3/8" x 29 3/8"

Add \$424.00 to list price for Electric Option. See pages 1 and 2 for more details.

	Overall Dimension Width x Height	Model	Frameless Mirror	List Price				Electric Option (EL, ER)	Side Mirror Kit - Surface Mount	
				SB, IB	PC, PN	BN, OR	BB			
FLAT MIRROR	23" x 30"	GC2430-4-SC-FM	\$823					\$424	SMK4-30	+ \$100
BEVELED MIRROR	23" x 30"	GC2430-4-SC-BM	\$875					\$424	SMK4-30	+ \$100
DECO	23 1/8" x 30 1/8"	GC2430-4-SC-DE		N/A	\$1,360	\$1,249	\$1,249	\$424	SMK4-30	+ \$100
DECO 3/4" BEVEL	23 1/8" x 30 1/8"	GC2430-4-SC-DE-BM		N/A	\$1,852	\$1,741	\$1,741	\$424	SMK4-30	+ \$100
LEXINGTON	23 1/8" x 30 1/8"	GC2430-4-SC-LE		\$1,429	\$1,314	\$1,230	\$1,230	\$424	SMK4-30	+ \$100
LEXINGTON 3/4" BEVEL	23 1/8" x 30 1/8"	GC2430-4-SC-LE-BM		N/A	\$1,807	\$1,722	\$1,722	\$424	SMK4-30	+ \$100
PARK AVE	23 1/4" x 30 1/4"	GC2430-4-SC-PA		\$1,474	\$1,360	\$1,249	N/A	\$424	SMK4-30	+ \$100
PARK AVE 3/4" BEVEL	23 1/4" x 30 1/4"	GC2430-4-SC-PA-BM		N/A	\$1,852	\$1,741	N/A	\$424	SMK4-30	+ \$100
SOHO	23 1/8" x 30 1/8"	GC2430-4-SC-SO		N/A	\$1,360	\$1,249	\$1,249	\$424	SMK4-30	+ \$100
SOHO 3/4" BEVEL	23 1/8" x 30 1/8"	GC2430-4-SC-SO-BM		N/A	\$1,852	\$1,741	\$1,741	\$424	SMK4-30	+ \$100
TRINITY	23 1/8" x 30 1/8"	GC2430-4-SC-TR		\$1,429	\$1,314	\$1,230	\$1,230	\$424	SMK4-30	+ \$100
TRINITY 3/4" BEVEL	23 1/8" x 30 1/8"	GC2430-4-SC-TR-BM		N/A	\$1,807	\$1,722	\$1,722	\$424	SMK4-30	+ \$100

GC2430 24" Width x 30" Height 6" Depth - Rough Opening: 22 3/8" x 29 3/8"

Add \$424.00 to list price for Electric Option. See pages 1 and 2 for more details.

	Overall Dimension Width x Height	Model	Frameless Mirror	List Price				Electric Option (EL, ER)	Side Mirror Kit - Semi Recessed / Surface Mount	
				SB, IB	PC, PN	BN, OR	BB			
FLAT MIRROR	23" x 30"	GC2430-6-SC-FM	\$1,199					\$424	SRMK2-30 / SMK6-30	+ \$100
BEVELED MIRROR	23" x 30"	GC2430-6-SC-BM	\$1,251					\$424	SRMK2-30 / SMK6-30	+ \$100
DECO	23 1/8" x 30 1/8"	GC2430-6-SC-DE		N/A	\$1,736	\$1,625	\$1,625	\$424	SRMK2-30 / SMK6-30	+ \$100
DECO 3/4" BEVEL	23 1/8" x 30 1/8"	GC2430-6-SC-DE-BM		N/A	\$2,229	\$2,118	\$2,118	\$424	SRMK2-30 / SMK6-30	+ \$100
LEXINGTON	23 1/8" x 30 1/8"	GC2430-6-SC-LE		\$1,805	\$1,691	\$1,606	\$1,606	\$424	SRMK2-30 / SMK6-30	+ \$100
LEXINGTON 3/4" BEVEL	23 1/8" x 30 1/8"	GC2430-6-SC-LE-BM		N/A	\$2,183	\$2,098	\$2,098	\$424	SRMK2-30 / SMK6-30	+ \$100
PARK AVE	23 1/4" x 30 1/4"	GC2430-6-SC-PA		\$1,851	\$1,736	\$1,625	N/A	\$424	SRMK2-30 / SMK6-30	+ \$100
PARK AVE 3/4" BEVEL	23 1/4" x 30 1/4"	GC2430-6-SC-PA-BM		N/A	\$2,229	\$2,118	N/A	\$424	SRMK2-30 / SMK6-30	+ \$100
SOHO	23 1/8" x 30 1/8"	GC2430-6-SC-SO		N/A	\$1,736	\$1,625	\$1,625	\$424	SRMK2-30 / SMK6-30	+ \$100
SOHO 3/4" BEVEL	23 1/8" x 30 1/8"	GC2430-6-SC-SO-BM		N/A	\$2,229	\$2,118	\$2,118	\$424	SRMK2-30 / SMK6-30	+ \$100
TRINITY	23 1/8" x 30 1/8"	GC2430-6-SC-TR		\$1,805	\$1,691	\$1,606	\$1,606	\$424	SRMK2-30 / SMK6-30	+ \$100
TRINITY 3/4" BEVEL	23 1/8" x 30 1/8"	GC2430-6-SC-TR-BM		N/A	\$2,183	\$2,098	\$2,098	\$424	SRMK2-30 / SMK6-30	+ \$100

Note: Product specifications and installation instruction sheets for all product models are available for download at www.GlassCraftersMirroredCabinets.com.

For custom size cabinet orders, please contact GlassCrafters Inc. directly at sales@glasscraftersinc.com concerning delivery times and pricing.

Electric Option is not currently available for custom size cabinets. All sales for custom size cabinets are final.



GLASSCRAFTERS INC.

2022 STANDARD MIRRORED CABINETS PRICE SHEETS

Price sheet includes, frameless and framed cabinets

Issued 6/1/22

GC2436 24" Width x 36" Height 4" Depth - Rough Opening: 22 3/8" x 35 3/8"

Add \$424.00 to list price for Electric Option. See pages 1 and 2 for more details.

	Overall Dimension Width x Height	Model	Frameless Mirror	List Price					Electric Option (EL, ER)	Side Mirror Kit - Surface Mount	
				SB, IB	PC, PN	BN, OR	BB				
FLAT MIRROR	23" x 36"	GC2436-4-SC-FM	\$952						\$424	SMK4-36	+ \$110
BEVELED MIRROR	23" x 36"	GC2436-4-SC-BM	\$1,004						\$424	SMK4-36	+ \$110
DECO	23 1/8" x 36 1/8"	GC2436-4-SC-DE		N/A	\$1,523	\$1,399	\$1,399		\$424	SMK4-36	+ \$110
DECO 3/4" BEVEL	23 1/8" x 36 1/8"	GC2436-4-SC-DE-BM		N/A	\$2,015	\$1,891	\$1,891		\$424	SMK4-36	+ \$110
LEXINGTON	23 1/8" x 36 1/8"	GC2436-4-SC-LE		\$1,586	\$1,471	\$1,376	\$1,376		\$424	SMK4-36	+ \$110
LEXINGTON 3/4" BEVEL	23 1/8" x 36 1/8"	GC2436-4-SC-LE-BM		N/A	\$1,963	\$1,869	\$1,869		\$424	SMK4-36	+ \$110
PARK AVE	23 1/4" x 36 1/4"	GC2436-4-SC-PA		\$1,637	\$1,523	\$1,399	N/A		\$424	SMK4-36	+ \$110
PARK AVE 3/4" BEVEL	23 1/4" x 36 1/4"	GC2436-4-SC-PA-BM		N/A	\$2,015	\$1,891	N/A		\$424	SMK4-36	+ \$110
SOHO	23 1/8" x 36 1/8"	GC2436-4-SC-SO		N/A	\$1,523	\$1,399	\$1,399		\$424	SMK4-36	+ \$110
SOHO 3/4" BEVEL	23 1/8" x 36 1/8"	GC2436-4-SC-SO-BM		N/A	\$2,015	\$1,891	\$1,891		\$424	SMK4-36	+ \$110
TRINITY	23 1/8" x 36 1/8"	GC2436-4-SC-TR		\$1,586	\$1,471	\$1,376	\$1,376		\$424	SMK4-36	+ \$110
TRINITY 3/4" BEVEL	23 1/8" x 36 1/8"	GC2436-4-SC-TR-BM		N/A	\$1,963	\$1,869	\$1,869		\$424	SMK4-36	+ \$110

GC2436 24" Width x 36" Height 6" Depth - Rough Opening: 22 3/8" x 35 3/8"

Add \$424.00 to list price for Electric Option. See pages 1 and 2 for more details.

	Overall Dimension Width x Height	Model	Frameless Mirror	List Price					Electric Option (EL, ER)	Side Mirror Kit - Semi Recessed / Surface Mount	
				SB, IB	PC, PN	BN, OR	BB				
FLAT MIRROR	23" x 36"	GC2436-6-SC-FM	\$1,327						\$424	SRMK2-36 / SMK6-36	+ \$110
BEVELED MIRROR	23" x 36"	GC2436-6-SC-BM	\$1,380						\$424	SRMK2-36 / SMK6-36	+ \$110
DECO	23 1/8" x 36 1/8"	GC2436-6-SC-DE		N/A	\$1,898	\$1,774	\$1,774		\$424	SRMK2-36 / SMK6-36	+ \$110
DECO 3/4" BEVEL	23 1/8" x 36 1/8"	GC2436-6-SC-DE-BM		N/A	\$2,391	\$2,268	\$2,268		\$424	SRMK2-36 / SMK6-36	+ \$110
LEXINGTON	23 1/8" x 36 1/8"	GC2436-6-SC-LE		\$1,961	\$1,846	\$1,751	\$1,751		\$424	SRMK2-36 / SMK6-36	+ \$110
LEXINGTON 3/4" BEVEL	23 1/8" x 36 1/8"	GC2436-6-SC-LE-BM		N/A	\$2,340	\$2,245	\$2,245		\$424	SRMK2-36 / SMK6-36	+ \$110
PARK AVE	23 1/4" x 36 1/4"	GC2436-6-SC-PA		\$2,012	\$1,898	\$1,774	N/A		\$424	SRMK2-36 / SMK6-36	+ \$110
PARK AVE 3/4" BEVEL	23 1/4" x 36 1/4"	GC2436-6-SC-PA-BM		N/A	\$2,391	\$2,268	N/A		\$424	SRMK2-36 / SMK6-36	+ \$110
SOHO	23 1/8" x 36 1/8"	GC2436-6-SC-SO		N/A	\$1,898	\$1,774	\$1,774		\$424	SRMK2-36 / SMK6-36	+ \$110
SOHO 3/4" BEVEL	23 1/8" x 36 1/8"	GC2436-6-SC-SO-BM		N/A	\$2,391	\$2,268	\$2,268		\$424	SRMK2-36 / SMK6-36	+ \$110
TRINITY	23 1/8" x 36 1/8"	GC2436-6-SC-TR		\$1,961	\$1,846	\$1,751	\$1,751		\$424	SRMK2-36 / SMK6-36	+ \$110
TRINITY 3/4" BEVEL	23 1/8" x 36 1/8"	GC2436-6-SC-TR-BM		N/A	\$2,340	\$2,245	\$2,245		\$424	SRMK2-36 / SMK6-36	+ \$110

Note: Product specifications and installation instruction sheets for all product models are available for download at www.GlassCraftersMirroredCabinets.com.

For custom size cabinet orders, please contact GlassCrafters Inc. directly at sales@glasscraftersinc.com concerning delivery times and pricing.

Electric Option is not currently available for custom size cabinets. All sales for custom size cabinets are final.

2022 STANDARD MIRRORED CABINETS PRICE SHEETS

Price sheet includes, frameless and framed cabinets

Issued 6/1/22

DECORATIVE FINISHES



Plated Polished
Chrome (PC)



Plated Polished
Nickel (PN)

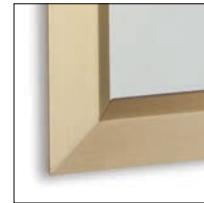

Satin Brass (SB)



Brushed Nickel (BN)



Iron-Black (IB)

[Plated - Polished / Mirror Like Finish]

[Satin Finish]

[Brushed / Matte Finish]

[Powder Coated /
Durable - Matte Finish]

Full-Length Cabinet GC1672 16" Width x 72" Height 4" Depth - Rough Opening: 14 3/8" x 72 1/8"

	Overall Dimension Width x Height	Model	Frameless Mirror	List Price			Electric Option (EL, ER)	Side Mirror Kit - Semi Recessed / Surface Mount	
				SB	PC, PN	BN, IB			
FLAT MIRROR	15" x 72"	GC1672-4-SC-FM*	\$2,130				N/A	SMK4-72	+ \$300
BEVELED MIRROR	15" x 72"	GC1672-4-SC-BM*	\$2,170				N/A	SMK4-72	+ \$300
LEXINGTON	15 1/8" x 72 1/8"	GC1672-4-SC-LE*		\$2,855	\$2,945	\$2,805	N/A	SMK4-72	+ \$300
PARK AVE	15 1/4" x 72 1/4"	GC1672-4-SC-PA*		\$2,940	\$3,020	\$2,840	N/A	SMK4-72	+ \$300
TRINITY	15 1/8" x 72 1/8"	GC1672-4-SC-TR*		\$2,855	\$2,945	\$2,805	N/A	SMK4-72	+ \$300

* Handed door is available with left or right side hinges. Add "L" or "R" to end of model code.

Note: Product specifications and installation instruction sheets for all product models are available for download at www.GlassCraftersMirroredCabinets.com.

Full-Length handle accessory comes standard with frameless cabinet only. For custom size cabinet orders, please contact

GlassCrafters Inc. directly at sales@glasscraftersinc.com concerning delivery times and pricing. All sales for custom size cabinets are final.



Electric Option currently not available for this unit

2022 STANDARD MIRRORED CABINETS PRICE SHEETS

Price sheet includes, frameless and framed cabinets

Issued 6/1/22

Full-Length Cabinet GC1672 16" Width x 72" Height 6" Depth - Rough Opening: 14 3/8" x 72 1/8"

	Overall Dimension Width x Height	Model	List Price				Electric Option (EL, ER)	Side Mirror Kit - Semi Recessed / Surface Mount	
			Frameless Mirror	SB	PC, PN	BN, IB			
FLAT MIRROR	15" x 72"	GC1672-6-SC-FM*	\$2,245				N/A	SRMK2-72 / SMK6-72	+ \$300 / + \$350
BEVELED MIRROR	15" x 72"	GC1672-6-SC-BM*	\$2,290				N/A	SRMK2-72 / SMK6-72	+ \$300 / + \$350
LEXINGTON	15 1/8" x 72 1/8"	GC1672-6-SC-LE*		\$2,975	\$3,060	\$2,925	N/A	SRMK2-72 / SMK6-72	+ \$300 / + \$350
PARK AVE	15 1/4" x 72 1/4"	GC1672-6-SC-PA*		\$3,055	\$3,135	\$2,955	N/A	SRMK2-72 / SMK6-72	+ \$300 / + \$350
TRINITY	15 1/8" x 72 1/8"	GC1672-6-SC-TR*		\$2,975	\$3,060	\$2,725	N/A	SRMK2-72 / SMK6-72	+ \$300 / + \$350

* Handed door is available with left or right side hinges. Add "L" or "R" to end of model code.

Full-Length Cabinet GC2072 20" Width x 72" Height 4" Depth - Rough Opening: 18 3/8" x 72 1/8"

	Overall Dimension Width x Height	Model	List Price				Electric Option (EL, ER)	Side Mirror Kit - Surface Mount	
			Frameless Mirror	SB	PC, PN	BN, IB			
FLAT MIRROR	19" x 72"	GC2072-4-SC-FM*	\$2,210				N/A	SMK4-72	+ \$300
BEVELED MIRROR	19" x 72"	GC2072-4-SC-BM*	\$2,245				N/A	SMK4-72	+ \$300
LEXINGTON	19 1/8" x 72 1/8"	GC2072-4-SC-LE*		\$2,970	\$3,065	\$2,920	N/A	SMK4-72	+ \$300
PARK AVE	19 1/4" x 72 1/4"	GC2072-4-SC-PA*		\$3,055	\$3,140	\$2,955	N/A	SMK4-72	+ \$300
TRINITY	19 1/8" x 72 1/8"	GC2072-4-SC-TR*		\$2,970	\$3,065	\$2,920	N/A	SMK4-72	+ \$300

* Handed door is available with left or right side hinges. Add "L" or "R" to end of model code.

Full-Length Cabinet GC2072 20" Width x 72" Height 6" Depth - Rough Opening: 18 3/8" x 72 1/8"

	Overall Dimension Width x Height	Model	List Price				Electric Option (EL, ER)	Side Mirror Kit - Semi Recessed / Surface Mount	
			Frameless Mirror	SB	PC, PN	BN, IB			
FLAT MIRROR	19" x 72"	GC2072-6-SC-FM*	\$2,405				N/A	SRMK2-72 / SMK6-72	+ \$300 / + \$350
BEVELED MIRROR	19" x 72"	GC2072-6-SC-BM*	\$2,440				N/A	SRMK2-72 / SMK6-72	+ \$300 / + \$350
LEXINGTON	19 1/8" x 72 1/8"	GC2072-6-SC-LE*		\$3,165	\$3,260	\$3,115	N/A	SRMK2-72 / SMK6-72	+ \$300 / + \$350
PARK AVE	19 1/4" x 72 1/4"	GC2072-6-SC-PA*		\$3,250	\$3,335	\$3,150	N/A	SRMK2-72 / SMK6-72	+ \$300 / + \$350
TRINITY	19 1/8" x 72 1/8"	GC2072-6-SC-TR*		\$3,165	\$3,260	\$3,115	N/A	SRMK2-72 / SMK6-72	+ \$300 / + \$350

* Handed door is available with left or right side hinges. Add "L" or "R" to end of model code.

Note: Product specifications and installation instruction sheets for all product models are available for download at www.GlassCraftersMirroredCabinets.com.

Full-Length handle accessory comes standard with frameless cabinet only. For custom size cabinet orders, please contact

GlassCrafters Inc. directly at sales@glasscraftersinc.com concerning delivery times and pricing. All sales for custom size cabinets are final.



Electric Option currently not available for this unit

2022 STANDARD MIRRORED CABINETS PRICE SHEETS

Price sheet includes, frameless and framed cabinets

Issued 6/1/22

Tri-view Cabinet GC3630 36" Width x 30" Height 4" Depth - Rough Opening: 35 3/8" x 29 3/8"

	Overall Dimension Width x Height	Model	List Price	Electric Option (EL, ER)	Side Mirror Kit - Surface Mount	
FLAT MIRROR	36" x 30"	GC3630-4-SC-FM-TRI	\$1,370	N/A	SMK4-30	+ \$100
BEVELED MIRROR	36" x 30"	GC3630-4-SC-BM-TRI	\$1,442	N/A	SMK4-30	+ \$100

Tri-view Cabinet GC3636 36" Width x 36" Height 4" Depth - Rough Opening: 35 3/8" x 35 3/8"

	Overall Dimension Width x Height	Model	List Price	Electric Option (EL, ER)	Side Mirror Kit - Surface Mount	
FLAT MIRROR	36" x 36"	GC3636-4-SC-FM-TRI	\$1,514	N/A	SMK4-30	+ \$110
BEVELED MIRROR	36" x 36"	GC3636-4-SC-BM-TRI	\$1,586	N/A	SMK4-30	+ \$110

Tri-view Cabinet GC4830 48" Width x 30" Height 4" Depth - Rough Opening: 47 3/8" x 29 3/8"

	Overall Dimension Width x Height	Model	List Price	Electric Option (EL, ER)	Side Mirror Kit - Surface Mount	
FLAT MIRROR	48" x 30"	GC4830-4-SC-FM-TRI	\$1,514	N/A	SMK4-36	+ \$100
BEVELED MIRROR	48" x 30"	GC4830-4-SC-BM-TRI	\$1,586	N/A	SMK4-36	+ \$100

Tri-view Cabinet GC4836 48" Width x 36" Height 4" Depth - Rough Opening: 47 3/8" x 35 3/8"

	Overall Dimension Width x Height	Model	List Price	Electric Option (EL, ER)	Side Mirror Kit - Surface Mount	
FLAT MIRROR	48" x 36"	GC4836-4-SC-FM-TRI	\$1,730	N/A	SMK4-36	+ \$110
BEVELED MIRROR	48" x 36"	GC4836-4-SC-BM-TRI	\$1,802	N/A	SMK4-36	+ \$110

Note: Product specifications and installation instruction sheets for all product models are available for download at www.GlassCraftersMirroredCabinets.com.

For custom size cabinet orders, please contact GlassCrafters Inc. directly at sales@glasscraftersinc.com concerning delivery times and pricing.

All sales for custom size cabinets are final.



GLASSCRAFTERS INC.

2022 STANDARD MIRRORED CABINETS PRICE SHEETS

Price sheet includes, frameless and framed cabinets

Issued 6/1/22

Vertical Tier Mirrored Cabinet 4" Depth (Flat Mirror / Beveled Mirror)

**Add \$424.00 to list price for Electric Option. See pages 1 and 2 for more details.

Overall Dimension Width x Height	Model	List Price		Electric Option (EL, ER)	Side Mirror Kit - Surface Mount	
		Flat Mirror	Beveled Mirror			
15" x 54 3/4"	VTS-1654-4-SC-FM	\$1,400	\$1,522	\$424	SRMK4-54	+ \$300
15" x 60 3/4"	VTS-1660-4-SC-FM	\$1,463	\$1,562	\$424	SRMK4-60	+ \$300
15" x 66 3/4"	VTS-1666-4-SC-FM	\$1,591	\$1,690	\$424	SRMK4-66	+ \$300
15" x 72 3/4"	VTS-1672-4-SC-FM	\$1,720	\$1,818	\$424	SRMK4-72	+ \$300
19" x 60 3/4"	VTS-2060-4-SC-FM	\$1,567	\$1,664	\$424	SRMK4-60	+ \$300
19" x 66 3/4"	VTS-2066-4-SC-FM	\$1,696	\$1,793	\$424	SRMK4-66	+ \$300
19" x 72 3/4"	VTS-2072-4-SC-FM	\$1,823	\$1,921	\$424	SRMK4-72	+ \$300
23" x 60 3/4"	VTS-2460-4-SC-FM	\$1,725	\$1,829	\$424	SRMK4-60	+ \$300
23" x 66 3/4"	VTS-2466-4-SC-FM	\$1,854	\$1,956	\$424	SRMK4-66	+ \$300
23" x 72 3/4"	VTS-2472-4-SC-FM	\$1,983	\$2,086	\$424	SRMK4-72	+ \$300

* Available with 3/4" bevel mirror; change "FM" to "BM" in the model code.

Vertical Tier Mirrored Cabinet 6" Depth (Flat Mirror / Beveled Mirror)

**Add \$424.00 to list price for Electric Option. See pages 1 and 2 for more details.

Overall Dimension Width x Height	Model	List Price		Option (EL, ER)	Side Mirror Kit - Semi Recessed / Surface Mount	
		Flat Mirror	Beveled Mirror			
15" x 60 3/4"	VTS-1660-6-SC-FM	\$2,023	\$2,110	\$424	SRMK2-60 / SRMK6-60	+ \$300 / + \$350
15" x 66 3/4"	VTS-1666-6-SC-FM	\$2,154	\$2,246	\$424	SRMK2-66 / SRMK6-66	+ \$300 / + \$350
15" x 72 3/4"	VTS-1672-6-SC-FM	\$2,283	\$2,379	\$424	SRMK2-72 / SRMK6-72	+ \$300 / + \$350
19" x 60 3/4"	VTS-2060-6-SC-FM	\$2,131	\$2,229	\$424	SRMK2-60 / SRMK6-60	+ \$300 / + \$350
19" x 66 3/4"	VTS-2066-6-SC-FM	\$2,179	\$2,277	\$424	SRMK2-66 / SRMK6-66	+ \$300 / + \$350
19" x 72 3/4"	VTS-2072-6-SC-FM	\$2,387	\$2,485	\$424	SRMK2-72 / SRMK6-72	+ \$300 / + \$350
23" x 60 3/4"	VTS-2460-6-SC-FM	\$2,288	\$2,393	\$424	SRMK2-60 / SRMK6-60	+ \$300 / + \$350
23" x 66 3/4"	VTS-2466-6-SC-FM	\$2,417	\$2,521	\$424	SRMK2-66 / SRMK6-66	+ \$300 / + \$350
23" x 72 3/4"	VTS-2472-6-SC-FM	\$2,546	\$2,650	\$424	SRMK2-72 / SRMK6-72	+ \$300 / + \$350

* Available with 3/4" bevel mirror; change "FM" to "BM" in the model code.

** Please contact GlassCrafters Inc. directly to order a Vertical Tier Mirrored Cabinet with Electric Option

Rough Opening Height: Overall cabinet height (minus) 3/8" = R.O. Height for VTS

Example: Two (2) 30" height cabinets = 60 3/4" Total height (minus) 3/8" = Rough Opening: 60 3/8"

Note: Rough opening sizes are listed on GlassCrafters' product specification sheets. Product specifications and installation instruction sheets for all product models are available for download at www.GlassCraftersMirroredCabinets.com.

For custom size cabinet orders, please contact GlassCrafters Inc. directly at sales@glasscraftersinc.com concerning delivery times and pricing.

Electric Option is not currently available for custom size cabinets. All sales for custom size cabinets are final.



GLASSCRAFTERS INC.

PARTS LIST - MIRRORED CABINET

Issued 6/1/22

Carefully confirm all parts and read installation instructions before you start. Please refer to the specific installation sheet for the parts list and item counts for each model number. Please make note of the list price per piece. Contact GlassCrafters for additional shipping charges.

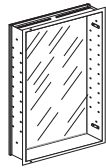

1

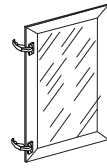

2



3



4

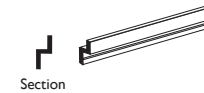

5



6

DESCRIPTION	CABINET	DOOR (BOXED SEPARATELY)	PLASTIC WALL ANCHORS	WALL ANCHOR SCREWS	BOTTOM SURFACE MOUNT WALL BRACKET	TOP SURFACE MOUNT BRACKET
PART #	GCXXXX-X-Cab	GCXXXX-X-D	#10 PWA	#10 X 1.5 Phillips	414-03	425-00
LIST PRICE	Consult GlassCrafters	Consult GlassCrafters	\$0.50	\$0.50	\$12.00	\$4.50



7

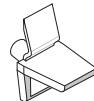

8



9

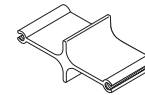

10

Note:

24" = 2
30" = 2
36" = 3
72" = 3

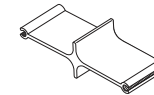

11



12

DESCRIPTION	SCREW CAPS	SHELF CLIP	HOLE PLUGS	4" DEEP CABINET CONNECTOR	6" DEEP CABINET CONNECTOR	CABINET CONNECTOR MOUNTING SCREW
PART #	434-00	439-01	433-00	426-00	429-00	18-85510-32x.5
LIST PRICE	\$0.50	\$1.75	\$0.50	\$12.00	\$15.00	\$0.50



13



14

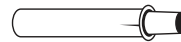

15



16



17

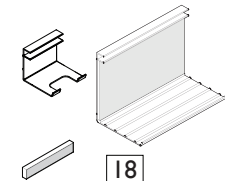

18

DESCRIPTION	HINGE COVER NAME PLATE	30 DEGREE LIMIT CLIP	SOFT CLOSE CUSHION	3X MAGNIFICATION MIRROR	FULL-LENGTH DOOR HANDLE	4" DEEP CABINET ACCESSORY KIT
PART #	904-00	901-00	900-00	950-01	GCCH-01	GCMCA-04-01
LIST PRICE	\$3.50	\$1.75	\$13.00	\$35.00	\$30.00	\$55.00



GLASSCRAFTERS INC.

PARTS LIST - MIRRORED CABINET

Issued 6/1/22

Carefully confirm all parts and read installation instructions before you start. Please refer to the specific installation sheet for the parts list and item counts for each model number. Please make note of the list price per piece. Contact GlassCrafters for additional shipping charges.

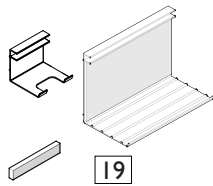

DESCRIPTION	6" DEEP CABINET ACCESSORY KIT
PART #	GCMCA-06-01
LIST PRICE	\$65.00



GLASSCRAFTERS INC.

PARTS LIST - GLASS SHELF

Issued 6/1/22

Each glass shelf will require four (4) shelf clips. Use care when handling non-tempered glass.

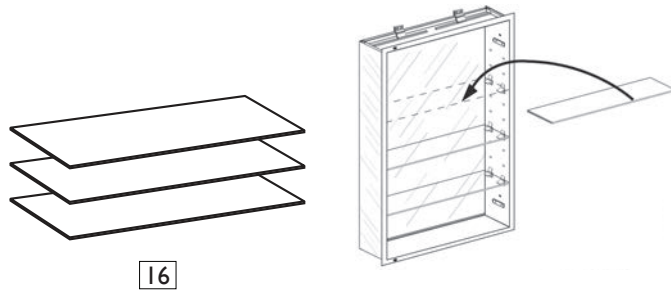

Note:

- 24" Height Series- 2 Shelves
- 30" Height Series- 3 Shelves
- 36" Height Series- 4 Shelves
- 72" Height Series- 8 Shelves

DESCRIPTION	CLEAR GLASS SHELF ONLY					
PART #	417-01-A	417-06-A	417-02-A	417-07-A	417-03-A	417-08-A
MODEL	16W x 4" Deep	16W x 6" Deep	20W x 4" Deep	20W x 6" Deep	24W x 4" Deep	24W x 6" Deep
SHELF SIZE	3 7/16" x 13 1/4"	5 7/16" x 13 1/4"	3 7/16" x 17 1/4"	5 7/16" x 17 1/4"	3 7/16" x 21 1/4"	5 7/16" x 21 1/4"
LIST PRICE	\$25.00	\$30.00	\$35.00	\$40.00	\$45.00	\$50.00



GLASSCRAFTERS INC.

2022 STANDARD WALL MIRRORS PRICE SHEETS

Price sheet includes, frameless and framed wall mirrors

Issued 6/1/22

Four choices of frameless wall mirrors are available to complete a horizontal combination of surface-mounted mirrored cabinets or as a stand-alone mirror to complement a hallway or powder room. The wall mirrors include all necessary installation hardware. When adding the frameless mirror to a combination of surface mounted cabinets, please refer to page 19 to add a glass shelf under the center mirror. Custom sizes available, consult GlassCrafters for size, price and availability. Note: All Wall Mirrors come equipped with hanging hardware attached. It is important to specify either a vertical or horizontal orientation when ordering Wall Mirrors from GlassCrafters.

CENTER MIRRORS

Decorative Frameless Mirrors

24" Height (Flat Mirror / Beveled Mirror)

Overall Dimension Width x Height	Model	List Price	
		Flat Mirror	Beveled Mirror
15" x 24"	C-FM-1624*	\$460	\$480
19" x 24"	C-FM-2024*	\$480	\$500
23" x 24"	C-FM-2424*	\$500	\$520

* Available with 3/4" bevel mirror, change "FM" to "BM" in the model code.

Decorative Frameless Mirrors

30" Height (Flat Mirror / Beveled Mirror)

Overall Dimension Width x Height	Model	List Price	
		Flat Mirror	Beveled Mirror
15" x 30"	C-FM-1630*	\$470	\$490
19" x 30"	C-FM-2030*	\$490	\$510
23" x 30"	C-FM-2430*	\$510	\$530
26" x 30"	C-FM-2630*	\$520	\$540
30" x 30"	C-FM-3030*	\$530	\$550
34" x 30"	C-FM-3430*	\$540	\$560

* Available with 3/4" bevel mirror, change "FM" to "BM" in the model code.

Note: Product specifications and installation instruction sheets for all product models are available for download at www.GlassCraftersMirroredCabinets.com.

For custom size wall mirror orders, please contact GlassCrafters Inc. directly at sales@glasscraftersinc.com concerning delivery times and pricing.

All sales for custom size wall mirrors are final.



CENTER MIRRORS

Decorative Frameless Mirrors 36" Height (Flat Mirror / Beveled Mirror)

Overall Dimension Width x Height	Model	List Price	
		Flat Mirror	Beveled Mirror
15" x 36"	C-FM-1636*	\$480	\$500
19" x 36"	C-FM-2036*	\$500	\$520
23" x 36"	C-FM-2436*	\$520	\$540
26" x 36"	C-FM-2636*	\$530	\$550
30" x 36"	C-FM-3036*	\$540	\$560
34" x 36"	C-FM-3436*	\$550	\$570

* Available with 3/4" bevel mirror; change "FM" to "BM" in the model code.

Note: Product specifications and installation instruction sheets for all product models are available for download at www.GlassCraftersMirroredCabinets.com.

For custom size wall mirror orders, please contact GlassCrafters Inc. directly at sales@glasscraftersinc.com concerning delivery times and pricing. All sales for custom size wall mirrors are final.

GlassCrafters offers five choices of decorative framed wall mirrors to complement your design. Traditional, Contemporary or Transitional, GlassCrafters has the right look for you. The decorative framed wall mirrors include all necessary installation hardware. Custom sizes available up to 36" x 36", consult GlassCrafters for size, price and availability. Note: All Wall Mirrors come equipped with hanging hardware attached. It is important to specify either a vertical or horizontal orientation when ordering Wall Mirrors from GlassCrafters.

DECORATIVE FINISHES



Plated Polished Chrome (PC)

[Plated - Polished / Mirror Like Finish]



Plated Polished Nickel (PN)



Satin Brass (SB)

[Satin Finish]



Brushed Nickel (BN) Brushed Bronze (BB)

[Brushed / Matte Finish]



Iron-Black (IB)

[Powder Coated / Durable - Matte Finish]

Decorative Framed Mirrors 16" Width x 24" Height

	Overall Dimension Width x Height	Model	List Price			
			SB	PC, PN	BN, IB	BB
LEXINGTON	15 1/8" x 24 1/8"	DF-FM-1624-LE	\$720	\$779	\$670	\$670
LEXINGTON 3/4" BEVEL	15 1/8" x 24 1/8"	DF-BM-1624-LE	N/A	\$1,160	\$750	\$750
PARK AVE	15 1/4" x 24 1/4"	DF-FM-1624-PA	\$865	\$670	\$765	N/A
PARK AVE 3/4" BEVEL	15 1/4" x 24 1/4"	DF-BM-1624-PA	N/A	\$1,186	\$845	N/A
TRINITY	15 1/8" x 24 1/8"	DF-FM-1624-TR	\$720	\$779	\$670	\$670
TRINITY 3/4" BEVEL	15 1/8" x 24 1/8"	DF-BM-1624-TR	N/A	\$1,160	\$750	\$750

Note: Product specifications and installation instruction sheets for all product models are available for download at www.GlassCraftersMirroredCabinets.com.

For custom size cabinet orders, please contact GlassCrafters Inc. directly at sales@glasscraftersinc.com concerning delivery times and pricing.

Electric Option is not currently available for custom size cabinets. All sales for custom size cabinets are final.



2022 STANDARD WALL MIRRORS PRICE SHEETS

Price sheet includes, frameless and framed wall mirrors

Issued 6/1/22

Decorative Framed Mirrors 16" Width x 30" Height

	Overall Dimension Width x Height	Model	List Price			
			SB	PC, PN	BN, IB	BB
LEXINGTON	15 1/8" x 30 1/8"	DF-FM-1630-LE	\$735	\$804	\$685	\$685
LEXINGTON 3/4" BEVEL	15 1/8" x 30 1/8"	DF-BM-1630-LE	N/A	\$1,181	\$765	\$765
PARK AVE	15 1/4" x 30 1/4"	DF-FM-1630-PA	\$880	\$837	\$780	N/A
PARK AVE 3/4" BEVEL	15 1/4" x 30 1/4"	DF-BM-1630-PA	N/A	\$1,215	\$860	N/A
TRINITY	15 1/8" x 30 1/8"	DF-FM-1630-TR	\$735	\$804	\$685	\$685
TRINITY 3/4" BEVEL	15 1/8" x 30 1/8"	DF-BM-1630-TR	N/A	\$1,181	\$765	\$765

Decorative Framed Mirrors 16" Width x 36" Height

	Overall Dimension Width x Height	Model	List Price			
			SB	PC, PN	BN, IB	BB
LEXINGTON	15 1/8" x 36 1/8"	DF-FM-1636-LE	\$755	\$828	\$705	\$705
LEXINGTON 3/4" BEVEL	15 1/8" x 36 1/8"	DF-BM-1636-LE	N/A	\$1,205	\$790	\$790
PARK AVE	15 1/4" x 36 1/4"	DF-FM-1636-PA	\$900	\$866	\$800	N/A
PARK AVE 3/4" BEVEL	15 1/4" x 36 1/4"	DF-BM-1636-PA	N/A	\$1,243	\$885	N/A
TRINITY	15 1/8" x 36 1/8"	DF-FM-1636-TR	\$755	\$828	\$705	\$705
TRINITY 3/4" BEVEL	15 1/8" x 36 1/8"	DF-BM-1636-TR	N/A	\$1,205	\$790	\$790

Note: Product specifications and installation instruction sheets for all product models are available for download at www.GlassCraftersMirroredCabinets.com.

For custom size cabinet orders, please contact GlassCrafters Inc. directly at sales@glasscraftersinc.com concerning delivery times and pricing.

Electric Option is not currently available for custom size cabinets. All sales for custom size cabinets are final.



2022 STANDARD WALL MIRRORS PRICE SHEETS

Price sheet includes, frameless and framed wall mirrors

Issued 6/1/22

Decorative Framed Mirrors 20" Width x 30" Height

	Overall Dimension Width x Height	Model	List Price			
			SB	PC, PN	BN, IB	BB
DECO	19 1/8" x 30 1/8"	DF-FM-2030-DE	N/A	\$857	\$765	\$765
DECO 3/4" BEVEL	19 1/8" x 30 1/8"	DF-BM-2030-DE	N/A	\$1,234	\$855	\$855
LEXINGTON	19 1/8" x 30 1/8"	DF-FM-2030-LE	\$755	\$819	\$705	\$705
LEXINGTON 3/4" BEVEL	19 1/8" x 30 1/8"	DF-BM-2030-LE	N/A	\$1,197	\$790	\$790
PARK AVE	19 1/4" x 30 1/4"	DF-FM-2030-PA	\$900	\$857	\$800	N/A
PARK AVE 3/4" BEVEL	19 1/4" x 30 1/4"	DF-BM-2030-PA	N/A	\$1,234	\$885	N/A
SOHO	19 1/8" x 30 1/8"	DF-FM-2030-SO	N/A	\$857	\$765	\$765
SOHO 3/4" BEVEL	19 1/8" x 30 1/8"	DF-BM-2030-SO	N/A	\$1,234	\$855	\$885
TRINITY	19 1/8" x 30 1/8"	DF-FM-2030-TR	\$755	\$918	\$705	\$705
TRINITY 3/4" BEVEL	19 1/8" x 30 1/8"	DF-BM-2030-TR	N/A	\$1,197	\$790	\$790

Decorative Framed Mirrors 20" Width x 36" Height

	Overall Dimension Width x Height	Model	List Price			
			SB	PC, PN	BN, IB	BB
DECO	19 1/8" x 36 1/8"	DF-FM-2036-DE	N/A	\$1,041	\$795	\$795
DECO 3/4" BEVEL	19 1/8" x 36 1/8"	DF-BM-2036-DE	N/A	\$1,418	\$880	\$880
LEXINGTON	19 1/8" x 36 1/8"	DF-FM-2036-LE	\$785	\$1,000	\$735	\$735
LEXINGTON 3/4" BEVEL	19 1/8" x 36 1/8"	DF-BM-2036-LE	N/A	\$1,377	\$805	\$805
PARK AVE	19 1/4" x 36 1/4"	DF-FM-2036-PA	\$930	\$1,041	\$830	N/A
PARK AVE 3/4" BEVEL	19 1/4" x 36 1/4"	DF-BM-2036-PA	N/A	\$1,418	\$900	N/A
SOHO	19 1/8" x 36 1/8"	DF-FM-2036-SO	N/A	\$1,041	\$795	\$795
SOHO 3/4" BEVEL	19 1/8" x 36 1/8"	DF-BM-2036-SO	N/A	\$1,418	\$880	\$880
TRINITY	19 1/8" x 36 1/8"	DF-FM-2036-TR	\$785	\$1,000	\$735	\$735
TRINITY 3/4" BEVEL	19 1/8" x 36 1/8"	DF-BM-2036-TR	N/A	\$1,377	\$805	\$805

Note: Product specifications and installation instruction sheets for all product models are available for download at www.GlassCraftersMirroredCabinets.com.

For custom size cabinet orders, please contact GlassCrafters Inc. directly at sales@glasscraftersinc.com concerning delivery times and pricing.

Electric Option is not currently available for custom size cabinets. All sales for custom size cabinets are final.



2022 STANDARD WALL MIRRORS PRICE SHEETS

Price sheet includes, frameless and framed wall mirrors

Issued 6/1/22

Decorative Framed Mirrors 24" Width x 30" Height

	Overall Dimension Width x Height	Model	List Price			
			SB	PC, PN	BN, IB	BB
DECO	23 1/8" x 30 1/8"	DF-FM-2430-DE	N/A	\$926	\$795	\$795
DECO 3/4" BEVEL	23 1/8" x 30 1/8"	DF-BM-2430-DE	N/A	\$1,303	\$880	\$880
LEXINGTON	23 1/8" x 30 1/8"	DF-FM-2430-LE	\$785	\$886	\$735	\$735
LEXINGTON 3/4" BEVEL	23 1/8" x 30 1/8"	DF-BM-2430-LE	N/A	\$1,264	\$805	\$805
PARK AVE	23 1/4" x 30 1/4"	DF-FM-2430-PA	\$930	\$926	\$830	N/A
PARK AVE 3/4" BEVEL	23 1/4" x 30 1/4"	DF-BM-2430-PA	N/A	\$1,303	\$900	N/A
SOHO	23 1/8" x 30 1/8"	DF-FM-2430-SO	N/A	\$926	\$795	\$795
SOHO 3/4" BEVEL	23 1/8" x 30 1/8"	DF-BM-2430-SO	N/A	\$1,303	\$880	\$880
TRINITY	23 1/8" x 30 1/8"	DF-FM-2430-TR	\$785	\$886	\$735	\$735
TRINITY 3/4" BEVEL	23 1/8" x 30 1/8"	DF-BM-2430-TR	N/A	\$1,264	\$805	\$805

Decorative Framed Mirrors 24" Width x 36" Height

	Overall Dimension Width x Height	Model	List Price			
			SB	PC, PN	BN, IB	BB
DECO	23 1/8" x 36 1/8"	DF-FM-2436-DE	N/A	\$1,110	\$845	\$845
DECO 3/4" BEVEL	23 1/8" x 36 1/8"	DF-BM-2436-DE	N/A	\$1,487	\$905	\$905
LEXINGTON	23 1/8" x 36 1/8"	DF-FM-2436-LE	\$810	\$1,066	\$760	\$760
LEXINGTON 3/4" BEVEL	23 1/8" x 36 1/8"	DF-BM-2436-LE	N/A	\$1,443	\$815	\$815
PARK AVE	23 1/4" x 36 1/4"	DF-FM-2436-PA	\$955	\$1,110	\$855	N/A
PARK AVE 3/4" BEVEL	23 1/4" x 36 1/4"	DF-BM-2436-PA	N/A	\$1,487	\$910	N/A
SOHO	23 1/8" x 36 1/8"	DF-FM-2436-SO	N/A	\$1,110	\$845	\$845
SOHO 3/4" BEVEL	23 1/8" x 36 1/8"	DF-BM-2436-SO	N/A	\$1,487	\$905	\$905
TRINITY	23 1/8" x 36 1/8"	DF-FM-2436-LE	\$810	\$1,066	\$760	\$760
TRINITY 3/4" BEVEL	23 1/8" x 36 1/8"	DF-BM-2436-TR	N/A	\$1,443	\$815	\$815

Note: Product specifications and installation instruction sheets for all product models are available for download at www.GlassCraftersMirroredCabinets.com.

For custom size cabinet orders, please contact GlassCrafters Inc. directly at sales@glasscraftersinc.com concerning delivery times and pricing.

Electric Option is not currently available for custom size cabinets. All sales for custom size cabinets are final.

GlassCrafters offers an extensive array of glass shelving sizes to fit your bath dimensions. Combine two surface-mounted cabinets with a center wall mirror and glass shelf kit for greater storage and a custom appearance. The center mirror shelf kit includes all necessary installation hardware. Standard glass thickness is 1/2".

For matching size center mirrors in a variety of styles see the Decorative Frameless Mirror page

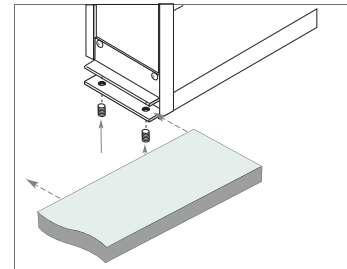
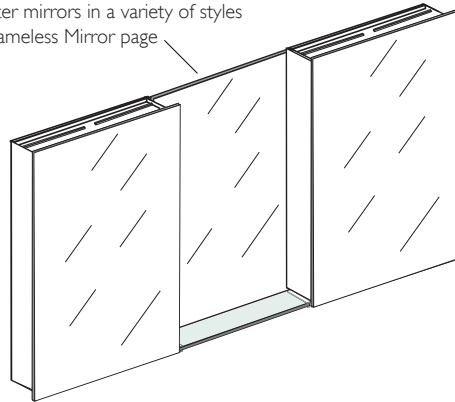

Center Mirror Glass Shelf 4" Depth

Overall Dimension Width x Height	Model	List Price
15" x 3 3/4"	GS-16-4	\$150
19" x 3 3/4"	GS-20-4	\$175
23" x 3 3/4"	GS-24-4	\$200
26" x 3 3/4"	GS-26-4	\$225
30" x 3 3/4"	GS-30-4	\$250
36" x 3 3/4"	GS-34-4	\$275

Center Mirror Glass Shelf 6" Depth

Overall Dimension Width x Height	Model	List Price
15" x 5 3/4"	GS-16-6	\$195
19" x 5 3/4"	GS-20-6	\$220
23" x 5 3/4"	GS-24-6	\$245
26" x 5 3/4"	GS-26-6	\$270
30" x 5 3/4"	GS-30-6	\$295
36" x 5 3/4"	GS-34-6	\$320

NEW

ULTRA THIN, ILLUMINATED WALL MIRROR COLLECTION

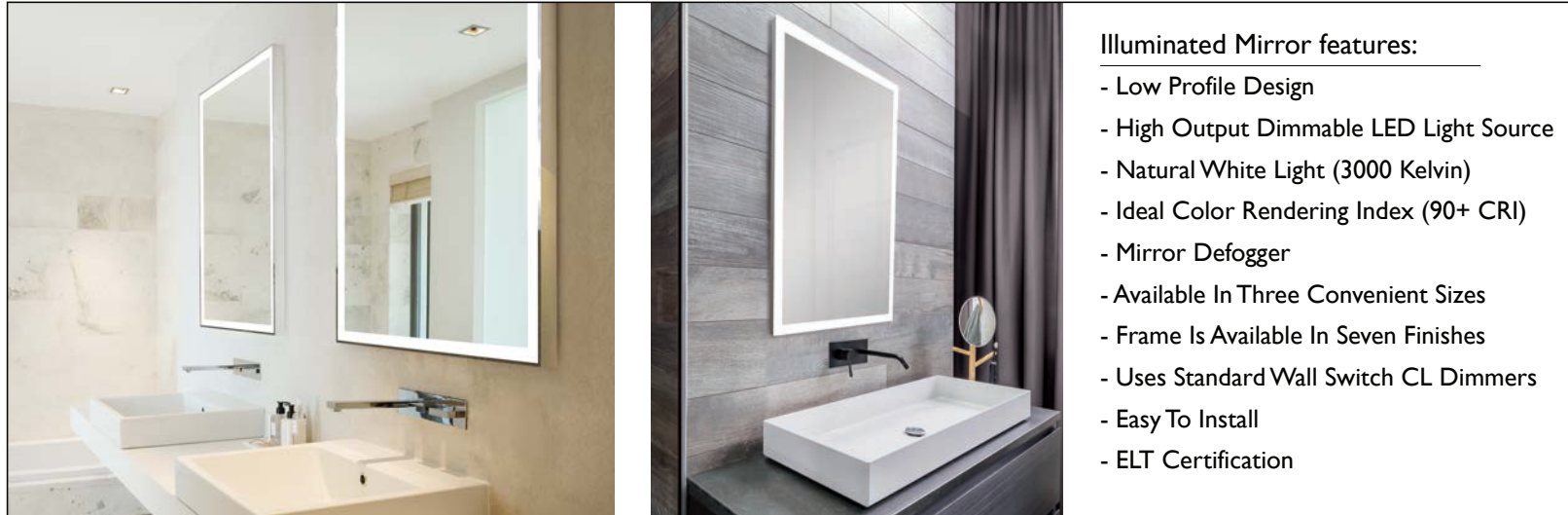

Tribeca Framed Illuminated Mirror
With Polished Chrome Finish

Chelsea Frameless
Illuminated Mirror

Illuminated Mirror features:

- Low Profile Design
- High Output Dimmable LED Light Source
- Natural White Light (3000 Kelvin)
- Ideal Color Rendering Index (90+ CRI)
- Mirror Defogger
- Available In Three Convenient Sizes
- Frame Is Available In Seven Finishes
- Uses Standard Wall Switch CL Dimmers
- Easy To Install
- ELT Certification

The Chelsea Collection illuminated mirror with Tribeca decorative frame by GlassCrafters offers superior light functionality that is unparalleled. Delivering high output, dimmable LED, warm white light with built-in mirror defogger, the illuminated mirror was created to enhance your daily grooming experience. The Tribeca frame's carefully detailed design and multiple finish options will make a style statement in any bath space or makeup station.

Frameless Sizes- 24"×30"×1 5/16"* , 24"×36"×1 5/16"* , 36"×36"×1 5/16"

Framed Sizes- 24"×30"×1 5/8"* , 24"×36"×1 5/8"* , 36"×36"×1 5/8"

*Rectangular Illuminated Mirrors Can Be Installed Either Portrait Or Landscape

Note: Product specifications and installation instruction sheets for all product models are available for download at www.GlassCraftersMirroredCabinets.com.

For custom size illuminated mirror projects, please contact GlassCraters Inc. directly at sales@glasscraftersinc.com concerning delivery times and pricing.

All sales for custom size illuminated mirror projects are final.

NEW

ULTRA THIN, ILLUMINATED WALL MIRROR COLLECTION



Tribeca Framed Illuminated Mirror
With Satin Brass Finish



Tribeca Framed Illuminated Mirror
With Iron-Black (Matte) Finish

Recommended Lutron C•L Dimmer Controls (purchase separately)



Maestro Sensor & Dimmer



Maestro Dimmer



Diva Dimmer

Frame Details

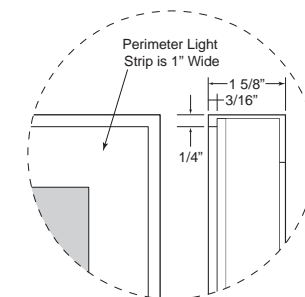

Note: Product specifications and installation instruction sheets for all product models are available for download at www.GlassCraftersMirroredCabinets.com.

For custom size illuminated mirror projects, please contact GlassCraters Inc. directly at sales@glasscraftersinc.com concerning delivery times and pricing.
All sales for custom size illuminated mirror projects are final.

DECORATIVE FINISHES

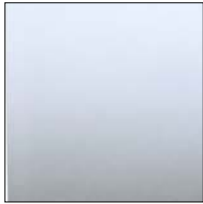

Plated Polished Chrome (PC)

[Plated - Polished / Mirror Like Finish]



Plated Polished Nickel (PN)



Polished Chrome Anodized (CHA)



Polished Nickel Anodized (PNA)

[Anodized Finish]



Brushed Nickel Anodized (BN)



Satin Brass Anodized (SB)

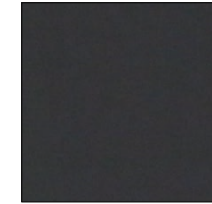

Iron-Black (IB)

[Powder Coated / Durable - Matte Finish]

Frameless Illuminated Mirrors with Defogger

Overall Dimension Width x Height	Model	List Price
		Frameless Mirror
24" x 30	GCCHE-IM-2430	\$654
24" x 36	GCCHE-IM-2436	\$704
36" x 36"	GCCHE-IM-3636	\$924

Tribeca Framed Illuminated Mirrors with Defogger

Overall Dimension Width x Height	Model	List Price						
		PC	PN	CHA	PNA	BN	SB	IB
24" x 30	GCCHE-IM-2430-TB	\$1,364	\$1,364	\$922	\$922	\$922	\$972	\$922
24" x 36	GCCHE-IM-2436-TB	\$1,601	\$1,601	\$1,141	\$1,141	\$1,141	\$1,191	\$1,141
36" x 36"	GCCHE-IM-3636-TB	\$1,807	\$1,807	\$1,263	\$1,263	\$1,263	\$1,313	\$1,263

Note: Product specifications and installation instruction sheets for all product models are available for download at www.GlassCraftersMirroredCabinets.com.

For custom size illuminated mirror projects, please contact GlassCrafters Inc. directly at sales@glasscraftersinc.com concerning delivery times and pricing.

All sales for custom size illuminated mirror projects are final.

VERTICAL LED TASK LIGHTS for recessed or surface mounted frameless mirrored cabinets



Features UL recognized components

Vertical LED Task Lights features:

- Linear illumination reduces shadows across face
- 2700 - 3000 Kelvin color temperature value (warm white light)
- Angled diffuser designed to project precise light towards user's face
- LED lamping is both energy efficient and longer lasting

GlassCrafters' Vertical LED Task Lights illuminate your daily grooming activities with energy efficient, optimal warm white light and integrate seamlessly into any decor. Providing a minimal, low profile design aesthetic, the 2 1/2" wide Vertical LED Task Lights are easy to install and complement GlassCrafters' 24" and 30" high, frameless flat or beveled mirrored cabinets.

Finish- White Acrylic Diffuser with Brushed Stainless Steel Cover Plates

Vertical LED Task Lights VTL 2.5" Width x 24" and 30" Heights - for 4" or 6" deep cabinets

Overall Dimension Width x Height (per light)	Model	List Price (price per pair of lights)	
2.5" x 24"	VTL-24-001	\$649	Non-dimming
2.5" x 30"	VTL-30-001	\$699	Non-dimming

Modular lighting that attaches to side of cabinet. Add 4 3/4" to the width for all Rough Openings and Framing for cabinets with Vertical LED Task Lights.
 For Roughing-in Opening and Overall Dimensions, see the modified Roughing Dimensions shown in the Vertical LED Task Lights manual that are applicable to all cabinet sizes and models.

Note: Product specifications and installation instruction sheets for all product models are available for download at www.GlassCraftersMirroredCabinets.com.

Vertical LED Task Lights are not available in custom sizes.

VERTICAL LED TASK LIGHTS for recessed or surface mounted frameless mirrored cabinets

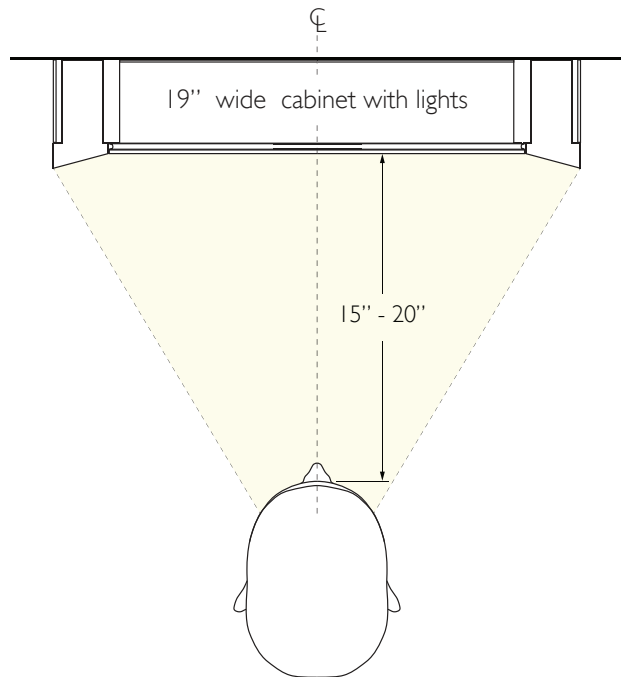

Providing ideal illumination for daily grooming activities.

1200k

4100k



2700k

5500k

GlassCrafters' lights range between 2700 - 3000 Kelvin color temperature.

Specifically designed to precisely project light at user's face, reducing shadows for makeup or shaving applications. We have found that **2700 - 3000 Kelvin color temperature** (warm white light) with a **color rendering index of 80-90** (for enhanced skin tones) provides the best environment for personal grooming tasks.

Note: Product specifications and installation instruction sheets for all product models are available for download at www.GlassCraftersMirroredCabinets.com. Vertical LED Task Lights are not available in custom sizes.



GLASSCRAFTERS INC.

MIRRORED CABINET ORDER FORM

Email to sales@glasscraftersinc.com or Fax to (888) 233-7362

Purchase Order

#

Date _____

Bill To: _____

Ship To: _____

Check if same as Bill To:

DEALER _____

DEALER _____

ADDRESS _____

ADDRESS _____

CITY _____ STATE _____

CITY _____ STATE _____

PHONE _____

PHONE _____

FAX _____

FAX _____

Ordered by: _____

Estimated Delivery Date: _____

EXAMPLE ORDERING NUMBER DETAILS	GC	16	30	—	4	—	SC	—	TR	—	BM	—	PC	—	EL*	—	SMK**
	Width		Height		Depth		Cabinet Finish Satin Chrome		Trinity Frame		Beveled Mirror		Polished Chrome Finish		Electric Option with Left Side Hinged Door		Side Mirror Kits

Qty	Model #	Cabinet List	Recess	Semi Recess	Surface Mount	TOTAL
_____	_____	_____	n/c	_____	_____	_____
_____	_____	_____	n/c	_____	_____	_____
_____	_____	_____	n/c	_____	_____	_____
_____	_____	_____	n/c	_____	_____	_____
_____	_____	_____	n/c	_____	_____	_____

*Electric option is available with the following 4" & 6" deep frameless and framed Mirrored Cabinets including: GC 1630, GC 1636, GC 2030, GC 2036, GC 2430, GC 2436. For left or right sided door hinges, add "EL" or "ER" to model code. **All wiring should be done by a qualified licensed electrician in a manner that conforms to the National Electric code. For information concerning wiring requirements, see installation instructions prior to purchase.**

**Surface Mount and Semi Recessed Cabinets require Side Mirrors

Signature Required _____

Date _____



GLASSCRAFTERS INC.

WALL MIRROR ORDER FORM

Email to sales@glasscraftersinc.com or Fax to (888) 233-7362

Purchase Order

#

Date _____

Bill To: _____

Ship To: _____

Check if same as Bill To:

DEALER _____

DEALER _____

ADDRESS _____

ADDRESS _____

CITY _____ STATE _____

CITY _____ STATE _____

PHONE _____

PHONE _____

FAX _____

FAX _____

Ordered by: _____

Estimated Delivery Date: _____

EXAMPLE ORDERING NUMBER DETAILS	DF	—	BM	—	16		30	—	LE	—	PC
			Beveled Mirror		Width		Depth		Lexington		Polished Chrome Finish

Qty	Model #	Vertical Orientation	Horizontal Orientation	Wall Mirror List	TOTAL
_____	_____	_____	_____	_____	_____
_____	_____	_____	_____	_____	_____
_____	_____	_____	_____	_____	_____
_____	_____	_____	_____	_____	_____
_____	_____	_____	_____	_____	_____

Signature Required

Date