



AMERICAN HONDA MOTOR CO., INC.
100 WEST ALONDRA BOULEVARD, GARDENA, CALIFORNIA 90247

Date of Issue: 4/75

SET-UP INSTRUCTION ADDENDUM FOR

ATC90K3



NOTE

Refer to the following pages for additional steps required to set-up the ATC90K3.

Insert this addendum in front of page 1 of the ATC90 Set-up Instructions.

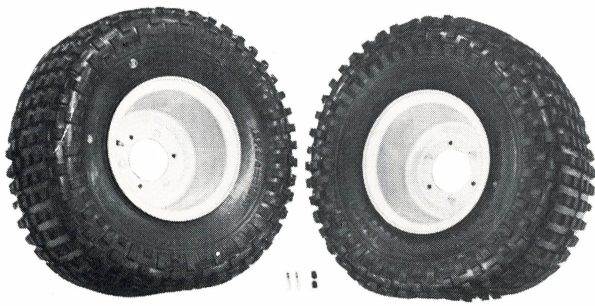

Rear Wheels, Valve Cores, and Caps

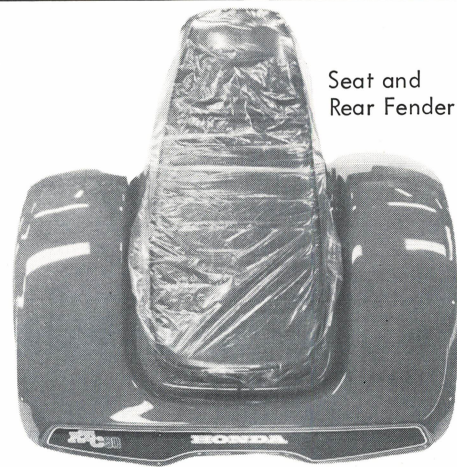

Seat and Rear Fender

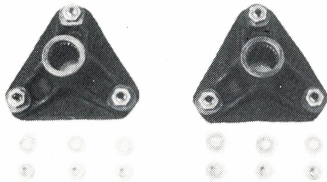

Rear Wheel Flanges and Attaching Hardware

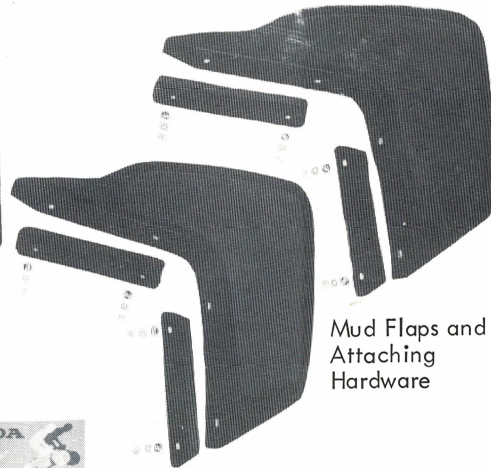
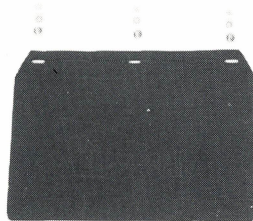

Mud Flaps and Attaching Hardware

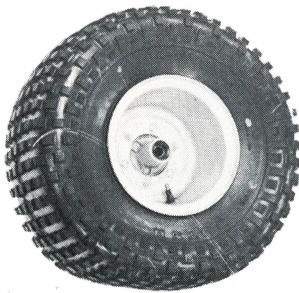

Front Wheel, Valve Core and Cap

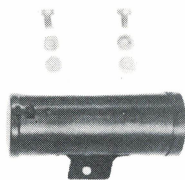

Tool Box



Owner's Manual

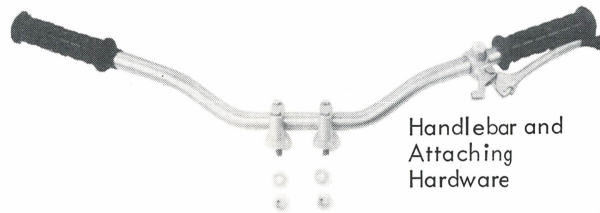

Handlebar and Attaching Hardware



Carrying Handle and Attaching Hardware

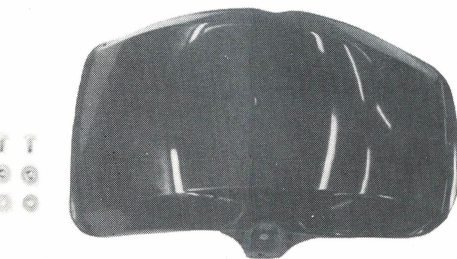

Front Fender and Attaching Hardware

STEP 4A — Unpack loose parts and check against this illustration. Report any damaged or missing parts immediately to American Honda Motor Co., Inc., 100 W. Alondra Blvd., Gardena, California 90247.

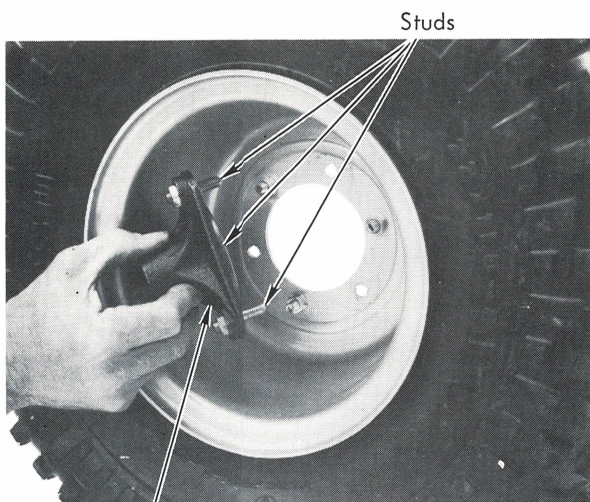

Rear Flange

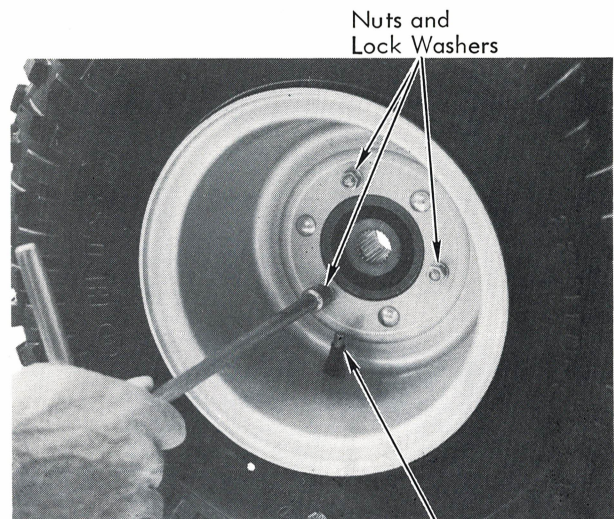

Valve Stem

STEP 12A — Insert studs of rear flange through rear wheel from side opposite valve stem. Install flange using three lock washers and nuts on side of wheel having valve stem. Tighten nuts securely. Repeat for other wheel.



Valve Stem

STEP 12B — Remove castle nuts and plain washers from rear axle. Grease axle splines. Install rear wheels, with valve stems to the outside, using same plain washers and castle nuts.

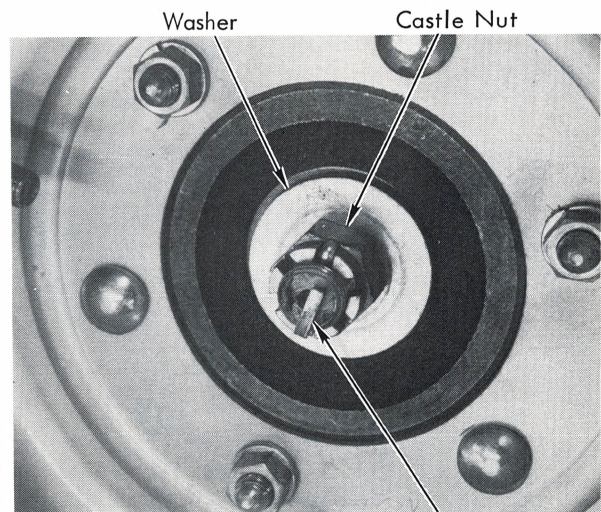

Cotter Pin

STEP 12C — Tighten both rear axle nuts to specified torque and install a cotter pin in each. Spread cotter pin ends as shown.

Torque specification:

6.0 - 8.0 kg-m (43 - 58 lbs-ft)

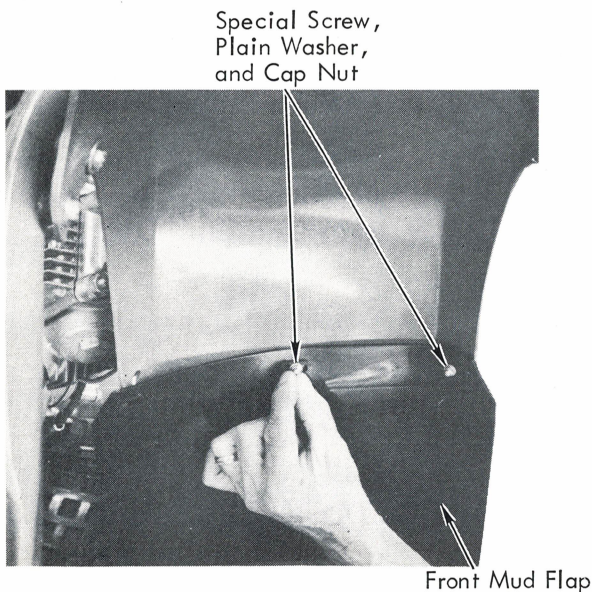

STEP 18A — Install front fender mud guard under fender using three special screws inserted through fender and mud flap, with plain washers and cap nuts on mud flap side. Tighten securely.

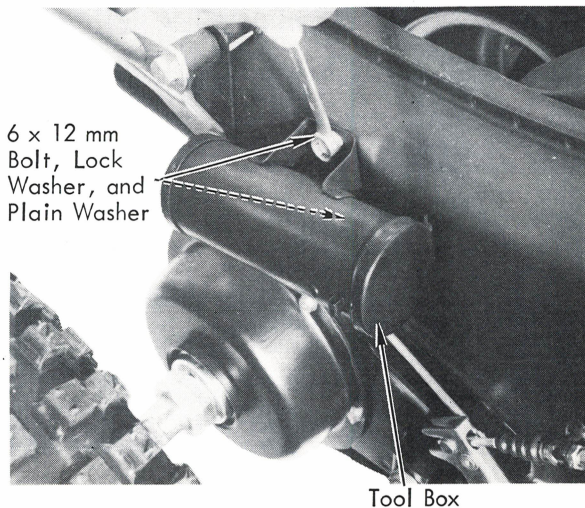

STEP 35A — Install tool box using two 6 x 12 mm bolts, lock washers, and plain washers. Tighten securely.

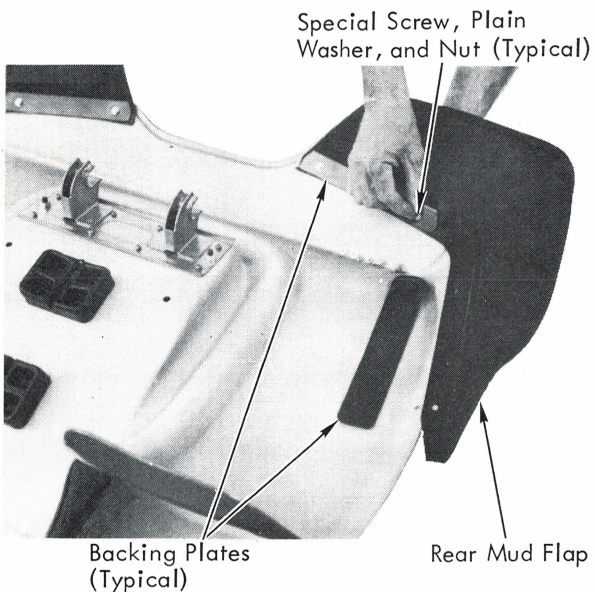

STEP 35B — Install each rear mud flap under fender using four special screws inserted through fender, mud flap, and backing plates, with plain washers and nuts on backing plate side. Tighten securely.

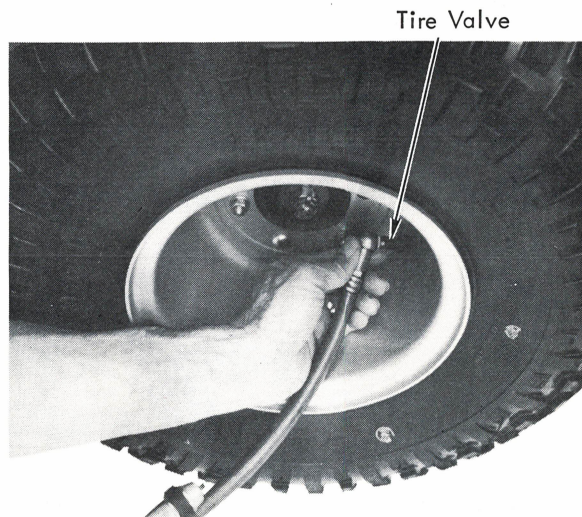

STEP 37 — Inflate and check tire pressure.
All tires: 2.2 psi.

MODEL ATC90K3
PARTS PACKAGE CONTENTS

The following is a list of items contained in the parts package carton located behind the front forks:

DESCRIPTION	H/C	PART NUMBER
Front fender	39881	61100-942-010TR
Carrying handle	37719	81200-918-670
Carrying handle taillight	37697	33700-942-000
Owner's manual	39911	3194202
Front fender mud guard	39882	61111-942-000
Rear fender mud guard (2 required)	39885	80111-942-000
Cotter pin (4 supplied) 3.0 x 30	05843	94201-30300
Valve cores (3 required)		Not Available Separately
Valve caps (3 required)		Not Available Separately
Handlebar complete:		
Handlebar	23465	53100-918-020XW
Lower holders (2 required)	27861	95014-32100
Upper holders (2 required)	26889	95014-21100
Brake hand lever	23405	53190-918-010
Brake hand lever bracket	23472	53172-918-000
Handgrips (2 required)	29048	53166-918-000
Spacer	26306	53152-918-000
Hex bolts, 6 x 28 (4 required)	17012	90117-065-000
Plain washer, 6mm (4 required)	05907	94101-06000
Hex bolts, 6 x 16 (4 required) front fender	05423	92000-06016
Hex bolts, 8 x 16 (2 required) carrying handle	14543	92000-08016-OA
Hex bolts, 10 x 180 (1 required) carrying handle	26307	90196-918-000
Washer, flanged (4 required) front fender	29937	64348-086-000
Washer, plain, 6.5 x 20 (4 required) front fender	14491	90545-292-000
Washer, lock, 8mm (8 required) carrying handle, rear flanges	05898	94111-08000
Washer, lock 10mm (3 required) handlebar, carrying handle	05900	94111-10000
Nut, 10mm (3 required) handlebar, carrying handle	14539	94001-10000-OS
Tool box	29060	89500-918-000
Rear wheel flange (2 required)	39869	42401-942-300
Hex bolts, 6 x 12 (2 required) tool box	05419	92000-06012
Washer, plain, 6mm (2 required) tool box	05907	94101-06000
Washer, lock, 6mm (2 required) tool box	25821	94111-06800
Nut, 8mm (6 required) rear wheel flanges	16733	94001-08000-OS

This page supersedes page 5 dated 4/75. Remove and destroy superseded page.

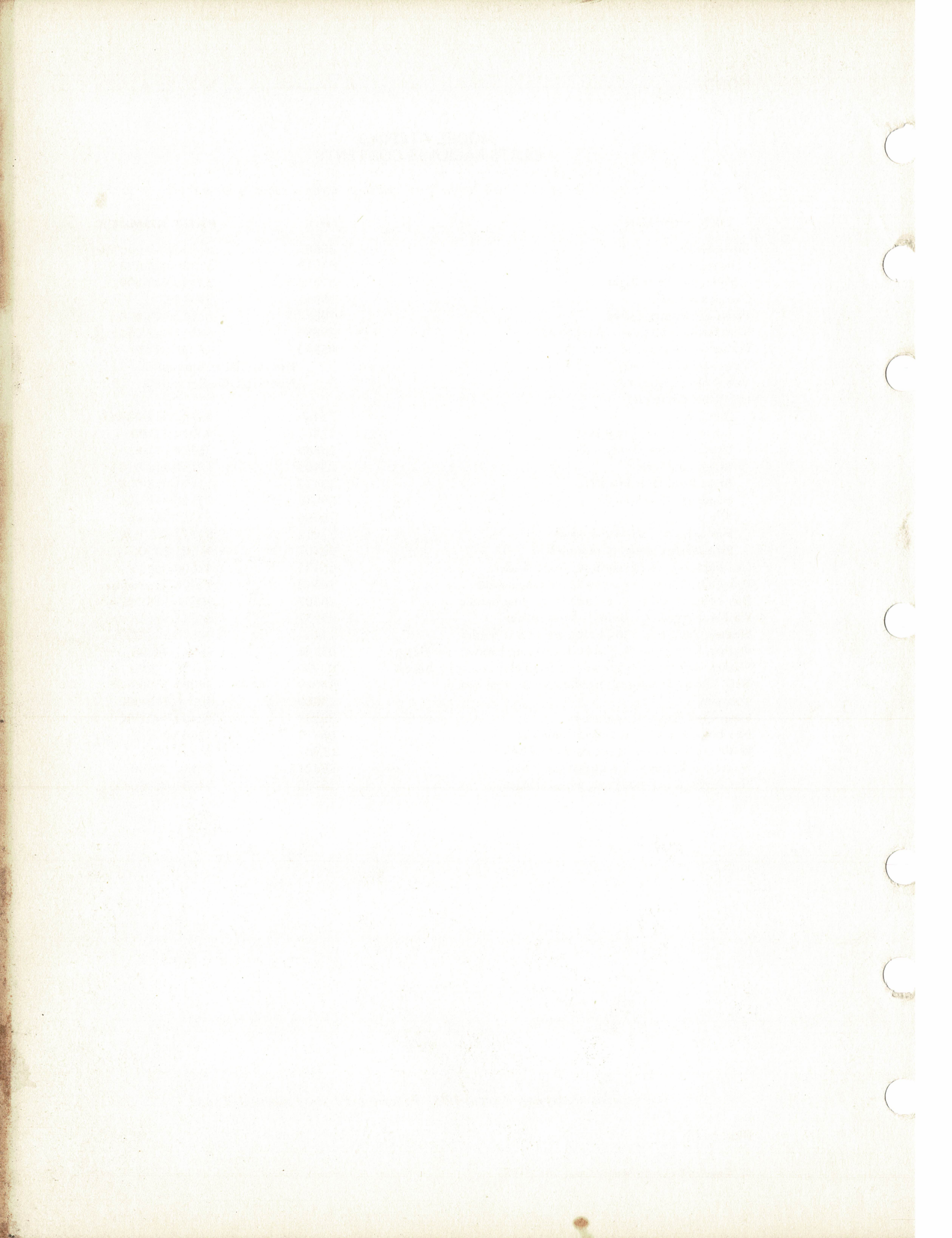



READ THIS READ THIS READ THIS

HONDA

MODIFICATIONS WHICH YOU HAVE MADE, OR SHOULD MAKE IN THE FUTURE, TO ANY HONDA MOTORCYCLE, SHALL BE DEEMED BY OUR COMPANY TO HAVE BEEN PERFORMED AT YOUR SOLE RISK AND RESPONSIBILITY, AND WITHOUT OUR COMPANY'S OR THE MANUFACTURER'S APPROVAL OR CONSENT, IMPLIED OR EXPRESSED. WE FURTHER DISCLAIM ANY AND ALL LIABILITY, OBLIGATION, OR RESPONSIBILITY FOR ANY DEFECTS OF MODIFIED PARTS OR OF THE MODIFIED MOTORCYCLE, AND FOR ANY CLAIMS, DEMANDS, OR CAUSES OF ACTION FOR DAMAGE TO PROPERTY OR FOR PERSONAL INJURIES RESULTING FROM THE MODIFICATION OF SAID HONDA MOTORCYCLE.

READ THIS READ THIS READ THIS

READ THIS READ THIS READ THIS