

Set-up Instructions

1987 Model ATC 250ES



MPD 341-8606

AMERICAN HONDA MOTOR CO., INC.
100 WEST ALONDRA BOULEVARD, GARDENA, CALIFORNIA 90247

WARNING

WARNING

WARNING

WARNING

SET-UP AND PRE-DELIVERY SERVICE MUST BE PERFORMED BY AN AUTHORIZED HONDA ATV DEALER. Proper set-up and pre-delivery service is essential to rider safety and reliability of the ATV. An error or oversight made by the mechanic assembling and servicing a new unit can easily result in faulty operation, damage to the machine, or even injury to the rider.



NOTE: Right and left are determined from the rider's view.

Date of Issue: 6/86

SET-UP INSTRUCTION REVISED PAGES

Pages Affected

Rev. Date

Remove and destroy superseded pages.

Pay special attention to warnings, cautions, and notes.

WARNING means hazards or unsafe practices which could cause severe personal injury or death.

CAUTION: means hazards or unsafe practices which could cause minor personal injury or product or property damage.

NOTE: gives helpful information.

TORQUE TABLE

ITEM	SIZE	TORQUE
Handlebar upper holder bolts	8 mm	2.4 kg-m (18 lb-ft)
Front fork leg bolts	-----	5.5 kg-m (40 lb-ft)
Front fender bolts	6 mm	1.0 kg-m (8 lb-ft)
Front axle	-----	9.0 kg-m (68 lb-ft)
Axle holder nuts	6 mm	1.2 kg-m (9 lb-ft)
Rear wheel nuts	10 mm	5.5 kg-m (40 lb-ft)
Engine guard bolts	8 mm	2.7 kg-m (19 lb-ft)
Gear case protector	8 mm	2.7 kg-m (19 lb-ft)
Trailer hitch	10 mm	4.0 kg-m (30 lb-ft)
Front carrier bolts	8 mm	2.7 kg-m (19 lb-ft)
Headlight rubber mount bolts	6 mm	1.2 kg-m (9 lb-ft)
Connector box bolts	6 mm	1.2 kg-m (9 lb-ft)
Sub carrier clamp bolts	6 mm	1.2 kg-m (9 lb-ft)
Luggage box bolts	6 mm	1.2 kg-m (9 lb-ft)
Luggage box cover bolts	6 mm	1.2 kg-m (9 lb-ft)
Mud guard screws	-----	0.4 kg-m (3 lb-ft)
Rear fender bolts	6 mm	1.2 kg-m (9 lb-ft)
Rear fender/carrier pivot bolts	-----	2.7 kg-m (20 lb-ft)
Fuel filter cup	-----	0.4 kg-m (3 lb-ft)

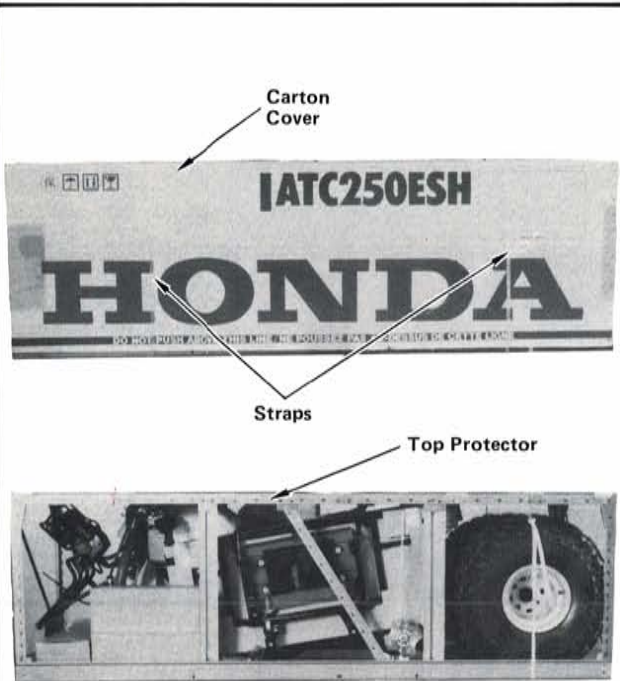

STEP 1—Cut the straps and remove the carton cover. Remove the crate top protector.

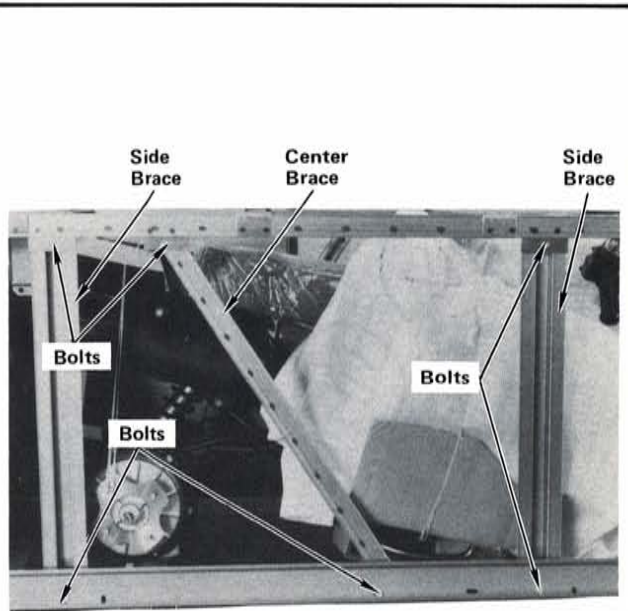

STEP 2—Remove the bolts attaching the center and side braces to the crate base. Discard the bolts and braces.

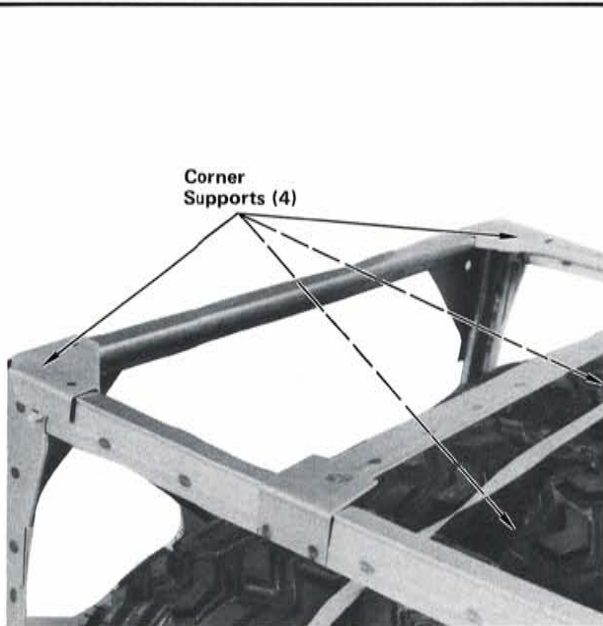

STEP 3—Remove and discard the corner supports.

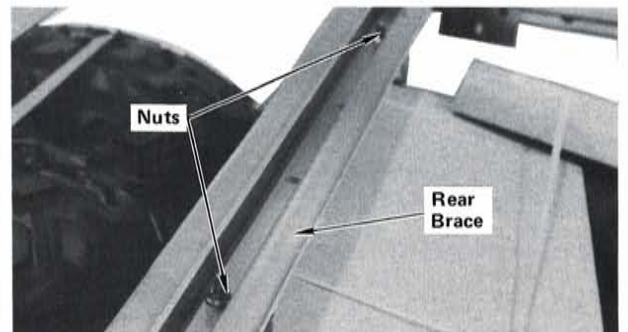
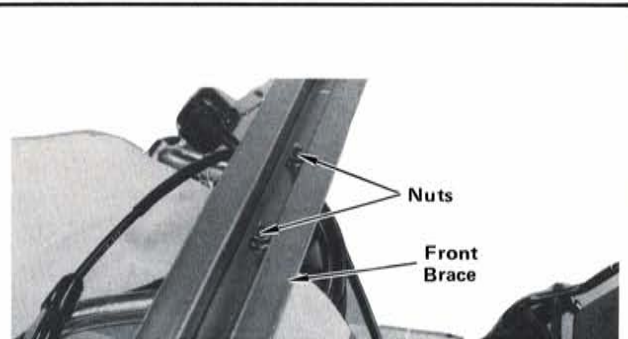

STEP 4—Remove and discard the nuts and the front and rear braces.

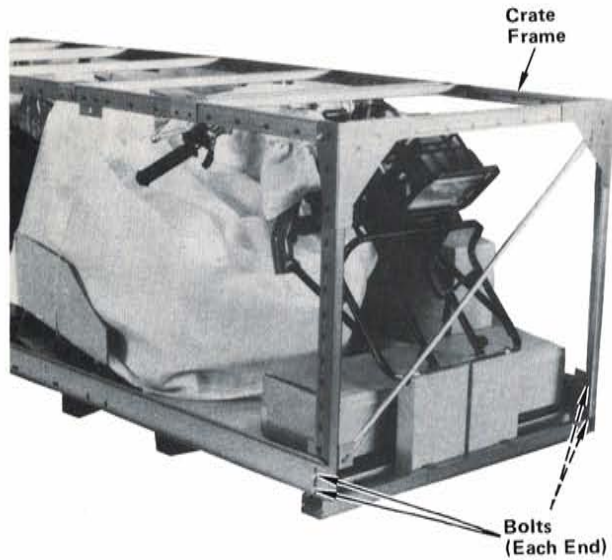

STEP 5—Remove and discard the four bolts from each end of the crate frame. Using two people, carefully lift off the frame and discard it.

CAUTION: Use extreme care not to damage the vehicle.

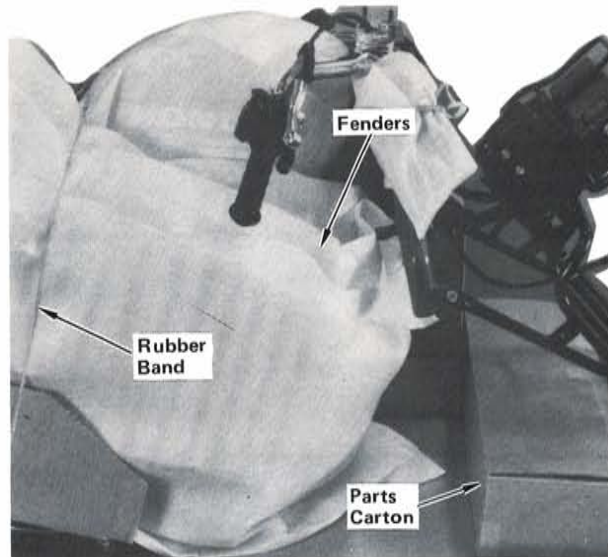

STEP 6—Remove the rubber band and the front and rear fenders. Remove the parts carton.

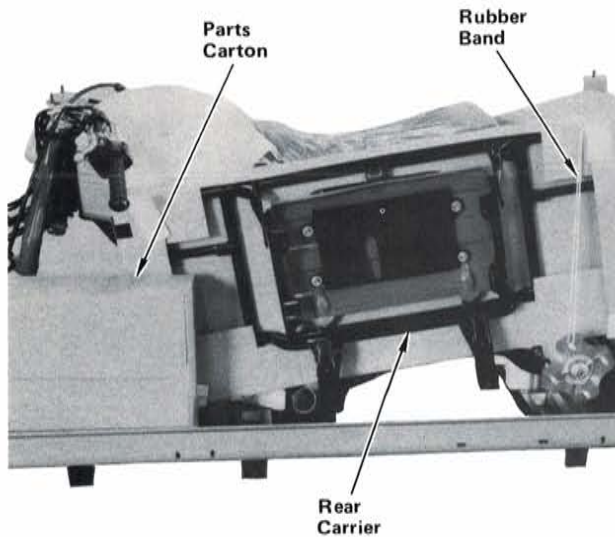

STEP 7—Remove the rubber band and the rear carrier. Remove the parts carton.

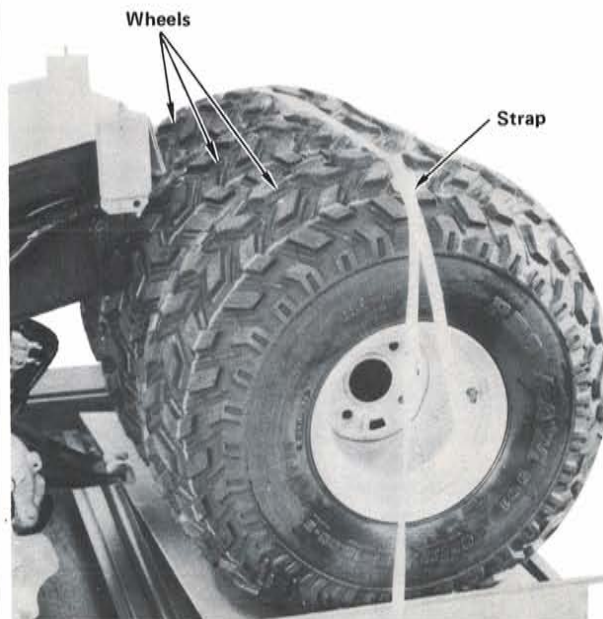

STEP 8—Cut the strap and remove the three wheels.

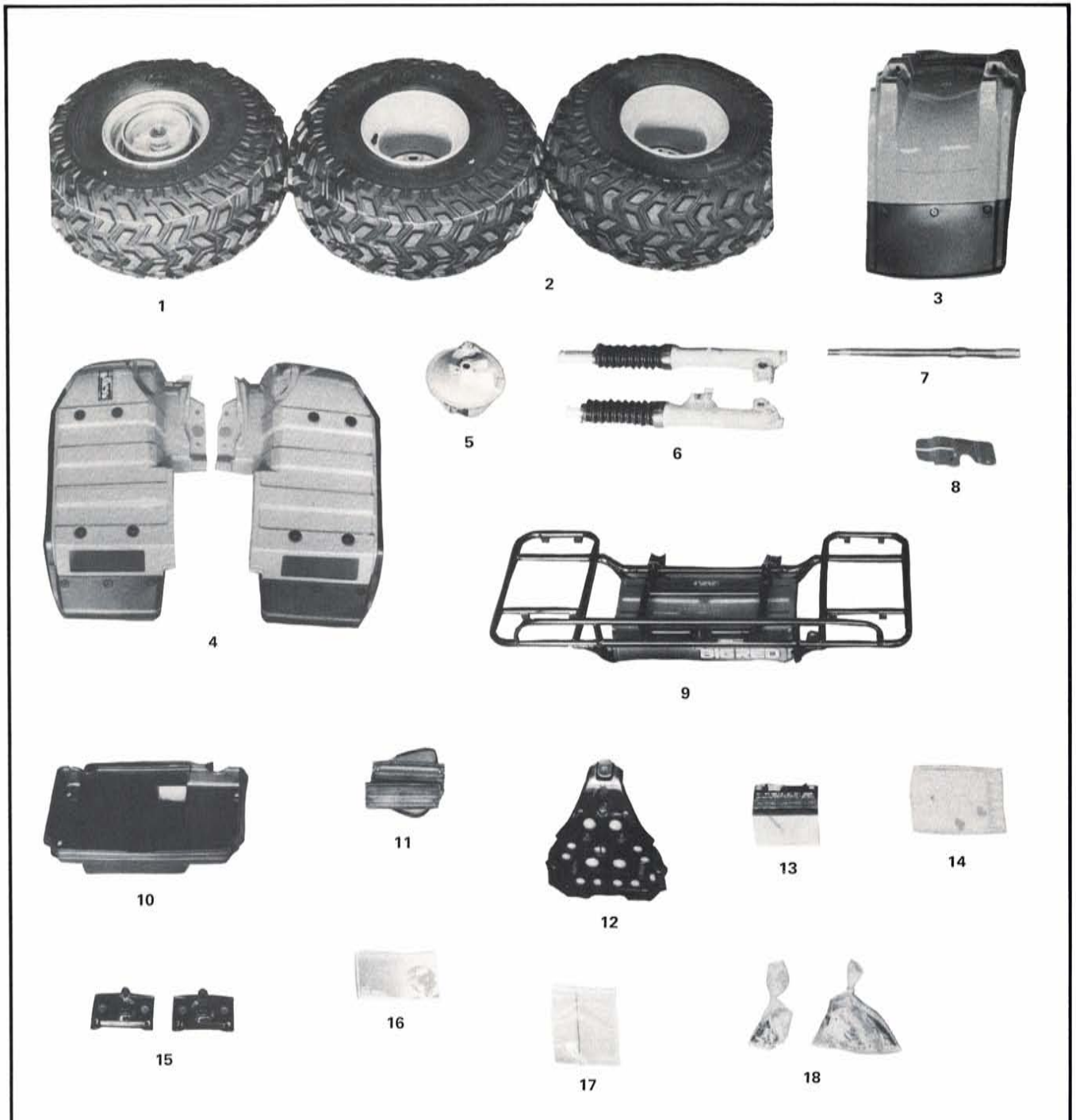

STEP 9—Unpack the loose parts and check them against the illustration above and the loose parts list on the following page. Report any damaged or missing parts immediately to: American Honda Motor Co., Inc., 100 West Alondra Blvd., Gardena, California 90248-2702.

Damaged and/or Missing Parts

It is necessary to differentiate between parts lost or damaged in transit and parts left out by the factory.

- For parts lost or damaged in transit, file a SHIPPING DAMAGE CLAIM.
- For parts left out by the factory, file an M/C WARRANTY CLAIM — S0908.

Order all parts through the normal parts ordering system.

LOOSE PARTS LIST

ITEM	DESCRIPTION	QTY	H/C	PART NUMBER
1.	Front wheel assy.	1	-----	-----
2.	Rear wheel assy.	2	-----	-----
3.	Front fender	1	-----	-----
4.	Rear fender, RH	1	-----	-----
	Rear fender, LH	1	-----	-----
5.	Front brake panel	1	-----	-----
6.	Front fork, RH	1	2088110	51400-HA0-681
	Front fork, LH	1	2088136	51400-HA0-681
7.	Front axle	1	2087948	44301-HA0-680
	Axle collar	1	1822659	44312-HA0-000
8.	Rear fender protector	1	2078640	80105-HA0-000
9.	Rear luggage carrier	1	-----	-----
10.	Luggage box	1	-----	-----
	Luggage box cover	1	-----	-----
11.	Taillight	2	2087682	33700-HA0-013
12.	Engine guard	1	1822964	50360-NA0-000
13.	Battery	1	-----	-----
14.	Electrolyte	1	-----	-----
15.	Taillight bracket	2	-----	-----
16.	Owner's manual	1	-----	-----
17.	Owner's manual bag	1	-----	-----
18.	Attaching parts:			
	Wire band	2	0468819	32161-404-000
	Wire harness guide	1	1821875	33717-HA0-000
	Wire harness guide	1	1821883	33718-HA0-000
	Front brake spring	1	1934116	45455-HA6-000
	Handlebar cover	1	2088243	53206-HA0-680
	Handlebar cover collar	2	1823426	53209-HA0-000
	Handlebar cover rubber	2	1823434	53210-HA0-000
	Fender collar	8	0763946	61104-444-000
	Rear carrier	2	1823848	81311-HA0-000
	Bolt, carrier	2	1824309	90102-HA0-000
	Bolt, flange 10 x 35 mm	2	1299189	90118-958-000
	Nut, rear wheel	8	2009397	90314-VM0-771
	Washer, 6 mm	2	1824523	90343-SA0-000
	Washer, 6 x 20 mm	4	1892223	90505-HA0-000
	Washer, 6 x 20 mm	4	0191494	90512-300-000
	Screw, pan 6 x 40 mm	2	0057612	93500-06040
	Nut, flange 5 mm	4	0612171	94050-05080
	Washer, 6 mm	4	0629824	94103-06800
	Bolt, flange 6 x 10 mm	2	0350488	95700-06010-00
	Bolt, flange 6 x 12 mm	12	0252254	95700-06012-08
	Bolt, flange 6 x 14 mm	4	0671198	95700-06014-00
	Bolt, flange 6 x 20 mm	4	0340331	95700-06020-08
	Bolt, flange 6 x 22 mm	4	0483925	95700-06022-00

STEP 9—(Continued)

STEP 10—Remove the two bolts and the front shipping brace. Remove the four bolts and the rear shipping braces. Discard the bolts and braces. Remove the ties from the cables and wiring harness as shown. Remove the protective covers.

STEP 11—Remove the two bolts and the handlebar holders, and route the indicator lights wire harness under the handlebars as shown.

STEP 12—Align the punch mark on the handlebar with the lower holder and install the upper holders, with their punch marks forward, using four 8 x 35 mm flange bolts. Tighten the front two bolts to the specified torque first, then the rear bolts.

Torque specifications:
2.4 kg-m, (18 lb-ft)

STEP 13—Secure the wire harnesses under the coupler box bracket, using the clamps provided as shown.

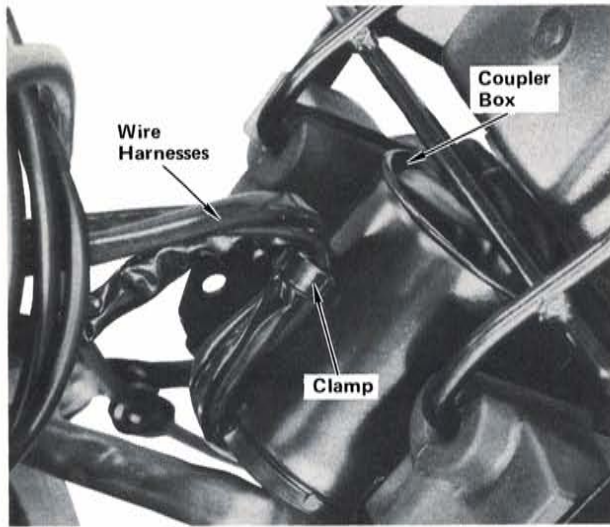

STEP 14—Secure the wire harnesses using the clamp provided on the coupler box as shown.

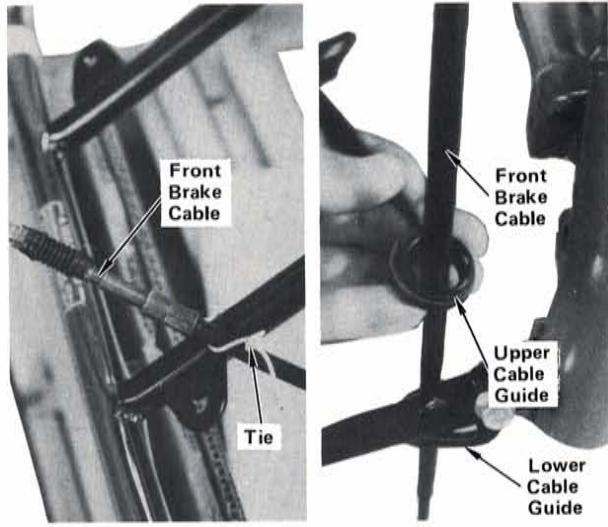

STEP 15—Remove the tie holding the front brake cable and route the cable through the upper and lower cable guides as shown.

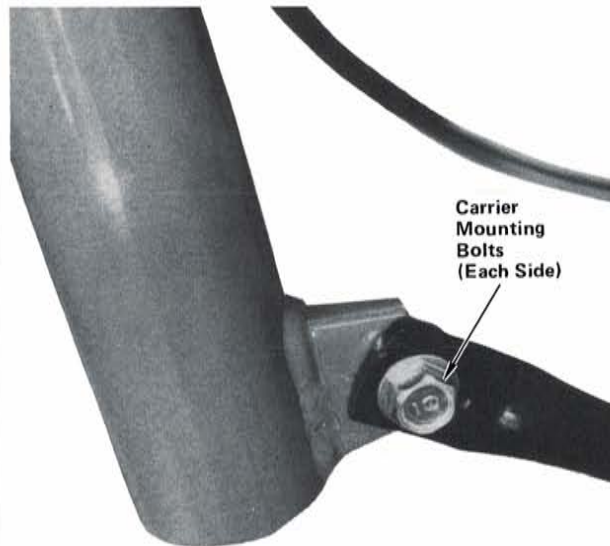

STEP 16—Loosen the front carrier lower mounting bolts.

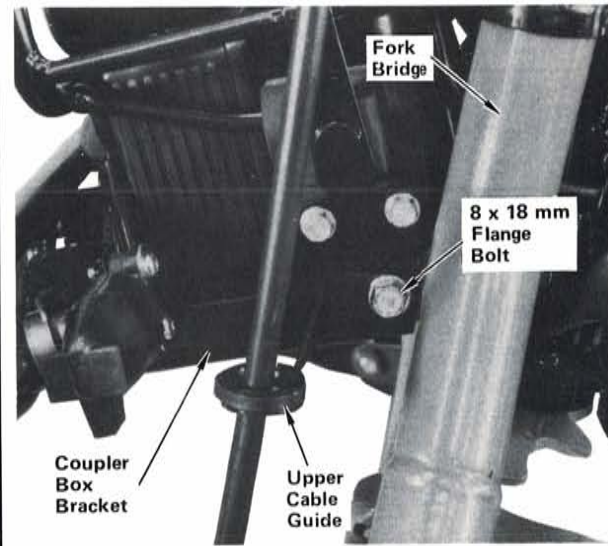

STEP 17—Swing the front carrier up to position the coupler box bracket against the fork bridge. Install the upper cable guide on the left side using an 8 x 18 mm flange bolt as shown, but do not tighten yet.

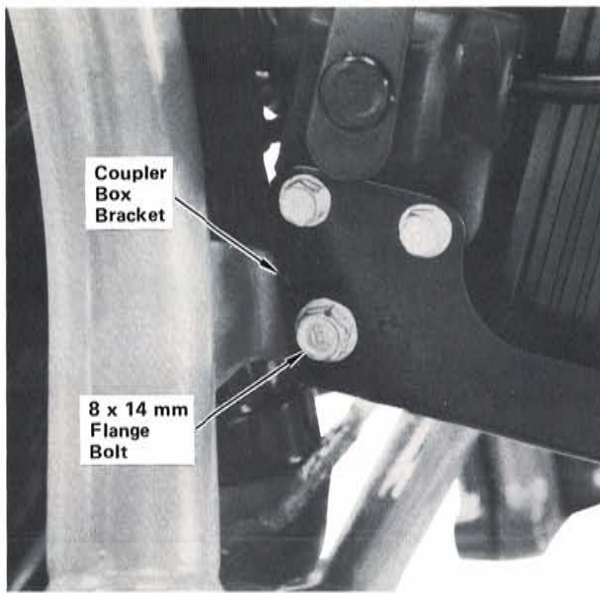

STEP 18—Attach the coupler bracket on the right side using an 8 x 14 mm flange bolt. Tighten this bolt and the bolt installed in step 17.

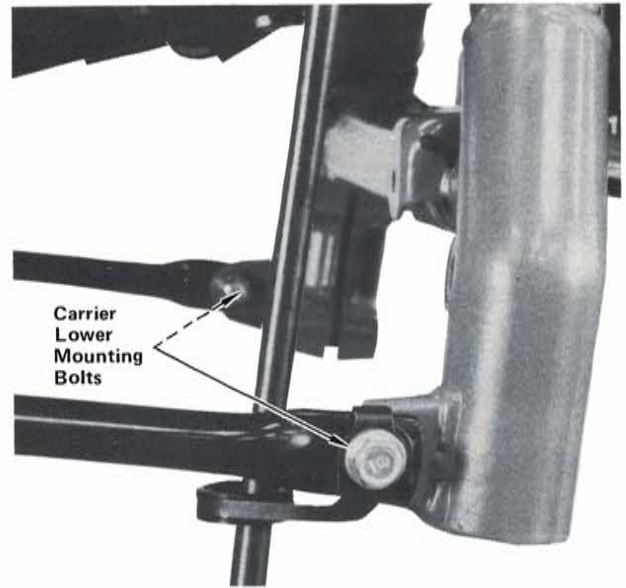

STEP 19—Tighten the carrier lower mounting bolts, both sides.

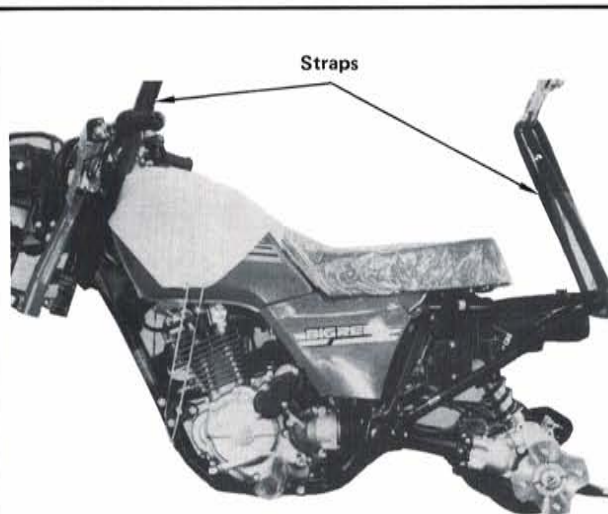

STEP 20—Position straps as shown and carefully lift vehicle from the crate base. Remove and discard the base.

CAUTION: Be sure that the straps are not around any cables, wire harnesses or fuel lines. Keep the straps away from the fuel tank.

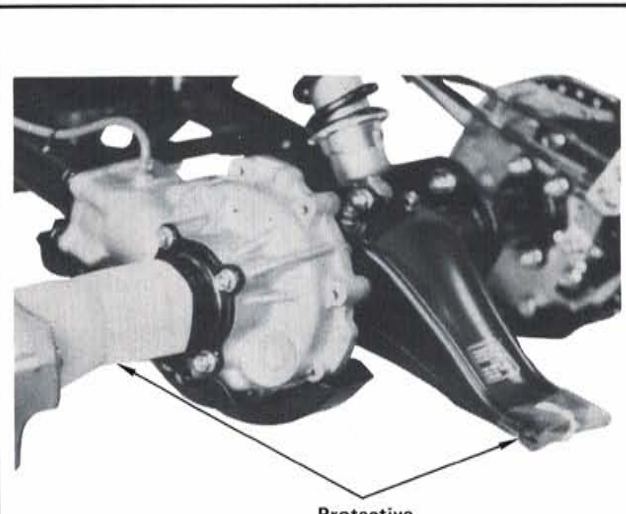

STEP 21—Remove and discard the protective covers from the rear hitch and axles.

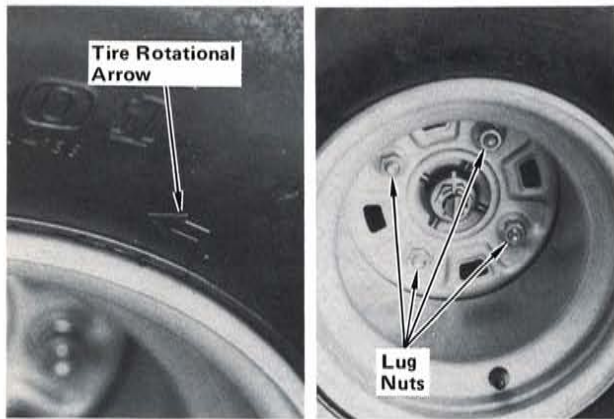

STEP 22—Position the rear wheels on the hubs with the tire rotational arrows (located on the sidewalls) pointing toward normal, forward direction of wheel rotation. Attach the wheels using four lug nuts on each side.

NOTE: Be sure that tapered side of the lug nut is installed toward the wheel. Tighten the lug nuts to the specified torque in crisscross pattern. Lower the vehicle to the floor and remove the sling.

Torque specification:
5.5 kg-m (40 lb-ft)

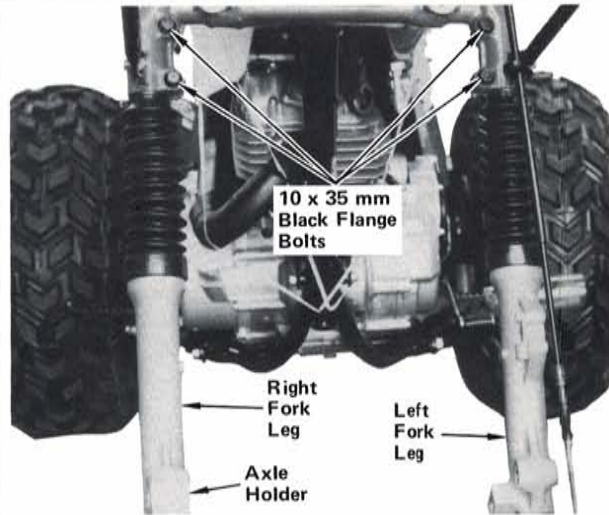

STEP 23—Insert the fork leg with the axle holder into the right side lower fork bridge and the other fork leg into the left side. Align the groove on the fork tubes with the upper bolt hole in the fork bridge (each side) and install four black 10 x 35 mm flange bolts as shown. Tighten to the specified torque.

Torque specification:
5.5 kg-m (40 lb-ft)

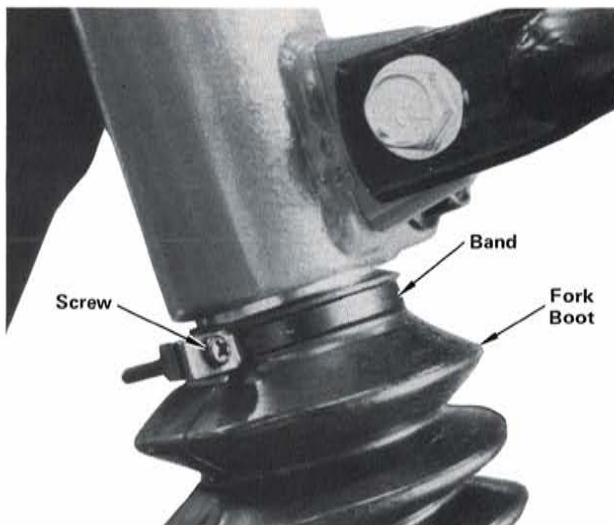

STEP 24—Loosen the fork boot band screws and locate them as shown. Tighten the screws securely.

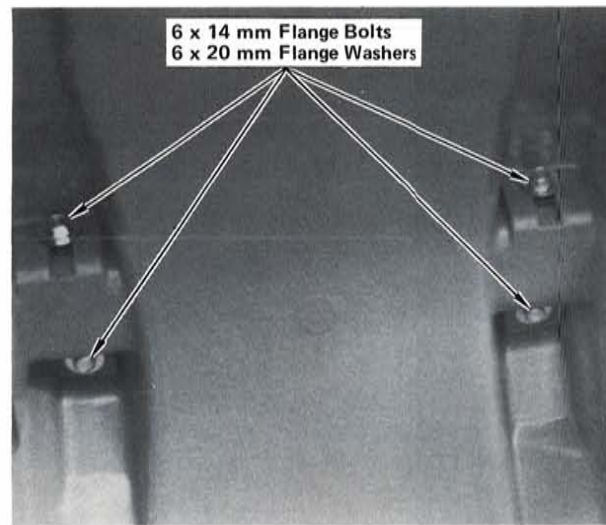

STEP 25—Attach the front fender using four 6 x 14 mm flange bolts and four 6 x 20 mm flanged washers. Tighten bolts to the specified torque.

Torque specification:
1.0 kg-m (8 lb-ft)

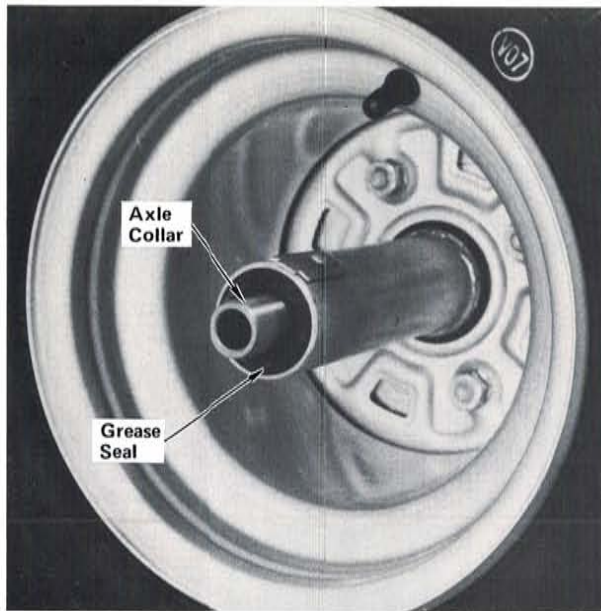

STEP 26—Insert axle collar into front wheel grease seal as shown.

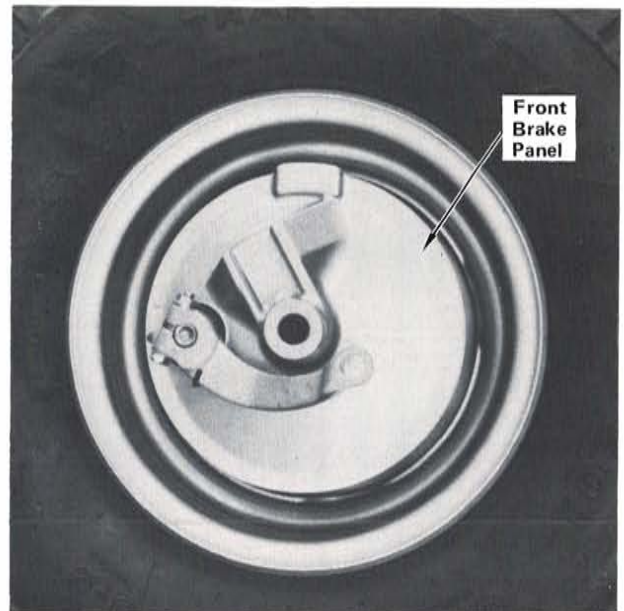

STEP 27—Clean front wheel brake drum and brake linings. Insert front brake panel into brake drum as shown.

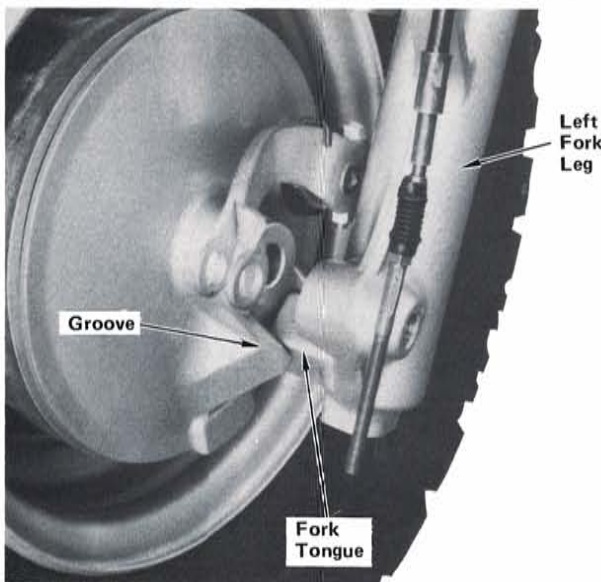

STEP 28—Position front wheel between front fork legs with brake panel on left, and align groove on brake panel with tongue on left fork leg.

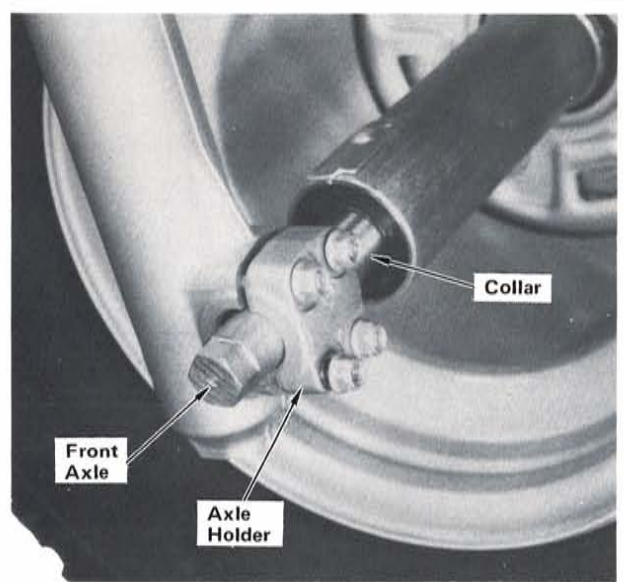

STEP 29—Loosen axle holder nuts. Insert front axle from right side, between axle holder and right fork leg, through axle collar, wheel hub, and screw into left fork leg. Tighten axle to specified torque.

Torque specification:
 9.0 kg-m (68 lb-ft)

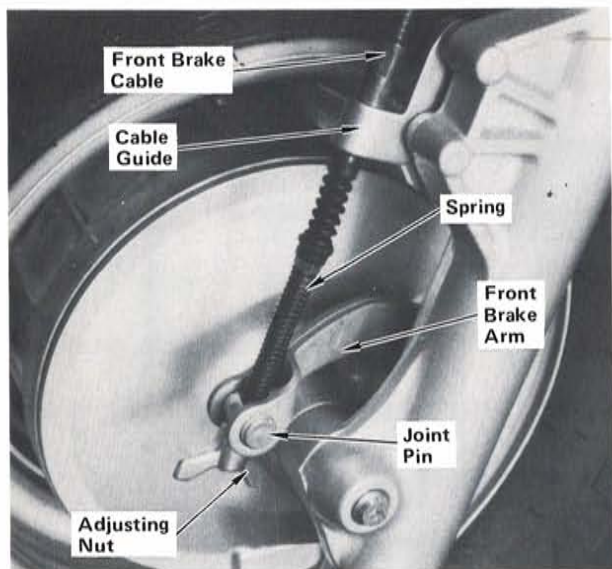

STEP 30—Insert front brake cable through cable guide on left fork leg as shown. Slip spring over end of front brake cable. Connect cable to brake arm using a joint pin and adjusting nut as shown. Insert cable end into slot in front brake hand lever and pull back through slots in knurled nut and cable adjuster. Adjust front and rear brakes as described in Steps 64 through 66.



STEP 31—Secure left handlebar switch wires to handlebar using two wire bands positioned where shown.



STEP 32—Press two special collars into holes of handlebar cover from underneath as shown.

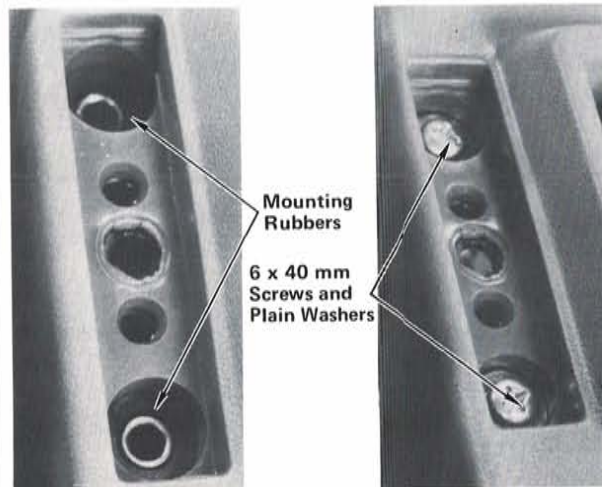

STEP 33—Position the handlebar cover on the handlebar and insert two mounting rubbers into mounting holes. Attach the cover using two 6 x 40 mm screws and two 6 mm plain washers.

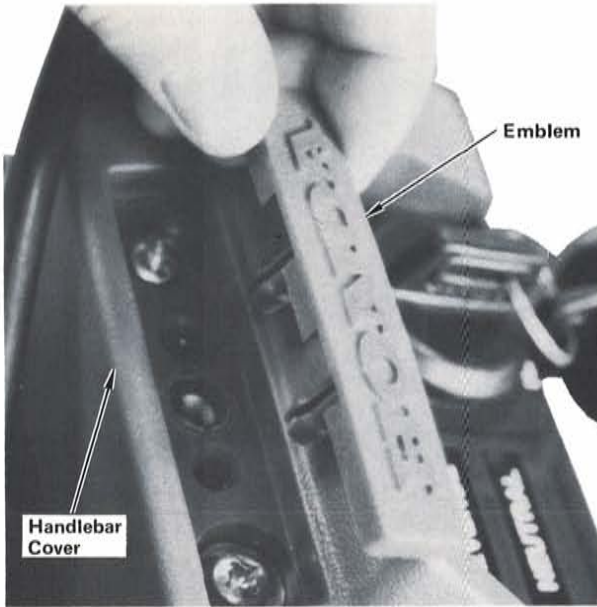

STEP 34—Press emblem into handlebar cover as shown.

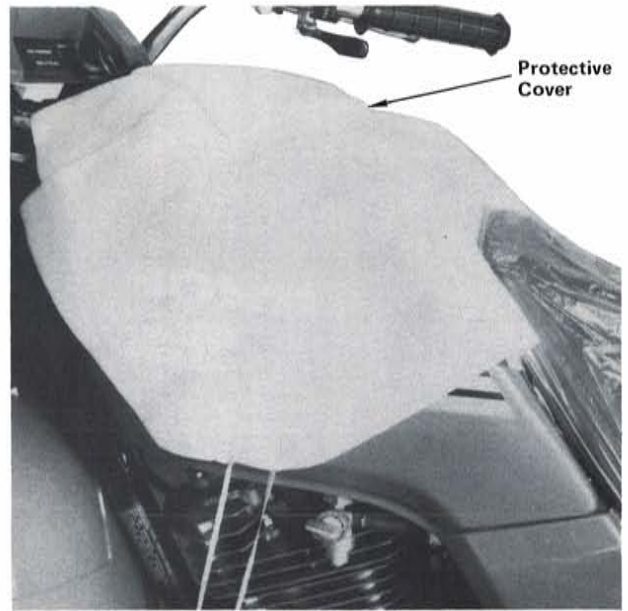

STEP 35—Remove protective covering from fuel tank.

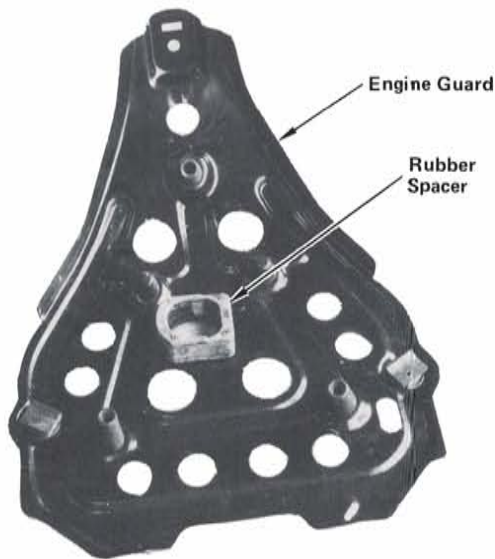

STEP 36—Position rubber spacer over drain plug hole in engine guard as shown.

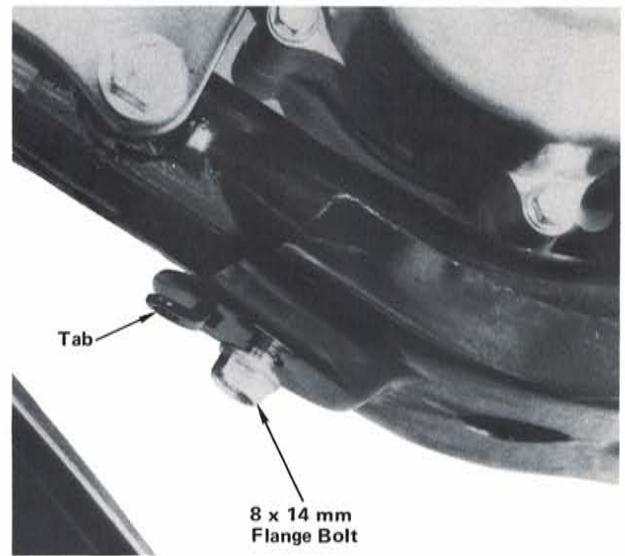

STEP 37—Insert tab on frame into slot in engine guard as shown. Attach front of engine guard to frame using an 8 x 14 mm flange bolt. Do not tighten bolt at this time.

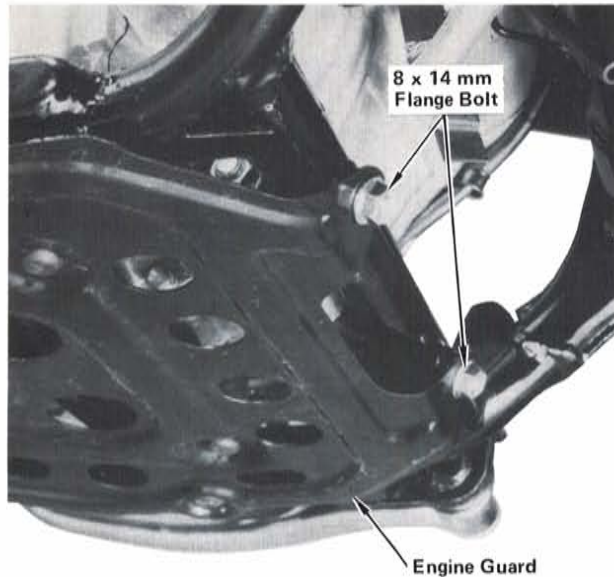

STEP 38—Attach rear of engine guard to frame using two 8 x 14 mm flange bolts. Tighten all three engine guard bolts to specified torque.

Torque specification:
2.7 kg-m (19 lb-ft)

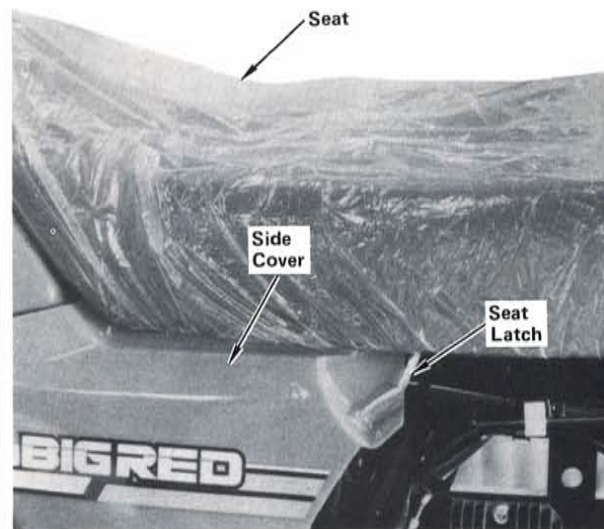

STEP 39—Remove seat by pulling seat latch lever. Remove right and left side covers.

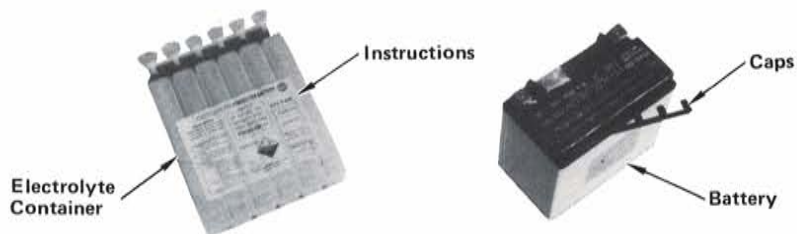

STEP 40—Remove vinyl cover from battery. Service battery as described in battery booklet or on battery preparation label on battery electrolyte container.

WARNING

- The battery electrolyte contains sulfuric acid. Protect your eyes, skin and clothing. In case of contact, flush thoroughly with water.
- If electrolyte gets in your eyes, flush them thoroughly with water and get prompt medical attention.
- The battery generates hydrogen gas which can be highly explosive. Do not smoke or allow flames near the battery especially while charging it.

CAUTION:

- Do not activate the battery unless the ATC is to be delivered immediately after set-up and pre-delivery service. Refer to SERVICE LETTER SL #48 for important information about the features, storage and activation of maintenance free batteries.
- Do not use the electric starter immediately after installation of the battery, allow some time for the battery to attain a full charge.
- Remove the battery from the vehicle whenever filling it with electrolyte.
- Do not use any liquids other than those furnished with the battery.
- After filling the battery be sure there is no electrolyte left in the container.
- Dispose of the container properly.

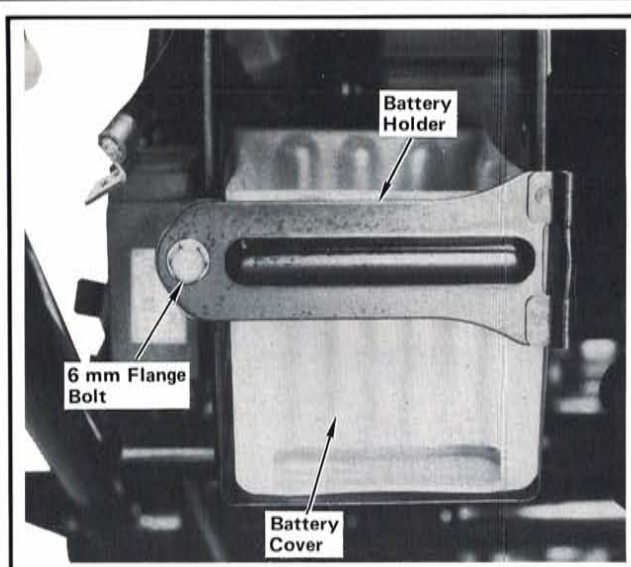

STEP 41—Remove and retain flange bolt attaching battery holder. Swing open battery holder and remove battery cover.

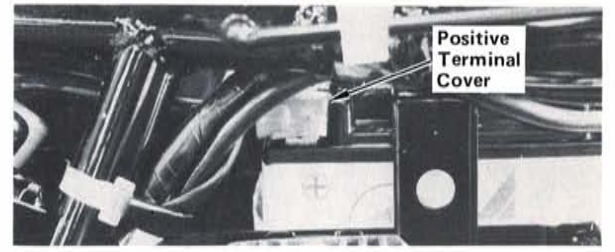
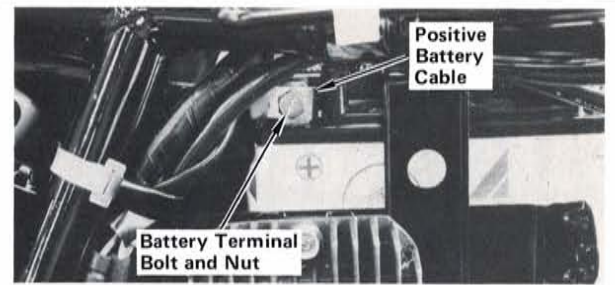

STEP 42—Check that ignition switch is off. Place battery in battery cover and slide into battery compartment with terminals facing left side. Connect positive battery cable (cable with terminal cover) to battery positive (+) terminal using a battery terminal bolt and nut as shown. Tighten bolt securely and coat terminal with clean grease. Slip terminal cover over positive terminal.

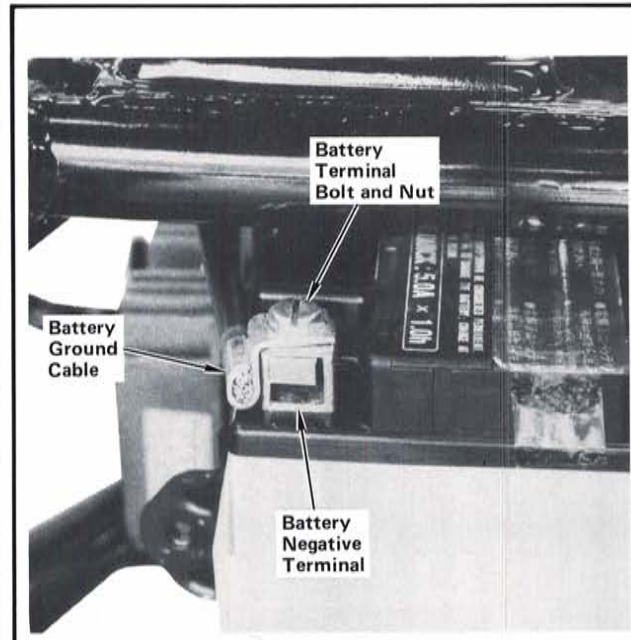

STEP 43—Connect ground cable to battery negative (-) terminal using a battery terminal bolt and nut as shown. Tighten bolt securely and coat terminal with clean grease.

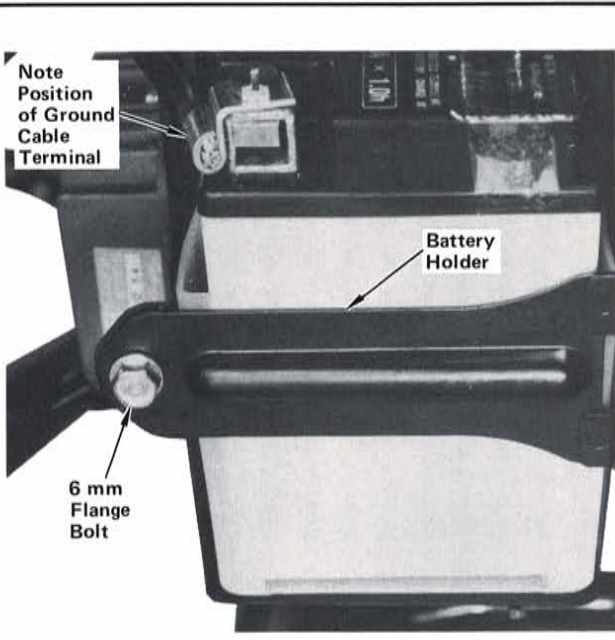

STEP 44—Close battery holder and secure with flange bolt removed in Step 41. Tighten bolt securely.

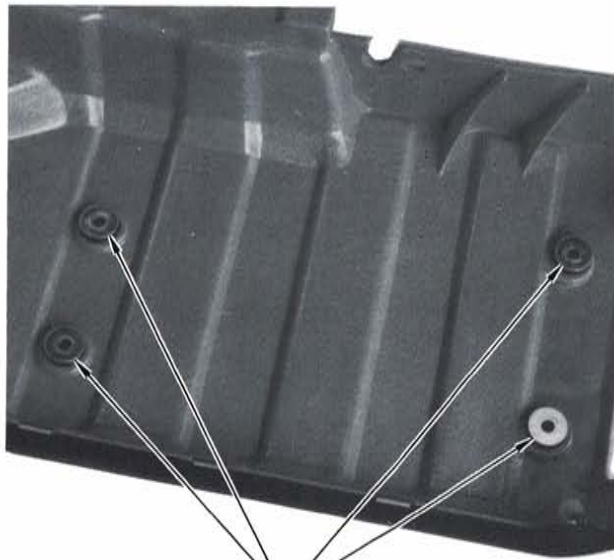

Collars
(Both Fenders)

STEP 45—Install the flanged collars into the grommets in the rear fenders as shown.



Rear
Fender

Rear
Carrier

STEP 46—Position rear fenders on rear carrier.

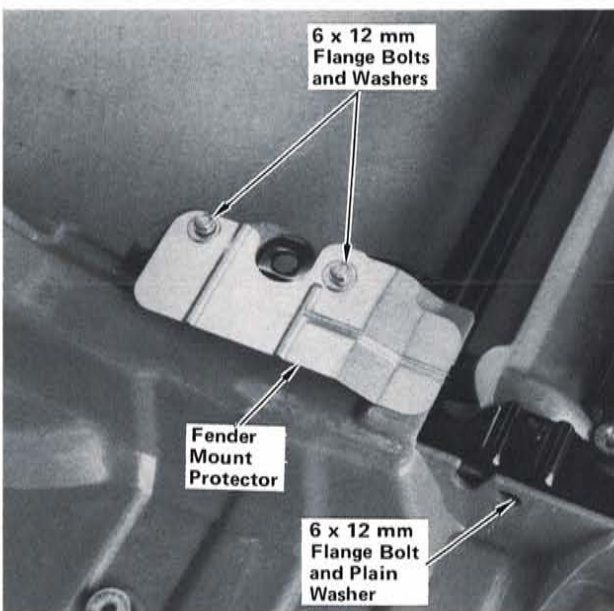

6 x 12 mm
Flange Bolts
and Washers

Fender
Mount
Protector

6 x 12 mm
Flange Bolt
and Plain
Washer

STEP 47—Attach the fender mount protector under the right rear fender as shown using two 6 x 12 mm flange bolts and plain washers. Attach the right fender to the carrier using a 6 x 12 mm flange bolt and plain washer. Do not tighten bolts yet.

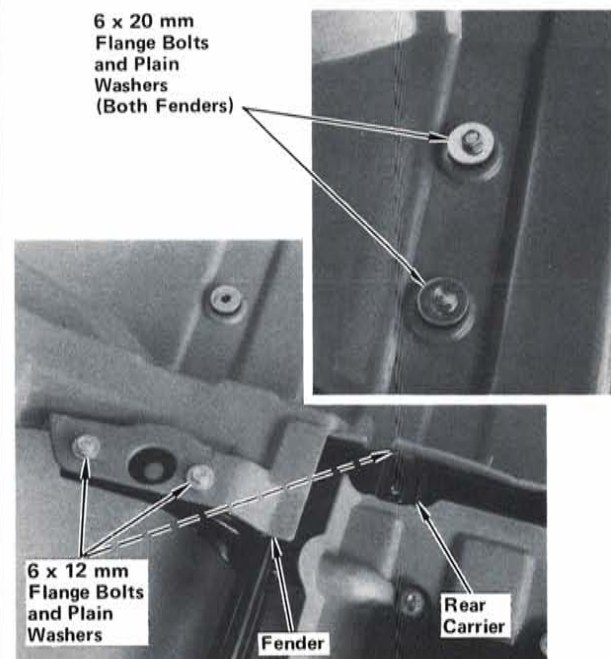

6 x 20 mm
Flange Bolts
and Plain
Washers
(Both Fenders)

6 x 12 mm
Flange Bolts
and Plain
Washers

Fender

Rear
Carrier

STEP 48—Attach the left fender using three 6 x 12 mm flange bolts. Install two 6 x 20 mm flange bolts and washers through the two forward holes, in each fender, that have the collars and grommets. Do not tighten bolts yet.

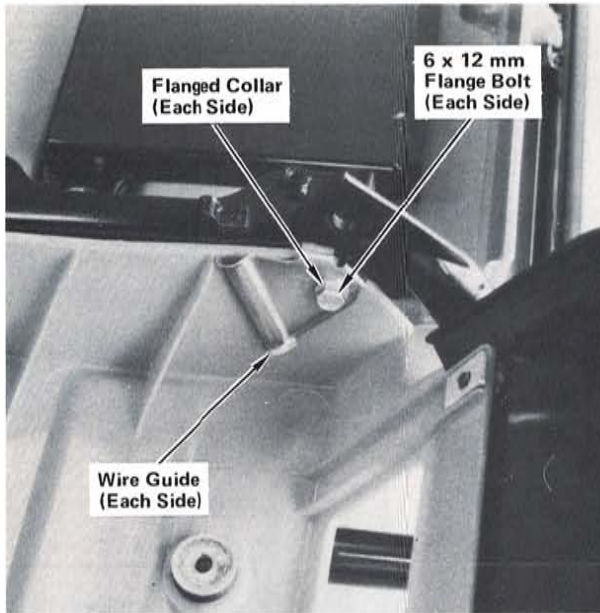

STEP 49—Loosely install taillight wire guide using a 6 x 12 mm flange bolt through wire guide and a flanged collar through fender and into rear carrier as shown for each fender. Do not tighten bolts yet.

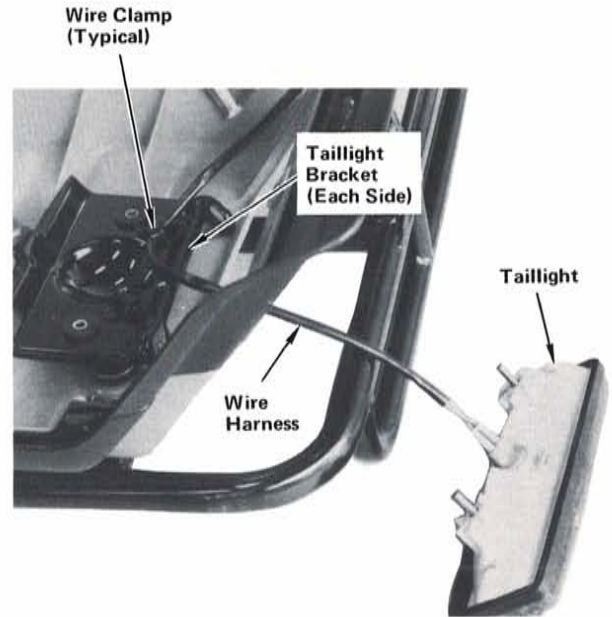

STEP 50—Route taillight wire harness through opening in rear fender and wire clamp of taillight bracket for each rear fender as shown.

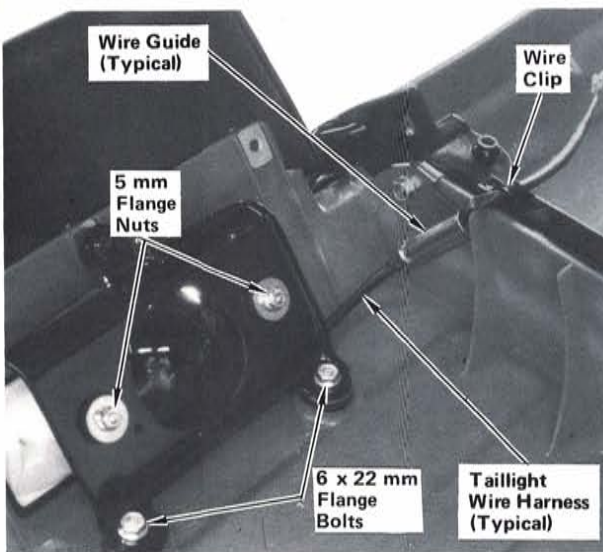

STEP 51—Install each taillight as shown using two 5 mm flange nuts and two 6 x 22 mm flange bolts for each. Tighten the 5 mm nuts securely. Route taillight wire harness through wire guide and wire clip for each taillight as shown.

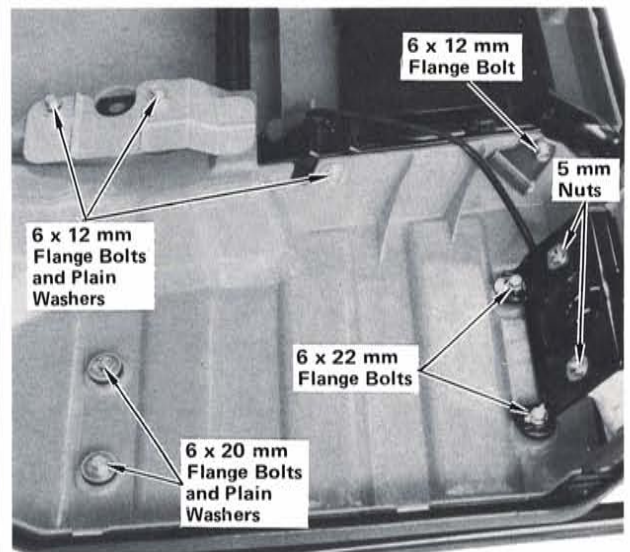

STEP 52—Tighten all 6 mm bolts installed in previous steps to specified torque.

Torque specification:
1.2 kg-m (9 lb-ft)

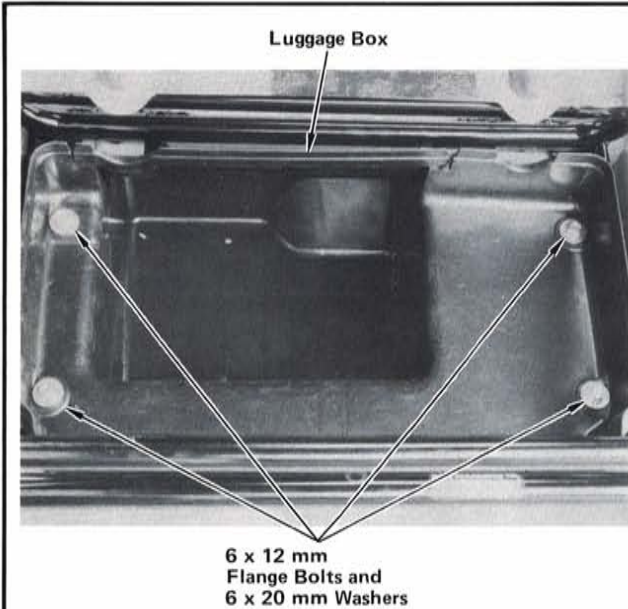

STEP 53—Position luggage box on rear carrier as shown and install using four 6 x 20 mm washers and 6 x 12 mm flange bolts. Tighten bolts to specified torque.

Torque specification:
1.2 kg-m (9 lb-ft)

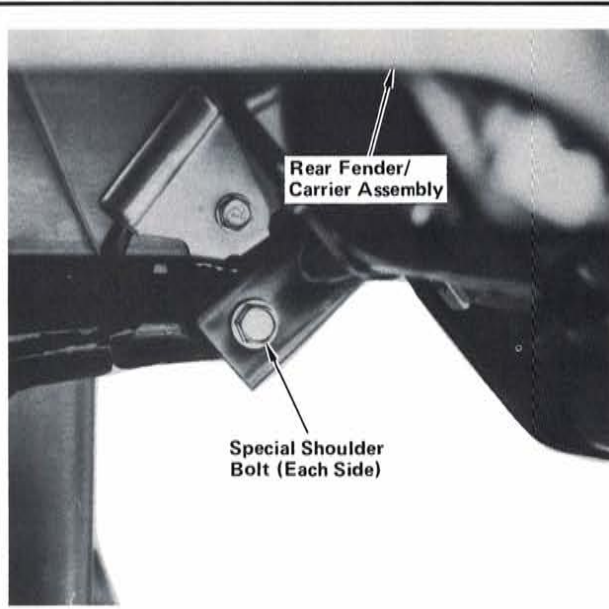

STEP 54—Position rear fender/rear carrier on frame as shown and install using two special shoulder bolts through carrier into frame. Tighten bolts to specified torque.

Torque specification:
2.7 kg-m (20 lb-ft)

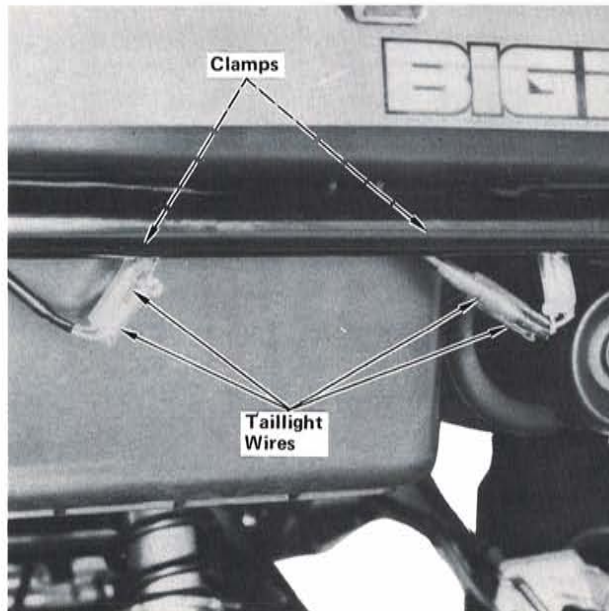

STEP 55—Connect the taillight wires, color to color and tuck the wires up between the frame and trunk. Secure the wires using the clamps on the frame.

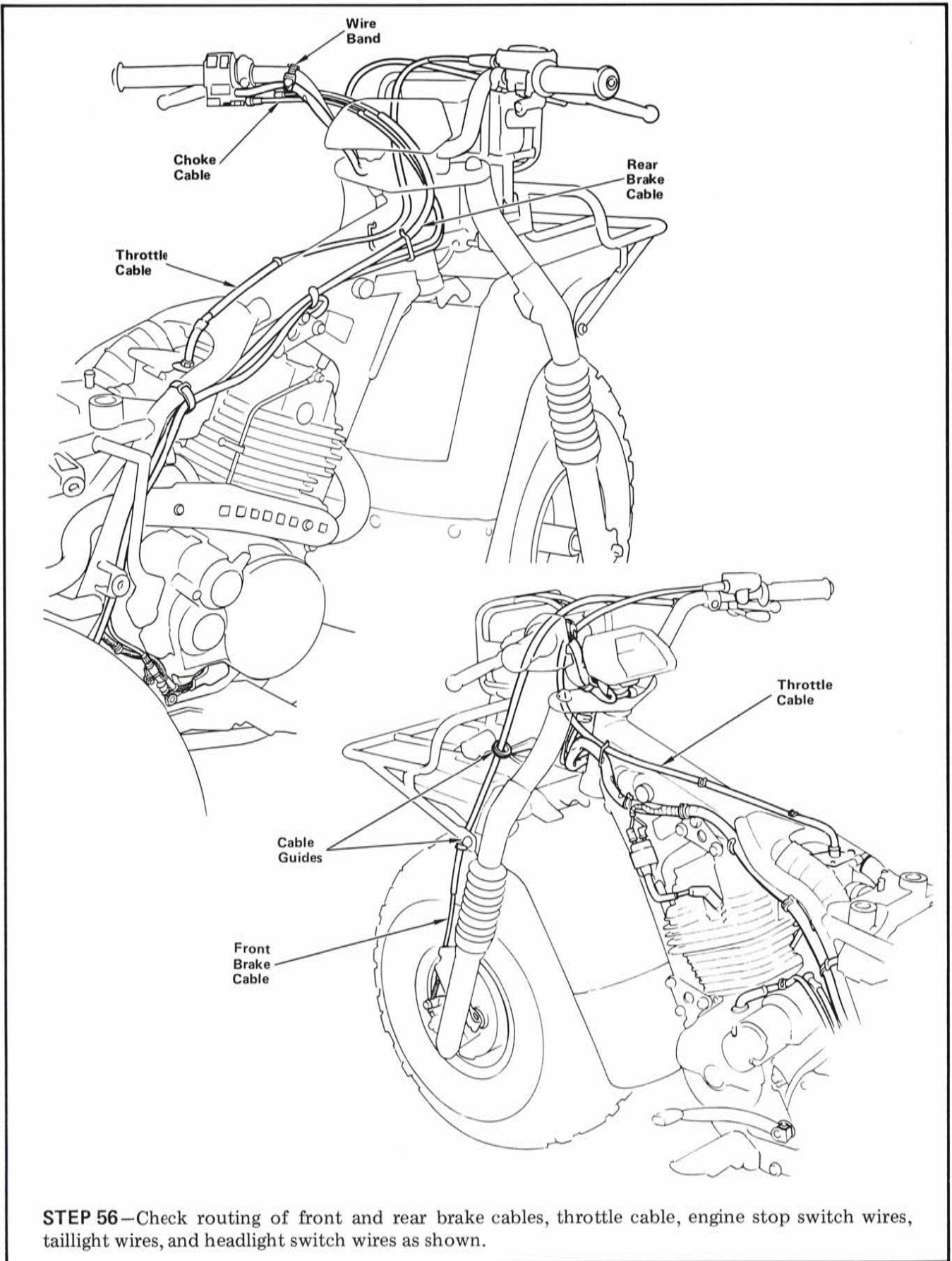

STEP 56—Check routing of front and rear brake cables, throttle cable, engine stop switch wires, taillight wires, and headlight switch wires as shown.

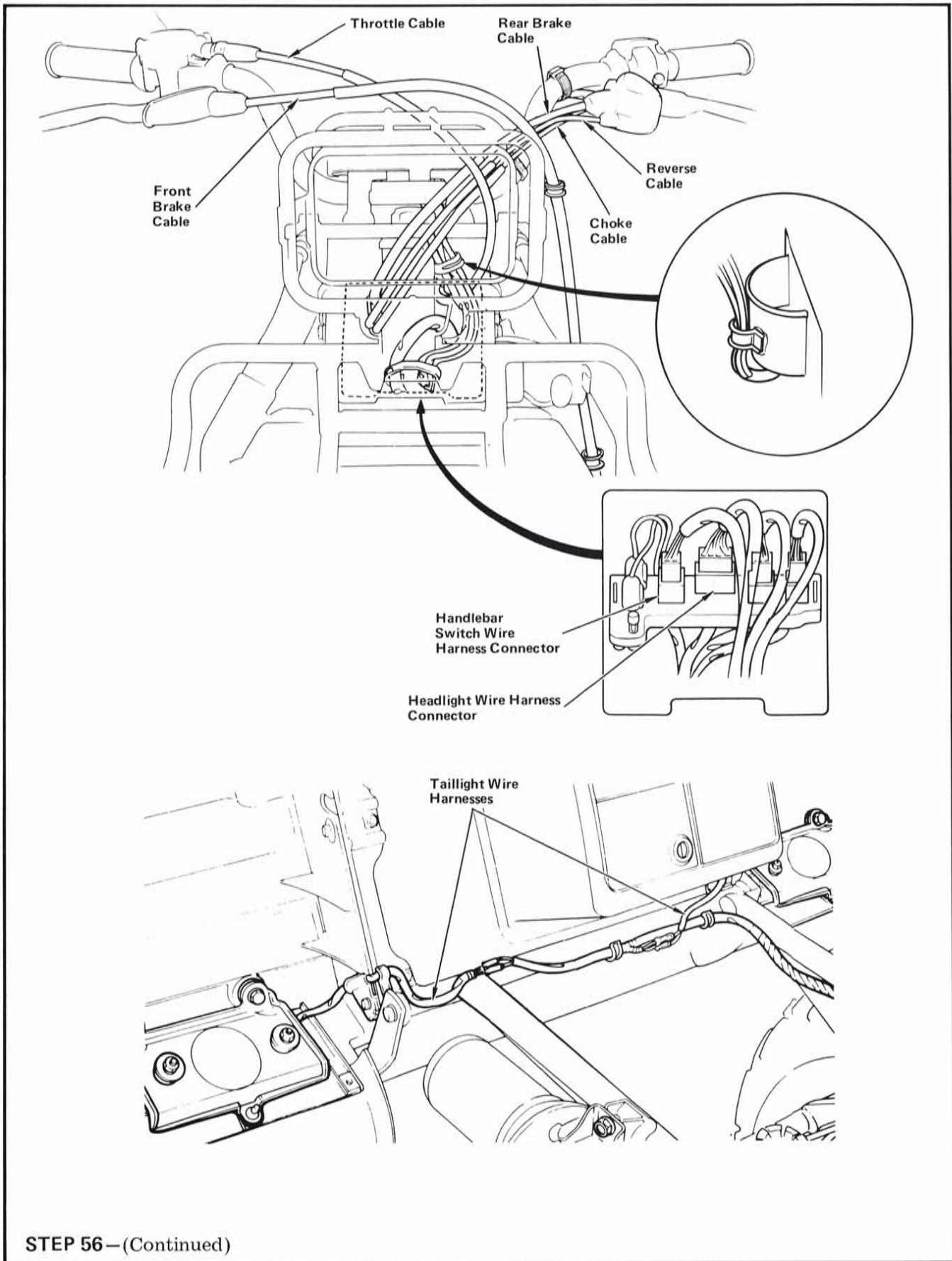

STEP 56—(Continued)

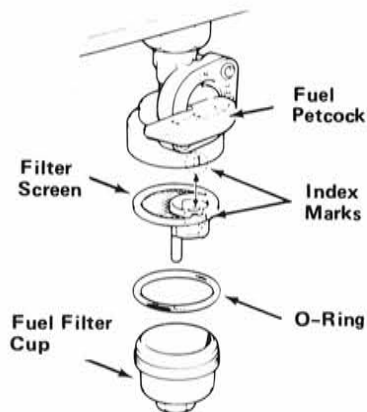
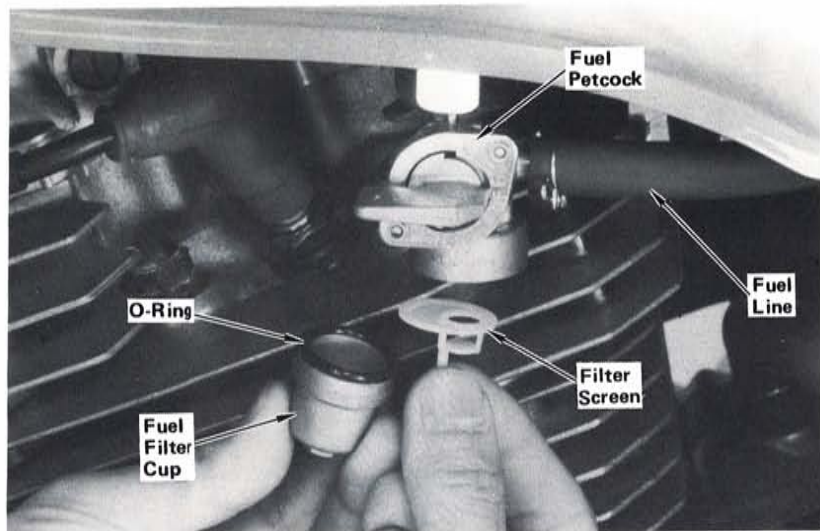

STEP 57—Turn fuel petcock to OFF. Remove fuel filter cup and wash cup and filter screen in clean non-flammable or high flash point solvent. Drain, flush and inspect fuel tank. Reinstall filter screen and O-ring, aligning index marks on filter screen and fuel petcock body. Install filter cup and tighten to a torque of 0.4 kg-m (3 lb-ft). Drain residual fuel from carburetor.

WARNING Fuel must be drained into a proper container. Gasoline is flammable and is explosive under certain conditions. Do not smoke or allow flames or sparks near the equipment while draining fuel.

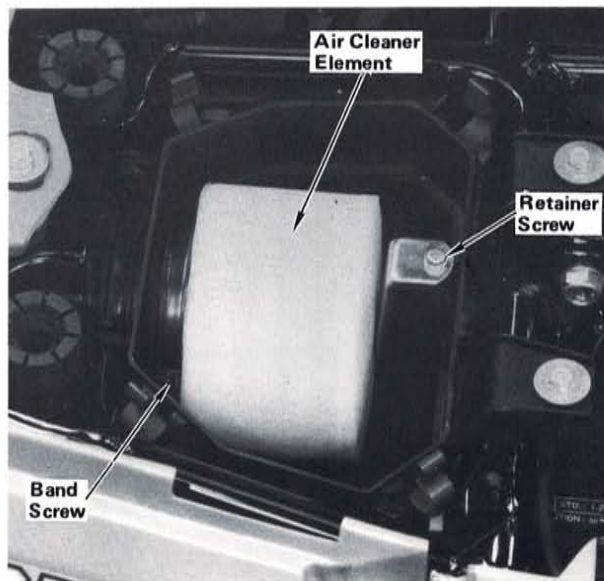
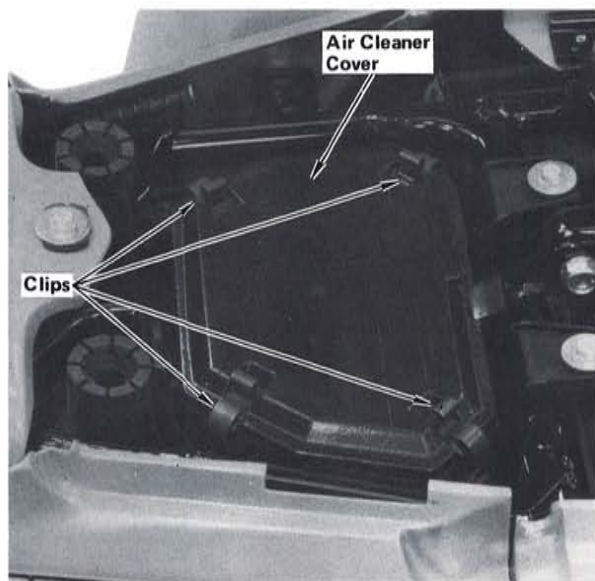

STEP 58— Release four clips attaching air cleaner cover and remove cover. Loosen band screw and remove retainer screw. Remove air cleaner element. Check condition of element. If necessary, clean and oil element as described in owner's manual or shop manual. Reinstall element. Tighten retainer screw and band screw securely. Reinstall cover. Make sure clips are secure.



STEP 59—Remove oil filler cap from final drive gear case. Check that oil level is even with lower edge of oil filler hole. If necessary, add recommended oil. Reinstall and tighten oil filler cap.

Recommended oil:

Hypoid Gear Oil SAE 80

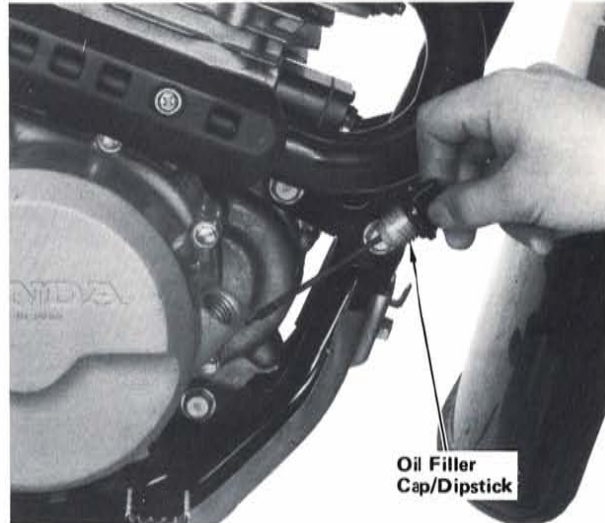

STEP 60—Remove oil filler cap/dipstick and fill crankcase with recommended oil as described in owner's manual. Reinstall and tighten oil filler cap/dipstick.



STEP 61—Connect a tachometer and check transmission in neutral. Start engine and allow it to warm up to operating temperature and check idle speed at $1,400 \pm 100$ rpm. If necessary, adjust idle speed using throttle stop screw. Remove tachometer.

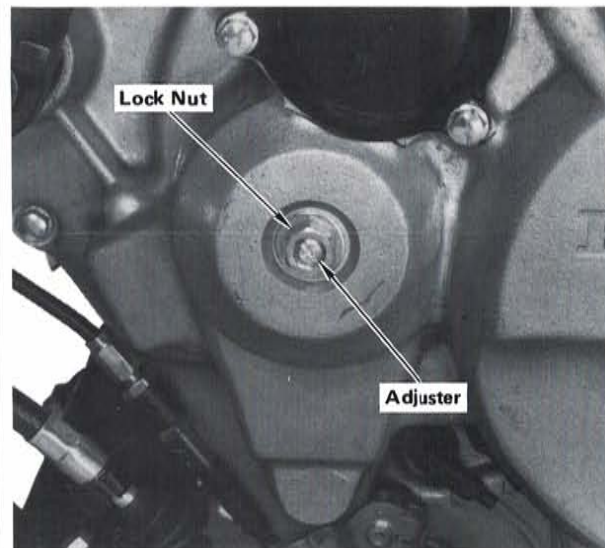

STEP 62—Check clutch operation. If adjustment is necessary, use the following procedure. Loosen lock nut and turn clutch adjuster counterclockwise until resistance is felt, then turn clutch adjuster $1/8$ – $1/4$ turn clockwise and tighten lock nut. Recheck clutch operation.

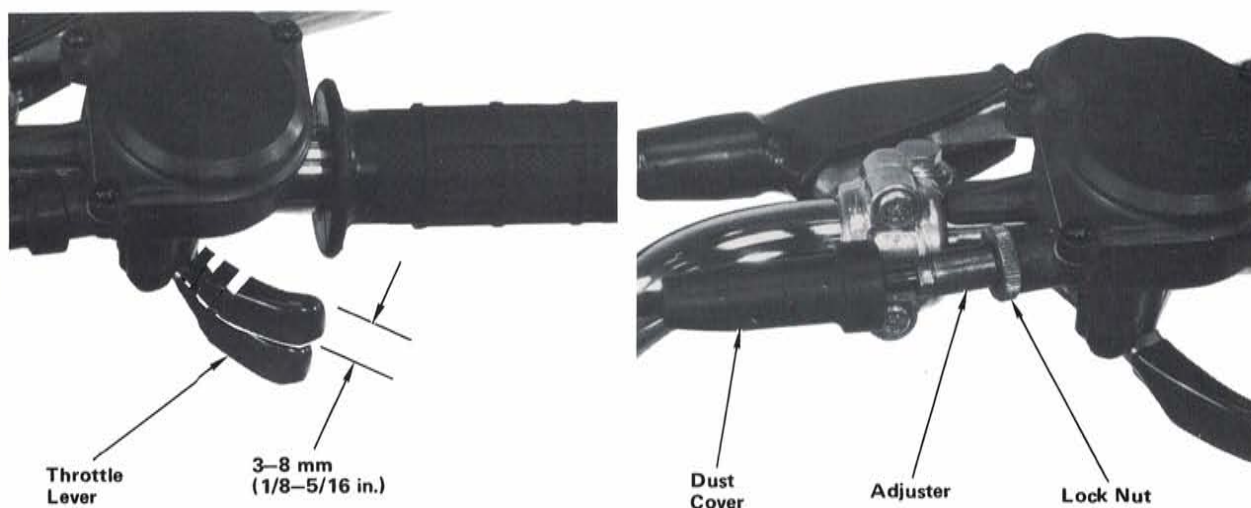

STEP 63—Check throttle cable for condition. Check that throttle lever free play is within 3–8 mm (1/8–5/16 in.) at tip of throttle lever. Check for smooth operation of throttle lever from fully closed to fully open in all steering positions and that throttle lever automatically returns from fully open to fully closed when released. If necessary to adjust free play, slide dust cover back to expose adjuster. Loosen lock nut and turn adjuster to obtain correct free play. After adjustment, tighten lock nut and reinstall dust cover.

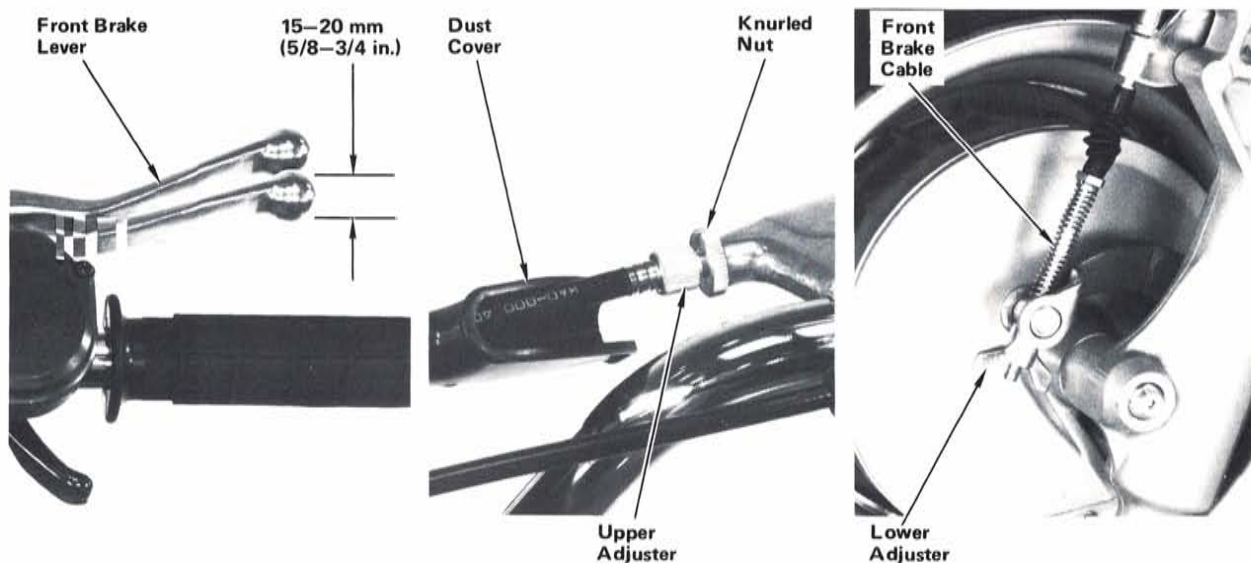

STEP 64—Raise front wheel off ground using a support block under engine. Spin front wheel by hand and measure free play of front brake hand lever before brake starts to engage. Free play, measured at tip of brake hand lever, should be between 15 and 20 mm (5/8–3/4 in.) Use lower adjuster to make large adjustments. Small adjustments are made at brake hand lever by sliding back dust cover, loosening knurled nut, and turning upper adjuster. After adjustment, tighten knurled nut and reinstall dust cover. Remove support block.

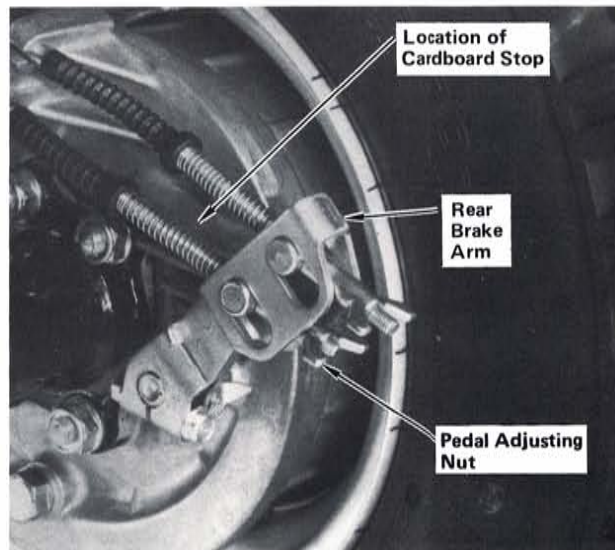
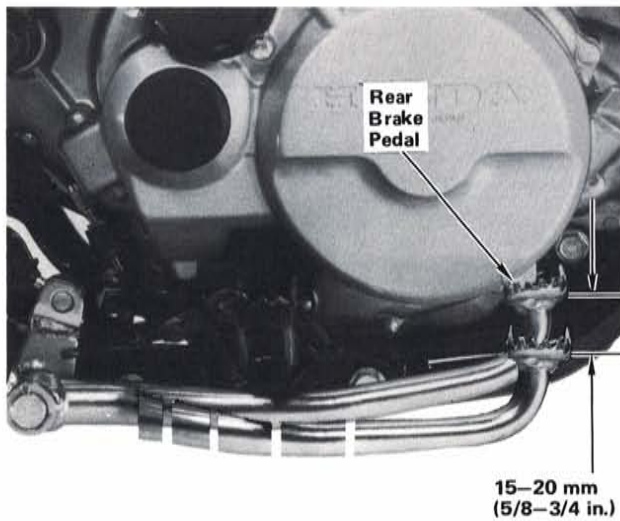

STEP 65—Raise rear wheels off ground using a support block under vehicle. Remove cardboard stop in front of rear brake arm. Rotate rear wheels by hand and measure free play before brake starts to engage. Free play, measured at tip of brake pedal, should be between 15 and 20 mm (5/8-3/4 in.). To adjust free play, turn adjusting nut. Turning adjusting nut clockwise will decrease free play.

15-20 mm
(5/8-3/4 in.)

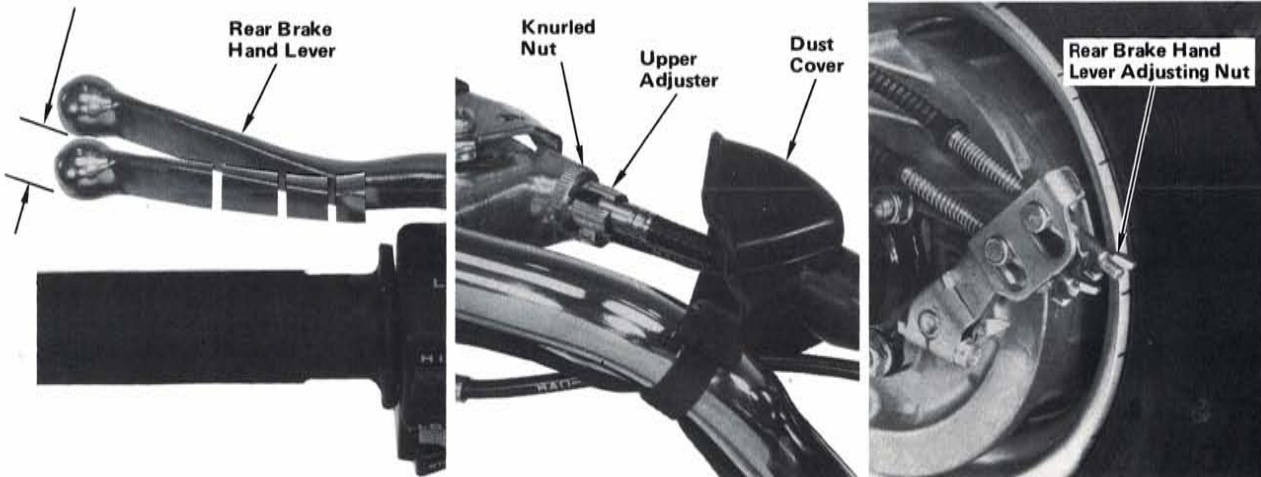

STEP 66—Spin rear wheels by hand and measure free play of rear brake hand lever before brake starts to engage. Free play, measured at tip of brake hand lever, should be between 15 and 20 mm (5/8-3/4 in.). Use lower adjuster to make large adjustments. Small adjustments are made at rear brake hand lever by sliding back dust cover, loosening knurled nut, and turning upper adjuster. After adjustment, tighten knurled nut and reinstall dust cover. Remove block under vehicle. Check parking brake operation.

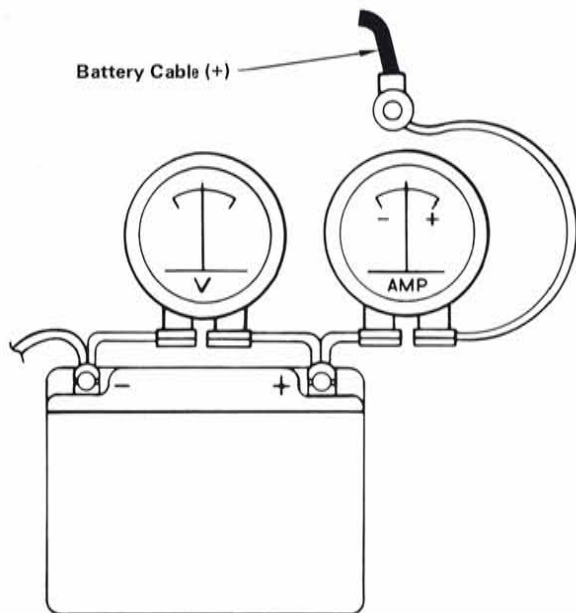

STEP 67—Check battery charging system (volts and amperes) at battery, as described in service manual.



STEP 68—Install right and left side covers by inserting prongs on side covers into rubber grommets on frame.

NOTE: Be sure kick starter pedal is folded before installing right side cover.

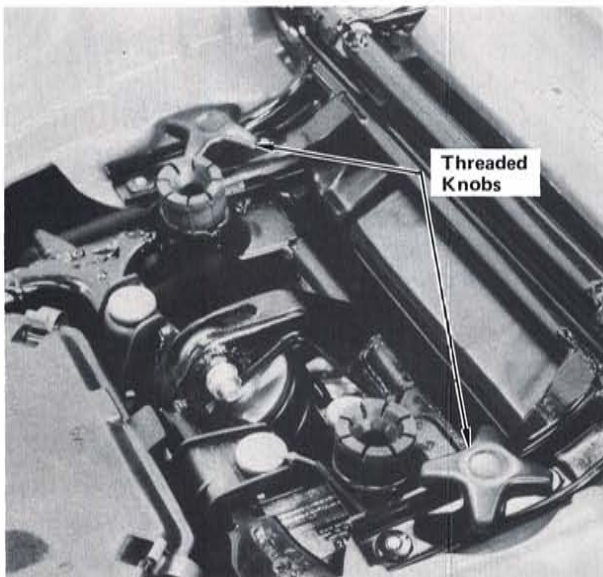

STEP 69—Lower rear fender and secure with two threaded knobs as shown.

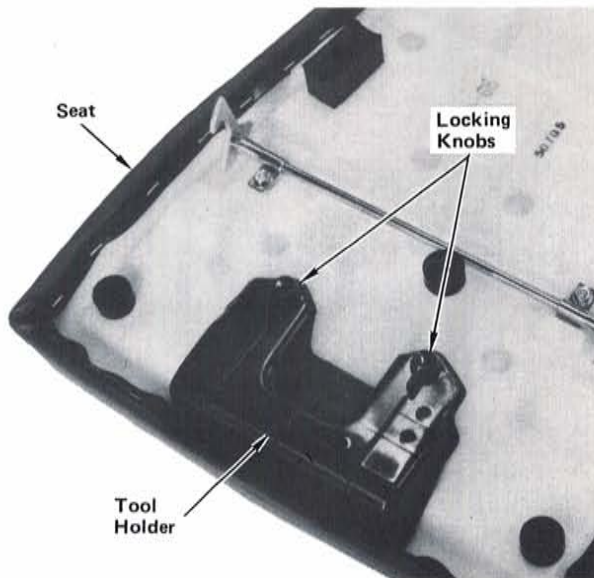

STEP 70—Place tool kit in tool holder. Install and lock tool holder under seat and lock in place with locking knobs.

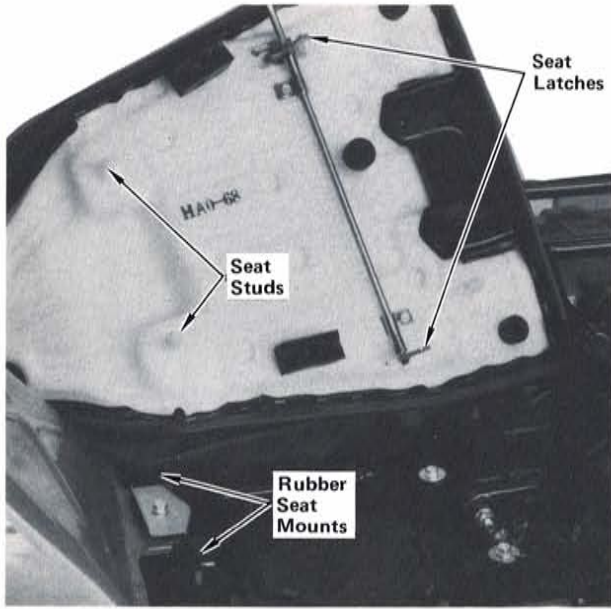

STEP 71—Install seat by inserting seat studs into holes in rubber seat mounts and engage seat latches.

NOTE: Check that seat latches are fully engaged.

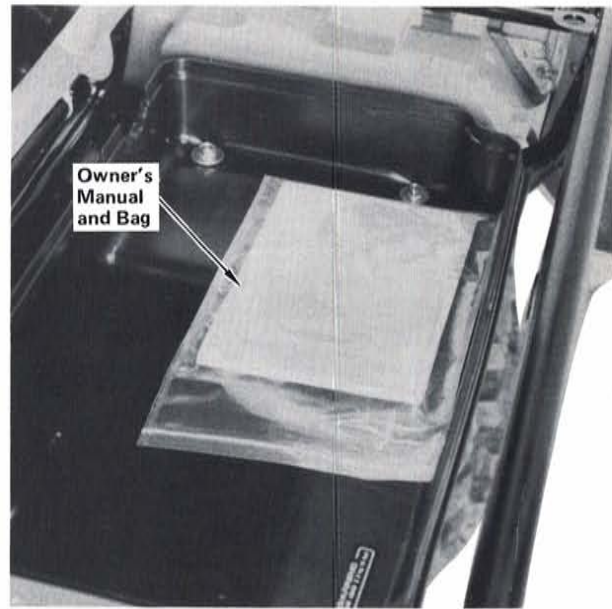

STEP 72—Insert owner's manual into luggage box. Close and secure cover.

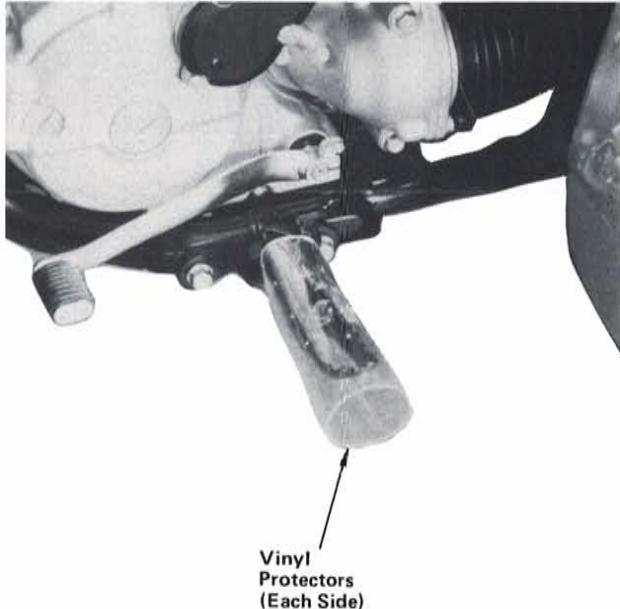

STEP 73—Remove and discard vinyl protectors.

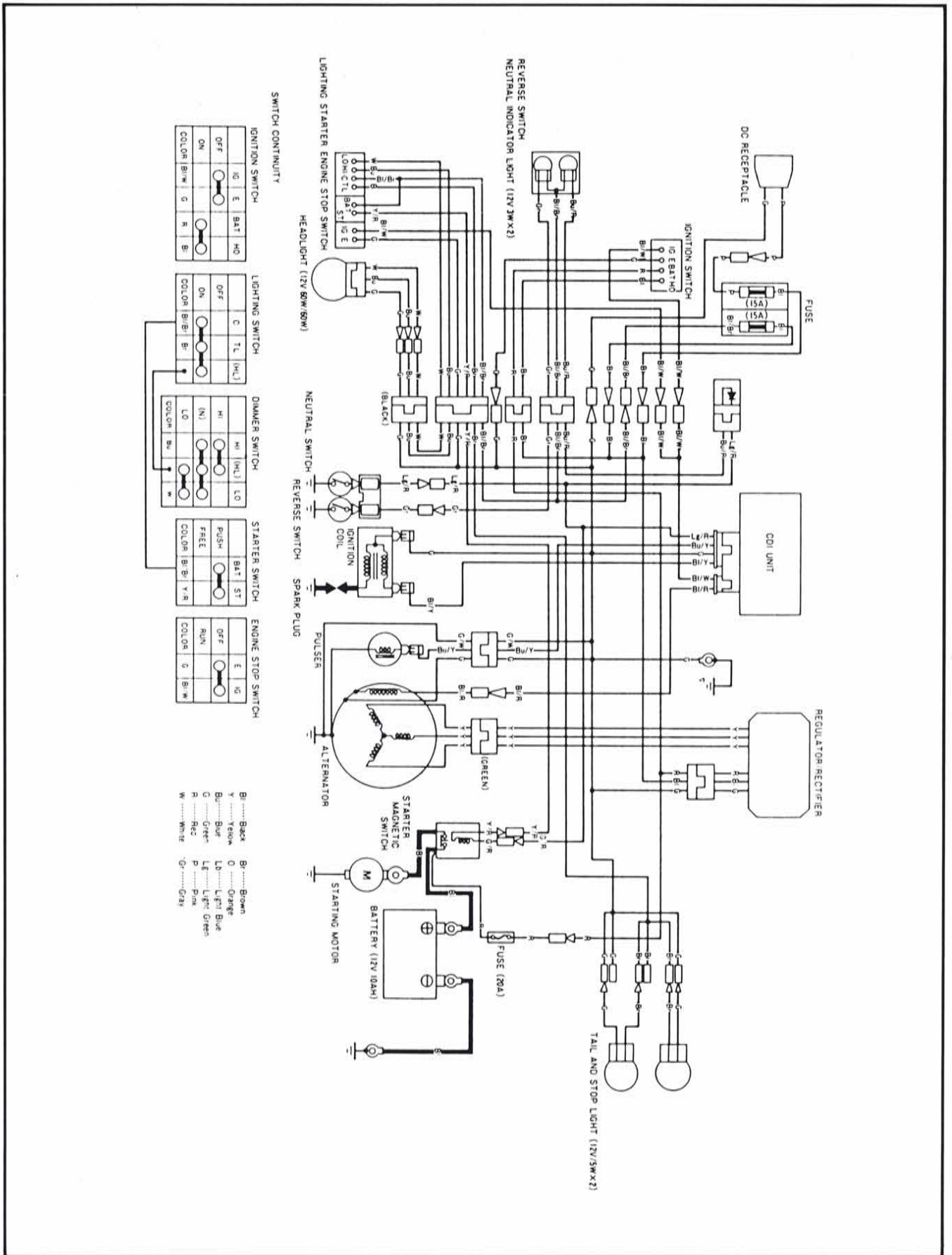

NOTE: Check all items listed on the following Pre-delivery Service Check List. Refer to owner's manual or shop manual for specifications and detailed procedures. Always test ride the unit to make sure that it is functioning properly.

PRE-DELIVERY SERVICE CHECK LIST

- | | |
|---|--|
| <ul style="list-style-type: none"> <input type="checkbox"/> Adjust front and rear brakes, check cable routing and check operation. <input type="checkbox"/> Fill crankcase with recommended oil. <input type="checkbox"/> Drain, flush, and inspect fuel tank. Clean fuel filter. <input type="checkbox"/> Drain residual fuel from carburetor. <input type="checkbox"/> Check air filter element. Clean and oil if necessary. <input type="checkbox"/> Fill fuel tank, turn on petcock and check for leaks. <input type="checkbox"/> Adjust idle speed. <input type="checkbox"/> Check throttle lever free play, cable routing, and operation in all steering positions. <input type="checkbox"/> Fill final drive case with recommended oil. <input type="checkbox"/> Check tire pressure. <input type="checkbox"/> Inspect electrical components for proper operation and adjustment. <ul style="list-style-type: none"> • Headlight switch. • Headlight: Adjust high beam aim. • Neutral and reverse indicator lights. • Taillights. • Starter. • Engine stop switch. • Battery charging system. | <ul style="list-style-type: none"> <input type="checkbox"/> Check security of all nuts, bolts, and other fasteners. <input type="checkbox"/> Check to ensure that all applicable recall and product update campaigns are complied with. <input type="checkbox"/> TEST RIDE: Check performance, handling, and operation. <ul style="list-style-type: none"> • Transmission, high-low-reverse gear range selector, and clutch: Ease of shifting, clutch operations, etc. • Acceleration: Smoothness, etc. • Cruising: Smoothness, etc. • Handling: Stability and cornering. • Brakes: Smoothness and stopping power. • Idling: Smoothness, throttle response, and return to idle. • Recheck idle speed after 10 minutes of stop and go operation. • Parking brake operation. • Upon completion of test ride, check for fuel and oil leaks. |
|---|--|

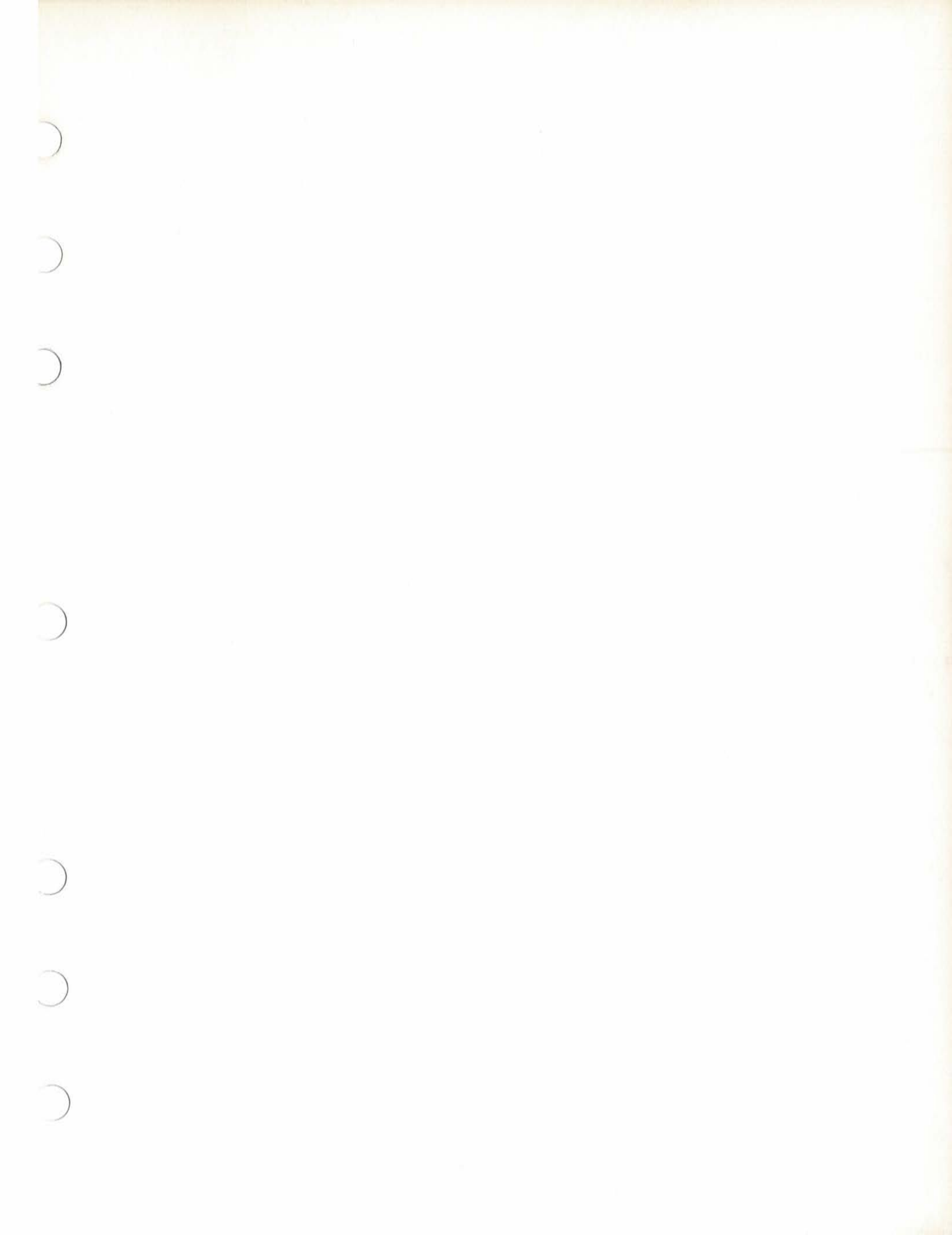

READ THIS READ THIS READ THIS

READ THIS READ THIS READ THIS

HONDA

Modifications which you have made, or should make in the future, to any Honda product, shall be deemed by our company to have been performed at your sole risk and responsibility, and without our company's or the manufacturer's approval or consent, implied or expressed. We further disclaim any and all liability, obligation, or responsibility for any defects of modified parts or of the modified product, and for any claims, demands, or causes of action for damage to property or for personal injuries resulting from the modification of said Honda product.

READ THIS READ THIS READ THIS