

 **HONDA**

**1984**

# Owner's Manual



**ATC200ES**

**HONDA ATC BIG RED  
OWNER'S MANUAL**

**1984**



All information in this publication is based on the latest product information available at the time of approval for printing. HONDA MOTOR CO., LTD. reserves the right to make changes at any time without notice and without incurring any obligation.

No part of this publication may be reproduced without written permission.

© Honda Motor Co., Ltd. 1983

**31969600**

## ////////////////////// PREFACE ////////////////////////

This booklet is your guide to the basic operation and proper maintenance of your new Honda ATC Big Red. Please take the time to read it carefully. Details necessary for riding the Honda ATC are given to acquaint the new owner with special riding techniques to be learned. When service is required, remember that your Honda dealer knows your vehicle best. If you have the required mechanical "know-how" and tools, your dealer can supply you with an official Honda Shop Manual to help you perform many maintenance and repair tasks.

Thank you for selecting a Honda. We wish you continued riding pleasure in the miles ahead.

# //////////////////// CONTENTS //////////////////////

	Page		Page
ATC SAFETY .....	1	Carburetor .....	45
DESCRIPTION .....	4	High Altitude .....	46
Parts Location .....	4	Spark Plug .....	48
Serial Numbers .....	6	Air Cleaner .....	49
Parts Function .....	7	Valves .....	50
Fuel .....	18	Clutch .....	52
Engine Oil .....	20	Brakes .....	53
Tires .....	22	Throttle Cable .....	58
OPERATION .....	24	Final Drive Oil .....	57
Pre-ride Inspection .....	24	Cam Chain .....	58
Starting the Engine .....	26	Battery .....	59
Break-in .....	28	Spark Arrestor .....	61
Riding .....	29	STORAGE GUIDE .....	62
Parking .....	38	TRANSPORTING .....	64
MAINTENANCE .....	39	NOISE EMISSION CONTROL SYSTEM .....	68
Maintenance Schedule .....	39	SPECIFICATIONS .....	69
Tool Kit .....	41	WIRING DIAGRAM .....	70
Engine Oil .....	42	OPTIONAL PARTS .....	71
Oil Filter Rotor .....	43	WARRANTY SERVICE .....	72
Fuel Filter .....	44		

## WARNING

- \* *ATC riding requires special efforts on your part to ensure your safety. Know these requirements before you ride.*
- \* *Avoid riding on paved surfaces as handling can be seriously affected. If it is necessary, ride at reduced speeds and avoid sudden turns.*

## SAFE RIDING RULES

- \* Always make a pre-ride inspection (page 24) before you start the engine. You may prevent an accident or equipment damage.
- \* Always obey local off-road riding laws and regulations.
- \* Obtain permission to ride on private property. Avoid posted areas and obey "no trespassing" signs.
- \* Know the terrain on which you are riding. If you are not familiar with the terrain, ride cautiously. Hidden rocks; holes or ravines could spell disaster.
- \* Your ability to operate the ATC safely is largely dependent upon your proper judgement.
- \* Do not use the flag pole bracket as a trailer hitch.

- \* When you select reverse gear, make sure there are no obstacles or people behind you. When it is safe to proceed, ride slowly.

## PROTECTIVE APPAREL

- \* Most ATC accident fatalities are due to head injuries; ALWAYS wear a helmet. You should also wear a face shield or goggles, boots, gloves and protective clothing.
- \* The exhaust system becomes very hot during operation and it remains hot after operation. Never touch any part of the hot exhaust system. Wear clothing that fully covers your legs.

## MODIFICATIONS

- \* Modification of the ATC, or removal of original equipment, may render the vehicle unsafe or illegal.
- \* Spark arresters and mufflers are required in most areas. Don't modify your exhaust system. Remember that excessive noise bothers everyone and creates a bad image for motorcycling.

## LOADING AND ACCESSORIES

### WARNING

\* *To prevent an accident, use extreme care when adding and riding with accessories and cargo. Addition of accessories and cargo can reduce the ATC Big Red's stability, performance, and safe operating speed. Slow down (15 mph or less) when loaded with cargo or pulling a trailer.*

The combined weight of the rider, cargo, and all accessories must not exceed **150 kg (330 lbs)** which is the vehicle capacity load.

The following loading and towing capacity data is valid only when the riding terrain is level and flat. For different riding terrains, you must exercise your own judgement to load and ride the ATC safely. Never exceed the loading capacities given here.

1. Load cargo on the rear carrier as far forward as possible. Do not allow cargo to extend beyond the end of rear carrier.

Front carrier	<b>10 kg (22 lbs)</b>
Rear carrier	<b>45 kg (100 lbs)</b>

2. When towing a trailer, care should be taken to maintain balance and stability. Place cargo in the trailer so that it will not cause the front wheel to lift off the ground during travel.

Tow weight **315 kg (700 lbs)**

(Trailer plus cargo weight)

Tongue weight **14 kg (30 lbs)**

(Weight on with point)

3. Do not obstruct the headlight beam with cargo.

4. Do not ride with a passenger on the rear.

This ATC is not designed to carry a passenger.

## DESCRIPTION

### PARTS LOCATION

- (1) Front brake lever
- (2) Throttle lever
- (3) Neutral indicator lamp
- (4) Reverse indicator lamp
- (5) Rear brake lever/parking brake
- (6) Fuel tank cap
- (7) Fuel valve
- (8) Recoil starter
- (9) Gearshift pedal
- (10) Neutral indicator
- (11) Posi-Torque Speed Range and Reverse Selector
- (12) Front Carrier
- (13) Rear Carrier

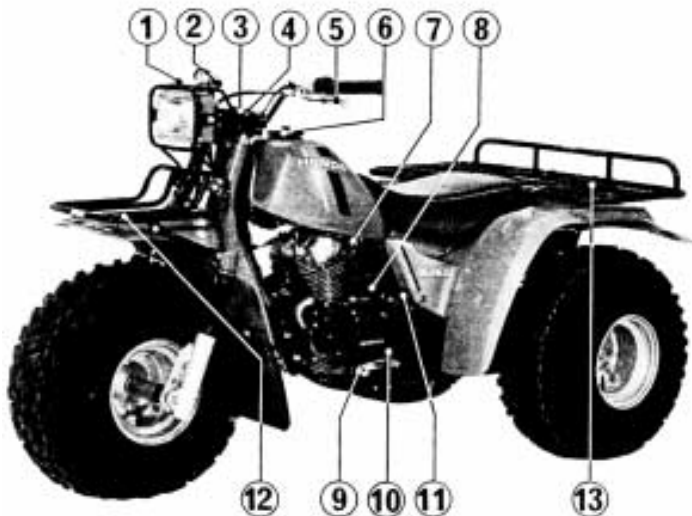

- (14) Ignition switch
- (15) Choke knob
- (16) Starter button
- (17) Headlight switch
- (18) Engine stop switch
- (19) Oil filler cap

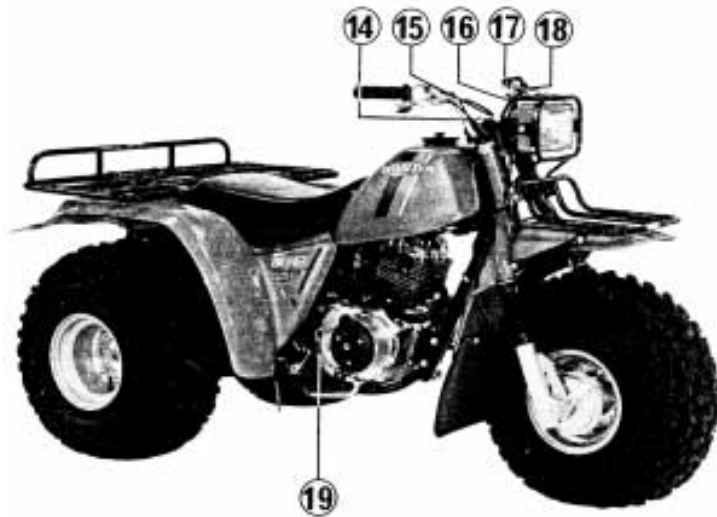



## SERIAL NUMBERS

The frame and engine serial numbers are required by your dealer when ordering replacement parts. Record the numbers here for your reference.

FRAME NO. \_\_\_\_\_

The frame serial number (1) is stamped on the left side of the steering head. The engine serial number (2) is stamped on the crankcase just above the left footpeg.

ENGINE NO. \_\_\_\_\_

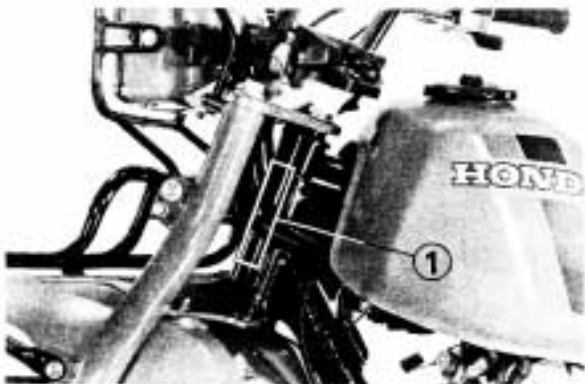

(1) Frame serial number

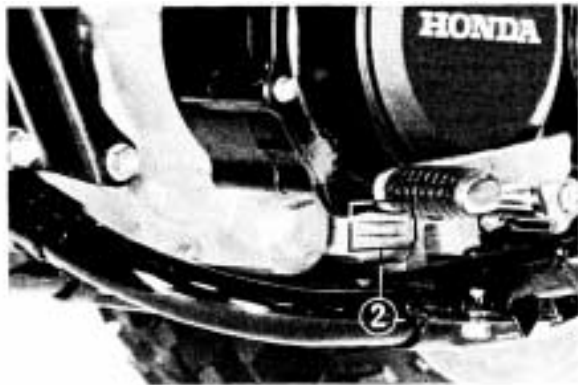

(2) Engine serial number

## PARTS FUNCTION

### Ignition Switch

The ignition switch (1) is on the handlebar upper holder.

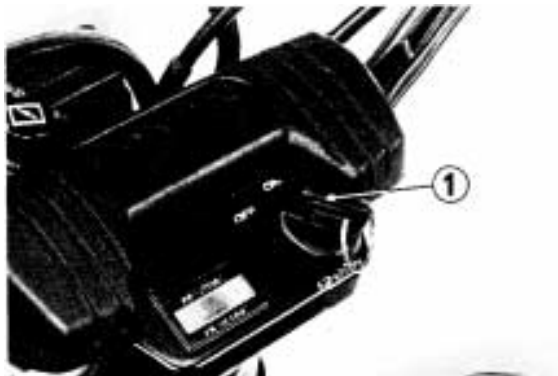

(1) Ignition Switch

Key Position	Function	Key Removal
OFF	Engine and headlight cannot be operated.	The key can be removed.
ON	Headlight can be turned on. With the engine stop switch at RUN and transmission in neutral, the engine can be started.	The key cannot be removed.

## Reverse Indicator Lamp

The Big Red is equipped with a reverse indicator lamp to show when the Posi-Torque Speed Range and Reverse Selector lever is in Reverse position.

### CAUTION:

- \* *Before moving the lever to the reverse position, make sure the transmission is in neutral.*



(1) Reverse indicator lamp

## Engine Stop Switch

The three position engine stop switch (1) is next to the left handlebar grip. In RUN, the engine will operate. In either OFF position, the engine will not operate.

This switch is intended primarily as a safety or emergency switch and should normally remain in RUN.

### NOTE:

- \* If your ATC is stopped with the ignition switch ON and the engine stop switch OFF, the headlight will still be on, resulting in battery discharge.

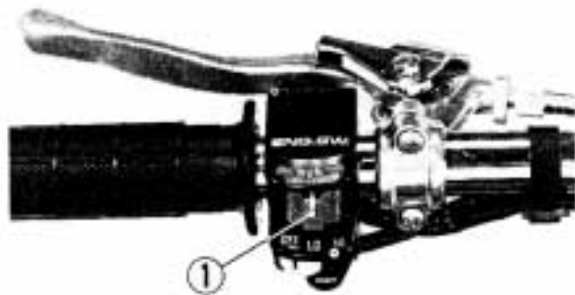

(1) Engine stop switch

## Starter Button

The starter button (1) is below the headlight switch. When the starter button is pressed and the transmission is in neutral, the starter motor will crank the engine.

### NOTE:

\* When the posi-torque speed range and reverse selector lever is in reverse position, the starter motor will not work.



(1) Starter button

## Headlight Switch

The headlight switch (1) is below the engine stop switch. Its operating positions are as follows:

Position	Function
OFF	Headlight is off.
LO	Headlight is on low beam.
HI	Headlight is on high beam.

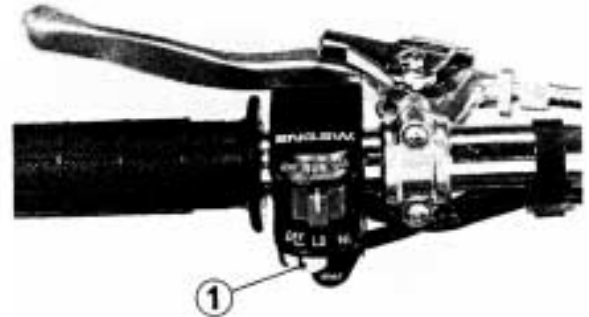

(1) Headlight switch

## Throttle Lever

The throttle lever (1) is next to the right handlebar grip and is operated by the rider's thumb. Pressing the lever forward opens the throttle. When the lever is released, spring tension closes the throttle automatically.

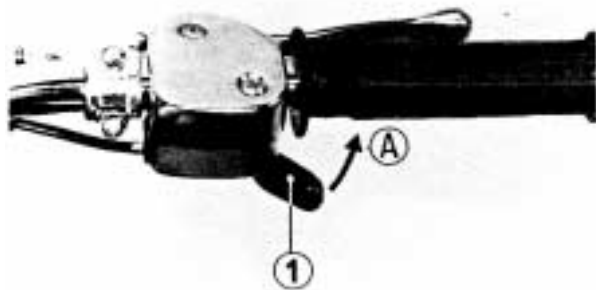

(1) Throttle lever      (A) Open

## Brake Lever/Parking Brake

The front brake lever is at the right handlebar grip. The left brake lever (1) and the brake pedal both operate the rear wheel brake. Either one can be used to stop the ATC. The left brake lever has the added feature of a lock (2) which allows the lever to be used as a parking brake.

Pull the left brake lever back and lock it with the lock. Always apply the parking brake when parking on a hill.

The parking brake is unlocked by squeezing the left brake lever.

### NOTE:

- \* Use of the parking brake in freezing weather may cause the brakes to freeze in the locked position.

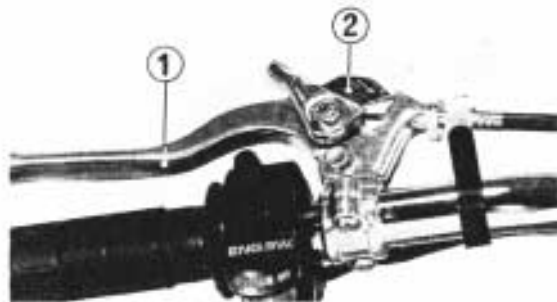

(1) Brake lever/Parking brake      (2) Lock

## Gearshift Pedal

The gearshift pedal (1) is near the left footpeg. One full stroke of the gearshift pedal will shift the transmission. The pedal automatically returns to the horizontal position when released. Each stroke of the pedal engages the next gear in sequence.

Depress the pedal to shift to a higher gear and raise the pedal to downshift.

When the Posi-Torque Speed Range and Reverse Selector lever (page 13) is in the Reverse Position, the gearshift pedal can only be shifted into the 1st gear position and neutral.

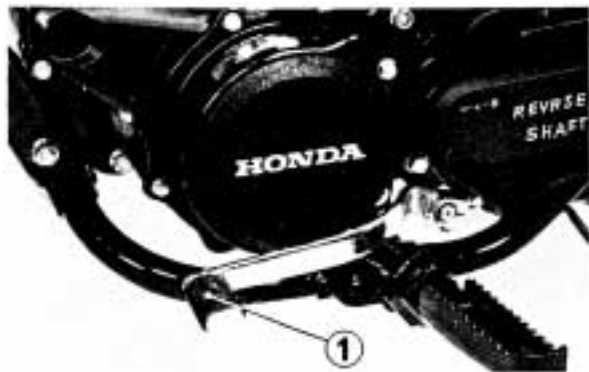

(1) Gearshift pedal

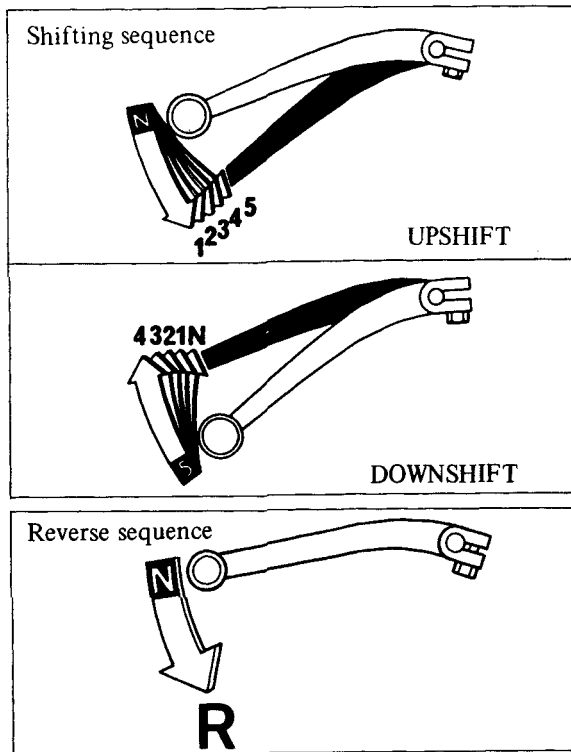

## Neutral Indicator/Neutral Indicator Lamp

The ATC Big Red is equipped with two indicators to show when the transmission is in neutral. This feature enables the rider to verify that the transmission is in neutral before starting the engine.

The neutral indicator lamp (1) is on the handlebar upper holder. When the ignition switch is turned to ON, the lamp lights if the transmission is in neutral. If the lamp does not light, shift the transmission into neutral, whereupon the lamp will light.



(1) Neutral indicator lamp

The neutral indicator (2) is on the left crankcase cover, just behind the recoil starter. The indicator rotates as the gears are changed. When the indicator aligns with the N mark on the crankcase, the transmission is in neutral.



(2) Neutral indicator

## Posi-Torque Speed Range and Reverse Selector

The ATC Big Red is equipped with the Posi-Torque subtransmission which supplements the five forward gears with two different final drive ratios and provides the ATC with a reverse gear as well.

The select lever (1) for the subtransmission is located on the left crankcase cover just behind the recoil starter housing. Moving the lever to L engages the low range final drive ratio and allows you to use the five forward gears. Select the low range (L) for low speed riding conditions where greater power is needed, as when climbing hills or traveling over difficult terrain. Moving the lever to H engages the high range final drive ratio and also allows you to use the five forward gears. Select the high range (H) for higher speed riding conditions where greater pulling power is not required. Moving the lever to R engages the reverse drive which permit the use of first gear only. Select reverse (R) for “backing-up”.

To shift the transmission, bring the ATC to a complete stop and shift the transmission into Neutral. Be sure the transmission is in Neutral by checking the neutral indicator and neutral indicator light (page 12). The select lever (1) can be shifted to the H, L or R position by moving the lever to the desired position.

### NOTE:

- \* The selector lever can not be moved in the reverse position without the transmission in the neutral or 1st gear.
- \* When shifting the select lever into the R and L position, pull up on the select lever knob.

### CAUTION:

- \* *Do not move the selector lever while riding, or damage to the transmission may result.*
- \* *Make sure the transmission is in Neutral before shifting the Posi-Torque Speed Range and Reverse Selector lever.*



(1) Selector lever



## Decompressor

The Honda ATC Big Red has a decompressor lever (1), located on the right side of the cylinder head, to aid starting when using the recoil starter. Before starting the engine, raise the lever to the DECOMP position (A). The lever moves down automatically when the recoil starter is pulled.

### NOTE:

- \* If the lever does not stay in the DECOMP position, there is no cylinder compression to release. Just pull the recoil starter to start the engine.

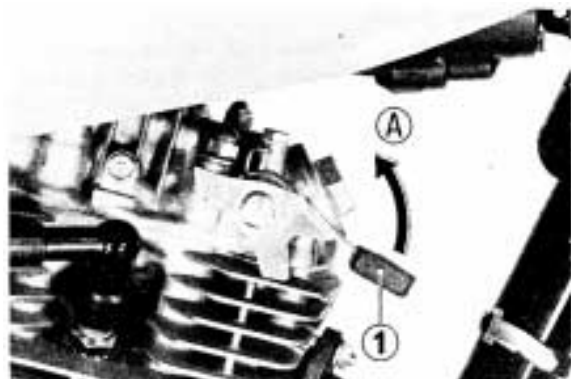

(1) Decompressor lever

(A) DECOMP position

## Choke Knob

The choke knob (1) is on the handlebar upper holder. Pulling the choke knob up will close the choke, and the carburetor will deliver a rich fuel mixture for starting the engine when cold. Lower the lever to open the choke as the engine attains normal operating temperature.

To restart a warm engine, it is not necessary to use the choke.

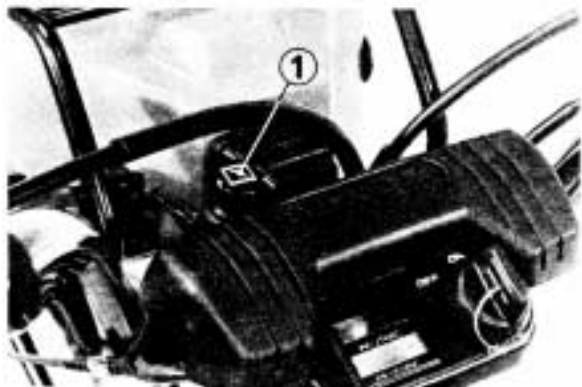

(1) Choke knob

## Fuse Replacement

The fuse holder (1) is located near the battery box. The specified fuse is 10A.

When frequent fuse failure occurs, it usually indicates a short circuit or an overload in the electrical system. See your authorized Honda dealer for repair.

### **WARNING**

- \* *Never use a fuse with a different rating from that specified. Serious damage to the electrical system or a fire may result, causing a dangerous loss of lights at night or engine power.*

### **CAUTION:**

- \* *Turn the ignition switch OFF before checking or replacing the fuse to prevent accidental short-circuiting.*

## 12V DC Power Supply

The direct current receptacle (1) is on the left side of the headlight. It provides 12V DC power at a maximum of 60 watts (5Amps). The fuse for this power supply is located on the frame under the seat. The specified fuse is 5A.

### WARNING

\* *Never use a fuse with a different rating from that specified. Serious damage to the electrical system or a fire could result.*

Accessories may be connected to the receptacle by using the special plug (2) that came with your ATC. To attach the special plug to the accessory:

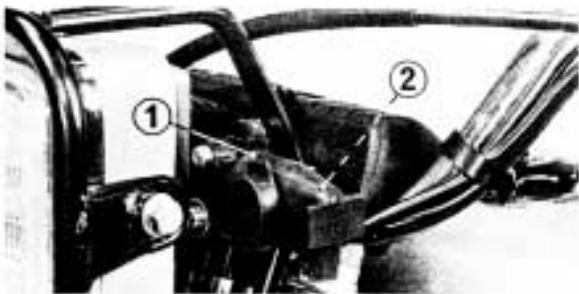

(1) Receptacle

1. Install the accessory leads to the plug, making sure to connect the positive and negative leads to the corresponding plug terminals.

### CAUTION:

\* *Do not install the positive and negative accessory leads in reverse when attaching them to the special plug.*

### NOTE:

- \* We recommend that you use AWG18–AWG20 electrical wire for attachment to the special plug.
2. With the ignition OFF, insert the plug into the plug receptacle, being careful not to twist the electrical leads coming from the accessory.

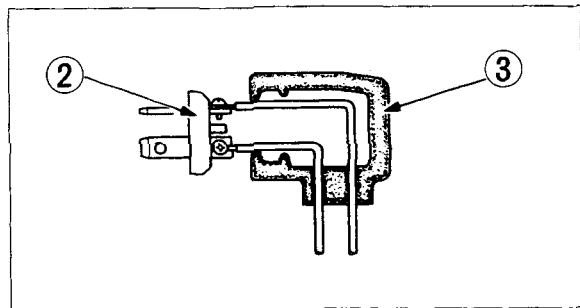

(2) Special plug      (3) Plug cover

 **WARNING**

- \* *Make sure the ignition switch is OFF when inserting or removing the special plug.*

**CAUTION:**

- \* *Keep the electrical leads insulated and away from hot engine parts and sharp edges.*
  - \* *Do not use accessories not designed for 12V DC power.*
  - \* *Make sure the electrical leads extend from the bottom of the plug when inserting it in the receptacle.*
3. When the receptacle is not being used, cover it with the rubber cap that came with your ATC to keep out dust, water and sand.

## FUEL

### Fuel Valve

The three way fuel valve (1) is on the left side of the carburetor.

#### OFF

At OFF , fuel cannot flow from the tank to the carburetor. Turn the valve off whenever the ATC is not in use.

#### ON

At ON , fuel will flow from the main fuel supply to the carburetor.

#### RES

At RES , fuel will flow from the reserve fuel supply to the carburetor. Use the reserve fuel only when the main supply is gone. Refill the tank as soon as possible after switching to RES . The reserve fuel supply is 1.0ℓ (0.26 US gal).

#### NOTE:

- \* Do not operate the ATC with the fuel valve in the RES position after refueling. You may run out of fuel with no reserve.

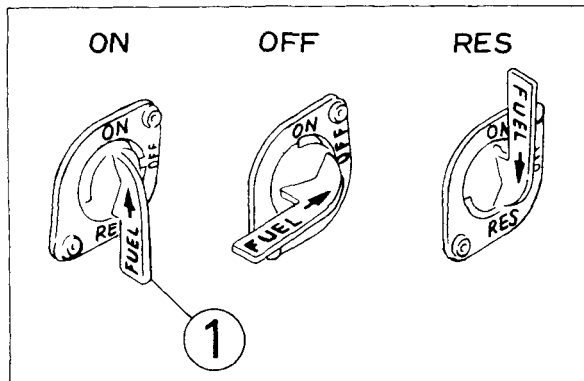

(1) Fuel valve

## Fuel Tank

Fuel tank capacity is 11.5ℓ (3.0 US gal) including 1.0ℓ (0.26 US gal) in the reserve supply. Remove the fuel tank cap (1) by twisting it counterclockwise.

Any automotive gasoline with a pump octane number ( $\frac{R+M}{2}$ ) of 86 or higher, or research octane number of 91 or higher may be used.

If knocking or pinging occurs, try a different brand of gasoline or a higher octane grade.

After refueling, be sure to tighten the tank cap firmly by turning it clock wise until the arrow on the cap faces forward.

The fuel tank cap (1) has a lever (2) with ON and OFF positions to open or close the tank vent. The lever should be turned to ON to allow fuel to flow when running the engine.

Turning the lever to OFF will prevent fuel from flowing out the vent hole when transporting the ATC.

### WARNING

*\* Gasoline is extremely flammable and is explosive under certain conditions. Refuel in a well-ventilated area with the engine stopped. Do not smoke or allow open flames or sparks in the area where the vehicle is refueled or where gasoline is stored.*

- \* Do not overfill the tank (there should be no fuel in the filler neck). After refueling, make sure the tank cap is closed securely.*
- \* Avoid repeated or prolonged contact with skin or breathing of vapor. KEEP OUT OF REACH OF CHILDREN.*

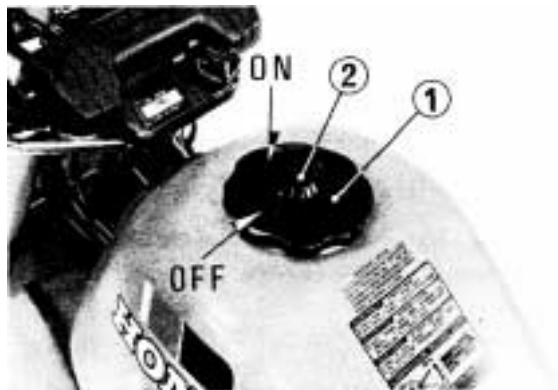

(1) Fuel tank cap

2) Cap lever

## ENGINE OIL

### Engine Oil Level Check

Check the engine oil level each day before operating the ATC.

The oil filler cap (1) is on the right crankcase cover and contains a dipstick for measuring the oil level. The oil level must be maintained between the upper (2) and lower (3) level marks on the dipstick.

1. With the ATC on level ground, remove the oil filler cap/dipstick and wipe it clean.
2. Reinsert the dipstick without screwing it in. Remove the oil filler cap/dipstick again and check the oil level.
3. If required, add the specified oil up to the upper level mark. Do not overfill.
4. Reinstall the filler cap/dipstick.

#### CAUTION:

\* *Running the engine with insufficient oil can cause serious engine damage.*

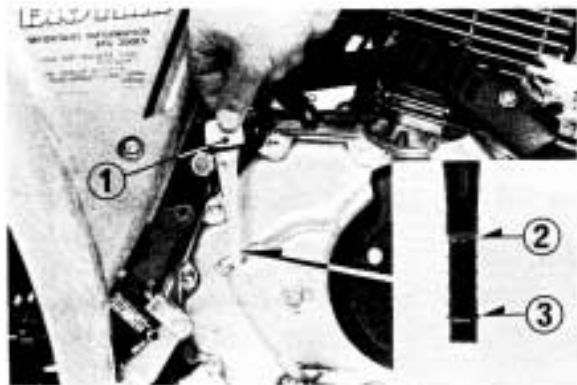

- (1) Oil filler cap/dipstick (3) Lower level mark  
(2) Upper level mark

## Engine Oil Recommendation

USE HONDA 4-STROKE OIL OR AN EQUIVALENT.

Use only high detergent, premium quality motor oil certified to meet or exceed US automobile manufacturers' requirements for Service Classification SE or SF.

Motor oils intended for Service SE or SF will show this designation on the container. The use of special oil additives is unnecessary and will only increase operating expenses.

### CAUTION:

\* *Engine oil is a major factor affecting the performance and service life of the engine. Non-detergent, vegetable, or castor based racing oils, are not recommended.*

Recommended Oil Viscosity:  
SAE 10W-40

Other viscosities shown in the chart below may be used when the average temperature in your riding area is within the indicated range.

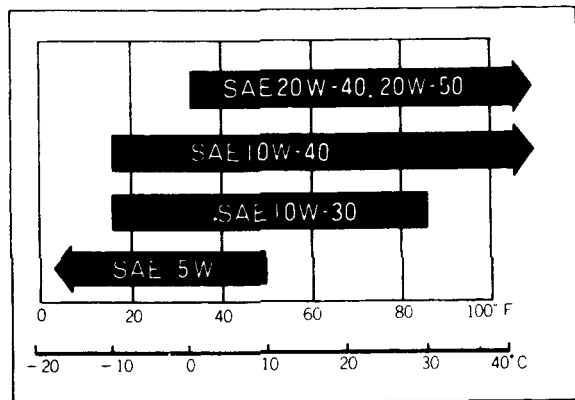



## TIRES

The ATC Big Red is equipped with 25x12-9 low pressure tubeless tires to provide a comfortable ride. Although the tires are designed specifically for vigorous off-road use, they are not immune to punctures. Always select your riding area with care.

### CAUTION:

\* *Driving on paved surfaces will cause excessive tire wear.*

For normal use, the tires should be inflated to a recommended pressure of 2.2 psi (15 kPa, 0.15 kg/cm<sup>2</sup>). A manually operated tire pump should be used rather than the high pressure systems found in service stations. This will minimize the possibility of tire damage from overinflation.

### NOTE:

\* Tire pressure should be checked when the tires are "cold," before you ride.

If no air pressure gauge is available to accurately measure air pressure, this value can be estimated by measuring the circumference of the tires with a measuring tape. When inflated to 2.2 psi (15 kPa, 0.15 kg/cm<sup>2</sup>), the maximum tire circumference measured over the tread ribs will be approximately 1,920 mm

(75.6 in.). The relationship between tire pressure and actual circumference varies slightly with factors of wear and stretching that occur through use.

Recommended Pressure: 2.2 psi (15 kPa, 0.15 kg/cm<sup>2</sup>)

Standard Tire Circumference: 1,920 mm (75.6 in.)

Max. Pressure: 2.6 psi (18 kPa, 0.18 kg/cm<sup>2</sup>)

Min. Pressure: 1.7 psi (12 kPa, 0.12 kg/cm<sup>2</sup>)



** WARNING**

- \* Be sure to inflate both rear tires equally. If the ATC is operated with unequal tire pressures, the resultant difference in tire circumference will cause the ATC to run toward one side and will adversely affect handling.*
- \* Maintain proper tire pressure. Underinflated tires may adversely affect maneuverability and cause wheel damage when riding over bumpy terrain. Overinflated tires may damage the tires, or hub on the fenders and hamper movement of the ATC.*

If you have a flat tire, use the plug method to make temporary repairs. The plug method is the same as that for conventional tubeless tires. A plug type repair kit, which is available at most auto part stores or service stations, provides a plug, an installation tool, tire cement, and an instruction sheet. Follow the instructions provided in the repair kit to make a temporary repair until the tire can be permanently repaired by the cold patch method. Any tire which cannot be repaired by the plug method should be replaced.

Whenever the ATC is to be operated far from service facilities or available transportation, we recommend that the rider carry a tire pump and a suitable repair kit with the ATC.

## PRE-RIDE INSPECTION

### WARNING

*\* If the Pre-ride Inspection is not performed, serious damage or an accident may result.*

Inspect your ATC every day before you start the engine. The items listed here will only take a few minutes to check and in the long run can save time, expense, and possibly your life.

1. Engine oil level – if required add engine oil (page 20). Check for leaks.
2. Fuel level – fill the fuel tank when necessary (page 18). Check for leaks.
3. Brakes – check operation. If necessary adjust free play (page 53).
4. Tires – check condition and pressure (page 22).
5. Throttle – check for smooth opening and closing in all steering positions (page 56).
6. Headlight switch – check for proper function (page 7).

7. Engine stop switch – check for proper function (page 6).
8. Nuts, Bolts, Fasteners – check the wheels to see that the axle nuts are tightened and secured by cotter pins. Check the security of all other nuts, bolts and fasteners.

Correct any discrepancy before you ride. Contact your authorized Honda dealer for assistance if you cannot correct the problem.

## STARTING THE ENGINE

### WARNING

- \* *Never run the engine in a closed area. The exhaust contains poisonous carbon monoxide gas.*
- \* *Do not try to start the engine with the transmission in gear. You may injure yourself or damage the vehicle.*

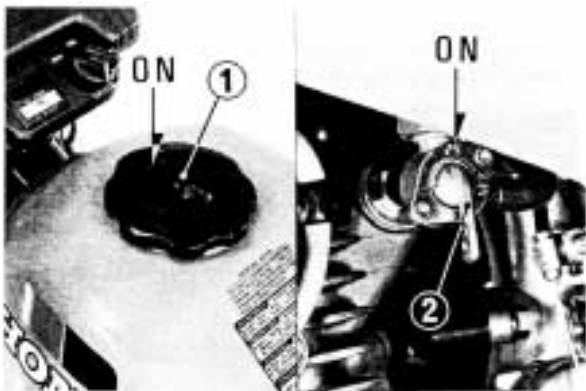

(1) Vent lever

(2) Fuel valve

### Preparation

1. Select a level surface and lock the parking brake (page 10) before starting the engine.
2. Turn the fuel cap vent lever (1) and fuel valve (2) to ON.
3. Make sure the engine stop switch (3) is at RUN.
4. Make sure that the transmission is in neutral by lifting the shift lever and checking that the neutral indicator (4) is at N.
5. Make sure the Posi-Torque Speed Range and Reverse Selector lever is in the H or L position.

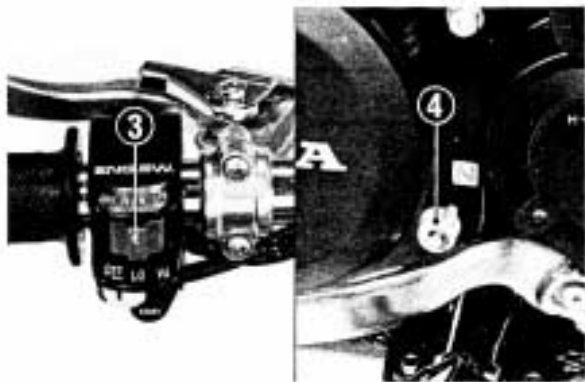

(3) Engine stop switch

(4) Neutral indicator

## Starting Procedure (after Preparation)

To restart a warm engine, follow the procedure for High Air Temperature.

### Normal Air Temperature

10°–35°C (50°–95°F)

1. Raise the choke knob (5) to the Fully Closed position (A).
2. Turn the ignition switch (6) to ON. Make sure that the transmission is in the neutral by the neutral indicator lamp.
3. Open the throttle slightly.
4. Press the starter button (7) and start the engine.

#### NOTE:

- \* Do not use the electric starter for more than 5 seconds at a time. Release the starter button for

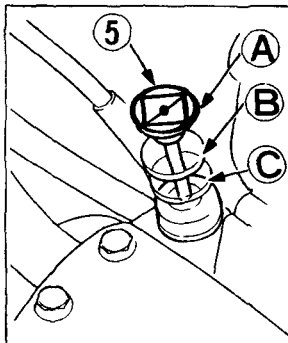

(5) Choke knob



(6) Ignition switch

approximately 10 seconds before pressing it again.

- \* When Posi-Torque Speed Range and Reverse Selector is in R position, the starter motor will not work.
5. Immediately after the engine starts, release the starter button and push the choke knob to the half position (B).
  6. About a half minute after the engine starts, push the choke knob down all the way to Fully Open (C).
  7. If idling is unstable, open the throttle slightly.

### High Air Temperature

35°C (95°F) or above

1. Do not use the choke.
2. Open the throttle slightly.
3. Start the engine by pressing the starter button.



(7) Starter button

### Low Air Temperature

10°C (50°F) or below

1. Follow steps 1–5 under Normal Air Temperature.
2. Warm up the engine by opening and closing the throttle slightly.
3. Continue warming up the engine until it will idle smoothly with the choke knob pushed down all the way to Fully Open (C).

### **CAUTION:**

- \* *Extended use of the choke may impair piston and cylinder wall lubrication.*
- \* *Do not race the engine during the warm-up period. Racing a cold engine wastes fuel and increases engine wear.*

### **Recoil Starting**

If the engine does not start with the electric starter, use the recoil starter.

1. Raise the decompressor lever (1) up to the DE-COMP position.
2. To use the recoil starter, follow the steps under Preparation and 1–3 under Normal Air Temperature.

### **NOTE:**

- \* A quick vigorous pull on the starter rope (2) will be the most effective way to start the engine.
- \* The recoil starter cannot be operated. When the selector lever is in the reverse position.



(1) Decompressor lever (2) Recoil starter

## **Flooded Engine**

If the engine does not start after several attempts, it may have become flooded with excess fuel. To clear the engine, turn the ignition switch OFF, push the choke knob down completely, hold the throttle fully open, and briefly press the starter button or pull the recoil starter rope several times.

When the engine is cleared, wait 10 seconds then turn the ignition switch ON and repeat the normal starting procedure, but do not use the choke.

## **BREAK-IN**

During the first few days of riding, operate your new ATC Big Red so that the engine neither pulls laboriously nor approaches maximum rpm in any gear. Avoid full throttle operation, and shift gears frequently to vary engine speed. Careful break-in during the initial operating period will measurably extend the service life of the engine.

## RIDING

### WARNING

- \* *Review ATC Safety (page 1) before you ride.*
- \* *Avoid “wheelies” and jumping as they may cause loss of control.*
- \* *Ride with your feet on the footpegs at all times. If your feet are removed from the footpegs and touch the ground while the ATC is moving, they may come in contact with the rear wheels.*
- \* *While carrying loads or pulling a trailer, use extreme caution when starting, stopping or turning the ATC.*

Under normal riding conditions it is not necessary or desirable to touch the ground for balance.

For your initial riding practice, select a safe area free of obstacles and with an even surface. Avoid paved surfaces as they make learning to maneuver more difficult, and will also significantly shorten tire life.

1. Make sure the transmission is in neutral and set the parking brake. Move the speed range selector lever to L (low) or H (high). You may now start the engine.
2. After the engine has been warmed up, release the parking brake. The ATC is ready for riding.
3. While the engine is idling, depress the gearshift pedal to shift into 1st (low) gear.
4. Increase engine speed by gradually opening the throttle.

5. When your speed increases, close the throttle and shift to 2nd gear by depressing the gearshift pedal.

### CAUTION:

- \* *Do not shift gears without closing the throttle. The engine and drive train could be damaged by overspeed and shock.*
6. This sequence is repeated to progressively shift to 3rd, 4th and 5th (top) gear.

### CAUTION:

- \* *Do not move the Posi-Torque selector lever while riding, or damage to the sub-transmission may result.*
- \* *Do not tow the ATC or coast for long distances while the engine is off. The transmission will not be properly lubricated and damage may result.*

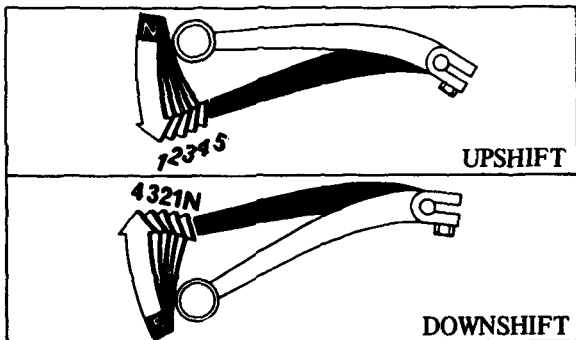

Shifting sequence



## Reverse Riding

For reverse riding practice, make sure there are no obstacles or people in the area.

1. Make sure the transmission is in neutral and set the parking brake. Make sure the subtransmission is in H or L.
2. Start the engine.
3. Move the posi-torque speed range and reverse selector lever to the reverse position (page 13).
4. While the engine is idling, depress the gearshift pedal into reverse gear.
5. Ride the ATC cautiously in reverse by gradually opening the throttle.

### NOTE:

- \* The posi-torque speed range and reverse selector lever cannot be moved in the reverse position without the transmission in the neutral or 1st gear.

### WARNING

- \* *Close the throttle and apply both front and rear brakes carefully to stop the ATC when riding in reverse. Applying the rear brake alone may cause the front wheel to lift off the ground.*

## Turning Maneuvers

For better traction in off-road use, the ATC has been fitted with a rear axle which drives both rear wheels equally at all times.

When negotiating a turn, the wheel on the outside of the turn must travel a wider radius and thus a greater distance than the inside wheel. As the rear axle does not permit a differing rate of wheel rotation, it is not enough to merely steer the ATC into a turn. The new rider must learn to shift his or her weight and control the throttle to allow the rear tires to negotiate the turn. This is the primary technique to be mastered in riding the Honda ATC. For your initial riding practice, operate the ATC in low gear.

Practice turning the ATC at slow, constant speeds. Defer higher speeds until you are confident of your proficiency.

To turn, steer in the direction of the turn, leaning your body to the inside of the turn, while supporting your weight on the outer footpeg. Use the throttle to maintain power throughout the turn.

This technique allows the ATC to lean slightly toward the outside, altering the balance of traction between the rear wheels sufficiently to allow them to negotiate the turn.

Once this technique is learned, turning maneuvers can be performed within a relatively small area.

Support your weight  
on the outer footpeg.

Lean towards  
inside of turn.

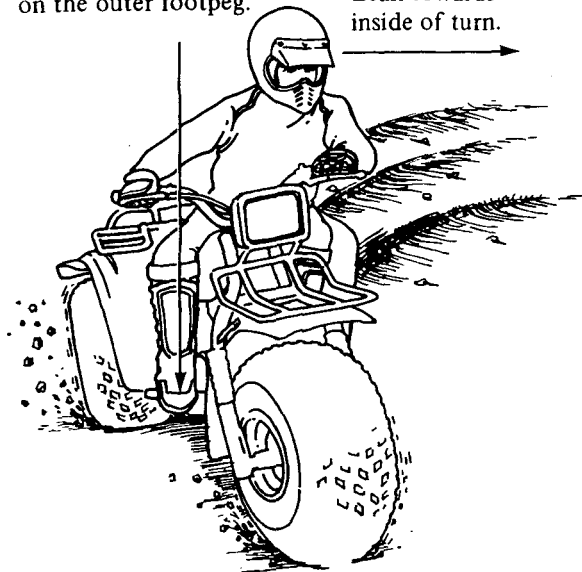

Incorrect turning techniques may cause the front wheel to slide straight ahead when steered without affecting the ATC's direction of travel. If this should occur, close the throttle and come to a stop. Then continue practicing the technique outlined on the preceding page.

If the front wheel tends to skid in mud or snow, you may be able to improve control under these conditions by leaning forward, transferring additional weight to the front wheel.

If the rear wheels inadvertently skid sideways, correct your slide by steering in the direction of the skid if you have room to perform this maneuver safely.

Avoid braking or accelerating until you have regained directional control.

To avoid skids while traveling on slippery terrain, the rider must exercise a high degree of caution. Controlled skids and spins, when performed safely, add to the sport the rider can enjoy. However, as skidding maneuvers are inherently more hazardous than those performed under full traction, we must caution the rider to first master the basic techniques of handling before practicing any skidding maneuver.

Surface composition is, of course, a major factor affecting skidding capability. It is obviously easier to slide on packed snow than in deep sand. Surfaces with extremely low or extremely high coefficients of friction must not be used for skidding maneuvers. It is dangerous to skid on ice, because you may lose all directional control, and it is dangerous to skid on pavement, because you may regain traction suddenly and unexpectedly, which can cause you to lose your balance and overturn.



## Climbing Hills

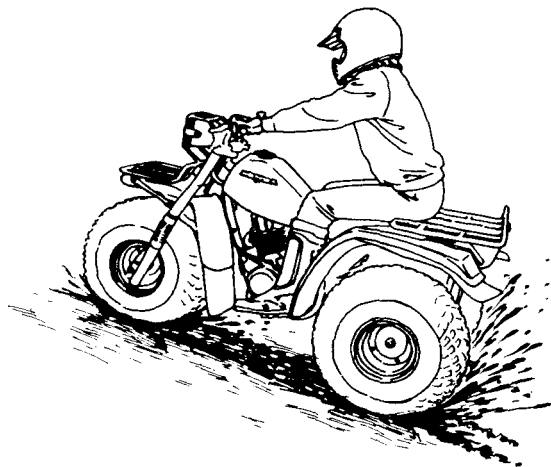

Practice climbing on evenly surfaced slopes of less than  $20^{\circ}$ . The ATC's capability in climbing hills or traversing any specific terrain is dependent upon rider skill. As you gain experience in handling the ATC and learn the hazards to be encountered and your own limitations, you may then proceed to ride more challenging terrain. However, you must first be able to discern and avoid any hill or hazard that would cause the ATC to overturn.

The riding technique for hill climbing involves transferring your weight toward the front wheel to keep it in contact with the ground. This may be done by leaning forward, or for greater weight transference, by standing on the footpegs and leaning forward.

Take a running start, in the appropriate gear and speed for the ascent, and climb at a steady rate of speed.

### **WARNING**

- \* *Do not apply power suddenly by opening the throttle or changing gears while ascending a hill, or the front wheel may rise from the ground. If the front wheel lifts, rider control will be lessened and the ATC may overturn backward.*

If you should find that you have incorrectly estimated climbing capability and lack the power or traction to continue the ascent, then turn the ATC around if space permits, while you still have the forward speed to do so and descend. Avoid stalling part way up a hill, as maneuvering will then become more difficult.

**WARNING**

*\* Before attempting a turn on a hillside, the rider should first master turning technique on level ground.*

If you do lose all forward speed and can neither continue uphill nor maneuver the ATC under its own power, dismount and physically turn the machine around. If it cannot be turned and must be backed down, first shift the transmission into neutral. However, we strongly recommend that the rider turn the ATC around rather than back it downhill.

**WARNING**

*\* To avoid overturning, the rider must exercise a high degree of caution when dismounting or moving the ATC on a hillside.*

*\* Applying the brakes or engaging the transmission while rolling backward downhill can easily cause the ATC to overturn and fall on the rider.*



## Descending Hills

It is usually advisable to descend hills with the ATC pointed directly downhill, avoiding angles that would cause the vehicle to lean sharply to one side. As you approach the point of descent, stop and survey the terrain below. Never ride headlong past your limit of visibility. When you have picked a safe path of descent, shift the transmission into low gear and descend slowly with the throttle closed. Sit back on the seat, with arms extended and braced on the handlebars.

When descending sand dunes, we recommend that the rider apply the brake intermittently to further reduce forward speed.

Braking effectiveness is, of course, reduced while descending any incline with a loose surface.

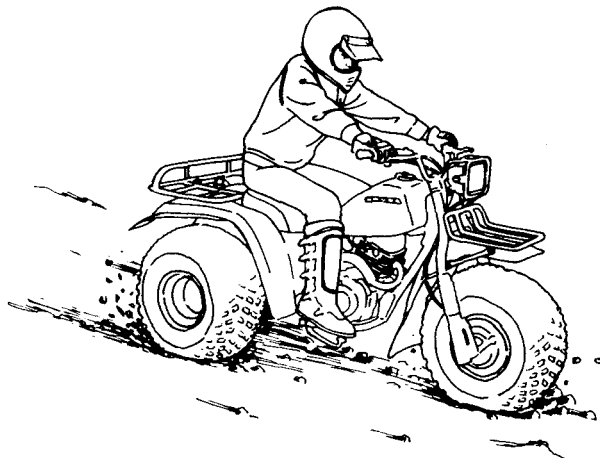

## Traversing Slopes

When riding across a slope at right angles to the incline of the hill, lean your body uphill to maintain balance and stability. On a loose surface such as sand, it may become necessary to steer slightly uphill in order to maintain your course of travel.

### WARNING

- \* *Balance is more precarious while the ATC is tilted to one side. Avoid traversing slopes where there is slippery or difficult terrain.*



## Riding Through Water

### WARNING

- \* *Do not ford any stream with fast flowing water. The tires may float, making it difficult to maintain control.*
- \* *Do not ride the ATC through water beyond its limit.*

The Honda ATC can ford water to a depth of approximately 11 inches, although the rider must be careful to avoid getting the spark plug or air cleaner wet.

When crossing streams, choose a course where both banks have gradual inclines. Proceed at a slow, steady speed, and take care to avoid submerged obstacles and slippery rocks.

After riding through water, the brakes may be less effective than normal. Test the brakes after traveling through any water, and if necessary, apply the brakes repeatedly until the heat of friction has dried them, and the brakes regain their normal effectiveness.

If they do not dry out and regain their effectiveness, stop the ATC and shut the engine OFF. Set the parking brake ON and drain any trapped water by removing the drain cap (1) from the bottom of the rear brake cover.

### CAUTION:

- \* *If any water drains, it is an indication that the rear brake seals must be replaced. Have these seals checked by your Honda dealer as soon as possible.*

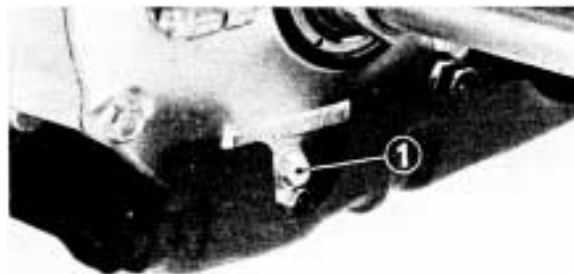

(1) Drain bolt



## High Altitude Riding

When operating this vehicle at high altitudes the air-fuel mixture becomes overly rich. Above 6,000 feet (1,800 m) driveability and performance may be reduced and fuel consumption increased. The carburetor can be modified to compensate for this high altitude richness. However, the carburetor must be returned to standard factory specifications when lower altitude riding is desired. (See page 46.)

### CAUTION:

*\* Sustained operation at altitudes below 5,000 feet (1,500 m) with high altitude carburetor modifications may cause engine overheating and damage.*

## PARKING

1. Stop the vehicle, shift the transmission into neutral, turn the fuel valve, fuel cap lever, and ignition switch OFF.
2. Pull the parking brake lever and lock it. (See page 10.)

# MAINTENANCE

## MAINTENANCE SCHEDULE

- The U.S. Environmental Protection Agency requires manufacturers to certify that vehicles built after January 1, 1983 will comply with applicable noise emission standards for one year or 3,000 km (1,865 miles) after the time of sale to the ultimate purchaser, when operated and maintained according to the instructions provided. Compliance with the terms of the Distributor's Warranty for the Honda Vehicle Noise Emission Control System is necessary in order to keep the noise emission control system in effect. (USA only)
- The maintenance intervals shown in the following schedule are based upon average riding conditions. ATC's subjected to severe use, or ridden in wet or unusually dusty areas, require more frequent servicing. Items marked \* should be serviced by an authorized Honda dealer, unless the owner has the proper tools and is mechanically proficient. Other maintenance items are simple to perform and may be serviced by the owner. Perform the Pre-ride Inspection (Page 24) at each scheduled maintenance period.

I: Inspect and Clean, Adjust, Lubricate or Replace, if necessary C: Clean A: Adjust                      R: Replace		INITIAL SERVICE PERIOD (First week of operation)	REGULAR SERVICE PERIOD (Every 30 operating days)	Refer to page	
	ENGINE OIL	NOTE (1),(2)	R	R	42
*	ENGINE OIL FILTER SCREEN		C	C	42
*	ENGINE OIL FILTER ROTOR			C	43
	AIR CLEANER ELEMENT	NOTE (2)		I	49
	SPARK PLUG			I	48

- NOTE:** (1) Replace every 30 operating days or every 3 months, whichever comes first.  
 (2) Service more frequently when riding in dusty areas.

I: Inspect and Clean, Adjust, Lubricate or Replace, if necessary C: Clean      R: Replace A: Adjust		INITIAL SERVICE PERIOD (First week of operation)	REGULAR SERVICE PERIOD (Every 30 operating days)	Refer to page
	BATTERY	I	I	59
*	VALVE CLEARANCE	I	I	50
*	CAM CHAIN TENSIONER	A	A	58
*	CARBURETOR	I	I	45
	FUEL LINE	I: (EVERY YEAR)		44
*	FUEL FILTER	C: (EVERY YEAR)		44
	THROTTLE OPERATION	I	I	58
	FINAL DRIVE OIL	I: (EVERY YEAR) R: (EVERY 2 YEARS)		57
*	BRAKE SHOES	I: (EVERY YEAR)		53
	BRAKE CONTROL LINKAGE	I	I	53
*	CLUTCH	A	A	52
*	SPARK ARRESTER		C	61
	ALL NUTS, BOLTS, FASTENERS	I	I	—
	LIGHTING EQUIPMENT	I	I	—
	TIRES	I	I	22
*	STEERING HEAD BEARING	A: (EVERY YEAR)		—

**WARNING**

- \* *Always turn the engine off before performing any maintenance operations unless otherwise stated.*
- \* *To maintain the safety and reliability of your HONDA ATC do not modify it and use only new genuine HONDA parts or their equivalent when servicing or repairing.*  
*The use of replacement parts which are not of equivalent quality may impair the operation of your ATC.*

**TOOL KIT**

The tool kit is stored in the compartment (1) shown below. The tools provided are sufficient to perform routine maintenance and simple repairs. Any extensive work requiring additional tools should be performed by an authorized Honda motorcycle dealer. Listed below are the items included in the tool kit:

- 10 x 12 mm open end wrench
- 14 x 17 mm open end wrench
- 24 mm box end wrench
- Handle for box end wrench
- 17 mm box wrench
- T-handle
- Handle for screw driver
- Screw driver blade
- Pliers
- Tool bag

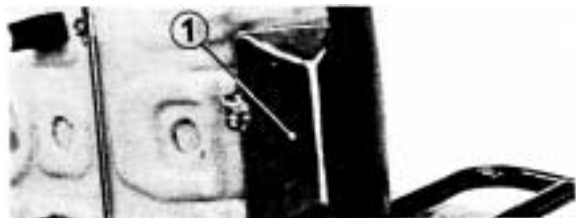

(1) Tool compartment

## ENGINE OIL

Engine oil should be changed in accordance with the maintenance schedule. Use motor oils of the grade and viscosity recommended on Page 20. When changing oil, drain the oil from the crankcase while the engine is still warm. This will ensure complete and rapid draining.

1. Remove the oil filler cap from the right crankcase cover.
2. Place an oil drain pan under the crankcase and remove the oil drain plug (1) with a 24mm socket wrench.

### NOTE:

- \* The oil filter screen (2) and spring (3) will come out when the drain plug is removed.

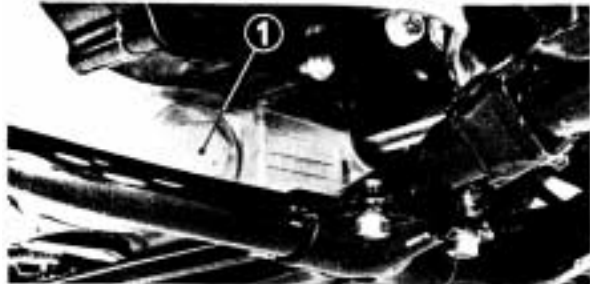

(1) Drain plug

3. After the oil stops draining turn the ignition switch and engine stop switch OFF and pull the recoil starter several times to drain any oil which may be left in the engine.
4. Clean the oil filter screen.
5. Check that the oil filter screen, sealing rubber and drain plug O-ring are in good condition and install them with the drain plug.
6. Fill the crankcase with approximately 1.5ℓ (1.6 US qt) of the recommended grade of motor oil.
7. Make sure that the oil level is between the upper and lower marks on the dipstick. If necessary, add more oil but do not overfill.



(2) Oil filter screen (3) Spring

## OIL FILTER ROTOR

1. Drain the oil from the engine.
2. Remove the right footpeg.
3. Remove the right crankcase cover bolts and cover (1).
4. Remove the oil filter rotor cover (2) and clean the inside of the rotor cover (2) and rotor.
5. Install the rotor cover, aligning the teeth on the friction spring with the groove in the cover.
6. Tighten the rotor cover bolts to 10–14 N·m (1.0–1.4 kg·m, 7–10 ft·lb) torque.
7. Install all other parts removed in the reverse order of removal.
8. Fill the crankcase with the recommended oil (page 20).

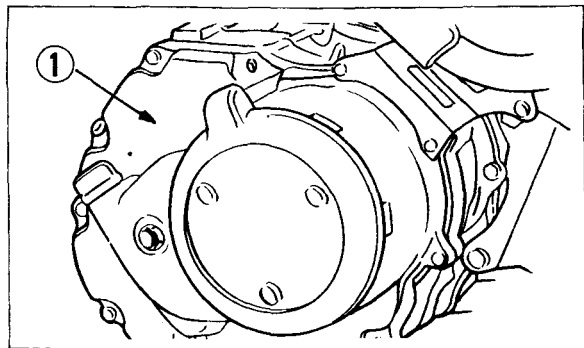

(1) Right crankcase cover

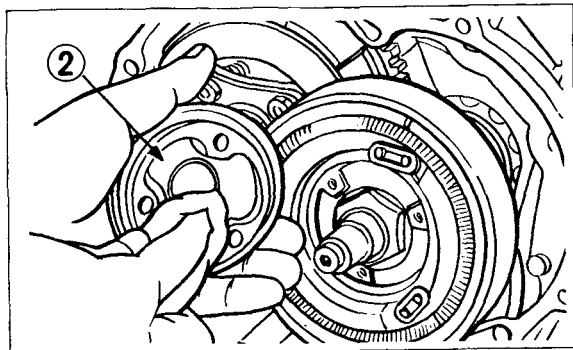

(2) Rotor cover

## FUEL FILTER

The fuel filter is incorporated in the fuel valve. Accumulation of dirt in the filter will restrict the flow of fuel, therefore, the fuel filter should be serviced periodically.

1. Drain the fuel from the fuel tank. Disconnect the fuel line.

### WARNING

*\* Gasoline is extremely flammable and is explosive under certain conditions. Perform this operation in a well-ventilated area. Do not smoke or allow flames or sparks near the equipment while draining fuel.*

2. Remove the fuel valve (1) by loosening the mounting nut and remove the fuel filter (2). Wash it in clean non-flammable or high flash point solvent.

### WARNING

*\* Never use gasoline or low flash point solvents for cleaning the fuel filter. A fire or explosion could result.*

3. Reinstall the fuel filter and fuel valve in the reverse order of removal and turn the fuel valve ON. Check for leaks.
4. Check the fuel line (3) for deterioration, damage or leakage. Replace if necessary.

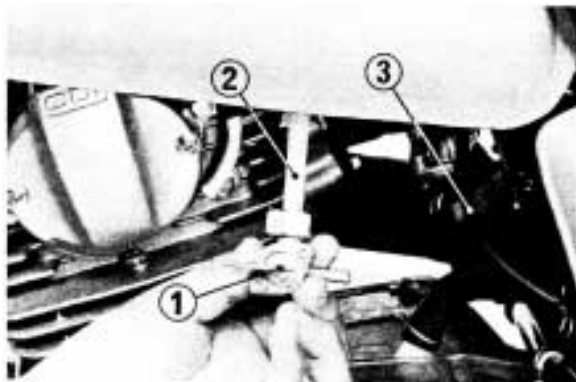

(1) Fuel valve  
(2) Fuel filter

(3) Fuel line

## CARBURETOR

The engine must be warm for accurate idle adjustment. Ten minutes of stop-and-go riding is sufficient.

### NOTE:

\* Do not attempt to compensate for faults in other systems by carburetor adjustment. See your authorized Honda dealer for regularly scheduled carburetor adjustments.

1. Warm up the engine.
2. Adjust idle speed with the throttle stop screw (1).  
IDLE SPEED:  $1,400 \pm 100$  rpm
3. To adjust the fuel mixture, turn the pilot screw (2) clockwise until you hear the engine miss or decrease in speed, then counterclockwise until the engine again misses or decreases in speed. Center the pilot screw exactly between these two extreme positions.

Usually the correct setting (between extremes of rich and lean) will be found to be 2 turns open from a fully closed position.

If idle speed changes after adjusting the fuel mixture, readjust the throttle stop screw.

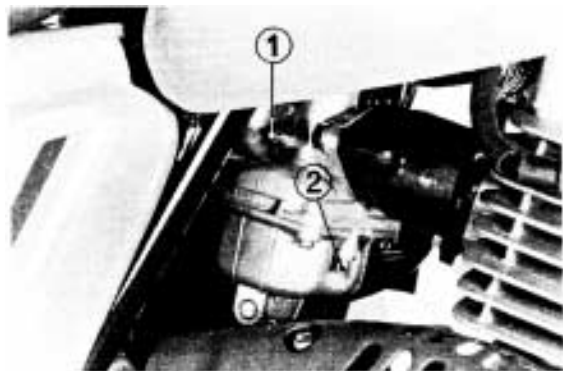

(1) Throttle stop screw

(2) Pilot screw



## HIGH ALTITUDE

When operating this ATC at high altitude the air-fuel mixture becomes overly rich.

Above 6,000 feet (1,800 m) driveability and performance may be reduced and fuel consumption increased.

A high altitude jet is available for carburetor modification to compensate for this high altitude richness. Although installation and adjustment procedures are offered here. We strongly urge that this carburetor modification be performed by your authorized Honda dealer, unless you are mechanically proficient and have the necessary tools.

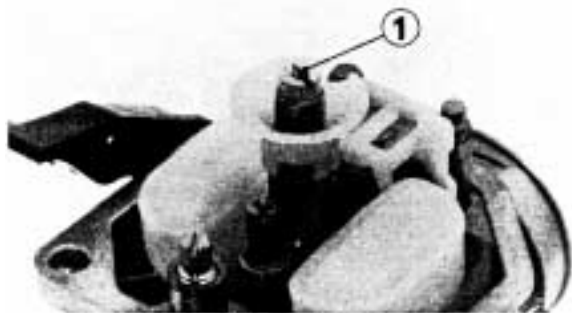

(1) Main jet

### CAUTION:

- \* *Sustained operation at lower altitudes below 5,000 feet (1,500 m) with the high altitude jet installed may cause engine overheating and damage.*

Altitude	Main jet	Pilot screw	Jet needle
Below 6,000 feet	No. 95	Factory preset	3rd notch
Above 5,000 feet	No. 90	Factory preset	2nd notch

Installation: Above 5,000 ft (1,500 m)

1. Turn the fuel valve OFF.
2. Place the carburetor drain tube in a suitable container. Turn the carburetor drain screw counterclockwise and drain the carburetor.

### WARNING

- \* *Gasoline is extremely flammable and is explosive under certain conditions. Perform this operation in a well-ventilated area. Do not smoke or allow flames or sparks in the area.*

3. Remove the carburetor by removing the nuts. Unscrew the carburetor cap, pull out the throttle valve (3), and remove the carburetor.
4. Remove the float chamber.
5. Remove the standard main jet (1) No. 95, and install the high altitude main jet No. 90. Reinstall the float chamber.
6. Remove the jet needle from the throttle valve. Change the position of the E-clip (2) from the 3rd notch to the 2nd notch. Reinstall the jet needle into the throttle valve.
7. Slide the throttle valve into the carburetor and tighten the cap. Install the carburetor. Make sure the drain screw is turned fully clockwise and turn the fuel valve ON.
8. Start the engine. Adjust the idle speed and pilot screw (page 45).

**NOTE:**

- \* Adjust the idle speed and pilot screw at high altitude to ensure proper high altitude operation.

**Removal: Below 6,000 ft (1,800 m)**

1. Follow installation steps 1-4.
2. Reinstall the original No. 95 main jet.
3. *Change the jet needle clip back to the 3rd notch.*
4. Reinstall the carburetor. Adjust the idle speed and pilot screw (page 45).

**NOTE:**

- \* Adjust the idle speed and pilot screw at low altitude to ensure proper low altitude operation.

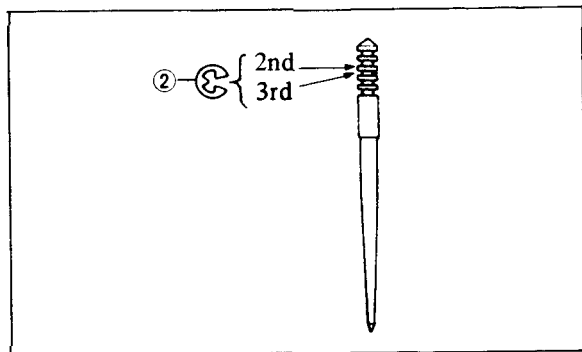

(2) E-clip

## SPARK PLUG

### Standard spark plug

DR8ES-L (NGK), X24ESR-U (ND)

#### CAUTION:

- \* *The use of spark plugs of incorrect size or heat range can cause serious engine damage.*

1. Disconnect the spark plug cap.
2. Clean any dirt from around the spark plug base.
3. Remove the plug with the wrench provided in the tool kit.
4. Visually inspect the spark plug electrodes for wear. The center electrode should have square edges and the side electrode should not be eroded. If the electrodes and insulator tip appear unusually fouled or burned, we suggest that you contact an authorized Honda dealer for inspection of the ATC. Discard the spark plug if there is apparent wear or if the insulator is cracked or chipped.
5. Make sure that the spark plug gap is 0.6–0.7 mm (0.024–0.028 in) using a wire-type feeler gauge. If adjustment is necessary, bend the side electrode (1) carefully.

6. With the plug washer attached, thread the spark plug in by hand to prevent cross-threading.
7. Tighten a new spark plug 1/2 turn with the spark plug wrench to compress the washer. If you are reusing a plug, it should only take 1/8–1/4 turn after the plug seats.

#### CAUTION:

- \* *The spark plug must be securely tightened. An improperly tightened plug can become very hot and possibly damage the engine.*



(1) Side electrode

## AIR CLEANER

The air cleaner element accumulates dust and must be cleaned periodically. If the ATC Big Red is ridden in dusty areas, the element must be cleaned at more frequent intervals than specified in the MAINTENANCE SCHEDULE.

To clean the filter element:

1. Remove the seat by pulling the lever (1).
2. Remove the four wing nuts (2) attaching the air cleaner case.
3. Pull out the retainer clip and remove the air cleaner assembly from the frame.
4. Remove the filter element (3), wash it in non-flammable or high flash point solvent and allow it to dry thoroughly.

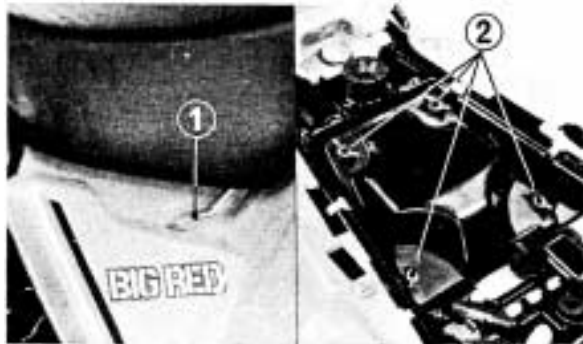

(1) Lever

(2) Wing nuts

### WARNING

- \* *Never use gasoline or low flash point solvents for cleaning the air cleaner element. A fire or explosion could result.*
5. Soak the filter element in clean gear oil (SAE 80- $\text{SAE}90$ ) until saturated, then squeeze out the excess oil.
  6. Reassemble by reversing the disassembly sequence.

### CAUTION:

- \* *Do not twist the filter element when squeezing the filter element.*

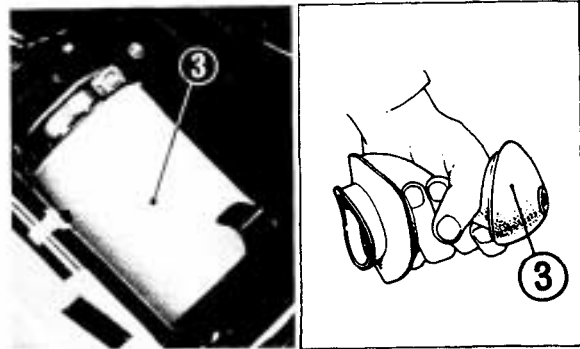

(3) Filter element

## VALVES

Valve clearance should be maintained at 0.05 mm (0.002 in). Excessive clearance will cause noise. Insufficient clearance will cause loss of power and could cause valve damage.

### NOTE:

- \* Check and adjust valve clearances while the engine is cold. The clearance will change as the temperature rises.
1. Remove the timing mark cover and valve adjusting caps.
  2. Using the recoil starter, rotate the alternator rotor counterclockwise until the T mark (1) on the alternator rotor lines up with the timing index mark (2) on the cover. In this position, the piston may either be on the compression or the exhaust stroke. The adjustment must be made when the piston is on top of the compression stroke and both the intake and exhaust valves are closed. This can be determined by moving the rocker arms by hand. If they are free, it is an indication that the valves are closed and that the piston is on the compression stroke. If they are tight and the valves are open, rotate the alternator rotor 360° (one complete revolution) and realign the T mark to the timing index mark.

3. Check the clearance of both valves by inserting a 0.05 mm (0.002 in) feeler gauge (5) between the adjusting screw and valve stem.

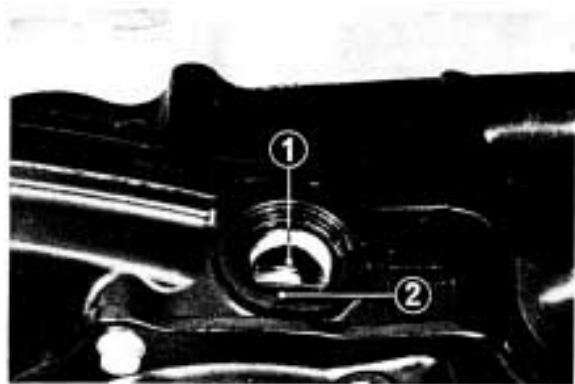

(1) T mark

(2) Index mark

4. If adjustment is necessary, loosen the adjusting screw lock nut (3) and turn the screw (4) so that there is a slight resistance when the feeler gauge (5) is inserted.
5. After adjustment, tighten the lock nut while holding the adjusting screw to prevent it from turning.
6. Recheck the clearance to make sure that it has not changed.
7. Reinstall the timing mark cover and valve adjusting caps.

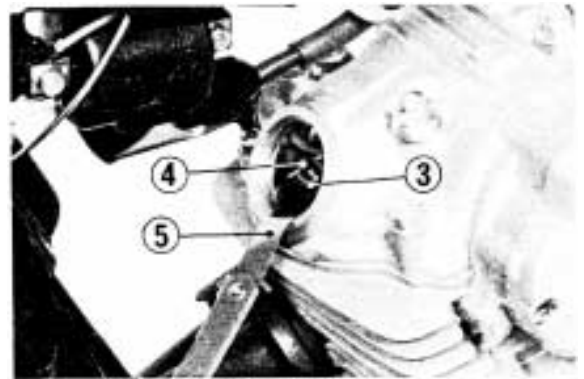

(3) Lock nut                      (5) Feeler gauge  
(4) Adjusting screw

## CLUTCH

1. Make sure the ignition switch is OFF.
2. Loosen the lock nut (1), and turn the clutch adjuster (2) counterclockwise until you feel resistance. Then turn 1/4 turn clockwise, and tighten the lock nut to hold the adjuster in this position.
3. After adjustment, start the engine and test ride the ATC to be certain that the clutch is operating properly.

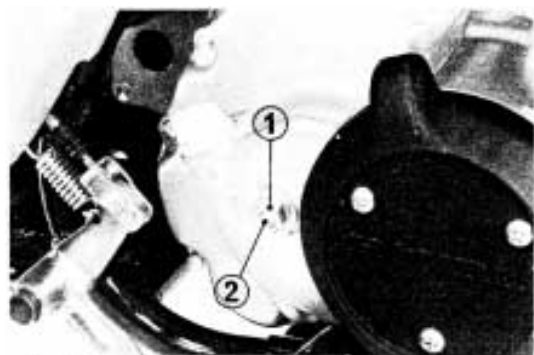

(1) Lock nut      (2) Clutch adjuster

# BRAKES

## Front Brake Lever

Measure the distance the brake lever moves before the brake starts to take hold.

Free play, measured at the tip of the front brake lever (1), should be within 15–20 mm (5/8–3/4 in.).

Minor adjustments can be made with the cable adjuster (2) on the front brake lever. Loosen the lock nut (3) and turn the front brake cable adjuster (2).

Major adjustment should be made using the lower adjuster (4). Loosen the lock nut (3) and turn the front brake cable adjuster (2) all the way in before making major adjustment.

### NOTE:

\* Make sure the cut-out on the adjusting nut (4) is seated on the brake arm pin

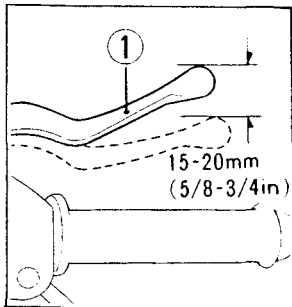

(1) Front brake lever

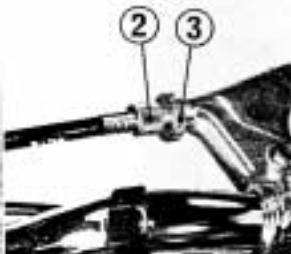

(2) Brake cable adjuster  
(3) Lock nut

### Other Checks:

Check the brake cable for kinks or signs of wear that could cause sticking or failure. Lubricate the brake cable with a commercially available cable lubricant to prevent premature wear and corrosion.

Make sure the brake arm, spring, and fasteners are in good condition.

### Wear Indicator:

When the brake is applied, an arrow (5) attached to the brake arm (6) moves toward a reference mark (7) on the brake panel.

If the arrow aligns with the reference mark on full application of the brake, the brake shoes must be replaced. See your authorized Honda dealer for this service.

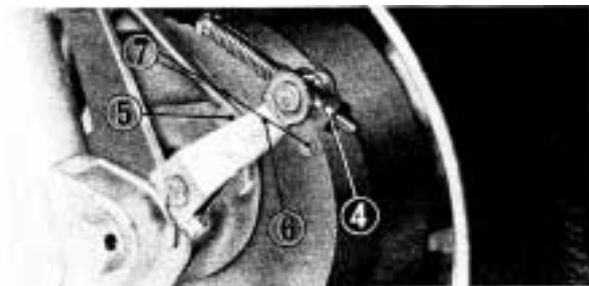

(4) Adjusting nut  
(5) Arrow

(6) Brake arm  
(7) Reference mark



## Rear Brake Pedal

Measure the distance the rear brake pedal moves before the brake starts to take hold.

Free play, measured at the end of the pedal (1), should be 15–20 mm (5/8–3/4 in.).

Adjust by turning the brake pedal adjusting nut (2) located on the brake operating rod at the rear of the frame.

### NOTE:

\* Make sure the cut-out on the adjusting nut is seated on the brake arm pin.

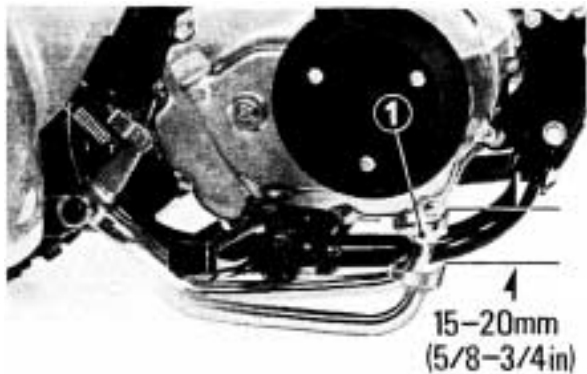

(1) Rear brake pedal

### Other Checks:

Check the brake cable for kinks or signs of wear that could cause sticking or failure. Lubricate the brake cable with a commercially available cable lubricant to prevent premature wear and corrosion.

Make sure the brake arm, spring, and fasteners are in good condition.

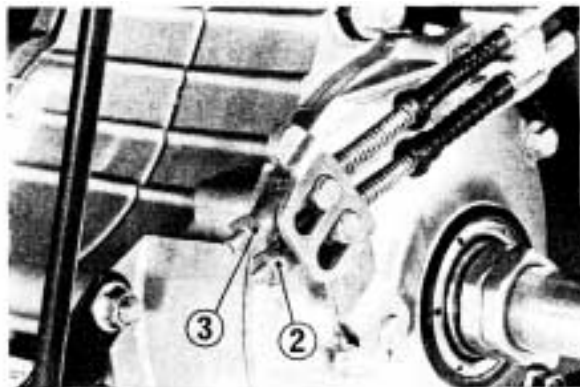

(2) Brake pedal adjusting nut

(3) Brake lever adjusting nut

## Rear Brake Lever/Parking Brake

Measure the distance the rear brake lever moves before the brake starts to take hold.

Free play, measured at the tip of the brake lever (4), should be within 15–20 mm (5/8–3/4 in). Minor adjustments can be made with the cable adjuster (6) on the front brake lever. Loosen the lock nut (5) and turn the front brake cable adjuster (6). Major adjustments should be made using the lower adjuster (7) located on the brake arm (8).

### Other Checks:

Check the brake cable for kinks or signs of wear that could cause sticking or failure. Lubricate the brake cable with a commercially available cable lubricant to

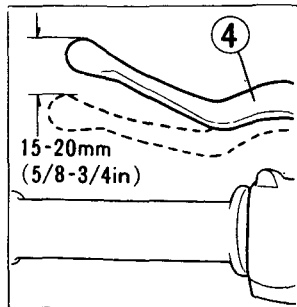

(4) Rear brake lever

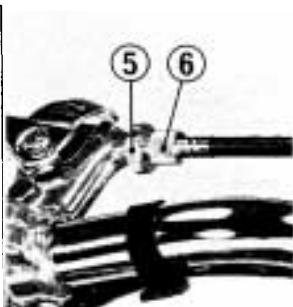

(5) Lock nut

(6) Adjuster

prevent wear and corrosion. Make sure the brake arm, spring, and fasteners are in good condition.

### Wear Indicator:

When the brake is applied, an arrow (9), attached to the brake arm (8), moves toward a reference mark (10) on the brake panel.

If the arrow aligns with the reference mark on full application of the brake, the brake shoes must be replaced. See your authorized Honda dealer for this service.

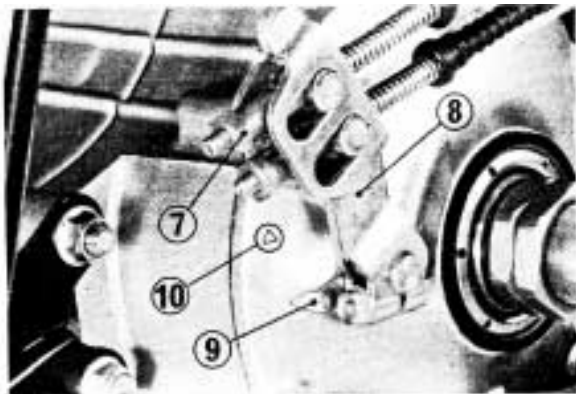

(7) Lower adjuster

(8) Brake arm

(9) Arrow

(10) Reference mark

## THROTTLE CABLE

Inspect the throttle cable for condition and operation. Replace the cable if it has become worn or kinked. Lubricate the cable with a commercially available cable lubricant to prevent premature wear and corrosion. Free play, measured at the tip of the throttle lever (1), should be maintained at 5–10 mm (3/16–3/8 in).

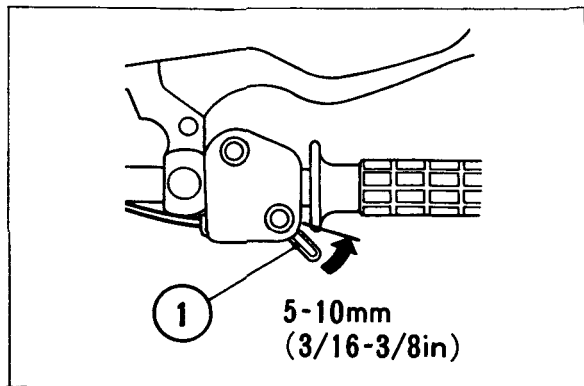

(1) Throttle lever

The cable adjuster (3) is located on top of the carburetor. Slide the rubber sleeve (2) back to expose the throttle cable adjuster (3). Turn the adjuster to obtain the correct free play. Reinstall the sleeve after adjustment.



(2) Rubber sleeve  
(3) Cable adjuster

(A) Increase free play  
(B) Decrease free play

## FINAL DRIVE OIL

Change the oil when specified by the maintenance schedule.

### NOTE:

\* Change the oil with the final drive warm and the ATC on level ground to assure complete and rapid draining.

1. To drain the oil, remove the oil filler cap (1) and drain plug (2).
2. After the oil has completely drained, install the drain plug.

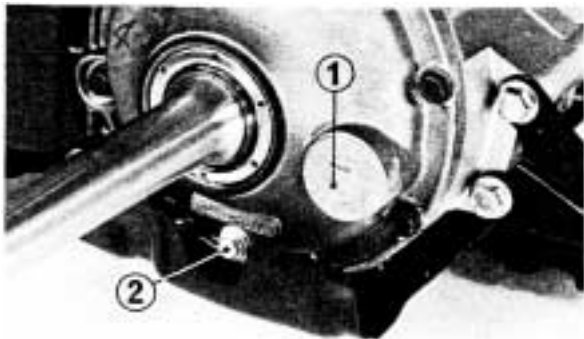

- (1) Oil filler cap
- (2) Oil drain plug

### Drain Plug Torque:

10–14 N·m (1.0–1.4 kg·m, 72–10 ft·lb)

3. Fill the final drive with approximately 350 cc (11.8 US oz) of the recommended oil. Make sure the recommended oil is filled up to the lower edge of the inspection hole (3).
4. Install the oil filler cap.

Recommended oil: HYPOID GEAR OIL SAE80

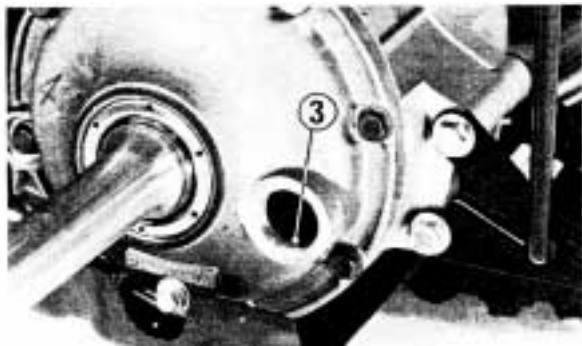

- (3) Inspection hole

## CAM CHAIN

An improperly adjusted cam chain will adversely affect engine performance. The cam chain will rattle and be noisy if it needs a tension adjustment.

To adjust the cam chain:

1. Start the engine and let it idle.
2. Remove the rubber cap (1) and loosen the tensioner adjusting bolt (2).

When it is loosened, the cam chain tensioner will automatically position itself to provide the correct cam chain tension.

3. Retighten the tensioner adjusting bolt and install the rubber cap.

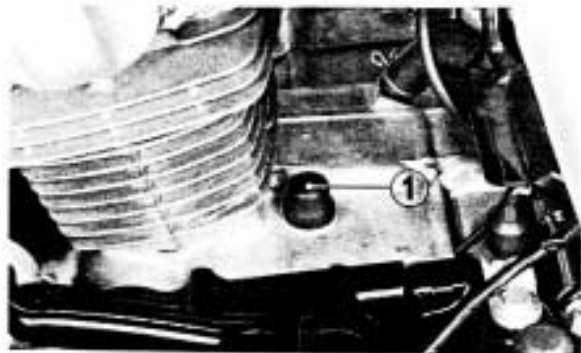

(1) Rubber cap

### NOTE:

- \* Do not attempt to loosen the 6mm bolt (3) while adjusting.

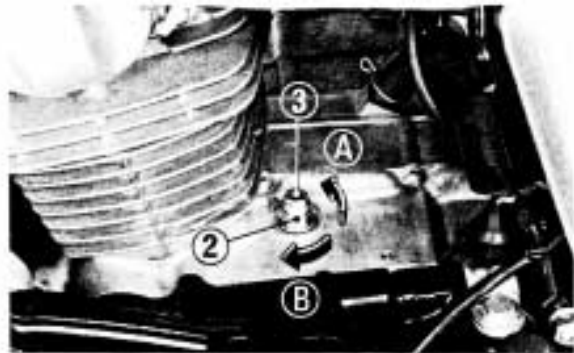

(2) Tensioner adjusting bolt (A) Loosen to adjust  
(3) 6mm bolt (B) Tighten

## BATTERY

If the ATC Big Red is operated with insufficient battery electrolyte, sulfation and battery plate damage will occur. If rapid loss of electrolyte is experienced, or if your battery seems to be weak, causing slow starting or other electrical problems, see your authorized Honda dealer.

### Battery electrolyte:

The battery (1) is under the seat. Remove the seat by pulling the seat lever. The electrolyte level must be maintained between the upper (4) and lower (5) marks on the side of the battery. If the electrolyte level is near the lower level mark, remove the battery filler caps (2), and carefully add distilled water to the upper level mark, using a small plastic funnel or syringe.

### CAUTION:

- \* *When checking battery electrolyte level or adding distilled water, make sure the breather tube is connected to the battery breather outlet (3).*

### NOTE:

- \* Use only distilled water in the battery. Tap water may shorten the service life of the battery.

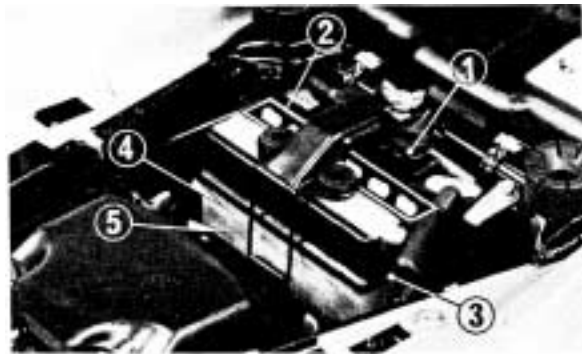

- (1) Battery
- (2) Battery filler caps
- (3) Battery breather outlet
- (4) Upper level mark
- (5) Lower level mark

 **WARNING**

- \* *The battery contains sulfuric acid. Avoid contact with skin, eyes or clothing. Antidote: EXTERNAL-Flush with water. INTERNAL-Drink large quantities of water or milk. Follow with milk of magnesia, beaten egg or vegetable oil. Call physician immediately. Eyes: Flush with water and get prompt medical attention.*
- \* *Batteries produce explosive gases. Keep sparks, flames and cigarettes away. Ventilate when charging or using in enclosed spaces. Always shield eyes when working near batteries.*
- \* **KEEP OUT OF REACH OF CHILDREN.**

**CAUTION:**

- \* *The battery breather tube must be routed as shown on the label. Do not bend or twist the breather tube. A bent or kinked breather tube may pressurize the battery and damage its case.*

## SPARK ARRESTER

The exhaust system must be periodically purged of accumulated carbon.

1. Remove the spark arrester bolts (1) and slide the diffuser (2) out.

### WARNING

*\* The exhaust system becomes VERY HOT even after short periods of engine operation.*

2. Clean the diffuser of accumulated carbon.
3. Start the engine with the transmission in neutral, and purge accumulated carbon from the spark arrester system by momentarily revving up the engine several times.

### WARNING

*\* To avoid fire hazards, DO NOT perform this maintenance in the vicinity of flammable materials.*

4. Stop the engine and allow the exhaust pipe to cool.
5. Reinstall the diffuser with the spark arrester bolts.

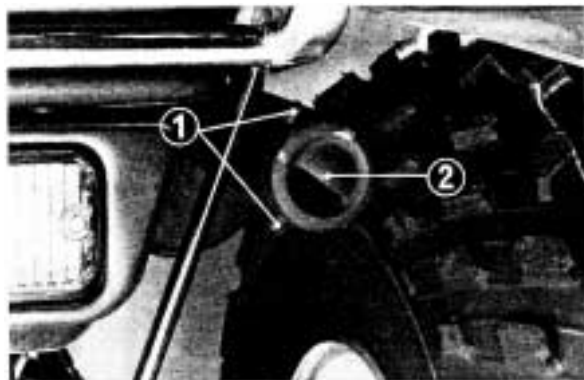

(1) Spark arrester bolts      (2) Diffuser



## STORAGE

Extended storage, such as for winter, requires that you take certain steps to reduce the effects of deterioration from non-use of the ATC. In addition, necessary repairs should be made **BEFORE** storing the ATC; otherwise, these repairs may be forgotten by the time the ATC is removed from storage.

1. Change the engine oil and clean the oil filter screen and the oil filter rotor.
2. Drain the fuel tank and carburetor. Spray the inside of the tank with an aerosol rust-inhibiting oil. Reinstall the fuel cap on the tank.

 **WARNING**

- \* *Gasoline is flammable and is explosive under certain conditions. Do not smoke or allow flames or sparks near the equipment while draining fuel.*

3. Remove the spark plug and pour a tablespoon (15–20 cc) of clean engine oil into the cylinder. Operate the starter for a few seconds to distribute the oil, then reinstall the spark plug.

**NOTE:**

- \* When turning the engine over, the Engine Stop Switch should be OFF and the spark plug placed in its cable cap and grounded to prevent damage to the ignition system.
4. Remove the battery. Store in an area protected from freezing temperatures and direct sunlight. Check the electrolyte level and slow charge the battery once a month.
  5. Wash and dry the ATC. Wax all painted surfaces.

6. Inflate the tires to their recommended pressures. Place the ATC on blocks to raise both tires off the ground.
7. Cover the ATC (don't use plastic or other coated materials) and store in an unheated area, free of dampness with a minimum of daily temperature variation. Do not store the ATC in direct sunlight.

## **REMOVAL FROM STORAGE**

1. Uncover and clean the ATC. Change the engine oil if more than 4 months have passed since the start of storage.
2. Check the battery electrolyte level and charge the battery as required. Install the battery.
3. Drain any excess aerosol rust-inhibiting oil from the fuel tank. Fill the fuel tank with fresh gasoline.
4. Perform all Pre-ride Inspection checks (page 24). Test ride the ATC at low speeds in a safe riding area.

## TRANSPORTING

1. Turn the fuel tank cap lever and fuel valve OFF.
2. Place the carburetor drain tube in a suitable container.
3. Turn the drain screw counterclockwise to drain the gasoline from the carburetor.

### WARNING

- \* *Gasoline is flammable and is explosive under certain conditions. Do not smoke or allow flames or sparks near the equipment while draining fuel.*
- \* *Never incline the machine with the front wheel up, or rest it on its side without draining the fuel and removing the battery. Fuel vapor or spilled fuel may ignite and the battery may leak electrolyte.*

4. After draining turn the drain screw clockwise until tight.

### NOTE:

- \* Be sure the fuel drain is closed (screw turned clockwise) before refueling the ATC.
  - \* It is not necessary to drain the engine oil from the crankcase, as no appreciable oil leakage will occur when the ATC is rested on its side.
5. Remove the battery, disconnecting the negative (-) terminal first, then the positive (+) terminal. When reinstalling the battery, connect the positive (+) terminal first, then the negative (-).
  6. If wheel removal is required when transporting, follow the procedures on the following pages.

## Front Wheel Removal

1. Place a support block under the engine to raise the front wheel off the ground.
2. Remove the front brake adjusting nut (1) and disconnect the front brake cable.
3. Remove the cotter pin (2) and remove the axle nut (3).
4. Remove the axle (4) and remove the axle collar and front wheel.

### NOTE:

- \* Cover the wheel hub as soon as the axle has been removed to prevent the entry of dirt.

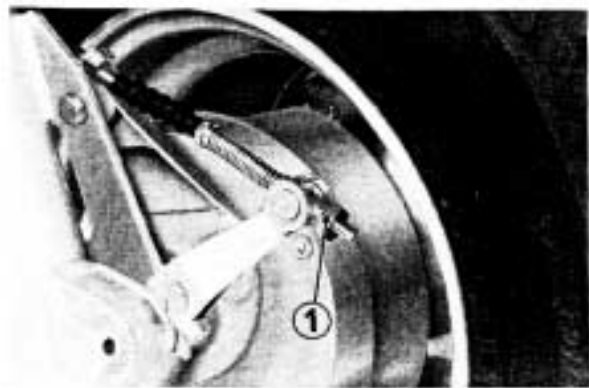

(1) Adjusting nut

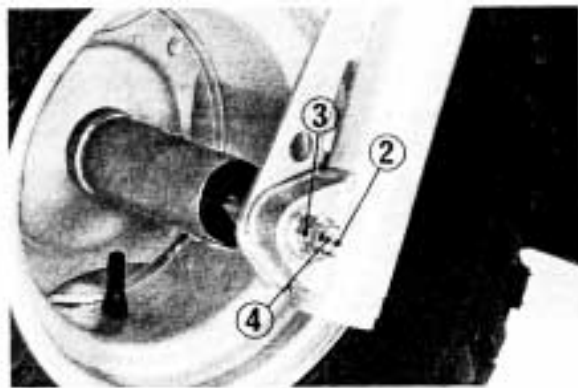

(2) Cotter pin

(3) Axle nut

(4) Axle

## Installation:

1. Install the front wheel between the front forks inserting the brake panel pin into the hole in the right front fork.
2. Install the axle collar and insert the front axle through the right front fork, front brake panel, front wheel, collar and left front fork.
3. Tighten the axle nut to 60–80 N·m (6.0–8.0 kg-m, 43–58 ft-lb) torque.
4. Insert the new cotter pin.
5. Install the front brake cable and adjust the front brake lever free play.

### WARNING

- \* *If a torque wrench was not used for installation, see your dealer as soon as possible to verify proper assembly.*
- \* *Be certain that the axle nut is tightened and secured by a cotter pin. If it is not, the wheel may come loose during operating.*

### CAUTION:

- \* *When the front axle is reinstalled, be careful that the grease seal is not cut or damaged.*
- \* *Always replace used cotter pins with new ones. To reduce the hazard of snagging the ends of the cotter pin while the ATC is operated, we recommend that the projecting ends of the front axle cotter pin be cut close to the axle nut.*

## Rear Wheel Removal

1. Place a support block under the vehicle and raise the rear wheel off the ground.
2. Loosen the wheel nuts (1) with a 12 mm socket wrench.
3. Remove the wheel.

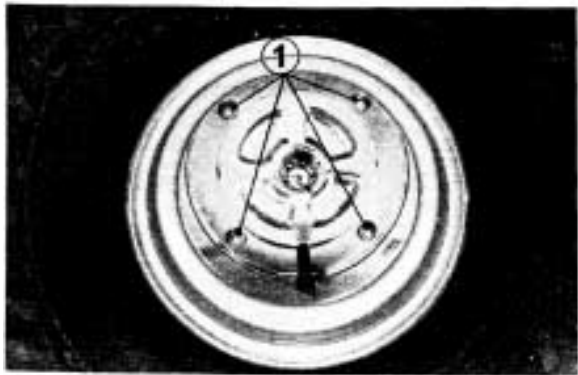

(1) Wheel nuts

## Installation Notes:

Reinstall the rear wheels and tighten the wheel nuts (1) in a cross pattern to 20–25 N·m (2.0–2.5 kg·m, 14–18 ft·lb).

### **WARNING**

*\* If a torque wrench was not used for installation, see your dealer as soon as possible to verify proper assembly.*

## //////////////////// NOISE EMISSION CONTROL SYSTEM (USA ONLY) //////////////////////

**TAMPERING WITH THE NOISE CONTROL SYSTEM IS PROHIBITED:** Federal law prohibits the following acts or the causing thereof: (1) The removal or rendering inoperative by any person, other than for purposes of maintenance, repair, or replacement, of any device or element of design incorporated into any new vehicle for the purpose of noise control prior to its sale or delivery to the ultimate purchaser or while it is in use: or (2) the use of the vehicle after such device or element of design has been removed or rendered inoperative by any person.

**AMONG THOSE ACTS PRESUMED TO CONSTITUTE TAMPERING ARE THE ACTS LISTED BELOW:**

1. Removal of, or puncturing the muffler, baffles, header pipes or any other component which conducts exhaust gases.
2. Removal of, or puncturing of any part of the intake system.
3. Lack of proper maintenance.
4. Replacing any moving parts of the vehicle, or parts of the exhaust or intake system, with parts other than those specified by the manufacturer.

DIMENSIONS	
Overall length	1,850 mm (72.8 in)
Overall width	1,070 mm (42.1 in)
Overall height	1,005 mm (39.6 in)
Wheelbase	1,230 mm (48.4 in)
WEIGHT	
Dry weight	170 kg (375 lbs)
CAPACITIES	
Engine oil	1.8 ℓ (1.9 US qt)
Fuel tank	11.5 ℓ (3.0 US gal)
Fuel reserve capacity	1.0 ℓ (0.26 US gal)
Passenger capacity	Operator only
ENGINE	
Bore and stroke	65 x 57.8 mm (2.6 x 2.3 in)
Compression ratio	7.8 : 1
Displacement	192 cc (11.7 cu-in)
Spark plug gap	0.6–0.7 mm (0.023–0.028 in)
Valve clearance	0.05 mm (0.002 in)

CHASSIS AND SUSPENSION	
Caster angle	69.5°
Trail length	7 mm (0.28 in)
Tire size, front and rear	25 x 12.0–9
POWER TRANSMISSION	
Primary reduction	3.333
Final reduction	4.255
Gear ratio, 1st	2.841
2nd	1.767
3rd	1.306
4th	1.026
5th	0.836
Posi-torque gear ratio	
1st	4.339
2nd	2.698
3rd	1.995
4th	1.567
5th	1.277
Reverse gear ratio	4.616



# WIRING DIAGRAM

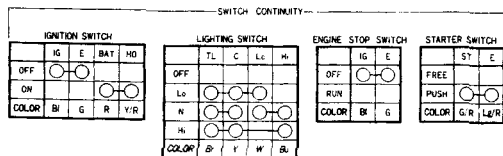
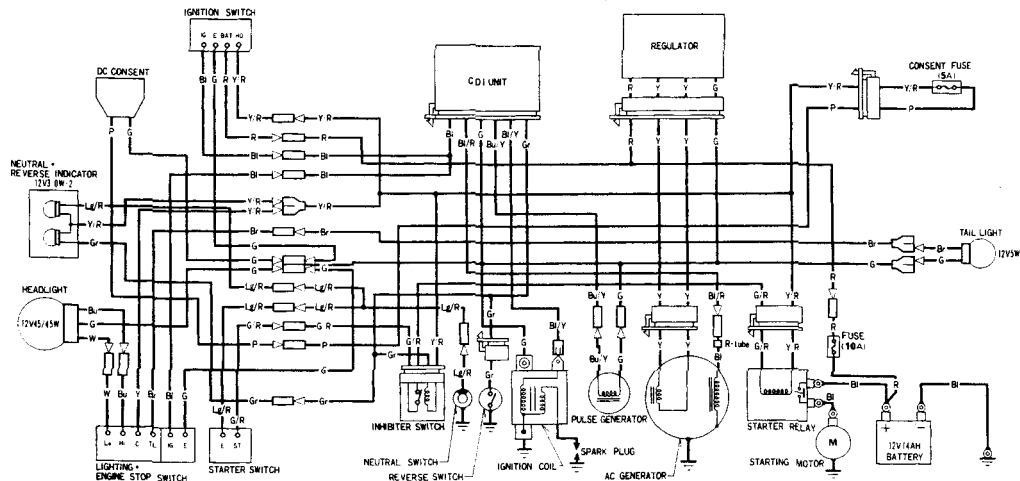

- |     |        |    |             |
|-----|--------|----|-------------|
| Bl  | BLACK  | Br | BROWN       |
| Y   | YELLOW | O  | ORANGE      |
| Blu | BLUE   | Lc | LIGHT BLUE  |
| G   | GREEN  | Lg | LIGHT GREEN |
| R   | RED    | P  | PINK        |
| W   | WHITE  | Gr | GRAY        |

0030Z-969-0100

OPTIONAL PARTS

Front Basket

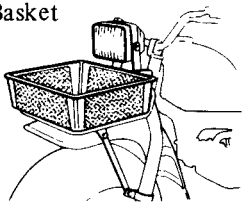

Carrier Belt

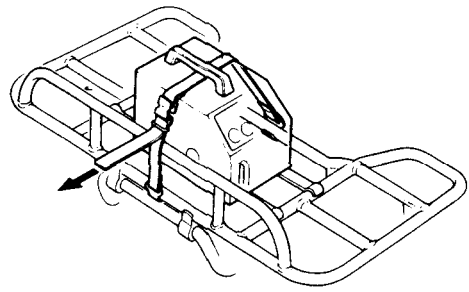

Headlight Lens Grille

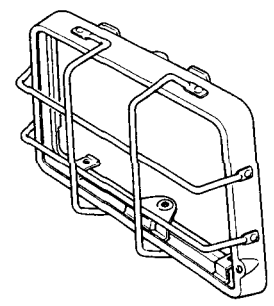

Rubber Step

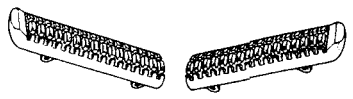

Body Cover

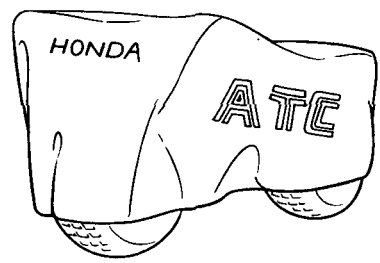

Air Pressure Gauge



Speedometer

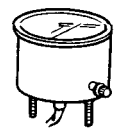

# Warranty Service

## Owner Satisfaction

Your satisfaction and goodwill are important to your dealer and to us. All Honda warranty details are explained in the Distributor's Limited Warranty. Normally, any problems with the product will be handled by your dealer's service department. Sometimes, however, in spite of the best intentions of all concerned, misunderstandings can occur. If your problem has not been handled to your satisfaction, we suggest you take the following action:

- Discuss your problem with a member of dealership management. Often complaints can be quickly resolved at that level. If the problem has already been reviewed with the Service Manager, contact the owner of the dealership or the General Manager.
- If your problem still has not been resolved to your satisfaction, contact the Motorcycle and Power Products Customer Relations Department at the regional office of American Honda Motor Co., Inc. in your area. Regional office locations are shown on the following page. We will need the following information in order to assist you:
  - Your name, address, and telephone number
  - Product model and serial number
  - Date of purchase
  - Dealer name and address
  - Nature of the problem

After reviewing all the facts involved, you will be advised of what action can be taken. Please bear in mind that your problem will likely be resolved at the dealership, using the dealer's facilities, equipment, and personnel, so it is very important that your initial contact be with the dealer:

Your purchase of a Honda product is greatly appreciated by both the dealer and American Honda Motor Co., Inc. We want to assist you in every way possible to assure your complete satisfaction with your purchase.

31969600  
PRINTED IN USA