

HONDA

ATC 70

Owner's Manual

READ BEFORE YOU RIDE!



'82

IMPORTANT NOTICE

- **FOR OFF-ROAD USE ONLY.**

This vehicle is designed and manufactured for off-road use only. It is equipped with a USDA approved spark arrester. It does not conform to Federal Motor Vehicle Safety Standards and operation on public streets, roads, or highways is illegal.

- **OPERATOR ONLY. NO PASSENGERS.**

This vehicle is designed and constructed as an operator-only model. The vehicle load limit and seating configuration do not safely permit the carrying of a passenger.

- **READ OWNER'S MANUAL CAREFULLY.**

All information in this publication is based on the latest product information available at the time of approval for printing. HONDA MOTOR CO., LTD. Reserves the right to make changes at any time without notice and without incurring any obligation whatever.

No part of this publication may be reproduced without written permission.



PREFACE

This booklet is your guide to the basic operation and proper maintenance of your new Honda ATC 70. Please take the time to read it carefully. Details necessary for riding the Honda ATC are given on later pages to acquaint the new owner with special riding techniques to be learned. Your authorized Honda dealer will be glad to provide assistance or further information and is equipped to handle your future service needs.

Thank you for selecting a Honda. We wish you continued riding pleasure in the miles ahead.



Message to Mom & Dad:

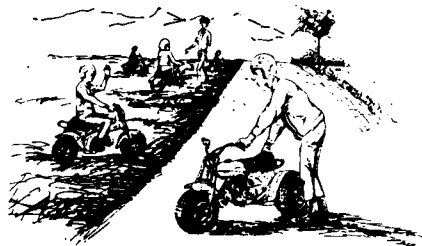

Most Honda ATC 70's will be operated by junior riders. In many instances, this is their initial introduction to the sport of motorcycling. Before your sons or daughters start to ride, it is important that you review the contents of this manual with them. A preliminary understanding of proper operation and maintenance will facilitate training and will contribute to their safety and the service life of the machine.

The Honda ATC 70 is designed and equipped for off-road use only and should not be operated on public streets. An ATC 70 is less visible to traffic than larger machines. If the rider must cross a street to reach his riding area, then for safety and to comply with laws in many states, he should shut off the engine and walk the ATC 70 across. When training your son or daughter, select a safe prac-

tice area with an even surface, free of obstacles.

The rider should wear protective clothing. The most important item is a good safety helmet. Eye protection, such as safety glasses, goggles, or a plastic face shield attached to the helmet, should also be worn. Clothing should protect the body as much as possible, and the rider should wear gloves and boots or sturdy shoes.

RESPECT PRIVATE PROPERTY. THE RIDER SHOULD NEVER CUT ACROSS RESIDENTIAL YARDS OR USE PRIVATE PROPERTY WITHOUT PERMISSION.

NOISE IS A NUISANCE TO YOUR NEIGHBORS. DO NOT ALTER OR REMOVE THE MUFFLER.

Pay special attention to statements preceded by the following words:

WARNING Indicates a strong possibility of severe personal injury or loss of life if instructions are not followed.

CAUTION: *Indicates a possibility of personal injury or equipment damage if instructions are not followed.*

NOTE: Gives helpful information.

This manual should be considered a permanent part of the vehicle and should remain with the vehicle when resold.



CONTENTS

SERIAL NUMBER LOCATIONS	1	PRE-RIDE INSPECTION	16
DESCRIPTION	2	STARTING THE ENGINE	17
OPERATING INSTRUCTIONS	4	BREAK-IN PROCEDURE	19
Ignition Switch	4	RIDING	19
Rear Brake Lever	4	PARKING	19
Gear Change Pedal	5	STORAGE	20
Neutral Indicator	6	MAINTENANCE	21
Choke Lever	7	Maintenance Schedule	21
Fuel Valve	8	Tool Kit	23
Fuel Tank	9	MAINTENANCE OPERATIONS	24
Fuel Drain	10	Engine Oil level	24
Oil Recommendation	11	Engine Oil Change	24
Engine Oil Level	12	Brake Adjustment	26
Throttle Lever	12	Drive Chain Adjustment	27
Speed Limiter	13	Drive Chain Lubrication	28
Step Guard	14	Valve Clearance Adjustment	29
Tires	15		

Contact Breaker Point Gap and Ignition Timing Adjustment	31
Spark Plug Replacement and Adjustment	32
Air Cleaner Maintenance	33
Throttle Cable Inspection and Adjustment	34
Carburetor Adjustment	35
Fuel Strainer Maintenance	36
Cam Chain Adjustment	37
Clutch Adjustment	38
Spark Arrester Maintenance	39
RIDING THE HONDA ATC	40
Safety Precautions	41
Turning Maneuvers	42
Climbing Hills	46
Descending Hills	48
Traversing Slopes	49

Riding Through Water	50
Tire Care	51
TRANSPORTING THE ATC.	52
Fuel	52
Removing and Installing the Rear Wheels	53
Removing the Front Wheel	54
Installing the Front Wheel	55
OPTIONAL PARTS	56
SPECIFICATIONS	57
WIRING DIAGRAM	58

SERIAL NUMBER LOCATION

SERIAL NUMBERS

The frame and engine serial numbers are required when registering your motorcycle. They may also be required by your dealer when ordering replacement parts. Record the numbers here for your reference.

FRAME NO. _____

ENGINE NO. _____



① Frame serial number



② Engine serial number

DESCRIPTION

- ① Ignition switch
- ② Fuel tank cap
- ③ Fuel tank
- ④ Fuel valve
- ⑤ Choke lever
- ⑥ Gear change pedal
- ⑦ Recoil starter
- ⑧ Neutral indicator

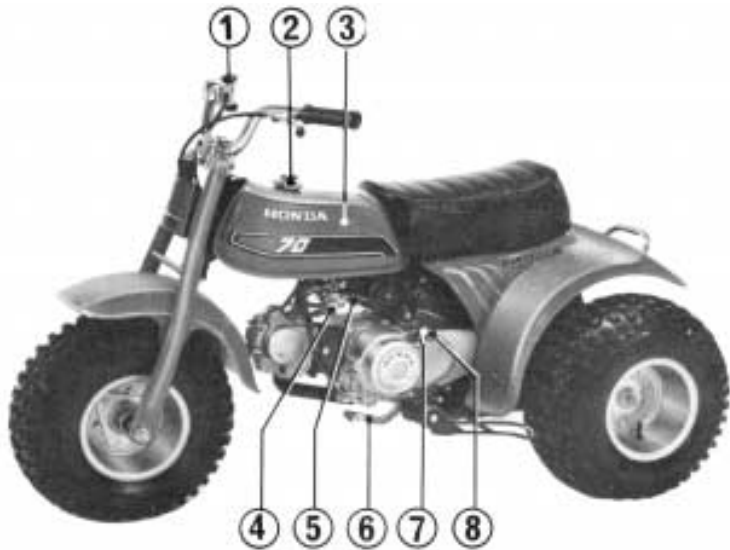



- ① Throttle lever
- ② Handlebar
- ③ Brake lever
- ④ Oil filler cap
- ⑤ Step guard
- ⑥ Foot peg

OPERATING INSTRUCTIONS

IGNITION SWITCH

The ignition switch ① is on the right handlebar. Turn the switch to **ON** when starting the engine and to **OFF** to stop the engine.



① Ignition switch

BRAKE LEVER

The brake lever ① is on the left handlebar and applies the brake to the rear wheels only. The brake lever free play should be 15 ~ 20 mm (5/8 ~ 3/4 in) at the tip of the lever.

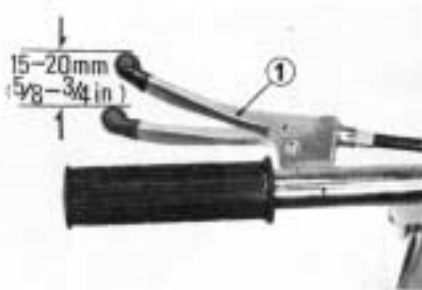

① Brake lever

GEAR CHANGE PEDAL

The gear change pedal ① is near the left foot peg. One full stroke of the gear change pedal will shift the transmission into gear. The pedal automatically returns to the horizontal position when released. The next stroke of the pedal engages the next gear in sequence. The shifting sequence is illustrated in the diagram on the next page.

The pedal is depressed to upshift and is raised to downshift.

With the transmission in neutral, depress the pedal to shift into low gear. 2nd, 3rd and 4th (top) gear are selected in sequence each time the pedal is again depressed.

Each time the pedal is raised, the next lower gear in sequence is engaged until the neutral position is reached.

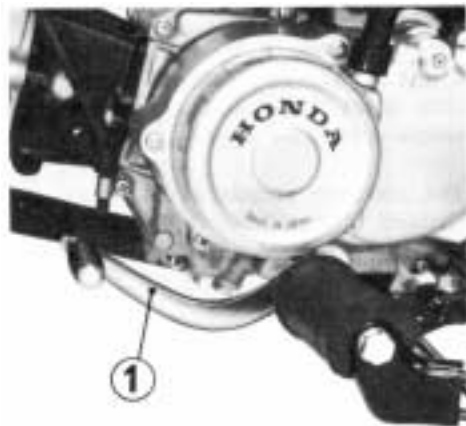

① Gear change pedal

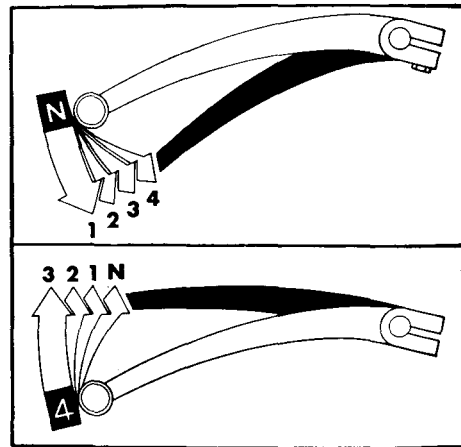

Shifting sequence

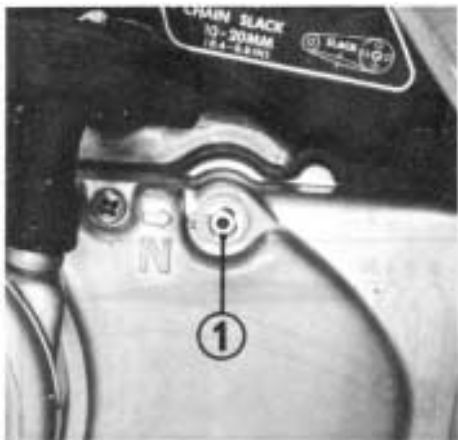

① Neutral indicator

NEUTRAL INDICATOR

The neutral indicator ① is on the left crankcase cover, just behind the recoil starter. This feature enables the rider to see that neutral has been selected before starting the engine.

The indicator rotates as the gears are changed. When the indicator aligns with the N mark on the crankcase, the transmission is in neutral.

CHOKE LEVER

The choke lever ① is on the left side of the carburetor.

Raising the choke lever will close the choke valve. With the choke lever raised, the carburetor will deliver a rich fuel mixture for starting the engine when cold. Lower the choke lever as the engine warms up.



① Choke lever

FUEL VALVE

The fuel valve is on the left side of the carburetor.

OFF position

In this position the fuel flow will be cut off. Whenever the vehicle is not in use, set the valve to this position.

ON position

In this position fuel will flow to the carburetor. When the engine is to be operated, set the valve to this position.

RES position

The fuel valve should be set in this position only after the regular fuel supply has been consumed. The reserve capacity is approximately 0.9 liter (0.2 US gal). When it becomes necessary to switch to RES the rider should refill the fuel tank.

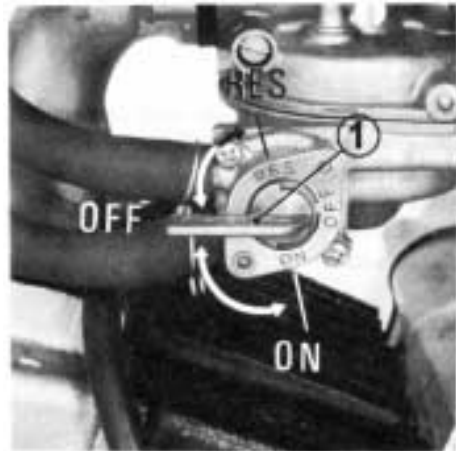

① Fuel valve lever

FUEL TANK

The fuel tank cap is removed by turning it counterclockwise. The fuel tank capacity including reserve is 4.3 liters (1.1 gal). Use of low-lead gasoline with 91 research octane number or higher is recommended. If such gasoline is not available, you may use a leaded regular grade gasoline. When refueling, do not allow dirt, water, or other contaminants to enter the fuel tank.

WARNING

Gasoline is extremely flammable and is explosive under certain conditions. Always stop the engine and do not smoke or allow flames or sparks near the ATC-70 when draining fuel or refueling.

Do not overfill the tank (there should be no fuel in the filler neck). Make sure that the filler cap is closed securely.

Avoid repeated or prolonged contact with skin or breathing of vapor. KEEP OUT OF REACH OF CHILDREN.

FUEL VENT VALVE

The fuel vent valve ② is on the fuel tank cap. Turn the valve ON to allow fuel to flow when running the engine. Turning the valve OFF will prevent fuel from flowing out the vent hole when transporting the motorcycle.

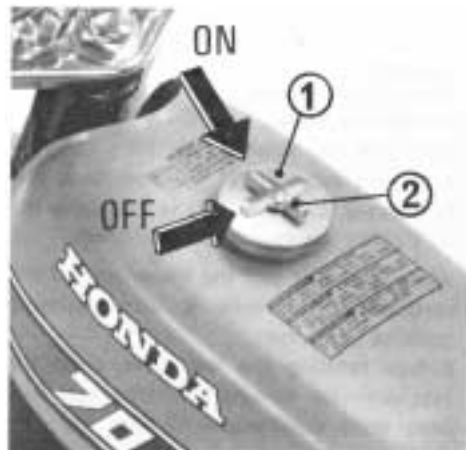

① Fuel tank cap ② Fuel vent valve

FUEL DRAIN

A fuel drain is provided to drain the carburetor and fuel tank for storage or transport. The fuel drain is opened by turning the carburetor drain screw ② counterclockwise.

With the fuel valve ① at RES and the fuel vent valve ON the fuel tank and carburetor will drain. If the fuel valve ① is OFF, only the carburetor will drain.

When draining, put the lower end of the carburetor drain tube ③ into a suitable gasoline container.

Before refilling the fuel tank, close the fuel drain by turning the carburetor fuel drain screw clockwise until tight.

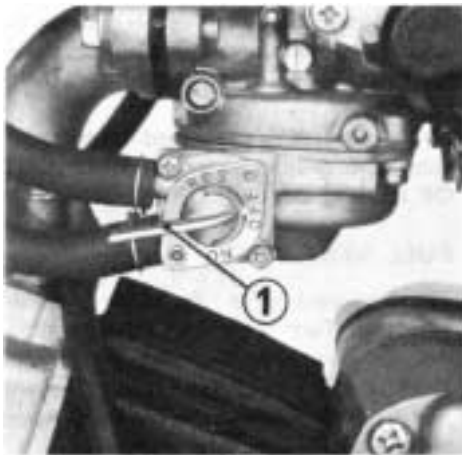

① Fuel valve



② Drain screw ③ Drain tube

OIL RECOMMENDATION

USE HONDA 4-STROKE OIL OR EQUIVALENT.

Use only high detergent, premium quality motor oil certified to meet or exceed U.S. automobile manufacturer's requirements for Service SE or SF.

Motor oils intended for Service SE or SF will show this designation on the container.

The use of special oil additives is unnecessary and will only increase operating expenses.

Oil should be changed at intervals prescribed in the Maintenance Schedule on page 21.

CAUTION:

Engine oil is a major factor affecting the performance and service life of the engine. Non-detergent, vegetable, or castor based racing oils are not recommended.

RECOMMENDED OIL VISCOSITY SAE 10W-40

Other viscosities shown in the chart below may be used when the average temperature in your riding area is within the indicated range.

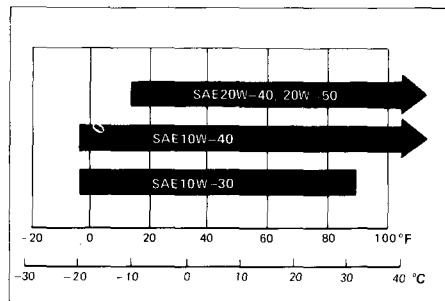

ENGINE OIL LEVEL

To check the oil level, place the ATC on level ground and unscrew the dipstick (1). Wipe it dry and reinsert the dipstick in the oil filler hole; do not screw it in. Withdraw the dipstick and check the oil level. The oil should be between the upper (2) and lower (3) marks on the dipstick.

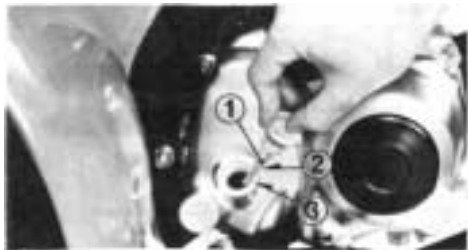

- ① Dipstick
- ② Upper oil level mark
- ③ Lower oil level mark

THROTTLE LEVER

The throttle lever ① is on the right handlebar grip and is operated by the rider's thumb. Pressing the lever forward opens the throttle. When the lever is released, spring tension closes the throttle automatically.



- ① Throttle lever

SPEED LIMITER

The speed limiter is a screw installed in the throttle control case. It limits maximum throttle and top speed to about 25 Km/h. (16 mph). This limiter is especially applicable to beginning riders. It can be removed after the rider is proficient only if the screw hole is plugged with the plug furnished with the ATC70.

WARNING

Failure to plug the hole after removing the speed limiter screw will allow dirt to enter, and may cause the throttle to stick open.

CAUTION:

To prevent rapid clutch wear, do not operate below 20 km/h (13 mph) in 4-th gear.



① Speed limiter

STEP GUARD

The step guards ① are attached to the right and left foot pegs. The step guards help to keep the rider's feet away from the rear wheels.

WARNING

Do not ride the ATC 70 with the step guards removed.

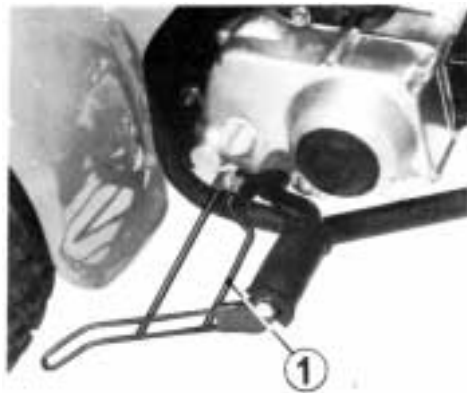

① Step guard

TIRES

The **ATC 70** is equipped with 16 x 8.0 -7, Sp. low pressure, tubeless tires. These tires are designed specifically for off-road use.

CAUTION:

Driving on paved surfaces will cause excessive tire wear.

For normal use, the tires should be inflated to a recommended pressure of 2.2 psi (15kpa, 0.15 kg/cm²). A manually operated tire pump should be used rather than the high pressure systems found in service stations. This will minimize tire damage from overinflation.

Be sure to inflate both rear tires equally. If the **ATC 70** is operated with unequal tire pressures, the resultant difference in tire circumference will cause the **ATC 70** to run toward one side and will affect handling adversely.

Recommended Pressure: 2.2 psi
(15kpa, 0.15 kg/cm²)

Standard Tire Circumference:
1,290 mm (50.7 in)

CAUTION:

Maintain proper tire pressure. Under-inflated tires may adversely affect maneuverability and cause wheel damage, when jumping or riding over bumpy terrain. Overinflated tires may rub on the fenders and hamper movement of the ATC.



PRE-RIDE INSPECTION

WARNING

If the Pre-ride Inspection is not performed, serious damage or an accident may result.

Inspect your **ATC 70** every day before you start the engine. The items listed here will only take a few minutes, and in the long run they can save time, expense, and possibly your life.

1. Engine oil level—add engine oil if required (page 12). Check for leaks.
2. Fuel level—fill fuel tank when necessary (page 9). Check for leaks.
3. Brake lever—check operation. Adjust free play if necessary. (page 26).
4. Tires—check condition and pressure (page 15).

5. Drive chain—check condition and slack (pages 27–28). Adjust and lubricate if necessary.
 6. Throttle—check for smooth opening and closing in all steering positions.
 7. Engine stop switch—check for proper function (page 4).
 8. Nuts, Bolts, Fasteners—check wheels to see that axle nuts are tightened and secured by cotter pins. Check security of all other nuts, bolts and fasteners.
- Correct any discrepancy before you ride. Contact your authorized Honda dealer for assistance if you cannot correct the problem.

STARTING THE ENGINE

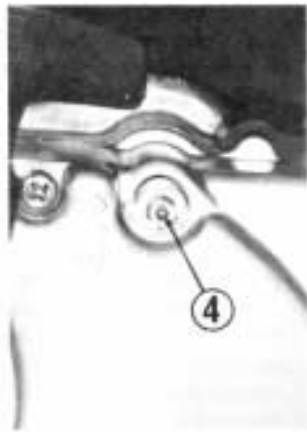

- ① Fuel valve lever
- ② Fuel vent valve

③ Ignition switch

④ Neutral indicator

WARNING

Exhaust contains poisonous carbon monoxide gas. Never run the engine in a closed area.

1. Turn the fuel valve ① ON , and make sure that the fuel vent valve ② is ON .
2. Turn the ignition switch ③ ON .
3. Make sure that the transmission is in neutral by lifting the shift lever and checking that the neutral indicator ④ is at N .

WARNING

Do not try to start the engine with the transmission in gear. You may injure yourself or damage the vehicle.



⑤ Recoil starter

4. Raise the choke lever and open the throttle approximately 1/4 to 1/3. Pull the recoil starter ⑤ slightly until compression is felt. With the engine against compression, pull the starter rope briskly to start.

If the engine does not start after several attempts, it may have become flooded with excess fuel. To clear the engine, turn the ignition switch OFF, open the choke, hold the throttle fully open, and pull the recoil starter rope several times. When the engine is cleared, turn the ignition switch ON and repeat the normal starting procedure, but do not use the choke.

CAUTION:

Use of the choke after the engine warm-up may impair piston and cylinder lubrication.

NOTE:

- * Do not race the engine during the warm up period. Revving a cold engine wastes fuel and increases engine wear.
- * In cold weather, leave the choke valve closed several minutes after the engine starts and then gradually open the choke as the engine warms up.

BREAK-IN PROCEDURE

During the first few days of riding, operate your new **ATC 70** so that the engine neither pulls laboriously nor approaches maximum rpm in any gear. Avoid full throttle operation, and select your gear changes to spare the engine undue stress. Careful break-in procedure during initial operation will measurably extend the service life of the engine.

WARNING

The exhaust pipe and muffler become very hot during operation and remain too hot to touch after shutting off the engine. Wear clothing which will completely cover your legs while riding, and avoid any

contact with unshielded portions of the exhaust system.

RIDING

1. After the engine has been warmed up, the machine is ready for riding.
2. While the engine is idling, depress the gear change pedal to shift into low (1st) gear. The shifting pattern is illustrated on page 5.
3. Increase engine speed by opening the throttle.
4. To shift into second gear, release the throttle lever and depress the gear change pedal again.
5. This sequence is repeated to progressively shift to 3rd and 4th (top) gear.

The shifting pattern is illustrated on page 5.

PARKING

When parking the vehicle, turn the ignition switch and the fuel valve to OFF.

Do not park the vehicle on a slope.

STORAGE

Preparing the ATC for storage:

1. Completely clean all parts of the ATC. If the ATC has been exposed to sea breeze or salt water, wash it down with fresh water and wipe dry.
2. Drain the gasoline from the fuel tank and the carburetor.
3. Change the engine oil.
4. Position the piston at the top of the compression stroke. This can be determined by pulling the starter rope until compression is felt.
5. Cover the ATC with a dust cover.
6. Store in an area which is free of humidity and dust.
7. Inflate the tires to the normal pressure and place the ATC on suitable blocks to raise the tires off the ground.



MAINTENANCE

MAINTENANCE SCHEDULE

The maintenance intervals shown in the following schedule are based upon average riding conditions. Machines subjected to severe use, or ridden in unusually dusty areas, require more frequent servicing. Items marked * should be serviced by an authorized Honda dealer, unless the owner has the proper tools and is mechanically proficient. Other maintenance items are simple to perform and may be serviced by the owner.

Perform the Pre-ride Inspection (Page 16) at each scheduled maintenance period.

I: Inspect and Clean, Adjust, Lubricate or Replace, if necessary C: Clean R: Replace A: Adjust			INITIAL SERVICE PERIOD (First week of operation)	REGULAR SERVICE PERIOD (Every 30 operating days)	Refer to page
	ENGINE OIL	NOTE (1), (2)	R	R	24
*	CONTACT POINTS AND IGNITION TIMMING		I	I	31
	AIR CLEANER ELEMENT	NOTE (2)		C	33
	SPARK PLUG			I	32
*	VALVE CLEARANCE COLD		I	I	29
*	CAM CHAIN TENSIONER		A	A	37
*	CARBURETOR HOT		I	I	35

NOTE: (1) Replace every 30 operating days or every 3 months, whichever comes first

(2) Service more frequently when riding in dusty areas.

I: Inspect and Clean, Adjust, Lubricate or Replace, if necessary C: Clean R: Replace A: Adjust	INITIAL SERVICE PERIOD (First week of operation)	REGULAR SERVICE PERIOD (Every 30 operating days)	Refer to page
	I: (EVERY YEAR)		8-10
*	C: (EVERY YEAR)		36
	I	I	34
	I	I	27
*	I: (EVERY YEAR)		-
	I	I	26
*	A	A	38
*		C	39
	I	I	-
	I	I	15
*	A: (EVERY YEAR)		-

CAUTION:

To maintain the safety and reliability of your HONDA ATC do not modify the ATC and use only new genuine HONDA parts or their equivalent when servicing or repairing.

The use of other replacement parts which are not of equivalent quality may impair the operation of your ATC.

TOOL KIT

A spark plug wrench and handle are attached under the rear of the seat. Any extensive work requiring additional tools should be performed by an authorized Honda dealer.

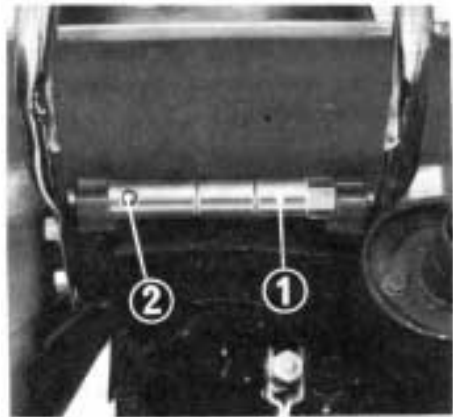

- ① Spark plug wrench
- ② Wrench handle

MAINTENANCE OPERATIONS

ENGINE OIL LEVEL

WARNING

Always turn the engine off before performing any maintenance operations unless otherwise stated.

Check engine oil level at the start of each day the **ATC 70** is to be ridden. The oil filler cap contains a dipstick ① for measuring oil level.

Oil level should be checked with the **ATC 70** on level ground and with the oil filler cap touching the filler hole but not screwed in.

Oil level should be maintained between the upper ② and lower ③ oil level marks on the dipstick.



- ① Dipstick
- ② Upper level mark
- ③ Lower level mark

ENGINE OIL CHANGE

Engine oil should be changed in accordance with the maintenance schedule on page 21 and 22. Use motor oils of the grade and viscosity recommended on page 11.

When changing oil, drain the used oil from the crankcase while the engine is still warm. This will ensure complete and rapid draining.

1. Remove the oil filler cap from the right crankcase cover.

2. Place a drain pan under the engine to catch the oil, and then remove the drain plug ① with a box wrench.
3. After the oil stops draining from the crankcase operate the recoil starter several times to drain any oil which may be left in the engine. (Make sure the engine stop switch is OFF .)
4. When the oil has been completely drained, reinstall the drain plug. Be sure the washer which seals the drain plug is in good condition.

5. Fill the crankcase through the oil filler opening with approximately 0.8 liter (0.8 US qt) of the recommended grade of motor oil.

Make sure that the oil level is between the upper and lower marks. If the level is low, add oil.

NOTE:

Machines ridden in unusually dusty areas require oil changes at more frequent intervals than specified in the MAINTENANCE SCHEDULE.

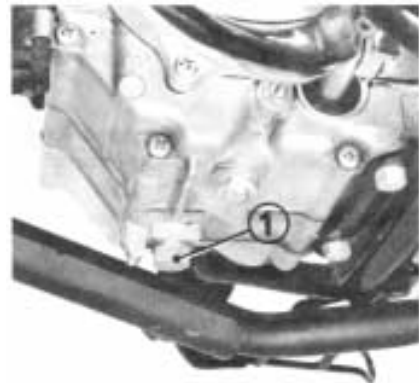

① Drain plug

BRAKE ADJUSTMENT

Free play, measured at the tip of the brake lever ①, should be 15 ~ 20 mm (5/8 ~ 3/4 in).

The adjusting nut ② is located on the brake operating rod at the rear of the frame.

Check the brake cable for kinks or signs of wear that could cause sticking or failure. Lubricate the brake cable with a commercially available cable lubricant to prevent premature wear and corrosion. Make sure the brake arm, spring and fasteners are in good condition.

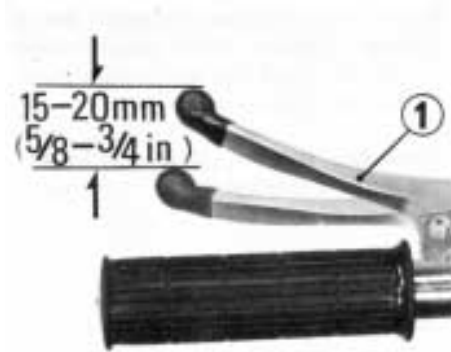

① Brake lever

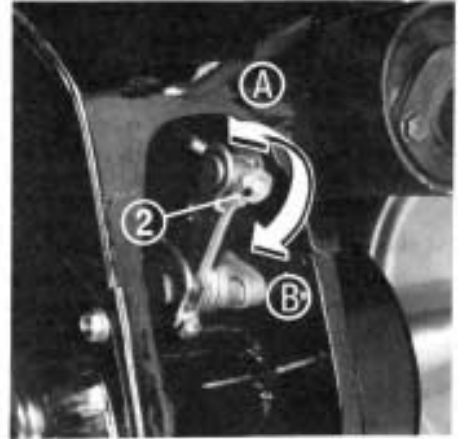

② Adjusting nut
Ⓐ Increase free play
Ⓑ Decrease free play

DRIVE CHAIN ADJUSTMENT

The drive chain ① will wear with use and requires periodic adjustment. Adjustment is normally performed in accordance with the MAINTENANCE SCHEDULE.

Shut the engine off. Remove the inspection hole cap. Chain slack should be checked by measuring the amount of chain slack through the inspection hole. The amount of slack should be 10 mm ~ 20 mm (3/8 ~ 3/4 in).

To adjust slack, raise the right side of the vehicle and place a block under the right wheel. Loosen the lock nuts ② and move the chain tensioner plate ③ to obtain correct chain slack. Tighten the lock nuts. Install the hole cap.



① Drive chain



② Lock nut

③ Chain tensioner plate

DRIVE CHAIN LUBRICATION

The drive chain can be lubricated through the inspection hole (page 27). This hole is covered with a cap which keeps dirt out of the chain case. Be sure to reinstall the cap after lubrication.

Commercially prepared drive chain lubricants should be used in preference to motor oil for lubricating the drive chain.

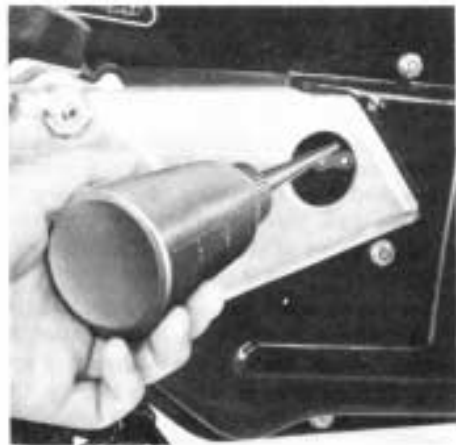

① Inspection hole cap

VALVE CLEARANCE ADJUSTMENT

Valve clearance should be maintained at 0.05 mm (0.002 in). Excessive clearance will cause noise. Insufficient clearance will cause loss of power and could cause valve damage.

NOTE:

Check or adjust valve clearance while the engine is cold. The clearance may increase as the temperature rises.

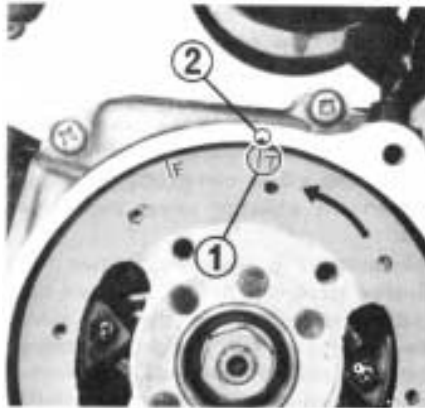

- ① "T" mark
- ② Index mark

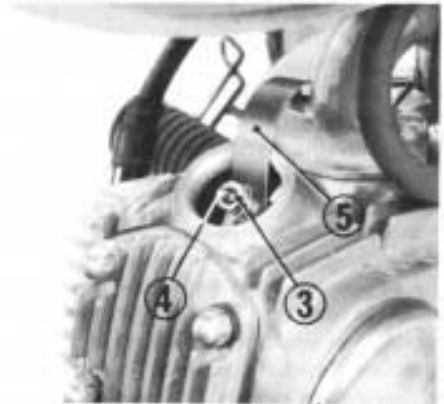

- ③ Adjusting screw lock nut
- ④ Adjusting screw
- ⑤ Feeler gauge

1. Shut the engine off.
2. Remove the recoil starter and tappet adjusting hole caps.
3. Rotate the dynamo rotor counter-clockwise until the "T" mark ① (page 29) on the dynamo rotor lines up with the timing index mark ② on the stator.

In this position, the piston may either be on the compression or the exhaust stroke. The adjustment must be made when the piston is on top of the compression stroke when both the intake and exhaust valves are closed. This can be determined by moving the tappets by hand. If the tappets are free, it is an indication

that the valves are closed and that the piston is on the compression stroke. If the tappets are tight and the valves are open, rotate the dynamo rotor 360° and realign the "T" mark to the timing index mark. Check the clearance of both valves by inserting a 0.05 mm (0.002 in) gauge between the adjusting screw and valve stem.

If adjustment is necessary, loosen the adjusting screw lock nut ③ and turn the adjusting screw ④ so that the valve clearance will offer a slight resistance when the gauge is inserted. After completing the adjustment, tighten the adjusting screw lock nut while holding the

adjusting screw to prevent it from turning. Recheck the clearance to make sure that the adjustment has not been disturbed.

CONTACT BREAKER POINT GAP AND IGNITION TIMING ADJUSTMENT

Ignition timing is adjusted by altering the contact breaker point gap ①.

1. Remove the recoil starter on the left side of the engine.
2. Rotate the flywheel counterclockwise and align the "F" mark ③ with the index mark ④. Ignition timing is correct if the contact breaker points just begin to open at this moment.
3. If ignition timing is incorrect, loosen the contact breaker locking screws ② and adjust the breaker point gap. Increasing the gap will advance ignition timing. Decreasing the gap will retard ignition timing.
4. Retighten the contact breaker locking screws and recheck ignition timing.

NOTE:

Point gap must remain within limits of 0.3–0.4 mm (0.012–0.016 in) after ignition timing has been set. If correct timing results in a point gap which is outside these limits, replace the contact breaker points.

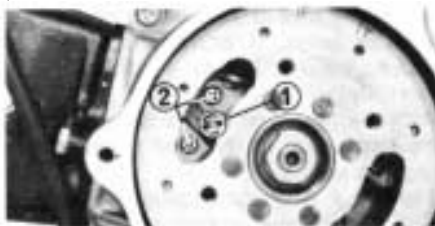

- ① Contact breaker points.
② Contact breaker point locking screws

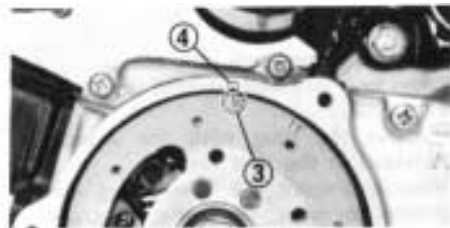

- ③ "F" mark ④ Index mark

SPARK PLUG REPLACEMENT AND ADJUSTMENT

Standard Spark plugs

NGK CR7HS or ND U22FSR-L

CAUTION:

* *The use of spark of incorrect size or heat range can cause serious engine damage.*

1. Disconnect the spark plug cap.
2. Clean any dirt from around the spark plug base.
3. Remove the plug with the wrench provided in the tool kit.
4. Visually inspect the spark plug electrodes for wear. The center electrode should have square edges and the side electrode should not be eroded. If

the electrodes and insulator tip appear unusually fouled or burned, we suggest that you contact an authorized Honda dealer. Discard the spark plug if there is apparent wear or if the insulator is cracked or chipped.

5. Make sure that the spark plug gap is 0.6–0.7 mm (0.024–0.028 in) using a feeler gauge. If adjustment is necessary, bend the side electrode (1) carefully.
6. With the plug washer attached, thread the spark plug in by hand to prevent cross-threading.
7. Tighten a new spark plug 1/2 turn with a spark plug wrench to compress the washer. If you are reusing a plug, it should only take 1/8–1/4 turn after the plug seats.

CAUTION:

* *The spark plug must be securely tightened. An improperly tightened plug can become very hot and possibly damage the engine.*



① Bend side electrode to adjust gap

AIR CLEANER MAINTENANCE

The air filter element accumulates dust and must be cleaned periodically. If the ATC 70 is ridden in unusually dusty areas, the filter element must be cleaned at more frequent intervals than specified in the MAINTENANCE SCHEDULE.

1. Remove the bolt ① and air cleaner cover ②.
2. Remove the filter element from the air cleaner case.
3. Remove air filter element tube ⑤ and support ④ from filter element ③
4. Wash the filter element in non-flammable or high flash point solvent and allow to dry thoroughly.
5. Soak the filter element in clean gear oil (SAE 80 ~ 90), then squeeze out the excess.

6. Reassemble filter by reversing the disassembly sequence.

WARNING

Never use gasoline or low flash point solvents for cleaning the air cleaner element. A fire or explosion could result.



① Bolt ② Air cleaner cover

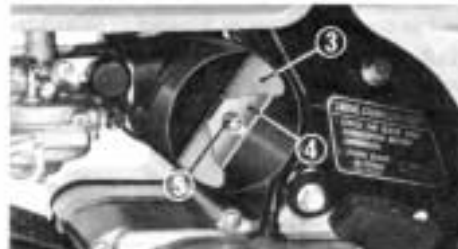

③ Filter element ⑤ Filter element tube
④ Support

THROTTLE CABLE INSPECTION AND ADJUSTMENT

Inspect the condition and operation of the throttle cable. The throttle cable must not bind or impair smooth operation of the throttle lever in any steering position. Reroute the cable if it is improperly installed. Replace the cable if it has become worn or kinked.

Lubricate the throttle cable with a commercially available cable lubricant to prevent premature wear and corrosion.

Free play, measured at the tip of the throttle lever, should be maintained at 5 ~ 10 mm (3/16 ~ 3/8 inch).

The adjusting nut is located at the top of the carburetor, against the end of the throttle cable housing. Slide the rubber sleeve ① back to expose the throttle cable adjuster ②. Reinstall the sleeve after adjustment.

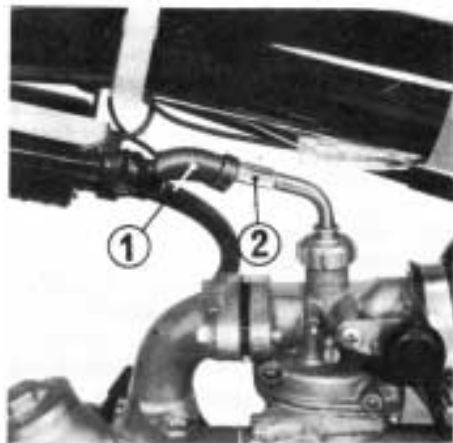

① Rubber sleeve ② Throttle cable adjuster

CARBURETOR ADJUSTMENT

NOTE:

Before making adjustments to the carburetor, be sure the ignition system is functioning properly and the engine has good compression. Do not attempt to compensate for other faults by carburetor adjustment.

Perform the carburetor adjustment periodically.

1. Start the engine and warm it up to operating temperature.
2. Set the idle speed to 1,500rpm with the throttle stop screw ①.

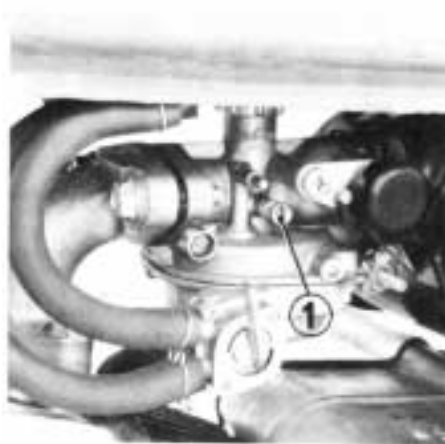

① Throttle stop screw

FUEL STRAINER MAINTENANCE

The fuel strainer is on the left side of the carburetor body. The fine mesh screen of the strainer prevents dirt from entering the carburetor passages.

Dirt which accumulates at the filter must be removed periodically, or the fuel flow will eventually be restricted.

WARNING

- Gasoline is extremely flammable and explosive under certain conditions.
- Gasoline is harmful or fatal if swallowed. Avoid repeated or prolonged contact with skin or breathing of vapor. Keep out of reach of children. If gasoline is swallowed, do not induce vomiting. Call a physician immediately.

1. Turn the carburetor fuel valve OFF .
2. Remove the two screws which retain the fuel valve, and remove the fuel valve.
3. Remove the neoprene O-ring ② and the filter screen ① .
4. Wash the filter screen in non-flammable or high flash point solvent.
5. Reassemble by reversing the disassembly sequence.
6. Turn the carburetor fuel valve ON and check for leaks at the fuel strainer cover. Correct if necessary.

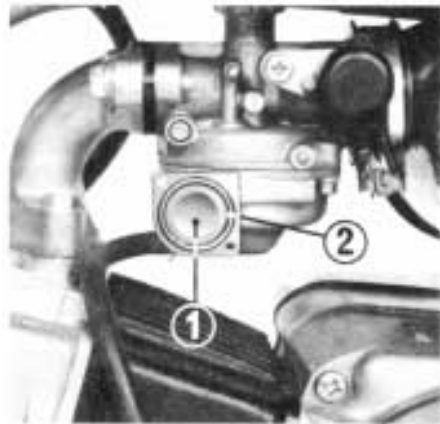

① Filter screen ② O-ring seal

CAM CHAIN ADJUSTMENT

An improperly adjusted cam chain will adversely affect the engine. Adjust tension while the engine is idling.

1. To adjust, loosen the lock nut ① and tensioner adjusting bolt ② approximately one half turn.
2. If the chain is still noisy even after adjustment, loosen the 14 mm sealing bolt located on the left bottom side of the crankcase, and screw in the tensioner bolt ③ gradually until the cam chain becomes quiet. After completing the adjustment, tighten the tensioner adjust bolt, lock nut, and 14 mm sealing bolt securely.

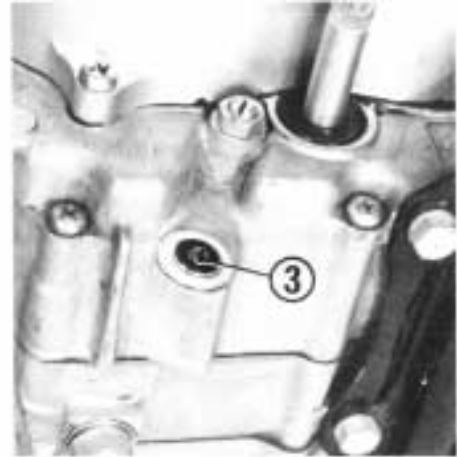

① Lock nut ② Tensioner adjusting bolt ③ Tensioner bolt

CLUTCH ADJUSTMENT

1. Make sure the ignition switch is off.
2. Loosen the lock nut ② , and turn the clutch adjuster ① counterclockwise until you feel resistance. Then turn 1/8 to 1/4 turn clockwise, and tighten the lock nut to hold the adjuster in this position.
3. After adjustment, start the engine and test ride the **ATC 70** to be certain that the clutch is operating properly.

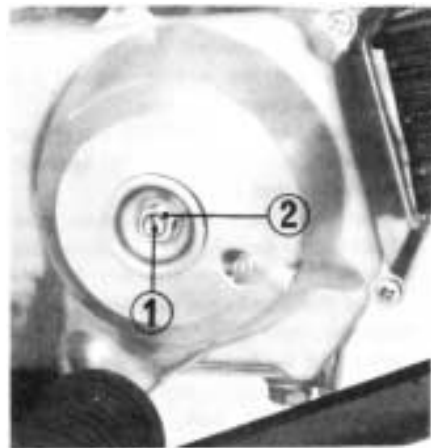

① Clutch adjuster ② Lock nut

SPARK ARRESTER MAINTENANCE

The exhaust system spark arrester must be periodically purged of accumulated carbon.

1. Shift the transmission into Neutral .
2. Remove the spark arrester bolt ① and slide the spark arrester ② out.
3. Clean the arrester of accumulated carbon.
4. Start the engine, and purge accumulated carbon from the system by momentarily revving up the engine several times.
5. Stop the engine and allow the exhaust pipe to cool.
6. Reinstall the spark arrester with the bolt.

WARNING

The exhaust system becomes **VERY HOT** even after short periods of engine operation.

To avoid fire hazards, **DO NOT** perform this maintenance in the vicinity of flammable materials.

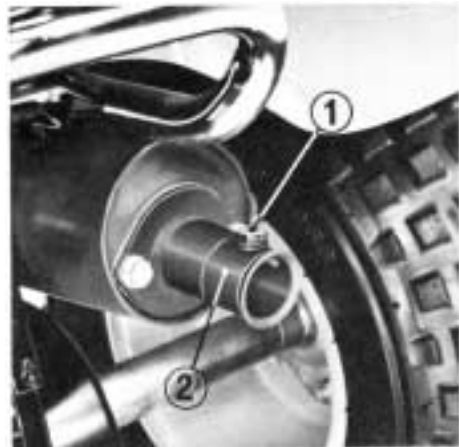

① Spark arrester bolt ② Spark arrester

**RIDING
THE
HONDA ATC**

SAFETY PRECAUTIONS

For your initial riding practice, select a safe area, free of obstacles with an even surface of dirt, sand, snow, etc. Avoid paved surfaces, as they make learning to maneuver more difficult and will also significantly shorten the tire life.

The clothing most suitable for comfort and protection varies with factors of climate and hazards of the terrain to be traveled. This matter is therefore left to the discretion of the individual rider. In all circumstances, however, we recommend wearing a safety helmet and boots which rise at least above the ankles.



Never put your feet on the ground when the ATC is moving.



IF YOUR FEET ARE REMOVED FROM THE FOOT PEGS TO TOUCH THE GROUND WHILE THE ATC IS IN MOTION, THEY MAY COME IN CONTACT WITH THE REAR WHEELS.



Always keep your feet on the foot pegs.

Shift the transmission into neutral before starting the engine. Allow sufficient warm up time before proceeding. Ride with your feet on the foot pegs at all times. Under normal riding conditions, it is neither necessary nor desirable to touch the ground for balance.

TURNING MANEUVERS

For better traction in off-road use, the ATC has been fitted with a rear axle which drives both rear wheels equally at all times.

When negotiating a turn, the wheel on the outside of the turn must travel a wider radius, and thus a greater distance,

than the inside wheel. As the rear axle does not permit a differing rate of wheel rotation, it is not enough to merely steer the ATC into a turn. The new rider must learn to shift his weight and control the throttle to allow the rear tires to negotiate the turn. This is the primary technique to be mastered in riding the Honda ATC.

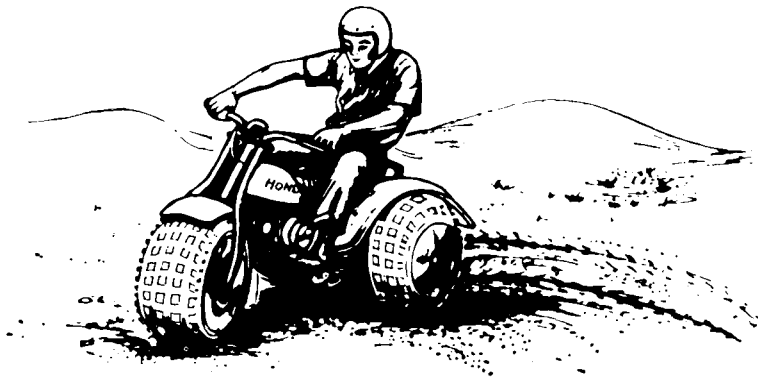

For your initial riding practice, operate the ATC in low gear. Avoid higher speeds until you are confident of your abilities.

Practice turning the ATC at slow, constant speeds. **Steer in the direction of the turn, and lean your body to the inside of the turn, while supporting your weight on the outer foot peg. Use the throttle to maintain power throughout the turn.**

This technique allows the ATC to lean slightly toward the outside, altering the balance of traction between the rear wheels sufficiently to allow them to negotiate the turn.

Once this technique is learned, turning maneuvers can be performed within a relatively small area.

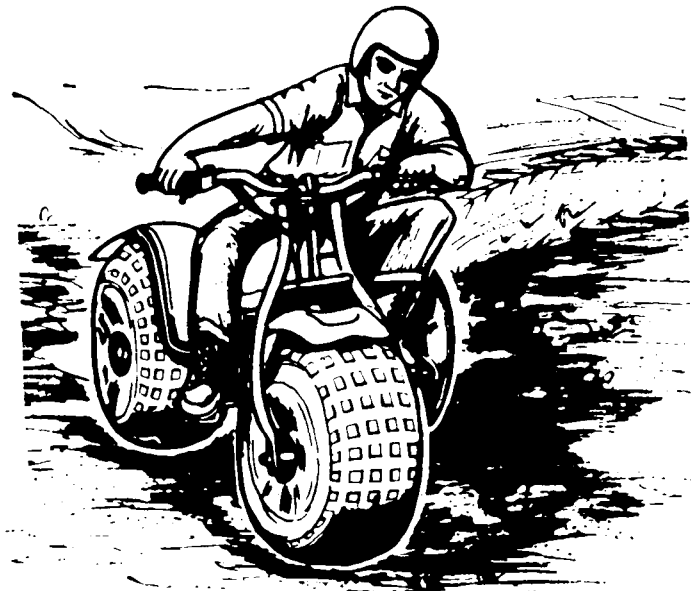

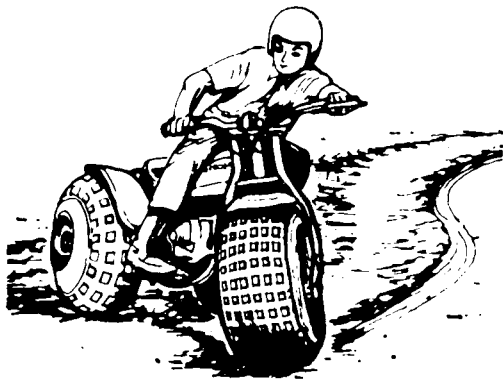

Incorrect turning techniques may cause the front wheel to slide straight ahead when steered without affecting the ATC's direction of travel. If this should occur, close the throttle, come to a stop, then continue practising, adhering to the technique outlined on the preceding page.

If the front wheel tends to skid in mud or snow, you may be able to improve control under these conditions by leaning forward, transferring additional weight to the front wheel.

If the rear wheels inadvertently skid sideways, correct your slide by steering in the direction of the skid if you have room to perform this maneuver safely. Avoid braking or accelerating until you have directional control of the ATC.

To avoid skidding while traveling on slippery terrain, the rider must exercise a high degree of caution.

Controlled skids and spins, when performed safely, add to the sport the rider can enjoy. However, as skidding maneuvers are inherently more hazardous than those performed under full traction, we must caution the rider to first master the basic techniques of handling the ATC before practicing any skidding maneuver.

Surface composition is, of course, a major factor affecting skidding capability. It is obviously easier to slide on packed snow than in deep sand. Surfaces with extremely low or extremely high coefficients of friction must not be used for skidding maneuvers, however. It is dangerous to skid on ice, because you may lose all directional control, and it is dangerous to skid on pavement, because you may regain traction suddenly and unexpectedly, which can cause you to lose your balance and overturn.



CLIMBING HILLS

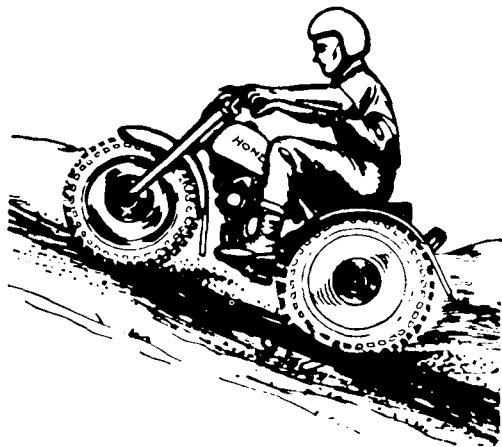

Practice climbing on evenly surfaced slopes of less than 20°. The ATC's capability in climbing hills or traversing any specific terrain is dependent upon rider skill. As you gain experience in handling the ATC, and learn the hazards to be encountered and your own limitations, you may then proceed to ride more challenging terrain. However, you must first be able to discern and avoid any hill or hazard that would cause the ATC to overturn.

WARNING IF THE FRONT WHEEL IS ALLOWED TO RISE FROM THE GROUND, THIS WILL LESSEN YOUR CONTROL OF THE ATC AND MAY CAUSE IT TO OVERTURN BACKWARD. THE SUDDEN APPLICATION OF POWER BY OPENING THE THROTTLE OR GEAR CHANGING WILL TEND TO RAISE THE FRONT WHEEL, ESPECIALLY WHILE ASCENDING A HILL.

The riding technique for hill climbing involves transferring your weight toward the front wheel to keep it in contact with the ground. This may be done by leaning forward from the normal riding position, or for greater weight transference, by standing on the foot pegs and leaning forward.

Take a running start, approaching the base of the hill in the appropriate gear and speed for the ascent, and climb at a steady rate of speed.

If you should find that you have incorrectly estimated climbing capability and lack the power or traction to continue the ascent, then if space permits, turn the ATC around while you still have the forward speed to do so and descend. Avoid stalling part way up a hill, as maneuvering will then become more difficult.

WARNING BEFORE ATTEMPTING ANY TURNING MANEUVER ON A HILLSIDE, THE RIDER SHOULD FIRST LEARN TURNING TECHNIQUE BY PRACTICING ON LEVEL GROUND.

If you do lose all forward speed, and can neither continue uphill nor maneuver the ATC under its own power, it will be necessary to dismount and physically turn the ATC around in order to descend.

WARNING TO AVOID OVERTURNING, THE RIDER MUST EXERCISE A HIGH DEGREE OF CAUTION WHEN DISMOUNTING OR MOVING THE ATC ON A HILLSIDE.

If it becomes necessary to roll the ATC backward first shift the transmission into neutral. Wherever circumstances permit, however, we strongly recommend that the rider turn the ATC around rather than backing downhill.

WARNING APPLYING THE BRAKES OR ENGAGING THE TRANSMISSION, WHILE ROLLING BACKWARDS DOWNHILL, CAN EASILY CAUSE THE ATC TO OVERTURN AND FALL ON THE RIDER.



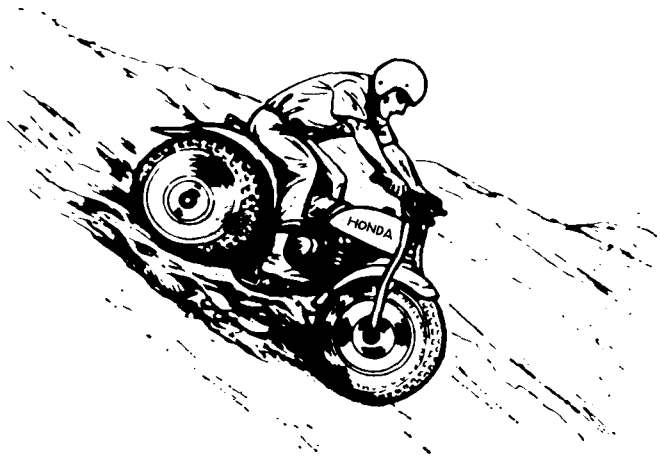

DESCENDING HILLS

It is usually advisable to descend hills with the ATC pointed directly downhill, avoiding angles that would cause the ATC to lean sharply to one side. As you approach the point of descent, stop and survey the terrain below. Never ride headlong past your limit of visibility. When you have picked a safe path of descent, shift the transmission into low gear and descend slowly with the throttle closed. Sit back on the seat, with arms extended and braced upon the handlebars.

When descending sand dunes, we recommend that the rider apply the brakes intermittently to further reduce forward speed.

Braking effectiveness is, of course, reduced while descending any incline with a loose surface.

TRAVERSING SLOPES

When riding across a slope, at right angles to the incline of the hill, lean your body in the uphill direction to maintain balance and stability. On a loose surface such as sand, it may become necessary to steer slightly uphill in order to maintain your course of travel.

WARNING BALANCE IS MORE PRECARIOUS WHILE THE ATC IS TILTED TO ONE SIDE. AVOID TRAVERSING SLOPES WHERE THERE IS SLIPPERY OR DIFFICULT TERRAIN.

WARNING AVOID "WHEELIES" AND JUMPING AS THEY CAUSE LOSS OF CONTROL.





RIDING THROUGH WATER

The Honda ATC can ford water to a depth of approximately 7 inches, although the rider must be careful to avoid getting the spark plug or air cleaner wet.

When crossing streams, choose a course where both banks have gradual inclines. Proceed at a slow, steady speed, and take care to avoid submerged obstacles and slippery rocks.

WARNING DO NOT FORD ANY STREAM WITH FAST FLOWING WATER. THE TIRES HAVE A TENDENCY TO FLOAT, MAKING IT DIFFICULT TO MAINTAIN CONTROL.

After riding through water, the brakes may be less effective than normal. Test the brakes after traveling through any water, and if necessary, apply the brakes repeatedly until the heat of friction has dried them, and the brakes regain their normal effectiveness.

TIRE CARE

The Honda ATC is equipped with 16 x 8.0-7, low pressure, tubeless tires. For normal use, they should be inflated to a recommended pressure of 2.2 psi (15 kpa, 0.15 kg/cm²). A manually operated tire pump should be used rather than the high pressure systems found in service stations. This will minimize tire damage by overinflation.

If no air pressure gauge is available to accurately measure 2.2 psi (15 kpa, 0.15 kg/cm²), this value can be obtained by measuring the circumference of the tires with a measuring tape. The tires will increase in circumference as air pressure is added. When inflated to 2.2 psi (15 kpa, 0.15 kg/cm²), the maximum tire circumference, measured over the tread ribs, will be approximately 1,290 mm (50.7 inches). The relationship between tire pressure and actual circumference varies slightly with factors of wear and stretching that occur through use.

Be sure to inflate both rear tires equally. If the ATC is operated

with unequal tire pressures, the resultant difference in tire circumference will cause the ATC to tend to run toward one side and will adversely affect handling.

If you have a flat tire, use the plug method to perform temporary repairs. The plug method is the same as that for conventional tubeless tires. A plug type repair kit, which is available at most auto part stores or service stations, provides a plug, an installation tool, tire cement, and an instruction sheet. Follow the instructions provided in the repair kit to perform a temporary repair until the tire can be permanently repaired by the cold patch method. Any tire which cannot be repaired by the plug method should be replaced.

Whenever the ATC is to be operated far from service facilities or available transportation, we recommend that the rider carry a tire pump and a suitable repair kit with him.

TRANSPORTING THE ATC

FUEL

1. When transporting your ATC, turn the fuel valve and fuel vent valve OFF to prevent fuel leakage.

WARNING GASOLINE IS FLAMMABLE, AND EXPLOSIVE UNDER CERTAIN CONDITIONS. ALWAYS STOP THE ENGINE, AND DO NOT SMOKE OR ALLOW FLAMES OR SPARKS NEAR THE ATC WHEN DRAINING OR REFUELING.

2. Place the drain tube in a suitable gasoline container.
3. With both valves OFF turn the carburetor drain screw counterclockwise.
4. When all the fuel has drained, retighten the screw.

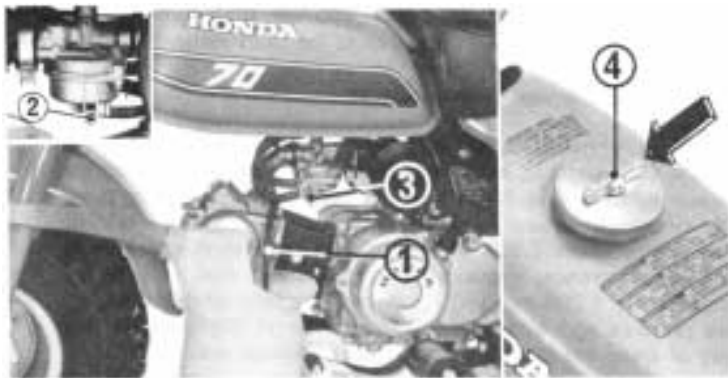

- ① Drain tube
- ② Drain screw
- ③ Fuel valve
- ④ Fuel vent valve

TRANSPORTING THE ATC (Continued)

Rear Wheel Removal

1. Place a support block under the vehicle and raise the rear wheel off the ground.
2. Loosen the wheel nuts (1) with the 12 mm socket wrench.
3. Remove the wheel.

Installation Note:

Reinstall the rear wheels by reversing the disassembly sequence.



① Wheel nuts

TRANSPORTING THE ATC (Continued)

REMOVING THE FRONT WHEEL

If limited carrying space requires removal of the front wheel, use the following procedure:

1. Remove the cotter pin ① securing the front axle nut.
2. Remove the axle nut ②
3. Pull out the axle and then remove the front wheel.

NOTE:

Cover the wheel hub as soon as the axle has been removed to prevent entry of dirt.



① Cotter pin

② Axle nut

INSTALLING THE FRONT WHEEL

Reinstall the front wheel by reversing the disassembly sequence.

NOTE:

When the front axle is reinstalled, be careful that the grease seal is not cut or damaged.

Always replace used cotter pins with new ones. To reduce the hazard of snagging the ends of the cotter pins, while the ATC is operated, we recommend that the projecting ends of the front axle cotter pins be cut close to the axle nut, as illustrated.

WARNING BE CERTAIN THAT ALL AXLE NUTS ARE TIGHTENED AND SECURED BY COTTER PINS. IF THEY ARE NOT, THE WHEELS MAY BECOME LOOSE DURING OPERATION.

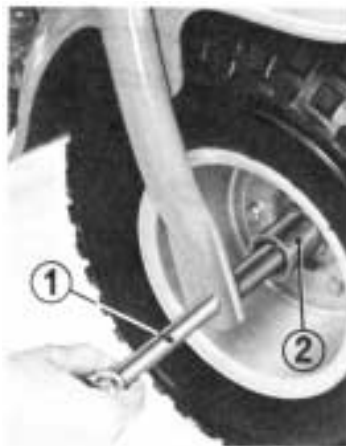

① Front Axle ② Wheel Hub



③ Axle Nut ④ Cotter Pin

OPTIONAL PARTS

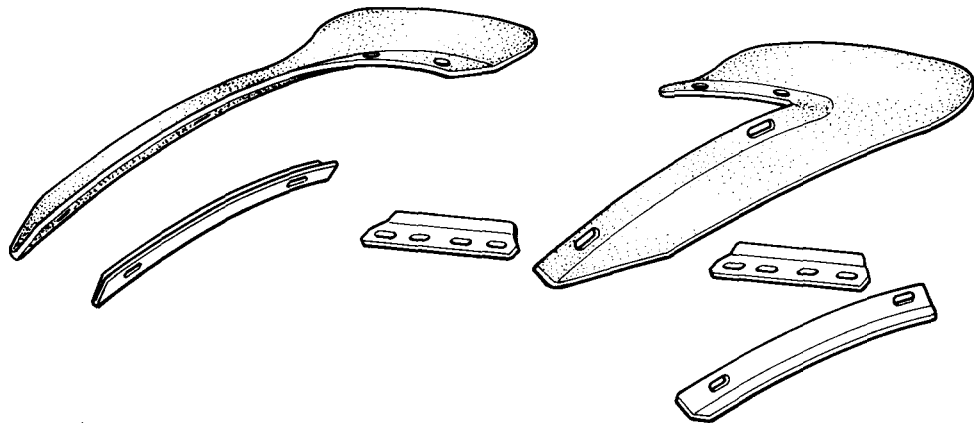

Rear mud guard

SPECIFICATIONS

DIMENSIONS

Overall length	1,300 mm (51.2 in)
Overall width	800 mm (31.5 in)
Overall height	800 mm (31.5 in)
Wheel base	895 mm (35.2 in)

WEIGHT

Dry weight	77 kg (169.8 lbs)
----------------------	-------------------

CAPACITIES

Engine oil	0.8 ℓ (0.8 U.S. qt)
Fuel tank	4.3 ℓ (1.1 U.S. gal)
Reserve fuel	0.9 ℓ (0.2 U.S. gal)

ENGINE

Bore and stroke	47.0 x 41.4 mm (1.850 x 1.630 in)
---------------------------	--------------------------------------

Compression ratio	7.5 : 1
Displacement	72 cc (4.4 cu. in)
Contact breaker point gap .	0.3 ~ 0.4 mm (0.012 ~ 0.016 in)
Spark plug gap	0.6 ~ 0.7 mm (0.024 ~ 0.028 in)
Valve tappet clearance . .	0.05 mm (0.002 in)

CHASSIS AND SUSPENSION

Caster angle	20°
Trail length	32 mm (1.26 in)
Tire size, front and rear . .	16 x 8.0 - 7

POWER TRANSMISSION

Primary reduction	4.058
Final reduction	2.769
Gear ratio, 1st	3.273
2nd	1.938
3rd	1.350
4th	1.043

WIRING DIAGRAM

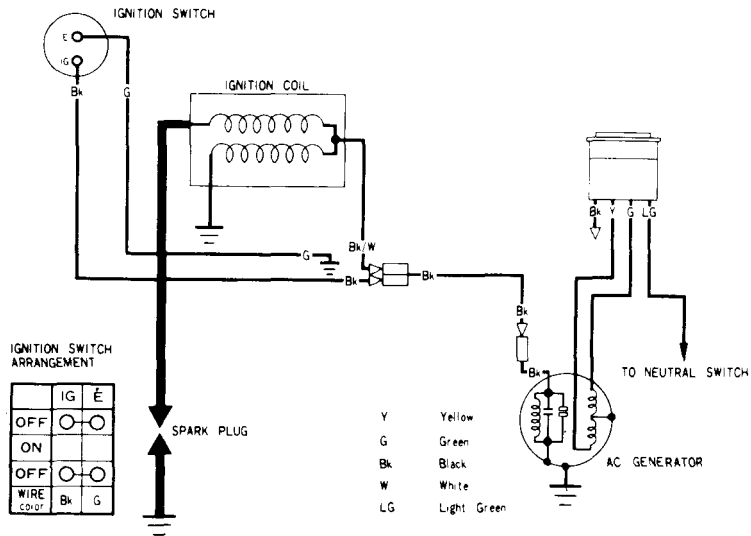

OWNER SATISFACTION

Your satisfaction and goodwill are important to your dealer and to us. Normally, any problems with the operation of your vehicle will be handled by your dealer's Service Department. Sometimes, however, despite the best intentions of all concerned, misunderstandings can occur. If your problem has not been handled to your satisfaction, we suggest you take the following action:

- * Discuss your problem with a member of dealership management. Often complaints can be quickly resolved at that level. If the problem has already been reviewed with the Service Manager, contact the owner of the dealership or the General Manager.
- * If your problem still has not been resolved to your satisfaction, contact the Motorcycle Customer Service Department, AMERICAN HONDA MOTOR CO., INC. 100 West Alondra Boulevard, Gardena, California 90247 (213) 327-8280, and provide them with:
 - Your name, address and telephone number
 - Vehicle frame number
 - Dealer's name and location
 - Vehicle delivery date
 - Nature of problem

After reviewing all the facts involved, you will be advised of what action can be taken.

Please bear in mind that your problem will likely be resolved in the dealership, using the dealer's facilities, equipment and personnel. So it is very important that your initial contact be with the dealer.

Your purchase of a Honda product is greatly appreciated by both your dealer and American Honda Motor Co., Inc. We want to assist you in every way possible to assure your complete satisfaction with your purchase.



HONDA
HONDA MOTOR CO., LTD. TOKYO, JAPAN

3195705

® SB10008107C
PRINTED IN JAPAN