

 **HONDA**

1984

Owner's Manual



ATC70

PREFACE

This manual is your guide to the basic operation and proper maintenance of your new Honda ATC 70. Please take the time to read it carefully. Details of the special techniques to be learned for riding the Honda ATC are given in the RIDING section later in this manual. Your authorized Honda dealer will be glad to provide assistance or further information and is equipped to handle your future service needs.

Thank you for selecting a Honda. We wish you continued riding pleasure in the miles ahead.

All information in this publication is based on the latest product information available at the time of approval for printing. HONDA MOTOR CO., LTD. reserves the right to make changes at any time without notice and without incurring any obligation. No part of this publication may be reproduced without written permission.

©Honda Motor Co., Ltd. 1983



CONTENTS

ATC SAFETY	1
SERIAL NUMBER LOCATIONS	4
DESCRIPTION	5
COMPONENT FUNCTION	7
Ignition Switch	7
Brake Lever/Parking Brake	7
Gearshift Pedal	8
Neutral Indicator	9
Choke Lever	10
Fuel Valve	11
Fuel Tank	12
Fuel Drain	13
Oil Recommendation	14
Engine Oil Level	15
Throttle Lever	15

Speed Limiter	16
Step Guard	17
Tires	18
PRE-RIDE INSPECTION	19
STARTING THE ENGINE	20
BREAK-IN PROCEDURE	21
RIDING THE HONDA ATC	23
Turning Maneuvers	24
Climbing Hills	28
Descending Hills	30
Traveling Slopes	31
Riding Through Water	32
Tire Care	33
MAINTENANCE	34
Maintenance Schedule	34
Tool Kit	36

MAINTENANCE OPERATIONS	37
Engine Oil Level	37
Engine Oil Change	37
Brake Adjustment	39
Drive Chain Adjustment	40
Drive Chain Lubrication	41
Valve Clearance Adjustment	42
Contact Breaker Point Gap and Ignition Timing Adjustment	44
Spark Plug Replacement and Adjustment	45
Air Cleaner Maintenance	46
Throttle Cable Inspection and Adjustment	47
Carburetor Adjustment	48
Fuel Strainer Maintenance	49
Cam Chain Adjustment	50

Clutch Adjustment	51
Spark Arrester Maintenance	52
TRANSPORTING THE ATC	53
Fuel	53
Removing and Installing the Rear Wheels	54
Removing the Front Wheel	55
Installing the Front Wheel	56
STORAGE	57
OPTIONAL PARTS	58
NOISE EMISSION CONTROL SYSTEM (USA ONLY)	59
SPECIFICATIONS	60
WIRING DIAGRAM	61
WARRANTY SERVICE	64

ATC SAFETY

MESSAGE TO PARENTS

The ATC 70 is designed for junior riders (rider weight of 150 pounds or less). It is a fine learning ATC as long as the following precautions are observed:

- * The parent or instructor must be fully familiar with the ATC 70 and the ATC's controls before starting to teach a junior rider. Both instructor and student must fully understand everything in this manual before riding instruction begins.
- * The ATC 70 is an OPERATOR-ONLY model. The rider weight limit of 150 pounds must be observed.
- * The practice location must be a level, uncongested off-road area free of obstacles.
- * It is illegal to ride the ATC 70 on

public streets, roads or highways. It must be ridden only in off-road areas where such activities are permitted. If it becomes necessary to cross a public roadway, remember to get off the ATC and push it across.

- * For safety, the ATC 70 must be properly adjusted and maintained. Be sure to make a "Pre-ride Inspection" and be sure to impress the student rider with the importance of checking all the items thoroughly before riding the ATC.

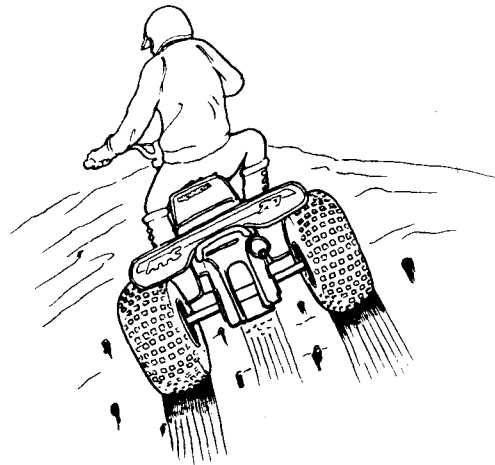

-
- * A prime objective in the instruction process is developing the student's self confidence. This self-confidence comes with a total familiarization with the ATC's controls and their functions, plus lots of PRACTICE.
 - * Always obey local off-road riding laws and regulations.
 - * Obtain permission to ride on private property. Avoid posted areas and obey "no trespassing" signs.
 - * When the basic riding techniques have been mastered by the young rider remember these next few words of caution: The young rider should always ride in the company of an adult on another ATC so they can assist each other in the event of trouble.
 - * Familiarity with the ATC is critically important should a problem occur far from help.
 - * Caution the young rider never to ride beyond his or her ability and experience or faster than conditions warrant.
 - * If you are not familiar with the terrain, the adult should lead the way and ride cautiously. Hidden rocks, holes or ravines could spell trouble.

PROTECTIVE APPAREL

1. Most motorcycle accident fatalities are due to head injuries: ALWAYS wear a helmet. You should also wear a face shield or goggles, boots, gloves, and protective clothing.
2. The exhaust system becomes very hot during operation, and it remains hot after operation. Never touch any part of the hot exhaust system. Wear clothing that fully covers your legs.

MODIFICATIONS

WARNING

- * **Modification of the ATC, or removal of original equipment may render the vehicle unsafe or illegal. Obey all federal, state and local equipment regulations.**
- * **Spark arresters and mufflers are required in most areas. Don't modify your exhaust system.**
- * **Remember that excessive noise bothers everyone and creates a bad image for motorcycling.**

SERIAL NUMBER LOCATION

SERIAL NUMBERS

The frame and engine serial numbers are required when registering your ATC. They may also be required by your dealer when ordering replacement parts. Record the numbers here for your reference.

FRAME NO. _____

ENGINE NO. _____



① Frame serial number

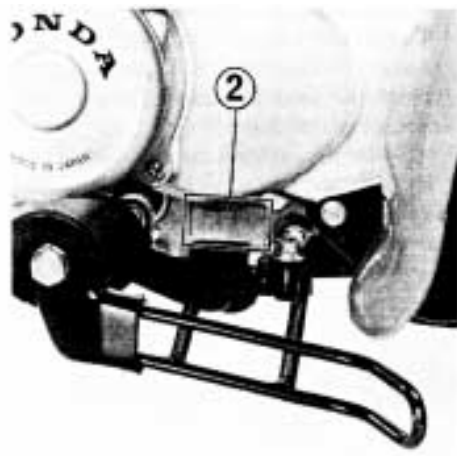

② Engine serial number

DESCRIPTION

- ① Ignition switch
- ② Fuel tank cap
- ③ Fuel tank
- ④ Fuel valve
- ⑤ Choke lever
- ⑥ Gearshift pedal
- ⑦ Recoil starter
- ⑧ Neutral indicator

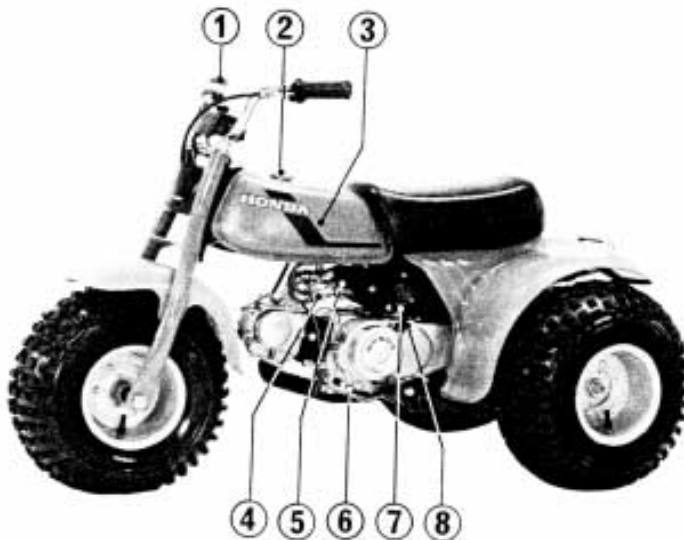

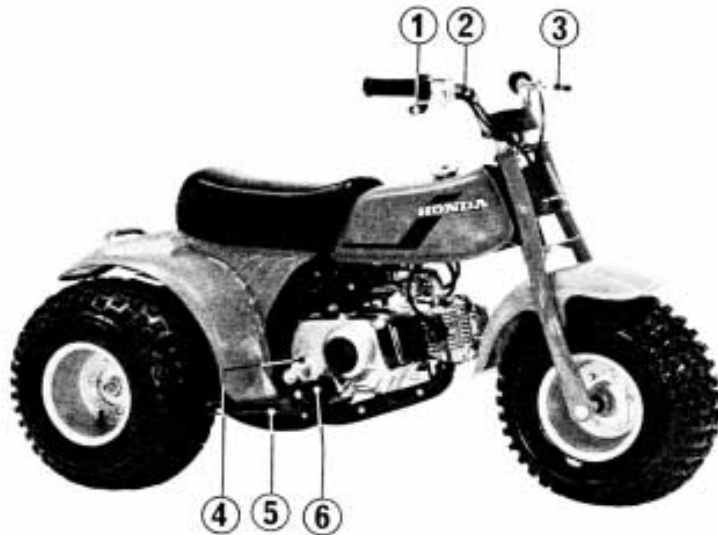

- ① Throttle lever
- ② Handlebar
- ③ Brake lever/Parking brake
- ④ Oil filler cap
- ⑤ Step guard
- ⑥ Footpeg

COMPONENT FUNCTION

IGNITION SWITCH

The ignition switch ① is on the right handlebar. Turn the switch to ON when starting the engine and to OFF to stop the engine.

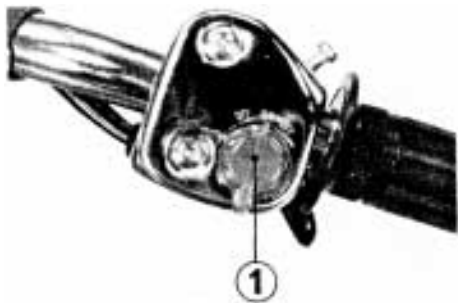

① Ignition switch

BRAKE LEVER/PARKING BRAKE

The brake lever ① is on the left handlebar and applies the brake to the rear wheels only. The brake lever free play should be 15 ~ 20 mm (5/8 ~ 3/4 in) at the tip of the lever.

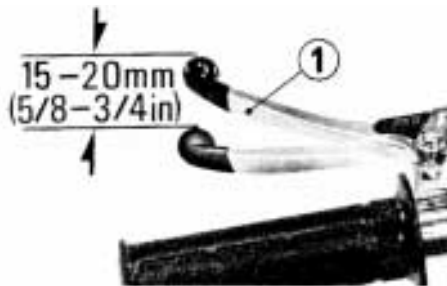

① Brake lever

The rear brake lever has the added feature of a lock ② which allows the lever to be used as a parking brake. (note use in photo).

Pull the brake lever back and lock it with the lock. Always apply the parking brake when parking on a hill.

NOTE:

* Use of the parking brake in freezing weather may cause the brakes to freeze in the locked position.

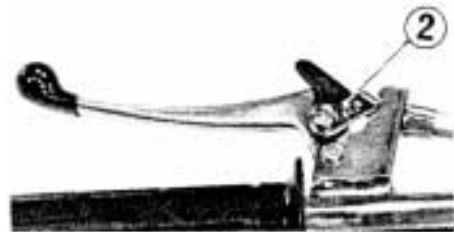

② Parking brake lock

Gearshift Pedal

The gearshift pedal ① is near the left footpeg. One full stroke of the pedal will shift the transmission. The pedal automatically returns to the horizontal position when released. Each stroke of the pedal engages the next gear in sequence. Depress the pedal to shift to a higher gear and raise the pedal to shift to a lower gear.

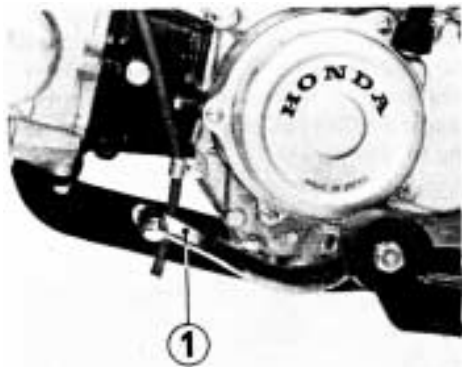

① Gearshift pedal

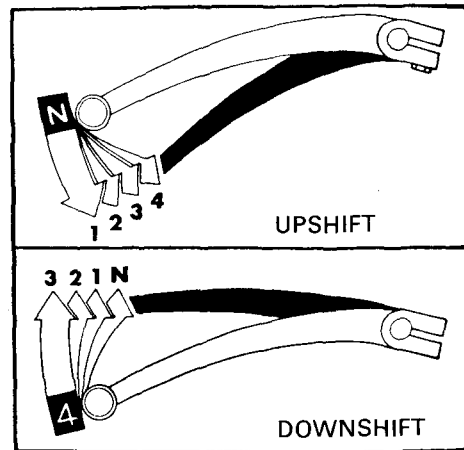

Shifting sequence



① Neutral indicator

NEUTRAL INDICATOR

The neutral indicator ① is on the left crankcase cover, just behind the recoil starter. This feature enables the rider to see that neutral has been selected before starting the engine.

The indicator rotates as the gears are changed. When the indicator aligns with the N mark on the crankcase, the transmission is in neutral.

CHOKE LEVER

The choke lever ① is on the left side of the carburetor.

Raising the choke lever will close the choke valve. With the choke lever raised, the carburetor delivers a rich fuel mixture for starting the engine when cold. Lower the choke lever as the engine warms up.

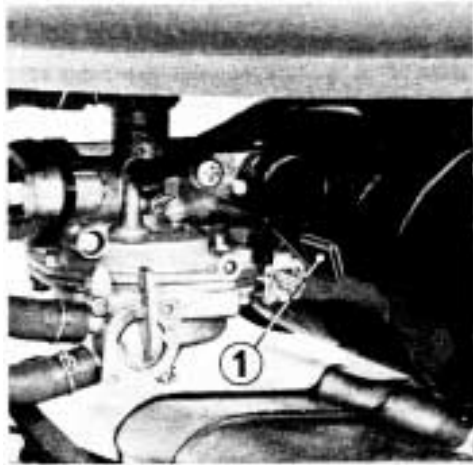

① Choke lever

FUEL VALVE

The fuel valve is on the left side of the carburetor.

OFF position

In OFF, the fuel flow will be cut off. Whenever the vehicle is not in use, set the valve to this position.

ON position

In ON, fuel will flow to the carburetor. When the engine is to be operated, set the valve to this position.

RES position

The fuel valve should be set to RES only after the regular fuel supply has been consumed. The reserve capacity is approximately 0.8 liter (0.2 US gal). When it becomes necessary to switch to RES the rider should refill the fuel tank.

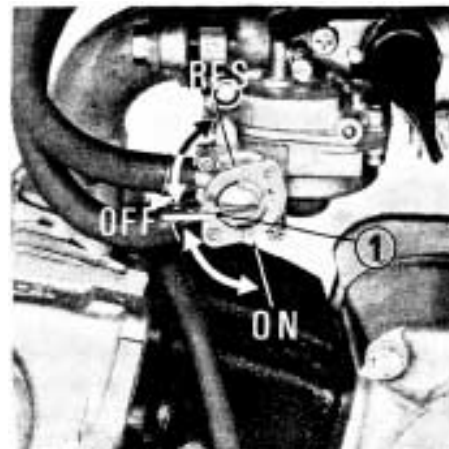

① Fuel valve lever

FUEL TANK

The fuel tank cap is removed by turning it counterclockwise. The fuel tank capacity including reserve is 4.3 liters (1.1 gal). Use of low-lead gasoline with 91 research octane number or higher is recommended. If such gasoline is not available, you may use a leaded regular grade gasoline. When refueling, do not allow dirt, water, or other contaminants to enter the fuel tank.

WARNING

Gasoline is extremely flammable and is explosive under certain conditions. Always stop the engine and do not smoke or allow flames or sparks near the ATC-70 when refueling.

WARNING

Do not overfill the tank (there should be no fuel in the filler neck). Make sure that the tank cap is closed securely.

Avoid repeated or prolonged contact with skin or breathing of vapor. KEEP OUT OF REACH OF CHILDREN.

FUEL VENT VALVE

The fuel vent valve ② is on the fuel tank cap. Turn the valve ON to allow fuel to flow when running the engine. Turning the valve OFF will prevent fuel from flowing out the vent hole when transporting the ATC.

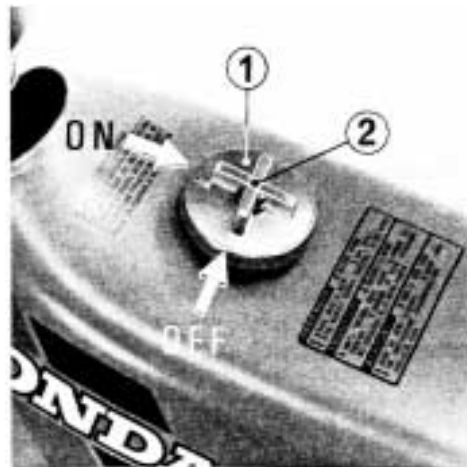

① Fuel tank cap ② Fuel vent valve

FUEL DRAIN

A fuel drain is provided to drain the carburetor and fuel tank for storage or transporting.

With the fuel valve at RES and the fuel vent valve ON, the fuel tank and carburetor will drain. If the fuel valve ① is OFF, only the carburetor will drain.

When draining, put the lower end of the carburetor drain tube ③ into a suitable gasoline container. Open the fuel drain by turning the carburetor drain screw ② counterclockwise.

WARNING

- * Gasoline is extremely flammable and is explosive under certain conditions. Always stop the engine and do not smoke or allow flames or sparks near the ATC-70 when draining fuel.

Before refilling the fuel tank, close the fuel drain by turning the carburetor fuel drain screw clockwise until tight.

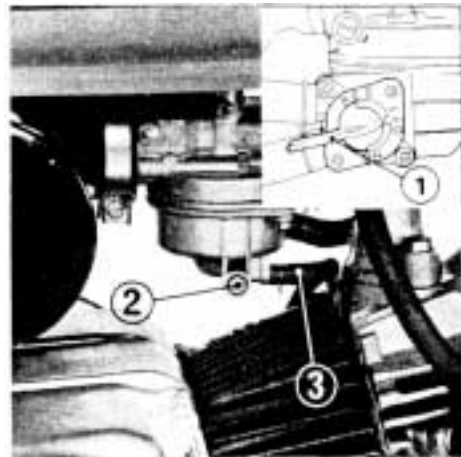

- ① Fuel valve
- ② Drain screw
- ③ Drain tube

OIL RECOMMENDATION

USE HONDA 4-STROKE OIL OR AN EQUIVALENT.

Use only high detergent, premium quality motor oil certified to meet or exceed U.S. automobile manufacturers' requirements for Service classification SE or SF.

Motor oils intended for Service SE or SF will show this designation on the container.

The use of special oil additives is unnecessary and will only increase operating expenses.

Oil should be changed at intervals prescribed in the Maintenance Schedule on page 34.

CAUTION:

Engine oil is a major factor affecting the performance and service life of the engine. Non-detergent, vegetable, or castor based racing oils are not recommended.

RECOMMENDED OIL VISCOSITY

SAE 10W-40

Other viscosities shown in the chart below may be used when the average temperature in your riding area is within the indicated range.

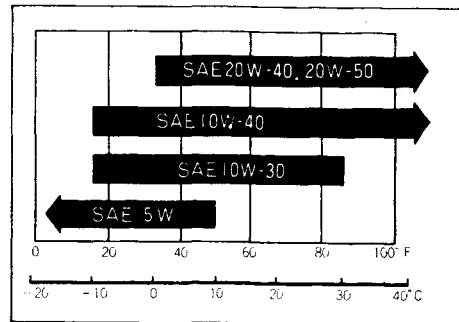

ENGINE OIL LEVEL

To check the oil level, place the ATC on level ground and unscrew the dipstick ①. Wipe it dry and reinsert the dipstick in the oil filler hole; do not screw it in. Withdraw the dipstick again and check the oil level. The oil should be between the upper ② and lower ③ marks on the dipstick.

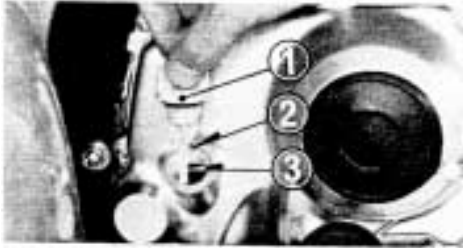

- ① Dipstick
- ② Upper oil level mark
- ③ Lower oil level mark

THROTTLE LEVER

The throttle lever ① is on the right handlebar grip and is operated by the rider's thumb. Pressing the lever forward opens the throttle. When the lever is released, spring tension closes the throttle automatically.

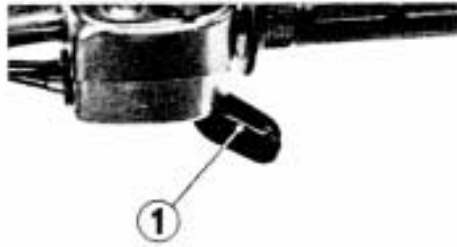

- ① Throttle lever

SPEED LIMITER

The speed limiter is a screw installed in the throttle control case. It limits maximum throttle and top speed to about 25 Km/h. (16 mph). This limiter is especially applicable to beginning riders. After the rider becomes proficient, the speed limiter can be removed by loosening the lock nut ① and removing the speed limiter screw ②. After removing the speed limiter, plug the hole with the screw enclosed with ATC 70.

WARNING

Failure to plug the hole after removing the speed limiter screw will allow dirt to enter, and may cause the throttle to stick open.

CAUTION:

To prevent rapid clutch wear, do not operate below 20 km/h (13 mph) in 4-th gear.

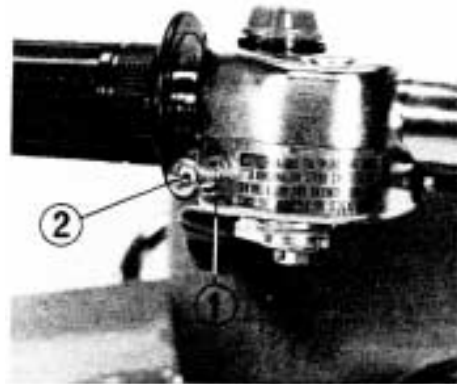

① Lock nut ② Speed limiter screw

STEP GUARD

The step guards ① are attached to the right and left footpegs. The step guards help to keep the rider's feet away from the rear tires.

WARNING

Do not ride the ATC 70 with the step guards removed.

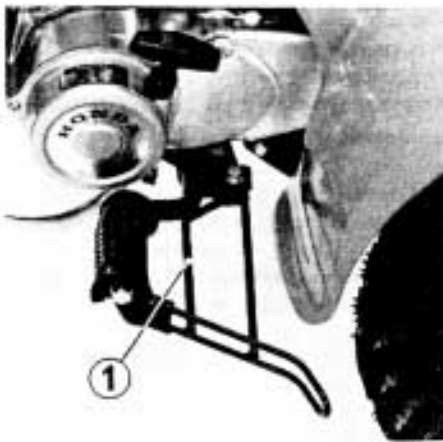

① Step guard

TIRES

The **ATC 70** is equipped with 16 x 8.0 -7, Sp. low pressure, tubeless tires. These tires are designed specifically for off-road use.

CAUTION:

Driving on paved surfaces will cause excessive tire wear.

For normal use, the tires should be inflated to a recommended pressure of 2.2 psi (15kpa, 0.15 kg/cm²). A manually operated tire pump should be used rather than the high pressure systems found in service stations. This will minimize tire damage from overinflation.

Be sure to inflate both rear tires equally. If the **ATC 70** is operated with unequal

tire pressures, the resultant difference in tire circumference will cause the **ATC 70** to run toward one side and will affect handling adversely.

Recommended Pressure: 2.2 psi
(15kpa, 0.15 kg/cm²)

Max Pressure: 2.5psi (18kpa, 0.18kg/cm²)

Min Pressure: 1.7psi (12kpa, 0.12kg/cm²)

Standard Tire Circumference at recommended air pressure:
1,290 mm (50.7 in)

CAUTION:

Maintain proper tire pressure. Under-inflated tires may adversely affect maneuverability and cause wheel damage when riding over bumpy terrain. Overinflation may damage the tires and cause them to rub on the fenders, hampering movement of the ATC.



PRE-RIDE INSPECTION

WARNING

If the Pre-ride Inspection is not performed, serious damage or an accident may result.

Inspect your **ATC 70** every day before you start the engine. The items listed here will only take a few minutes to check and, in the long run, can save time, expense, and possibly your life.

1. Engine oil level—If necessary, add engine oil (page 15). Check for leaks.
2. Fuel level — fill the fuel tank when necessary (page 12). Check for leaks.
3. Brake lever—check operation. If necessary, adjust free play. (page 39).
4. Tires—check condition and pressure (page 18).

5. Drive chain—check condition and slack (pages 40–41). If necessary, adjust and lubricate.
6. Throttle—check for smooth opening and closing in all steering positions.
7. Engine stop switch—check for proper function before riding (page 7).
8. Nuts, Bolts, Fasteners—check the wheels to see that the axle nuts are tightened and secured by cotter pins. Check the security of all other nuts, bolts and fasteners.

Correct any discrepancy before you ride. Contact your authorized Honda dealer for assistance if you cannot correct the problem.

STARTING THE ENGINE

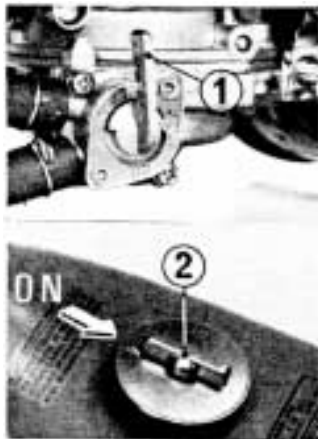

- ① Fuel valve lever
- ② Fuel vent valve



- ③ Ignition switch



- ④ Neutral indicator

WARNING

Exhaust contains poisonous carbon monoxide gas. Never run the engine in a closed area.

1. Lock the parking brake. Turn the fuel valve ① to ON, and make sure that the fuel vent valve ② is ON.
2. Turn the ignition switch ③ ON.
3. Make sure that the transmission is in neutral by lifting the shift lever and checking that the neutral indicator ④ is at N.

WARNING

Do not try to start the engine with the transmission in gear. You may injure yourself or damage the vehicle.

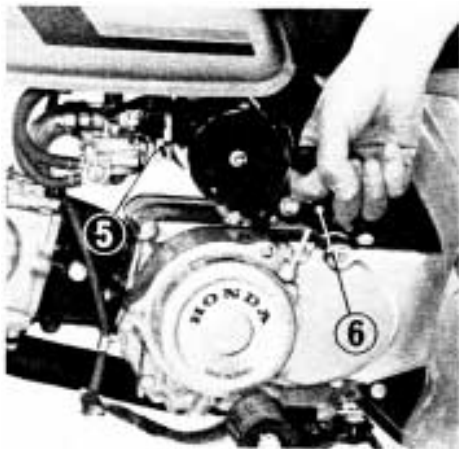

⑤ Choke lever ⑥ Recoil starter

4. Raise the choke lever (5) and open the throttle approximately $1/4$ to $1/3$. Pull the recoil starter (6) slightly until compression is felt. With the engine against compression, pull the starter rope briskly to start.

If the engine does not start after several attempts, it may have become flooded with excess fuel. To clear the engine, turn the ignition switch OFF, lower the choke lever to open the choke, hold the throttle fully open, and pull the recoil starter rope several times.

When the engine is cleared, turn the ignition switch ON and repeat the normal starting procedure, but do not use the choke.

CAUTION:

Use of the choke after the engine warm-up may impair piston and cylinder lubrication.

NOTE:

- * Do not race the engine during the warm up period. Revving a cold engine wastes fuel and increases engine wear.
- * In cold weather, leave the choke valve closed several minutes after the engine starts and then gradually open the choke as the engine warms up.

BREAK-IN PROCEDURE

During the first few days of riding, operate your new ATC 70 so that the engine neither pulls laboriously nor approaches maximum rpm in any gear. Avoid full throttle operation, and select your gear changes to spare the engine undue stress. Careful break-in procedure during initial operation will measurably extend the service life of the engine.

RIDING THE HONDA ATC

RIDING

Review ATC Safety (page 1) before you ride:

WARNING

- * Avoid "wheelies" and jumping as they may cause loss of control.
- * Ride with your feet on the footpegs at all times. If your feet are removed from the footpegs to touch the ground while the ATC is moving, they may come in contact with the rear tires.

Under normal riding conditions it is not necessary or desirable to touch the ground for balance.

For your initial riding practice, select a safe area free of obstacles and with an even surface. Avoid paved surfaces as they make learning to maneuver more difficult, and will also significantly

shorten tire life.

1. After the engine has been warmed up, the ATC is ready for riding. Release the parking brake.
2. While the engine is idling, depress the gearshift pedal to shift into 1st (low) gear.
3. Increase engine speed by opening the throttle.
4. When your speed increases, close the throttle and shift to 2nd gear by depressing the gearshift pedal.

CAUTION:

- * Do not shift gears without closing the throttle. The engine and drive train could be damaged by overspeed and shock.
5. This sequence is repeated to progressively shift to 3rd and 4th (top) gear.

CAUTION:

- * Do not tow the vehicle or coast for long distances while the engine is off. The transmission will not be properly lubricated and damage may result.

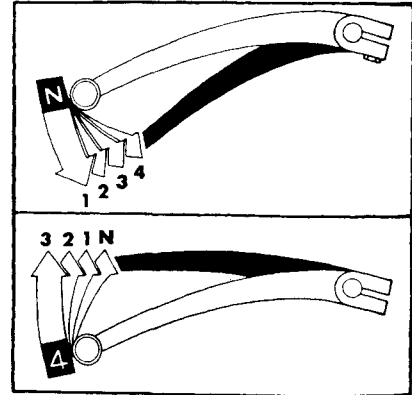

Shifting sequence

TURNING MANEUVERS

For better traction in off-road use, the ATC has been fitted with a rear axle which drives both rear wheels equally at all times.

When negotiating a turn, the wheel on the outside of the turn must travel a wider radius and thus, a greater distance, than

the inside wheel. As the rear axle does not permit a differing rate of wheel rotation, it is not enough to merely steer the ATC into a turn. The new rider must learn to shift his or her weight and control the throttle to allow the rear tires to negotiate the turn. This is the primary technique to be mastered in riding the Honda ATC.

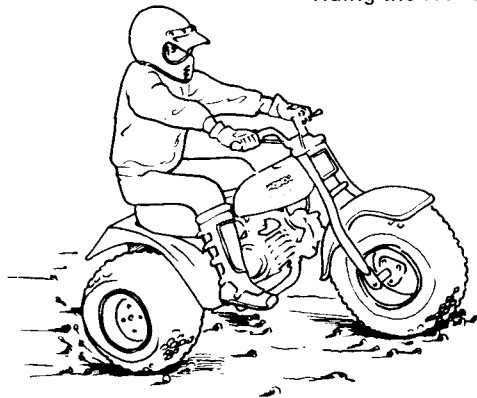

For your initial riding practice, operate the ATC in low gear. Avoid higher speeds until you are confident of your abilities.

Practice turning the ATC at slow, constant speeds. Steer in the direction of the turn, and lean your body to the inside of the turn, while supporting your weight on the outer footpeg. Use the throttle to maintain power throughout the turn.

This technique allows the ATC to lean slightly toward the outside, altering the balance of traction between the rear wheels sufficiently to allow them to negotiate the turn.

Once this technique is learned, turning maneuvers can be performed within a relatively small area.

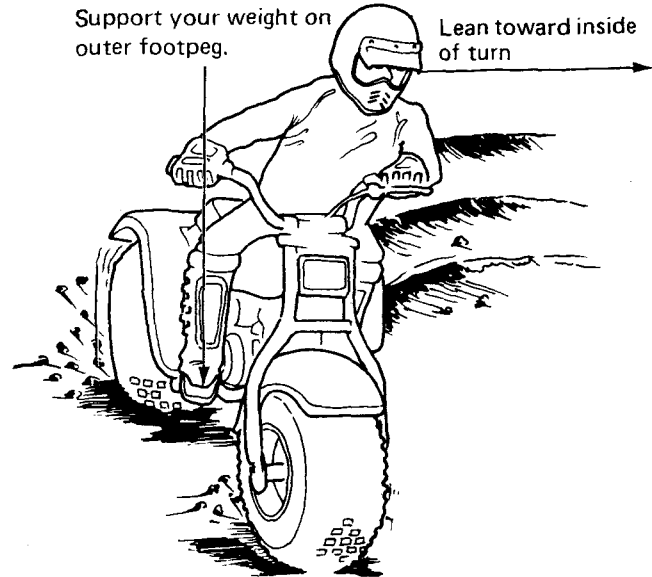

Incorrect turning techniques may cause the front wheel to slide straight ahead when steered without affecting the ATC's direction of travel. If this should occur, close the throttle, come to a stop, then continue practicing, adhering to the technique outlined on the preceding page.

If the front wheel tends to skid in mud or snow, you may be able to improve control under these conditions by leaning forward, transferring additional weight to the front wheel.

If the rear wheels inadvertently skid sideways and you have room to maneuver safely, correct your slide by steering in the direction of the skid. Avoid braking or accelerating until you have directional control of the ATC.

To avoid skidding while traveling on slippery terrain, the rider must exercise a high degree of caution.

Controlled skids and spins, when performed safely, add to the sport the rider can enjoy. However, as skidding maneuvers are inherently more hazardous than those performed under full traction, we must caution the rider to first master the basic techniques of handling the ATC before practicing any skidding maneuver.



Surface composition is, of course, a major factor affecting skidding capability. It is obviously easier to slide on packed snow than in deep sand. Surfaces with extremely low or extremely high coefficients of friction must not be used for skidding maneuvers, however. It is dangerous to skid on ice, because you may lose all directional control, and it is dangerous to skid on pavement, because you may regain traction suddenly and unexpectedly, which can cause you to lose your balance and overturn.

CLIMBING HILLS

Practice climbing on evenly surfaced slopes of less than 20°. The ATC's capability in climbing hills or traversing any specific terrain is dependent upon rider skill. As you gain experience in handling the ATC, and learn the hazards to be encountered and your own limitations, you may then proceed to ride more challenging terrain. However, you must first be able to discern and avoid any hill or hazard that would cause the ATC to overturn.

WARNING IF THE FRONT WHEEL IS ALLOWED TO RISE FROM THE GROUND, THIS WILL LESSEN YOUR CONTROL OF THE ATC AND MAY CAUSE IT TO OVERTURN BACKWARD. THE SUDDEN APPLICATION OF POWER BY OPENING THE THROTTLE OR CHANGING GEARS WILL TEND TO RAISE THE FRONT WHEEL, ESPECIALLY WHILE ASCENDING A HILL.

The riding technique for hill climbing involves transferring your weight toward the front wheel to keep it in contact with the ground. This may be done by leaning forward from the normal riding position, or for greater weight transference, by standing on the footpegs and leaning forward.

Take a running start, approaching the base of the hill in the appropriate gear and speed for the ascent, and climb at a steady rate of speed.



If you should find that you have incorrectly estimated climbing capability and lack the power or traction to continue the ascent, then turn the ATC around if space permits while you still have the forward speed to do so and descend. Avoid stalling part way up a hill, as maneuvering will then become more difficult.

⚠ WARNING BEFORE ATTEMPTING ANY TURNING MANEUVER ON A HILLSIDE, THE RIDER SHOULD FIRST LEARN THE TURNING TECHNIQUE BY PRACTICING ON LEVEL GROUND.

If you do lose all forward speed, and can neither continue uphill nor maneuver the ATC under its own power, it will be necessary to dismount and physically turn the ATC around in order to descend.

⚠ WARNING TO AVOID OVERTURNING, THE RIDER MUST EXERCISE A HIGH DEGREE OF CAUTION WHEN DISMOUNTING OR MOVING THE ATC ON A HILLSIDE.

If it becomes necessary to roll the ATC backward, first shift the transmission into neutral. Wherever circumstances permit, however, we strongly recommend that the rider turn the ATC around rather than backing downhill.

⚠ WARNING APPLYING THE BRAKE OR ENGAGING THE TRANSMISSION WHILE ROLLING BACKWARDS DOWNHILL CAN EASILY CAUSE THE ATC TO OVERTURN AND FALL ON THE RIDER.



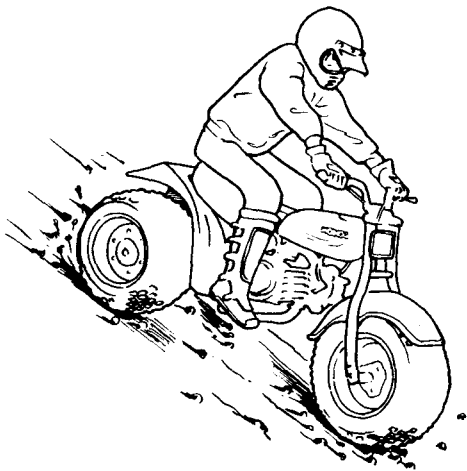

DESCENDING HILLS

It is usually advisable to descend hills with the ATC pointed directly downhill, avoiding angles that would cause the ATC to lean sharply to one side. As you approach the point of descent, stop and survey the terrain below. Never ride headlong past your limit of visibility. When you have picked a safe path of descent, shift the transmission into low gear and descend slowly with the throttle closed. Sit back on the seat, with arms extended and braced upon the handlebars.

When descending sand dunes, we recommend that the rider apply the brake intermittently to further reduce forward speed.

Braking effectiveness is, of course, reduced while descending any incline with a loose surface.

TRAVERSING SLOPES

When riding across a slope, at right angles to the incline of the hill, lean your body uphill to maintain balance and stability. On a loose surface such as sand, it may become necessary to steer slightly uphill in order to maintain your course of travel.

WARNING BALANCE IS MORE PRECARIOUS WHILE THE ATC IS TILTED TO ONE SIDE. AVOID TRAVERSING SLOPES WHERE THERE IS SLIPPERY OR DIFFICULT TERRAIN.



RIDING THROUGH WATER

The Honda ATC70 can ford water to a depth of approximately 7 inches, although the rider must be careful to avoid getting the spark plug or air cleaner wet.

WARNING DO NOT RIDE THE ATC IN WATER BEYOND ITS LIMIT.

When crossing streams, choose a course where both banks have gradual inclines. Proceed at a slow, steady speed, and take care to avoid submerged obstacles and slippery rocks.

WARNING DO NOT FORD ANY STREAM WITH FAST FLOWING WATER. THE TIRES HAVE A TENDENCY TO FLOAT, MAKING IT DIFFICULT TO MAINTAIN CONTROL.

After riding through water, the brake may be less effective than normal. Test the brake after traveling through any water, and if necessary, apply the brake repeatedly until the heat of friction has dried it, and it regains normal effectiveness.



TIRE CARE

The Honda ATC is equipped with 16 x 8.0-7 low pressure tubeless tires. For normal use, they should be inflated to a recommended pressure of 2.2 psi (15 kpa, 0.15 kg/cm²). A manually operated tire pump should be used rather than the high pressure systems found in service stations. This will minimize tire damage by overinflation.

If no air pressure gauge is available to accurately measure air pressure, this value can be obtained by measuring the circumference of the tires with a measuring tape. The tires will increase in circumference as air pressure is added. When inflated to 2.2 psi (15 kpa, 0.15 kg/cm²), the tire circumference measured over the tread rib (see page 18) will be approximately 1,290 mm (50.7 inches). The relationship between tire pressure and actual circumference varies slightly with factors of wear and stretching that occur through use.

Be sure to inflate both rear tires equally. If the ATC is operated

with unequal tire pressures, the resultant difference in tire circumference will cause the ATC to tend to run toward one side and will adversely affect handling.

If you have a flat tire, use the plug method to perform temporary repairs. The plug method is the same as that for conventional tubeless tires. A plug type repair kit, which is available at most auto part stores or service stations, provides a plug, an installation tool, tire cement, and an instruction sheet. Follow the instructions provided in the repair kit to perform a temporary repair until the tire can be permanently repaired by the cold patch method. Any tire which cannot be repaired by the plug method should be replaced.

Whenever the ATC is to be operated far from service facilities or available transportation, we recommend that the rider carry a tire pump and a suitable repair kit with the ATC.

MAINTENANCE

MAINTENANCE SCHEDULE

- The U.S. Environmental Protection Agency requires manufacturers to certify that vehicles built after January 1, 1983 will comply with applicable noise emission standards for one year or 3,000 km (1,865 miles) after the time of sale to the ultimate purchaser, when operated and maintained according to the instructions provided. Compliance with the terms of the Distributor's Warranty for the Honda Vehicle Noise Emission Control System is necessary in order to keep the noise emission control system in effect. (USA only)

The maintenance intervals shown in the following schedule are based upon average riding conditions. ATC's subjected to severe use, or ridden in wet or dusty areas require more frequent servicing. Items marked * should be serviced by an authorized Honda dealer, unless the owner has the proper tools and is mechanically proficient. Other maintenance items are simple to perform and may be serviced by the owner.

Perform the Pre-ride Inspection (Page 19) at each scheduled maintenance period.

I: Inspect and Clean, Adjust, Lubricate or Replace, if necessary C: Clean R: Replace A: Adjust		INITIAL SERVICE PERIOD (First week of operation)	REGULAR SERVICE PERIOD (Every 30 operating days)	Refer to page
	ENGINE OIL	NOTE (1), (2)	R	37
*	CONTACT POINTS AND IGNITION TIMING	I	I	44
	AIR CLEANER ELEMENT	NOTE (2)	C	46

NOTE: (1) Replace every 30 operating days or every 3 months, whichever comes first

(2) Service more frequently when riding in dusty areas.

I: Inspect and Clean, Adjust, Lubricate or Replace, if necessary C: Clean R: Replace A: Adjust		INITIAL SERVICE PERIOD (First week of operation)	REGULAR SERVICE PERIOD (Every 30 operating days)	Refer to page
	SPARK PLUG		I	45
*	VALVE CLEARANCE (COLD ENGINE)	I	I	42
*	CAM CHAIN TENSIONER	A	A	50
*	CARBURETOR (HOT ENGINE)	I	I	48
	FUEL LINE	I: (EVERY YEAR)		13
*	FUEL STRAINER SCREEN	C: (EVERY YEAR)		49
	THROTTLE OPERATION	I	I	47
	DRIVE CHAIN	NOTE(2)	I	40-41
*	BRAKE SHOES	I: (EVERY YEAR)		39
	BRAKE SYSTEM	I	I	39
*	CLUTCH	A	A	51
*	SPARK ARRESTER		C	52
	ALL NUTS, BOLTS, FASTENERS	I	I	-
	TIRES	I	I	33
*	STEERING HEAD BEARING	A: (EVERY YEAR)		-

⚠ WARNING

- * Always turn the engine off before performing any maintenance operations unless otherwise stated.
- * To maintain the safety and reliability of your HONDA ATC, do not modify it and use only new genuine HONDA parts or their equivalent when servicing or repairing.
The use of replacement parts which are not of equivalent quality may impair the operation of your ATC.

TOOL KIT

A spark plug wrench and handle are stored under the rear of the seat. Any extensive work requiring additional tools should be performed by an authorized Honda dealer.

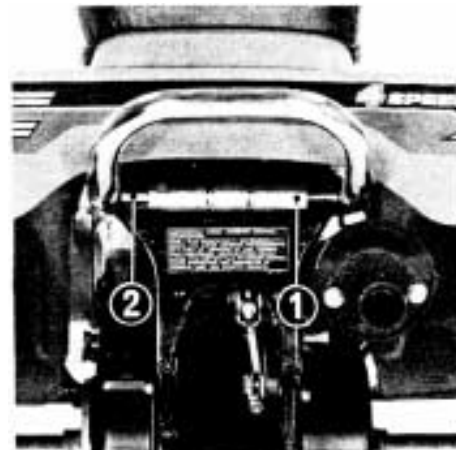

- ① Spark plug wrench
- ② Wrench handle

MAINTENANCE OPERATIONS

ENGINE OIL LEVEL

Check engine oil level at the start of each day the **ATC 70** is to be ridden. The oil filler cap contains a dipstick ① for measuring oil level.

Oil level should be checked with the **ATC 70** on level ground. Remove the oil filler cap/dipstick, wipe it clean and reinsert the dipstick without screwing it in. Remove the oil filler cap/dipstick again and check the oil level.

Oil level should be maintained between the upper ② and lower ③ oil level marks on the dipstick.

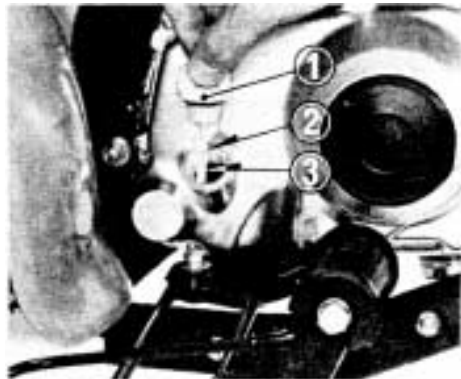

- ① Dipstick
- ② Upper level mark
- ③ Lower level mark

ENGINE OIL CHANGE

Engine oil should be changed in accordance with the maintenance schedule on page 34. Use motor oils of the grade and viscosity recommended on page 14.

When changing oil, drain the used oil from the crankcase while the engine is still warm. This will ensure complete and rapid draining.

1. Remove the oil filler cap/dipstick from the right crankcase cover.

2. Place a drain pan under the engine to catch the oil, remove the drain plug ① with a box wrench.
3. After the oil stops draining from the crankcase, turn the engine stop switch OFF and pull the recoil starter several times to drain any oil which may be left in the engine. (Make sure the engine stop switch is OFF.)
4. When the oil has been completely drained, reinstall the drain plug. Be sure the washer which seals the drain plug is in good condition.

5. Fill the crankcase through the oil filler opening with approximately 0.8 liter (0.8 US qt) of the recommended grade of motor oil.

Make sure that the oil level is between the upper and lower marks.

NOTE:

ATC's ridden in dusty areas require oil changes at more frequent intervals than specified in the MAINTENANCE SCHEDULE.

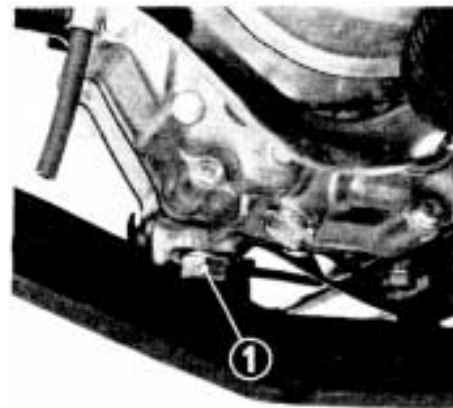

① Drain plug

BRAKE ADJUSTMENT

Free play, measured at the tip of the brake lever ①, should be 15 ~ 20 mm (5/8 ~ 3/4 in).

The adjusting nut ② is located on the brake operating rod at the rear of the ATC.

If proper free play cannot be obtained after adjustment, see your authorized Honda dealer.

Check the brake cable for kinks or signs of wear that could cause sticking or failure. Lubricate the brake cable with a commercially available cable lubricant to prevent premature wear and corrosion.

Make sure the brake arm, spring and fasteners are in good condition.

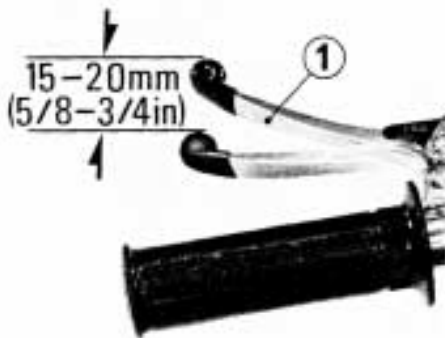

① Brake lever

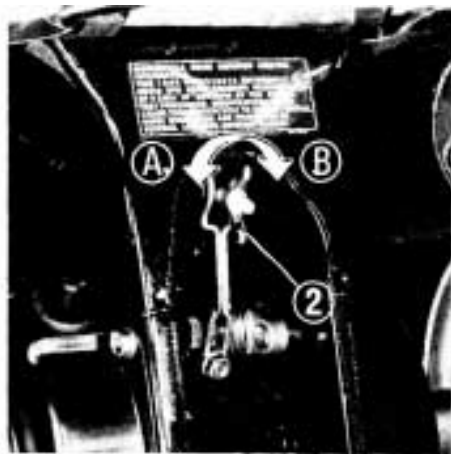

② Adjusting nut

Ⓐ Increase free play

Ⓑ Decrease free play

DRIVE CHAIN ADJUSTMENT

The drive chain ② will wear with use and requires periodic adjustment. Adjustment is normally performed in accordance with the MAINTENANCE SCHEDULE.

Shut the engine off. Remove the inspection hole ① cap from the side of the chain guard. Chain slack should be checked by measuring the amount of chain slack through the inspection hole. The amount of slack should be 10 mm ~ 20 mm (3/8 ~ 3/4 in).

To adjust slack, raise the right side of the ATC and place a block under the right tire. Loosen the lock nuts ③ and move the chain tensioner plate ④ to obtain correct chain slack. Tighten the lock nuts. Install the inspection hole cap.

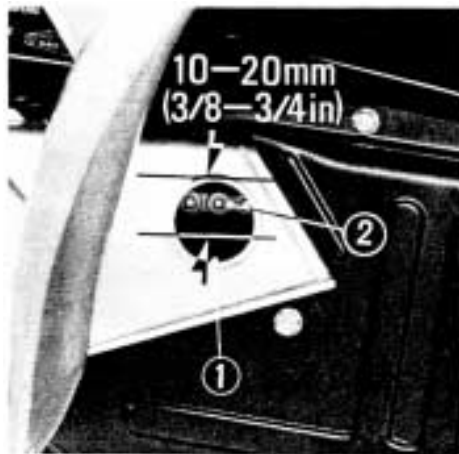

① Inspection hole ② Drive chain

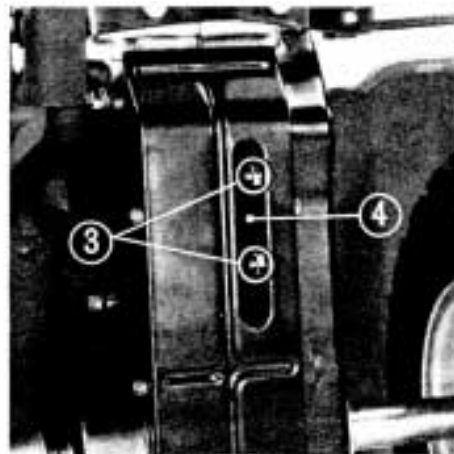

③ Lock nuts ④ Chain tensioner plate

DRIVE CHAIN LUBRICATION

The drive chain can be lubricated through the lubrication hole ① which is on the top rear of the chain guard. This hole is covered with a cap which keeps dirt out of the chain case. Be sure to reinstall the cap after lubrication.

Commercially prepared drive chain lubricants should be used in preference to motor oil for lubricating the drive chain.

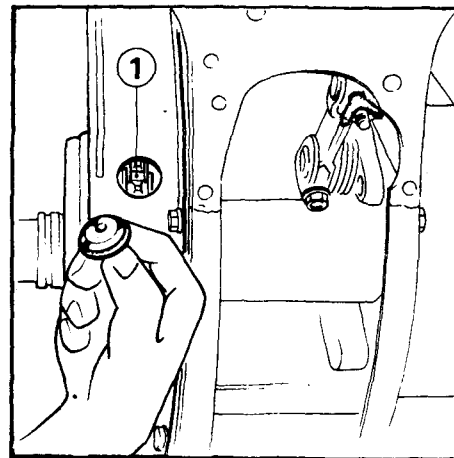

① Lubrication hole

VALVE CLEARANCE ADJUSTMENT

Valve clearance should be maintained at 0.05 mm (0.002 in). Excessive clearance will cause noise. Insufficient clearance will cause loss of power and could cause valve damage.

NOTE:

Check or adjust valve clearances while the engine is cold. The clearance will change as the temperature rises.

To adjust the valves:

1. Shut the engine off.
2. Remove the recoil starter and rocker arm adjustment hole caps.
3. Rotate the alternator rotor counter-clockwise until the T mark ① on the dynamo rotor lines up with the timing index mark ② on the stator.

In this position, the piston may either be on the compression or the exhaust stroke. The adjustment must be made when the piston is on top of the compression stroke when both the intake and exhaust valves are closed. This can be determined by moving the rocker arms by hand. If the rocker arms are free, it is an indication

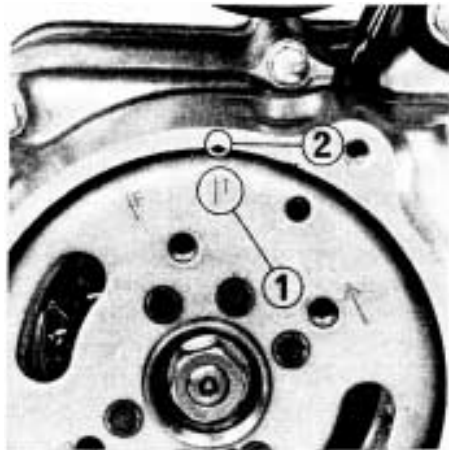

- ① "T" mark
- ② Index mark

that the valves are closed and that the piston is on the compression stroke. If the rocker arms are tight and the valves are open, rotate the dynamo rotor 360° and realign the T mark to the timing index mark. Check the clearance of both valves by inserting a 0.05 mm (0.002 in) gauge between the adjusting screw and valve stem.

If adjustment is necessary, loosen the adjusting screw lock nut ③ and turn the adjusting screw ④ so that there is a slight resistance when the gauge is inserted. After completing the adjustment, tighten the adjusting screw lock nut while holding the adjusting screw to prevent it

from turning. Recheck the clearance to make sure that the adjustment has not changed.

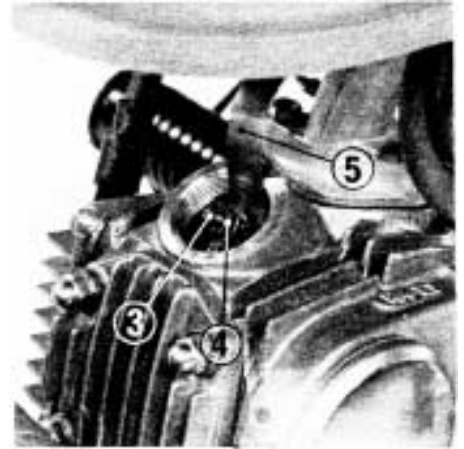

③ Adjusting screw lock nut
④ Adjusting screw ⑤ Feeler gauge

CONTACT BREAKER POINT GAP AND IGNITION TIMING ADJUSTMENT

Ignition timing is adjusted by altering the contact breaker point gap ①.

1. Remove the recoil starter on the left side of the engine.
2. Rotate the flywheel counterclockwise and align the F mark ③ with the index mark ④. Ignition timing is correct if the contact breaker points just begin to open at this moment.
3. If ignition timing is incorrect, loosen the contact breaker locking screws ② and adjust the breaker point gap. Increasing the gap will advance ignition timing. Decreasing the gap will retard ignition timing.
4. Retighten the contact breaker locking screws and recheck ignition timing.

NOTE:

Point gap must remain within limits of 0.3–0.4 mm (0.012–0.016 in) after ignition timing has been set. If correct timing results in a point gap which is outside these limits, replace the contact breaker points.



- ① Contact breaker points
- ② Contact breaker point locking screws

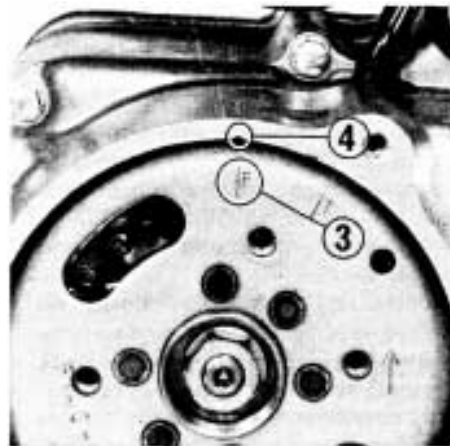

- ③ F mark
- ④ Index mark

SPARK PLUG REPLACEMENT AND ADJUSTMENT

Standard Spark plugs
NGK CR7HS or ND U22FSR-L

CAUTION:

* *The use of spark plug of incorrect size or heat range can cause serious engine damage.*

1. Disconnect the spark plug cap.
2. Clean any dirt from around the spark plug base.
3. Remove the plug with the wrench provided in the tool kit.
4. Visually inspect the spark plug electrodes for wear. The center electrode should have square edges and the side electrode should not be eroded. If

the electrodes and insulator tip appear unusually fouled or burned, we suggest that you contact an authorized Honda dealer. Discard the spark plug if there is apparent wear or if the insulator is cracked or chipped.

5. Make sure that the spark plug gap is 0.6–0.7 mm (0.024–0.028 in) using a wire-type feeler gauge. If adjustment is necessary, bend the side electrode (1) carefully.
6. With the plug washer attached, thread the spark plug in by hand to prevent cross-threading.
7. Tighten a new spark plug 1/2 turn with the spark plug wrench to compress the washer. If you are reusing a plug, it should only take 1/8–1/4 turn after the plug seats.

CAUTION:

* *The spark plug must be securely tightened. An improperly tightened plug can become very hot and possibly damage the engine.*

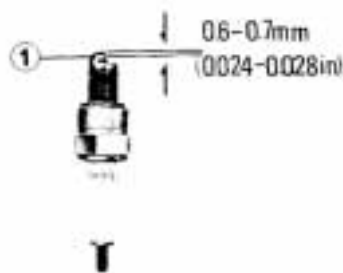

① Bend side electrode to adjust gap

AIR CLEANER MAINTENANCE

The air filter element accumulates dust and must be cleaned periodically. If the ATC 70 is ridden in unusually dusty areas, the filter element must be cleaned at more frequent intervals than specified in the MAINTENANCE SCHEDULE.

1. Remove the bolt ① and air cleaner cover ②.
2. Remove the filter element from the air cleaner case.
3. Remove air filter element tube ⑤ and support ④ from filter element ③.
4. Wash the filter element in non-flammable or high flash point solvent and allow it to dry thoroughly.

WARNING

Never use gasoline or low flash point solvents for cleaning the air cleaner element. A fire or explosion could result.

5. Soak the filter element in clean gear oil (SAE 80 ~ 90), then squeeze out the excess.
6. Reassemble the filter in the reverse order of disassembly.

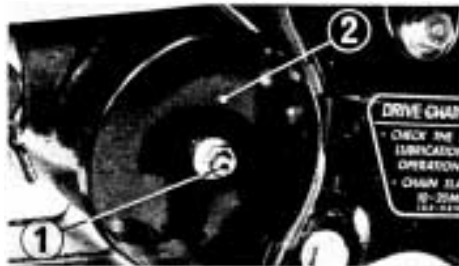

① Bolt ② Air cleaner cover

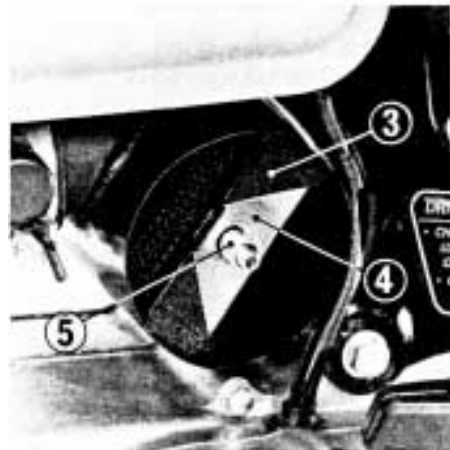

③ Filter element ⑤ Filter element tube
④ Support

THROTTLE CABLE INSPECTION AND ADJUSTMENT

Inspect the condition and operation of the throttle cable. The throttle cable must not impair smooth operation of the throttle lever in any steering position. Reroute the cable if it is improperly installed. Replace the cable if it has become worn or kinked.

Lubricate the throttle cable with a commercially available cable lubricant to prevent premature wear and corrosion.

Free play, measured at the tip of the throttle lever, should be maintained at 5~10 mm (3/16 ~ 3/8 inch).

The adjusting nut is located at the top of the carburetor, against the end of the throttle cable housing. Slide the rubber sleeve ① back to expose the throttle cable adjuster ②. Turn the adjuster until the specified free play is obtained. Reinstall the sleeve after adjustment.

NOTE:

* Note the band positions when removing them.

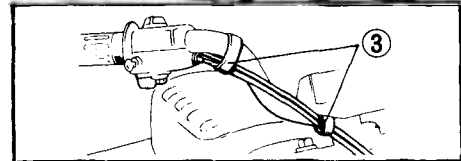
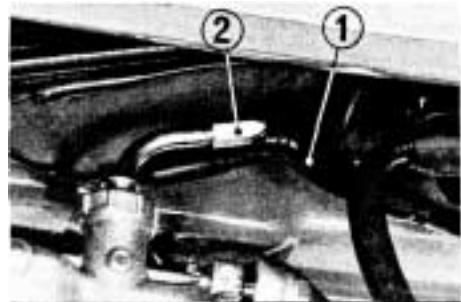

① Rubber sleeve ② Throttle cable adjuster
③ Bands

CARBURETOR ADJUSTMENT

NOTE:

Before making adjustments to the carburetor, be sure the ignition system is functioning properly and the engine has good compression. Do not attempt to compensate for other faults by carburetor adjustment.

Perform the carburetor adjustment as specified in the maintenance schedule.

To adjust the carburetor.

1. Start the engine and warm it up to operating temperature.
2. Set the idle speed to 1,500rpm with the throttle stop screw ①.

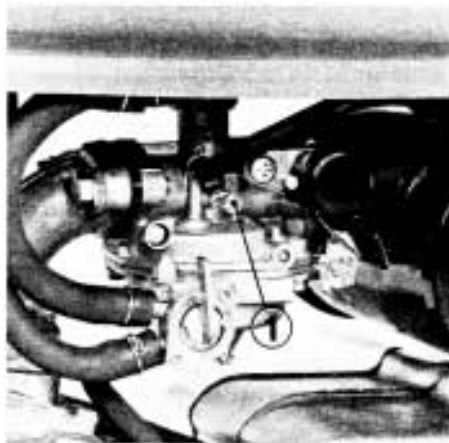

① Throttle stop screw

FUEL STRAINER MAINTENANCE

The fuel strainer is on the left side of the carburetor body. The fine mesh screen of the strainer prevents dirt from entering the carburetor passages.

Dirt which accumulates at the filter must be removed periodically, or the fuel flow will eventually be restricted.

WARNING

- Gasoline is extremely flammable and explosive under certain conditions.
- Gasoline is harmful or fatal if swallowed. Avoid repeated or prolonged contact with skin or breathing of vapor. Keep out of reach of children. If gasoline is swallowed, do not induce vomiting. Call a physician immediately.

1. Turn the carburetor fuel valve to OFF.
2. Remove the two screws which retain the fuel valve, and remove the fuel valve.
3. Remove the neoprene O-ring ② and the filter screen ①
4. Wash the filter screen in non-flammable or high flash point solvent.

WARNING

- * Never use gasoline or low flash point solvents for cleaning the air cleaner element. A fire or explosion could result.
5. Reassemble in the reverse order of disassembly.
 6. Turn the carburetor fuel valve ON and check for leaks at the fuel strainer cover. Correct if necessary.

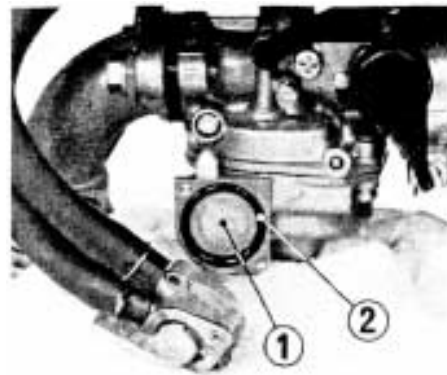

① Filter screen ② O-ring seal

CAM CHAIN ADJUSTMENT.

An improperly adjusted cam chain will rattle and be noisy, and will adversely affect the engine. Adjust tension while the engine is idling and the parking brake is locked ON.

1. To adjust, loosen the lock nut ① and tensioner adjusting bolt ② approximately one half turn.
2. If the chain is still noisy even after adjustment, loosen the 14 mm sealing bolt located on the left bottom side of the crankcase, and turn in the tensioner bolt ③ gradually until the cam chain becomes quiet. After completing the adjustment, tighten the tensioner adjust bolt, lock nut, and 14 mm sealing bolt securely.

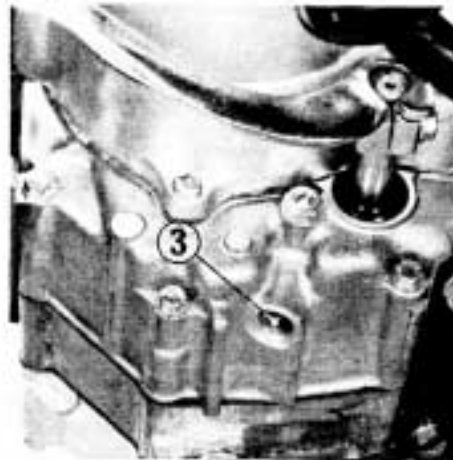
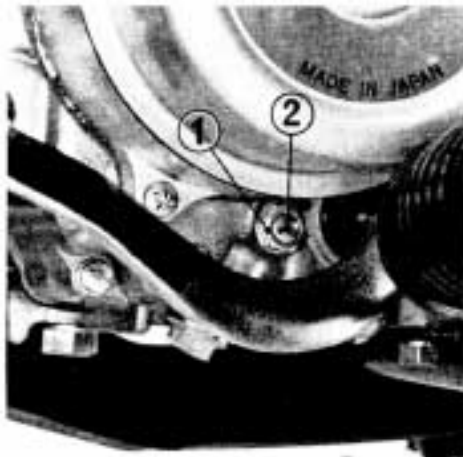

① Lock nut ② Tensioner adjusting bolt ③ Tensioner bolt

CLUTCH ADJUSTMENT

1. Make sure the ignition switch is off.
2. Loosen the lock nut ② , and turn the clutch adjuster ① counterclockwise until you feel resistance. Then turn 1/8 to 1/4 turn clockwise, and tighten the lock nut to hold the adjuster in this position.
3. After adjustment, start the engine and test ride the **ATC 70** to be certain that the clutch is operating properly. ↵

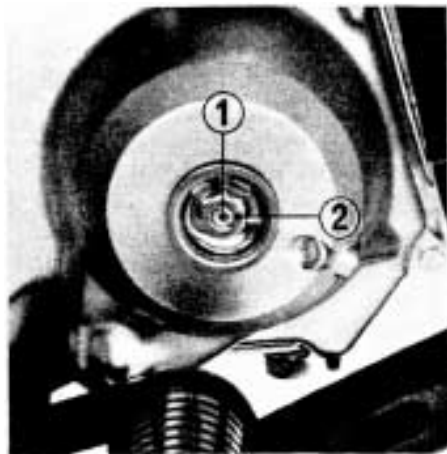

① Clutch adjuster ② Lock nut

SPARK ARRESTER MAINTENANCE

The exhaust system spark arrester must be periodically purged of accumulated carbon.

1. Remove the spark arrester bolt ① and slide the spark arrester ② out.

⚠ WARNING

The exhaust system becomes **VERY HOT** even after short periods of engine operation.

2. Clean the arrester of accumulated carbon.
3. Start the engine, and purge accumulated carbon from the system by momentarily revving up the engine several times.

⚠ WARNING

To avoid fire hazards, **DO NOT** perform this maintenance in the vicinity of flammable materials.

4. Stop the engine and allow the exhaust pipe to cool.
5. Reinstall the spark arrester with the bolt.



① Spark arrester bolt ② Spark arrester

TRANSPORTING THE ATC

FUEL

1. When transporting your ATC, turn the fuel valve and fuel vent valve OFF to prevent fuel leakage.

WARNING GASOLINE IS FLAMMABLE AND EXPLOSIVE UNDER CERTAIN CONDITIONS. ALWAYS STOP THE ENGINE, AND DO NOT SMOKE OR ALLOW FLAMES OR SPARKS NEAR THE ATC WHEN DRAINING OR REFUELING.

2. Place the drain tube in a suitable gasoline container.
3. With the fuel valve and fuel vent valve OFF, turn the carburetor drain screw counterclockwise.
4. When all the fuel has drained, retighten the screw.

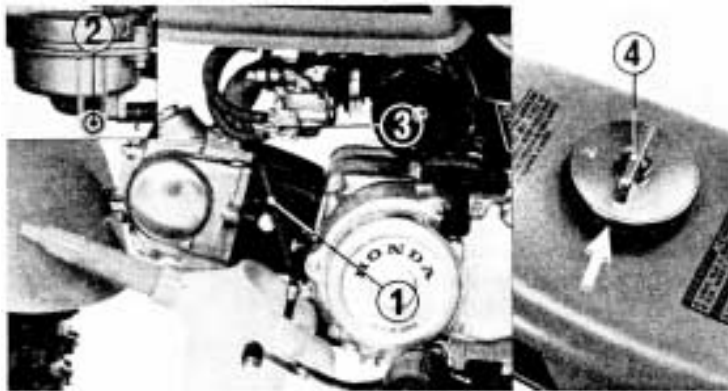

- ① Drain tube
② Drain screw

- ③ Fuel valve
④ Fuel vent valve

TRANSPORTING THE ATC (Continued)

Rear Wheel Removal

1. Place a support block under the vehicle and raise the rear wheel off the ground.
2. Loosen the wheel nuts (1) with a 12 mm socket wrench.
3. Remove the wheel.

Installation Note:

When reinstalling the rear wheels, make sure to torque the wheel nuts to 19–25 N·m (1.9–2.5 kg·m, 14–18 ft·lb).



① Wheel nuts

TRANSPORTING THE ATC (Continued)

REMOVING THE FRONT WHEEL

If limited carrying space requires removal of the front wheel, follow this procedure:

1. Remove the cotter pin ① securing the front axle nut.
2. Remove the washer ③ and axle nut ②.
3. Pull out the axle and then remove the front wheel.

NOTE:

Cover the wheel hub as soon as the axle has been removed to prevent the entry of dirt.

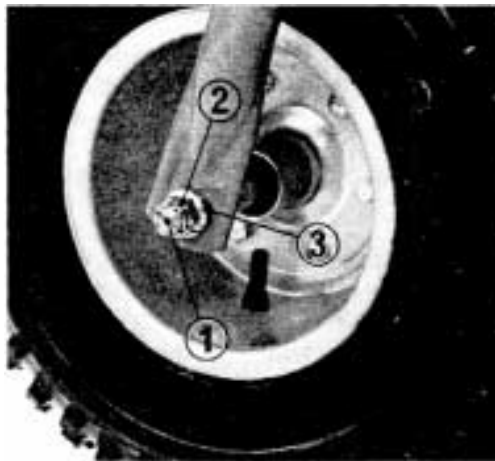

① Cotter pin ② Axle nut ③ Washer

INSTALLING THE FRONT WHEEL

Reinstall the front wheel in the reverse order of disassembly, and torque the axle nut to 60–80 N·m (6.0–8.0 kg·m, 43–57 ft·lb).

NOTE:

When the front axle is reinstalled, be careful that the grease seal is not cut or damaged.

Always replace used cotter pins with new ones. To reduce the hazard of snagging the ends of the cotter pins, while the ATC is operated, we recommend that the projecting ends of the front axle cotter pins be cut close to the axle nut, as illustrated.

WARNING BE CERTAIN THAT THE AXLE NUT IS TIGHTENED AND SECURED BY A COTTER PIN. IF IT IS NOT, THE WHEEL MAY COME LOOSE DURING OPERATION.

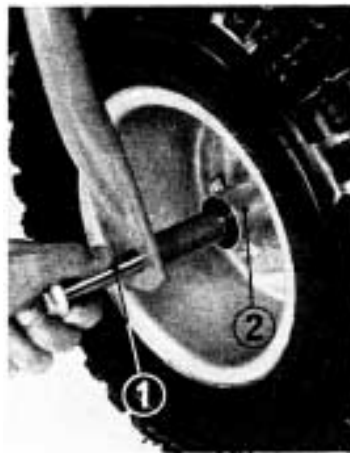

① Front Axle ② Wheel Hub

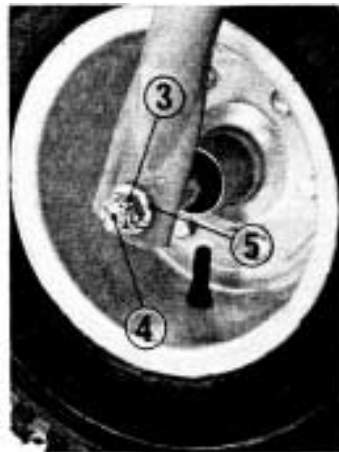

③ Axle Nut ④ Cotter Pin
⑤ Washer

STORAGE

To store the ATC:

1. Completely clean all parts of the ATC. If the ATC has been exposed to sea breeze or salt water, wash it with fresh water and wipe dry.
2. Drain the gasoline from the fuel tank and the carburetor.

WARNING

- * **Gasoline is flammable and is explosive under certain conditions. Do not smoke or allow flames or sparks near the equipment while draining fuel.**
3. Change the engine oil.
 4. Position the piston at the top of the compression stroke. This can be determined by pulling the starter rope until compression is felt.

5. Inflate the tires to the normal pressure and place the ATC on suitable blocks to raise the tires off the ground.
6. Cover the ATC with a dust cover (don't use plastic or other coated material).
7. Store in an area which is free of humidity and dust.

OPTIONAL PARTS

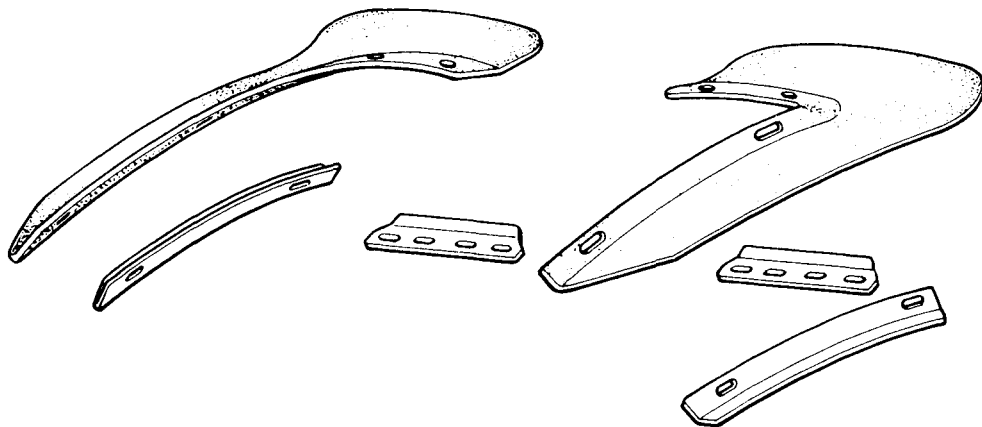

Rear mud guard

NOISE EMISSION CONTROL SYSTEM (USA ONLY)

TAMPERING WITH THE NOISE CONTROL SYSTEM IS PROHIBITED: Federal law prohibits the following acts or the causing thereof: (1) The removal or rendering inoperative by any person, other than for purposes of maintenance, repair, or replacement, of any device or element of design incorporated into any new vehicle for the purpose of noise control prior to its sale or delivery to the ultimate purchaser or while it is in use; or (2) the use of the vehicle after such device or element of design has been removed or rendered inoperative by any person.

AMONG THOSE ACTS PRESUMED TO CONSTITUTE TAMPERING ARE THE ACTS LISTED BELOW:

1. Removal of, or puncturing the muffler, baffles, header pipes or any other component which conducts exhaust gases.
2. Removal of, or puncturing of any part of the intake system.
3. Lack of proper maintenance.
4. Replacing any moving parts of the vehicle, or parts of the exhaust or intake system, with parts other than those specified by the manufacturer.

SPECIFICATIONS

DIMENSIONS

Overall length	1,300 mm (51.2 in)
Overall width	800 mm (31.5 in)
Overall height	800 mm (31.5 in)
Wheelbase	895 mm (35.2 in)

WEIGHT

Dry weight	77 kg (169.8 lbs)
----------------------	-------------------

CAPACITIES

Engine oil	0.8 ℓ (0.8 U.S. qt)
Fuel tank	4.3 ℓ (1.1 U.S. gal)
Reserve fuel	0.8 ℓ (0.2 U.S. gal)

ENGINE

Bore and stroke	47.0 x 41.4 mm (1.850 x 1.630 in)
---------------------------	--------------------------------------

Compression ratio	7.5 : 1
Displacement	72 cc (4.4 cu. in)
Contact breaker point gap .	0.3 ~ 0.4 mm (0.012 ~ 0.016 in)
Spark plug gap	0.6 ~ 0.7 mm (0.024 ~ 0.028 in)
Valve tappet clearance . .	0.05 mm (0.002 in)

CHASSIS AND SUSPENSION

Caster angle	20°
Trail length	32 mm (1.26 in)
Tire size, front and rear . .	16 x 8.0 - 7

POWER TRANSMISSION

Primary reduction	4.058
Final reduction	2.769
Gear ratio, 1st	3.273
2nd	1.938
3rd	1.350
4th	1.043

WIRING DIAGRAM

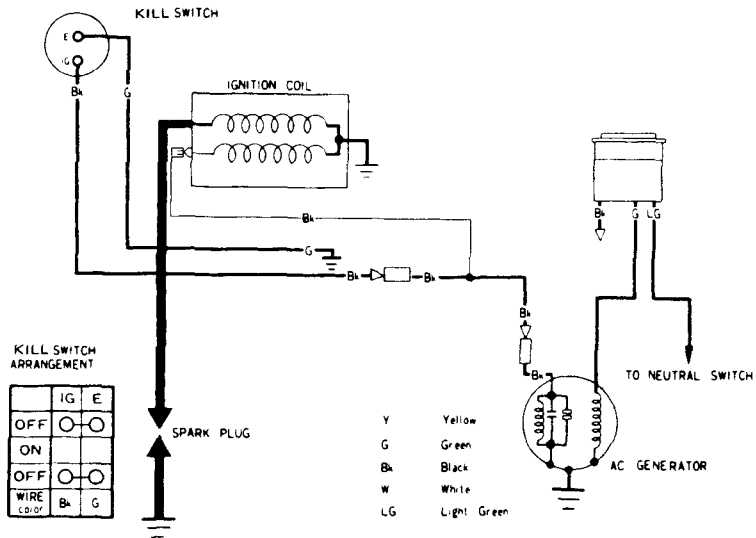

Warranty Service

Owner Satisfaction

Your satisfaction and goodwill are important to your dealer and to us. All Honda warranty details are explained in the Distributor's Limited Warranty. Normally, any problems with the product will be handled by your dealer's service department. Sometimes, however, in spite of the best intentions of all concerned, misunderstandings can occur. If your problem has not been handled to your satisfaction, we suggest you take the following action:

- Discuss your problem with a member of dealership management. Often complaints can be quickly resolved at that level. If the problem has already been reviewed with the Service Manager, contact the owner of the dealership or the General Manager.
- If your problem still has not been resolved to your satisfaction, contact the Motorcycle and Power Products Customer Relations Department at the regional office of American Honda Motor Co., Inc. in your area. Regional office locations are shown on the following page. We will need the following information in order to assist you:
 - Your name, address, and telephone number
 - Product model and serial number
 - Date of purchase
 - Dealer name and address
 - Nature of the problem

After reviewing all the facts involved, you will be advised of what action can be taken. Please bear in mind that your problem will likely be resolved at the dealership, using the dealer's facilities, equipment, and personnel, so it is very important that your initial contact be with the dealer.

Your purchase of a Honda product is greatly appreciated by both the dealer and American Honda Motor Co., Inc. We want to assist you in every way possible to assure your complete satisfaction with your purchase.

31957610
PRINTED IN USA