

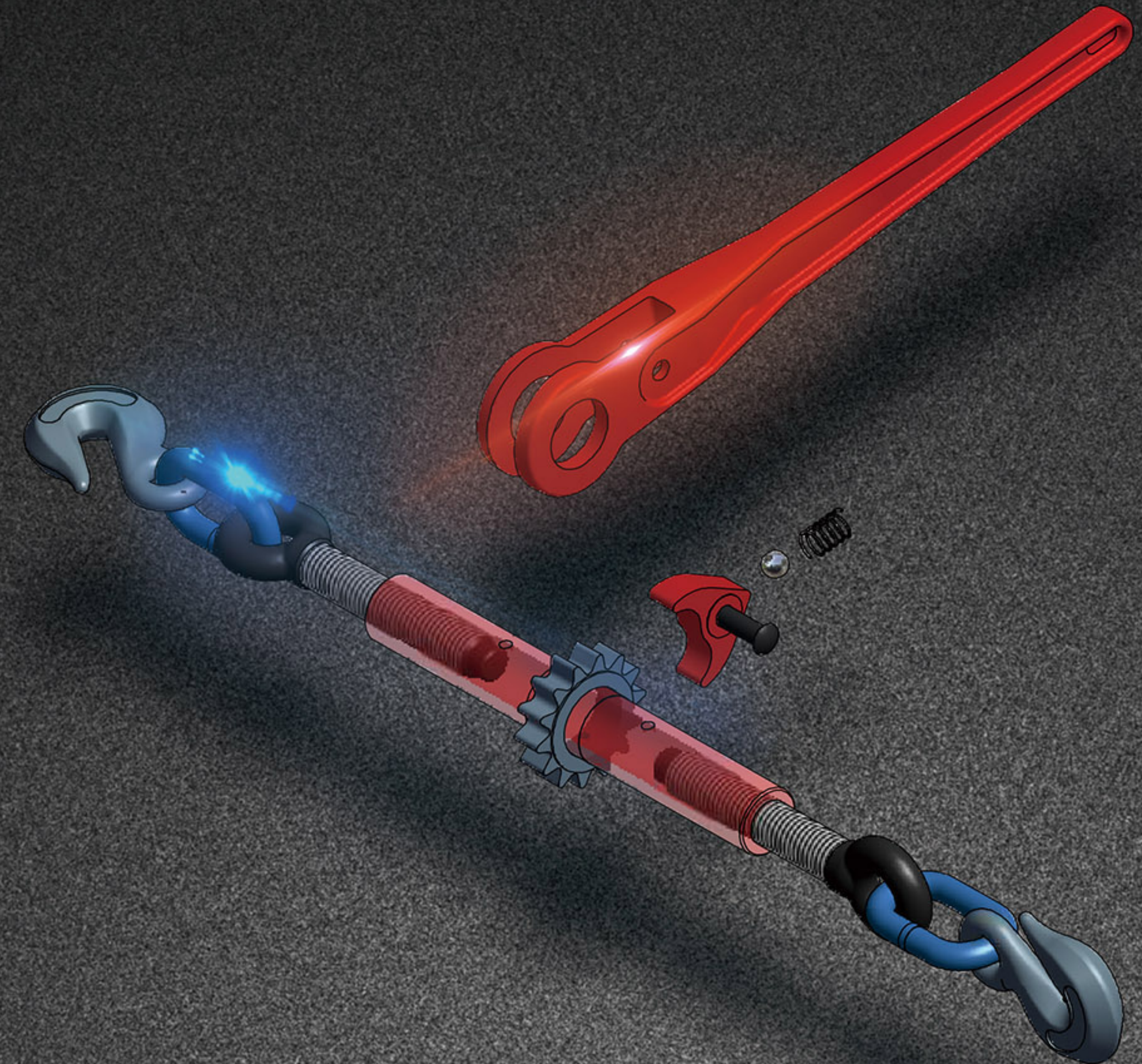

LOAD BINDER

Qingdao Qinde Rigging Hardware Co., Ltd.



Qingdao QinDe Rigging Hardware co.,Ltd

FACTORY

No 1590 Wangsha Road, Qingdao, China, 266106

Tel: +86(0)532-87887928 Fax: +86(0)532-87888719

E-mail: willisfan@qindeerigging.com

www.qinderigging.com



Qinde Rigging USA Inc.

USA Office: 1470 Rolling Knoll Road, Diamond Bar, CA, 91765

Tel: (909) 895 6922

Mobile: (909) 992 9327

E-mail: qinderigging@gmail.com

www.qdrig.com



We are the member of AWRE and WSTDA

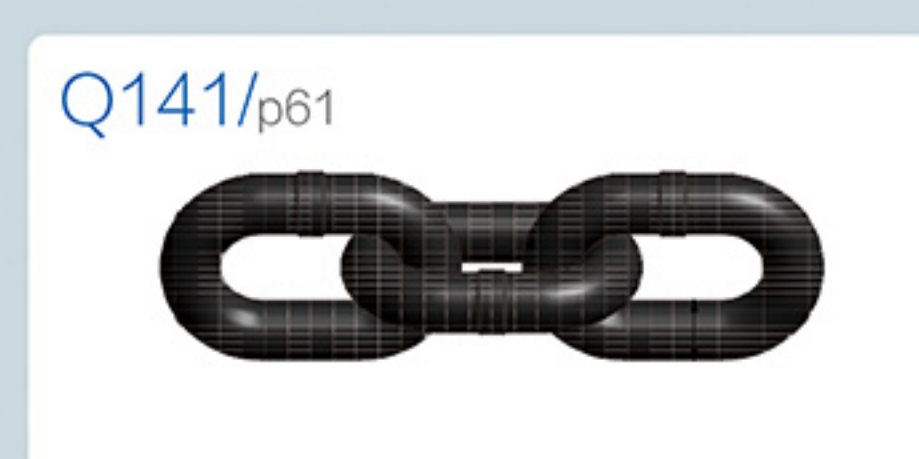
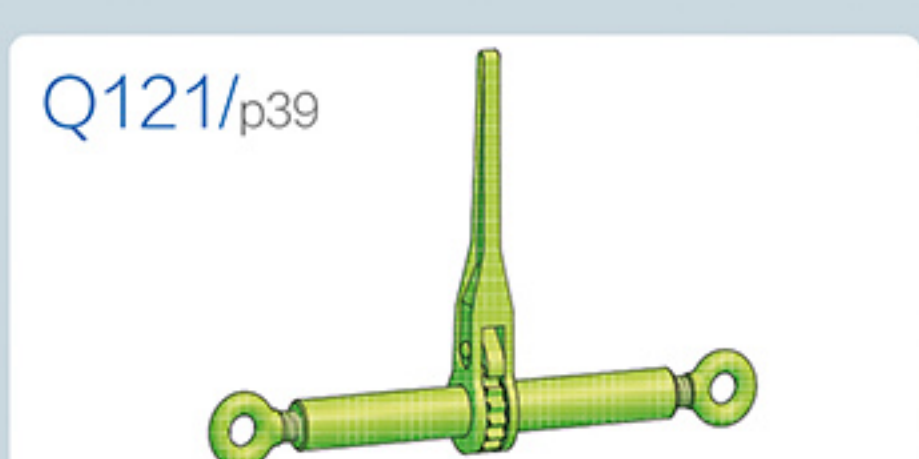
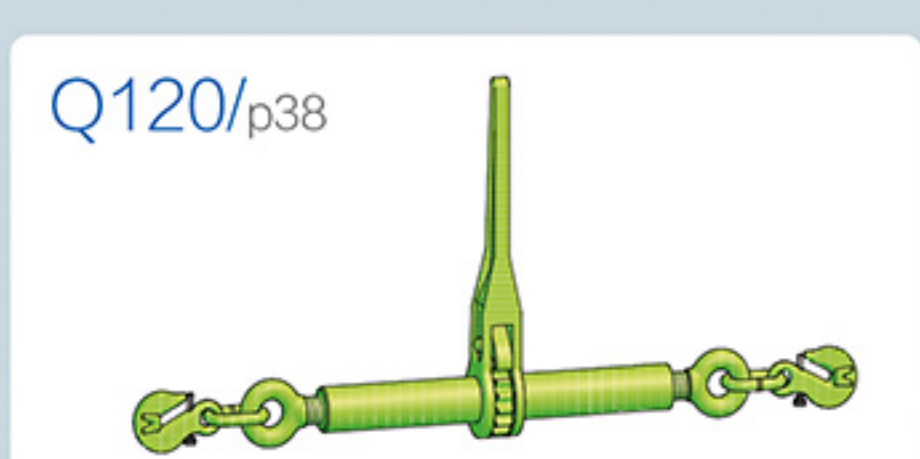
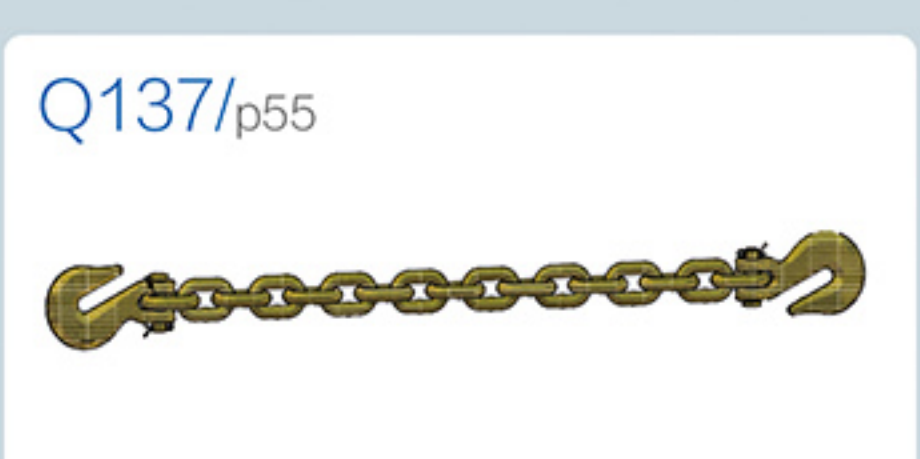
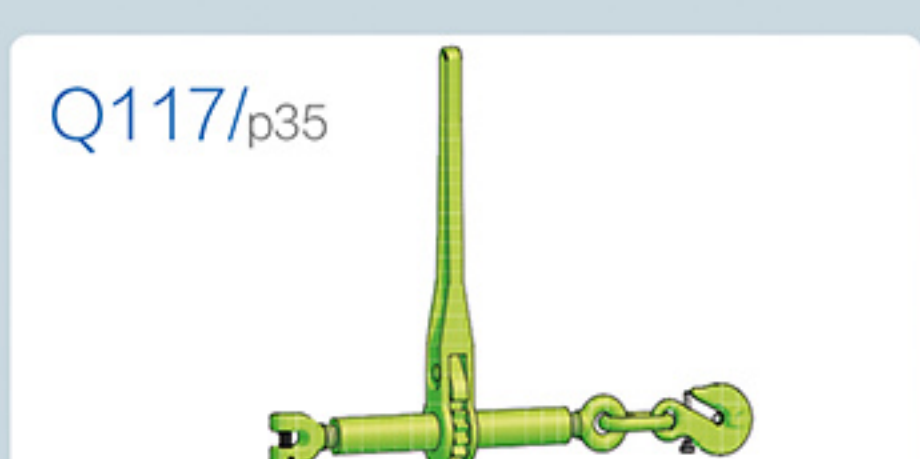
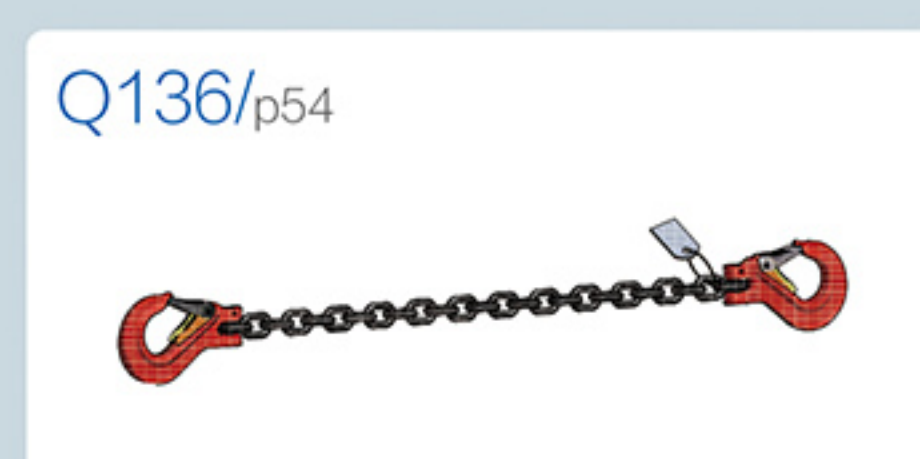
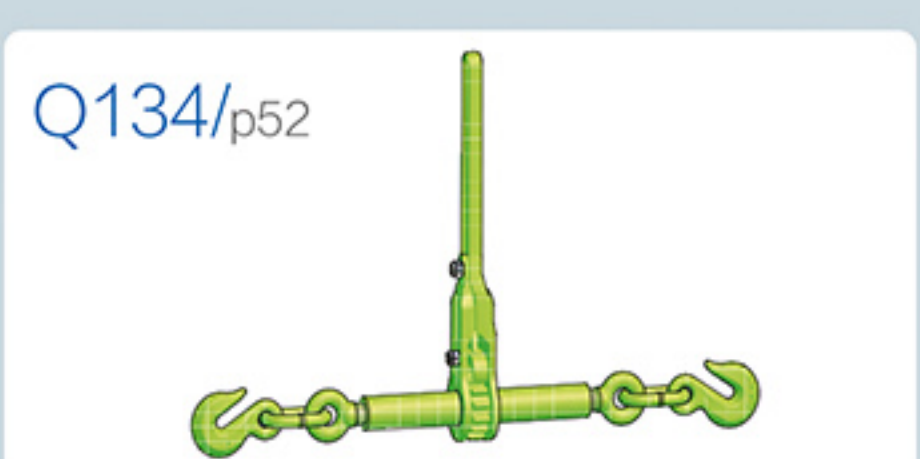
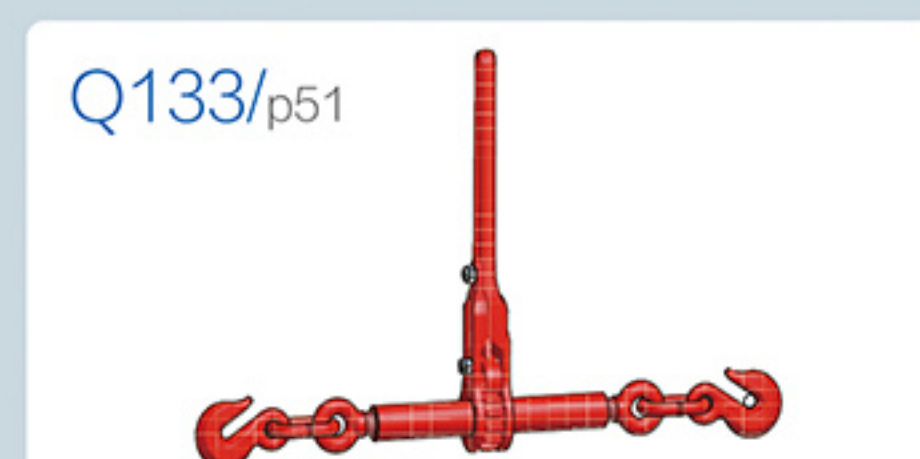
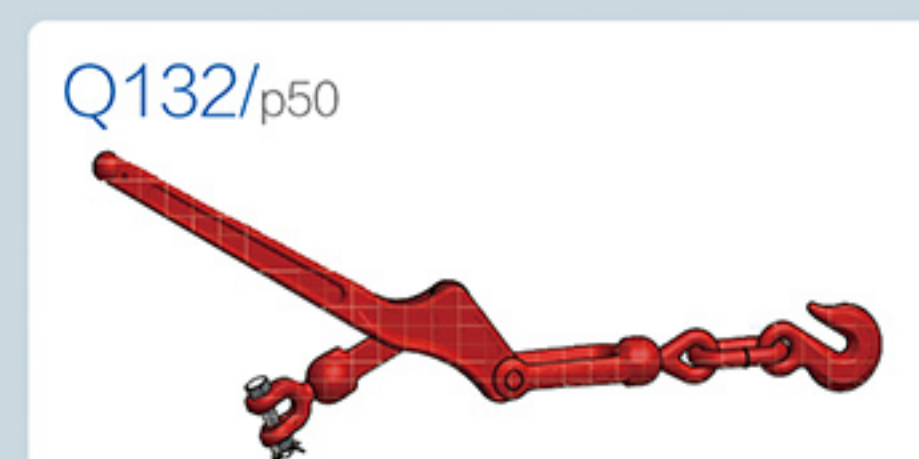
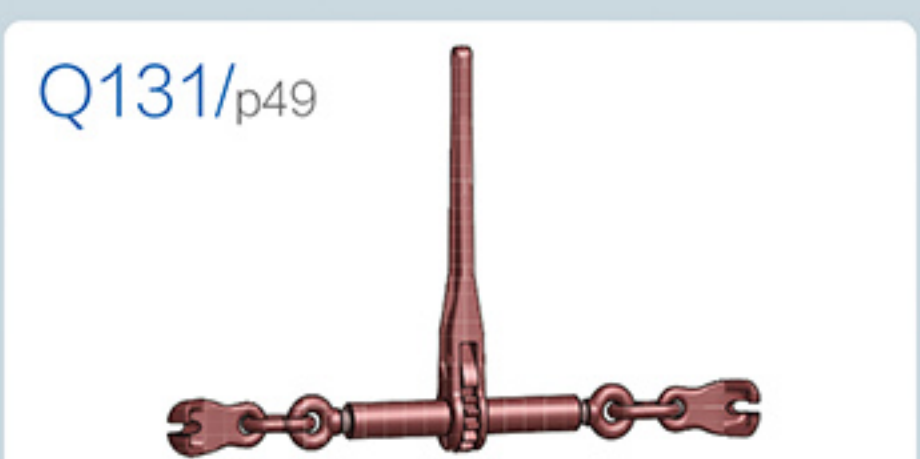
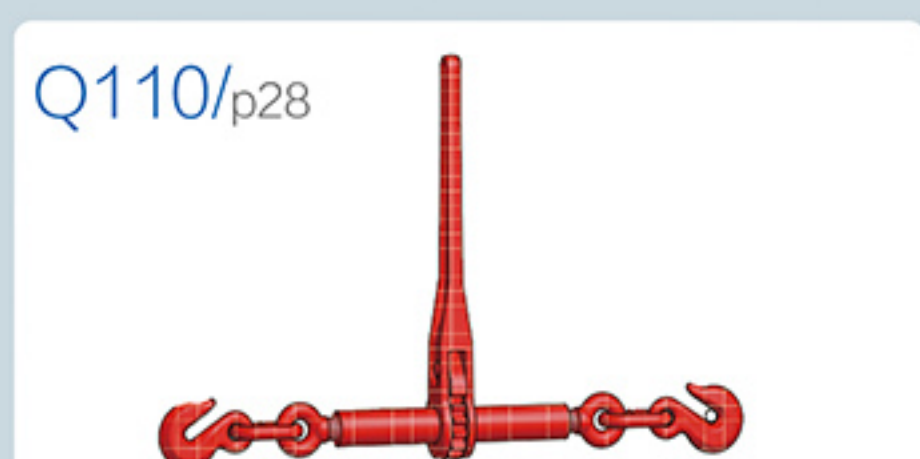
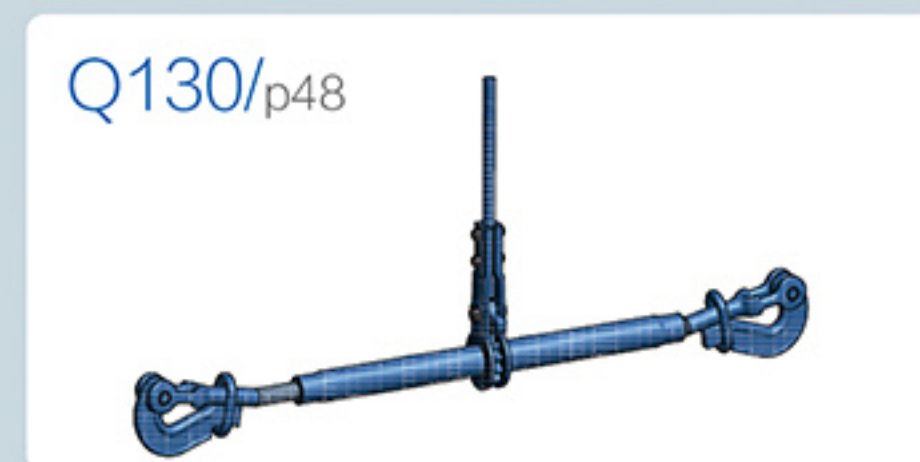
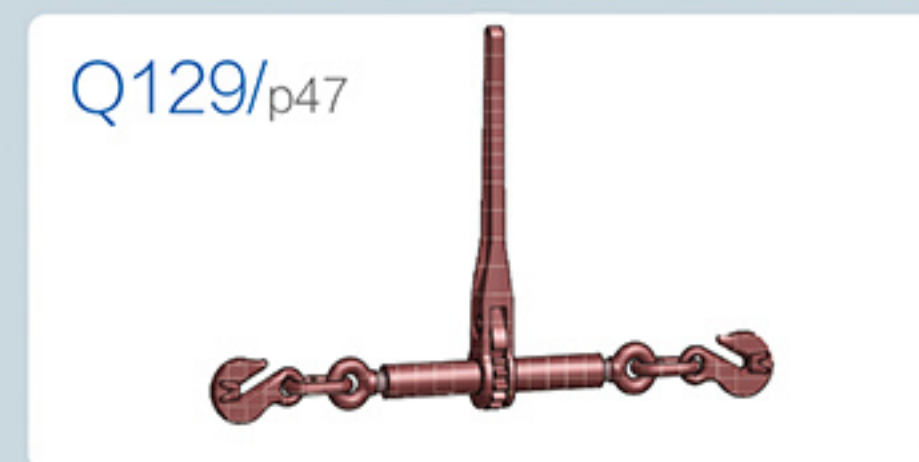
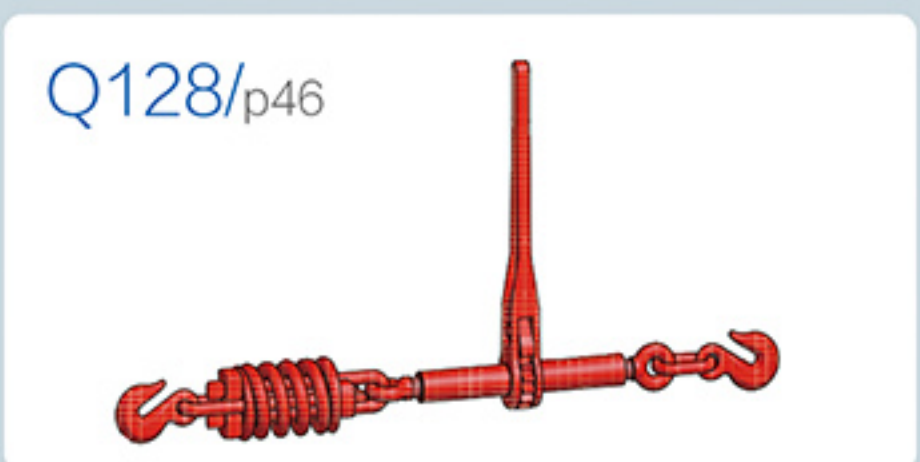
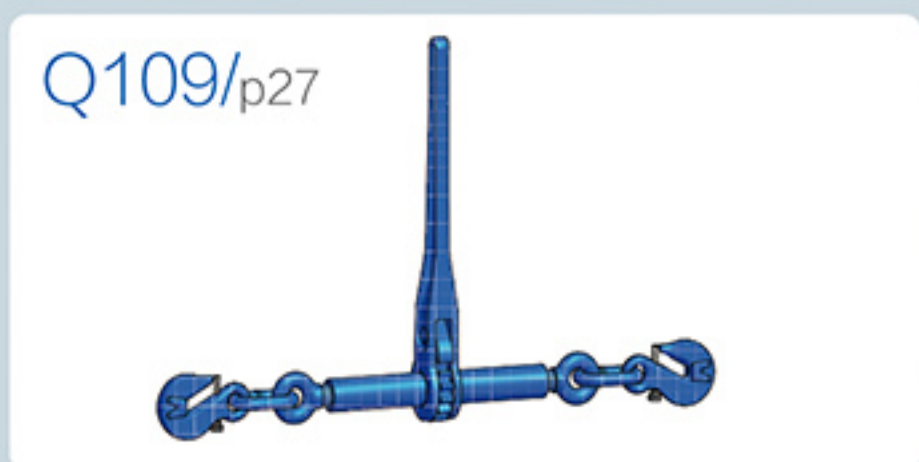
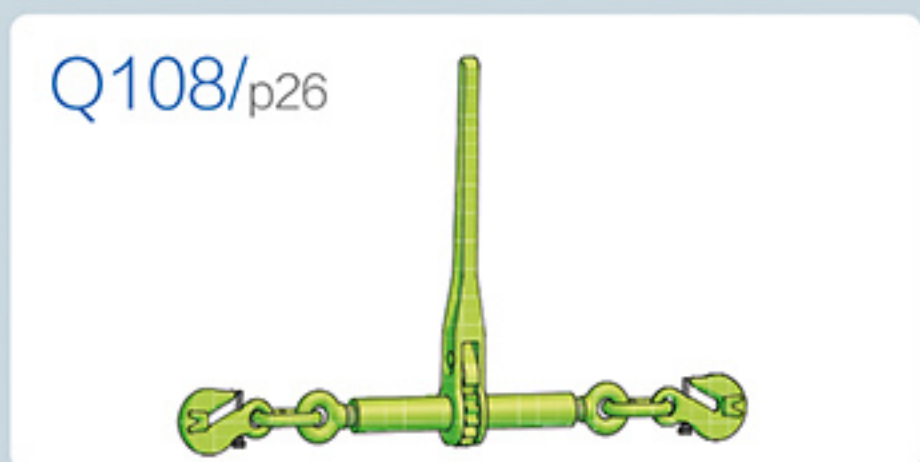
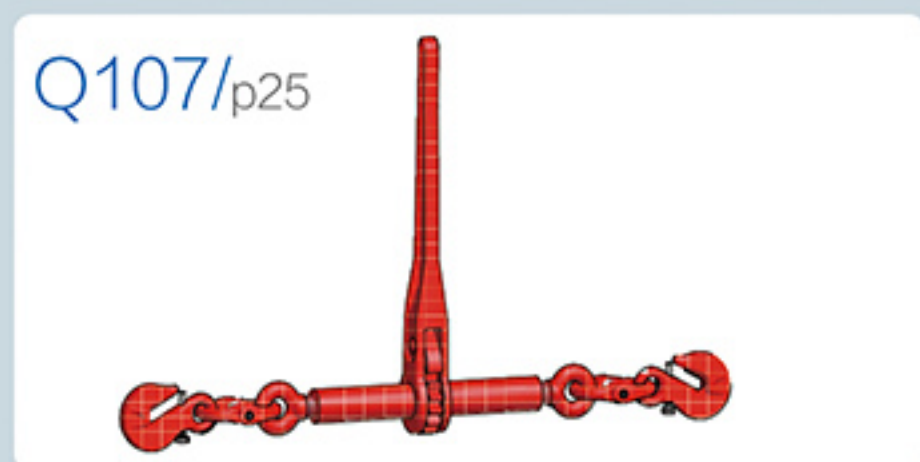
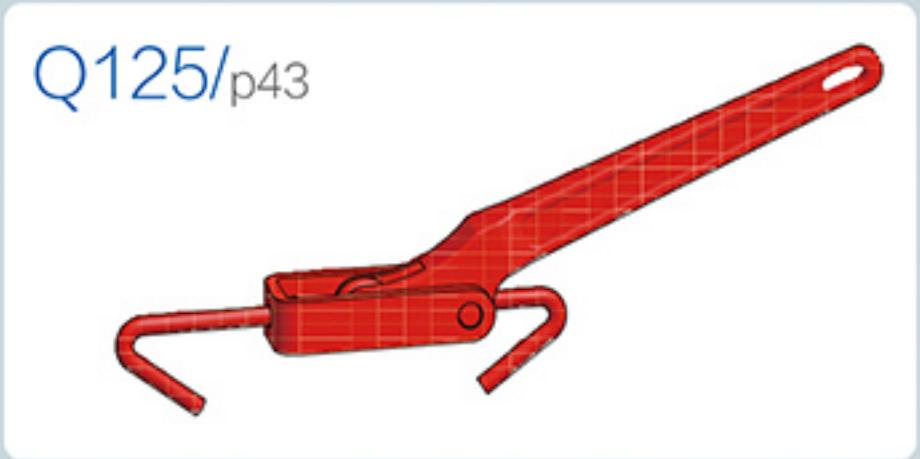
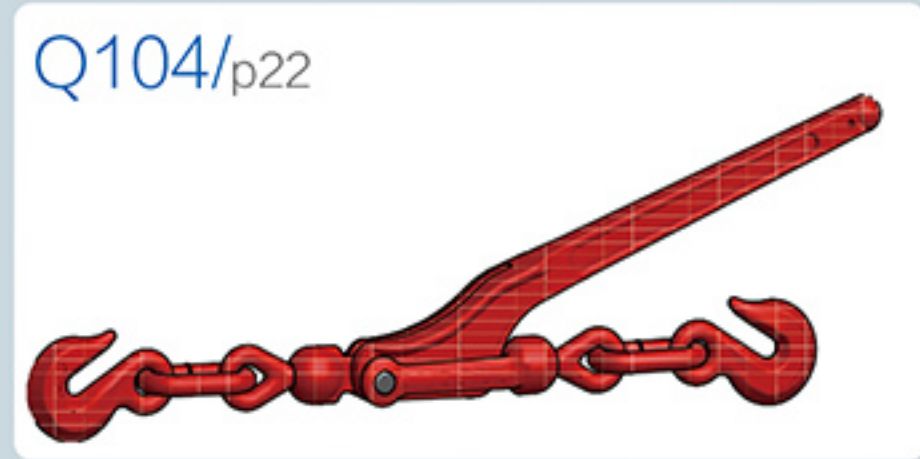
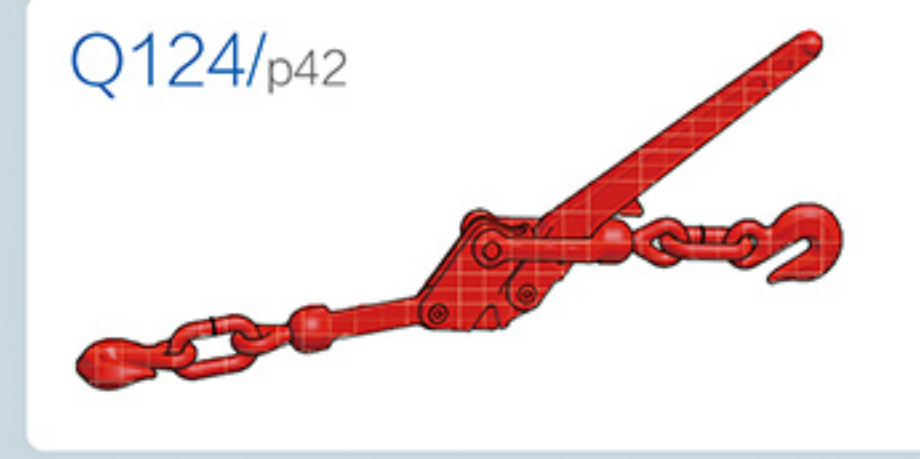
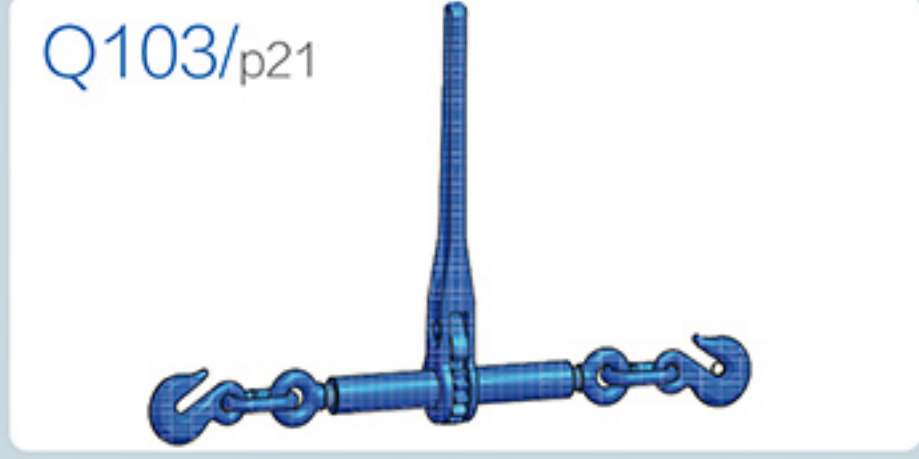



Qingdao QinDe Rigging Hardware Co., Ltd

QINGDAO QINDE RIGGING HARDWARE COMPANY LIMITED was established in 1988 and it is a leading manufacturer of Load Binders, Shackles, Hooks, Turnbuckles, cargo control and other Wire Rope and Chain Fitting products.

The company is located in Qingdao city of China, owns more than 100 staffs and workers, has got 50KJ CNC Air Hammer, 1000T forged pressing machine workplace, 630T forged pressing machine workplace, 400T forged pressing machine workplace, 300T forged pressing machine workplace and 160T forged pressing machine workplace. All the forged dies are made by our own tooling workplace.



QINGDE FAN
FOUNDER/OWNER

As a proof of our consistent work to maintain a high standard of quality QINGDAO QINDE RIGGING HARDWARE COMPANY LIMITED was certified in accordance with the ISO 9001-2015 standard in 2016.

QINGDAO QINDE RIGGING HARDWARE COMPANY LIMITED has effectively identified distributors to market product on overseers markets; we have established a close business relationship with some worldwide distributor because of our safe quality products and reasonable price. It is estimated that the products of us have dominated almost 60% of the United States and 30% of Europe markets.

To enlarge the US market and prompt the service, QinDe Rigging USA Inc the branch company of Qingdao QinDe Rigging Hardware founded in 2009, and became AWRF member in 2010 and WSTDA member in 2011. this will keep the company developing and growing.

Qingdao QinDe Rigging Hardware Co., Ltd

SAFETY SUPPLIER
SINCE 1988

Honorary Certificate

QUALITY **D**ECIDED RIGGING SUPPLIER
RELIABLE RIGGING EXPERT
YOUR TRUSTED BUSINESS PARTNER



We are the member of AWRF and WSTDA

DNV-GL

MANAGEMENT SYSTEM CERTIFICATE

Certificate No: 197528-2016-AQ-RCC-PLA Initial certification date: 19 April, 2016 Valid: 19 April, 2016 - 19 April, 2019

This is to certify that the management system of

Qingdao Qinde Rigging Hardware Co., Ltd.

Dong Ge Village, Xifu Town, Chengyang District, Qingdao, Shandong Province, P.R. China (Organization Code: 713774516)

has been found to conform to the Quality management system standard:

ISO 9001:2015

This certificate is valid for the following Scope:

Manufacture of Riggings

Place and Date: Shanghai, 20 April, 2016

The IAF is a signatory to the IAF MLA

For the issuing office: DNV GL - Business Assurance, Suite A, Building 5, No.1391 Hongqiao Road, Chengyang District, Shanghai 200336, P.R. China. TEL: +86 21 22050518

Check 11 Management Representative

Links of full text of conditions as set out in the Certification Agreement may be found on the Certificate holder's website: www.dnv-gl.com. The validity of the certificate can be checked through the DNV website in China: www.dnv.com.cn. DNV-GL

DNV-GL

管理体系认证证书

证书编号: 197528-2016-AQ-RCC-PLA 首次认证日期: 2016年4月19日 有效期至: 2016年4月19日至2019年4月19日

兹证明

青岛勤德索具有限公司

中国山东省青岛市城阳区城阳镇董葛村 (组织机构代码: 713774516)

质量管理体系符合:

ISO 9001:2015 标准

此证书对下列产品及服务范围有效:

索具的制造

颁发日期: 2016年4月20日

The IAF is a signatory to the IAF MLA

对于签发办公室: DNV GL - 商业质量保证, 上海虹桥路1391号A座, 城阳区长阳路, 上海200336, 中国。电话: +86 21 22050518

检查11 管理代表

本证书持有者可在其网站上找到认证协议的全文链接: www.dnv-gl.com.cn。本证书的有效性可通过DNV网站进行验证: www.dnv.com.cn。DNV-GL

QINGDAO QINDE RIGGING HARDWARE CO., LTD
 Dongge Village Xifu Town ChengYangDistrict- QingDao City ShanDong Province China
 TEL: 0086-532-87887929 FAX: 0086-532-87887927
 WEBSITE: www.qinde-rigging.com EMAIL: willis@qinde-rigging.com

Mill test certification

Test Certificate No. 20160817001 ORIGINAL OF CHINA

Description of Item Being Tested: 5/16"-3/8" RATCHET LOAD BINDER

Meets or exceeds DOT and CVSA Cargo Securement Tie-down Guideline

Mill PO Number: 17950
 Item: RBNDR375I
 PO Quantity: 800 PCS
 Test Quantity: 3 PCS
 Date of Test: 08/17/2016
 Federal Spec MBS: 26400 LBS
 Actual MBS: 27180 LBS, 27195 LBS, 27200 LBS
 Safe Working Load: 6600 LBS
 Proof Load: 13200 LBS
 BODY: 45#
 HOOK: 40Cr

C (%)	Si (%)	Mn (%)	P (%)	S (%)	Cr (%)	Ni (%)	Cu (%)
0.45	0.26	0.58	0.022	0.010	0.02	0.01	0.02

HOOK: 40Cr

C (%)	Si (%)	Mn (%)	P (%)	S (%)	Cr (%)	Ni (%)	Cu (%)
0.40	0.23	0.55	0.017	0.010	0.90	0.02	0.02

I certify that the above particulars are correct, and that the examination and test were carried out by a competent person.

(Signature:

青岛勤德索具有限公司性能实验室
PERFORMANCE TEST LABORATORY OF QINDE RIGGING HARDWARE CO., LTD.
专用章

Qin de QingDao Qinde Rigging Hardware Co.,Ltd
 Dongge Village Xifu Town ChengYangDistrict- QingDao City ShanDong Province China TEL: 0086-532-87887929
 Website: www.qinde-rigging.com FAX: 0086-532-87887927
 Mobile: 0086-13854293176 Email: willis@qinde-rigging.com qinderigging@gmail.com

TEST AND MATERIAL CERTIFICATE

Supplier: Qingdao Qinde Rigging Hardware Co., Ltd TEST NO.

Certificate 3.1

Order no: EN12195-3 G80 RATCHET LOAD BINDER WITH SAFETY PIN Date: 04/14/2016
 815408-1 1200 pcs
 Manufacturer code: QDF2016A0121 Purchaser: Delivery terms:

Item	Item no.	Cast no.	Marking	C%	Si%	Mn%	P%	Cr%
1	Body	LWCL45	WLL6300KGS 3/8 10MM	0.46	0.24	0.58	0.03	0.03
2	Hook	20CrMnTH	10-8	0.17	0.22	1.07	0.014	1.1

POWERTEX EN12195-3 G80 RATCHET LOAD BINDER description & Strength Characteristics

1	Material:	Body: 1045C, Hook: 20CrMnTH
2	Surface finish:	Red powder coated
3	Working Load Limit (WLL):	63 KN
4	Deformation load:	126 KN
5	Actual breaking force:	130 KN
6	Test date:	04/14/2016

The manufacturer confirms that the results of tests performed on the items supplied show that the above-listed parts comply with the order specifications.

Name/Date/Signature:

Company stamp:

1

Qin de QingDao Qinde Rigging Hardware Co.,Ltd
 Dongge Village Xifu Town ChengYangDistrict- QingDao City ShanDong Province China TEL: 0086-532-87887929
 Website: www.qinde-rigging.com FAX: 0086-532-87887927
 Mobile: 0086-13854293176 Email: willis@qinde-rigging.com qinderigging@gmail.com

Customer: WD Test Number: cp201686-3
 P.O.: WD15127 Test Date: 2016-08-06
 Part No.: Description: SI24520
 Spec: 3/8-1/2 Peak load(kN): 150.38
 Length: Test Duration(s): 30

Comment:

Test Results:
 Acceptable
 Not Acceptable

Conducted by: 邵格先

PICC 中国人民财产保险股份有限公司
 PICC Property and Casualty Company Limited

总公司设于北京 1949年创立
 Head Office: BEIJING Established in 1949

PRODUCTS LIABILITY INSURANCE POLICY

Policy NO: PZAI20163702000000027

Whereas the insured named in the Schedule hereto has made to PICC Property and Casualty Company Limited (hereinafter called "the Company") a written Proposal which together with any other statements made by the Insured for the purpose of this Policy is deemed to be incorporated herein and has paid to the company the premium stated in the Schedule.

Now this policy of insurance witnesses that subject to the terms and conditions contained herein or endorsed hereon the company shall indemnify the Insured for the legal liability incurred by the Insured during the period of insurance stated in the Schedule in the manner and to the extent hereinafter provided.

By PICC Property and Casualty Company Limited

Authorised Signature

Date of Issue: June 19th 2016
 Place of Issue: Qingdao City

This policy comprises mainly the Schedule, Scope of Cover, Exclusions, Treatment of Claim, Insured's Obligations, General Conditions and Special Provisions, including also the Proposal of Insurance together with its attachments as well as any additions to be made, from time to time, by the Company in the form of Endorsement.

印刷号: 201600007



FACTORY CNC FACILITIES

Qingdao Qinde Rigging Hardware Co., Ltd.



071



AUTOMATIC HEAT TREATMENT WORKSHOP

08



FORGING WORKSHOP





LOAD BINDER WORKSHOP



FACTORY FACILITIES

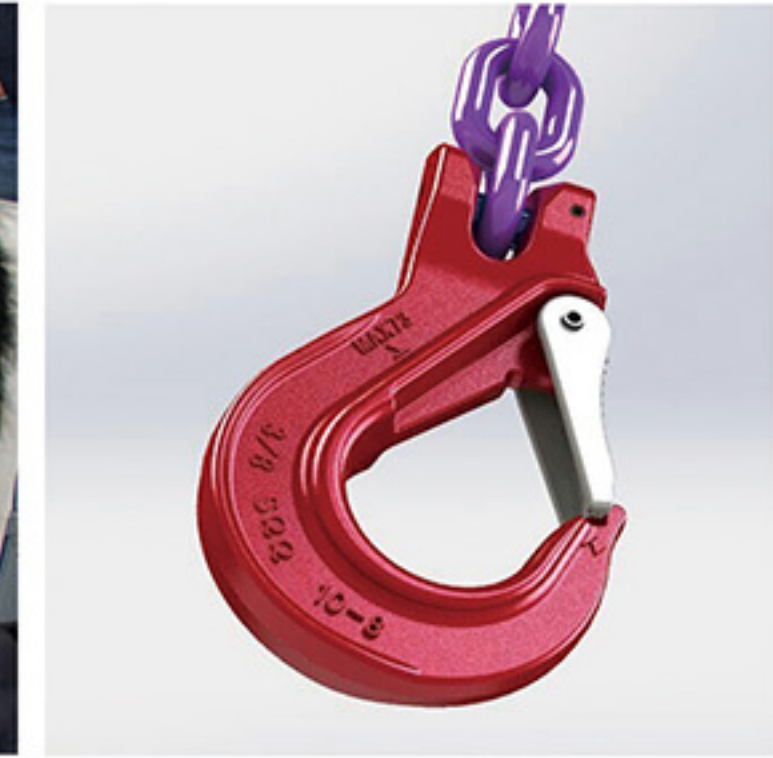

3D printer technology will make the development of new products much easy and more efficiency.



**1200TON
TESTING BED**



TESTING FACILITIES



-40 DEGREE CHARPY
TESTING MACHINE



CHEMICAL SPECTRUM



FATIGUE TESTING
MACHINE



200TON PULL TESTING
MACHINE



WAREHOUSE

SALES NETWORK

OUR MAJOR MARKET IS: NORTH AMERICA, WEST EUROPE, SCANDINAVIA, MIDDLE EAST AND AUSTRILIA



PACKING

