

# SPARKS

P.O. Box 342768 \* Memphis, Tennessee 38134-2768 \* Volume 23 \* June 2017



## Welcome to the Delta Amateur Radio Club

Visit our home on the web at: <http://www.deltaclub.org>

EMAIL: [darc4you@gmail.com](mailto:darc4you@gmail.com)

Facebook: <https://www.facebook.com/darcmem>

Newsletters: <http://www.deltaclub.org/sparks.html>

## W4BS

### REPEATER SYSTEM

146.820 <sup>-107.2</sup>	* 147.360 <sup>+107.2</sup>
146.625 <sup>-107.2</sup>	443.200 <sup>+107.2</sup>
224.420 <sup>-107.2</sup>	
144.390 Digipeater	*Fusion

**This month's meeting** begins at 7pm on June 13, 2017, at Ellendale Church of Christ, 7365 Highway 70 Memphis, TN (1 ½ miles north of Highway 64 (Stage Road)).

**In this month's program** we welcome David Campbell, KD4NOQ. David's topic will be about some of the certificates and QSL cards from special event stations he has worked over the years. He has a certificate from the International Space Station, and other interesting "wallpaper" such the one from NU5DE, a "Naturist Amateur Radio Club." David will explain the "naturist" context. David got his ticket in 1992, with his first radio being a refurbished Alinco DR-110 from a dealer at the Birmingham hamfest. When he passed his General, his dad gave him an FT-901DM HF rig and a G5RV antenna. He attended his first Central States weak signal conference in 1994 in Memphis and has been going to Mt. Nebo since about 1998. Although David admits most of the 1994 presentations were over his head, he was fired up to learn more about antennas, antenna ranges, homebrew microwave band radios, and other topics. David has helped Tri-State and Delta with antenna, feed line, and repeater work.

**Delta Club FCC testing sessions** are held monthly except December. Registration begins at 5:30 PM; testing begins by 6:00 PM. Please bring a photo ID and another form of identification, copies of existing licenses or CSCEs, and your FCC Registration Number (FRN) if one has been issued. Please be on time for registration to allow our Volunteer Examiner (VE) team to complete their work prior to the club meeting. The 2017 test fee is \$15 (cash or check). Individuals receiving their initial FCC license grant at a Delta Club test session or through a Delta Club training class will receive a complimentary individual club membership for the remainder of the current calendar year when they also show proof of ARRL membership. For more information, please email our VE Liaison, [Jeff Krause, AJ4GY](mailto:Jeff.Krause@AJ4GY), or call at 901-301-6776.

**Congratulations** to those who passed exams during Delta's May, 2017, test session: new Technician Kendell Camp, KG5TFT.

## President's Corner

Submitted by Ken Laseter, KI4AOH

Don't forget that FIELD DAY is the 24<sup>th</sup> and 25<sup>th</sup> of THIS MONTH. This year's FIELD DAY will be like no other you have ever seen. It will be bigger than last year, better, and more diverse than ever before. Again, this year we have four Amateur Radio Clubs and several different local, state, and federal agencies scheduled to participate. So, save the dates and plan to be a part of history in the making by volunteering. See the **Field Day, 2017** article for details on setup and operating schedules.

As always, please don't forget to check into the Delta Club information net on the 146.820 repeater at 8:00 pm each evening, and when you check-in, make sure to thank the net control operator for taking time from their family and busy schedule to call the net for us. They are some of our most valuable assets!

If you have not renewed your club membership now is the time. I think we still have some members that are procrastinating or have forgotten. Linda, KJ4CTX, will be glad to accept your renewal application and cash, check or money order, either at a club meeting or via snail mail.

See you at the meeting Tuesday night!

73

Kenneth Laseter  
KI4AOH

## Treasurer's Report

Submitted by Linda Laseter, KJ4CTX

### DELTA AMATEUR RADIO CLUB

#### Monthly Treasurer's Report

For month ended May 31, 2017

Submitted by Linda Laseter Treasurer

### CHECKING ACCOUNT

#### BEGINNING BALANCE

<b>BEGINNING BALANCE</b> as of May 01, 2017	<b>\$7,871.83</b>
---	-------------------

#### INCOME

Date		Amount	
05/05/17	Membership dues	\$ 20.00	
05/10/17	Huntsville bus trip	\$ 60.00	
05/10/17	Huntsville bus trip	\$ 600.00	
05/15/17	Huntsville bus trip	\$ 60.00	
05/17/17	Huntsville bus trip	\$ 240.00	
05/26/17	DARC shirt order checks	\$ 357.00	
05/30/17	Huntsville bus trip	\$ 60.00	
<b>TOTAL INCOME</b>		<b>\$ 1,397.00</b>	<b>\$ 1,397.00</b>

#### EXPENSES

Date	Check #	To	Description	Amount	
05/05/17	1415	Virginia Griffin	Estate equipment sales	\$ (2,176.00)	
05/09/17	1416	US Postal Service	PO box rental	\$ (83.00)	
5/15/2017	1417	Virginia Griffin	Estate equip purchase	\$ (1,300.00)	
<b>TOTAL EXPENSES</b>				<b>\$ (3,559.00)</b>	<b>\$ (3,559.00)</b>

<b>ENDING BALANCE</b> as of May 31, 2017	<b>\$ 5,709.83</b>
--	--------------------

#### CERTIFICATES OF DEPOSIT

	Maturity Date	Balance as of	
Certificate of Deposit #1	10/10/2018	4/29/2017	\$ 10,469.69
Certificate of Deposit #2	10/19/2022	3/31/2017	\$ 10,039.27

<b>TOTAL DARC CASH ASSETS</b>	<b>\$ 26,218.79</b>
-------------------------------	---------------------

**This Month's Board Meeting Minutes**  
June 6, 2017 -- Submitted by Barri Munday, WB4SWP

Attendees: Steve Frazier, KK4VPT, Barri Munday, WB4SWP, Bill Stevens, WC9S, Dan Lasley, NE7JN, Ken Laseter, KI4AOH, and Linda Laseter, KJ4CTX. Absent: Scott Adams, KM4PMU, Kevin Zent, K4KLZ, Len Grice, W4MKS, and Joe Lowenthal, WA4OVO.

Ken called the meeting to order at 7:00.

Linda gave the Treasurers Report.

The club polo shirts have come in and will be distributed at Tuesday's club meeting. Len will be taking orders for additional polo shirts. See **Delta Club Logo Shirts** later in the newsletter.

Bill Stevens discussed Field Day preparations and told us about some very old radio equipment and parts that were donated to the club.

Ken asked the board of directors to review the updated club by-laws with the idea of finishing our review, if possible, at the next board of directors meeting.

Several members of the board of directors are not planning to run for office in 2018 and the suggestion was made that we should begin to solicit club members for a position on the board.

The meeting adjourned at 7:30pm

## Minutes of Last Month's Club Meeting

May 9, 2017 – Submitted by Barri Munday, WB4SWP

Club President Ken Laseter, KI4AOH, opened the meeting at 7:00 pm and reminded everyone to sign in and drop a ticket in the bucket. Introductions were then made by name and call sign.

Ham Hilliard, W4GMM, moved to approve the previous meeting minutes as recorded in Sparks, seconded by Ned Savage, KA4BLL; the minutes were approved by acclamation.

Ham moved to approve the Treasurer's report as recorded in Sparks, second not recorded; the report was approved by acclamation.

Joe Lowenthal, WA4OVO, said his most recent testing session had six people in the class with all six passing the Tech exam and with two passing the General exam and one passing the Extra exam. The next Tech class is to be held on July 10th, probably at the EMHC ambulance training room. Joe also reminded us about the bus trip to Huntsville Hamfest in August. See the hamfest article later in the newsletter for details.

Bill Stevens, WC9S, told us he still has some estate items for sale. If they don't sell by end of the meeting tonight, he will take to the Hamvention in Xenia, Ohio. Bill also mentioned the Field Day planning meeting at Fire Station #4 on May 23 at 7:00pm. All hams are welcome to attend.

Pat Lane, W4OQG, spoke about the Armed Forces Day event on May 13th at NAS Millington from 8:30-3:00. The MARS frequency will be 5403.05 simplex.

With the upcoming Memorial Day holiday, Dan Lasley, NE7JN, honored those who served in the military.

Geoff Krause, AJ4GY, told us tonight's testing produced one new Tech, Kendell Camp, KG5TFT.

Ken and Len Grice, W4MKS, spoke about the club polo shirts people could try on and order tonight. We want to be able to wear them on Field Day.

Tonight's presentation was by Geoff Smith, KB9KQU. He spoke on his homebrewed Hentenna antenna.

Danny Banks, KJ4FXZ, won tonight's prize drawing: Chick-fil-A cards.

Ham moved to adjourn at 8:00pm.

## Last Month's Program

Submitted by Dan Lasley, NE7JN, contributions by Geoff Smith, KB9KQU

Geoff Smith, KB9KQU, provided the May program. His topic was "Hentenna, The 'Strange' Antenna." Geoff says this antenna, his first homebrewed model, has about 3 dB of gain and he pointed out that this figure is relative to a dipole (dBd) rather than to the lesser dBi (isotropic) value.

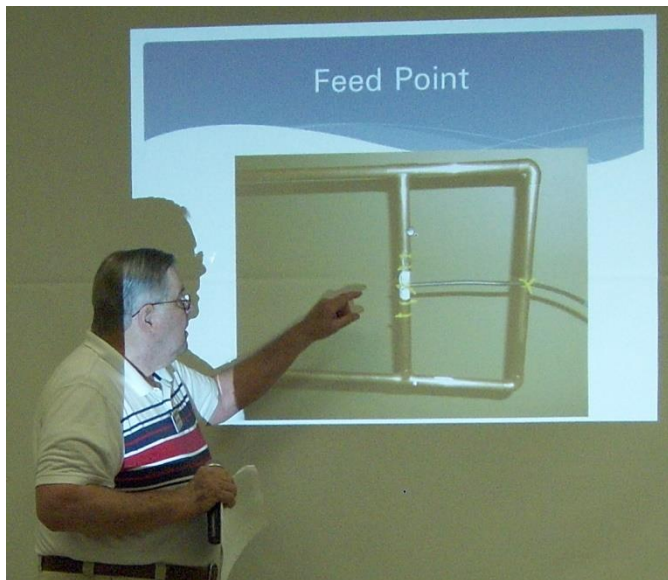

Geoff told us this antenna was developed by a couple of Japanese hams in the 1970s and was described by Koji Sugihara, JJ1UMS, in his February, 1982, QST article, "Let's Make the 'Hentenna'." The 'Strange' attribute refers to the non-obvious polarization. He said the antenna scales very predictably from one band to another.

Here he answers a question from the audience on the antenna feed point.

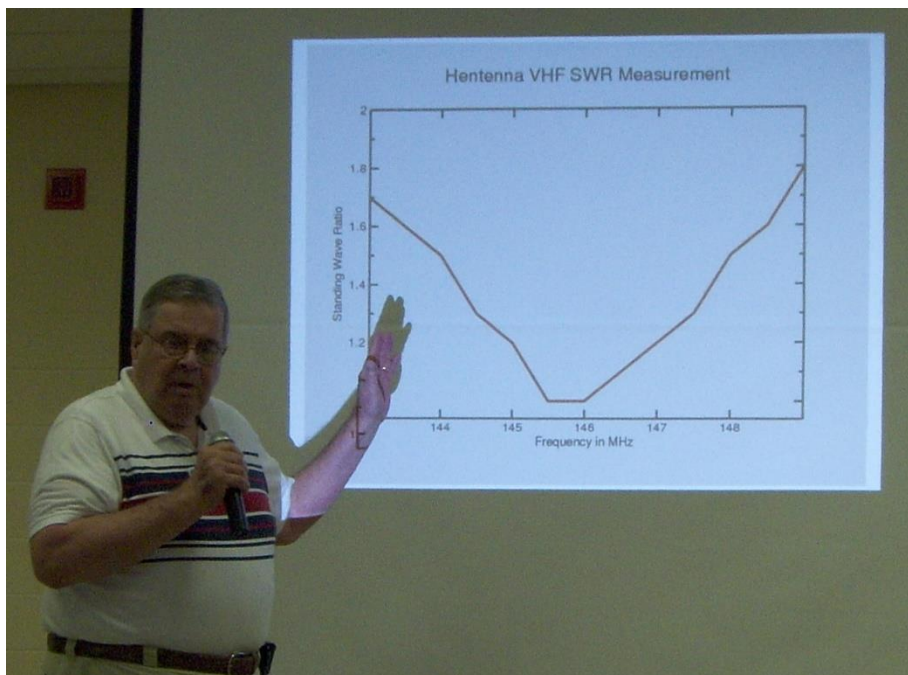

Using his antenna analyzer, Geoff measured the SWR across the two meter band; you can see the SWR is 1.5:1 or less across the entire band.

If this SWR chart is too small to read, see Geoff's complete presentation [here](#).

Geoff told us his Hentenna works well on UHF in addition to VHF.

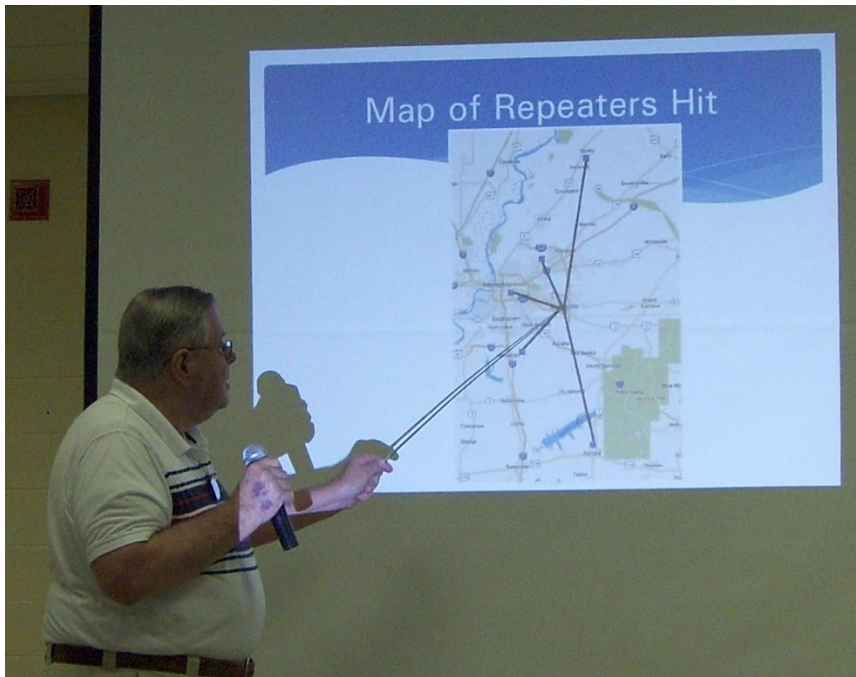

From his QTH, Geoff can operate through a number of repeaters up to 50 miles or so away with his Hentenna inside his attic.

The table below shows some of the repeaters he uses often.

Repeater	Frequency	Signal strength	Distance
Ripley	145.230	40%	52 miles
Oxford	147.330	<20%	49 miles
Hernando	146.910	90%	25 miles
Memphis	443.200	20%	23 miles
Brunswick	443.700	70%	16 miles

The % figures are from his radio's signal strength meter. He pointed out that his antenna is on the opposite side of his house from the Hernando repeater and also from the Memphis 443.2 repeater and his signal must also traverse various pieces of attic HVAC equipment.

Geoff's future plans include converting the present Hentenna into a four-element beam on a rotor in his walk-in attic and constructing a 1.25 meter Hentenna beam to add to the same rotor.

If you are interested in building your own Hentenna, Geoff provided several links:

<http://www.wa0itp.com/hentenna.html>

<http://www.hamuniverse.com/hentenna.html>

<http://www.hamuniverse.com/n5nns4elhentenna.html>

Thanks, Geoff, for a very interesting presentation!

## Field Day, 2017

Submitted by Dan Lasley, NE7JN, contributions by Michael Knight, KK4IOH,  
and Ryan Turner, KORET

In May, 2016, Michael Knight, KK4IOH, then Delta's Vice President, presented a program entitled "Field Day, 2016." Because Michael's presentation was clear and succinct, I would like the reader to refer to the June, 2016, Sparks [article](#), pages 10-11, for the objective and rationale for Field Day. Thanks, Michael, for a great presentation!

2017 Field Day set up operations begin at 6pm Friday (all times are local), June 23rd, at 7771 Poplar Pike, Germantown, TN, behind the Pickering Center. A number of hams (and everyone is invited) will meet for breakfast on the following morning at 7:30am at Piccadilly Cafeteria, 2055 Exeter Road, Germantown, TN, then proceed to the Field Day site. On-the-air operations commence at 1pm Saturday, June 24th, and end at 1pm Sunday, June 25th, followed by tear down operations.

As in 2016, Delta is joining forces with MARA, the Nashoba Club, and the Tri-State Repeater Association in Field Day operations and we expect a smooth running Field Day.

Our capabilities will include voice, CW, digital, satellite, packet and APRS demos, and networking via HamWAN:

<b>Band</b>	<b>Mode</b>	<b>Primary operators</b>
10M/15M/80M	SSB	Ham Hilliard, W4GMM
20M	SSB	Fred Miller, KS2X
40M	SSB	Michael Knight, KK4IOH
various	digital	Hugh Wardlaw, WB4SLI
various	CW	Pat Lane, W4OQG, and Jim Cissell, KI4I
various	SSB	GOTA (Get On The Air), Amanda Nash, KM4MSC
VHF	satellite	Rick Tillman, WA4NVM
GHz	HamWAN	Ryan Turner, KORET

The Field Day operation accumulates points for on-air contacts: phone contacts count one point, and CW and digital contacts count two points. We accumulate additional points in a number of other ways, such as youth participation, using 100% emergency power, media publicity, satellite QSOs, educational activities, and more. Our educational activity will be a transmitter hunt class by David Campbell, KD4NOQ, on Saturday at 2pm.

Ryan Turner, KORET, says, "HamWAN Memphis Metro will be providing local WiFi and computer help for the event. We'll have a tent setup demonstrating the network services offered as well."

As detailed in the August, 2016, [Sparks](#), pages 17 and 18, the combined clubs racked up points as follows in 2016:



bonus points	1,570
QSO points	2,512
GOTA points	120
	=====
total points	4,202

We plan to exceed 4,202 points in 2017!

Here is how you can help with Field Day:

- operate a voice or CW station (this is an excellent opportunity for those of you who would like to make some HF contacts but have never done so)
- log contacts
- help coach
- greet the public
- act as tour guides for the public
- loan batteries for the event duration
- help set up or tear down (or both!)

We hope to see you on Field Day!

<p style="text-align: center;"><b>Delta Club Logo Shirts</b> Submitted by Dan Lasley, NE7JN</p>
---

At the April meeting, club president Ken Laseter, KI4AOH, asked attendees about their interest in obtaining a shirt with your name, call sign, and Delta's logo. About 50 folks said they were interested in ordering one or more of these shirts. Here is your chance!

Go [here](#) to see a sample shirt and to find ordering information. At the June meeting Len Grice, W4MKS, will distribute shirts to those who have placed an order and he will have sample shirts in a number of sizes for those of you who wish to place an order.

Bring your order form and cash, check, or credit card to the June meeting.

## **A Visit to the Memphis Belle**

Submitted by Joe Lowenthal, WA4OVO

Before the 2017 Dayton/Xenia Hamvention®, ten very excited Memphis hams had the pleasure of having a special tour of the restoration area for the World War II B-17F Memphis Belle at the National Museum of the Air Force at Wright-Patterson Air Force Base.

For security clearances, several weeks prior to the tour, we had to send pictures of our driver's licenses to the restoration coordinator. On the day of the tour, we met our escorts in the VIP parking area at the National Museum of the Air Force at 8:30am. Only Dick Cookenham, K3ORS, retired Navy, was able to drive while the other two carloads had to ride with official escorts to the active duty side of the base where the restoration area is located.

Once at the restoration hanger, the lead escort rang a doorbell on the hanger and we waited for our tour guide. After waiting nearly thirty minutes—the whole time from afar watching the Air Force personnel work on the plane—our escort reported back to us that he had some bad news and some good news. The bad news was that our designated tour guide did not show up; the good news was that the tour guide would be Greg Hassler, the supervisor for the restoration.

We could not have been luckier—Hassler has worked in restoration for 17 years and prior to that, was in the Air Force working on planes at Wright-Patterson.

As we toured the restoration project, he told us that it took six trucks to move the Belle to Dayton from Memphis. He also pointed out that while the plane will never fly again, but will be restored to near original condition. Currently the plane exterior has been stripped for painting except for the "famous" left nose artwork with the--25 bombs representing the 25 missions flown, and the other eight symbols representing the confirmed number of German planes shot down.

The world-famous plane was named after Memphis native Margaret Polk who was Captain Robert Morgan's girlfriend. While in Bangor Maine getting the 100-flight hours on their new plane before deploying to England, the name came to Morgan one evening while he and co-pilot, James Verinis, saw the movie "Lady for the Night" with a Mississippi River gambling boat named the Memphis Belle. The rest is aviation history!

Hassler also explained how they acquire and/or remanufacture pieces that have been damaged. After an hour and forty-five minutes our group departed the hanger knowing that the Memphis Belle is in good hands. The Memphis Belle will be on display again as part of the permanent exhibit at the National Museum of the Air Force starting May 17, 2018, the 75<sup>th</sup> anniversary of its 25<sup>th</sup> mission.



The Memphis Belle, a B-17F in restoration. Photo by Joe Lowenthal, WA4OVO



(L-R) Richard Martin, K4DXF, Randy Wilder, WB4LHD, Joe Wray, WD4GXI, Dick Cookenham, K3ORS, Steve Frazier, KK4VPT, Bill Stevens, WC9S, John Wray, KK4DUX, Max Gray, K1MAX, Restoration Supervisor Greg Hassler, Joe Lowenthal, WA4OVO, Rick Tillman, WA4NVM. Photo by Bill Stevens, WC9S.

## Huntsville Hamfest Bus Trip

Submitted by Joe Lowenthal, WA4OVO, Director of Training

Delta ARC is sponsoring a 50-passenger bus trip to go to the Huntsville Hamfest on August 19, 2017. There is a graduated scale fare for the bus trip. The fare is \$65 if paid by June 30, 2017, and \$70 if paid after June 30th. The fare includes the \$10 hamfest entry ticket. There will be two biscuits (bacon, ham or plain) sandwiches, water, sodas, chips, and fruit on the bus going to Huntsville and whatever is left during the day and then for the trip back. There are no refunds, but you can sell your seat to someone else if you cannot go. Let me know.

Cash or checks will be accepted for payment. Make checks payable to Delta Amateur Radio Club. You can pay at a meeting. You can also send your check to Joe Lowenthal WA4OVO, 6675 Ashbridge Cove, Memphis, TN 38120. Please include your name, callsign, cell phone number, and email address. **Reservations will be on a first come first paid basis.**

The bus will leave Germantown Baptist Church, 9450 Poplar Avenue at Johnson Road, Germantown, TN at 6:00am. The bus will leave Huntsville immediately after the 4pm door prize drawing and return to Germantown Baptist Church approximately 7:30pm.

Germantown Baptist Church has asked us to park in the back on the northeast side of the church so there will be security cameras on the cars.

## HQ 101

Submitted by Dan Lasley, NE7JN

Our CW Elmer, Jim Cissell, KI4I, attended a school event with his grandson and wasn't able to teach the CW class in May. Jim asked if I would take over the class in his absence. I told him I would, but I surely had reservations since I'm very inexperienced with the code!

We covered the letters P through T and after sending each letter a dozen times or more, I sent a number of short words having the new letters for copy practice.

Several of the folks in the class were able to copy the practice words and no one mentioned QLF, so we ended the class on a positive note.

Next month Jim will rejoin the class as Elmer and he will cover the letters U through Z. If you want to learn Morse code but have missed some of the classes, please join us. You have to start somewhere!

If you use iambic paddles, check out the iambic paddle [guide](#) by our own Ray Miller, AA4UK. Thanks, Ray.

## Amateur Hardware Update

Article and image submitted by James Butler, KB4LJV

Many amateurs use the Baofeng HT. It is unique in that the standard battery pack can only be charged with the drop in charger. The input to the drop in charger is about 10 VDC. This month's project is a universal cable to allow connections to different 12 VDC batteries to operate the Baofeng drop in charger. The adapter consists of battery clips and the correct coaxial 2.5 mm OD power connector along with 4 diodes. The series connected diodes serve two functions in the circuit. One is to provide a voltage drop of about 2.4 volts to get charger input closer to 10 VDC. Be sure to check voltage output and polarity before hooking up to charger base. The other is to prevent damage if it is accidentally hooked up to battery backwards. The adapter works well and allows me another option to charge the Baofeng during emergencies.

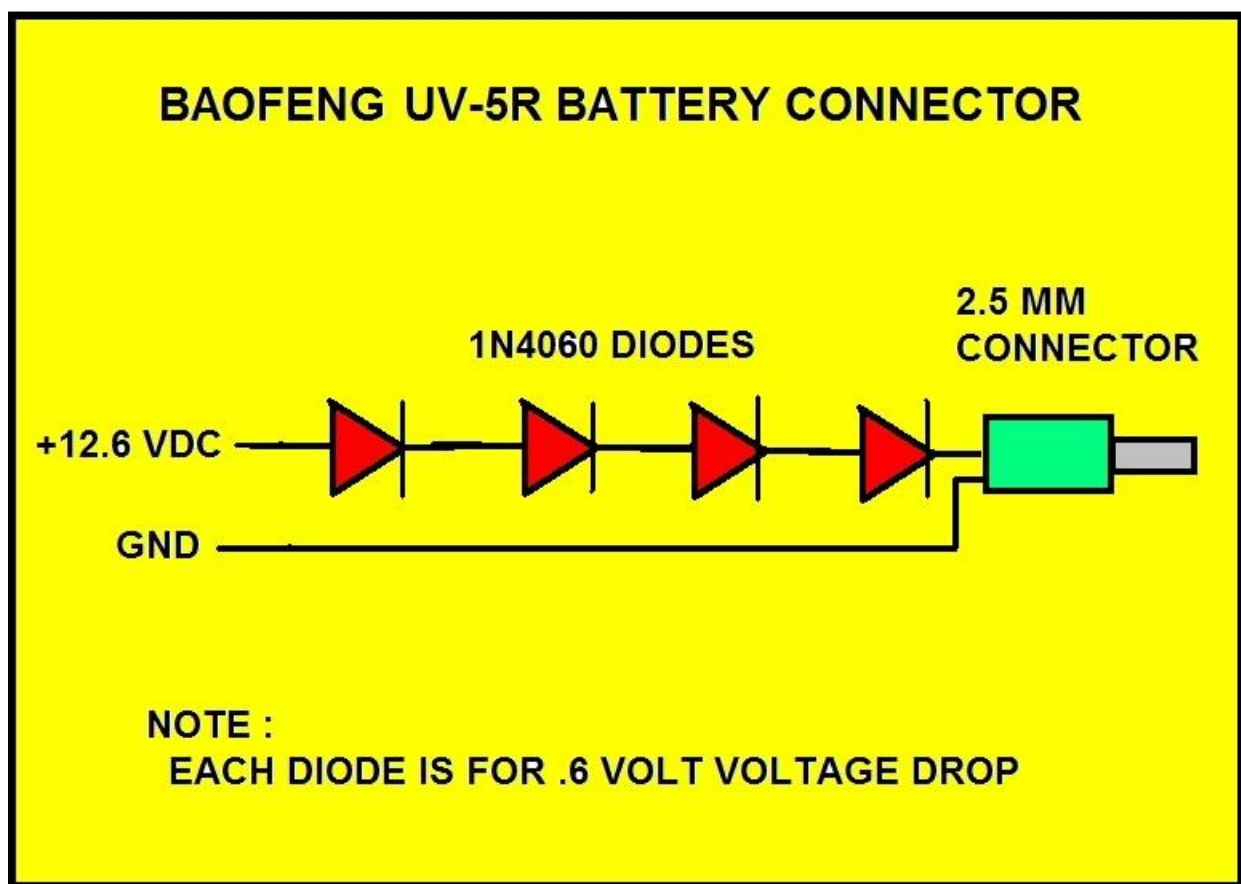

## Amateur Packet Update

Submitted by James Butler, KB4LJV

The 220 MHZ amateur band has always been more expensive to buy equipment for than the 2 meter band. You can now get on the 220 MHZ amateur band for less money. BridgeCom now has a new HT that covers the FM part of the band. The BCH-220 is a 220 MHZ portable. The power output is 2 or 5 watts selectable. The radio comes with a rechargeable battery, drop in charger, rubber duck antenna, belt clip, and charger power supply. The radio has an LCD display and DTMF keypad along with 199 memory channels. Transmit frequencies are 222.000 to 224.995 MHZ. The best thing is the radio is under \$100.00. If you are looking for a cheaper way to get on 220 MHZ check out this HT from BridgeCom. The web address is <https://www.bridgecomsystems.com/products/bch-220>.

## The Fusion Confusion Net

Submitted by Warren Zimmer, KC7ND

Warren Zimmer, KC7ND, reports the establishment of a new VHF net: "A bunch of us Bullfroggers who have C4FM fusion radios have started a net. We are calling it the Fusion Confusion Net. It's on Sunday nights at 7:00pm on 146.48 simplex, digital C4FM mode."

Anyone who is interested please check into the new net! You'll find the net information repeated each month in the **Memphis Area VHF/UHF Nets** section near the end of the newsletter.

## Delta Ham License Training, 2017

Submitted by Joe Lowenthal, WA4OVO

*There is no charge for classes, but the student is responsible for the purchase of the license manual and the \$15 ARRL FCC examination fee.*

### Licenses Earned in 2017 from Delta Classes

6 Technician

2 General

6 Extra

If you are interested in attending a training class, send an email to [Joe Lowenthal](mailto:Joe.Lowenthal@delta-ham.org) with the desired class name in the subject line, along with your name, email address and cell phone number in the text.

The new [Technician question pool](#) is effective July 1, 2014, through June 30, 2018. You will need the [ARRL Ham Radio License Manual 3rd Edition](#) to study for the Technician exam.

The new [General question pool](#) is effective July 1, 2015, through June 30, 2019. You will need the [ARRL General Class License Manual 8th Edition](#) to study for the General exam.

The new [Extra question pool](#) is effective July 1, 2016, through June 30, 2020. You will need the [ARRL Extra Class License Manual 11th Edition](#) to study for the Extra exam.

### Scheduled Classes

Tech Class 3-17 is being planned to start on six Monday nights from July 10th until August 14th from 6:15pm-9:30pm at EMHC ambulance company training room, 6972 Appling Farms Parkway. The FCC exam will be offered on August 7th. If interested in the Technician class, send an email to [Joe](mailto:Joe.Lowenthal@delta-ham.org) with Subject line: Tech Class and name, email address and cellphone in the text area.

## March of Dimes Event

Text and photos by Dan Lasley, NE7JN

The annual March of Dimes March for Babies event took place on Saturday, May 6, and was assisted by Delta Club members who provided communications for the event.



Linda Laseter, KJ4CTX (left), continued in her role as event wrangler for the ham volunteers, providing sausage biscuits, pastries, leadership, and excellent documentation on when to arrive, where to go and who to contact when you arrive, primary and backup repeaters, and anything else you needed to know for your assignment.

The primary repeater was to be MARA's 147.030 repeater located at the WKNO site immediately north of the event but it wouldn't cooperate, so we switched to the backup, which was Delta's 146.820 repeater.

This is an example of why every plan needs to provide for contingencies!



Barri Munday, WB4SWP, and Pat Lane, W4OQG (seated, L-R), provided net control at the communications tent. Where is the tent, you ask? It was retired due to high winds!

Marlin Mogy, KM4DPP (far left), and Ken Laseter, KI4AOH (far right), are two of the 22 hams scheduled to help in the event.





(L-R) Janice Shaner, KX4BB, and Tom Dichiara, AC5MR, compare H-T settings.

If Linda, KJ4CTX, had been able to control the weather, she couldn't have picked a better day! The sky was cloudless, the humidity was low (low for Memphis, that is), and the strong breeze helped keep everyone cool.



The MOD folks provided two security guards, (L-R) Bridgette Wright and Tarelle Thompson. Both are bright, personable, and very knowledgeable about their jobs.

Tarelle is an 18 year Army vet who plans to stay in as long as the Army will let him. Thanks, Tarelle, for your service to the country.

If you've never volunteered to help with an event, you should consider helping with next year's MOD event!

I had a great time and I'm looking forward to next year.

## Results of the Armed Forces Communications Test

Submitted by Bob Vawter, KW4RJ, contributions by Joe Lowenthal, WA4OVO

The Corps of Engineers Memphis District sponsored a station (WUG2) for the Armed Forces Communications Test on Saturday, May 13th. Pat Lane, W4OQG, said we had over 100 contacts on 5.4014 MHz. I (Bob Vawter, KW4RJ) made my first MARS contacts. Joe Lowenthal, WA4OVO, was covering 20 meters, but he was hogging the mic! There were about seven local ham operators who showed up at the station, which was located on the Navy base in Millington. Overall it was a great day for radio!



Pat Lane, WA4OQG, staying busy! Photo by Bob Vawter, KW4RJ.



Joe Lowenthal, WA4OVO, working 20 meters. Photo by Bob Vawter, KW4RJ.

**2017 Tour de Peddler event**  
Submitted by Dan Lasley, NE7JN

Pat Lane, W4OQG, is heading up communications for the 2017 [Tour de Peddler](#) event to be held on Saturday, June 17, 2017. Pat needs 20 ham operators for the event. Can you help? Please email [Pat](#) to volunteer for the event.

Everyone will meet at Memphis Peddler Bike Shop, 3548 Walker Avenue, at 7am on June 17.

This year's routes will include lengths of [2 miles](#), [20 miles](#), [40 miles](#), and [62 miles](#).

**Note:** these routes are subject to change based on final permits and unexpected construction or road conditions. Please check the [event website](#) for the most up-to-date information.

## DXCC Entities

Submitted by Dan Lasley, NE7JN, contributions by Ron Rubin, K3RON

When I first became interested in earning the ARRL [DXCC award](#), a good friend, an accomplished ham, and a recipient of the DXCC award, Ron Rubin, K3RON, told me that a confirmed QSO with Hawaii, Alaska, and one of the remaining 48 states counts as three of the 100 entities you need for the DXCC award. While I might have eventually discovered that fact on my own, I surely appreciated Ron's heads-up! I want to pass along Ron's helpful tidbit and add other DXCC-related information I've learned over the last few years.

The first item I want to mention is the official ARRL list of DXCC entities. Go to [Country Lists & Prefixes](#) and click on the [Go Now](#) link under "DXCC Entities List (Text Version)." This returns a list of all current and deleted entities as of May, 2017. You've no doubt noticed I keep saying "entities" and not "countries." That's because a significant number of entries in the DXCC list are not countries. You already know that two entries in the list (Hawaii and Alaska) are not countries. The ARRL therefore adopted the nomenclature of "entities" rather than countries.

If you've been a ham for more than five minutes, you know U.S. hams have a call sign beginning with AA through AK, K, N, or W, so you scroll down the DXCC Entities List looking for AA-AK. When you reach the middle of page 2 of the entity list, you discover there is no entry for AA-AK! Keep scrolling down; by the time you get to the first K entity on page four, you'll find "K,W,N,AA-AK" are prefixes for the U.S. Keep going and look for N and W U.S. entities. You won't find them!

Our second lesson, then, is that the list is incomplete. The list should have separate entries for AA-AK, K, N, and W, but it doesn't. Ok, not a big deal, everyone knows about AA-AK, K, N, and W. We'll return to the issue of an incomplete list below.

Page four has more to teach us. The second K entity, KG4, says "Guantanamo Bay." Wait a minute, that's on the island of Cuba! Yes, it is, ain't politics wonderful? Not everyone on Cuba lives near Guantanamo Bay, so where are the remaining Cuban prefixes? Search for "Cuba" and find that Cuban entities are CM and CO. If you confirm a QSO with either a CM or a CO and a KG4, you have two of the 100 entities you need for DXCC.

The remaining K entities are either states (Hawaii, KH6 and KH7, and Alaska, KL, AL, NL, WL) or territories for which the U.S. is responsible.

Suppose you heard the call sign MX0TBG. Where is this station? Page four shows not a single M! Search for ",M" and you'll find that G, GX, and M are call signs for England. This is another example of an incomplete list. Note: you won't always be this lucky on a ", " search; [qrz.com](#) is a good alternative to the DXCC entity list in some cases.

Suppose you heard the call sign WP4OUH. Where is it? You can't tell from the DXCC entity list. Our good friend, page four, shows Puerto Rico as KP3 and KP4, but it completely

neglects NP3, NP4, WP3, and WP4! Again, [qrz.com](http://qrz.com) is a good alternative to the DXCC entity list.

While AA, for example, is strictly an American prefix, the TO prefix refers to no fewer than ten DXCC entities.

Just because an entity exists for a given location (e.g., KH9 is Wake Island), don't spend a lot of time listening for a signal from that entity! I could find only four KH9 call signs on planet earth and none had a Wake Island address.

In the June, 2017, issue of QST, Bernie McClenny, W3UR, tells us in his "How's DX?" column that Mellish Reef, prefix VK9M, is mostly submerged at high tide and the part that isn't submerged is "only about 2 meters above high tide." Other than DXpeditions, you won't hear many Mellish Reef signals.

There are a number of "gotchas" in the DXCC entity list, but after you browse through it and begin working DX, it won't be long before you recognize such things as a JN or 7N prefix being Japan.

Ron has more suggestions: "With ARRL's Logbook Of The World (LOTW), it is easier to get QSOs confirmed toward DXCC. LOTW is supported by most modern logging programs. Keep in mind that CQ Magazine and others offer awards like Worked All Zones, Worked All States, and the very difficult Worked All Counties."

Thanks, Ron, for helping me and Sparks readers!

## Update on Browser Calculators

Submitted by Dan Lasley, NE7JN

On page 29 of the December, 2016, [Sparks](#), I mentioned a number of calculators that operate through your browser. I've found more browser-based calculators. Check out the [555 Astable Circuit Calculator](#) and the [555 Monostable Circuit Calculator](#). Both are well done.

A back issue of QST points to a watts-to-dBm (and vice versa) [calculator](#) from [Radius](#). If you go to the calculator link, you will also find other useful types of browser calculators.

## YL News

Submitted by Linda Laseter, KJ4CTX

**YL NET** – I love the spring and summer months. It is so relaxing to sit outside and watch the trees as their branches sway in the wind or the clouds as they roll by, but these same months can bring weather events such as we had this week. The trees are no longer swaying they are cracking and falling causing major damage and power outages. Ken and I are lucky to have power and no damage to our property, but many of you are still without power and some may even have a tree in your living room. Ladies, these are the times when you need your radio skills!

The YLs are planning a “Practice Using Your Radio Day”. This would be an excellent opportunity for you to gain confidence and skills using your radio. We have tentatively planned a Saturday in August to begin honing our skills, but looks like we may need to set something up sooner. Please email [me](#) if you would be interested in joining us on a Saturday to learn more about your radio and gain some hands on practice.

Please join us each Saturday night at 8:45 p.m. on the 146.820 repeater.

**YL LUNCHEON** – With a forecast of rain and stormy weather only a few of us were brave enough to wander out for our May luncheon. We laughed and misbehaved and generally had a great time! As usual the YL’s ordered a variety of delicious foods. For those of you who could not join us, please know you were missed.

We have plans to have a program/learning session at our luncheons every other month starting in August. If you have something you would be interested in learning more about, please send me an email and we will work it into our program schedule.

Betsy, KD4KOM, won the door prize this month. A set of two chili/soup bowls with lids. Perfect for heating up something quickly or for soup on those rainy days or cool summer nights.

**Our June luncheon is as follows:**

**11:30 a.m.,  
Saturday, June 10, 2017  
Fat Larry’s Bar-B-Q  
7537 Hwy 70  
Bartlett, TN 38133 (East of Ellendale Church)**

Hope to see you there!

## Inexpensive (Free) Windows 10 Async Terminal

Submitted by Hugh Wardlaw, WB4SLI

Have you had a situation where you needed a simple asynchronous terminal to troubleshoot a TNC or Dial a modem on Windows 10? Save yourself some Google time looking for a solution. There is a free software package called PUTTY which is a telnet terminal package. I just noticed that it can do a serial connection. Your initial screen looks like the left image. Once you select Serial COMx You will see the right image.

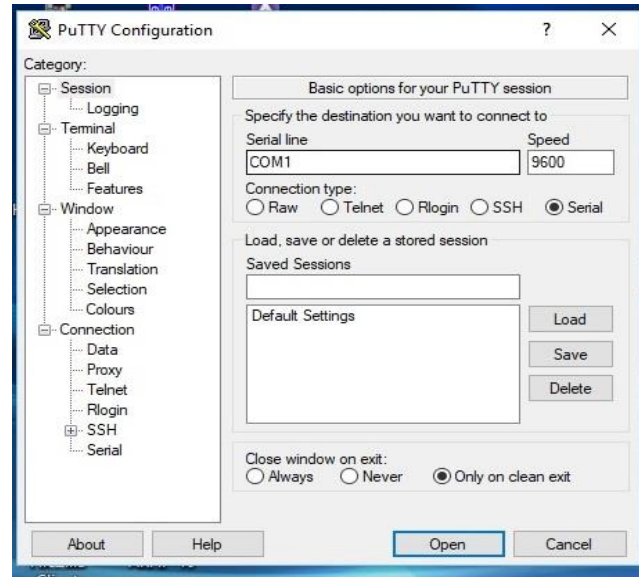
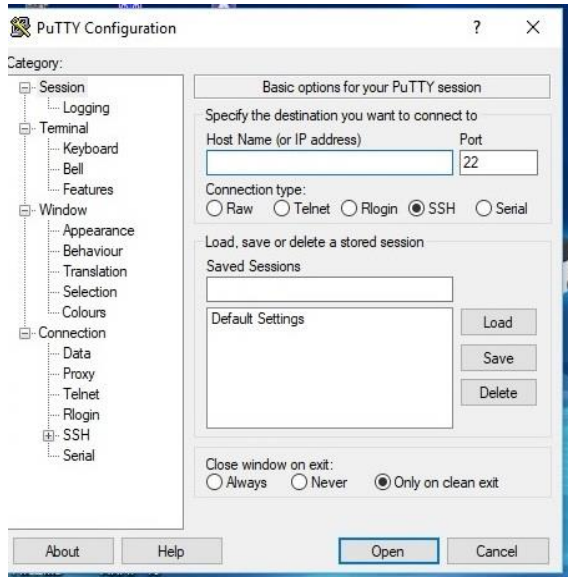

Click on Open and you will see the screen below. This is where I was checking out my MFJ -1278T TNC. Go to <http://www.chiark.greenend.org.uk/~sgtatham/putty/latest.html> to download the software.

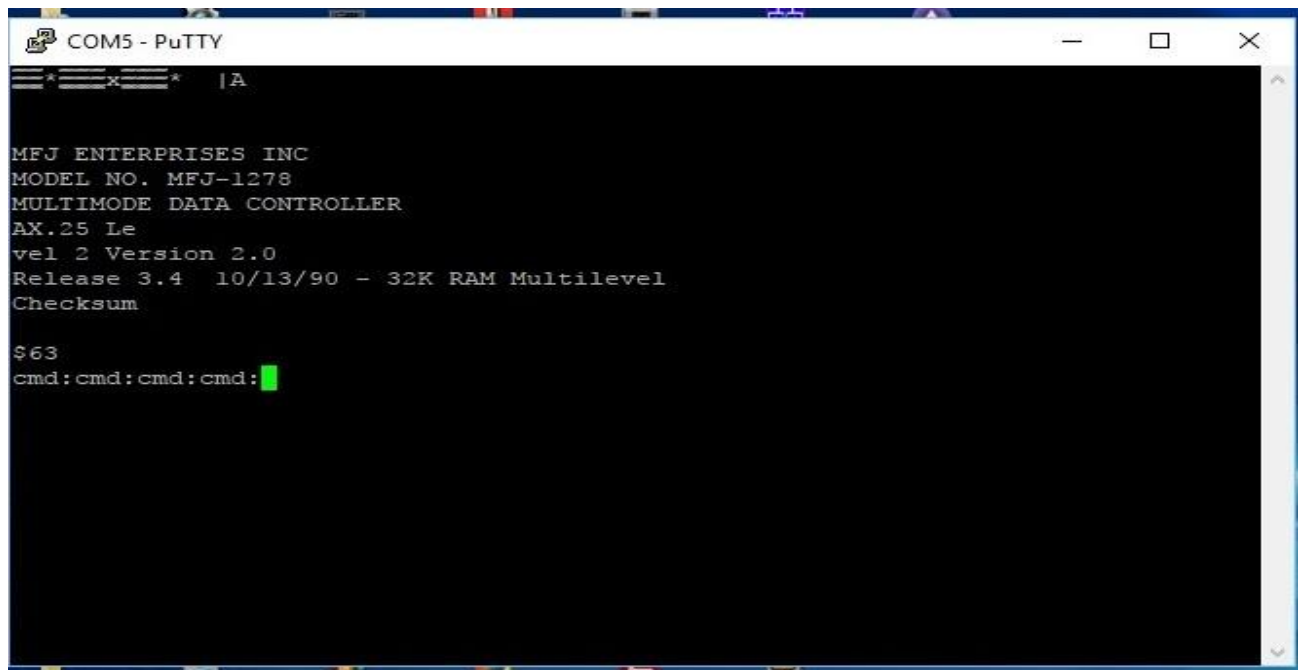

*Editor's note: Thanks to Hugh for another very interesting article!*

## HF Propagation, Part 9

Submitted by Dan Lasley, NE7JN, contributions by Larry May, K4QZF

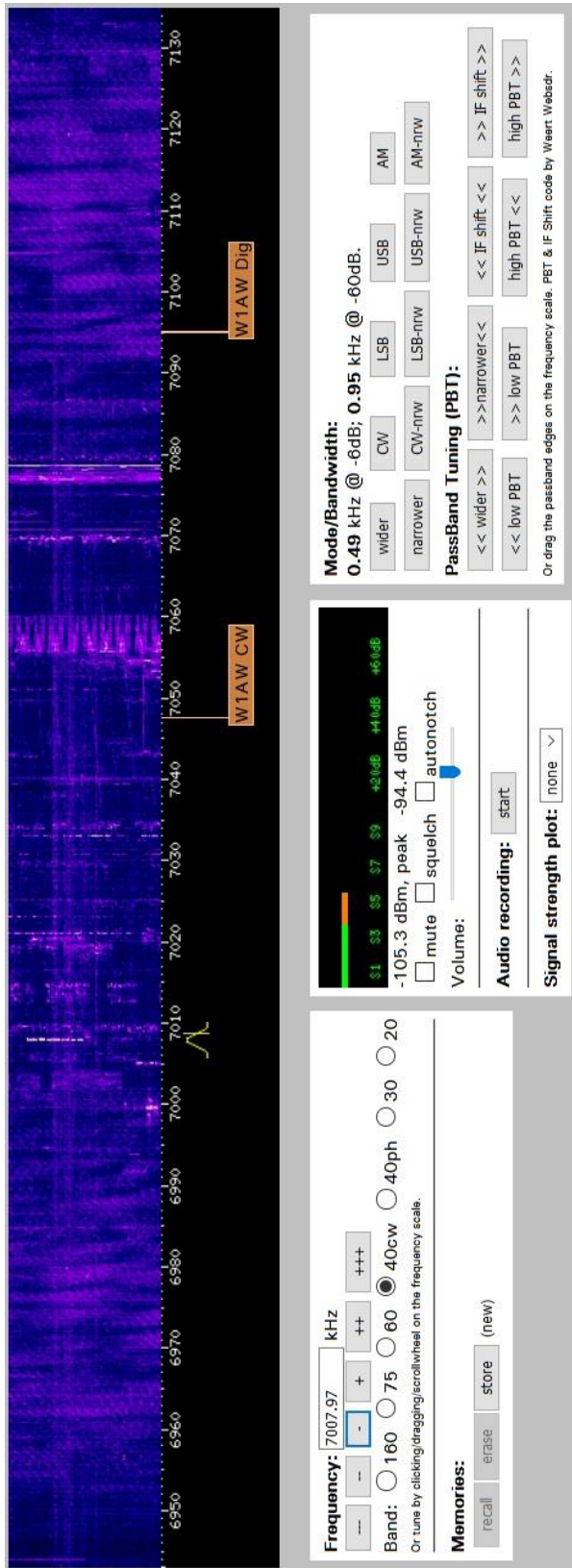

One morning during the 40 meter group's conversations, Larry May, K4QZF, mentioned that he couldn't directly hear the signal from Jim Cissell, KI4I, but he was listening to a Knoxville-based SDR receiver over the Internet and was receiving Jim's signal via that path!

Larry couldn't copy Jim's ground wave at a distance of 9.2 miles but easily copied skip from Memphis as received in Knoxville, about 400 miles away.

Larry sent me two URLs to control remote SDR receivers, [GlobalTuners](#) and [WebSDR](#). GlobalTuners requires a free login and offers about 60 free receiver connections. Anyone may use WebSDR, no login required; it offers about 160 free receiver connections.

I've tried a few receivers on both GlobalTuners and WebSDR. The GlobalTuners receivers are basic and seem to have similar, perhaps identical, user interfaces. WebSDR interfaces resemble modern radios with a waterfall display and have a somewhat more complex user interface that will feel very comfortable with a bit of experimentation even if you'd never used a waterfall display before (I hadn't).

As examples of differences among various WebSDR receivers, the [Sedona-based receiver](#) provides three ham bands, SSB only; the receiver in [Half Moon Bay, California](#) (shown here), provides six bands, including the CW portion of 40M.

I was listening to a strong CW signal at about 7008 KHz (look for the yellow passband just left and below 7010 on the image). You can see the dits and dahs (in white) about to march off the top of the display.

I think you will enjoy exploring these Internet-based SDR receivers. *Warning: waterfalls are addictive!*



## Odds and Ends

Submitted by Dan Lasley, NE7JN

Tom Dichiara, AC5MR, sent me a link to the [Radio Handbook](#). This URL provides links to most editions of the Radio Handbook from the first edition in 1931 to the 20th edition in 1975. I looked at the 9th edition in 1942 and it has very informative chapters on Antenna Theory and Operation and on Radio Mathematics and Calculations, topics that are as useful today as in 1942. Thanks to Tom for the link.

Speaking of books, Edmund Laport's [Radio Antenna Engineering](#) is available as a free download.

Joe Lowenthal, WA4OVO, sent me a link to [Electrical Tape Tips by KOFF](#). This is a collection of tips for those of you who put up outside antennas and need to make connections waterproof. Thanks to Joe for the link.

The ARRL Letter for April 20, 2017, tells us "Alex Schwarz, VE7DXW, ... developed the online [Scanning RF Seismograph](#) to determine which bands are open."

In "[Meet the ESP8266](#)" author Craig Lindley says, "It's not all that often that a new piece of hardware comes along that immediately captures the attention of the builder community. The ESP8266 is the newest example of this. It's only about the size of a nickel, yet contains a powerful 32-bit microcontroller and a Wi-Fi interface, plus you can buy it for around \$4."

Jeff Eckert's "[World's Smallest Transistor -- Sort of](#)" talks of using molybdenum disulfide for transistors. If you've ever been around molybdenum disulfide in industry, you know this stuff is an excellent lubricant, but if it ever gets on your clothes, it's there forever.

If you want to chase DX but you're not sure where it is, see hamradioweb.org's [DXpeditions and Contest Schedule](#) and the [DX Calendar](#) at dxnews.com. The dxnews.com DX calendar for a recent month showed no less than 44 DXpeditions, all clickable.

Elizabeth St. Vincent, K4KTG, Managing Director, Auxiliary Communicators of Tennessee provided a couple of interesting articles by Earl Pack, AE5PA: [Charging Batteries](#) and [Battery Selection and Battery Safety](#). Thanks, Elizabeth.

If you need QSL cards from multiple states on multiple bands, the [13 Colonies Special Event](#) on July 1-6 is a target rich environment!

Jim Brown, K9YC, has written extensively on [audio systems and ham radio](#). Check out "[A Ham's Guide to RFI, Ferrites, Baluns, and Audio Interfacing](#)," Revision 6, 5 December 2016.

The ARRL Contest Update for May 17, 2017, says, "Rocket triggered lightning strikes are NOT a good way to protect your towers from high energy events" but they "make [impressive videos](#)."

The ARRL's [Product Review List by Manufacturer](#) was helpful to me in finding a new power supply and in evaluating a radio I was interested in buying.

The ARRL Letter for May 18, 2017, provides a treat for fans of CW: "All copies of the English-language version of [Morsum Magnificat](#), the Morse Magazine, are now available for free download from the website of Lynn Burlingame, N7CFO."

See the Bell System Technical Journal's "Radio Propagation Fundamentals" by Kenneth Bullington, May, 1957, 34 pages; 60 years old, still worth reading!

<https://ia902701.us.archive.org/34/items/bstj36-3-593/bstj36-3-593.pdf>

"[Measure small LCs with a scope](#)" tells how to measure small-value inductors and capacitors with an oscilloscope.

"[How to Measure Inductance](#)" gives three methods of measuring the value of an inductor.

What do art and Morse code have in common? Go [here](#) to find out.

## SPARKS Newsletter & Delta Club Information

SPARKS is published monthly by the Delta Amateur Radio Club and emailed to club members. All information published in this newsletter is provided as a service. While every reasonable effort has been made to ensure accuracy, neither the Delta Amateur Radio Club nor its officers assume any liability resulting from errors or omissions. All correspondence may be mailed to:

Delta Amateur Radio Club \* P.O. Box 342768 \* Memphis, Tennessee 38184-2768

An alternative email address to offer the Board your suggestions, ask questions, and voice complaints is [darc4you@gmail.com](mailto:darc4you@gmail.com).

Please note that you must provide your name and call sign if you're requesting specific actions or personal follow-ups, and also be aware that any profane or mean-spirited comments will be unceremoniously discarded without consideration.

Delta Club Members Can Like Us/Follow Posts On Facebook! Go to <https://www.facebook.com/darcmem>.

### **2017 BOARD OF DIRECTORS**

**President**

[Ken Laseter, KI4AOH](#)  
901-853-0400

**Vice-President**

[Steve Frazier, KK4VPT](#)  
901-218-6385

**Secretary**

[Barri Munday, WB4SWP](#)  
901-756-5259

**Treasurer**

[Linda Laseter, KJ4CTX](#)  
901-268-1766

**Director of Training**

[Joe Lowenthal, WA4OVO](#)  
901-628-4318

**Director of Publications**

[Dan Lasley, NE7JN](#)  
901-827-5049

**Director of Programs**

[Kevin Zent, K4KLZ](#)

**Director of Meetings & Special Events**

[Scott Adams, KM4PMU](#)

**Repeater Trustee**

[Bill Stevens, WC9S](#)

**Public Information Officer**

[Len Grice, W4MKS](#)  
901-488-4195

**Immediate Past President**

Joe Wray, WD4GXI

Board members beginning their positions in 2017 are listed in *italics*.

## Public Service Events

If you are a coordinator for any of these events, please review the listed information. Please [email](#) corrections or additions.

<b>2017 Date</b>	<b>Event</b>	<b>Contact Information</b>
Jan. 15	<a href="#">Swamp Stompers 50K/25K Run</a>	<a href="#">Keith Barton, KT4EP</a>
May 6	<a href="#">March of Dimes March for Babies</a>	<a href="#">Linda Laseter, KJ4CTX</a>
TBD	Diabetes Tour de Cure	<a href="#">Pat Lane, W4OQG</a>
<b>Sep. 9-10</b>	2017 Bike MS: FedEx Rock-N-Roll	<a href="#">Darrell Sheffield, KK4D</a>
Oct. 7	Bluff City Blues 100 Ride	<a href="#">Danny Banks, KJ4FXZ</a>
Dec. 2	<a href="#">St. Jude Marathon</a>	<a href="#">Roger Schlichter, WR4R</a>

Note: Dates in **red** are tentative.

## Tennessee Ham Radio License Plate Submitted by Joe Lowenthal, WA4OVO

The link below is for information and instructions about Tennessee ham radio call sign Emergency/Safety automobile license plates:

<http://www.tn.gov/revenue/article/emergency-safety>

The application can be found at this link:

<http://www.tn.gov/assets/entities/revenue/attachments/f1312601Fill-in.pdf>

## Other Notes of Possible Interest

Submitted by David Webb, KV4QI

It's Time to Renew Your 2017 Annual Memberships! Download the latest Delta Club [Membership Application Form](#). The 2017 membership renewal fee remains a very modest \$20 for an individual, with an additional \$5 fee for family membership. Thanks for Your Active Support of Delta Amateur Radio Club!

## Memphis Area VHF/UHF Nets

Updated September, 2016

Name of Net	Freq. MHz	Offset/Tone	Local Time	Day of Week
<b>Delta Club Information Net</b>	<b>146.820</b>	<b>- (107.2)</b>	<b>8:00p</b>	<b>Daily</b>
<b>YL Net</b>	<b>146.820</b>	<b>- (107.2)</b>	<b>8:45p</b>	<b>Sat</b>
Mid-South Barefooted Bullfrog Net	146.535	[simplex]	7:30p	Daily
Secret Service Net	224.780	[no tone]	8:30p	Mon
Elmer Net	145.210	- (107.2)	9:00p	Mon
The Short Winded Net	146.850	- (107.2)	8:30p	Tue
MedMERS Net	146.820	- (107.2)	12:00p	Wed
CERTPlus Net	443.200	+ (107.2)	8:30p	Wed
ARES Training Net	146.880	- (107.2)	9:00p	Thu
Super Sunday Niner Net	927.6125	- (146.2)	8:30p	Sun
Fusion Confusion Net [C4FM digital]	146.48	[simplex]	7:00p	Sun

**Delta Club sponsored Nets are shown in red.**

## TENNESSEE HF NETS

As of December, 2015

All times are Central Time

Net Name	Freq. MHz	Local Time	Day of Week
Tennessee CW Net	3.563	7:00p	Daily
Tennessee Slow CW Net	3.682	7:30p	Tue-Sun
Tennessee Alternate Phone Net	7.238		As needed
CUSEC (Center for United States Earthquake Consortium)	3.810		As needed
CUSEC (Center for United States Earthquake Consortium)	7.180		As needed

### 3980 kHz – TN Phone Net

Mon-Fri - 5:40 AM, 6:45 AM & 6:30 PM

Saturday - 8:00 AM & 6:30 PM

Sunday - 8:00 AM only

Holidays - 8:00 AM only

## DELTA CLUB ADVERTISEMENTS

See Advertisement Order Form for Instructions.



### MID-SOUTH AMATEUR RADIO SUPPLY (MSARS)

6631 Vallendar Cv., Bartlett, Tennessee 38135

tel: 901-371-9700 • fax: 901-266-3374 • web: [www.msars.com](http://www.msars.com)

CURRENTLY STOCKING			
Antennas	Antenna Mounts	Connectors	Coax & Cable
HT	Magnet	UHF	RG-213
Mobile	Trunk Lip	"N"	RG-8/U Mini
Base Station	Roof Mount	SMA	RG-58
HF	Window Mount	BNC	450 & 300 Ohm
Wire	Swivel Ball	RCA	Rotor Cable

LDG Electronics	Accessories	Miscellaneous
Automatic Antenna Tuners	RF Chokes	Gordon West Books
Remote Tuners	Power Poles	Coax Seal
Brand Specific Antenna Tuners	Antenna Switches	Fuse Holders
Baluns	SWR/Power Meters	Remote Tuner Boxes
Ununs	Mic Holders	Dog Bone Insulators

**Owners/  
Operators**

**Steve**  
W5VAA

**Rosalinda**  
WN2V

**Ham**  
W4GMM

**Mid-South Amateur Radio Supply**, (MSARS.COM) is owned and operated by local hams who are dedicated to promoting the hobby and providing help to anyone interested in ham radio. We actively support the local amateur radio clubs and are ARRL members.

**MSARS** offers free antenna building classes each year and help many new hams with guidance on their first radio, setting up a ham shack, programming a radio and much more. We are proud to be a part of the ham radio community and are *here to help you*.

*Please thank our sponsors by using their services and mentioning that you saw their ad in the Delta Club SPARKS Newsletter!*

*This ad space is available*

## DELTA CLUB ADVERTISEMENTS

See Advertisement Order Form for Instructions.

### DELTA AMATEUR RADIO CLUB

P.O. Box 342768  
Memphis, TN 38134-2768

**DARC** Meeting: Second  
Tuesday of every month  
at Ellendale Church of Christ  
7365 Hwy 70, Bartlett TN



W4BS REPEATER SYSTEM  
146.82- 147.36+ (107.2Hz tone)  
224.42- 443.20+ (107.2Hz tone)



**Ben Richhart**  
Sales and Service Director

**Chick-fil-A at Paragon Place**  
6282 Poplar Avenue  
Memphis, TN 38119  
Phone: 901-766-1875  
Fax: 901-766-1878  
E-mail: ben@cfaparagonplace.com

*Please thank our sponsors by using their services and mentioning that you saw their ad in the Delta Club SPARKS Newsletter!*

*This space is available!*

*We offer our continued thanks to EMHC ambulance company for generously providing their training room for the many ham radio classes given there.*

**Delta Amateur Radio Club  
Sparks Advertising Order Form**

Date: \_\_\_\_\_

Name: \_\_\_\_\_

Call Sign: \_\_\_\_\_ Phone: \_\_\_\_\_ Email: \_\_\_\_\_

**TO PLACE AN ORDER**

1. Mark the box below indicating the ad size you are purchasing and the months you want your ad to appear in Sparks.
2. Submit this completed order form and your camera ready ad, via email at [sparks@carbheat.net](mailto:sparks@carbheat.net)  
Make check payable to Delta Amateur Radio Club (DARC) at monthly Delta Club meeting, or send US Mail to club mailing address at P.O. Box 432768, Memphis, TN 38134-2768. Camera ready means that ad copy is exactly as you wish it to appear, scaled to fit within the dimensions specified below. Ads may be submitted in .gif or .jpg format, or submitted as a hard copy (we will scan and place your ad for you).
3. Your ad order and payment must be received on or before the first Tuesday of the **month before** you want it to appear in Sparks.

**SPARKS ADVERTISING**

FULL PAGE			HALF PAGE			¼ PAGE			BUSINESS CARD		
<b>\$50.00</b>			<b>\$25.00</b>			<b>\$15.00</b>			<b>\$10.00</b>		
for 3 Months			for 3 Months			for 3 Months			for 3 Months		
7" w X 8 ½" h			7" w X 4" h			3 ½" w X 4" h			3 ½" w X 2" h		
Jan 2017	Feb 2017	Mar 2017	Apr 2017	May 2017	Jun 2017	July 2017	Aug 2017	Sept 2017	Oct 2017	Nov 2017	Dec 2017