

# SPARKS

P.O. Box 342768 \* Memphis, Tennessee 38134-2768 \* Volume 23 \* August 2017



## Welcome to the Delta Amateur Radio Club

Visit our home on the web at: <http://www.deltaclub.org>

EMAIL: [darc4you@gmail.com](mailto:darc4you@gmail.com)

Facebook: <https://www.facebook.com/darcmem>

Newsletters: <http://www.deltaclub.org/sparks.html>

## W4BS

### REPEATER SYSTEM

146.820 <sup>-107.2</sup>	* 147.360 <sup>+107.2</sup>
146.625 <sup>-107.2</sup>	443.200 <sup>+107.2</sup>
224.420 <sup>-107.2</sup>	
144.390 Digipeater	*Fusion

**This month's meeting** begins at 7pm on August 8, 2017, at Ellendale Church of Christ, 7365 Highway 70 Memphis, TN (1 ½ miles north of Highway 64 (Stage Road)).

**In this month's program** we welcome Sam Kahel with the Memphis Light Gas & Water smart meter team. Sam is a Telecommunications Design Engineer Level III. He is a registered Professional Engineer in the State of Tennessee. He graduated from Tennessee State University in 1998 with a Bachelor of Science degree in Electrical Engineering. He has been working with the division since 1999. During his 18 years with the division he has been responsible for MLGW private Telecommunications infrastructures. In the last 3 years, he has been selected to be on the Smart Meter project.

**Delta Club FCC testing sessions** are held monthly except December. Registration begins at 5:30 PM; testing begins by 6:00 PM. Please bring a photo ID and another form of identification, copies of existing licenses or CSCEs, and your FCC Registration Number (FRN) if one has been issued. Please be on time for registration to allow our Volunteer Examiner (VE) team to complete their work prior to the club meeting. The 2017 test fee is \$15 (cash or check). Individuals receiving their initial FCC license grant at a Delta Club test session or through a Delta Club training class will receive a complimentary individual club membership for the remainder of the current calendar year when they also show proof of ARRL membership. For more information, please email our VE Liaison, [Jeff Krause, AJ4GY](mailto:Jeff.Krause@AJ4GY), or call at 901-301-6776.

## President's Corner

Submitted by Ken Laseter, KI4AOH

I'm sure enjoying the lower temperatures we are having right now. I like summer, but not those days over 97 degrees and high humidity. Even at these lower daily temperatures (84-88) if you must work outside, try to stay in the shade, dress in light colored clothes, eat light foods, and drink plenty of water (not alcohol). Personally, I'm looking forward to some even cooler weather.

Don't forget that next month is the Multiple Sclerosis 150-mile bike ride. I believe that this year it will run from Byhalia, MS to Oxford, MS. The exact routes, aid station locations, and other details have not been released. Watch the Sparks Newsletter for more details.

Don't forget, we have chartered a bus again this year going to the Huntsville Hamfest. Riding the bus is a great opportunity for new hams to corner the more experienced hams (Elmers) to ask them those questions you just can't seem to find the answers for. I personally know this works, because it's what I did some years ago, and it worked GREAT for me. Furthermore, the Huntsville Hamfest is one of the best in the country. You can find almost anything you need for setting up your hamshack or that one special fitting you need, but not sure exactly what it's called. So, if you would like to go, contact Joe Lowenthal and buy your ticket. I promise you, it's always fun!

As always, please don't forget to check into the Delta Club information net on the 146.820 repeater at 8:00 pm each evening, and when you check-in, make sure to thank the net control operator for taking time from their family and busy schedule to call the net for us. They are some our most valuable assets!

If you have not renewed your club membership now is the time. I think we still have some members that are procrastinating or have forgotten. Linda, KJ4CTX, will be glad to accept your renewal application and cash, check or money order, either at a club meeting or via snail mail.

See you at the meeting Tuesday night!

73

Kenneth Laseter  
KI4AOH

## Treasurer's Report

Submitted by Linda Laseter, KJ4CTX

### DELTA AMATEUR RADIO CLUB

#### Monthly Treasurer's Report

For month ended July 31, 2017

Submitted by Linda Laseter Treasurer

### CHECKING ACCOUNT

#### BEGINNING BALANCE

<b>BEGINNING BALANCE</b> as of June 1, 2017	<b>\$5,934.83</b>
---	-------------------

#### INCOME

Date		Amount
07/11/17	Membership dues 2017	\$ 100.00
07/13/17	Patch sale	\$ 5.00
07/14/17	Huntsville bus trip	\$ 140.00
<b>TOTAL INCOME</b>		<u>\$ 245.00</u> <b>\$ 245.00</b>

#### EXPENSES

Date	Check #	To	Description	Amount
07/03/17	1419	Len Grice	DARC shirt reimbursemen	\$ (289.00)
07/11/17	1420	Scott Adams	DARC refreshments	\$ (67.58)
<b>TOTAL EXPENSES</b>				<u>\$ (356.58)</u> <b>\$ (356.58)</b>

<b>ENDING BALANCE</b> as of July 31, 2017	<b>\$ 5,823.25</b>
---	--------------------

#### CERTIFICATES OF DEPOSIT

	Maturity Date	Balance as of	
Certificate of Deposit #1	10/10/2018	7/26/2017	\$ 10,502.10
Certificate of Deposit #2	10/19/2022	7/31/2017	\$ 10,079.58

<b>TOTAL DARC CASH ASSETS</b>	<b>\$ 26,404.93</b>
-------------------------------	---------------------

**This Month's Board Meeting Minutes**  
August 1, 2017, submitted by Dan Lasley, NE7JN

Attendees: Steve Frazier, KK4VPT, Bill Stevens, WC9S, Dan Lasley, NE7JN, Ken Laseter, KI4AOH, Linda Laseter, KJ4CTX, and Joe Lowenthal, WA4OVO. Absent: Barri Munday, WB4SWP, Kevin Zent, K4KLZ, Scott Adams, KM4PMU, and Len Grice, W4MKS,

Ken called the meeting to order at 6:57pm.

Linda gave us an update on an interest payment to one of the club CDs and said the YL luncheon will be at the club meeting location on Saturday, August 5th at 11:30 am. The gathering will continue with a training session assisted by OMs Ken, Jim Cissell, KI4I, and possibly others. The training session subjects will include HT programming and HF/VHF/UHF on-the-air sessions.

Joe's Technician class had 11 attendees (with one absent due to illness) in the most recent class. The next class will be exam time. Joe reminded everyone you can avoid the \$25 surcharge for renewal of your Emergency/Safety automobile license plate if you are an ARES member. See the "Tennessee Ham Radio License Plate" article near the end of this issue of Sparks.

Ken promised to distribute the recently reviewed club by-laws to the Board of Directors. He reminded us that director positions held by Barri (secretary), Bill (repeater trustee), Steve (vice president), and Dan (publications) will be open. Club members are urged to consider running for one of the open positions for calendar year 2018.

At the conclusion of business, Ken moved to adjourn the meeting at 7:54 pm, seconded by Linda.

## Minutes of Last Month's Club Meeting

July 11, 2017 – Submitted by Barri Munday, WB4SWP

Club President Ken Laseter, KI4AOH, opened the meeting at 7:00 pm and reminded everyone to sign in and drop a ticket in the bucket. Introductions were then made by name and call sign.

Ham Hilliard, W4GMM, moved to approve the previous meeting minutes as recorded in Sparks, seconded by Ned Savage, KA4BLL; the minutes were approved by acclamation.

Ham moved to approve the Treasurer's report as recorded in Sparks, seconded by Len Grice, W4MKS; the report was approved by acclamation.

Linda Laseter, KJ4CTX, reports the YL Net is going very well.

Bill Stevens, WC9S, told us Field Day was a smashing success and the site has been reserved for next year's Field Day. We had a total of 1,247 contacts with the GOTA station reporting 32 contacts.

Joe Lowenthal, WA4OVO, talked about the bus trip to the Huntsville hamfest; tickets are \$70 for the trip which includes breakfast biscuits and an admission ticket. The bus will leave Germantown Baptist Church at 6 am promptly. Joe also said a Tech class is being held on Monday nights at 6:15 til 9:30 at the EMHC ambulance office. At this time there are 18 people signed up for the class.

Darrell Sheffield, KK4D, discussed the upcoming MS-150 bike ride. It is to start in Byhalia, MS, proceed to Oxford, MS, on Sept 23rd and return on the 24th. If you have questions on the event or if you wish to volunteer, call Darrell at 277-8122.

Keith Miller, N9DGK, TN ARRL Section Director, presented the evening's program.

Ham moved to adjourn the meeting at 8:45 pm.

## Last Month's Program

Submitted by Dan Lasley, NE7JN

Keith Miller, N9DGK, ARRL Tennessee Section Manager, told us which subjects the ARRL board is focusing on in 2017 and fielded questions and comments from the audience.

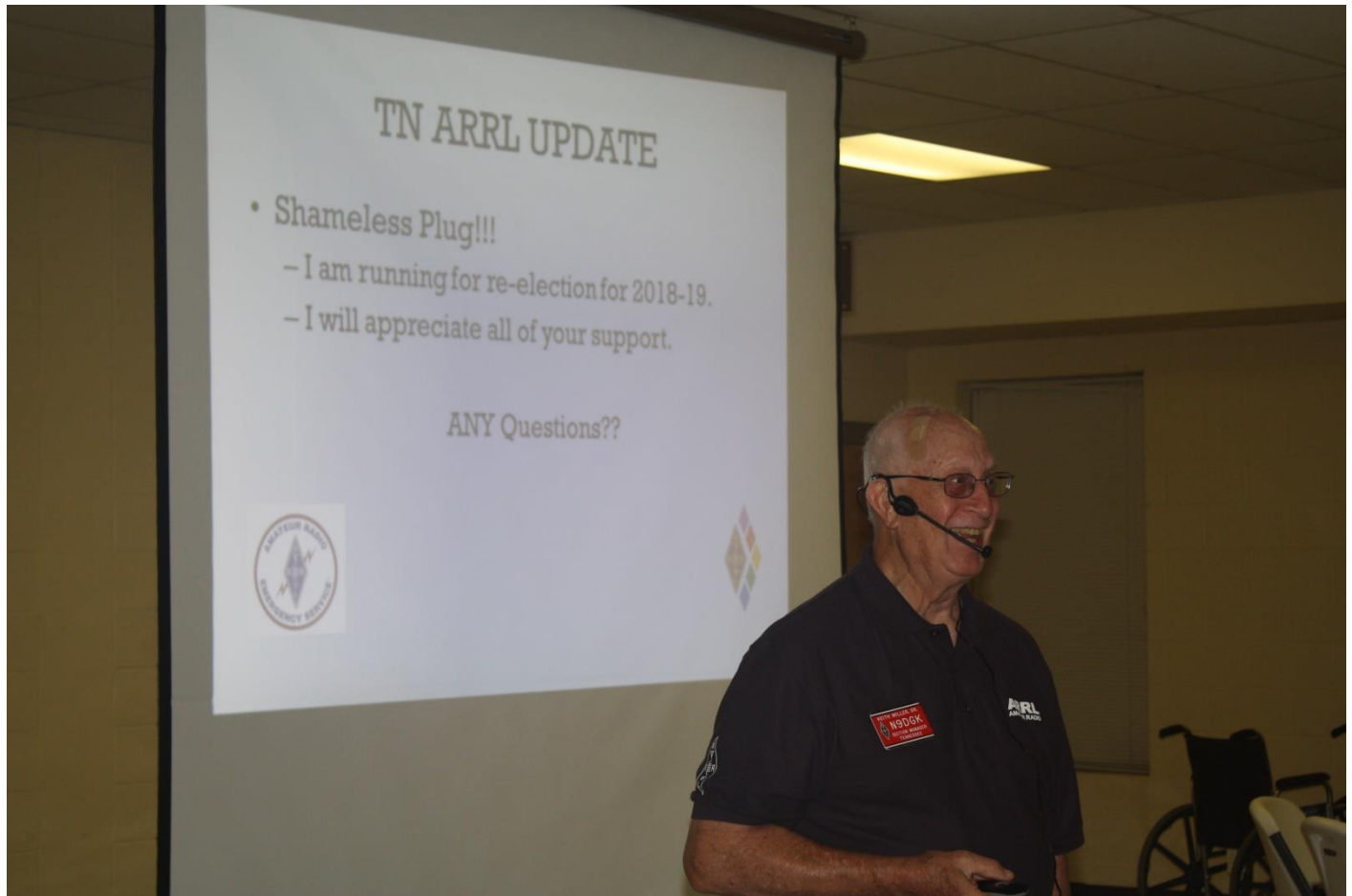

As you can see in Keith's "Shameless Plug" slide, he plans to run for re-election as ARRL Section Manager. Joe Wray, WD4GXI, former Delta president, asked for everyone's support of Keith in his quest for reelection.

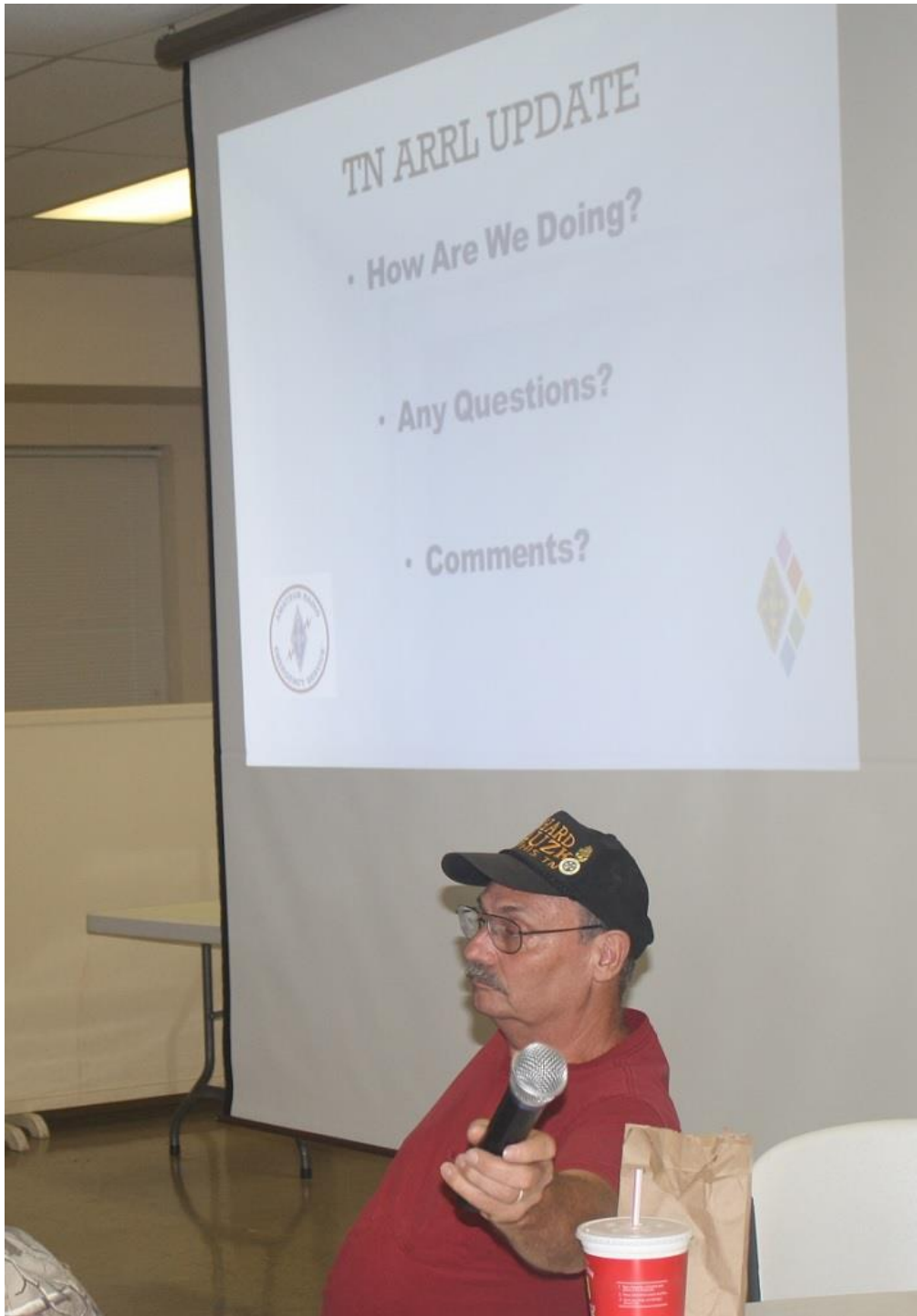

Richard Smith, KJ4UZK, poses a question for Keith.

Keith's presentation was interesting and informative and we thank him for driving from Murfreesboro to be with us.

## Field Day, 2017, Part II

Submitted by Dan Lasley, NE7JN, contributions by Bill Stevens, WC9S,  
and David Albert, N5COO

Thanks to Bill Stevens, WC9S, for a summary of the 2017 Field Day statistics. We used the special event call sign N4E.

N4E's Contest Summary Report for ARRL-FIELD-DAY

Total Contacts = 1,247

Total Points = 1,470

Operating Period: 2017/06/24 18:10 - 2017/06/25 17:59

Total Bonus Points 1,350

Band	CW	Phone	Dig	Total	%
----	--	-----	---	-----	----
80	0	131	15	146	12
40	0	357	28	385	31
20	166	326	13	505	40
15	0	151	1	152	12
10	0	32	0	32	3
6	0	27	0	27	2
---	-----	-----	---	-----	----
Total	166	1,024	57	1,247	100%

Thanks to David Albert, N5COO, for taping and posting a [video](#) of 2017 Field Day events.

If you enjoyed participating in this year's Field Day events, please consider pitching in and helping during Field Day 2018!



## July HQ 101

Submitted by Dan Lasley, NE7JN

The July HQ 101 discussion was on the topic of the ARRL band plans, specifically the [2 meter and 70 centimeter band plans](#). We discussed the use (and misuse) of the 146.52 MHz National Simplex Calling Frequency, frequencies reserved for CW, SSB, beacons, EME (earth-moon-earth), and repeaters. We had some good discussions and fielded interesting questions.

Join us upstairs at 6pm on the next club meeting night, August 8, for our next HQ 101 session, which will be an open forum. Bring your questions and join the group! It's always an interesting meeting before the meeting!

## Passage of The Amateur Radio Parity Act

Submitted by Dan Lasley, NE7JN

Rick Roderick, K5UR, ARRL President, recently distributed an email to ARRL members asking for their help in getting the Senate to pass The Amateur Radio Parity Act. This bill passed the House of Representatives in January.

Many deed-restricted communities prohibit external antennas of any form. If you are a member of a deed-restricted community and feel these restrictions unfairly limit your enjoyment of amateur radio, here is your chance to act!

If you are not currently a member of a deed-restricted community, you may face these restrictions one day, so please help ensure your antenna-raising ability in the future.

Go to <https://arrl.rallycongress.net/ctas/urge-us-senate-to-support-amateur-radio-parity-act> and follow the directions. It should take no more than a minute or so. Please help!

## Amateur Hardware Update

Article and image submitted by James Butler, KB4LJV

Many times we look for backup power during outdoor activities or emergencies. The standard for a lot of low power portable equipment is the 5 volt USB port. These battery powered devices do a great job with long runs before they need recharging. One new popular device now used is the backup battery. These vary in capacity, but they all do the same function. They have an on board battery and a USB connector to hook up your equipment so you can keep running and get a quick recharge. Some units have built in rechargeable batteries while others let you put in one time alkaline batteries for emergency power. They even have units with built in solar panels on the case to keep the battery fully charged and ready to go. These are available for under \$10.00 on Ebay. Do a search for "battery USB power" to see all they have for sale.



## Amateur Packet Update

Submitted by James Butler, KB4LJV

Running HF voice or data wire antennas represent the best deal for the money. Amateurs have been building wire antennas for many years. DX Engineering has come out with a kit to build your own wire antennas. The EZ-BUILD kit has an insulated plastic tee for the feed point and wire connections and a set of insulated end pieces for the ends of the antenna. You can use this kit to build dipoles, ZEPPs, Offset feeds, and Multiband wire antennas etc. These kits are under \$25.00. They also sell 150 foot spools of 14 gauge wire to use with the kit for under \$25.00. If you are looking to build your own wire antennas, check out DX Engineering for the parts.

The website is <https://www.dxengineering.com/search/brand/dx-engineering>

*Editor's note: see "Antenna-Trimming Technique," May, 2017, QST, page 65, for a simple, quick method of trimming a dipole to a given resonant frequency.*

## 2017 Route 66 On The Air

Submitted by Dan Lasley, NE7JN



The 2017 [Route 66 On The Air](#) Special Event will be held September 9-17. As I mentioned in an article in last September's [Sparks](#), pages 18-19, this is a fun event to work. If you are pursuing WAS or other awards, this event provides contacts on multiple bands in eight states. You can obtain QSL cards from the 21 individual stations along the path of Route 66 and a certificate is also available.

Image by Freddie, CC BY-SA 3.0, <https://commons.wikimedia.org/w/index.php?curid=12499286>

## Huntsville Hamfest Bus Trip

Submitted by Joe Lowenthal, WA4OVO, Director of Training

DARC is sponsoring a 50-passenger bus trip to go to the Huntsville Hamfest on August 19, 2017. The fare is \$70 after June 30th. The fare includes the \$10 hamfest entry ticket. There will be biscuit sandwiches, water, sodas, chips, and fruit on the bus going to Huntsville and whatever is left for the trip back. There are no refunds, but you can sell your seat to someone else if you can not go. Let me know.

Cash or checks will be accepted for payment. Make checks payable to Delta Amateur Radio Club. You can pay at a meeting. You can also send your check to Joe Lowenthal WA4OVO, 6675 Ashbridge Cove, Memphis, TN 38120. Please include your name, callsign, cell phone number, email address and whether you want bacon, ham or plain biscuits.

**Reservations will be on a first come first paid basis.**

The bus will leave Germantown Baptist Church, 9450 Poplar Avenue at Johnson Road, Germantown, TN at 6:00am. The bus will leave Huntsville immediately after the 4pm door prize drawing and return to Germantown Baptist Church approximately 7:30pm.

Germantown Baptist Church has asked us to park in the back on the northeast side of the church so there will be security cameras on the cars.

## On-line Call Books

Submitted by Dan Lasley, NE7JN

A recent ARRL email said, "Tracking the history of vanity call signs is made easier through the online availability of some years of [Amateur Radio call books](#)." (Kudos to Dennis, N6KI, for the information.)

Recently Ervin Ables, KU4K, asked several of us if anyone had a 1958 or 1959 call book. The link above doesn't have either of the call books Ervin would like to borrow. If you can loan either of both of these call books to Ervin, please email [Ervin](#).

## My Start in Amateur Radio

Submitted by Jim Cissell, KI4I

*Editor's note: Jim Cissell, KI4I, recently sent an email about news from his home town. As I read through it, I realized this could be the start of a new series of Sparks articles about how someone developed an interest in Amateur Radio. I badgered Jim into letting me publish the article. Here is Jim's story.*

I found an [article](#) on my hometown news from Perryville, MO, about radio station KSGM turning 70. The founders started this station about the same time that I came into the world.

KSGM was the AM station closest to my hometown. We had an old, brown Bakelite Zenith table radio in the kitchen. It was always parked on 980 kilocycles, at least until we turned teenage and discovered KXOK AM 630 in St. Louis playing only rock and roll.

We got our news, music and school closing reports from that old radio station in Ste. Genevieve, MO. I was curious as to what made radios work. It was magic. With an ignition coil, some wire, 6 volt battery and parts from my Erector Set, I made a spark transmitter and heard my "signal" across the room on the old Zenith. All I knew was dits at this time. We could tell dad was coming home from a day in the field on his old Oliver tractor as we heard the pop pop of the ignition coming through the radio. One could say it was DX as we heard him about a quarter mile away. BTW, I was not out to make a transmitter. I was just duplicating the Kettering ignition system from the tractor manual.

Nothing radio-wise happened until another 15 years had gone by and I discovered amateur radio.

*Editor's note: This newsletter goes out to about 650 folks every month. Each of you has a story about how you got involved with Amateur Radio. If you send [me](#) your story, we'll work together and create the next War and Peace. It doesn't matter if you've been a ham for 17 months (KN4BVH) or 59 years (KU4K). It doesn't have to be long or dramatic. It only has to be from the heart.*

## Delta Ham License Training, 2017

Submitted by Joe Lowenthal, WA4OVO

*There is no charge for classes, but the student is responsible for the purchase of the license manual and the \$15 ARRL FCC examination fee.*

### Licenses Earned in 2017 from Delta Classes

6 Technician  
2 General  
6 Extra

If you are interested in attending a training class, send an email to [Joe Lowenthal](mailto:Joe.Lowenthal@delta-radio.org) with the desired class name in the subject line, along with your name, email address and cell phone number in the text.

The new [Technician question pool](#) is effective July 1, 2014, through June 30, 2018. You will need the [ARRL Ham Radio License Manual 3rd Edition](#) to study for the Technician exam.

The new [General question pool](#) is effective July 1, 2015, through June 30, 2019. You will need the [ARRL General Class License Manual 8th Edition](#) to study for the General exam.

The new [Extra question pool](#) is effective July 1, 2016, through June 30, 2020. You will need the [ARRL Extra Class License Manual 11th Edition](#) to study for the Extra exam.

### Current Class

Tech Class 3-17 began on Monday night July 10<sup>th</sup> for six Mondays until August 14<sup>th</sup> from 6:15pm-9:30pm at EMHC ambulance company training room, 6972 Appling Farms Parkway. There are 18 enthusiastic students in the class including three young men and four women. The FCC exam will be offered on August 7<sup>th</sup> with a review session prior to the test. There will be equipment demonstrations on August 14<sup>th</sup>.



Tech Class 3-17. Photo by Joe Lowenthal, WA4OVO.



Keith Barton, KT4EP, giving instruction to Tech Class 3-17. Photo by Joe Lowenthal, WA4OVO.

The instructors are Pat Lane, W4OQG, John Reiners, KN4BVH, Keith Barton, KT4EP, Len Grice, W4MKS, Perry Hayes, N4PSH, and Joe Lowenthal, WA4OVO. The equipment demonstrators are Pat Lane, W4OQG on SSB, long wire antennas, and Winlink; Rick Tillman, WA4NVM, on satellite; Rick Pellicciotti, KJ4NWQ, on ARES; and Joe Lowenthal, WA4OVO, on repeater basics.

## Unbroken Circle

Submitted by Dan Lasley, NE7JN



Several Delta Club members served as pallbearers for Bob Gruner, W4UFT, last December. We met John French (center) and his dad, Richard French, AK4S (right), at the funeral. Richard and Bob were good friends and had known each other for many years. Jim Cissell, KI4I (left), one of Bob's pallbearers, brought some of Bob's 73 magazines to distribute to the ham community. You're gone, Bob, but you surely aren't forgotten.

In a sense, Richard is coming out of retirement! He would like to volunteer for some type of public service. Richard, perhaps you can join Delta in some of our public service events!



## YL News

Submitted by Linda Laseter, KJ4CTX



**YL LUNCHEON** – We returned to Sweet Peas for our July luncheon. Just love their “good ole down home cookin”. We munched on delicious hushpuppies and fried green tomatoes before our meal.

Ann, WB4FAA (left), was the lucky winner of July’s door prize that was a very nice set of covered bowls.

**YL NET** – Not much news this month. Some of our YLs have been out of town and were not able to check-in. We missed them and will be listening for them when they return home. Soon we hope!

Please join us each Saturday night at 8:45 p.m. on the 146.820 repeater for the YL Net.

**Our August luncheon is as follows: 11:30 a.m., Saturday, August 5, Ellendale Church of Christ (the regular DARC meeting**

location), 7365 US-70, Memphis, TN 38133.

## HF Propagation, Part 11: More than High Frequencies

Submitted by Dan Lasley, NE7JN, contribution by Billy Freeman, WL4B

You are probably familiar with the work of Ward Silver, NOAX. He has written QST articles for many years, including the "Hands-On Radio" column which began in the February, 2003, issue of QST and continues through the current issue. He is also an editor of all three ARRL License Manuals.

Ward wrote a couple of very interesting propagation articles for Nuts & Volts magazine ([part 1](#) and [part 2](#)). Ward's propagation articles apply to all ham bands, but some of the material applies primarily to bands above HF. If you have a wireless router, you would benefit from the discussion of reflection, refraction, and multipath.

Ward says, "... when I lived in Seattle, it was not uncommon to contact someone on a VHF or UHF band by bouncing a signal off Mount Rainier tens of miles away! Not unsurprisingly, this is called scatter propagation." If you attended the May, 2014, Delta Club meeting, our own Billy Freeman (then KD4EYW, now WL4B) presented a program entitled "Communications Support for the Oso Washington Mudslide." Here is one of Billy's images:

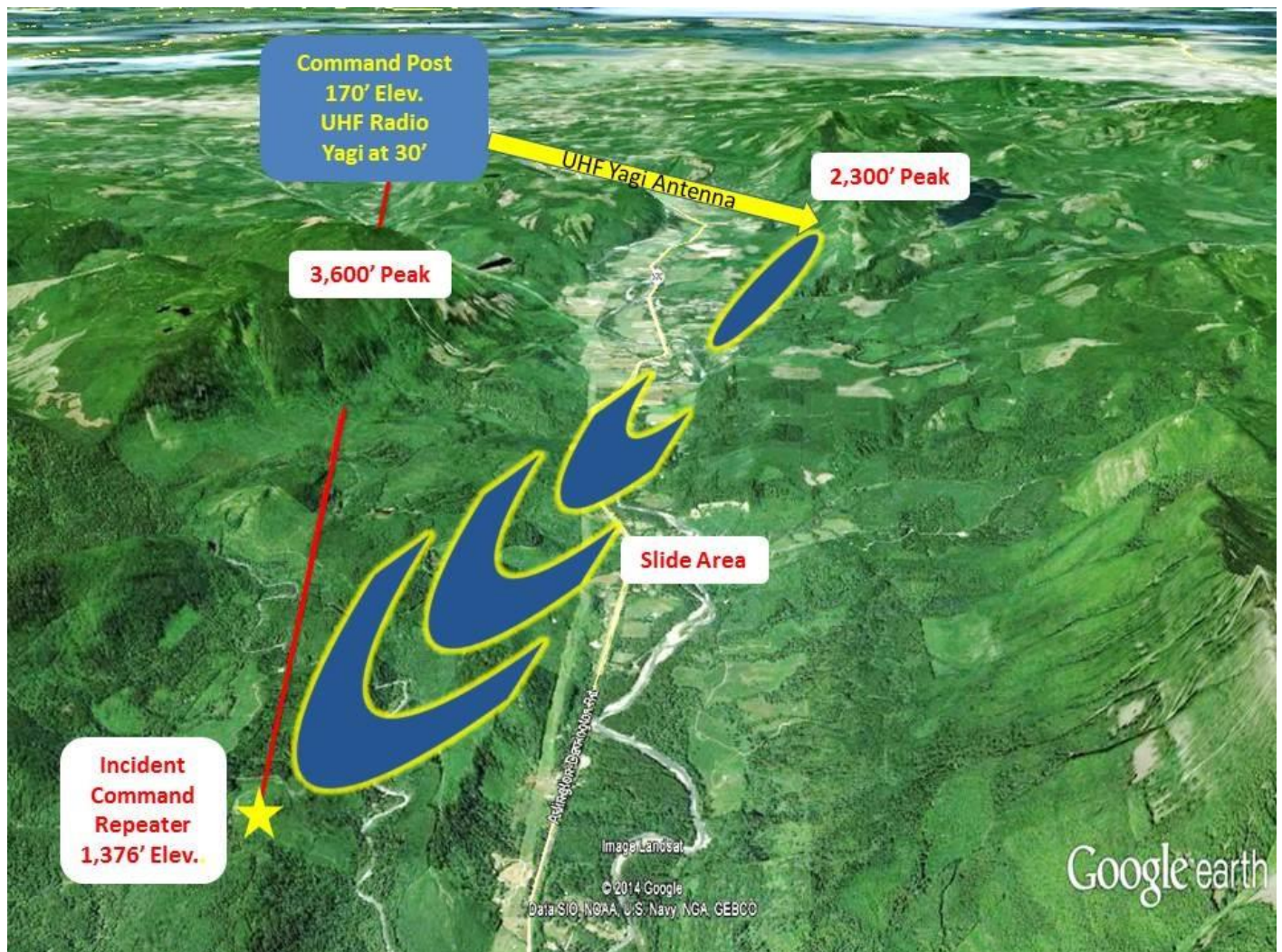

The command post (in blue, upper left) needed to communicate through the incident command repeater (in white, lower left). Unfortunately a 3,600 foot peak blocked direct communications between the two points.

In order to establish communications between the command post and the slide area (white box in the center of the image), Billy pointed the command post's UHF Yagi antenna toward a 2,300 foot peak (yellow arrow). Some of the signal (blue outlined in yellow) reflected off the smaller peak and reached the incident command repeater which, in turn, retransmitted the original signal and made it available to workers at the slide area. This is an excellent, real-world example of Ward's scatter propagation.

If you have any interest in propagation, HF or otherwise, I think you will enjoy Ward's articles.

Thanks to Billy, WL4B, for providing the image.

## The Arduino Inventor's Guide

Submitted by Dan Lasley, NE7JN

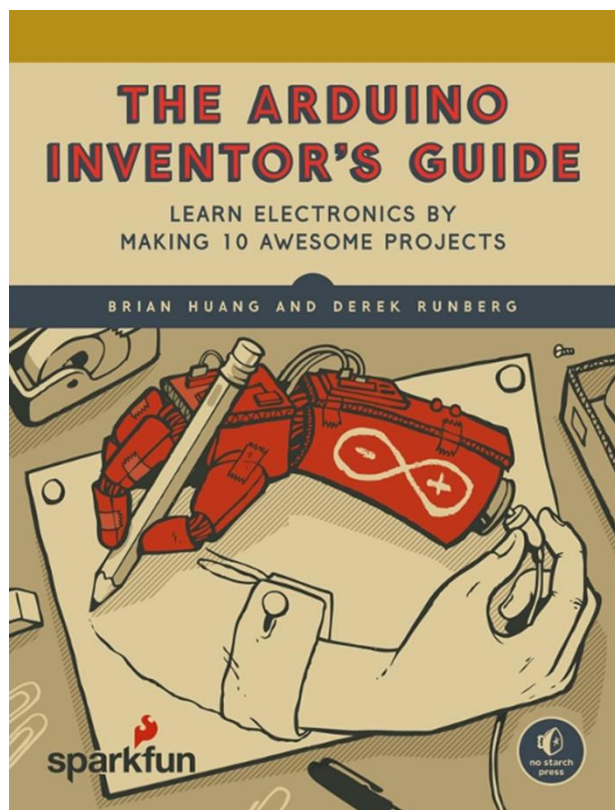

The cover of Nuts and Volts' [Arduino Inventor's Guide](#) shows an Arduino-based robot arm drawing a person's arm which, in turn, appears to be connecting the robot arm to an external device. If you know the name of the lithograph upon which this drawing is based and the famous Dutch graphic artist who drew it, [email me](#) to win valuable coupons from [Danver's!](#)

The first person to identify correctly the lithograph and artist wins two \$5 coupons, the second winner receives one \$5 coupon, and third place takes home one \$3 coupon. I'll throw in an extra \$5 coupon if any of the winners can identify the American cartoonist (as named by the Dutch graphic artist) who created a similar drawing.

All email entries must be received by 4pm CDT August 8, the day of the next club meeting. You don't have to be present at the August meeting to receive your coupons, but we hope you will.

The Arduino Inventor's Guide covers ten projects, one of which is a temperature-sensing mini greenhouse with an automated fan and vent. It looks like an interesting book.

## A Slice of Raspberry Pi

Submitted by Hugh Wardlaw, WB4SLI

I was talking with some hams interested in getting into Raspberry Pi and they were unsure as to where to begin. First, you will need a Pi if you do not have one; [GigaParts](#) sells them as well and [SparkFun](#) has them as well. Sprkfun has all sorts of interesting devices for sale for Android, Arduino, Pi, Beagle, pcDuino and on and on.

Next, you should go to <https://www.raspberrypi.org> and go to Downloads to retrieve the operating system. I use Raspbian Jessie for Ham radio, Select Raspbian Jessie with Pixel ZIP to download. Go to [https://www.sdcard.org/downloads/formatter\\_4/](https://www.sdcard.org/downloads/formatter_4/) to download the SD Card Formatter. Once downloaded proceed to install the downloaded file. This will format your SDHC card for the Pi. Now, go to <https://sourceforge.net/projects/win32diskimager/> and click on the Green Download button to download the diskimager. Install the disk imager program. Open file manager and open the Downloads folder. Right mouse click on the RaspbianJessie image and select extract all to extract the disk image. Once completed, use the Win32 disk imager to write the image to the SDHC card that you formatted with SD Card Formatter. This will take a while.

Now you may boot your Pi with the SDHC card that you created. Select install and wait. Once complete you will need to do two more steps before loading programs. First, open a terminal window and type in 'sudo apt-get update' and press enter. Do not include the apostrophes. Once completed type in 'sudo apt-get upgrade' and press enter. These two previous steps do require some time.

Now, to get the software, keep the terminal window open and type in 'sudo apt-get install fldigi' and press enter. It will ask about using disk space so press y and enter. Type in 'sudo apt-get install flrig' and press enter. Again, it will ask about disk space and press y and enter.

In the upper left hand corner of the screen there is a raspberry. Click on it and scroll down to Ham Radio and click on it. You will see your two apps that you downloaded and installed. Connect your USB/Serial adapter to the Pi. In the terminal window type 'ls /dev/tty\*' and press enter. If you have only one USB serial device it will show /dev/ttyUSB0 for the device. Look at the sound card by typing 'aplay -l' (the last character is an L). Hopefully you will see a USB Audio device on the screen. Note the information to use when you configure the rig interface and the sound card.

### **fldigi for Windows**

Sourceforge.net is a resource for all sorts of free software to peruse. Take your browser to <https://www.sourceforge.net>. Next to the bold word Sourceforge there is a white box. Enter fldigi in the box and press enter. Scroll down to fldigi and click on it. There are some tabs that say Summary and Files. Click on files. You will see a list of Ham Radio related files. Click on fldigi and click on the setup.exe file to download.

Once downloaded, double click on the file and install it. Flrig, flmsg, and flarq are some more interesting programs. There are other programs in the Files listing that can be interesting as well. Have fun!

*Editor's note: Thanks again to Hugh for another very interesting Raspberry Pi article! In less than one page he has managed to squeeze all the information you need to obtain a Pi, download the operating system, boot it, install fldigi and flrig on the Pi, and locate its USB audio information. If that isn't enough, he tells us how to install fldigi, flrig, flmsg, flarq, and other goodies on our PCs. The next time you see Hugh, please tell him thanks for his expertise and hard work!*

## International Lighthouse Lightship Weekend

Submitted by Dan Lasley, NE7JN, contributions by Kevin Mulcahy, VK2CE



The International Lighthouse Lightship Weekend [web site](#) tells us this special event "... takes place on the 3rd full weekend in August each year and attracts over 500 lighthouse entries located in over 40 countries." This year's event will take place during the 48 hours from August 19 0001Z to August 21 0000Z and will be a great way to chase DX!

See the [Entrants List](#) for details on participating countries, call signs, and QSL information.

The ILLW web site [history page](#) says the special event began in 1993 with two members of the [AYR Amateur Radio Group](#) in Scotland, John Forsyth, GM400U, and Mike Dalrymple, GM4SUC (SK). The 11 stations (all in Scotland) participating in the first event generated about 8,200 QSOs. The [statistics page](#)

indicates the amazing growth of this event.

Thanks to Kevin Mulcahy, VK2CE, for the use of the ILLW logo. Kevin is the event organizer and webmaster. G'day, mate, and happy birthday on August 3rd!

## Summits On The Air

Submitted by Dan Lasley, NE7JN, photos courtesy of Pete Scola, WA7JTM

This part of the country is board flat or nearly so and no local terrain suggests the word "summit." At 2,753 feet, the highest point in Arkansas, Magazine Mountain, is about four hours west of here. The highest point in Mississippi, Woodall Mountain, 806 feet, is about two hours to the southeast. Tennessee's highest point, Clingmans Dome, rises to 6,643 feet, and is more than 7 hours east. While we have no close summits, those of you who are on HF regularly have probably heard or worked operators who are participating in Summits on the Air (SOTA).

The [SOTA history](#) page tells us that SOTA is not a club or society but rather an award program that came into being in 2002.

As described in [SOTA's Joining In](#) page, you can chase or activate summits. A chaser operates from the comfort of the shack and contacts activators; an activator hikes to the top of a summit and operates from there for chasers. The Joining In page tells how to do both, details the available awards, answers frequently asked questions, and more.

[The Associations](#) page shows 130 Associations scattered across the world; these 130 Associations provide 98,654 summits which are recognized by SOTA and are available for activation. If you want to be an activator, you should consider starting off with an easy one such as Mississippi's only summit, [W5M/MS-001, Choctaw County](#), about 35 miles southwest of Starkville.

By comparison to Mississippi, the [W7A - USA - Arizona](#) Association lists 21 regions and 2,483 qualifying summits!



Here is Pete Scola, WA7JTM, at the top of Humphreys Peak, 12,633 feet above sea level, the tallest peak in Arizona. Pete is the [W7A \(Arizona\) Association](#) Manager for SOTA. He has 306 summit activations (243 of which are unique), he has accumulated 2466 SOTA points, and has achieved both the Mountain Goat and Shack Sloth SOTA awards, the highest available.



Pete (left) has activated Humphreys Peak for Summits on the Air. What an incredible view!

Pete's qrz.com page says, "The next day this peak was covered with snow."

The folks behind SOTA have done an amazing job. See, for example, Arizona's [Association Reference Manual](#) (ARM) and [SOTA Online Resources](#) (SOR).

As a former Arizona resident, I looked at several regions in Arizona and was surprised to see that I've been to the top of a number of SOTA peaks. Shown below is [one](#) (the flat-topped extinct volcano under the word "FIVE").

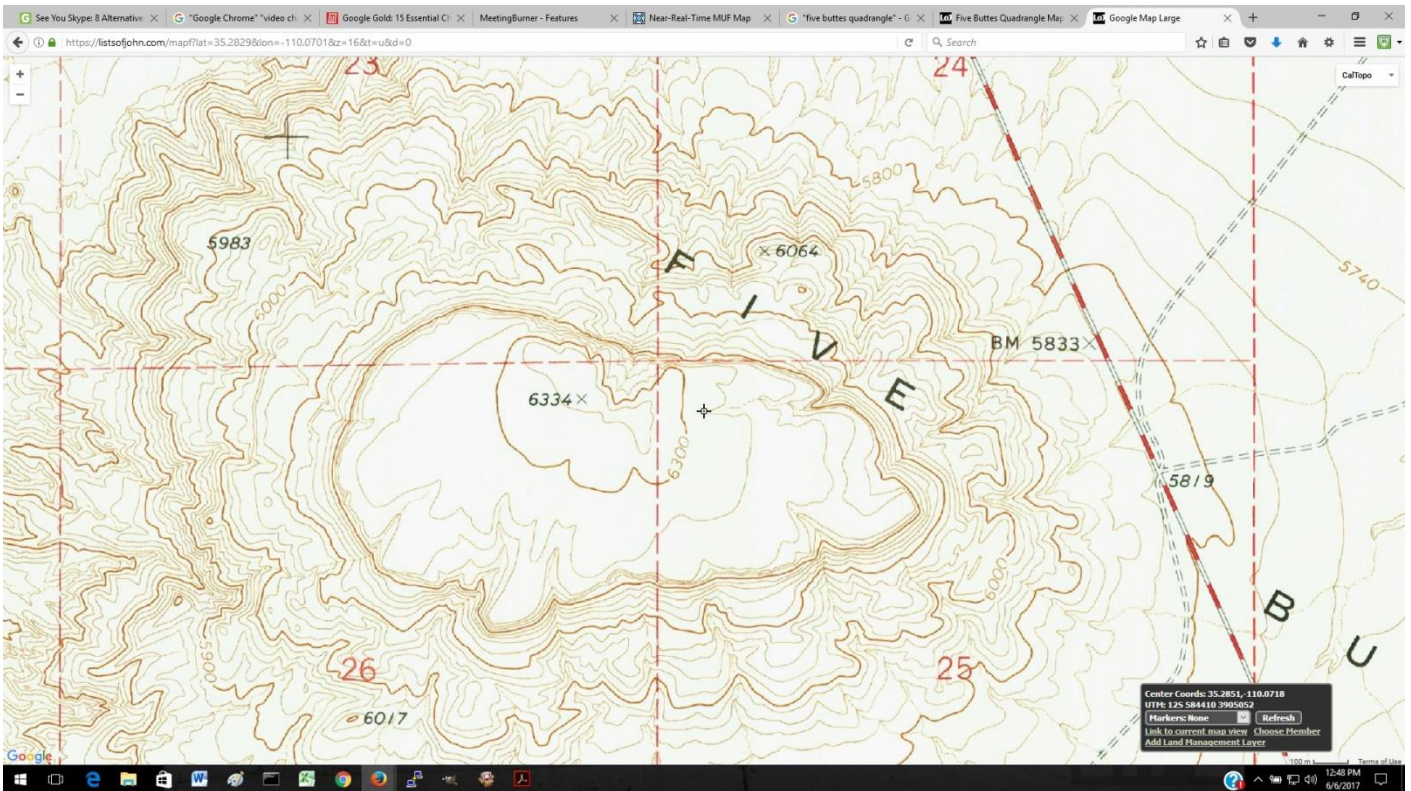

Unfortunately, at the time I didn't have a ham license, a radio, or a battery with me. Maybe next time I will!

## A Little More Light Reading

Submitted by Dan Lasley, NE7JN

Last month's [Sparks](#) featured an article entitled "A Little Light Reading" about the treasure trove of information in the Bell System Technical Journal. This month we'll look at another treasure trove, the 28 volumes of the MIT Radiation Laboratory.

[Wikipedia](#) tells us the "Radiation Laboratory officially opened in November 1940." Note that "radiation" refers here to electromagnetic radiation, not to the ionizing form of radiation. The Lab's first three projects "were (1) a 10-cm detection system [i.e., a 3 GHz radar] for fighter aircraft, (2) a 10-cm gun-aiming system for anti-aircraft batteries, and (3) a long-range airborne radio navigation system."

The first project "eventually became the [SCR-720](#), used extensively by both the U.S. Army Air Corps and the British Royal Air Force." The second project developed into the [SCR-584](#) "automatic-tracking microwave radar, ... one of the most advanced ground based radar [systems] of its era, and became one of the primary gun laying radars used worldwide well into the 1950s."

The third project, a long-range navigation system, became [LORAN](#) (Long Range Navigation), "highly successful and beneficial to the war effort. By the end of hostilities, about 30 percent of the Earth's surface was covered by LORAN stations and used by 75,000 aircraft and surface vessels."

After the war ended, Wikipedia says, "Most of the important research results of the Rad Lab were documented in a 28-volume compilation entitled the [MIT Radiation Laboratory Series](#)." Why would hams care about the 28-volume Rad Lab Series? Let's look at the titles of several volumes:

- Volume 5, [Pulse Generators](#)
- Volume 8, [Principles of Microwave Circuits](#)
- Volume 10, [Waveguide Handbook](#)
- Volume 11, [Technique of Microwave Measurements](#)
- Volume 12, [Microwave Antenna Theory and Design](#)
- Volume 13, [Propagation of Short Radio Waves](#)
- Volume 18, [Vacuum Tube Amplifiers](#)

If you can't find something of interest in one of these volumes, you aren't trying very hard!



The Rad Lab Series was published between 1947 and 1953. While the oldest volume is 70 years old and technology has immeasurably improved, each volume (with one possible exception) can probably teach you something.

The exception is Volume 27, [Computing Mechanisms and Linkages](#). In 1945 how would you have computed the tangent of an angle inside an auto-tracking radar system? You would have used some type of mechanical linkage:

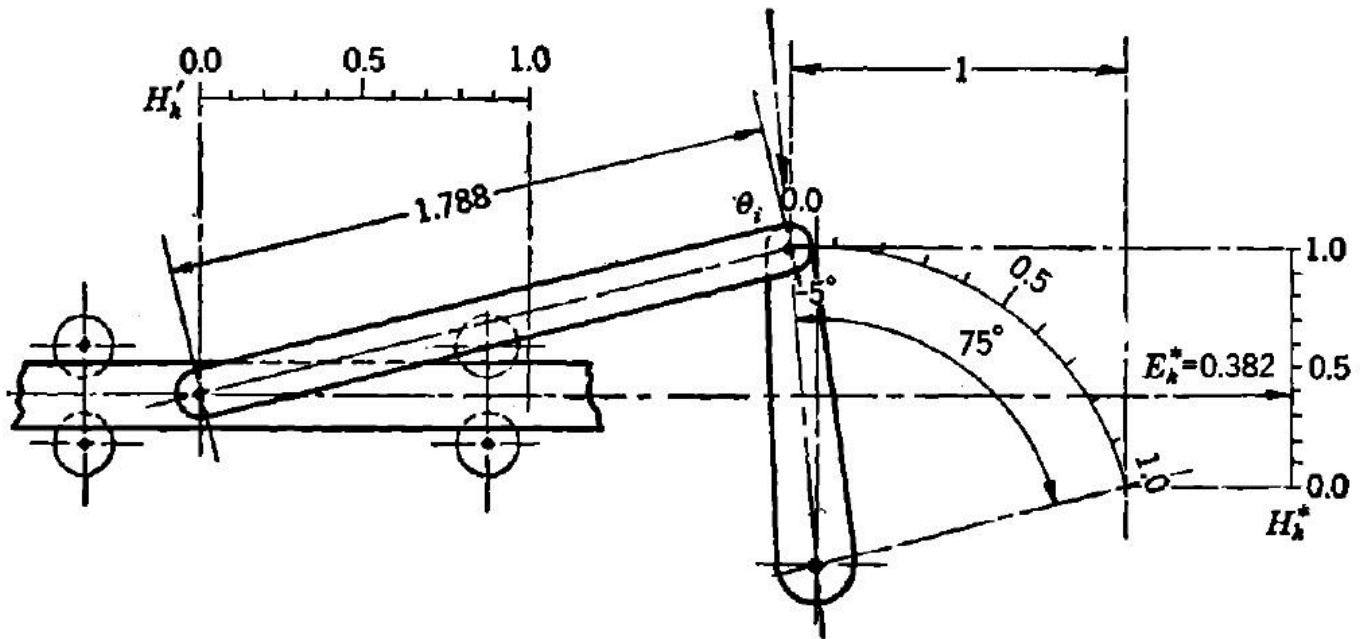

**FIG. 4-12.**—Harmonic transformer mechanizing  $x_2 = \tan x_1$ ,  $0^\circ < x_1 < 50^\circ$ .

<https://www.jlab.org/ir/MITSeries/V27.PDF>, page 77.

You would need a skilled tradesman to fabricate such a linkage. Note that it only works for angles greater than zero and less than 50 degrees. Volume 27 may be the only truly obsolete volume; today we would use an Arduino or Raspberry Pi or an equivalent very small computer for trig functions, no skilled metal worker needed.

While I was researching this topic, I discovered "Pulse: A Practical Technique for Amateur Microwave Work," parts I through IV, by Robert Guba, W1QMN, and John Zimmer, W2BVU, in the February through May, 1963, issues of QST. The authors mentioned adapting APG-5 and APG-15 radars from the tail gun position of a B-29. You'd likely have a tough time finding an APG-5 or APG-15 radar these days, but don't let that keep you from experimenting with pulsed microwave communications as W1QMN and W2BVU did.

I think you'll enjoy rummaging around in the Rad Lab Series. Even if you never venture above a wavelength shorter than 10 meters, you can add to your knowledge of HF propagation in the [Propagation of Short Radio Waves](#) volume.

## Odds and Ends

Submitted by Dan Lasley, NE7JN

Two articles from the ARRL Letter, July 13, 2017:



"The five CubeSats making up the [BIRDS-1 constellation](#) were deployed into orbit from the ISS on July 7. Amateur Radio stations that successfully decode the telemetry data and Earth images will receive a QSL card from the BIRDS team."



The tiny lighthouse in this image marks [Baker Island](#), the fourth most-wanted DXCC entity on Club Log's [DXCC Most Wanted List](#). The [Dateline DX Association](#) plans to deliver this DXCC entity to a radio near you at a date yet to be determined. Stay tuned.



Nuts & Volts Magazine offers "[Flight Computers for Sounding Rockets](#)" by Dan Gravatt. This extremely cool article shows a number of flight computers, several versions of which offer 2M transmitters! See also "The Brief Flight of the *Eclipse*" by Steven Ford, WB8IMY, QST, November, 1988, pages 50, 51.

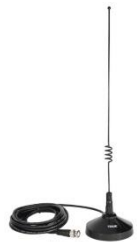

From the ARRL Contest Update for June 28, 2017: "Home Depot sells some [2m/440 dual band antennas and other antenna accessories](#) ... through their website. According to their website, orders can be picked up with no shipping costs if they're delivered to your local Home Depot, or shipped with a minimum order of \$45."



In "[Receiving Data with Web Based Shortwave Radios](#)", George Steber tells us the secret of decoding data transmissions using web-based shortwave radios, [Voicemeeter](#), [Fldigi](#), and [MULTIPSK](#). These pieces of software can decode CW, RTTY, Binary Phase Shift Keying, Weak Signal Propagation Reporter, weak signal digital modes JT9 and JT65, radio-facsimile, slow scan TV and EasyPal.



The 2017 [Tennessee QSO Party](https://tnqp.org) will be Sunday, September 3 at 1800Z through September 4 at 0300Z. See <https://tnqp.org/rules/> for the 2017 rules.

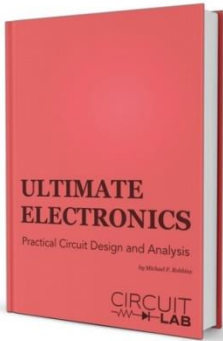

In a brief review of the on-line book "[Ultimate Electronics: Practical Circuit Design and Analysis](#)" by Michael F. Robbins, an anonymous [reviewer](#) writes, "It's a beginner's design and analysis course, not a beginner's electronics course. Ideally you should already know the basic component types from building other people's designs before you try to design your own circuits. There are plenty of free courses and web pages and YouTube videos that cover the novice material ..., but I haven't found much that fits this book's niche."



[JustRadios](#) sells capacitors, resistors and schematics for vintage tube radios and electronics applications.

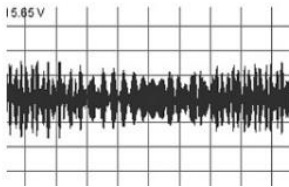

In "[Techniques to Improve Your Signal-to-Noise Ratio](#)," Nuts & Volts author Beau Schwabe shows how differential signaling can cancel noise. His figure 2 demonstrates how left- and right-channel common mode noise is canceled using the circuit of his figure 3.



Here is an old trick that works well. How many of you "[Use Light Bulbs as Current Limiters?](#)" (From The ARRL Contest Update for July 26, 2017.)

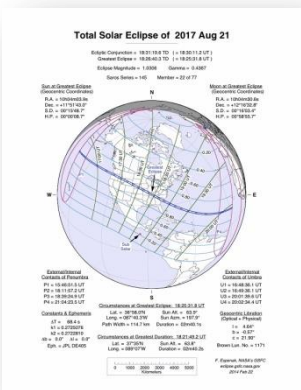

Nuts & Volts Magazine presents "[The Solar Eclipse and Ham Radio](#)" by Ward Silver, NOAX. Ward discusses The Eclipse and Radio, What are the Hams Doing, How Can You Participate, and more.

This is interesting reading whether you'll be inside twiddling the knobs on your rig or outside watching (carefully!) the proceedings.

NASA image from <https://eclipse.gsfc.nasa.gov/SEplot/SEplot2001/SE2017Aug21T.GIF>.

## SPARKS Newsletter & Delta Club Information

SPARKS is published monthly by the Delta Amateur Radio Club and emailed to club members. All information published in this newsletter is provided as a service. While every reasonable effort has been made to ensure accuracy, neither the Delta Amateur Radio Club nor its officers assume any liability resulting from errors or omissions. All correspondence may be mailed to:

Delta Amateur Radio Club \* P.O. Box 342768 \* Memphis, Tennessee 38184-2768

An alternative email address to offer the Board your suggestions, ask questions, and voice complaints is [darc4you@gmail.com](mailto:darc4you@gmail.com).

Please note that you must provide your name and call sign if you're requesting specific actions or personal follow-ups, and also be aware that any profane or mean-spirited comments will be unceremoniously discarded without consideration.

Delta Club Members Can Like Us/Follow Posts On Facebook! Go to <https://www.facebook.com/darcmem>.

### **2017 BOARD OF DIRECTORS**

#### **President**

[Ken Laseter, KI4AOH](#)  
901-853-0400

#### **Vice-President**

[Steve Frazier, KK4VPT](#)  
901-218-6385

#### **Secretary**

[Barri Munday, WB4SWP](#)  
901-756-5259

#### **Treasurer**

[Linda Laseter, KJ4CTX](#)  
901-268-1766

#### **Director of Training**

[Joe Lowenthal, WA4OVO](#)  
901-628-4318

#### **Director of Publications**

[Dan Lasley, NE7JN](#)  
901-827-5049

#### **Director of Programs**

[Kevin Zent, K4KLZ](#)

#### **Director of Meetings & Special Events**

[Scott Adams, KM4PMU](#)

#### **Repeater Trustee**

[Bill Stevens, WC9S](#)

#### **Public Information Officer**

[Len Grice, W4MKS](#)  
901-488-4195

#### **Immediate Past President**

Joe Wray, WD4GXI

Board members beginning their positions in 2017 are listed in *italics*.

## Public Service Events

If you are a coordinator for any of these events, please review the listed information. Please [email](#) corrections or additions.

<b>2017 Date</b>	<b>Event</b>	<b>Contact Information</b>
Jan. 15	<a href="#">Swamp Stompers 50K/25K Run</a>	<a href="#">Keith Barton, KT4EP</a>
May 6	<a href="#">March of Dimes March for Babies</a>	<a href="#">Linda Laseter, KJ4CTX</a>
June 17	<a href="#">Diabetes Tour de Cure</a>	<a href="#">Pat Lane, W4OQG</a>
Sep. 23-24	<a href="#">2017 Bike MS: FedEx Rock-N-Roll</a>	<a href="#">Darrell Sheffield, KK4D</a>
Oct. 7	Bluff City Blues 100 Ride	<a href="#">Danny Banks, KJ4FXZ</a>
Dec. 2	<a href="#">St. Jude Marathon</a>	<a href="#">Roger Schlichter, WR4R</a>

## Tennessee Ham Radio License Plate

Submitted by Joe Lowenthal, WA4OVO

The link below is for information and instructions about Tennessee ham radio call sign Emergency/Safety automobile license plates:

<http://www.tn.gov/revenue/article/emergency-safety>

The application can be found at this link:

<http://www.tn.gov/assets/entities/revenue/attachments/f1312601Fill-in.pdf>

As of July 1<sup>st</sup>, 2017, you must send a copy of or show an ARES membership card to keep from paying the \$25 surcharge for new plates or renewals. If you send a renewal in by mail with the lesser amount and do not include a copy of your ARES membership card, they will return your renewal and check due to insufficient funds.

If you want to become an ARES member, complete an ARES Registration Form FD-98 at <http://www.arrl.org/files/file/Public%20Service/fsd98.pdf>. Send completed form to Shelby County ARES c/o Joe Lowenthal, 6675 Ashbridge Cove, Memphis, TN 38120 or email to [wa4ovo@gmail.com](mailto:wa4ovo@gmail.com).

If you are not an ARES member and you do not want to pay the \$25 surcharge for renewal, you can get a regular plate for no additional charge. You will need a copy of your previous registration or there is an additional \$3 charge.

If a spouse is also a ham, only one of the couple needs to be an ARES member if the auto is registered in both names. If registered in the spouse's name, the spouse must have an ARES membership card.

The following link from the Tennessee Department of Revenue <https://www.tn.gov/revenue/article/emergency-safety> has the Amateur Radio auto tag information and listed below:

### **Amateur Radio**

Available to: Tennessee residents who hold an official FCC-issued amateur radio license (unrevoked and unexpired).

Documentation Required: Application supported with copy of the FCC Amateur Radio license.

Cost: Annual fee of \$51.50; Members of emergency, rescue squad and Amateur Radio Emergency Service - \$26.50.

## Other Notes of Possible Interest

Submitted by David Webb, KV4QI

It's Time to Renew Your 2017 Annual Memberships! Download the latest Delta Club [Membership Application Form](#). The 2017 membership renewal fee remains a very modest \$20 for an individual, with an additional \$5 fee for family membership. Thanks for Your Active Support of Delta Amateur Radio Club!

## Memphis Area VHF/UHF Nets

Updated September, 2016

Name of Net	Freq. MHz	Offset/Tone	Local Time	Day of Week
<b>Delta Club Information Net</b>	<b>146.820</b>	<b>- (107.2)</b>	<b>8:00p</b>	<b>Daily</b>
<b>YL Net</b>	<b>146.820</b>	<b>- (107.2)</b>	<b>8:45p</b>	<b>Sat</b>
Mid-South Barefooted Bullfrog Net	146.535	[simplex]	7:30p	Daily
Secret Service Net	224.780	[no tone]	8:30p	Mon
Elmer Net	145.210	- (107.2)	9:00p	Mon
The Short Winded Net	146.850	- (107.2)	8:30p	Tue
MedMERS Net	146.820	- (107.2)	12:00p	Wed
CERTPlus Net	443.200	+ (107.2)	8:30p	Wed
ARES Training Net	146.880	- (107.2)	9:00p	Thu
Super Sunday Niner Net	927.6125	- (146.2)	8:30p	Sun

**Delta Club sponsored Nets are shown in red.**

## TENNESSEE HF NETS

As of December, 2015

All times are Central Time

Net Name	Freq. MHz	Local Time	Day of Week
Tennessee CW Net	3.563	7:00p	Daily
Tennessee Slow CW Net	3.682	7:30p	Tue-Sun
Tennessee Alternate Phone Net	7.238		As needed
CUSEC (Center for United States Earthquake Consortium)	3.810		As needed
CUSEC (Center for United States Earthquake Consortium)	7.180		As needed

### 3980 kHz – TN Phone Net

Mon-Fri - 5:40 AM, 6:45 AM & 6:30 PM

Saturday - 8:00 AM & 6:30 PM

Sunday - 8:00 AM only

Holidays - 8:00 AM only

## DELTA CLUB ADVERTISEMENTS

See Advertisement Order Form for Instructions.



### MID-SOUTH AMATEUR RADIO SUPPLY (MSARS)

6631 Vallendar Cv., Bartlett, Tennessee 38135

tel: 901-371-9700 • fax: 901-266-3374 • web: [www.msars.com](http://www.msars.com)

#### CURRENTLY STOCKING

Antennas	Antenna Mounts	Connectors	Coax & Cable
HT	Magnet	UHF	RG-213
Mobile	Trunk Lip	"N"	RG-8/U Mini
Base Station	Roof Mount	SMA	RG-58
HF	Window Mount	BNC	450 & 300 Ohm
Wire	Swivel Ball	RCA	Rotor Cable

LDG Electronics	Accessories	Miscellaneous
Automatic Antenna Tuners	RF Chokes	Gordon West Books
Remote Tuners	Power Poles	Coax Seal
Brand Specific Antenna Tuners	Antenna Switches	Fuse Holders
Baluns	SWR/Power Meters	Remote Tuner Boxes
Ununs	Mic Holders	Dog Bone Insulators

**Owners/  
Operators**

**Steve  
W5VAA**

**Rosalinda  
WN2V**

**Ham  
W4GMM**

**Mid-South Amateur Radio Supply**, (MSARS.COM) is owned and operated by local hams who are dedicated to promoting the hobby and providing help to anyone interested in ham radio. We actively support the local amateur radio clubs and are ARRL members.

**MSARS** offers free antenna building classes each year and help many new hams with guidance on their first radio, setting up a ham shack, programming a radio and much more. We are proud to be a part of the ham radio community and are *here to help you*.

*Please thank our sponsors by using their services and mentioning that you saw their ad in the Delta Club SPARKS Newsletter!*

*This ad space is available*



## DELTA CLUB ADVERTISEMENTS

See Advertisement Order Form for Instructions.

### DELTA AMATEUR RADIO CLUB

P.O. Box 342768  
Memphis, TN 38134-2768

**DARC** Meeting: Second  
Tuesday of every month  
at Ellendale Church of Christ  
7365 Hwy 70, Bartlett TN



W4BS REPEATER SYSTEM  
146.82- 147.36+ (107.2Hz tone)  
224.42- 443.20+ (107.2Hz tone)



**Ben Richhart**  
Sales and Service Director

**Chick-fil-A at Paragon Place**  
6282 Poplar Avenue  
Memphis, TN 38119  
Phone: 901-766-1875  
Fax: 901-766-1878  
E-mail: ben@cfaparagonplace.com

*Please thank our sponsors by using their services and mentioning that you saw their ad in the Delta Club SPARKS Newsletter!*

*This space is available!*

*We offer our continued thanks to EMHC ambulance company for generously providing their training room for the many ham radio classes given there.*

**Delta Amateur Radio Club  
Sparks Advertising Order Form**

Date: \_\_\_\_\_

Name: \_\_\_\_\_

Call Sign: \_\_\_\_\_ Phone: \_\_\_\_\_ Email: \_\_\_\_\_

**TO PLACE AN ORDER**

1. Mark the box below indicating the ad size you are purchasing and the months you want your ad to appear in Sparks.
2. Submit this completed order form and your camera ready ad, via email at [sparks@carbheat.net](mailto:sparks@carbheat.net)  
Make check payable to Delta Amateur Radio Club (DARC) at monthly Delta Club meeting, or send US Mail to club mailing address at P.O. Box 432768, Memphis, TN 38134-2768. Camera ready means that ad copy is exactly as you wish it to appear, scaled to fit within the dimensions specified below. Ads may be submitted in .gif or .jpg format, or submitted as a hard copy (we will scan and place your ad for you).
3. Your ad order and payment must be received on or before the first Tuesday of the **month before** you want it to appear in Sparks.

**SPARKS ADVERTISING**

FULL PAGE			HALF PAGE			¼ PAGE			BUSINESS CARD		
<b>\$50.00</b>			<b>\$25.00</b>			<b>\$15.00</b>			<b>\$10.00</b>		
for 3 Months			for 3 Months			for 3 Months			for 3 Months		
7" w X 8 ½" h			7" w X 4" h			3 ½" w X 4" h			3 ½" w X 2" h		
Jan 2017	Feb 2017	Mar 2017	Apr 2017	May 2017	Jun 2017	July 2017	Aug 2017	Sept 2017	Oct 2017	Nov 2017	Dec 2017