

# Pennsylvania School Bus Driver's Manual



# **FOREWORD**

The Highway Safety Program of the National Highway Traffic Safety Administration, under the U.S. Department of Transportation's Federal Standard 17, requires each state to develop plans to reduce, as much as possible, the danger of death or injury to school children while being transported to and from school. This manual and the associated training course are Pennsylvania's response to this standard. This manual is intended as a means for certified instructors to deliver training courses effectively and uniformly to school bus drivers throughout Pennsylvania.

The course contained in this manual emphasizes fundamental concepts of school bus operation for the new driver and recertification (experienced) levels. This manual provides a basic foundation for new instructors, but also provides sufficient flexibility for enhancement and adaptation by the more knowledgeable and experienced instructors.

Organizations or individuals interested in pupil transportation and safety may freely use the contents of this manual in whole or in part, provided the material used is properly cited.

**THIS PUBLICATION IS NOT FOR SALE**

---

# ACKNOWLEDGEMENTS

The revision of this manual benefited from the help of many individuals. PennDOT's Bureau of Driver Licensing staff Scott Shenk, Chris Miller, and Laura Krol directed the project's technical aspects and served as lead reviewers. Additional support at PennDOT was provided by Troy Roadcap in the Bureau of Driver Licensing and Jacquie Turk in the Bureau of Highway Safety and Traffic Engineering. Rebecca Lorah and Matthew Hedge of PennDOT's Bureau of Planning and Research managed the contractual aspects of the project, and kept the project on schedule and on budget.

The project was completed by Pennoni Associates in conjunction with Rod Sams Consulting and Vance and Renz, LLC. Mark Hood P.E., Steve Thompson, and Rod Sams served as primary authors and were supported by Larry Bankert P.E. and Rosalind Murray. Robert Vance Ph.D. and Michael Renz led the crash data analysis efforts.

The Task Force, listed below, was responsible for the many changes in content and the reorganization of the material in this latest revision of the Pennsylvania School Bus Driver's Manual.

Burt Blackburn  
Director of Transportation  
Radnor Township School District  
Radnor, Pa.

David Lutz  
Director of Transportation  
Coalico School District  
Denver, Pa.

Maggie Broerman  
Director of Safety and Training, Central Region  
Student Transportation of America, Inc.  
Carnegie, Pa.

Selina Pittenger  
Executive Director  
Pennsylvania School Bus Association (PSBA)  
Camp Hill, Pa.

George "Rick" Comer  
Safety and Training Manager  
Customer Service Center Manager  
Durham School Services  
York, Pa.

Craig Poles  
Coordinator of Driver Training and Certification  
School District of Philadelphia  
Philadelphia, Pa.

Scott Downey  
Transportation Coordinator  
Lower Dauphin School District  
Hummelstown, Pa.

Dave Schlotter  
Director of Safety and Operations  
Brightbill Transportation, Inc.  
Lebanon, Pa.

Jane Gerhold  
Operations Manager  
Rohrer Bus Service  
Duncannon, Pa.

Gail Wolfel  
Supervisor of Transportation Services  
Unionville-Chadds Ford School District  
Kennett Square, Pa.

Wayne Johnston  
Director of Transportation  
School District of Springfield Township  
Oreland, Pa.

David Yarian  
Director of Transportation  
Derry Township School District  
Hershey, Pa.

---

Special thanks go to the following individuals for their outside review and comment on specific units or input into various legal or enforcement issues:

Barbara Schaefer, Ph.D., College of Education, Pennsylvania State University (Units B and D)

Shirley Woika, Ph.D., College of Education, Pennsylvania State University (Unit D)

Kristie Kaufman, M.D., Center Medical and Surgical Associates – Pediatrics (Unit I)

Brian Newcomb, M.D., Mt. Nittany Medical Center – Emergency Medicine (Unit I)

Edward Miller, Lower Moreland Police Department, Montgomery County

John Collins, Upper Merion Police Department, Montgomery County

Kathy Strotmeyer, Pennsylvania Chapter, American Academy of Pediatrics

---

# TABLE OF CONTENTS

## UNIT A

### THE SCHOOL BUS DRIVER: ROLE, RESPONSIBILITIES, AND REQUIREMENTS

INTRODUCTION .....	A-2
YOUR ROLE AND RESPONSIBILITIES .....	A-3
WHAT DO I NEED TO DO TO BECOME A SCHOOL BUS DRIVER IN PENNSYLVANIA? .....	A-7

## UNIT B

### STUDENT MANAGEMENT AND DISCIPLINE

INTRODUCTION .....	B-2
SCHOOL BUS DRIVER RESPONSIBILITIES .....	B-2
STUDENT RESPONSIBILITIES .....	B-4
DRIVER-STUDENT INTERACTIONS .....	B-5
CHARACTERISTICS OF STUDENT BEHAVIOR .....	B-9
GUIDELINES FOR CONTROLLING STUDENT BEHAVIOR .....	B-11
ASSERTIVE DISCIPLINE .....	B-13
GANG AWARENESS .....	B-15
BULLYING AND HARASSMENT ON THE SCHOOL BUS .....	B-16

## UNIT C

### STUDENT LOADING AND UNLOADING

INTRODUCTION .....	C-2
THE LOADING/UNLOADING AREA .....	C-3
LOADING PROCEDURES .....	C-4
UNLOADING PROCEDURES .....	C-6
UNIQUE DANGERS OF LOADING AND UNLOADING ZONES .....	C-8
ENFORCING THE SCHOOL BUS STOPPING LAW .....	C-8

## UNIT D

### TRANSPORTATION OF STUDENTS WITH DISABILITIES

INTRODUCTION .....	D-2
DRIVER RESPONSIBILITY .....	D-3
CONFIDENTIAL INFORMATION .....	D-3
GUIDELINES FOR MANAGING STUDENTS WITH DISABILITIES .....	D-4
TYPES OF DISABILITIES .....	D-6
TRANSPORTING STUDENTS WITH DISABILITIES .....	D-13

## UNIT E

### PREVENTIVE MAINTENANCE

INTRODUCTION .....	E-2
PRE-TRIP INSPECTION .....	E-2
PREVENTIVE MAINTENANCE WHILE ON THE ROAD .....	E-17
POST-TRIP PREVENTIVE MAINTENANCE PROCEDURES .....	E-22

---

## **UNIT F**

### **SAFE DRIVING**

INTRODUCTION .....	F-3
THE DRIVING TASK .....	F-5
DRIVER CONDITIONS .....	F-7
VEHICLE CONDITIONS .....	F-17
ENVIRONMENTAL AND ROADWAY CONDITIONS .....	F-17
CONTROLLING SPEED .....	F-30
STOPPING .....	F-31

## **UNIT G**

### **FUNDAMENTALS OF DRIVING A SCHOOL BUS**

INTRODUCTION .....	G-2
PREPARING TO DRIVE .....	G-2
KNOW YOUR ROUTE .....	G-4
FIELD TRIP / ATHLETIC TRIP CONCERNS .....	G-5
STARTING AND OPERATING A DIESEL VEHICLE .....	G-6
STEERING AND TURNING YOUR BUS .....	G-7
BACKING .....	G-10
MAKING A TURN-AROUND .....	G-12
STOPPING .....	G-13
CHECKING OVERHEAD CLEARANCE .....	G-15
APPROACHING RAILROAD CROSSINGS .....	G-16

## **UNIT H**

### **CRASH AND EMERGENCY PROCEDURES**

INTRODUCTION .....	H-3
EMERGENCY DRIVING TECHNIQUES .....	H-3
EMERGENCY PROCEDURES .....	H-10
EVACUATING THE BUS .....	H-14
EMERGENCY EQUIPMENT .....	H-19
SCHOOL BUS SECURITY .....	H-22
HOSTAGE AWARENESS .....	H-24

## **UNIT I**

### **STUDENT EMERGENCIES**

INTRODUCTION .....	I-2
MEDICAL LIABILITY .....	I-3
FIRST AID PROCEDURES .....	I-4
REPORT ALL INCIDENTS .....	I-13
FIRST AID EQUIPMENT .....	I-14

# UNIT A - THE SCHOOL BUS DRIVER: ROLE RESPONSIBILITIES AND REQUIREMENTS

INTRODUCTION .....	A-2
YOUR ROLE AND RESPONSIBILITIES .....	A-3
Your Role as a Driver .....	A-3
Attitude .....	A-3
You Are Important .....	A-3
You Are Responsible .....	A-3
You Are a Member of the Safety Team .....	A-3
Your Responsibilities as a Driver .....	A-4
Your Driving Technique .....	A-4
Your Passengers .....	A-4
Public Relations .....	A-5
Appropriate Dress .....	A-5
Your Supervisor and Fellow Employees .....	A-6
The Transportation Director/Your Supervisor .....	A-6
WHAT DO I NEED TO DO TO BECOME A SCHOOL BUS DRIVER IN PENNSYLVANIA? .....	A-7
Initial Requirements - First Step .....	A-7
Knowledge Test Authorization and School Bus Learner's Permit - Second Step .....	A-8
Training and Skills Testing Requirements - Third Step .....	A-8
The School Bus Driver Training Course .....	A-8
Health and Safety Requirements .....	A-10
Drug and Alcohol Testing for School Bus Drivers .....	A-11
Positive Test or Refusing to Take a Test .....	A-11
Driver Recertification .....	A-12
Completion of Report Form .....	A-13
Annual Physical Examination .....	A-13
Change of Information on License .....	A-13
Documents Carried While Operating a School Bus .....	A-14
Comprehensive Resource .....	A-14

# UNIT A - THE SCHOOL BUS DRIVER: ROLE RESPONSIBILITIES AND REQUIREMENTS

## INTRODUCTION

Transporting students to and from school is a necessary part of a sound education program. For a safe, efficient, and economical transportation program, competent school bus drivers and standard bus operation are necessary. At present, there are approximately 30,000 school buses in operation within the Commonwealth of Pennsylvania and about 40,000 licensed school bus drivers. For detailed Pennsylvania school bus statistics, visit the Driver and Vehicle Statistics link under the News, Facts and Stats Information Center of PennDOT's Driver and Vehicle Services website, [www.dmv.pa.gov](http://www.dmv.pa.gov)

Before you get behind the wheel of a school bus, you need to understand your role as a bus driver and your responsibilities to your passengers, your school system, your community and your fellow workers. These topics are covered in the first part of this Unit. The second part describes the requirements for certified school bus drivers in Pennsylvania.

If you are a new school bus driver in PA, you will receive a minimum of 14 hours of classroom training and six hours of one-on-one in-bus instruction. If you are recertifying to maintain your license, you will receive a minimum of seven hours of classroom training and three hours of one-on-one in-bus instruction.

**If you are not given the minimum number of training hours, do not sign the Training Report Form (DL-714). You may contact PennDOT's Special Driver Programs Unit at (717) 787-6453 or [ra-pdschoolbushelp@state.pa.us](mailto:ra-pdschoolbushelp@state.pa.us), if you have any concerns associated with your school bus driver training.**

Your employer may also provide you with additional training on the policies and procedures of the school district in which you will be working. Some of what you learn in this training might need to be adjusted to comply with your company's policies. For instance, in classroom training you might be instructed to notify a mechanic if you discover something wrong with your bus during a pre-trip inspection. Your company might require that mechanical complaints be reported to the dispatcher who notifies the mechanic. You should follow local policies and procedures as long as they don't violate state laws or regulations. Bring those to your employer's attention.



## YOUR ROLE AND RESPONSIBILITIES

The school bus driver plays an important role in the educational system. The role includes a number of responsibilities the driver must willingly accept.

### YOUR ROLE AS A DRIVER

Learning to operate a vehicle the size of a school bus is a difficult task involving knowledge of laws, regulations, visual and mechanical skills, judgments, decisions, and accurate responses. Your performance as a school bus operator is dependent on developing skills, acquiring necessary knowledge and maintaining a positive attitude.

#### **Attitude**

Learn how to keep a positive attitude and recognize your moods. If you are angry, do you drive more aggressively? Do you still greet the students with a smile? Your mood not only affects your driving, but those around you. Keep a positive attitude. You must be mentally prepared to make allowances for the poor attitude and driving of other motorists, and not allow the actions of other motorists to cause you to react emotionally and involve you in a crash.

School bus drivers must be mentally alert at all times. They must keep their concentration on what they are doing.

#### **You Are Important**

You, the professional school bus driver, are a very important person with a responsible part to play in the educational system. In many instances, you are the first representative of the school system to meet the children in the morning and the last to see them at night. You are in a position to have a large influence on a child's attitude toward school.

#### **You Are Responsible**

Your position as a school bus driver is to safely transport students from one place to another.

You are responsible for how you drive and for how you feel about your students, coworkers, and position. You need to have a positive attitude, if you want to be a safe and successful school bus operator who enjoys your work.

You should like working with and being with students. If you don't, you will find it hard to keep a positive attitude about your position as a school bus operator.

#### **You Are a Member of the Safety Team**

Safety starts with you. Perhaps no other area of educational operations demands more responsibility for student welfare than the transportation of students in buses on public highways, streets and roads. The driver is a very important member of the safety team, which includes students, parents, teachers, school administrators, and law enforcement officials. As a key member of this team, you must constantly strive to improve operational safety and efficiency.

## **YOUR RESPONSIBILITIES AS A DRIVER**

As a professional driver, you are expected to meet high standards of conduct. A school bus driver is more than a professional driver and is expected to meet standards of conduct higher than those of other professional drivers. Always conduct yourself in such a manner that your actions on and off duty will not be open to criticism. You are a role model for the students and a representative of the school district and your employer.

Student passengers and their parents place a great deal of confidence in you. You should act deserving of this confidence, including being:

- A dependable person who can be relied upon to carry out your duties;
- Emotionally stable to work effectively and patiently with students, parents, school officials, and the public;
- Mature enough to cope with unexpected and unusual situations;
- Interested in the welfare and needs of others;
- Willing to practice patience and understanding;
- Observant of all traffic laws, Pennsylvania Department of Transportation (PennDOT) regulations, and local rules, regulations and policies, which includes conducting at least a minimum of two emergency evacuation drills on your bus every school year;
- Neat and clean, as a symbol of the entire school system;
- Careful to refrain from using profanity;
- Well rested, so you are free from fatigue, and;
- Free from the effects of alcohol and drugs, including prescription and over-the-counter medication.

**A school bus driver also has the following specific responsibilities:**

### **Your Driving Technique**

When you transport a bus load of children to school every day in a wide variety of highway and weather conditions, you are charged with a serious responsibility. The vital links to safety – proper driver attitude, knowledge and skills – are developed through your interest in safe driving. Your ability to cope with a constantly changing driving environment demands both pre-employment preparation and continual in-service activity. You must constantly reevaluate your driving technique. It is important that you honestly evaluate yourself to ensure you are physically and mentally prepared for driving your bus.

A safe and defensive school bus driver must exercise self-control, alertness, foresight, judgment, and skills in handling and maintaining control of the bus at all times. A good attitude about safe driving and safety procedures is the best guarantee of the safest trip possible.

### **Your Passengers**

Try to establish a positive relationship with your passengers. Their conduct will depend a great deal on what you say and do. Greet your students in a personable and friendly manner whenever they board your bus, and if possible, learn their names. Your expression of interest in each child will help you to gain the confidence of your riders. Remember, an essential part of your job is to maintain discipline according to procedures established by your local school system. Since students desire recognition of their good traits and abilities, compliment good conduct, habits, and deeds.

If you explain existing rules at the beginning of the school year, you will usually have the cooperation of students. If students know drivers are fair and have their safety in mind, they usually accept the rules. Drivers should recognize each student's individuality. Drivers cannot maintain discipline and respect if they are too harsh or too lenient. Drivers who handle problems fairly and according to the rules get the respect of students, parents and administrators.

Under ordinary loading and unloading circumstances, communication between driver and passengers should be encouraged. You should help your passengers understand and follow what is considered normal and proper behavior on the school bus. Maintain a professional, yet friendly, relationship with all students. Refer to Unit B for additional information on Student Management and Discipline and to Unit C for additional information on Student Loading and Unloading.

### **Public Relations**

Public relations are directly related to the opinion people have of drivers and the school system. This opinion is formed by the way you, a school bus driver, complete your daily responsibilities. Careful, courteous drivers make good impressions; careless, thoughtless drivers create harmful impressions. For example, the school bus driver who weaves in and out of traffic attracts unfavorable attention and more negative comment than one who observes proper lane usage. One discourteous, irresponsible act reflects poorly on all members of the student transportation team and, more significantly, can create a safety problem.

In many school districts, the school bus driver is the only contact parents have with school personnel other than teachers. Good or bad impressions of the school can be conveyed by the driver's attitude toward students and their parents. You will encounter students and parents with a wide range of attitudes toward you and the school system. You should strive to be flexible and treat everyone in a courteous and professional manner. Your reputation in the community, your courteous treatment of children and their parents, and your willingness to better prepare yourself for your position will help parents and children to have confidence in you.

You should consider all law enforcement officers in the community, as well as crossing guards and school patrols as part of the safety team. Their job, as well as yours, is to ensure safety on the highways you travel. You should strive to develop good working relations with them – their authority and experience may be invaluable to you.

Building desirable public relations is a continuous process and depends on the attitude you bring to work each day. You can add to your system's reputation by showing pride in your work. This sustains a good public opinion.

Good relations within your organization are essential. Public relations begins with fellow employees. An organization whose members have mutual friendliness, interest and respect meets a major requirement of good public relations.

### **Appropriate Dress**

The way you dress and look affects many parts of your job. As a school bus driver, it is necessary to identify oneself as an adult, not a student. In order to accomplish this, the driver must dress in a manner designed to instill a degree of respect. If one dresses in a careless way, the driver cannot expect to receive the appropriate level of respect from the students on the bus needed to maintain good discipline.

Types of shoes should comply with school district safety recommendations. This typically eliminates wearing open-toed shoes, sandals, clogs, wooden-soled shoes of any type, or heels of more than two-inch height. The best driving shoe is one that has a flat sole, covers the entire foot and fastens securely. The type of shoe you wear could affect your ability to perform in a safe manner during an emergency situation.

**Your Supervisor and Fellow Employees**

Someone in your school district or company is assigned the responsibility of supervising you as an employee. The person is another member of the safety team and is vitally interested in the safety of your riders. Cooperation with your supervisor and fellow employees is essential to transportation safety.

The following are ways you can cooperate with them:

- Understand and support your written school policy;
- Communicate often with your immediate supervisor and accept his/her authority;
- Willingly accept your responsibilities and assignments;
- Don't repeat personal or confidential information;
- Always inform your supervisor of discipline problems, bus conditions, highway conditions, and changing pick-up/discharge conditions;
- Submit required forms and reports on time;
- Report any and all crashes or incidents, whether or not damage is apparent, including crashes with property, pedestrians, vehicles, animals, and passengers. Also report those crashes near, but not involving, your bus;
- Be helpful, assisting others in pre-trip inspections, and in school bus loading and unloading zones;
- Comply with your school district regulations regarding the number of chaperons that accompany students on various school activities;
- Never change a bus stop or route without permission from your supervisor;
- Maintain a positive attitude; and
- Help out with conditions such as routine overload, route adjustments, equipment repair, loading stop adjustments, and other areas of student safety.

**The Transportation Director/Your Supervisor**

You should consider your transportation director or supervisor as your adviser and partner in working with students on your bus, especially when working through discipline problems. The transportation director/supervisor should be informed of any significant problems that arise. In many larger schools, the day-to-day responsibilities of the transportation director are delegated to a transportation area coordinator or other supervisor.

The transportation director/supervisor is often responsible for:

1. Assigning drivers to buses;
2. Establishing bus routes, stops and turn-around locations;
3. Assigning passengers to buses;
4. Ensuring buses are in safe operating condition; and
5. Appointing monitors/aides as needed.

## WHAT DO I NEED TO DO TO BECOME A SCHOOL BUS DRIVER IN PENNSYLVANIA?

According to federal standards, each state must have regulations to ensure all school bus drivers are in good physical condition, of good character and skilled in the operation of their vehicles. They should have strong morals, an even temperament, the ability to adjust to the varying conditions of their job, and a positive attitude toward safety. To become a certified school bus driver in Pennsylvania, a person must meet several initial requirements and then successfully complete the training and testing requirements established by PennDOT.

### INITIAL REQUIREMENTS – FIRST STEP

To become a certified school bus driver in Pennsylvania, you must first obtain an appropriate Commercial Driver's License (CDL) Knowledge Test Authorization/Learner's Permit. To apply for a CDL Knowledge Test Authorization/Learner's Permit:

- You must be eighteen (18) years of age or older.
- You must obtain a Commonwealth of Pennsylvania School Bus Driver's Physical Examination Form (DL-704), which is to be completed by either your health care provider or a physician appointed by the local school board. You must obtain this form from your employer. When completed, make sure your employer gets a copy for your personnel file. If you satisfactorily pass the physical examination, the examining health care provider will issue a Physical Examination Certificate (DL-742). You need to keep the DL-742. It is a credential that must be carried when driving a school bus. The Physical Examination Certificate is valid for one (1) year.
- You must self-certify the type of driving in which you expect to engage using a DL-11CD. Drivers engaged in "Non-excepted" transportation are also required to submit a valid Medical Examiner's Certificate to maintain licensure.
  - Driving types are
    - NI - Non-Excepted Interstate Transportation: Interstate drivers who are subject to the Federal Physical Qualifications and Examination regulations. A Medical Examiner's Certificate must accompany this form.
    - NA - Non-Excepted Intrastate Transportation: Intrastate drivers who are subject to the Federal Physical Qualifications and Examination regulations. A Medical Examiner's Certificate must accompany this form.
    - EI - Excepted Interstate Transportation: Interstate drivers who are not subject to the Federal Physical Qualifications and Examination regulations. Therefore, a Medical Examiner's Certificate is not required.
    - EA - Excepted Intrastate Transportation: Intrastate drivers who are not subject to the Federal Physical Qualifications and Examination regulations. Therefore, a Medical Examiner's Certificate is not required.

Additional information, including examples, is available in the Commercial Driver Information Center on our website at [www.dmv.pa.gov](http://www.dmv.pa.gov).

- You must also complete the Commercial Learner's Permit Application (DL-31CD) and submit it along with the DL-704 with a check or money order payable to "PennDOT," for any applicable fee required with this form. The cost is prorated and can be calculated on the form. Note that the DL-31CD and DL-11CD are available on PennDOT's Driver and Vehicle Services website, [www.dmv.pa.gov](http://www.dmv.pa.gov) under Forms and Publications.
- Remember to submit the DL-704, DL-11CD and Medical Examiner's Certificate if applicable, and DL-31CD together with the fee.

Once these forms are completed and submitted, a Knowledge Test Authorization (KTA) and School Bus Learner's Permit can be obtained either through mail or same-day service available at PennDOT's Riverfront Office Center, Driver/Vehicle Customer Service in Harrisburg, or a Driver License Center. If the forms listed above and the fee are forwarded through the mail, the KTA and School Bus Learner's Permit will be returned in approximately 14 days from receipt of the documents.

Also visit PennDOT's Driver and Vehicle Services website for online driver and vehicle services.

## **KNOWLEDGE TEST AUTHORIZATION (KTA) AND SCHOOL BUS LEARNER'S PERMIT - SECOND STEP**

Upon receipt of these forms, PennDOT reviews your documents for correctness, license suspension and determination of medical competency. To see if you meet the physical requirements of the School Bus Driver Regulations (Title 67, Chapter 71 of the Pennsylvania Code), visit [www.pacode.com](http://www.pacode.com).

A CDL Knowledge Test Authorization and School Bus Learner's Permit are issued.

If you do not meet the physical qualifications required of school bus drivers, your application will be denied.

The School Bus Learner's Permit is the only document that allows you to operate a school bus. **You may not use the KTA for driving purposes.**

The KTA and School Bus Learner's Permit are valid for one (1) year. During this one-year period, you will be required to complete all knowledge and skills testing. The knowledge examination will consist of:

- Vision Test;
- Knowledge Tests, including, but not limited to general knowledge, Passenger Endorsement (P), School Bus Endorsement (S), and if you are going to operate a bus with air brakes, removal of the air brake restriction, if applicable. If you already have a CDL, you may just be pursuing the "P" and "S" endorsements.

## **TRAINING AND SKILLS TESTING REQUIREMENTS – THIRD STEP**

Pennsylvania law requires certain commercial learner's permit holders to wait at least 15 days before taking the examination to upgrade their driving privilege. You will need to check the bottom of your learner's permit for your driver test eligibility date. This date identifies the earliest date you are eligible to take your driving test. Keep in mind that you **MUST** pass all applicable knowledge tests before taking your skills test.

### **The School Bus Driver Training Course**

The Pennsylvania school bus driver training course is administered by local school districts, contractors or Intermediate Units (IU) under the supervision of PennDOT and is outlined in Section 71.5 of Title 67. This course is available to all public, private and parochial school bus driver applicants.

**To obtain a Pennsylvania School Bus endorsement (S), you must complete a minimum of 20 hours of instruction including at least 14 hours of classroom instruction and six (6) hours of one-on-one vehicle familiarity and driving instruction (in-bus training). ALL training must be completed by a certified school bus driver instructor. Also note that the in-bus portion of the training must be one-on-one training with a certified instructor.**

This requirement (commonly known as the New Driver Training Course) can be completed in two ways:

- Complete the full 20 hours of instruction before attempting to pass the skills examination administered by PennDOT or a state-certified Third Party Tester. This method is recommended by PennDOT.

- Complete 10 hours of instruction (seven [7] hours of classroom training and three [3] hours of one-on-one in-bus training) and attempt to pass the skills examination administered by PennDOT or a state-certified Third Party Tester. If successful, you have 120 days from the date the endorsement card is issued to complete the remaining 10 hours of instruction (seven [7] additional hours of classroom training and three [3] additional hours of one-on-one in-bus training). Note: check with your employer as to which completion method they require; some specifically prohibit the ‘splitting’ of training.

After completing the full 20 hours of instruction or the first 10 hours of instruction, you are issued a Certificate of Completion Card (DL-713). You will need to keep this card as it is required to test. State law (Title 75, Section 1607) requires that a person hold the learner’s permit to add or upgrade the commercial class for 15 days before they are eligible to take the skills test administered by PennDOT or a state-certified Third Party Tester, so check the bottom of your learner’s permit for your driver test eligibility date.

Your permit is valid for one (1) year, so your skills examination must be completed within 12 months from the date on your permit issuance. Also keep in mind that your New Driver Training is also only valid for one (1) year. If you do not pass your skills examination within one (1) year of the completion of the training, you must complete the training again.

When taking the skills examination, bring the following documents to the test site:

- A valid driver’s license (if you are a licensed driver);
- A valid Pennsylvania CDL learner’s permit;
- A valid Physical Examination Certificate (DL-742);
- A valid Certificate of Completion Card (DL-713);
- The current vehicle registration card for the bus being driven;
- A valid insurance card or proof of financial responsibility for the bus being driven; and
- A valid CDL of the person accompanying you that covers the class of license, endorsements (e.g., ‘P’), and commercial restrictions for which you are being tested.

You must be accompanied by a commercial driver who is at least 21 years of age and has all proper applicable endorsements to legally drive the bus to the testing point and back in case you fail the driving examination. All applicable knowledge tests must be successfully completed before taking the skills test regardless of your eligibility date.

The skills examination will be administered in three parts. Refer to Pennsylvania’s CDL Manual (Publication 223). The CDL Manual is available under Forms and Publications of PennDOT’s Driver and Vehicle Services website, [www.dmv.pa.gov](http://www.dmv.pa.gov).

<http://www.dot.state.pa.us/Public/DVSPubsForms/BDL/BDL%20Manuals/Manuals/Commercial%20Drivers%20Manual/Comm%20Manual%20English/PUB%20223.pdf>

- The safety inspection shall be the first part of the skills examination. Inability to correctly perform the air brake check will result in automatic failure of this portion, if applicable.
- The basic skills test is the second part of the skills examination. The test will be comprised of a selection of the following exercises:
  1. Simulated or discussed student discharge (scored as part of the skills test);
  2. Simulated or discussed railroad crossing (scored as part of the skills test);
  3. Forward Stop;

4. Straight line backing;
  5. Alley dock;
  6. Parallel Park (driver side);
  7. Parallel Park (conventional);
  8. Right Turn; and
  9. Backward serpentine.
- The on-road driving test is the third part of the skills examination. An automatic failure will occur if you commit any traffic offense, run over a curb or sidewalk or cause a crash. (An accumulation of minor infractions will also cause a failure.)

You are permitted to take the driving examination three (3) times on a valid CDL learner's permit. The examination may be taken only once during a given day. If you fail a portion of the test, you may return on another day and retake only the portion you failed. Note that you do not have to retake the sections you already passed. If you fail the driving examination three (3) times, you must reapply for a CDL learner's permit, pay the appropriate fee, and complete all training requirements again. If you fail to successfully pass the skills test within 12 months of your training completion date, you will be required to repeat all 20 hours of training.

When you successfully complete the test, your passing test results will be credited to your driving record. Once your record reflects that all minimum requirements have been met, you will receive a CDL displaying the "S" endorsement and a School Bus Endorsement card from PennDOT. If the full 20 hours of the training has been completed, the school bus endorsement card is valid for one (1) year. The School Bus Endorsement card is reissued annually by PennDOT, if the requirement for the annual physical examination is met. If you successfully pass the driving examination after completing only 10 hours of instruction, you must complete the additional ten (10) hours of instruction (seven [7] hours of classroom and three [3] hours of one-on-one in-bus instruction) within 120 days of the endorsement card issue date, or PennDOT will cancel your School Bus Endorsement card.

PLEASE NOTE: School bus drivers are required to carry three credentials when operating a school bus in Pennsylvania: a valid CDL displaying the "S" endorsement, a valid School Bus Endorsement card, and a valid physician's certificate. If you are going to operate a bus with air brakes, you must have the air brakes restriction removed (passing applicable knowledge and skills tests).

## HEALTH AND SAFETY REQUIREMENTS

You must be fit to operate a school bus with regard to the health and safety of the students being transported. To establish fitness you must:

- Comply with Pennsylvania Department of Health and any local school district regulations and policies regarding communicable diseases;
- Have a clean criminal history record as evidenced by Pennsylvania State Police criminal history check.
- Have a clean child abuse history record;
- Have no record of motor vehicle crashes or traffic violations determined to be excessive in number by your employer;
- Complete FBI clearance checks (fingerprinting); and,
- Be drug-and alcohol-free when driving, and you must not consume any alcoholic beverages within eight (8) hours prior to operating a school bus and never consume illegal substances.

Local requirements may be more stringent than those listed above.



### **Drug and Alcohol Testing for School Bus Drivers**

All CDL drivers operating commercial motor vehicles (CMVs) (i.e. transporting more than 16 passengers) on public roadways must be DOT drug and alcohol tested. This means any school bus driver required to possess a CDL, whether a full or part time driver must also be included in an employer's drug and alcohol testing program.

The regulations require a five panel testing for the following classes of controlled substances: marijuana, cocaine, opiates, amphetamines, and phencyclidine (PCP). Drug testing is accomplished by a urine sample while alcohol testing is accomplished by breath analysis or other screening test approved by NHTSA.

There are many different methods used in establishing a policy on drug and alcohol testing. As a new driver, you are responsible to know and understand the drug and alcohol testing policies for your company or school district. Employers are required by federal law to do testing as indicated in the following:

- 1. Pre-Employment Testing:** A new driver must be drug tested with a negative test result before an employer can permit him/her to operate a CMV on a public roadway.
- 2. Random Testing:** CDL drivers are subject to unannounced random drug and alcohol testing throughout the year. Random alcohol testing must be conducted just before, during or just after a driver's performance of safety sensitive duties. Once notified of a random test, drivers must immediately report to the designated testing location.
- 3. Post-Accident Testing:** This federally-mandated testing is required for any crash involving:
  - A fatality; or
  - Bodily injury requiring immediate medical treatment away from the scene AND the employee/driver has been issued a citation; or
  - Vehicle damage sufficient to require any of the involved vehicles to be towed AND the employee/driver has been issued a citation.

Note: Pennsylvania state law (Section 3756 of Title 75) requires testing after any reportable crash in a school bus.

- 4. Reasonable Suspicion:** Testing is done when a trained supervisor observes specific, contemporaneous, articulable objective facts indicating current drug or alcohol use.
- 5. Return to Duty:** After a positive drug and/or alcohol test or refusing to take a test, the employee/applicant shall be referred to a Substance Abuse Professional (SAP). Following the initial assessment, the SAP will recommend a treatment unique to that individual. If your employer does not have a "Zero Tolerance Policy" and allows an employee to return to duty following a positive test and subsequent evaluation and treatment, the SAP will recommend a return-to-duty test when the employee has successfully completed treatment and is no longer a concern to safety.
- 6. Follow-Up Testing:** After completing a return to duty test, follow-up testing will be performed for a period of one to five years with a minimum of six unannounced tests conducted during the first year. The number and frequency of tests beyond the minimums is set by the SAP based on his/her evaluation of the employee. Follow-up testing is separate and in addition to any other testing.

### **Positive Test or Refusing to Take a Test**

A drug or alcohol test is considered positive if the individual is found to have a quantifiable presence of a prohibited substance in the body above the minimum thresholds defined in 49 CFR Part 40. Any applicant or employee who tested positive or refused to take a drug or alcohol test must have a negative return-to-duty test and be evaluated and released by a SAP before returning to safety-sensitive work. There is no requirement the company pays for this treatment or schedules the SAP appointment.

## DRIVER RECERTIFICATION

State law requires you to renew your school bus endorsement every four (4) years, completing a minimum of 10 hours of instruction and the “S” endorsement knowledge and skills examinations. Recertification must occur in a school bus representative of the class of school bus the driver is licensed to operate, so test in the Class school bus listed on your license. The recertification skills exam is outlined in Chapter 71.4 of Title 67. Visit [www.pacode.com](http://www.pacode.com).

The instruction must be provided by a certified instructor and must include seven (7) hours of classroom training and three (3) hours of one-on-one in-bus training. This ten 10-hour course (commonly known as the driver recertification course) may be completed at any time during the 12 months immediately preceding the recertification date on your School Bus Endorsement card. PennDOT notifies you of this requirement through a notice mailed one year before your endorsement expires. **DO NOT LOSE YOUR RECERTIFICATION NOTICE; YOU WILL BE REQUIRED TO PRESENT IT TO THE EXAMINER WHEN TAKING THE KNOWLEDGE AND SKILLS TESTS.**

Upon successful completion of the training and testing requirements, a new School Bus Endorsement card is issued to you 45 days prior to the expiration of your current “S” endorsement. If you fail the skills examination three (3) times, your current School Bus Endorsement card must be surrendered to the examiner. You must then reapply for the “S” endorsement learner’s permit and complete all training requirements for new drivers outlined in the previous sections. Any training taken as a requirement for recertification cannot be counted toward new learner’s permit training requirements. If the recertification requirements are not completed before the recertification date of the School Bus Endorsement, you have one (1) year from that date to complete the training and testing requirements, but you cannot drive except to complete in-bus training and the skills test. If the requirements are not completed within this additional year, you must reapply for an “S” endorsement permit and repeat all training and testing procedures.

After PennDOT receives your recertification paperwork, a new School Bus Endorsement card will be mailed to you. If your old School Bus Endorsement card expired before, or shortly after, the completion of recertification training, you are not permitted to operate a school bus until receiving the new School Bus Endorsement from PennDOT. Remember, you must have the School Bus Endorsement card with you to operate a school bus.

When taking the examination for recertification, you must bring the following documents to the testing site:

- Your valid commercial driver’s license;
- Your school bus recertification notice;
- Your valid Physical Examination Certificate;
- The current vehicle registration card for the bus being driven; and
- A valid insurance card or proof of financial responsibility for the bus being driven.

## COMPLETION OF REPORT FORM

You, the school bus driver, will be asked to sign the School Bus Driver's Training Report Form (DL-714), verifying the minimum training requirements have been met.

PLEASE NOTE: Your signature on the Training Report Form certifies, under penalty of law, that the information contained on the form is true and correct.

WARNING: Falsification to authorities is a misdemeanor of the third degree and is punishable by a fine of up to \$2,500 and/or imprisonment up to one year.

**IF YOU ARE NOT GIVEN THE MINIMUM NUMBER OF TRAINING HOURS OR YOUR IN-BUS TRAINING WASN'T ONE-ON-ONE, DO NOT SIGN THE TRAINING REPORT FORM. You may contact PennDOT's Special Driver Programs Unit at (717) 787-6453 or [ra-pdschoolbushelp@state.pa.us](mailto:ra-pdschoolbushelp@state.pa.us), if you have any concerns associated with your school bus driver training.**

The safety of school children is the main concern of PennDOT. Compliance with every aspect of the School Bus Driver Training Program is essential to the safety of school children.

## ANNUAL PHYSICAL EXAMINATION

To maintain a valid School Bus Endorsement, you must pass an annual physical examination given by either your physician or a physician appointed or approved by the local school board. A Pennsylvania School Bus Driver's Physical Examination Form (DL-704) must contain the signature of the physician before sending it to PennDOT. Refer to Section 71.3 of Title 67 for details on this examination. Visit [www.pacode.com](http://www.pacode.com).

A letter is mailed to you approximately 90 days prior to the expiration of your school bus physical. The purpose of this letter is to remind you that your physical is about to expire. Your School Bus Endorsement card will not be renewed unless PennDOT has a current physical on file. You must pass the minimum requirements listed on the physical examination form. Additional medical information may be required to further determine physical competency. If PennDOT determines you are not physically competent to operate a school bus, your School Bus Endorsement will be cancelled. You may request a re-examination.

Upon passing the physical examination, the examining physician will issue a Physical Examination Certificate valid for one (1) year. This certificate must be carried whenever operating a school bus.

In addition to the annual School Bus Driver's Physical Examination (DL-704), commercial drivers engaged in "Non-expected" transportation are also required to submit a valid Medical Examiner's Certificate in order to maintain commercial licensure.

Additional information is available in the Commercial Driver Information Center on our website at [www.dmv.pa.gov](http://www.dmv.pa.gov).

## CHANGE OF INFORMATION ON LICENSE

A new camera card or photo license will be issued whenever you are adding or deleting an endorsement, removing a restriction or upgrading your class of license.

If you are changing your name or address on your CDL and "S" endorsement, you must complete form DL-80CD (Commercial Driver's License Application to Replace/Correct) and forward it to PennDOT with the appropriate fee. The DL-80CD is located under the Forms and Publications link on PennDOT's Driver and Vehicle Services website, [www.dmv.pa.gov](http://www.dmv.pa.gov).

## **DOCUMENTS CARRIED WHILE OPERATING A SCHOOL BUS**

The following current and valid documents must be carried by you at all times while operating a school bus:

- CDL, with Passenger and School Bus Endorsements;
- Pennsylvania School Bus Endorsement Card;
- Physical Examination Certificate (DL 742);
- Vehicle registration card for the bus being driven;
- A valid insurance card or proof of financial responsibility for the bus being driven; and
- DOT physical, if applicable (i.e., contractors who cross state lines). This physical is known as the Medical Examination Report for Commercial Driver's Fitness Determination and is available at [www.fmcsa.dot.gov](http://www.fmcsa.dot.gov).

## **COMPREHENSIVE RESOURCE**

For a comprehensive resource on virtually all aspects of becoming a school bus operator, visit the School Bus Information Center on PennDOT's Driver and Vehicle Services website, [www.dmv.pa.gov](http://www.dmv.pa.gov).

# UNIT B - STUDENT MANAGEMENT AND DISCIPLINE

INTRODUCTION .....	B-2
SCHOOL BUS DRIVER RESPONSIBILITIES .....	B-3
Student Seating Plans .....	B-4
STUDENT RESPONSIBILITIES .....	B-5
DRIVER-STUDENT INTERACTIONS .....	B-6
General Guidelines for Interacting with Students .....	B-6
Class: A Student Management Memory Aid .....	B-7
Serious Discipline Problems .....	B-8
CHARACTERISTICS OF STUDENT BEHAVIOR .....	B-9
Kindergarten and Elementary School Age Students (Grades K-5) .....	B-9
Middle-School Age Students (Grades 6-8) .....	B-9
Secondary Age Students (Grades 9-12) .....	B-10
Summary of Age-Level Characteristics .....	B-10
GUIDELINES FOR CONTROLLING STUDENT BEHAVIOR .....	B-11
Keep Discipline Private Whenever Possible .....	B-11
Stay Professional .....	B-11
Set Discipline Standards .....	B-12
Work with School Authorities .....	B-12
Don't Deal with On-Bus Problems when Loading and Unloading .....	B-13
ASSERTIVE DISCIPLINE .....	B-13
Non-Assertive Discipline .....	B-14
Hostile Discipline .....	B-14
Assertive Discipline .....	B-14
GANG AWARENESS .....	B-15
Gangs and the Bus Driver .....	B-16
BULLYING AND HARASSMENT ON THE SCHOOL BUS .....	B-16
Description of Harassment and Bullying .....	B-17
Reporting Suspected Child Abuse and/or Neglect .....	B-18

# UNIT B - STUDENT MANAGEMENT AND DISCIPLINE

## INTRODUCTION

This unit is a general guide to help you manage student passengers. General guidelines are presented, which you may need to adapt to meet the specific local policies approved by your school district's board of directors. **In disciplinary cases, always follow written school district policy. The person ultimately responsible to discipline students is the school principal.**

You, the driver, are often the first contact children have outside their homes every day. Your attitude toward them may set the stage for their conduct for the remainder of the day. Your words and actions can have a tremendous influence. Students are affected by what they experience while they are traveling to and from school. Undesirable conduct not only makes all passengers uncomfortable, but can jeopardize their safety. These experiences, good and bad, are an extension of the regular school day and become an important part of their education. Many of the same rules of behavior are in effect on the bus as in the classroom.

As a school bus driver, you are in the people business. Children, like adults, can be unpredictable and often have moods that reflect what is going on in their personal lives. These moods and changes in their life will be reflected in how they interact with you and with other passengers on the bus. Behavior is typically dependent on age and cognitive development, and can range from that of a toddler to a young adult. You should become familiar with the general characteristics for each age group with which you will be dealing, as well as how to apply positive techniques to manage student behavior.

In cooperation with students, parents and school officials, you are responsible for the safety of the students who ride your bus. You must be able to control them, and the bus during the ride, and during loading and unloading. The student ridership program should be a cooperative effort among students, parents, school officials, and bus drivers. A sound program makes the bus driver's job easier and improves transportation safety.

## SCHOOL BUS DRIVER RESPONSIBILITIES

School bus drivers have a significant responsibility to transport their students safely and efficiently to and from school. In order to do this effectively, you must create a positive atmosphere for travel, by implementing the following points:

1. Familiarize yourself with and abide by all rules, policies and procedures relating to student transportation.
2. Familiarize yourself with all assigned routes and designated school bus stops.
3. Maintain your passenger lists so they are up-to-date. These will be critical in an emergency.
4. Recognize the importance of establishing solid working relationships with students, parents, supervisors, and school administrators, especially when working to ensure proper student conduct.
5. Instruct students on proper behavior while on the bus and the consequences of improper behavior. Provide and enforce general policies regarding riding the bus, and instructions during emergency evacuation drills.
6. Conduct yourself in a professional and respectable manner.
7. Avoid becoming too closely acquainted with students; maintain a friendly but firm adult/student relationship. You should never put your hands on a student, nor should you grab, slap, hit, or shake a student.
8. Maintain order and safety on the bus at all times. Create an atmosphere where the rights of others are respected on the school bus and at the school bus stop. You can do this by:
  - a. Requiring an orderly entrance and exit;
  - b. Minimizing interior noise;
  - c. Controlling passenger movement;
  - d. Requiring silence at railroad crossings; and
  - e. Prohibiting transportation of unauthorized materials.
9. Keep rules of conduct reasonable and simple for students to understand. Deal with infractions promptly, firmly and fairly.
10. Handle minor infractions with school district approved consequences. In instances of serious or recurring misconduct, follow school district policy.
11. Present a positive image in dress, hygiene, language, and manner while on duty because you represent the school system.
12. Be considerate and patient with all children, especially young students or students with special needs. These children may be entering school for the first time and may be intimidated or frightened by all the new experiences. It is important to make these children feel safe and welcome. Some students with special needs will require repetition and practice to become clear on expectations. Others may react strongly to changes in routine or environment.
13. Keep the bus clean during both regular route and extra-curricular trips. Consider making this part of students' responsibilities by having them take any of their trash with them.
14. Remember to inspect the interior of the bus before a new group of students enters and again after they exit. This can help identify students who may be tampering with or destroying parts of the bus.
15. Consider keeping a daily log of events at the end of your routes.
16. Work with your school district to have a readily-available emergency contact list in case of an emergency, and ensure your communication system is operational.
17. Avoid negative verbal interactions, such as sarcasm, as these are not effective tools for student management.

## STUDENT SEATING PLANS

Check with your school district regarding the use of seating charts in your bus. It may be a good policy to establish and use seating charts for morning and evening runs, when possible. These charts are helpful in controlling student behavior and assist you in getting to know the students' names. This is particularly useful for elementary age students. Seating charts are especially helpful for a substitute driver and during an emergency.

Some things to consider when developing a seating plan:

1. Your route and the order in which students are loaded and unloaded at home and at school.
2. The medical conditions of the students. Keep in mind that you might not know this information. Otherwise, consider the following:
  - a. Students who are medically fragile or vulnerable and who need to sit further front where there is less bounce;
  - b. Students who are prone to seizures in certain light conditions;
  - c. Younger students and those in child safety seats who need to sit in the first few seats;
  - d. Students with respiratory conditions who need to sit away from the lift area and away from rear windows near the exhaust. Note that changes in temperature also tend to bother these students; and
  - e. Students who may need to sit over wheel wells for additional lower extremity support.
3. For evacuations, consider:
  - a. Which students can evacuate themselves;
  - b. Which students need help;
  - c. Which students could help others; and
  - d. Which students are in child safety seats.
    - i. They should not be in emergency exit rows; and
    - ii. Never seat a student next to a window, if there is a child safety seat in the aisle position.
4. Consider behavior by thinking about students who are compatible with each other and who aren't.
5. Consider supervision for behavior or a medical condition as indicated above.
6. Consider the age of the student. For example, some districts require grade levels to be seated together, chronologically from the front to the back of the bus. Know and follow your district procedures.
7. Consider your ability to observe the student.



## STUDENT RESPONSIBILITIES

Like the school bus driver, the student has responsibilities with regard to his/her behavior during the transportation process. Since poor student behavior on the school bus can be distracting to the driver and contribute to crashes, it is important to establish clear rules for the student to follow and for each student to follow them. All students and parents need to know and understand the rules, and that these rules were established for the safety of the students who ride the bus. Further, students and parents must also understand the consequences of unacceptable behavior. Often, your school administration will prepare lists of rules and regulations covering student behavior and distribute them to students and parents. The parents' active cooperation is also helpful. Therefore, students should:

1. Know the rules, and understand and accept responsibility for their actions.
2. Be respectful of the rights of other students.
3. Be on time at bus stop locations at home and at school. They should leave home in time to reach the bus stop five (5) minutes before scheduled pickup and avoid playing when waiting for a bus, especially right next to the roadway. Present clear safety procedures for walking on the highway or crossing roadways.
4. Be aware of the dangers involved in the loading and unloading zones, including the dangers involved with loose clothing, clothing accessories and personal items that can drop under the bus.
5. Enter and leave the bus at school loading and unloading zones and at bus stops in an orderly fashion, and follow instructions. They must be careful about their own safety and the safety of others. They must move without haste, crowding or pushing.
6. Upon entering the bus, go directly to their seats, and remain seated until instructed to stand and unload.
7. Keep the aisle clear at all times. Books, lunch boxes, instruments and book bags must be placed under the seat or held on the student's lap. **DO NOT BLOCK THE AISLE!**
8. Refrain from loud conversation, unnecessary noise and boisterous conduct.
9. Use appropriate language (e.g., no profanity permitted).
10. Never bring tobacco, glass containers, weapons, drugs, alcohol, or any other items that could distract the driver on the bus.
11. Keep all body parts and other objects inside the school bus. The driver will tell students when they may open and close windows.
12. Never tamper with or block emergency exits.
13. Keep hands and feet off other children and their possessions. Throwing materials, hitting, pushing, spitting, biting, tripping and rough behavior will not be tolerated.
14. Never tamper with or destroy the school bus. Students can be prosecuted for doing so.
15. Remain silent while the school bus is stopped at railroad crossings.
16. Be aware that transportation can be ultimately denied to students who act inappropriately.
17. Keep the school bus clean. Do not leave trash behind.

As a new school bus driver, you will learn the after-school route may be more demanding on the driver when compared to the morning route. After being in a classroom all day, students may have a lot of energy and a desire to release tension. You will need to develop a higher tolerance for the students' behavior on the after-school route, without allowing flagrant abuse of the privilege to ride the school bus.

## DRIVER-STUDENT INTERACTIONS

As a professional bus driver, you should always have a general knowledge of each of your passengers, including their names and general behavior. Since you have contact with the students for only a short time each day, you may not initially know as much about the students as their teachers, but often you will be assigned to a route transporting the same students for several years. This may give you a chance to develop relationships with students that other district staff may not have. You must not only know how to perform your job as a driver, but you must also know something of your riders' behavior patterns and a great deal about their reactions in order to safely pick up and deliver your passengers. Your main function is to transport the students to their destination and discharge them safely.

You must also know how to approach students in a way that will gain their respect. It is better to talk to students without shouting, showing anger or displaying irritation. Be careful to never threaten them with any action you cannot enforce. Give your instructions to the students without favoritism. If you overlook poor behavior by one student, you lose the respect of the other students. Strike a happy medium by being neither too lenient nor too harsh; both extremes are equally bad for the morale of the students on your bus. Your attitude should be friendly, cheerful and professional.

Building good bus conduct starts the first day of the school year. After arriving at your first destination and prior to unloading, stand and state the rules very clearly. Be sure to deal with the very first infraction promptly and firmly. It is much easier to prevent a bad situation than to correct one.

Work to build cooperation with your students by being friendly, courteous and helpful. Over time, high student morale will help you control the worst offenders. When offenders find that improper conduct is unacceptable to the group, they will think twice about doing things that cause them to "lose face" with the group. If your school district has a student court of inquiry, it can often help in enforcing discipline.

## GENERAL GUIDELINES FOR INTERACTING WITH STUDENTS

You can avoid many problems on the bus by recognizing good behavior and using proper techniques to reinforce that behavior. While it is often easier to use negative terms when dealing with behavior, it is much more effective to use positive comments to reinforce the good things that happen on the bus. Learn to recognize desirable behaviors and emphasize them with positive comments.

For example:

- "I saw you pick up that gum wrapper, Fred, and I appreciate it."
- "Jane, you were at the stop on time this morning. Good for you."
- "That's what I like to see."

If you learn to stress specific, positive and behaviorally-related activities on your bus, you will eventually eliminate the negative ones. Work to develop this skill. It will mean many safe and pleasant trips.

Remember the following points, when dealing with students:

- Though each student is different, do not allow special privileges for any student unless requested by the school administration.
- Observe the rights and privileges of each child only as long as he or she obeys the rules of good bus behavior. Riding is a privilege, not a right. The moment a student "gets out of line," deal with the offender fairly, impartially and in the same manner you treat all such offenders.

- Remember that all eyes are on you while you are driving the bus. Your words and actions have tremendous influence on your passengers. Speak quietly, clearly, confidently, and firmly when talking to the students on your bus.
- Praise students generously when they accept responsibility and show a general pattern of good behavior.

If you are faced with a discipline problem, pause and relax for a few seconds. Use this time to think about what you are going to say and do next. How you handle behavioral situations, appropriately and inappropriately, will be watched closely by the students for consistency, fairness and understanding.

1. If you yell, expect yelling back, if not at you, then at someone else.
2. If you praise, expect it to be picked up by others.
3. Expect and encourage discussion and openness with students, and you will get it.
4. Keep discussions short and simple.
5. Never use profane or obscene language or raise your voice above a level necessary to be heard.

A word of warning directed to the offender may be enough for a minor infraction. Avoid getting into lengthy discussions, while the bus is moving.

## **CLASS: A STUDENT MANAGEMENT MEMORY AID**

To help you remember important student management techniques, learn the rules represented by the letters of the word "CLASS." By remembering one easy word, you will be able to remember five simple rules for student management.

- |                    |   |
|--------------------|---|
| C = Consistent.... | Always be consistent with praise and discipline. Whenever a student behavior problem arises, follow through with the appropriate consequences.  |
| L = Limits.....    | Set limits and make sure the students are aware of them. They should be the same for all students.  |
| A = Attitude.....  | Have a positive attitude. A cheerful smile may change the behavior of a student. The attitude of the driver often becomes the attitude of the student.  |
| S = Share.....     | Share with the students what is expected of them. State the rules and their consequences. If the students do not know the rules, they cannot be expected to follow them.  |
| S = Support.....   | Support other drivers and exchange experiences. Other individuals may be able to assist in difficult situations. Also by sharing, common problems may be discovered and new techniques explored. Support is also available from your supervisors and from the school district, usually via the principal. |

## SERIOUS DISCIPLINE PROBLEMS

For problems of a more serious nature, such as a fight on the school bus, follow your school district's procedures for discipline or refusal of rights to ride the bus and apply the following general procedure:

1. Drive out of traffic to a safe location, stop and secure the bus. This may be in a parking lot or a driveway. The fact you have taken this action makes the students realize the situation is one out of the ordinary.
2. After stopping the engine and removing the ignition key, get out of your seat, and stand and face the students. Address the offenders in a courteous manner, but in a firm voice. Don't show anger, but all students must realize you expect an immediate, positive response.
3. Address the student(s) involved by name and state specifically what behavior you will not allow. Explain the district guidelines you expect the student to obey and you can enforce. Maintain control of yourself and avoid projecting hostility.
4. Relate your comments to a specific unacceptable behavior you want changed; don't humiliate the child involved. This may require repeating the action you expect (using the same words) several times. Limit this communication to what is not acceptable and what must occur to remedy the situation. Suggest an action that can be performed successfully.
5. Before you specify related consequences, be sure they are supported by existing policy and the school principal, you are willing to follow through, and **THEY ARE WITHIN YOUR POWER TO INITIATE.**
6. Once you are sure you are on firm and acceptable ground, and you have committed yourself, THEN relay the consequences. You cannot afford to initiate hollow consequences. You must take the action you have indicated. This emphasizes the point made in Unit A regarding your relationship with your transportation director/supervisor and with the school principal.
7. Don't forget to inform your supervisor as soon as possible after any confrontation. Make sure you document the incident, children involved and actions taken so a record is on file.

If these steps don't work, radio the supervisor or dispatcher; don't start the bus until you get a response.

**NEVER** ask or send students to telephone school officials. You are responsible for all students; keep them on the bus. If you are near the school, you also might consider turning the bus around and driving back to the school. Never order any student off of the bus. Always call for assistance and be prepared if there is not a response. A call to the local police is not out of the question if the violator(s) are creating a hazardous situation which would make transporting the students unsafe.

When working through more serious discipline problems, never physically move a student. In fact, be extremely careful about physically touching a child. If a change in seating is needed, do not direct the student to sit directly behind you, but to a seat where you can more closely observe the behavior. Also keep in mind you have no legal right to put the student off the bus, except at the student's regular bus stop or at school. Similarly, you cannot deny the student a seat on the bus the next morning.

Keep in mind there are behavioral approaches to help you with student management. However, it is most important to consistently follow established school district procedures.

If the situation escalates or requires additional attention, do not try to handle serious discipline cases by yourself. Refer all such cases to your supervisor or the school principal. Give all the facts, in detail, and be sure the entire problem is stated clearly. Usually the child who causes problems on the bus is also causing problems in the classroom. The school administrator has the whole picture of the child, while you, as a driver, know only about his or her bus behavior.

## **CHARACTERISTICS OF STUDENT BEHAVIOR**

As described below, kindergarten and elementary students behave differently than middle school and secondary students. By learning some of these characteristics, you will be better informed when managing the students on the bus.

### **KINDERGARTEN AND ELEMENTARY SCHOOL AGE STUDENTS (GRADES K-5)**

The kindergarten or elementary school age student tends to prefer a great deal of physical activity. Normally, these students have a problem staying in their seats. When they can't move, they often talk instead. Loud talking on the bus is a problem you will need a lot of patience to deal with, but absolute silence among students is not a healthy school bus atmosphere. Students vary in the amount of activity they need, and their behavior will vary from day to day. Students of this age have limited attention spans and short memories, and the day after an occurrence they may have forgotten all about it. For this reason, they rarely hold grudges against those who discipline them. Beginning bus drivers should not try to gain the children's favor by letting small misdeeds go unnoticed. Take prompt and continued action for all infractions of bus conduct.

These younger students tend not to pay attention to the feelings of adults, but, on the other hand, they care a lot about what the adults think of them. Some children can be actively rejected by their peers, sometimes because they are perceived as odd or have poor social skills. They also are sensitive to the opinions of other youngsters and sometimes tend to pick on children who do not fit in well with the group. If you transport students in special education and students in general education in the same bus, be alert to ensure the exceptional students are not being insulted or targeted.

Bullying can also emerge among older elementary school students. Bullying and other forms of victimization reflect individuals' lack of self-control, and bullies tend to seek victims who are insecure, anxious and isolated. Bus drivers should monitor children's behavior and provide appropriate intervention when bullying or harassment occurs or is reported. See the section below on bullying and harassment.

Be careful not to allow individual children to hurt themselves socially by setting themselves up as the "driver's pet." Some students who have not yet learned to get along with others may also misbehave to attract attention.

Given the way students of this age behave, you may be able to promote a group spirit "to make our bus the best." Many bus drivers have achieved excellent results by discussing bus rules with their students and making them "our rules." Some drivers develop a game of having each busload try to excel in keeping the bus clean, behaving well on the bus, and staying orderly when loading and unloading. This method requires considerable skill, and new bus drivers should consult experienced drivers before attempting to start this type of competition. Keep in mind, however, that art work, festive decorations, etc., should not be displayed on the bus. These can interfere with safe operations.

### **MIDDLE-SCHOOL AGE STUDENTS (GRADES 6-8)**

Students in the middle school are often centered on themselves and will argue to convince others or to clarify their own thinking. They begin to think more independently and critically, and also tend to become more focused on acceptance and popularity among peers. With adolescence and hormonal changes, middle school students may experience mood swings and begin to test the limits of adult authority. Social interactions may involve changing seats or loud conversations. Verbal and sometimes physical aggression can occur, sometimes in the form of bullying and harassment. Fads and conformity in communication and dress develops among peer groups. Some youth begin exploring with sexual activity, and a small percentage, especially boys, may become involved in gangs and other delinquent social activities.

## SECONDARY AGE STUDENTS (GRADES 9-12)

In the junior and senior high school age groups, girls tend to be more mature than boys, but teens remain highly socially self-conscious. Relationships between romantic couples emerge, and sometimes may cause trouble on the school bus when some of the students are “going steady.” Other students often shield “making out” in the rear of the bus. Be alert to stop such actions as soon as you spot them. Ingenuity in seating arrangements can help to prevent this problem. For instance, placing the senior girls opposite seventh grade boys may help.

Students of this age are very concerned about their dignity and want to be treated like adults, although they do not always act the part. They are apt to be erratic in their behavior, and they are usually very anxious to dress and act the same as all members of their group.

You must be very careful not to make remarks about administrators and teachers. Secondary school students are chronic gossips, and any belittling remark you make may be widely circulated and magnified when retold. Students may also pass on remarks unintentionally to parents and others.

Young bus drivers must expect the older students to resent any great show of authority. Do not hesitate to ask for help from your supervisor or principal to solve problems involving these students.

## SUMMARY OF AGE-LEVEL CHARACTERISTICS

The behavioral characteristics of elementary and secondary students are presented in summary form to assist you in dealing with these age groups.

### Kindergarten and Elementary Students can be expected to be:

- Physically active;
- Talkative (loud);
- Forgetful (predictably unpredictable);
- Insensitive to the feelings of others (may pick on students with physical or mental disabilities);
- Sensitive to adult criticism;
- Willing to cooperate in group projects; and
- Harder to handle in the afternoon than in the morning.

### Middle-School Age Students can be expected to:

- Change at different rates;
- Be vulnerable to bouts of low self esteem;
- Have new interests and abilities as well as many new feelings, thoughts, and concerns;
- Identify with their peer groups and want to belong;
- Seek limited independence and autonomy;
- Question rules and beliefs they had accepted at face value until now;
- Be easily offended and sensitive to criticism; and
- Behave erratically and inconsistently.

**Secondary Students have the following characteristics:**

- Girls will be more mature than boys;
- Girls will be more influenced by boys than vice versa;
- Boy/girl relationships may cause problems;
- Concerned with their dignity (image);
- Gossipy, repeat things to their parents;
- Resent authority;
- Organize in groups;
- More prone to vandalism; and
- Try to disturb the driver.

## **GUIDELINES FOR CONTROLLING STUDENT BEHAVIOR**

The following pointers can help you prevent and/or control discipline problems you may encounter on your bus.

### **KEEP DISCIPLINE PRIVATE WHENEVER POSSIBLE**

- If an individual breaks the rules of bus conduct, do not reprimand him or her in front of all the students riding the bus. Individual behavior problems that do not affect the others on the bus are best handled in a private manner.
- Avoid a showdown with a chronic troublemaker in front of the other students. Instead, report an incident to the principal or supervisor, and request their help in the matter.
- Do not threaten the entire busload for the misdeeds of a few. Focus your attention on the students creating the disorder; avoid disciplining all of the students when restoring order.
- It is a good rule never to say anything unpleasant to more than one person at a time. On the other hand, if general bus safety is being threatened by one or more students, a driver should point out their misbehavior in front of all bus passengers. A case in point is the lighting of matches by students riding the bus. Stop the incident immediately in front of the entire busload of students.

### **STAY PROFESSIONAL**

- Young people greatly resent any sign of favoritism. Avoid being too lenient with normally well-behaved students and too harsh toward those who have been causing trouble.
- Never lose your temper. In the event of an argument or misunderstanding, the less emotion you display, the less emotion you will rouse in the student. Avoid using threats or physical force. Be consistent in your actions.
- Young people tend to test adults to see how far they can go or how much they can get away with doing. Deal with this behavior fairly and firmly, avoiding harshness or unfriendliness. If students know that reasonably good behavior is expected of them at all times on the school bus, then you may not have any real disciplinary problems.
- Start out the school year being extremely strict and gradually lessen discipline, if bus behavior remains satisfactory. Students may also calm down during the course of the year. If a difficult child shows signs of calming down, do not hold a grudge; rather, show encouragement.
- Do not exchange wise cracks and gossip with the students, as your actions should aid the educational program of the school district. Avoid shouting, arguing, and obscene or profane language.
- Avoid biases against students. Do not prejudge students because of family name, background, appearance or neighborhood. Avoid being overly suspicious, but be alert for potential discipline problems.

- Act in a responsible manner. Show the importance of your job in your actions.
- Always be courteous to children. Provide compliments whenever possible.
- Keep alert. Do not ignore minor incidents; they can easily become major problems.

## **SET DISCIPLINE STANDARDS**

- Do everything possible to inform students they have important responsibilities in ensuring group safety.
- Settle discipline problems quickly.
- Handle serious discipline problems only when the bus is stopped.
- Seat any troublemakers near you where you can see them and observe their behavior.
- Display smooth driving skills; poor driving habits often increase student misbehavior and frighten younger passengers.
- Be firm, fair, impartial and consistent.
- Never lose your temper.
- Treat students as you would like your child to be treated.

## **WORK WITH SCHOOL AUTHORITIES**

Discipline on school buses is the biggest problem confronting school bus drivers, and the critical relationship to nurture is the one with school authorities.

While a school bus driver is not alone when it comes to solving discipline problems, he/she may be alone when a disturbance occurs. You are responsible for the conduct of students on your bus, but you must have the backing of the school administration to effectively discharge this responsibility. A copy of local school district rules should be posted in a conspicuous place in the bus. Always follow written school district policy. In cases of continued misconduct, report the student to the supervisor or school principal.

In many school districts, the first action taken is a reprimand. A withdrawal of bus privileges for a short period of time may occur next. If the student's behavior does not improve after returning, the privilege to ride the bus for the balance of the school year may be denied or the student may be transferred to another bus. Never put a student off of the bus for misconduct; you are not empowered to make the decision yourself. School officials may take this step after all other measures have failed to improve the situation. Keep in mind some districts will discipline a student while in school so as not to interrupt their educational experience. Some students will not come to school, if they are denied a ride on the bus.

Remember the following pointers:

- Always follow the local policy adopted by the school board.
- Supply a copy of the rules to each student and post a copy of the rules so every student is aware of your expectations.
- If any action taken by the school administration does not promote good or safe school bus behavior, ask to meet with your supervisor to discuss the matter. They can work with administration to emphasize the safety of the entire busload of students is threatened, if no action is taken against chronic offenders.
- Maintain close contact with the principal and secure their cooperation.



## **DON'T DEAL WITH ON-BUS PROBLEMS WHEN LOADING AND UNLOADING**

In order to get students to and from school safely and on time, you need to be able to concentrate on the driving task. Loading and unloading requires all your concentration, especially considering the number of injuries and other incidents that occur during these times. Don't take your eyes off of what is happening outside the bus. If there is a behavior problem on the bus, wait until the students have finished loading or have unloaded to a place of safety. If necessary, pull the bus over to handle the problem.

## **ASSERTIVE DISCIPLINE**

There are many differences between the students of today and the students of past decades, and past disciplinary techniques used by school bus drivers and other school officials/personnel are no longer as useful as they once were.

While there are many theories regarding behavior management for children, one respected set of guidelines and disciplinary skills known as assertive discipline, can assist school personnel, including school bus drivers with handling disciplinary problems (Canter, 1976, 1992). Assertive discipline was developed for classroom situations so teachers and other personnel would be able to understand and communicate their needs to students in order to meet the needs of the students. A more productive environment results when needs of students and teachers are met. Essentially, a key to this technique is catching students being "good," recognizing and supporting them when they behave appropriately, and on a consistent basis letting them know you like what they are doing.

Assertive discipline can and should be applied to school bus driver/student situations. School bus drivers need to have an orderly and quiet bus; students need a safe ride to and from school. The ride is much safer for the students when your needs are met. Along with the differences in today's students, individual bus drivers also differ. Each bus driver operates in a different manner and may allow behaviors other bus drivers will not allow. This creates a conflict for the student who expects you to react in the same manner previous bus driver. Assertive discipline can help you communicate your particular needs to the students. Although you should effectively maintain order on the school bus, you also need to avoid alienating students or infringing upon their rights. Setting limits for the students must be balanced with showing compassion and warmth.

An assertive discipline plan can be used by you to:

- Provide students with clear expectations;
- Help you handle all behavior (major and minor) problems consistently;
- Provide a common approach everyone understands;
- Prevent you from reacting emotionally or overreacting; and
- Remind you to frequently praise students and acknowledge positive behavior.

Disciplinary measures can be categorized into three types: non-assertive, hostile and assertive. These terms describe the methods used, not the person using them.

## NON-ASSERTIVE DISCIPLINE

There are two basic situations that can be classified as non-assertive discipline. First, if you do not clearly convey your wants and needs, then the student cannot be expected to follow them. A second non-assertive technique is to state your needs, but not back up the statements with actions. A bus driver who acts in a non-assertive manner is passive. Students will not usually cooperate with a non-assertive individual. If you feel you cannot handle student behavior, let students misbehave, back down when challenged, or feel overwhelmed, you are most likely a non-assertive driver, and you will need to change to manage student behavior.

## HOSTILE DISCIPLINE

On the other hand, hostile bus drivers express their wants and needs in (negative) ways that may violate the rights of the student. While students usually obey a hostile bus driver, they may become afraid of you and act more aggressively when threatened. If you find yourself yelling constantly, threatening students (and not following up), or using physical force, you are acting in a hostile way, which is not appropriate for a school bus operator.

## ASSERTIVE DISCIPLINE

Assertive discipline creates a positive environment in which the needs of you and your students are met. It creates a balance between the rights of each person, and a balance between the limits you place on students and the support you show for students. Because of this, the students trust and respect you (Canter, 1976, 1993).

Assertive bus drivers are neither hostile nor passive. They clearly state their needs and back up their statements with appropriate actions. Assertive drivers have a positive outlook and believe in their abilities. They communicate effectively and plan how to respond with actions. They are persistent and quick to respond in a meaningful way, operating in a take-charge manner, but aware of the support needed by each individual child. To summarize, assertive bus drivers:

- Are the boss on the bus;
- Say what they mean and mean what they say;
- Clearly and firmly tell students exactly how they want them to behave;
- Stay calm and use a normal tone of voice;
- Have a plan of action when students do not behave; and
- Reward students when they do behave. (Canter 1987)

To become an assertive bus driver,

1. Start with an assertive attitude—No student will stop me from driving a safe bus;
2. Speak assertively—calm, firm, clear, and without anger;
3. Have an assertive discipline plan:
  - a. Set clear, simple rules for behavior on the bus
  - b. Have consequences when students don't follow the rules and be sure consequences match the problem behavior; and
  - c. Provide positive rewards when students do behave.

Several obstacles may stand in your way as you try to achieve assertive discipline. First, you will not be able to influence a student, if you do not believe you can. It's easy to make excuses for poor student behavior, such as heredity, ignorance, peer pressure, inadequate parenting, socio-economic background, or environment. You need to recognize the difference between students who cannot control their actions and those who can, but choose not to control them. Even many students with disabilities can choose whether to display good or poor behavior, as referenced in Unit D.

Don't forget you must identify a student's individual needs for a given bus trip; they may be different for field trips than for routine trips. You must also be able to clearly state these needs to all students on the bus. Tell all students you expect them to behave well and tell them the consequences, should they choose to behave poorly. Reinforce these directives by following through with appropriate actions. This includes praise when a student does something well and discipline for poor behavior. All students must receive the same disciplinary sanctions, but recognize some students need more attention and support than others. Misbehavior in a student may indicate the need for extra attention.

No disciplinary plan is foolproof. Some students will continue to misbehave even when you have acted correctly. Sometimes you will need to ask the help of other drivers, a teacher, or the principal in dealing with a particular student or situation. The assertive discipline plan is a necessary tool for routine student management.

## **BE ASSERTIVE!**

# **GANG AWARENESS**

One unique student discipline problem that may arise is gangs. Gangs have become commonplace in most cities, and unfortunately their members and activities are present on the school bus. Kids are entering gangs as early as elementary school. While you, as a school bus driver, cannot control who is or is not recruited, you can report unusual or inappropriate behavior to your supervisor. Under no circumstances are you, the bus driver, to confront gang leaders or potential gang members. Explain to your bus riding students the rules of the bus (what is and is not acceptable behavior). If they misbehave, follow district policy.

Gang activity is extremely serious and sometimes deadly. Never interfere. Should you see gang signs or symbols on the outside or inside of the bus, report it and then remove it. If you or your students are approached by gang members, avoid a confrontation, leave the area as quickly and as safely as possible, then report the incident to your dispatcher.

## **GANGS AND THE BUS DRIVER**

Gang members generally bother kids who are not in gangs and are usually more interested in fighting rival gangsters, not a school bus driver. They usually associate only with fellow gang members. It is important to set and enforce rules on the school bus and at the school bus stop. Gang members need to know the school and school bus stop are neutral zones, and gang violence will not be tolerated. When speaking to a suspected gang member, do not disrespect the gang, their family members or friends. Speak one-on-one with the student, and do not belittle them. Treat them with the same respect all students deserve. If they misbehave, follow local school district policies.

Make sure you report all incidents that appear to be suspicious to the proper school district official. Listen to the kids on your bus since they often know what is going to happen long before the school district official or police are made aware of a problem. Some school districts may have 24-hour tip lines students should be aware of, if they are afraid to come to you. Refer to your school district policy.

A few summary points when dealing with gang issues:

1. Be assertive, decisive, firm, and fair. Lenient treatment of gang members is viewed as a weakness, and they will take advantage of your “weakness.”
2. Intimidation of gang members usually escalates into a confrontation and seldom creates respect. Remember, lectures to scare “gangsters straight” DO NOT WORK!
3. When gang graffiti is found, report it and remove it as soon as possible. It will attract rival gangs and/or invite more “writing on the wall” and vandalism of your bus.
4. Prevent conflict whenever possible. Experience has proven that an incident, no matter how minor today, can cause more gang-related or motivated acts of vengeance or reprisals as much as two or more years later.
5. Never insult or show disrespect for a gang member, particularly in front of his or her peers. In the gang subculture, no insult goes unchallenged.
6. Never be critical of gang clothing, slang, tattoos, jewelry, hand signs, rap music, graffiti, or other indicators of the gang subculture. This would be an obvious form of disrespect.
7. Never confront gang status, only behavior.
8. Never confront a gang member in the company of their gang peers. This invites resistance in normal society let alone in the gang subculture.
9. Never mimic gang activity by affecting a gang stance or throwing a gang hand sign.
10. Never call a gang member a “wannabe.” This is openly disrespectful and may induce the individual to prove you have underestimated them.
11. Never place rival gang members together.
12. Never assume you are safe just because you are encountering a gang member in a school bus.
13. Never physically confront a gang member.
14. Never underestimate the threat from a young or small gang member.
15. Never assume anything.

## **BULLYING AND HARASSMENT ON THE SCHOOL BUS**

While there is a great deal of research in the topics of bullying and harassment in the school setting, relatively little has been investigated in these topics on the way to or from school or on the school bus. One of the few recent studies that has been completed with high school students found more students reported being fearful of their peers on the school bus than they were during any other time of their school day (DeLara, 2000; 2002).

Harassment includes unfair and disrespectful remarks, written words, or pictures that are unpleasant and offensive. Similarly, a person is bullied when they are exposed repeatedly over time to the negative actions of one or more other students. These actions may range from stares and teasing up to and including physical assault. Research has found that two incidents of bullying occur on each bus ride, and a full bus and poorly supervised conditions are prime environmental factors for bullying (Raskauskas, 2005).

Sexual harassment, in particular, appears to be rampant among secondary students with 80 percent of students reporting sexual harassment, and half of all students admitting they sexually harass others (AAUW, 2001). This type of harassment has also been reported among middle school age students. In fact, one university researcher has indicated sexual harassment is a much more serious issue in public schools than most people have been willing to admit, and it's much more likely to occur in unsupervised venues like buses or bathrooms (Williamson and Aratani, 2005). Remember that sexual harassment is a form of sex discrimination and is illegal according to Title VII of the Civil Rights Act of 1964, as amended, which protects the adolescent at work, and Title IX of 1972, which protects the teen from sex discrimination at school.

## DESCRIPTION OF HARASSMENT AND BULLYING

Harassment includes unwelcome remarks or behavior that shows disrespect for its victims. It hurts and harms the students in long-lasting ways. No student should be treated in this manner.

- It is a deliberate or repeated behavior, which is unwelcome, not asked for, and not returned.
- It is intentional.
- The behavior can be verbal, nonverbal, visual, and/or physical.
- Examples of verbal harassment could include teasing someone about their body development or body parts; telling dirty sexist jokes; calling others names that have a negative sexual meaning; or saying something to someone about sexual acts.
- Examples of nonverbal harassment could include looking at another person in a way that makes them feel uncomfortable (suggestive looks, leering, staring), obscene gestures or whistling.
- Examples of visual harassment could include glaring or staring; obscene/ suggestive letters, notes, or graffiti; obscene/suggestive pictures taped on notebooks.
- Examples of physical harassment could include “purposely” brushing against someone’s body; “friendly” pats, pinches, grabs and holds; pulling down someone’s gym shorts; or using force to “physically hold/ corner” a person in one place.
- Examples of cyber bullying could include the use of e-mail, instant messaging, chat rooms, pagers, cell phones, or other forms of information technology to deliberately and repeatedly, harass, taunt, ridicule, threaten, or intimidate someone. This can occur on the bus or at a bus stop.
- The word “unwelcome” places responsibility on the receiver to tell the sender the behavior is unwanted.
- The student who is a victim may:
  - a. Suffer from loss of confidence or self-esteem;
  - b. Find it hard to study and pay attention; and
  - c. Dread or even avoid going to school or sports in which they anticipate harassment.

School personnel have a legal responsibility to protect students from known or reasonably foreseeable harm occurring during or in connection with school activities.

Harassment and bullying are not limited to children. Often the school bus driver has been the victim of harassment. If you feel as though you have been harassed, report the incident to your supervisor.

The bus driver should expect all students to travel with dignity and respect, and to arrive at school safely and ready to learn. In the transportation arena, we have an opportunity and obligation to be role models who will display and expect respect is always the order of the day. If a student confides in you, listen, and show understanding and support.

When you hear unkind, and humiliating remarks, respond immediately.

In her exploratory study, DeLara (2008) outlined the following strategies developed BY school bus operators, FOR school bus operators to help combat bullying and harassment:

1. Seat who are susceptible to bullying or being victimized children close to the driver;
2. Separate children who are fighting or having difficulty and assign seats;
3. Be “aware of everything” and watch for the moods and signs of troubled kids;
4. Talk with bullies about being respectful on the bus;
5. Intervene before anything happens and discuss with students;

6. Maintain a good relationship with each child;
7. Ask about interests and hobbies;
8. Try to engage potential bullies in positive conversations; and
9. Above all, talk to students with respect.

These strategies build on the strengths of aggressive children and distract them from disrespectful and disruptive behavior.

In cases of bullying or harassment, you as the school bus operator must document and report all incidents and allegations. Take all your concerns to your supervisor, principal or other designated school personnel.

## **REPORTING SUSPECTED CHILD ABUSE AND/OR NEGLECT**

In some unfortunate circumstances, you may encounter a situation where levels of bullying or harassment have severely escalated. School bus drivers have the unique opportunity to get to know their students. Often the same driver will be assigned to a route transporting the same students for several years. This gives drivers the chance to develop relationships with students that other district staff may not have. Because of this level of trust, it is possible that a student may disclose information to a driver or the driver may begin to observe behavior leading to a suspicion of child abuse or neglect.

Each school district and/or transportation department should have specific policies and procedures that must be followed to facilitate reporting of suspected child abuse or neglect. This may include specific forms for documentation or a designated contact person. Know your district's policies and procedures for reporting suspected child abuse or neglect.

Whether you are reporting through district channels or directly to Child Protective Services (CPS), the following information is needed to the extent available:

- Name, address, and age of child;
- Name and address of custodial parent/guardian;
- Nature and extent of injury/injuries;
- Nature and extent of neglect;
- Nature and extent of sexual abuse.;
- Evidence of previous injuries, including nature and extent; and
- Any other pertinent information supporting the reasonable suspicion of abuse, neglect, or the perpetrator.

The law protects any person reporting or testifying regarding suspected child abuse and neglect. You are immune from any liability resulting from such reporting/testimony.

# UNIT C - STUDENT LOADING AND UNLOADING

INTRODUCTION .....	C-2
Fatalities During Loading and Unloading .....	C-2
THE LOADING/UNLOADING AREA .....	C-3
Education .....	C-4
Physical Tools .....	C-4
When Selecting Loading Zones at a Bus Stop Follow These Procedures Carefully .....	C-4
LOADING PROCEDURES .....	C-5
Approach and Check .....	C-5
Stop .....	C-5
Load .....	C-5
Check and Proceed .....	C-6
UNLOADING PROCEDURES .....	C-7
Approach and Check .....	C-7
Stop .....	C-7
Unload .....	C-7
Check and Proceed .....	C-8
When in Doubt, Check it Out .....	C-8
UNIQUE DANGERS OF LOADING AND UNLOADING ZONES .....	C-8
Don't Deal with On-Bus Problems when Loading and Unloading .....	C-9
ENFORCING THE SCHOOL BUS STOPPING LAW .....	C-9

# UNIT C - STUDENT LOADING AND UNLOADING

## INTRODUCTION

In Pennsylvania, and across the nation, incidents during student loading and unloading are responsible for more school bus-related fatalities than any other source. While fatalities are very low, you must be vigilant during student loading and unloading to help prevent these incidents from occurring.

Listed below are descriptions of a few fatalities. Unfortunately, students are often killed by their own school bus because the driver could not see them crossing in front of or behind the bus. A particularly hazardous situation is when a student leaving the bus reaches a point of safety, then re-approaches the bus, slipping under the wheels as it proceeds. To prevent these situations, you must be very attentive at all times during student loading and unloading.

## FATALITIES DURING LOADING AND UNLOADING

- A student was waiting in his parent's vehicle across the street from the school bus stop. As the school bus slowed to approach the stop with its amber lights flashing, the student exited his mother's vehicle and darted in front of an oncoming vehicle. The student, a 6-year-old male, was struck and killed.
- A student was waiting at his bus stop when a car drove up on the sidewalk striking the student from behind. The student, a 10-year-old male, was killed.
- A student exited the school bus and crossed the street. The bus driver completed student drop off and pulled up to make a left turn. As the driver was turning, the student, a 9-year-old male, chose to run toward the bus and slipped on the ice and slid under the bus, being run over by the left rear duals.
- A student was exiting her bus after dark at her bus stop. An oncoming vehicle failed to stop for the flashing school bus lights and struck her with the left front bumper. There was no evidence the driver applied the brakes. The student, a 5-year-old female, died without regaining consciousness.
- A 5-year-old female student was run over and killed by the left rear wheels of her school bus after she had exited the bus.
- A 6-year-old male student unexpectedly ran back toward the school bus, after he had been discharged from the bus and was struck and killed beneath the left front wheels of the bus.
- A student arrived at his bus stop early and decided to cross the road to a store on the opposite side of the road. When the student came out of the store, he saw the school bus approaching his stop and was in a hurry to get back to the bus stop. As the 9-year-old male ran across the roadway in the direction of his stop, he was struck and killed by a passing vehicle.
- A student and his brother missed their bus at the assigned bus stop location. The students went to their old bus stop, which had been declared unsafe due to sight distance. The bus driver had been instructed by dispatch not to pick up the student at the old location. As the school bus driver was coming up the road, the two students were in the roadway attempting to stop the bus. The school bus driver opened her driver's window to tell the students she could not pick them up at the location when an approaching vehicle came over the hill. One student was able to get out of the roadway, but the other, a 16-year-old male, was struck and killed by an approaching vehicle. The bus did not have the eight-way light system in operation.
- A 4-year-old male student ran back toward the bus to pick up something he had dropped, and was struck and killed by the right rear dual wheels of the bus.
- A student was late getting to her bus. As she ran up on the right to catch her bus, the 10-year-old female was struck and killed by the right rear dual wheels of the bus.



Loading and unloading maneuvers expose students and drivers to many hazards. You must be aware of the proper procedures for driving the bus and maintaining student behavior while performing these maneuvers. Driving procedures can be found in Units F and G.

This unit presents procedures for maintaining safety during loading and unloading. These procedures include: controlling traffic; assisting students crossing streets or highways; seating the students; and loading and unloading the students. The procedures below also cover proper use of the eight-way light system at the bus stop.

## THE LOADING/UNLOADING AREA

While children are safest on the school bus, the school bus loading and unloading area is a dangerous location because children are at a greater risk of being struck. The 10-foot area immediately around the bus is known as the danger zone because it is the area where children entering and exiting the school bus are at greatest risk of being hit by a motor vehicle, or accidentally run over by their bus driver. It is shown below in Figure C-1.

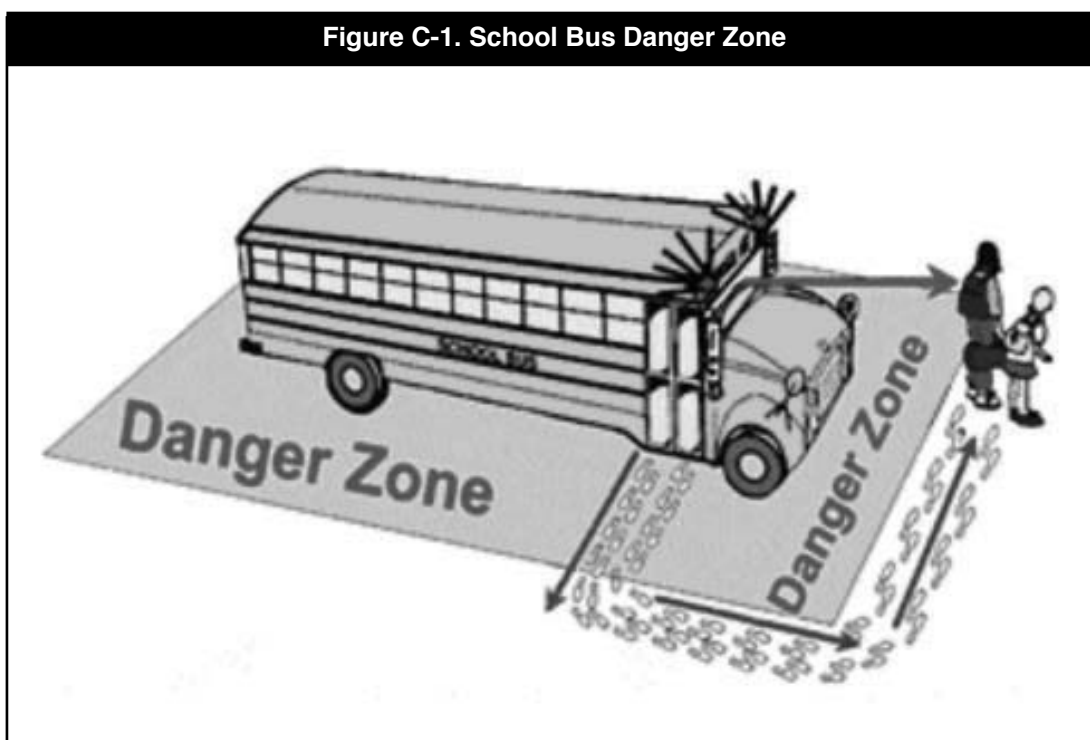

To help alleviate the danger in the loading and unloading area, the school bus driver has a number of tools at their disposal.

## EDUCATION

Educating children on how to be safe pedestrians is fundamental to school bus safety. Beginning with their first step onto a school bus, children must learn how to safely arrive at the school bus stop, board the bus, behave during the bus ride, exit the bus, and arrive home safely. Most of the time, children only get this information from the school bus operator. If the school bus operator doesn't instruct them on these items, chances are no instruction will be received until they get in trouble.

As a school bus operator, not only are you educating the students that ride your bus, you must also adequately warn (educate) other motorists of your actions when loading or unloading students. This is accomplished through different devices on the school bus.

## PHYSICAL TOOLS

All school buses in Pennsylvania are equipped with a school bus eight-way light system. This system consists of two amber flashing lights and two red flashing lights mounted on the front and rear of the bus.

School buses also have a side stop arm with a stop sign and a crossing arm. The crossing control arm, which is attached to the front of the bus, causes students to walk far enough in front of the bus so the bus driver can easily see them.

## WHEN LOADING AT A BUS STOP, FOLLOW THESE PROCEDURES CAREFULLY!

1. Load students only at designated bus stops approved by the school board. NEVER change a bus stop without approval by your supervisor. Student loading zones should be on the right side of the highway where visibility is clear. Refer to Chapter 104 of Title 67 for loading zone standards. Visit [www.pacode.com](http://www.pacode.com).
2. Students should wait at a specific designated place. This place should be at least 10 feet from the edge of the highway at the approved bus stop. You may often have to remind students after they board to stay back from the bus as it approaches.
3. Tell students to be on time according to district policy. Typically this means students are to be at the bus stop five minutes before the scheduled pick-up time. The driver and students share the responsibility of maintaining the bus schedule.
4. As a bus operator, if you are running late, don't speed to make up the lost time. Remember, it is safety first and schedule second.
5. If you arrive at a pick-up location early or on time and the student is not present, proceed with extreme caution. The student may be running late and be rushing to catch the bus. If you proceed without double checking, you may miss the location of the approaching child.

## LOADING PROCEDURES

### APPROACH AND CHECK

1. When approaching the designated stop, start slowing down in preparation for the stop. Evaluate the stop as far in advance as possible and approach at a slow rate using extreme caution. Look for pedestrians, traffic or people who may not belong at the school bus stop.
2. Always watch for late-arriving students who may be running to the bus stop. Use the mirrors to check for students to the rear of the bus.
3. When the loading zone is between 150-300 feet away (at most the length of a football field), activate the amber flashing lights of the school bus eight-way light system to warn other vehicles. Brake gradually with the transmission in gear while approaching the stop. The greater your approach speed, the greater the distance away you should activate your amber lights.
4. Check all mirrors to see if traffic is clear and it is safe for you to stop.
5. Approach students with extreme care giving due consideration to the surface on which you are going to stop:
  - a. When road and traffic conditions are normal, require students to stand at least 10 feet from the edge of the road. If students are not complying with this, remind them as they board the bus, before the next pickup.
  - b. When road surfaces are hazardous (e.g., slippery, rough), stop short of the bus stop, by as much as 20 feet, and ease the bus carefully to the stop. Instruct students to always wait a safe distance from the flow of traffic, especially in inclement weather.

### STOP

1. Come to a full stop;
2. When stopped, set the parking (emergency) brake;
3. Place the transmission in neutral;
4. Open the service door slightly (note this may not be possible with some automatic doors), activating the red flashing lights, side stop arm, crossing arm, and automatically deactivating the amber flashing lights of the eight-way light system; and
5. Check traffic to assure all traffic is stopped, and open the door completely ONLY after traffic stops.

### LOAD

1. Instruct students not to move toward the bus until the bus stops and the door opens. Make sure to count all the students while loading. This will let you know if you have picked up all of the students assigned to that stop on your roster.
  - a. When students must cross a roadway before getting on the bus, you must be able to see them at all times. When crossing in front of the bus, students should cross in front of the arm and should be able to see your face (at least 10 feet in front of the bus). If you have concern with a particular bus stop being at an unsafe location for students to cross the street (poor sight distance, long crossing distance for the student, etc.), let your transportation director/supervisor know immediately.
  - b. Be alert to warn students of an illegally passing motorist. Stress that students must look both ways before crossing the street or highway in front of the bus. Do not tolerate crowding or pushing. Have students board the bus slowly, in single file, and using the handrail.

2. Seat students according to local policy. Refer to Unit B for Seating Plans.
  - a. Keep in mind that seating capacity is limited according to the inspection sticker affixed on the bus by the Pennsylvania State Police. However, this rating is not an absolute; it is a maximum. Refer to Section 4552(d) of Title 75 as well as Sections 42, 69, and 144 of Chapter 171 of Title 67 for additional information on aisle and seating requirements.
    - Aisles shall be unobstructed at all times. Passengers may not be seated so as to encroach on the minimum aisle clearance.
    - A seating space at least 13 inches wide shall be provided for each passenger.
  - b. Remember that passengers are not permitted to stand while the bus is in motion.

## **CHECK AND PROCEED**

1. Check all mirrors around the bus for students.
2. When all students are accounted for, prepare to leave. Close the service door, which turns off the red lights, and retracts the stop arm and the crossing arm.
  - a. Wait for everyone to be seated before putting the bus in motion. Otherwise, you cannot expect your passengers to remain seated while the bus is in motion. You may consider requiring students to be seated before the door is shut to help prevent a driver behind your bus accidentally rear-ending the bus and causing standing students to fall.
  - b. Know the students assigned to your bus and be careful not to leave students stranded. Account for all the students on your bus.
  - c. When all passengers are seated, prepare to proceed to the next stop.
3. Using all mirrors, check traffic, put the transmission into proper gear, then release the parking brake.
4. Check child safety, recheck the mirrors and proceed safely to your next stop.

## UNLOADING PROCEDURES

When unloading students, you must make sure all of your students get safely across the street and out of the danger zone. Unload students only at properly designated bus stops. Use the following procedures when unloading students at a bus stop:

### APPROACH AND CHECK

1. When approaching the designated bus stop, start slowing down in preparation for the stop.
2. As you approach the bus stop, look in your mirrors to check traffic conditions.
3. When the loading zone is between 150-300 feet away, activate the amber flashing lights of the school bus eight-way light system to warn other vehicles. Brake gradually with the transmission in gear while approaching the stop.
4. Do not allow students to stand until the bus has come to a full stop.
5. Check all mirrors to see if traffic is clear and it is safe for you to stop.

### STOP

1. Come to a full stop;
2. When stopped, set the parking (emergency) brake;
3. Place the transmission in neutral;
4. Open the service door slightly (if physically possible), activating the red flashing lights, side stop arm, crossing arm, and automatically deactivating the amber flashing lights of the eight-way light system; and
5. Check traffic and open the door completely after traffic stops, and ONLY after traffic stops.

### UNLOAD

1. Do not permit students to leave the bus except at regularly assigned stops, unless they have written permission from a school administrator (Refer to school district policy). It is illegal for you to discharge students at places other than designated bus stops as per Section 3345(i) of Title 75.
2. Have students exit in an orderly fashion, counting them as they exit; this will let you know if you have dropped off all of the students assigned to that stop. Observe students as they step from the bus to see all move promptly away from the danger zone. Recount the students as they reach a place of safety outside of the danger zone, i.e. sidewalks, curbsides, or inside houses for door to door routes.
  - a. Instruct students who must cross a roadway after getting off of the bus to stand on the side of the roadway far enough in front of the bus to see your face (at least 10 feet). Be alert for passing motorists so you may warn students. The students are to look both ways before stepping into the roadway. They should cross in front of the crossing arm.
  - b. Instruct students who do not have to cross the roadway after unloading exactly where they should walk or wait until the bus pulls completely away. Tell them to never re-approach the bus.
  - c. Students should never cross the roadway behind the bus.
  - d. Take extra time with elementary school age students to make sure they understand these procedures. Be overly cautious when loading and unloading these students.

## CHECK AND PROCEED

1. Check all mirrors for students, and make sure students are not returning to the bus, and check for traffic and other pedestrians;
2. Close the service door to deactivate the flashing red lights, side stop arm, and crossing arm;
3. Check the mirrors, put the transmission in gear, release the parking (emergency) brake; and
4. Recheck child safety, recheck mirrors, and proceed safely to your next stop.

If you cannot account for a student outside the bus, secure the bus, (engage emergency brake, shut off the engine and remove keys) and get out and check around and underneath the bus.

## WHEN IN DOUBT, CHECK IT OUT!

The following is an example of an alert, quick acting driver who prevented a tragedy:

- During a noon return of kindergarten students at a stop with a wide shoulder, the bus was stopped and a student was unloading. The driver saw a car in her mirrors that was obviously committed to passing the bus on the right side. The bus door was open, and the child was going down the steps. The driver grabbed the child's coat and pulled her down onto the bus step.

Hopefully, you will be prepared to act in a similar manner if the situation arises.

## UNIQUE DANGERS OF LOADING AND UNLOADING ZONES

1. Dropped or Forgotten Objects - Always focus on students as they approach the bus and watch for any who disappear from sight. Students may drop an object near the bus during loading and unloading. Stopping to pick up the object or returning to pick up the object, may cause the student to disappear from the driver's sight at a very dangerous time. Students should be told to leave any dropped items and move to a safe place out of danger and attempt to get the driver's attention to retrieve it.
2. Handrail Dangers - Students have been injured or killed when clothing, accessories or even parts of their body get caught in the handrail or door as they exit the bus. You need to closely observe all students exiting the bus to confirm they are in a safe location prior to moving the bus.
3. Schools - Another area where serious incidents occur is the loading and unloading zones at the schools. You as a driver must train your students not to push and shove other students when they get on or off the bus. Teach the students to use handrails and go directly to their seats and face forward at all times.
4. **Students Left on the Bus - After your last drop off, in a safe location, make sure to walk to the back of your bus and check for sleeping or hiding students before returning to the yard.**

## WHEN POSSIBLE, DON'T DEAL WITH ON-BUS PROBLEMS WHEN LOADING AND UNLOADING

As outlined in Unit B, in order to get students to and from school safely and on time, you need to be able to concentrate on the driving task. Loading and unloading requires all your concentration, especially considering the number of injuries and other incidents that occur during these times. Don't take your eyes off of what is happening outside the bus. If there is a behavior problem on the bus, wait until the students have finished loading or have unloaded to a place of safety. If necessary, pull the bus over to handle the problem.

## ENFORCING THE SCHOOL BUS STOPPING LAW

While loading or unloading, check to make certain traffic in all directions obeys the red flashing lights as required by Section 3345 of Title 75 (Pennsylvania Vehicle Code). The following summarizes this section and provides some requirements for school bus operators to follow to help with enforcement. Note that Figures C-2, C-3, and C-4 illustrate examples of required motorist stops for school buses.

- On highways or trafficways not separated by a physical barrier, traffic in all directions must stop at least 10 feet away from the bus and remain stopped until every child has entered the bus (when loading) or has reached the sidewalk or side of highway (when unloading). Painted center lines, ridged or grooved roadway dividers, or a center turning lane do NOT create separate roadways or constitute a physical barrier; all traffic must stop on highways with these markings.



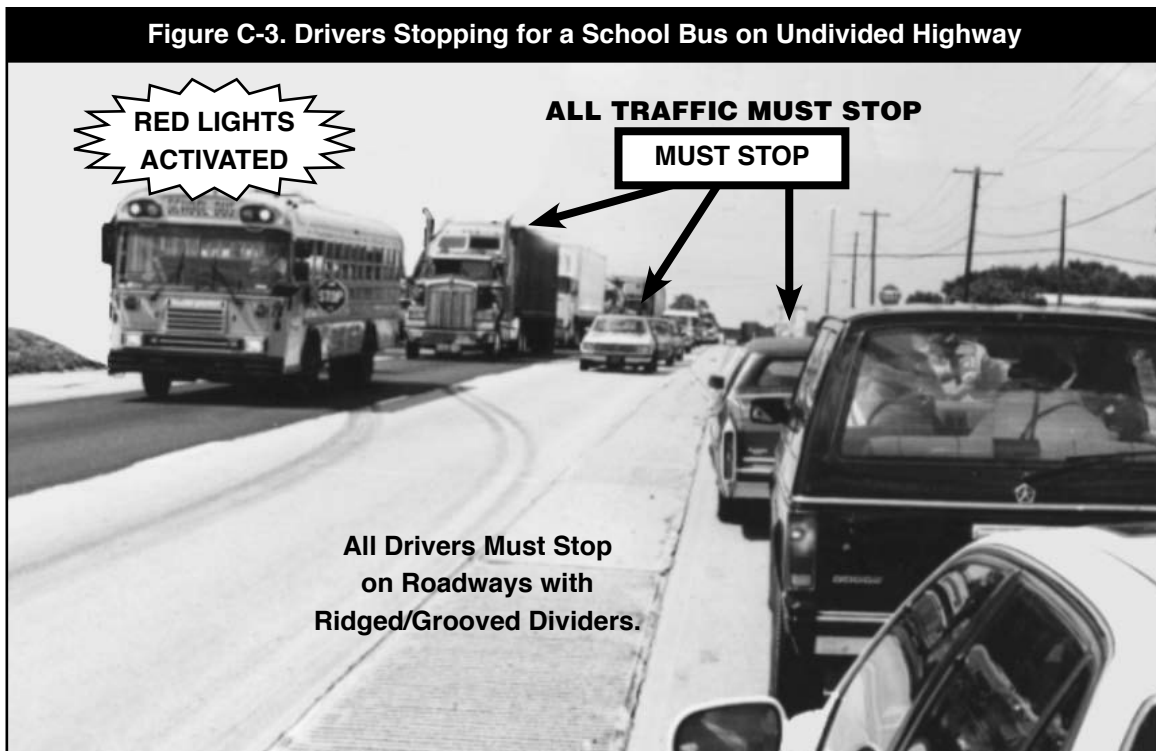

- On highways or trafficways separated by a physical barrier, traffic moving in the same direction as the bus must stop as described above. Traffic approaching the bus from the opposite direction may proceed with caution. A highway with separate roadways is divided into two or more roadways with physical barriers such as: concrete median barrier, metal median barrier, non-mountable curb or clearly indicated dividing sections (e.g., concrete mountable curb, trees or shrubs, rock or boulders, stream grass) to block traffic between the roadways.
- The driver of a vehicle approaching an intersection where a school bus is stopped to load or unload students must stop the vehicle at the intersection until the flashing red signal lamps are no longer actuated.
- You, as a school bus driver, should not be stopping in the middle of an intersection.
- If you are having difficulty at an intersection or drop off location, work with your transportation director or supervisor to find a better location.



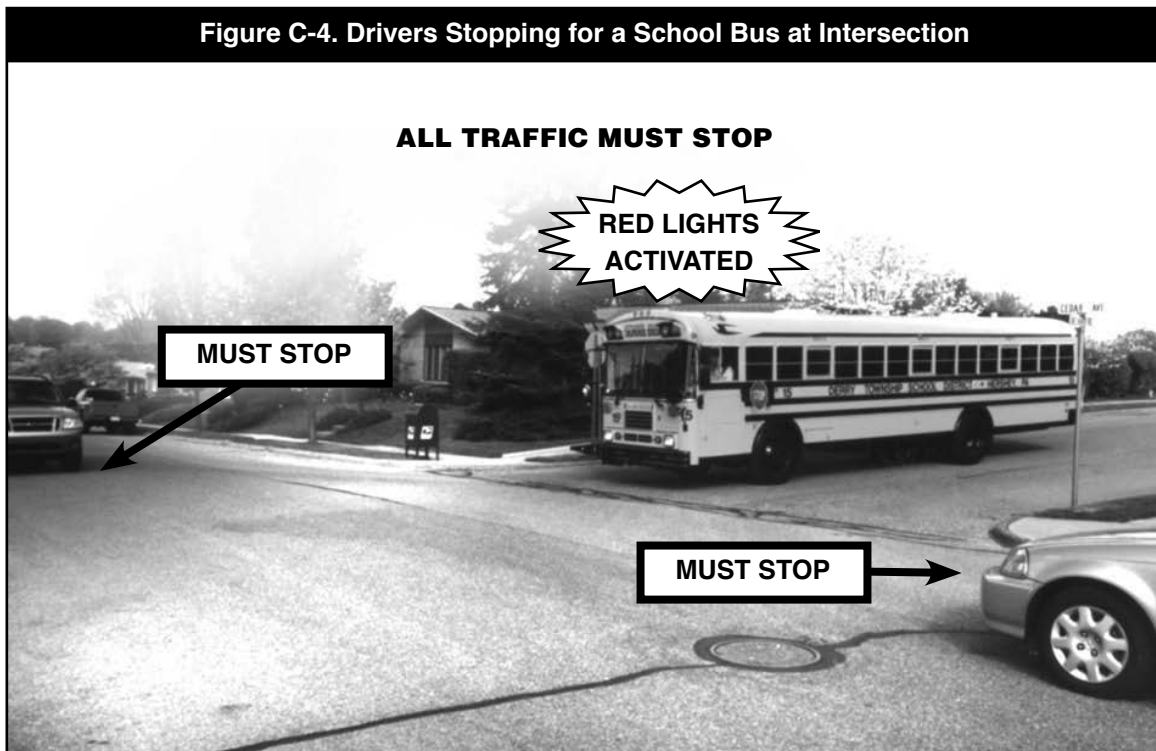

- Emergency vehicles (fire engines, ambulances and police cars) must also obey the red flashing warning lights of a loading or unloading school bus. In fact, Section 3105(h) of Title 75 states “... the driver of an emergency vehicle shall come to a complete stop when a school bus flashes its red signal lights and activates its side stop signal arms. After stopping, the driver of the emergency vehicle may pass the school bus only after exercising due diligence and caution for the safety of the students in a manner that will not risk the safety of the students.”

**If you see another vehicle disobeying these laws:**

- Try your best to warn students before they attempt to cross the highway;
- Note the license plate number, color and type of the vehicle; time and location of the incident; and identity of the driver (as much as you can tell). You must deliver a signed, written report containing this information within 48 hours to the state or local police with jurisdiction where the incident occurred.

When someone is convicted of violating Pennsylvania’s School Bus Stopping Law, they will receive a 60-day driver’s license suspension, five points on their driving record and a \$250 fine, plus court costs.

**THIS PAGE INTENTIONALLY LEFT BLANK**

# UNIT D - TRANSPORTATION OF STUDENTS WITH DISABILITIES

INTRODUCTION .....	D-2
DRIVER RESPONSIBILITY .....	D-3
CONFIDENTIAL INFORMATION .....	D-3
GUIDELINES FOR MANAGING STUDENTS WITH DISABILITIES .....	D-4
START: A Memory Aid for Managing Students with Disabilities .....	D-5
TYPES OF DISABILITIES .....	D-5
Autism .....	D-6
Deaf and Blind (Deaf-Blindness) .....	D-7
Deafness/Hearing Impairments .....	D-7
Emotional Disturbance .....	D-8
Intellectual Disability .....	D-8
Multiple Disabilities .....	D-9
Orthopedic Impairments .....	D-9
Other Health Impairments .....	D-9
Epilepsy .....	D-10
Tourette Syndrome .....	D-11
Attention Deficit Hyperactivity Disorder (ADHD) .....	D-11
Specific Learning Disability .....	D-12
Speech or Language Impairment .....	D-12
Traumatic Brain Injury (TBI) .....	D-12
Visual Impairments .....	D-13
TRANSPORTING STUDENTS WITH DISABILITIES .....	D-13
General Considerations .....	D-13
Bus Stop Procedures .....	D-14
Identifying Bus Stops .....	D-14
Loading Procedures .....	D-14
Assigning Seats .....	D-15
On the Road .....	D-15
Unloading Procedures .....	D-15
Modified Vehicles and Special Equipment .....	D-15
Modified Vehicles .....	D-15
Special Equipment .....	D-15
Emergency Procedures and Evacuation Drills .....	D-17

# UNIT D - TRANSPORTATION OF STUDENTS WITH DISABILITIES

## INTRODUCTION

There are two significant laws that ensure services to students with disabilities. The Individuals with Disabilities Education Improvement Act (IDEIA) is a federal law ensuring special education and related services to children with disabilities throughout the nation. IDEIA governs how states and public agencies provide early intervention, special education and related services including transportation. This law mandates that school districts provide transportation services for all eligible students, regardless of their disability. Chapter 14 of the Pennsylvania Code (Title 22) provides regulatory guidance in Pennsylvania to ensure compliance with IDEIA, and its regulations. This chapter can be found at [www.pacode.com](http://www.pacode.com).

A second major law related to students with disabilities is Section 504 of the Rehabilitation Act of 1973. This federal law assures other protected students with disabilities receive the accommodations and related services they require in order to access educational programs. Students who qualify for Section 504 services do not require specially designed instruction (or special education services which would require an IEP); however, they do require accommodations that may include specialized transportation services. The federal requirements of Section 504 are addressed under Chapter 15 of the Pennsylvania Code (Title 22).

Local school districts are responsible for providing individualized educational programs (IEP) for the students who qualify for special education services under the IDEIA within their district. The school district or intermediate unit is responsible for identifying, locating, evaluating, and providing services for all students who qualify for special education within its boundaries and placing them into appropriate programs planned uniquely for them. Students are required to be included in the least restrictive (e.g., general education) environment when appropriate, including ordinary transportation to and from school. Where this is not possible or appropriate, however, specialized transportation services are provided, often involving different types of vehicles and procedures. With this special transportation, these students can receive the education, therapy and other opportunities they need.

Although transportation is a privilege for regular education students, it is an entitlement for students with special needs. Transportation is typically listed as a related service on IEPs. If special considerations for transportation are warranted for students, they will be addressed within the 504 Service Agreement (or Chapter 15 Service Agreement).

The inclusion of special education and other protected students with disabilities in general education classes and transportation is increasing. Consequently, bus drivers must have a working knowledge of the guidelines for managing students with disabilities while they are being transported; and special transportation procedures used for these students.

This unit provides information on both of these topics. The position you hold as driver for these students may be one of the most demanding and difficult jobs you will ever have, but it may also be one of the most rewarding. Keep in mind that additional, more specialized training may be provided by your employer on these topics including the proper use of wheelchair securement devices and other occupant protection systems.

## DRIVER RESPONSIBILITY

Local policy is the guideline for your role and responsibility as a driver of students with disabilities. To ensure smooth pick-up and return of students, keep in mind:

- Stops will be established by the intermediate unit or school district staff in cooperation with the transportation provider. Changes in stops must be approved by the Transportation Department. You cannot establish or change bus stops.
- The student's home may be assigned as the pick-up and return location. If so, you may wish to introduce yourself to each student's parent(s) by telephone or personal visit, and tell them approximately what time you will pick up the student each morning and approximately when you will deliver the student home in the afternoon.
- Remind parents to have the student ready for morning pickup at least five minutes before your expected arrival. If the student is continually late for pickup, notify your supervisor. (Keep written notes of dates.)
- A responsible adult should be home to receive the student in the afternoon. If not, contact your supervisor. Never leave a student with a significant disability alone, especially if help at home is expected.

### **To ensure students' safety in case of a crash:**

- Keep a written description of your route, pupils' addresses, and their telephone numbers in a safe place. This information is critical to emergency response personnel.
- If you assign permanent seats in your bus, keep one copy of the seating arrangement in the bus and turn one copy in to the office.
- Coordinate activities with any aides, paraprofessionals, personal care assistants or therapeutic support staff (TSS) who may be assigned to assist specific students or the entire bus.
- Also keep written emergency seizure plans, local policies on allergy management, use of medication, etc. Be familiar with the plans and policies as described throughout this unit and in Units H and I.

## CONFIDENTIAL INFORMATION

By law, information contained in school records is confidential. No one should see school records unless he/she has an educational interest in the child. Typically, only individuals who are responsible for some aspect of a child's educational program have an educational interest. As a bus driver, you are entitled to know certain information regarding a child's disability, and it may be shared with you, if you have a legitimate educational interest as a service provider. However, it is your duty to keep the information confidential. This means you cannot share records or information about a child with anyone who does not have an educational interest. More specifically, you cannot talk about a child's special needs with other students, parents of other students, or other bus drivers who do not provide transportation services for the child.

You will have to talk occasionally to parents and teachers about transporting a student. Apart from these practical conversations, do not discuss anything concerning students, parents, teachers, classes, or vehicles with parents or neighbors. If anyone raises a question, refer them to the proper source, i.e., teacher, principal, or supervisor. Never hold any discussions in front of the students.

Obtain medical and emergency information for each student from your transportation director or supervisor. Any medications used by the student, their administration, and any possible side effects should be included for each student as applicable. This information must be kept current and accessible to aides and substitute

drivers who will work with the students on your bus. Note any unique behavior patterns to watch for and procedures for managing any circumstances that might arise while the student is under your supervision. If you feel behavior patterns warrant additional attention, contact your supervisor. **Work closely with your employer to determine the extent of your duties regarding the administration of medication: FOLLOW YOUR LOCAL POLICIES.**

## **GUIDELINES FOR MANAGING STUDENTS WITH DISABILITIES**

To manage students with disabilities while transporting them, you must know individual specific behavior patterns and required treatments. All students are affected by other people's actions, particularly people who play significant roles in their lives. Students with disabilities may be especially sensitive to the behavior and moods of others.

Parents, teachers and special education professionals can give you information about the nature and extent of a student's disability along with other relevant information. In some instances, it may be appropriate for a bus driver to be included in an IEP meeting or a 504 Service Plan meeting in order to ensure necessary information is shared. School staff will coordinate such meetings, and you will be invited, if deemed appropriate.

In addition to following the previous guidelines for managing students outlined in Unit B, keep these points in mind when working with students with disabilities:

- Be observant and try to anticipate problems. Always expect the unexpected.
- Keep teachers, professionals and parents informed of problems with the student or significant changes in behavior.
- In dealing with individuals with limited cognitive skills or mental retardation, work with the classroom teacher or parents to learn and understand appropriate communication methods for that student. Some students may use an augmentative communication device such as a laminated card with pictures or a computer with a voice simulator to express their needs. It may be helpful to ask simple yes/no questions in order to communicate effectively.
- Give students with emotional or behavioral disorders some responsibility in setting the standards of behavior they must meet.
- If a student with an emotional disorder becomes agitated or loses self-control, you should verbally intervene and attempt to calm the situation. Do so in a calm, directive manner.
- Be aware that "bad days" happen. The student's efficiency and self control may vary from day to day or from week to week. These puzzling shifts may lead you to feel much of the student's behavior is willful disobedience. Remember, these fluctuations may not be under the student's control. Document these incidents and report them to your supervisor, if you feel additional attention is needed. In some cases, you may work with a classroom teacher and parent to implement a Behavior Intervention Plan (BIP) reflecting the goals identified for that student's development.
- Always put safety first. If a student's behavior is distracting or dangerous to others, report the situation to your supervisor immediately.
- Introduce a substitute driver to the students in advance, if possible, since a change in routine or environment (e.g., driver change) may cause some students to react emotionally. Substitute drivers or aides must also be made aware, and be properly trained to understand and work with each student on the bus. Make sure the new driver has explicit, written instructions about the route and pick-up and drop-off times for each student.

## **“START”: A MEMORY AID FOR MANAGING STUDENTS WITH DISABILITIES**

You will likely carry at least one student with a disability on your bus during your driving career. Because a bus operator may not even know he/she is transporting a student with a disability, all operators should be aware of the special concerns relating to these passengers. An easy way to remember these special concerns is with the word “START.”

**S = Special** . . . . . Every student is unique. You should get to know each one and learn their individual traits. Talk with the student, their parents, aides, and teachers to find out important information. Students, even those who have similar conditions, are different. The more you know about their needs, the better you can accommodate them. Be aware some information is confidential.

**T = Treat Equally** . . . . . Students with disabilities want to be treated the same as all other students. Although there are many differences, whenever possible, all students should be required to follow the same rules.

**A = Attention** . . . . . You must pay specific attention to students with disabilities. Some students will behave poorly in order to get your attention. By paying attention to them when their behavior is appropriate, you may improve their behavior. They may require more of your time than other students.

**R = Restraints** . . . . . Students with physical disabilities often require special seats or restraining devices. If you are driving a bus equipped with these devices, learn to properly secure these students in their seats. Wheelchairs used by students need to be properly tied down.

**T = Different Techniques** . . . One particular method may not work in all situations with all students. If you are having trouble maintaining control of a student, change your method and try something new. Keep trying until you find something that works. The old saying “try, try, try again” is particularly appropriate when it comes to working with students with disabilities. Be sure to ask other drivers or your supervisor for helpful suggestions in working with particular students or situations. Even better, consult a behavioral specialist or school psychologist with expertise in this area.

## **TYPES OF DISABILITIES**

In addition to the general guidelines above, you should understand the different types of disabilities defined in the IDEIA that students you transport may have, and the specific procedures used in managing each type. Many of these conditions may not be visibly apparent, so drivers must be prepared to work with different conditions.

As mentioned earlier, some students with disabilities outlined below will require specialized transportation services often involving different types of vehicles and procedures. At the same time, some students with disabilities will be included in general education transportation, so you need to be aware of any unique guidelines or specialized procedures that are required.

## AUTISM

IDEIA defines autism as, “a developmental disability significantly affecting verbal and non-verbal communication and social interaction, generally evident before age three adversely affecting a child’s educational performance. Other characteristics often associated with autism are engagement in repetitive activities and stereotyped movements, resistance to environmental change or change in daily routines, and unusual responses to sensory experiences.” Autism spectrum disorders are viewed on a continuum. Students with severe autism may be nonverbal and often have mental retardation as a co-existing condition while students with milder symptoms may have some social skills deficits and a limited range of interests. Some students with autism may be included in general education transportation while others may require specialized services.

### **Behaviors that may be evident in students who are autistic include:**

- Indifference to other people - Students with autism sometimes treat other people as if they were objects and just in the way. They may bump into you as if you were a piece of furniture, without excusing themselves or noticing they bumped into another person.
- Difficulty looking people in the eye - When you talk to students with autism, you may have to work hard to get and keep their attention, especially if they are not facing you. The students may not notice or pay attention to other students or adults.
- Problems with their speech and language - Some students with autism cannot speak at all, and others may just scream or make other noises. Students who do speak may have some unusual speech patterns. For example, some students have trouble with pronouns and may use “you” instead of “I” when speaking. Some students tend to repeat what they hear instead of responding in a more typical way. For example, a student may repeat, “How are you?,” instead of responding to the question.
- Unusual reactions to different parts of their environment - They are very resistant to any change in routine or environment. They are easily upset and anxious about changes other students may not even notice, such as if a different type of bus picks them up, if they are in the window seat instead of the aisle seat, or if they are sitting next to someone new. They are often very sensitive to changes in temperature, loud noises, or physical touch, and may have a panic reaction at times to some of these changes.
- Unusual interest in objects - They may cling to objects, and examine and reexamine them. They may also be fascinated by various kinds of movements, for example, becoming completely absorbed by a spinning wheel or fan.
- Problems with their own movement - They may repeat movements over and over again without any particular purpose, for example, swaying, rocking, banging their head, or flapping their hands.
- Non-age appropriate behavior - Some students with autism may display behavior more typical of much younger students.

When working with students who are autistic, remember these students are affected by a disorder; their conduct is not necessarily willful. They cannot always control or stop their behavior upon request. These students need sameness, calmness, structure, and firmness along with gentleness, and patience. Here are a few pointers:

- Stick to a routine with the students. It will be critical.
- Prepare students for changes, such as detours, new passengers or substitute bus drivers.



- Use short, simple sentences and concrete concepts when communicating. For example, “Stay in your seat.”
- Recognize when students may be experiencing stress from changes in the environment.
- Do not insist on eye contact.
- Some students respond well to music. Parents may be able to help you determine what medium will provide a calming effect during the bus ride.

## **DEAF AND BLIND (DEAF-BLINDNESS)**

Some students may have hearing and visual impairments, the combination of which causes such severe communication and other developmental and educational needs they cannot be accommodated in special education programs solely for children with deafness or children with blindness. If available, you should work with a mobility specialist and the student to determine the best methods for assistance (sighted guide techniques, etc.). Many intermediate units (IUs) will have mobility specialists who can work with you.

Drivers should learn signals for help, distress, toileting needs, illness, hunger, and any other daily events that may occur on a bus as these signals are the only means by which the student can communicate. Consider seating students who are deaf and blind close to the bus door for ease of exit/entry and to avoid objects or people who may block movement in the aisle. Also, avoid seat reassignment for behavior management to ensure a consistent orientation route from the stairwell to their seat.

## **DEAFNESS/HEARING IMPAIRMENTS**

Students who have hearing impairments may require special transportation, though the inclusion of students with hearing impairments in general education transportation is fairly common. Hearing impairments may range from some degree of hearing loss to totally deaf.

Students who are deaf are taught and communicate through their other senses and therefore rely on visual and tactile information. Their greatest difficulty is to learn speech and language. To communicate, the student often learns to respond to lip movement, facial expression, signs, and/or finger spelling. When reading lips, students may not understand all of what is said, so repetition may be necessary. As a driver, you may need to gain the student’s attention by tapping him/her on the shoulder or waving your hand. Remember to look directly at the student, maintain eye contact, and speak clearly, naturally and slowly; shouting is useless. Repetition, facial expressions and gestures can also help with communication. Ask the teacher or parent to explain the nature and extent of the student’s hearing loss, and the best way to communicate with him or her. If the student communicates using sign language, you should attempt to learn a few common, useful ‘signs’ the student will understand.

## **EMOTIONAL DISTURBANCE**

Students who are emotionally disturbed have a condition exhibiting one or more of the following characteristics over a long period of time and to a marked degree that adversely affects their educational performance:

- An inability to learn that cannot be explained by intellectual, sensory or health factors;
- An inability to build or maintain satisfactory relationships with peers and teachers;
- Inappropriate types of behavior or feelings under normal circumstances;
- A general pervasive mood of unhappiness or depression; and
- A tendency to develop physical symptoms or fears associated with personal or school problems.

The inclusion of students with emotional disturbance in general education transportation is fairly common. These students may act in ways that are inappropriate, either in their nature or in their timing or degree. Since many have unusual difficulties maintaining interpersonal relationships, they can be aggressive, withdrawn, anxious, or easily frustrated. These students may be unable to express feelings and needs. They may be loud, excitable, defiant and aggressive, particularly when confronted by adults setting rules, such as bus drivers. Behavior may include destroying property, starting fights, and using offensive or inappropriate language. On the other end of the spectrum, some students who are emotionally disturbed have a pervasive mood of unhappiness or depression, and do not cope well with stress. They may be excessively shy and withdrawn, and avoid contact with their peers and adults alike.

As a bus driver, it is likely you will encounter students with emotional disturbances. Therefore, it is important to be calm, firm, fair, and consistent. Pay attention to your students and immediately report any threats of suicide to the school. It is a difficult challenge to maintain a professional distance and to stay involved with the students, but it is an important responsibility of the bus driver.

## **INTELLECTUAL DISABILITY**

IDEIA defines intellectual disability as, “significantly subaverage general intellectual functioning existing concurrently with deficits in adaptive behavior and manifested during the developmental period that adversely affects the child’s educational performance.” In other words, these students have impaired intellectual development, which seriously reduces their ability to learn. In addition, they struggle with age appropriate adaptive behavior skills. Adaptive behavior refers to the daily living skills that students need to function and includes communication, personal care, motor skills, and social skills. Some students will have mild intellectual disability while others will be significantly impaired, and so the levels of driver assistance and/or specialized equipment may vary.

As the bus driver, you may find it useful to assign specific seats with appropriate seat belts or child safety restraint systems (CSRS, i.e., car seat, safety vest, etc.). One person per seat is best. Consistency in the bus routes, personnel and service will help the trip go smoothly. Be patient as students with intellectual disability will require more repetition than typical peers to learn procedures.

## MULTIPLE DISABILITIES

A student with multiple disabilities has a combination of disabilities (such as intellectual disability and blindness or intellectual disability and orthopedic impairment). The combination of disabilities causes such severe educational needs that such students cannot be accommodated in special education programs solely for one of the impairments.

Students with multiple disabilities often require specialized transportation, especially if one of the impairments is an orthopedic impairment. These students are typically severely impaired and may need significant assistance in all areas of functioning. It would be important to obtain specific guidance for such severely impaired students from knowledgeable individuals such as the parents, teachers and other specialists to include physical therapists, speech therapists or mobility specialists.

## ORTHOPEdic IMPAIRMENTS

Students with orthopedic impairments have severe orthopedic issues that adversely affect their educational performance. The impairments may be a result of a congenital anomaly, disease or other causes. Some students may require wheelchairs or other holding devices for mobility, while others can walk with crutches or a walker. Therefore, they may need help in loading and unloading the bus. Refer to the later section on special equipment and your local specialized training provided by your employer or IU.

Whenever possible, students with minor physical disabilities are integrated into the regular transportation system, but may need some slight assistance. Other students may have physical disabilities that might not affect mobility in terms of boarding a bus, but may impair speech or other forms of communication, writing, or arm, hand, eye, and head movement. This may affect their seating requirements on your bus.

### Some common physical disorders and their effects include:

- **Cerebral Palsy (CP)** — Causes abnormal changes in physical movement, such as slow or spastic limb movement or seizures. A person with CP may be unable to coordinate body movement and may have possible speech problems. Intellectual functioning is often not affected. In the transportation setting, a student with CP may need a special harness.
- **Muscular Dystrophy (MD)** — A progressive general weakening of various muscle groups in the body. Students with MD may fatigue easily and may require the use of braces, harnesses or a wheelchair.
- **Spina Bifida** — A birth defect involving the spinal cord. Depending upon the severity of the defect, the student may be partially paralyzed (lower half of the body) or have a physical deformation. Some students with spina bifida are very verbal. On the bus, be careful with lower body positioning because these students may not have feeling in the lower half of their body. If they are positioned too close to a baseboard heater, they can get serious burns on their legs and not realize it.

## OTHER HEALTH IMPAIRMENTS

Students with other health impairments have limited strength, vitality or alertness, including a heightened alertness to environmental stimuli resulting in limited alertness with respect to the educational environment. This is due to chronic or acute health problems, such as asthma, attention deficit hyperactivity disorder (ADHD), diabetes, epilepsy, a heart condition, hemophilia, lead poisoning, leukemia, nephritis, rheumatic fever, sickle cell anemia, or Tourette's Syndrome. These conditions can adversely affect a child's educational performance.

When transporting students on the severe end of the spectrum, such as those requiring special transportation, you may need to talk to parents or teachers to find out about the special needs of these students on your route. Some students may wear medical identification tags specifying care and medical limitations.

Some of the more common impairments are discussed below.

## **EPILEPSY**

Epilepsy is a chronic nervous disorder, characterized by seizures of varying degrees. Students with epilepsy are commonly included in general education transportation. Epileptic seizures may be triggered by stress, hitting bumps in the road while driving, hot weather or a hot passenger compartment, strobes or flashing lights. You should know what to do, if a student has a seizure during the bus ride. Most students will have an “emergency preparedness plan” or “seizure plan”. This plan will provide you with some basic information on how to respond appropriately for that student.

### **Follow these steps to minimize any injuries to the student:**

- Listen to the student - Sometimes a student with epilepsy experiences a peculiar sensation known as an aura before a seizure. If the student warns you, pull the bus over to a safe location.
- Keep calm - The student is usually not suffering or in danger.
- Help the child to a safe place, but do not restrain his or her movements. Move anything the student may strike against with his or her head, arms, or legs. Most injuries occur from bumping hard objects.
- Do not force a hard object between the student’s teeth.
- Do not give the student anything to drink.
- Saliva may flow from the student’s mouth. Wipe it away with a tissue.
- Stand by until the student has fully recovered consciousness and seems clearheaded. The student may seem dazed and incoherent for awhile after a seizure.
- Encourage deep breathing after the student regains consciousness.
- Assure the student all is well and encourage him or her to go about regular activities.
- If the student is unconscious after the seizure, call for assistance and place him/her on his/her side in the recovery position.
- Occasionally, after a seizure, the student may want to sleep. Help him or her to a safe place to rest.
- Refer to local guidelines and procedures regarding the administration of medications and any supervisor/parent notification requirements.

## **TOURETTE'S SYNDROME**

Tourette's Syndrome is a neurological disorder characterized by repetitive, stereotyped, involuntary movements, and vocalizations called tics. The early symptoms of Tourette's are almost always noticed between the ages of seven and 10 years. Most people with the condition experience their worst symptoms in their early teens, with improvement occurring in the late teens and continuing into adulthood. Students with Tourette's are commonly included in general education transportation.

Tics are classified as either simple or complex. Simple motor tics are sudden, brief and repetitive movements such as eye blinking and other vision irregularities, facial grimacing, shoulder shrugging, and head or shoulder jerking. Simple vocalizations might include repetitive throat-clearing, sniffing or grunting sounds. Complex motor tics might include facial grimacing combined with a head twist and a shoulder shrug. Other complex motor tics may actually appear purposeful, including sniffing or touching objects, hopping, jumping, bending, or twisting. More complex vocal tics include words or phrases. Do not be offended by the behavior or language exhibited as this may be a manifestation of the syndrome. Note that tics are involuntary and are often worse with excitement or anxiety and better during calm, focused activities.

### **Here are a few tips for you as a bus driver:**

- Do not point out the behavior to the student;
- Give careful consideration to seat assignment;
- Stick to a routine as much as possible; and
- Keep your rules and directions short.

## **ATTENTION DEFICIT HYPERACTIVITY DISORDER (ADHD)**

Attention Deficit Hyperactivity Disorder (ADHD) includes primarily inattentive type, primarily hyperactive-impulsive type, and combined type. Students with ADHD have significant difficulty maintaining their attention to effortful tasks, excessive physical activity and impulsivity, or both.

### **Common symptoms include:**

- Impulsiveness - A child who acts quickly without thinking first or exhibits uncontrolled, abrupt and sudden changes in behavior. Students often act without considering the consequences and may endanger or harm themselves, or others.
- Hyperactivity - A child who can't sit still, walks, runs, or climbs around when others are seated, talks when others are talking. They may also be unable to stick to one task for very long before looking for something else to do.
- Inattention - A child who daydreams or seems to be in another world or is sidetracked by what is going on around him or her.
- Forgetfulness - The student may forget items or have a tendency to misplace them.

Have patience with a student with ADHD. Like other students with impairments, have firm, fair and consistent expectations. You may need to provide verbal clues to let your student know when his/her stop is nearby so he/she can gather his/her belongings. For some students, permission to use electronic devices (i.e., music device, handheld game, etc.) may be considered to keep the child engaged in a preferred activity and minimize problem behaviors.

## **SPECIFIC LEARNING DISABILITY**

Students with learning disabilities are those who have a disorder in one or more of the basic psychological processes involved in understanding or using spoken or written language. The disorder may show up as trouble with listening, thinking, speaking, reading, writing, spelling, or solving math problems. This category does not include students with learning disorders caused by visual, hearing or motor disabilities, or intellectual, emotional, cultural, economic or environmental disorders. The inclusion of students with learning disabilities in general education transportation is common.

You may find it helpful to contact the classroom teacher to ascertain what is working for the student during the school day.

## **SPEECH OR LANGUAGE IMPAIRMENT**

A speech or language impairment means a communication disorder, such as stuttering, impaired articulation or a speech or language impairment that adversely affects a child's educational performance. The inclusion of students with a speech or language impairment in general education transportation is fairly common.

Students with speech or language impairments may have trouble communicating clearly because they may be difficult to understand. Listen attentively and repeat back what you think was said. Keep your manner of responding "encouraging" rather than "correcting" and be patient! Watch a student's reaction to your response. It will help you know whether the message has been communicated. If you still don't understand the student, ask a peer to help, or ask a series of short questions that require "yes" or "no" answers. It may be helpful to use an alternative means of communication such as a pen and paper.

## **TRAUMATIC BRAIN INJURY (TBI)**

Some students have acquired injury to the brain resulting in total or partial functional disability including impairments in one or more areas, such as cognition; language; memory; attention; reasoning; abstract thinking; judgment; problem-solving; sensory, perceptual, and motor abilities; psychosocial behavior; physical functions; information processing; or speech. Participation in regular transportation will be dependent on the level of impairment.

### **Students with TBI may exhibit the following characteristics:**

- Reduced physical stamina,
- Possible seizures or headaches,
- Possible hearing or vision problems,
- Easily confused,
- Susceptible to mood swings, and
- Issues with social skills.

Remember to be consistent, and review the rules of the bus often. Be clear with your expectations. You may find it helpful to contact the classroom teacher to ascertain what is working for the student during the school day.

## VISUAL IMPAIRMENTS

IDEIA indicates that students who have visual impairments have vision that, even with correction, adversely affects their educational performance. They may have partial sight, meaning they can only see low light or shapes, or be legally blind. While the visual impairment may affect their educational performance, it will not affect their intelligence unless they have cognitive disabilities as well. The educational development of students with visual impairments may not be very different from students without a visual impairment. The inclusion of students with visual impairments in general education transportation is fairly common.

Students with visual impairments should be allowed to move independently, but they should be monitored for safety. Students with visual impairments may use a cane, service animal or other mobility device, and may rely on auditory and tactile information. Consultation with an orientation or mobility specialist may be warranted when transporting students with visual impairments.

If a student with a visual impairment rides your bus, provide descriptive feedback during the ride to help the student orient, especially in advance of their stop, so they can prepare. Having the student sit near the driver can help with this. Some students may need assistance navigating the narrow steps and aisles on the bus. Also, be sure to address the student clearly and specifically by name so he/she is sure you are communicating with him/her. As the student becomes more familiar with riding your bus, he/she may need less assistance as the school year progresses. Exercise particular caution during pickup and drop off.

## TRANSPORTING STUDENTS WITH DISABILITIES

As indicated in the sections above, transporting students with disabilities may involve special equipment and procedures in addition to basic bus driving skills. This section describes general procedures, unique bus stop procedures, the modified vehicles and special equipment used in transporting students with disabilities as well as emergency procedures and evacuation drills. Talk to your employer about obtaining specialized training in the use of unique equipment or procedures. You must become familiar with local guidelines and training.

## GENERAL CONSIDERATIONS

When determining the level of support a given student may require related to transportation, it is important to consider the following factors:

- 1. Length of Ride** – Health factors and the impact of the student’s disability should be considered as they influence the safety of the student during transit. Young students may show limited tolerance for extended bus rides, and the behavior of students with emotional disturbance or behavioral disorders tends to deteriorate as the length of the bus ride increases. There may also be unique issues for students requiring medication.
- 2. Level of Assistance Needed** – The level of assistance required by a student is influenced by the student’s age, size, sensory skills (e.g., vision, hearing), communication skills, level of intelligence, and social/emotional factors.
- 3. Seating** – Seating decisions are generally based on the student’s level of functioning. Students with limited trunk strength may require a seat belt or vest to provide additional support while on a moving bus. Students with visual impairments are likely to require an assigned seat they can independently locate. Students with significant intellectual limitations may require assistance to find their seats. Students with seizure disorders may need to be seated where they can be monitored and where lighting can be controlled.

4. **Special Adaptive and Assistive Equipment** – Seat belts, vests, harnesses, and wheelchair securement devices must be properly used. It is important to consult with a knowledgeable professional such as a physical therapist, school therapist or mobility specialist to ensure any such devices are used properly. If a student brings an assistive device on the bus, make sure it is properly secured for transport.
5. **Evacuation** – When preparing for the possible evacuation of students with disabilities, it is essential to have a written plan, which pays close attention to the individual needs of students. All students should participate in evacuation drills unless they have been exempted by authorized medical personnel. School bus operators and other personnel should plan to evacuate all students using all available exits with and without the use of the power lift (if applicable). Refer to Unit H for evacuation procedures.

## BUS STOP PROCEDURES

### Identifying Bus Stops

- The bus stop for many students with disabilities, especially those with physical disabilities using wheelchairs, may be located on the sidewalk or driveway in front of the students' homes.
- The bus stop should have level parking, smooth approaches from the house, and adequate space for placing ramps and loading wheelchairs.
- Bus stops where you must pull your bus over to the left side of the street, facing oncoming traffic, are prohibited.
- Just as each student requires individual attention, each stop requires its own approach. Adapt your pickup and drop off procedures for the particular needs of the student and the location.
- Stops for students with disabilities require more time and care than those for typical students. Try to find a place where traffic will not be unduly held up, if the school bus eight-way light system is activated.

### Loading Procedures

- Follow the procedures outlined in Unit C on loading and unloading for pulling up to the bus stop.
- If you can move your bus completely off of the roadway, you do not need to use the school bus eight-way light system. However, you must use the hazard warning lights.
- Sometimes students will need your help boarding or carrying their belongings. Assisting in the loading of a student with a disability (usually a student with a physical disability) is a time when you are permitted to leave the wheel of your vehicle. If you must leave the wheel, put the transmission in park or neutral and turn off the ignition. Be sure to remove the keys and set the emergency brake. On some vehicles with special equipment such as a lift, you must leave the engine on during loading and unloading. In these situations, make sure the transmission is in park or neutral, and the emergency brake is engaged before you leave the vehicle for loading or unloading. Know your vehicle.
- In order to board or exit the bus, some students may need the help of several people (e.g., parents, aides) in addition to you. Be sure all persons involved know their role in this procedure, ideally before the beginning of the school year.
- Most vehicles that transport students with disabilities have seat belts or other forms of child safety restraint systems (CSRS) you must help students secure. Before turning on the engine again, make sure all seat belts are fastened, all doors and windows are locked, all security devices are engaged, and all belongings are securely placed. Keep messages and supplies for delivery to parents or teachers in a secure place.



- Plan considerably more time to load students with disabilities, especially those with physical impairments. Follow your school district policy on wait time and expected boarding time. Parents should be instructed to have students at the bus stop five minutes before the scheduled time of arrival.
- Remember — if a student requires an aide, you must never leave him or her unattended.

### **Assigning Seats**

- If you are transporting a student with a disability in a large bus with general education students, don't automatically assign the student to the front seat. Typically, front seats are saved for "problem" students, and not many students want to sit near the driver. Students with disabilities are like most of your student passengers — they would prefer to sit with their friends.
- When assigning a seat to a student with a disability, consider such factors as mobility and independence of the student, needs of the student, ease of emergency evacuation, availability of dependable assistance, and vulnerability of the student during interactions with other students.

### **On The Road**

- While on the road, watch for any behaviors that might cause a dangerous situation. If aides are available, part of their responsibilities should be to make sure all students remain safely seated and secure. With or without aides, make periodic checks yourself. Knowing each student's specific behavior patterns will enable you to avoid potentially dangerous situations during transport. Before transporting any student with special needs, it is critical to understand the disability and potential behavior each student may exhibit.

### **Unloading Procedures**

- Unloading procedures are similar to loading procedures, but in the reverse order.
- Never leave students unless a parent or other responsible person is there. Since policies differ from area to area, local school district officials must establish specific procedures to follow when no responsible person is present where the student is to be unloaded.

## **MODIFIED VEHICLES AND SPECIAL EQUIPMENT**

Depending on the needs of students with disabilities in each school district, various modifications can be made to vehicles and special equipment can be obtained. You will be given additional training by the local school district or intermediate unit in the operation of modified vehicles and special equipment (e.g., wheelchair securement devices, car seats, child safety restraints, etc.) you will need to use.

### **Modified Vehicles**

Because students with disabilities have a wide variety of needs, there is a wide range of vehicles available for their transportation. State law (Section 4551 of Title 75) requires modified vehicles to conform to standards set by regulations in Chapter 171 of Title 67. These regulations may be found at [www.pacode.com](http://www.pacode.com).

### **Special Equipment**

State law (Title 75, Section 4581) requires children under four years of age and transported in a school vehicle (which is a vehicle originally designed to transport 10 or fewer passengers, including the driver) must be fastened securely in a child safety seat. The law also requires children four years of age or older, but under eight years of age, must be fastened securely in a child booster seat. Always follow the child safety seat and child booster seat installation instructions, particularly for seating positions that are equipped with a lap belt only. Any children transported over the age of eight, but less than 18 years of age, must be fastened in a seat

belt. NOTE: The above provisions are for school vehicles, not school buses. The law is silent regarding school buses on this issue. If you are in a situation where you are transporting pre-school age children in school buses, follow your local school district's policies on this issue and refer to the National Highway Traffic Safety Administration's (NHTSA) Guideline for the Safe Transportation of Pre-school Age Children in School Buses (<http://www.nhtsa.dot.gov>).

Other special equipment you may have to use includes ramps, lifts, seat belts, positioning belts, safety vests, or harnesses. Some students with physical disabilities often use wheelchairs, and a general description of the lifts and ramps used to load and unload passengers is presented below. The specific procedures for using all special equipment will be provided as a part of your local training.

**Ramps for Bus or Vans** – Some vehicles carry ramps to allow aides to manually roll wheelchairs into a van or bus or to allow students who can walk to enter without climbing steps; a combination ramp and shallow step may also be available. These should be securely stored while the bus is in motion. You may also have to secure the ramp in place on the vehicle to use it for loading or unloading. You may need to use special techniques to push the wheelchair and the passenger up the ramp and to lower them down without straining yourself (or the attendant) and without endangering the security of the student.

**Lifts** – Buses and other vehicles designed or converted to carry students who use wheelchairs are often equipped with a lift. In these cases, guide the wheelchair onto the lift platform so the wheelchair is facing outside the bus, lock the wheelchair's brakes, and secure the safety strap. Make sure the rider's hands and arms are inside the armrests. After you secure the rider, stand back from the platform at a position where you can operate the lift controls and safely hold onto the wheelchair with one hand. As the lift rises, the front kick plate should flip up to secure the front. When the wheelchair has been raised to the bus floor level, unlock the brakes and push the wheelchair inside the bus as far as you can, then secure the brakes again, and inform your passenger you are going inside the bus. Enter the vehicle, unlock the brakes and secure the wheelchair into position. Always position the wheelchair and secure it to the floor using four tie downs, a lap/shoulder belt, and the independent wheelchair seat belt, if it has one. Check with your supervisor for the correct method of tie downs.

Here are a few additional tips for working with wheelchairs:

- There are separate brakes for each side of the wheelchair – use them both.
- Always make sure the wheelchair brakes are engaged when the wheelchair is unattended and when the student is moving in and out of the wheelchair.
- Never lift a wheelchair by its arms or footrests (as they may come off of the chair) or by the wheels – always use the frame.
- Keep loose clothing away from the wheels.
- Always secure the passenger with a three-point seat belt system attached to the wall of the bus. The seat belt on the wheelchair is NOT a proper occupant restraint.
- If assisting a student in a wheelchair, don't forget to use the tilt bars, when necessary.

Note: Lifts should be operated in accordance with manufacturer's recommendations. No standees should be permitted on the lift while in operation and the operator should not be on the lift during operation.

## EMERGENCY PROCEDURES AND EVACUATION DRILLS

The procedures to follow in case of a crash or any serious incident forcing you to stop and seek assistance are generally the same as those outlined in Unit H (Crash and Emergency Procedures) and Unit I (Student Emergencies). Carry a copy of First Aid procedures in the vehicle and make sure your vehicle has the required and optional emergency equipment listed and described in Unit H.

When planning emergency procedures, keep these points in mind:

- If immediate assistance is needed, contact 911 for assistance.
- Under no circumstances should you leave the students being transported.
- An able student can sometimes serve as a second-in-command in emergency situations, if an aide is not available. Consult with the parents and teachers in advance about the abilities of particular students to decide whether this would work.
- Assign those students who are blind and/or deaf to a partner who can assist them in case of an emergency.
- Because many students with mental impairments have trouble remembering, evacuation drills should be limited to simulations at the school, where school supervisory personnel can assist in performing the drill and help train those students capable of taking responsibility. Bus evacuation procedures and drills are described in Unit H.
- Ambulatory students with disabilities are evacuated in the same manner as students in general education, whenever possible.
- In a crisis, non-ambulatory students may be placed on the floor and pulled by their clothing or drag cloth out of any available exit. Ramps may be used to roll or slide students to the ground, if necessary. Contact your employer regarding training in these specialized areas.
- Students with disabilities who have been involved in a crash or an emergency evacuation should be examined by qualified medical personnel even if they appear uninjured. Refer to local guidelines and procedures regarding the notification of parents or guardians.

**THIS PAGE INTENTIONALLY LEFT BLANK**

# UNIT E - PREVENTATIVE MAINTENANCE

INTRODUCTION .....	E-2
PRE-TRIP INSPECTION .....	E-3
VEHICLE OVERVIEW .....	E-4
Engine Compartment Inspection .....	E-5
Inspect the Inside of Bus .....	E-7
Driver Compartment .....	E-7
Passenger Entry .....	E-12
Passenger Compartment .....	E-12
Inspect Outside of Bus: Walk-Around Inspection .....	E-13
Tires, Wheels, and Rims .....	E-13
Check Right Front .....	E-14
Check Front Side .....	E-15
Check Left Front .....	E-16
Check Left Side .....	E-16
Check Left Rear .....	E-16
Check Rear Side .....	E-17
Check Right Rear .....	E-17
Check Brake System .....	E-17
Automatic Brake Adjusters (ASAs) .....	E-18
PREVENTIVE MAINTENANCE WHILE ON THE ROAD .....	E-19
Detecting Abnormal Vehicle Behavior .....	E-19
Continuous Checks .....	E-19
Check Parking Brake .....	E-19
Check Service Brakes .....	E-20
Check Transmission .....	E-20
Check Steering .....	E-20
Check Suspension .....	E-20
Check Engine .....	E-20
Check Your Tires .....	E-20
Good Driving Habits .....	E-21
Starting the Bus and Basic Operations .....	E-21
Proper Use of the Clutch .....	E-21
Proper Use of the Brakes .....	E-22
Protection of the Rear Axle .....	E-22
Proper Use of the Transmission .....	E-22
POST-TRIP PREVENTIVE MAINTENANCE PROCEDURES .....	E-23
Importance of Reporting Problems .....	E-24
Five Basic Items Mechanics Want You to Know .....	E-24

# UNIT E - PREVENTATIVE MAINTENANCE

## INTRODUCTION

The life of a school bus and the dependable service it can provide to you as an operator as well as to the pupils you are transporting is directly related to how you care for your bus. Central to this is a planned, budgeted and proactive preventative maintenance system. This system involves such items as service, adjustments, replacements, inspections based on pre-determined intervals, and tolerances. These minimize failures and costs, and maximize safe and comfortable operations. Most significantly, safety is the most important and obvious reason for performing inspections: inspecting your vehicle helps you to know your vehicle is safe. You should never operate a vehicle that is not running properly, is not safe or does not have the proper equipment on board.

As a school bus operator, you have significant responsibility in the preventive maintenance program, especially in the proactive component of preventive maintenance. Remember: with an effective preventive maintenance system, service begins with the pre-trip inspection. With an ineffective preventive maintenance system, breakdowns and complaints control the service. From an operator's standpoint, preventive maintenance includes the following items:

1. Pre-trip inspection;
2. Operational inspection; and
3. Post-trip inspection.

As indicated in this unit, as an operator, you should NOT be making repairs yourself; this is the role of your maintenance team. Report, don't diagnose. However, since you are on the road with your vehicle for several hours each day, you are in the best position to observe how it performs under all conditions. Learn to recognize defects both during the pre-trip inspection and while on the road, and immediately report problems to your supervisor or the bus maintenance department. Problems cannot be repaired, if they are not reported.

This unit covers each of these items as part of your normal daily preventive maintenance tasks. Responsibility for these tasks may vary due to differences in buses and/or local policy. If you are ever unsure of the preventive maintenance duties assigned to you, ask your supervisor.

## PRE-TRIP INSPECTION

The purpose of a pre-trip inspection is to identify problems that could cause a crash or breakdown. Each school bus operator may have unique methods or procedures for completing and documenting a pre-trip inspection, so work with your supervisor to review system-specific policies and/or checklists. The key for you, the operator, is to complete your pre-trip inspection the same way each time. In this fashion, you will learn all the correct steps, improve the efficiency of your inspection and will be less likely to forget something important.

The following is a pre-trip inspection that should take an operator about 15 minutes to complete. This is only a recommended procedure that makes logical sequential sense. If you have a more efficient process that still covers the requirements in 49 CFR Section 396.13 (Driver Inspection), or if your school district or contractor requires something different, use their procedures. Remember, federal regulations require you to ALWAYS be satisfied your bus is in good operating condition and you review the last driver inspection report.

It is also good practice to always complete your pre-trip inspection the same way each time so you will be less likely to forget a step. A few items to have on hand when you complete your pre-trip inspection include:

- Work gloves to keep your hands clean;
- Rags for removing caps and checking fluid levels under the hood;
- Paper towels for cleaning small spills;
- Window cleaning fluid for washing windows, mirrors and headlights. It is good practice to clean all lights, reflectors and glass, as you go along; and
- A checklist provided by your employer (may be company-specific) for making sure you check all important items.

Remember federal regulations require that before driving your bus, you shall:

1. Be satisfied it is in safe operating condition;
2. Review the last driver vehicle inspection report; and
3. Sign the report, only if defects or deficiencies were noted by the driver who prepared the report, to acknowledge the driver has reviewed it and there is a certification the required repairs have been performed. The signature requirement does not apply to listed defects on a towed unit, which is no longer part of the vehicle combination.

There are also specific federal requirements for post-trip inspection in 49 CFR Section 396.11 (Driver Vehicle Inspection Reports) as discussed later in this unit.

# 1. VEHICLE OVERVIEW

As you approach the vehicle, note its general condition, and look for damage or whether the vehicle is leaning to one side. Look under the vehicle for fluid, which may be fresh indicating oil coolant, grease, or fuel leaks. If any of these are noted, contact your supervisor or maintenance professional. Recognize what items are critical to operating a bus safely. If the fluid is condensation from the air conditioner, there is no need to report a problem, but if it is a fuel leak, the bus should be immediately removed from service until the problem is repaired. Also, check the area around the vehicle — above and below — for hazards to vehicle movement (people, other vehicles, objects, low hanging wires or limbs, etc.). This is of particular importance for homeland security issues.

If your vehicle has recently been in for service, pay particular attention to the problem areas to determine whether they have been adequately repaired. Review the bus repair report and/or last bus inspection report. This is particularly important if you are driving a bus that is not your own.

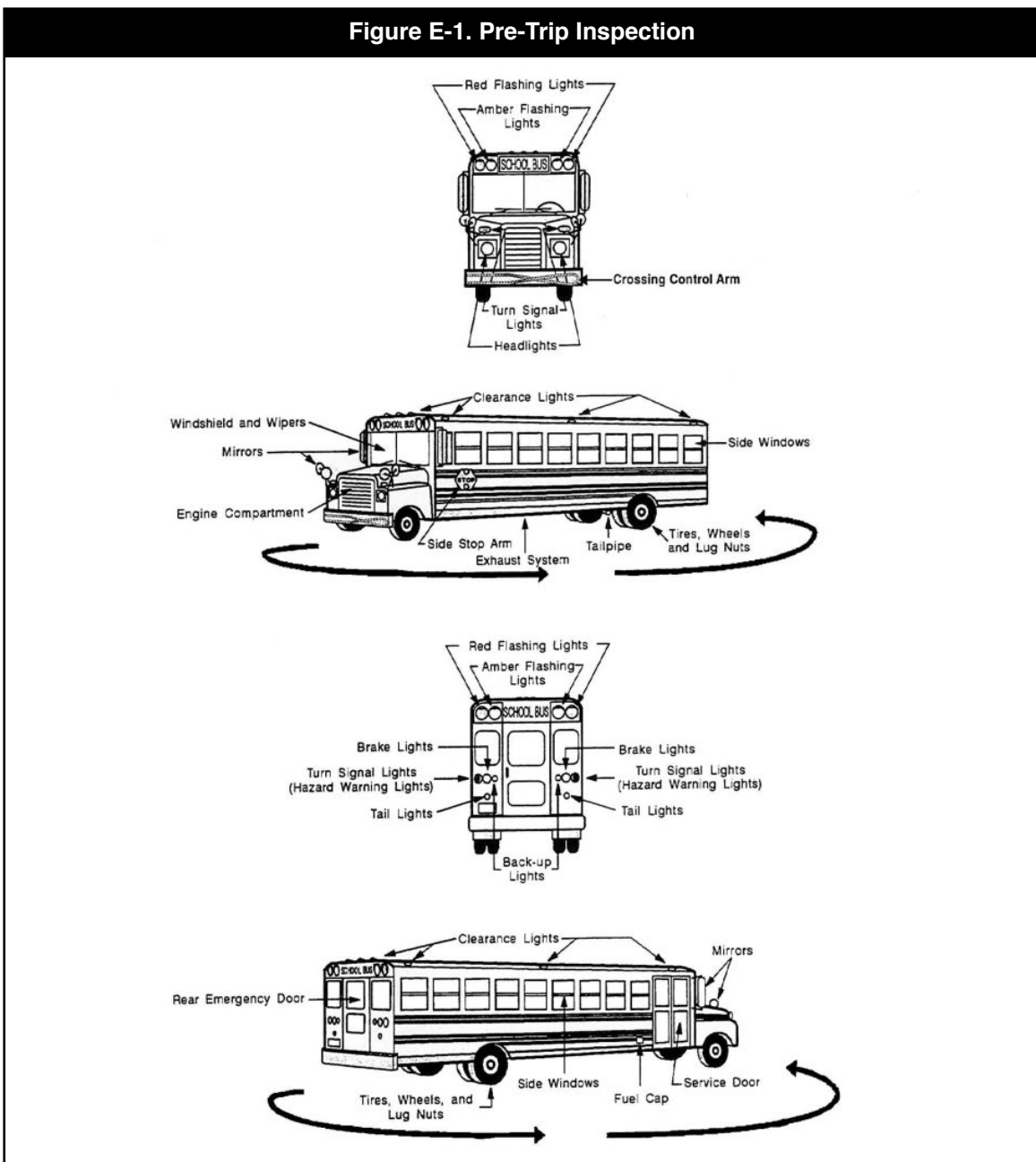



## 2. ENGINE COMPARTMENT INSPECTION

Some contractors and school districts do not require drivers to perform under-the-hood checks, but all drivers should be trained in the proper procedure. Make your first set of checks under the hood while the engine is cool and the various fluid systems have had time to stabilize.

Ensure the parking brakes are on and/or wheels chocked. You may have to raise the hood, secure loose items so they don't fall and break something, or open the engine compartment door.

Check the following while the engine is not running:

- **Engine oil level** – Remove the oil dipstick, wipe the dipstick clean with a rag and look at the indicator at the bottom of the dipstick. Push the dipstick back into the hole, making sure to push it all the way back in until it seats. Pull out the dipstick again and see where the oil has left a residue in relationship to the indicators. Make sure the level is between the 'add' and the 'full' line.
- **Coolant level in radiator** – While the engine may not be running, you may be doing this check after someone else has used your bus, and it has not completely cooled yet. Because of this, never remove the radiator cap when the engine is hot. The fluid is under pressure, and you can be burned seriously.
  - ❖ Identify the full hot and full cold level markings on the opaque white plastic coolant overflow tank located right next to the radiator. If the engine is hot, fill to the hot line. If the engine is cold, fill to the cold line. If you're low, top it off with a 50/50 mixture of coolant and water. There is more than one type of coolant. Only use the type of coolant specified by the mechanic. To add the coolant, unscrew or pop the top of the opaque plastic reservoir, and add your mixture until it reaches the full mark. Replace the cap tightly. If you spill any coolant on the ground, wipe it up. Certain coolants are deadly to animals, but they like to drink it because it tastes sweet. If there is no fluid in the reservoir, notify the mechanic for instructions before starting the bus.
- **Condition of hoses** –
  - ❖ To check the condition of the hoses, when the engine is cold, squeeze each hose. If the hose feels crunchy or brittle, it's old and needs to be replaced.
  - ❖ Visually inspect the hoses for cracks, tears, frayed ends, and damp or wet areas. Check the clamps at ends of the hoses.
- **Power steering fluid level. Make sure it is above the "fill" mark** –
  - ❖ Wipe the power steering fluid reservoir cap with a clean rag or paper towel before opening.
  - ❖ Visually inspect the hose for cracks, tears, frayed ends, and damp or wet areas (if any).
  - ❖ Some tanks require this to be checked when hot. Refer to your bus manual for specific details.
- **Windshield washer fluid level** –
  - ❖ The windshield washer fluid reservoir is a large, clear plastic container that may be labeled with words or a symbol on the cap showing two sprits of water.
  - ❖ Check the fluid level. You can fill this reservoir all the way to the top.
- **Battery fluid level, connections and tie downs (battery may be located elsewhere)** –
  - ❖ No smoking and extinguish all open flames. Batteries produce hydrogen gas when charging. Hydrogen is extremely flammable and explosive.
  - ❖ Clean the top surface to remove any dirt and debris with a rag before removing the caps.
  - ❖ Remove the vent caps by prying them up or turning them counter clockwise and look inside each cell. The fluid level should be level with the filler ring for each cell.
  - ❖ Use a battery fill jug. Fill any low cells with distilled water up to the proper level.

- ❖ Replace the vent caps and clean up any spills.
- ❖ Warning – battery fluid is sulfuric acid. Do not get any on your skin or clothing. If battery fluid does make contact with your skin, flush with fresh water immediately.
- ❖ Only use distilled water in your battery. Anything else will cause the battery to fail.
- **Automatic transmission fluid level (may require engine to be running and be fully warmed up) –**
  - ❖ Be careful around the running engine. The fan might come on suddenly and catch any loose clothing or jewelry and may cause serious injury.
  - ❖ Pull out the dipstick and wipe it clean with a rag.
  - ❖ Put the dipstick back in the hole. Make sure to push it all the way back in until it seats.
  - ❖ Pull out the dipstick and ensure the fluid level is between the full and low levels.
  - ❖ Use a long, thin funnel to add transmission fluid through the dipstick hole if required.
  - ❖ There is more than one type of transmission fluid. Only use the type of transmission fluid specified by the mechanic or as shown on the dipstick or engine manual.
- **Tightness and excessive wear on belts on the alternator, water pump, and air compressor –**
  - ❖ Learn how much “give” the belts should have when adjusted right, and check each one. Press lightly with your thumb on each belt at the belt’s longest part between pulleys. In general, there should be no more than ½” to 1” of movement. The belt should not be cracked. As mentioned earlier, this portion of your pretrip will normally be done when the engine is cool. If for some reason it is not, let the engine cool before checking belts, and be careful around hot engine parts and sharp edges.
- **Inspect for leaks in the engine compartment (fuel, coolant, oil, power steering fluid, hydraulic fluid, brake fluid, windshield washer fluid, gear oil, automatic transmission fluid, battery fluid).**
  - ❖ Except for windshield washer fluid and fuel, the fluids in your bus shouldn’t get used up or go anywhere.
  - ❖ As brake linings wear, brake fluids will drop slightly.
  - ❖ If you notice any other fluids are low, you probably have a leak.
  - ❖ Inspect underneath the bus looking for wet areas or drips clinging to the underside of the bus.
  - ❖ Sticky sweet smelling fluid is coolant. The old color for coolant was green, now it comes in yellow, as well as other colors. Dark slick greasy fluid is engine oil. Honey or dark colored thick fluid with a chestnut smell is gear oil. Clear slippery fluid is brake fluid. Slippery red fluid is transmission fluid or power steering fluid. Fuel is easily identified by its odor. Windshield washer fluid comes in several colors – blue and orange are typical. Battery fluid could be on top of the battery. Don’t touch this. It is acid.
  - ❖ If you are running the air conditioner expect to see water dripping, which is just condensation and is nothing to worry about.
  - ❖ Look for cracked worn insulation around electrical wiring. Look for bare wire spots where the insulation has broken, burnt or worn away.
  - ❖ Don’t tug on the wires. You might pull them out of the connections and disconnect the wire.

When the engine compartment inspection is complete, carefully lower and secure hood latches or the engine compartment door.

### 3. INSPECT INSIDE OF BUS

Once the engine compartment has been checked, inspect the inside of the bus. This task can be separated into three areas: the driver compartment, the passenger entry and the passenger compartment. It is recommended you start the vehicle engine and complete this portion with the engine turned on. For diesel engines, make sure the injector pump is engaged before starting.

Refer to Unit F for starting and driving a diesel vehicle. At a minimum:

- Make sure parking brake is on;
- Put gearshift in neutral (or park, if available);
- Turn off the heaters before starting, so the engine will reach operating temperature more quickly; and
- Start the engine and listen for unusual noises.

#### **Driver Compartment**

At the start of your in-bus check, activate the four-way flashers and amber lights from the operator's seat. From the seated position, you can see in your mirrors whether the front ambers are working and can see the turn signals both flashing. Later, when you walk through the bus and open the back door, you can see whether the back turn signals are flashing and the amber lights in the back are flashing.

#### **1) Inspect the Gauges. Check all of the following gauges:**

- Oil pressure should come up to normal within seconds after engine is started. If it does not, shut down the engine and notify the mechanic.
- Ammeter and/or voltmeter should be in normal range(s).
- Coolant temperature should begin gradual rise to normal operating range.
- Oil, coolant and charging circuit warning lights should go out right away.
- Fuel gauge should indicate a safe margin for the day's trip.
- Buses equipped with hydraulic brakes with vacuum assist have a vacuum gauge and low vacuum warning light. If the gauge reads less than normal or the warning light starts to blink, report the condition.
- Air gauges with warning buzzers on buses with air brakes stop buzzing when air pressure increases above 60 psi. Do not drive the bus, if the pressure is less than 60 psi.

#### **2) Check Controls. Check all of the following for looseness, sticking, damage, or improper setting:**

- Steering wheel;
- Clutch;
- Accelerator (gas pedal);
- Brake Controls; and
  - ❖ Foot brake,
  - ❖ Parking brake,
  - ❖ Retarder controls (if vehicle has them),
  - ❖ Transmission controls.
- Horn: Horn should be heard approximately 200' away.

- Windshield wiper/washer. Spray the washer fluid before turning on the wipers, to avoid damaging the windshield.
- Lights.
  - ❖ Headlights;
  - ❖ Dimmer switch;
  - ❖ Turn signal;
  - ❖ Four-way flashers;
  - ❖ Clearance, identification, marker light switch(es);
  - ❖ School bus eight-way light system; and
  - ❖ Strobe light, if applicable.

**3) Check All Mirrors.** Mirrors play a critical role in the safe operation of your vehicle because they allow an operator to observe the zone around the bus and look for students, traffic and other objects in this area (Refer to Unit B). For example, children standing in front of the bus may not be visible in any other way. Therefore, all mirrors must be secure, clean and unbroken. Check mirrors to make sure they are clean and adjusted so you can see all areas around the bus from the driver's seat and you can obtain the maximum viewing area consistent with the vision requirements of Federal Motor Vehicle Safety Standard No. 111, "Rearview Mirrors." Refer to 49 CFR 571.111. See Figure E-2 below. The interior rearview mirror must provide a good view of passengers and the area directly behind the bus. The right and left side mirrors must provide a clear view past the right and left rear of the bus. The right and left front fender-mounted rear mirrors (convex mirrors) must provide a clear view from the forward-most point of the front fenders past the rear of the bus. The left front fender-mounted crossover mirror (convex) must provide a view of the blind area directly in front of the bus.

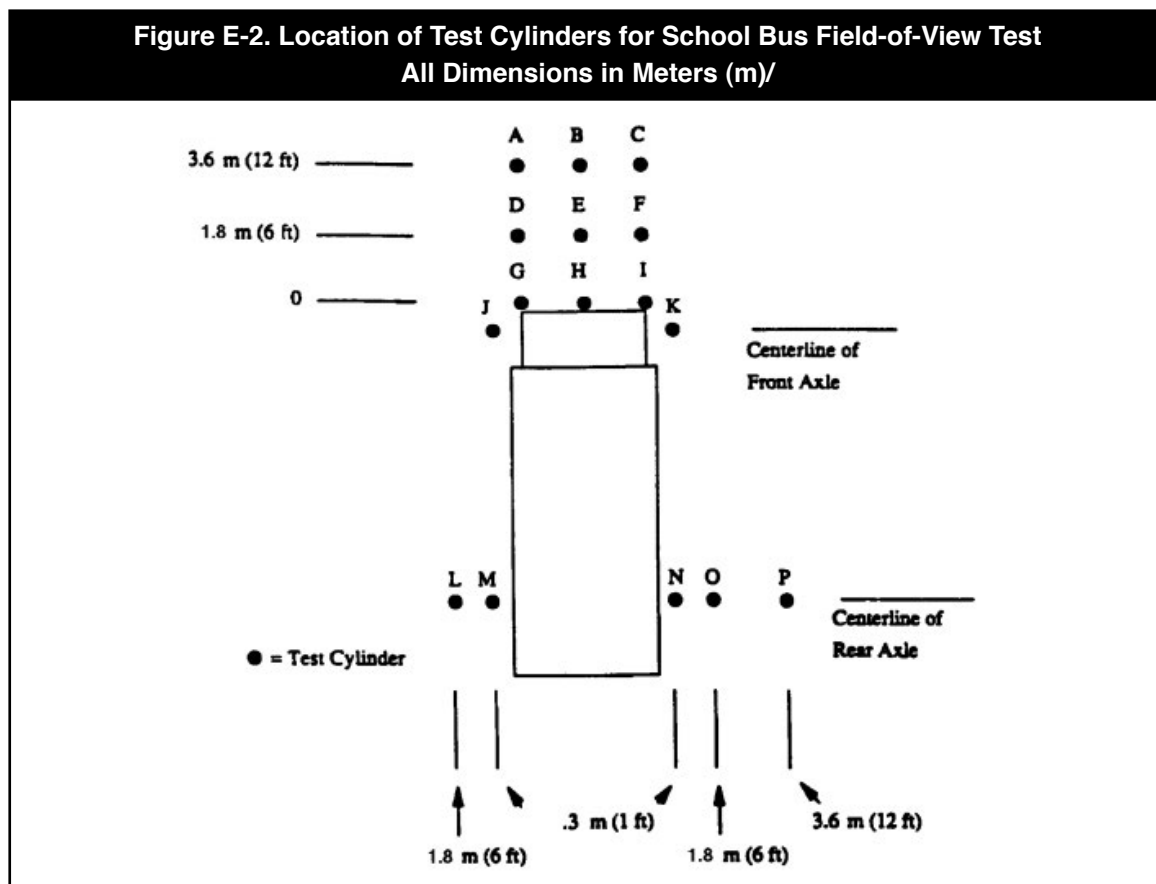

**Outside Left and Right Side Flat Mirrors.**

These mirrors are mounted at the left and right front corners of the bus at the side or front of the windshield. They are used to monitor traffic, check clearances and students on the sides and to the rear of the bus. There is a blind spot immediately below and in front of each mirror and directly in back of the rear bumper. The blind spot behind the bus could extend up to 400 feet depending on the width of the bus. Ensure the mirrors are properly adjusted so you can see:

- 200 feet or four bus lengths behind the bus;
- Along the sides of the bus; and
- The rear tires touching the ground.

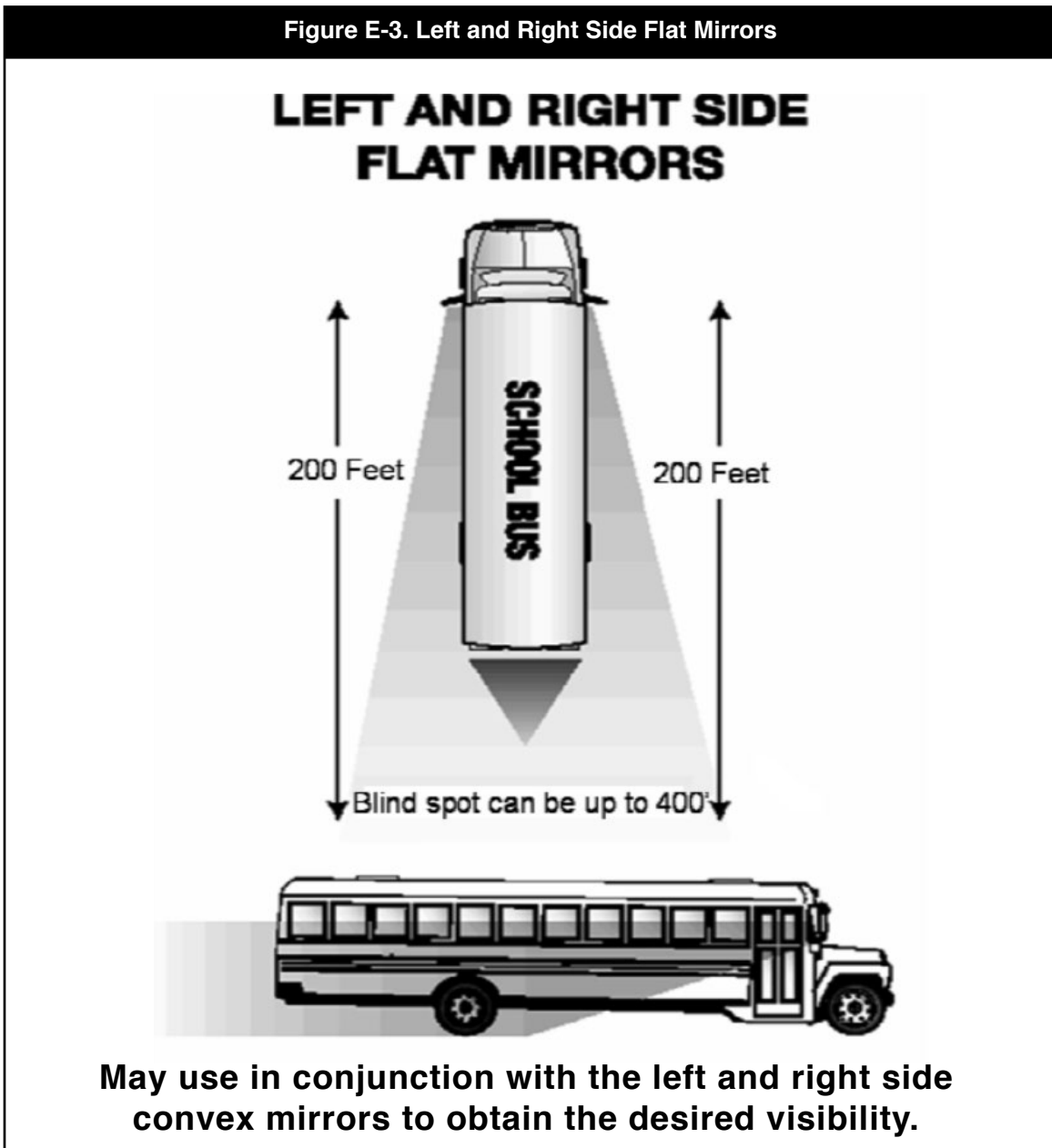

**Outside Left and Right Side Convex Mirrors.**

The convex mirrors are located below the outside flat mirrors. They are used to monitor the left and right sides at a wide angle. They provide a view of traffic, clearances and students at the side of the bus. These mirrors present a view of people and objects that does not accurately reflect their size and distance from the bus. Ensure the mirrors are properly adjusted so you can see:

- The entire side of the bus up to the mirror mounts;
- Front of the rear tires touching the ground; and
- At least one traffic lane on either side of the bus.

**Figure E-4. Left and Right Side Convex Mirrors**

## LEFT AND RIGHT SIDE CONVEX MIRRORS

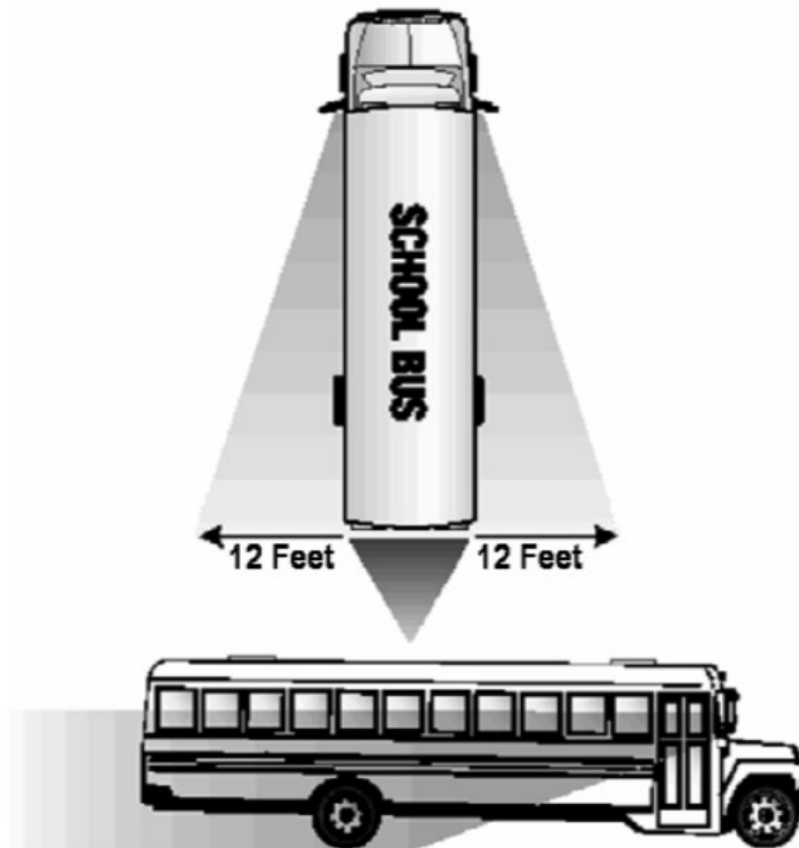

**May use in conjunction with the left and right side standard (flat) mirrors to obtain the desired visibility.**

**Outside Left and Right Side Cross View Mirrors.**

These mirrors are mounted on the left and right front corners of the bus. They are used to see the “danger zone” area directly in front of the bus not visible by direct vision, and to view the “danger zone” areas to the left side and right side of the bus, including the service door and front wheel areas. The mirror presents a view of people and objects that does not accurately reflect their size and distance from the bus. The driver must ensure these mirrors are properly adjusted. Ensure the mirrors are properly adjusted so you can see:

- The entire area in front of the bus from the front bumper at ground level to a point where direct vision is possible. Direct vision and mirror view vision should overlap;
- The right and left front tires touching the ground; and
- The area from the front of the bus to the service door.

These mirrors, along with the convex and flat mirrors, should be viewed in a logical sequence to ensure a child or object is not in any area of the danger zone.

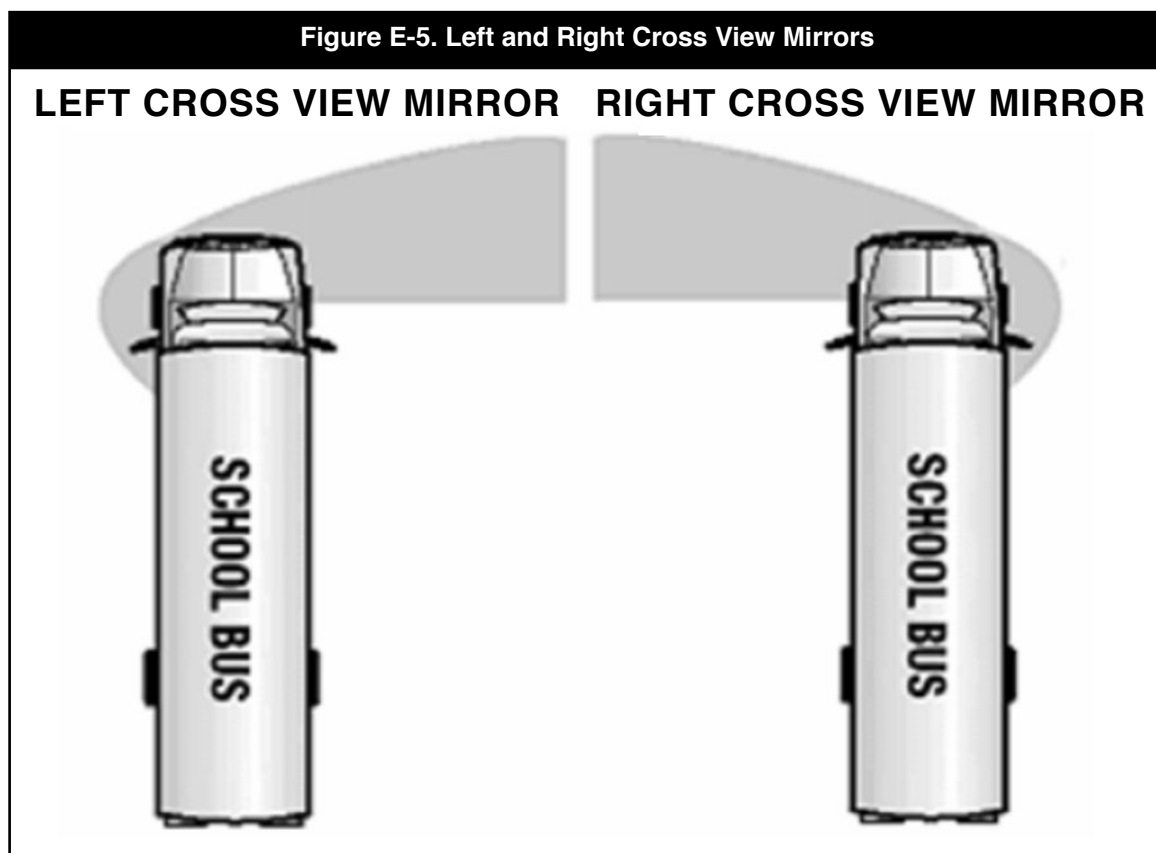
**Overhead Inside Rearview Mirror.**

This mirror is mounted directly above the windshield on the driver’s side area of the bus. This mirror is used to monitor passenger activity inside the bus. It may provide limited visibility directly in back of the bus, if the bus is equipped with a glass-bottomed rear emergency door. There is a blind spot area directly behind the driver’s seat as well as a large blind spot area beginning at the rear bumper and could extend up to 400 feet or more behind the bus. You must use the exterior side mirrors to monitor approaching traffic and enter this area. Ensure the mirrors are properly adjusted so you can see:

- The top of the rear window in the top of the mirror; and
- All of the students, including the heads of the students right behind you.

## Passenger Entry

- 1) **Check Service Doors** – Open and close your service door to ensure it operates smoothly, and there is no broken or obscure glass.
- 2) **Check the Stairwell** – Ensure the skid resistant tread is in good operating condition and the stairs themselves are not bent or rusting. Some stairwells are lighted. If this is the case, the lens cover should not be broken. Make sure if a light is present, it operates correctly.
- 3) **Check the Handrail** – This item is required in a school bus, and it should be secure and undamaged. This is of particular importance so it does not snag a student's clothing and drag them, if the bus is in motion.

## Passenger Compartment

A walk-through examination of the passenger compartment should be completed next. You should examine seats to ensure they are secure to the floor with no broken parts, and the condition of the upholstery is adequate. This includes making sure the seat bottoms are secure on the way down the aisle and also check for vandalism. Correct any problems, if possible, and report any hazardous conditions to your supervisor. Also be sure the compartment is free of clutter or trash, which could cause a student to slip or fall.

At the end of the walk-through, be sure the emergency door(s) is unlocked and opens and closes properly, and the warning buzzer works properly. While the door(s) must be shut to prevent carbon monoxide fumes from entering, it must not be locked at any time during operation of the bus. In addition, the door and aisle should never be blocked. The rear emergency door and side emergency door exits must open and close properly from outside the bus.

When you walk through the bus and open the back door, you can see that the back turn signals are flashing, and the amber lights in the back are flashing.

Check emergency exit windows on sides and emergency escape hatches in the roof to see they are operational and the warning buzzer works properly.

Lastly, check the school bus emergency equipment. This includes:

- Spare electrical fuses, unless vehicle has circuit breakers;
- Three red reflective triangles;
- Properly charged and rated fire extinguisher. This is a fire extinguisher with a total rating of not less than two A-10 BC for electrical and liquid-fuel fires. Ensure the pin is in place. You need to make sure the fire extinguisher is inspected at least once a year to ensure it is fully charged, properly filled and operable. Upon approval, the fire extinguisher shall be tagged, signed and dated. Check to make sure your extinguisher is tagged, signed and dated as part of your inspection. Refer to Section 171.51, 171.122, 171.132, and 171.147 of Title 67 for additional details on fire extinguishers;
- Complete First Aid Kit (refer to Unit I) including a Body Fluid Clean-Up Kit;
- Pry bar;
- Tire chains (Optional: where winter conditions require them);
- Tire changing equipment (optional);
- List of emergency phone numbers; and
- Crash reporting packet (Refer to Unit I).



Refer to state regulations in Title 67, Chapter 171 for additional regulatory information regarding safety equipment: [www.pacode.com](http://www.pacode.com).

Don't forget to check the interior signal pilot and dashboard lights. Make sure the headlight dimmer switch is working, and check the dome and stepwell lights. Lastly, activate the school bus eight-way light system. While it is on, the red flashing lights will be activated once you open the service door of the bus. Leave all lights on at this point so you can check them from the outside during your walk-around inspection.

#### 4. INSPECT OUTSIDE OF BUS: WALK-AROUND INSPECTION

Walk around the bus for the next set of checks. Leave the engine running with the parking brake set, transmission out of gear, and lights and signal devices left on. To save time, it is a good idea to team up with another driver when checking mirrors, headlights, the red and amber flashing lights of the school bus eight-way light system, side marker lights, brake lights, and back-up lights.

##### Tires, Wheels, and Rims

Tires, wheels and rims operate together. Tires should be of the same size, evenly matched, and of the same type (radial or bias type). The recaps are permitted on rear tires unless they are single wheels, but not on the front. If using recapped tires, they must be stamped as " regroovable." Refer to Section 171.36 of Title 67 for additional details. The tread should not be separating from the tire. Rims should not be bent or damaged, and should have no welding repairs. Look for rust trails, which may indicate the rim is loose on the wheel. Rust around lug nuts may also indicate looseness. You may need to tighten with a wrench. Also, the hub oil seals, axle seals, and wheel bearing seals should not be leaking. Look for any other signs of misalignment or missing lug nuts.

When walking around, carry your pry bar or tire buddy, and strike each tire; the bar should bounce back adequately, if properly inflated. If you have any indication a tire is not properly inflated, check the tire with a

tire gauge. Also check for tread depth: A minimum depth of 4/32" is required on the front tires and 2/32" on the rear tires as per Section 171.36 of Title 67. The valve stem and cap should be in place and undamaged. Also, there should be no obstructions between the dual wheels.

Develop the habit of observing tires for abnormal wear patterns, which may be a symptom of suspension problems. Figure E-6 shows several types of abnormal wear that can cause steering problems, shimmy conditions and premature tire wear. Do not operate the bus, if the tire has such defects as bubbles, cracks or significant abnormal tire wear patterns.

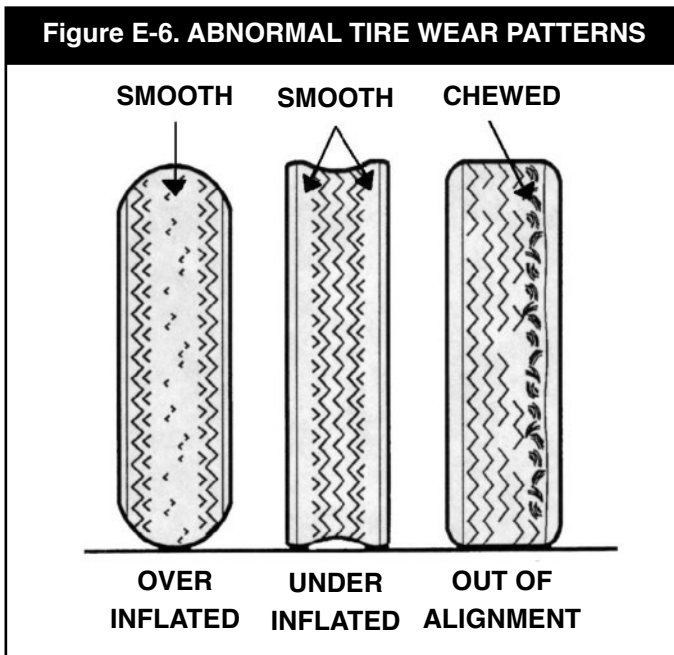

## Check Right Front

- Right fender-mounted mirror (previously outlined in this unit);
- Right front tires, wheels and rims (previously outlined in this unit);
  - ❖ Condition,
  - ❖ Hub oil level adequate,
  - ❖ 4/32" tread depth.
- Right front suspension;
  - ❖ Spring, spring hangers, shackles, U-bolts: Mount should be secure, not broken or cracked, without missing or loose bolts. Bushings and axle mounting parts should not be damaged, broken, or missing. Check for missing or broken leaves; leaves that have shifted and may be nearly in contact with the tire, rim, brake drum, frame, or body. For a coil spring, look for breaks or distortions.
  - ❖ Shock absorbers should be secure, unbroken and have no leaks.
  - ❖ A key with this inspection is to give valid information on important parts, and to know what constitutes an unsafe condition. YOU are responsible for safety.

**Figure E-7. Suspension System**

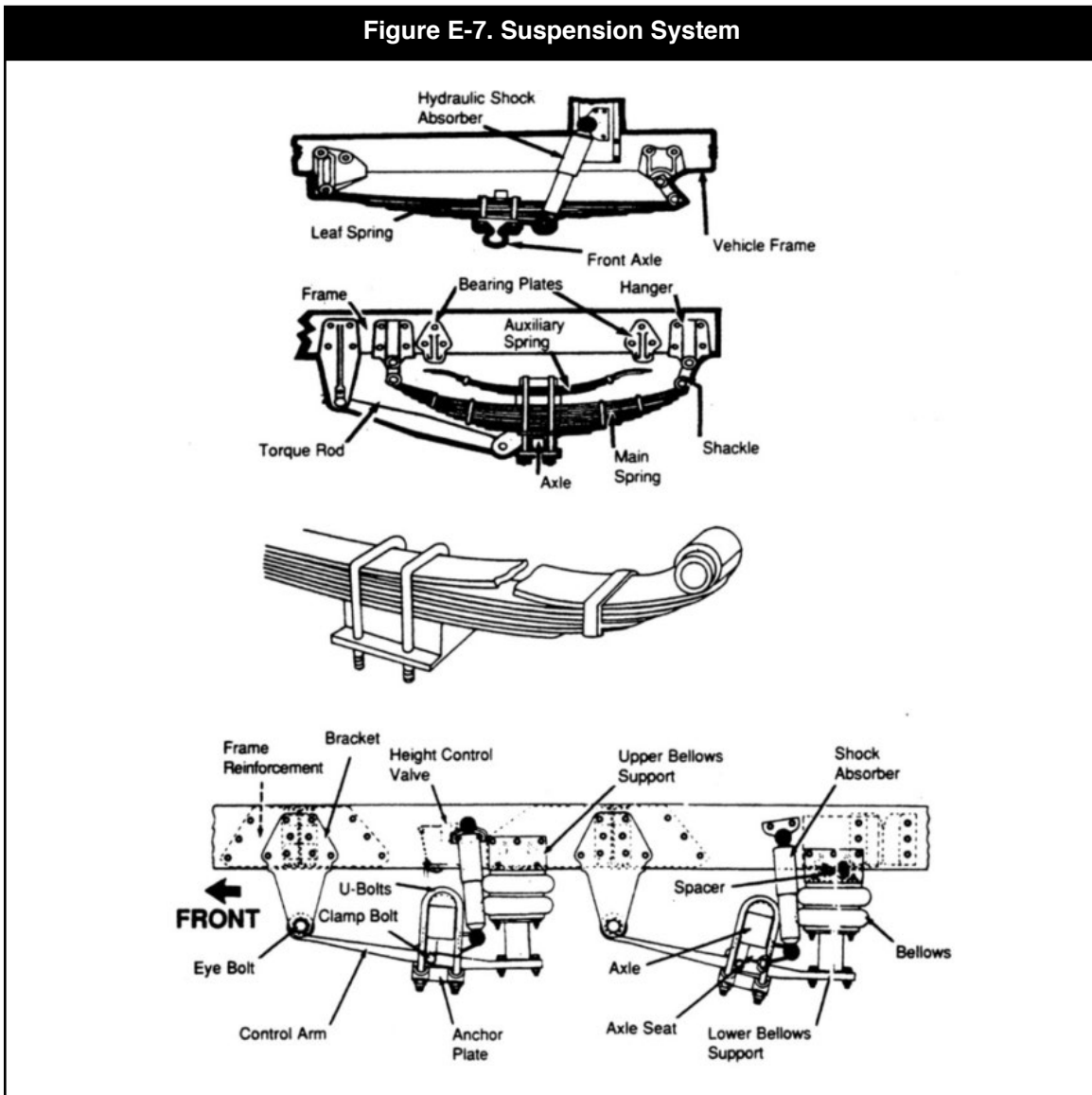

- Crossing arm control should be secure and not broken;
- Right front brake;
  - ❖ Brake drum – The brake drum should have no cracks, dents or holes, and no missing or loose bolts. Brake linings should not be worn thin.
  - ❖ Condition of hoses – Hoses should not be cracked, worn, or frayed, and couplings should be secure.
  - ❖ Slack adjuster (for air brakes) – The slack adjuster should have no broken, loose or missing parts. The angle between the push rod and the adjuster arm should be about 90 degrees when the parking brake is applied. When pulled by hand, brake push rod should move no more than about 1” (front brake).
  - ❖ Brake chamber (for air brakes).
  - ❖ NOTE: Valves and brake shoes cannot be checked by the operator during the pre-trip inspection.

**Check Front Side**

- Condition of front axle;
- Condition of steering system (See Figure E-8);
  - ❖ No loose, worn, bent, damaged, or missing parts.
  - ❖ Grab the steering wheel to test for looseness. Steering wheel play should not be more than 10 degrees or two inches of movement at the rim of a 20-inch diameter steering wheel.
  - ❖ Steering box and steering linkage: Look for missing nuts, bolts, fluid leaks, and damage to the power steering hose. No connections to the front wheels should be cracked.

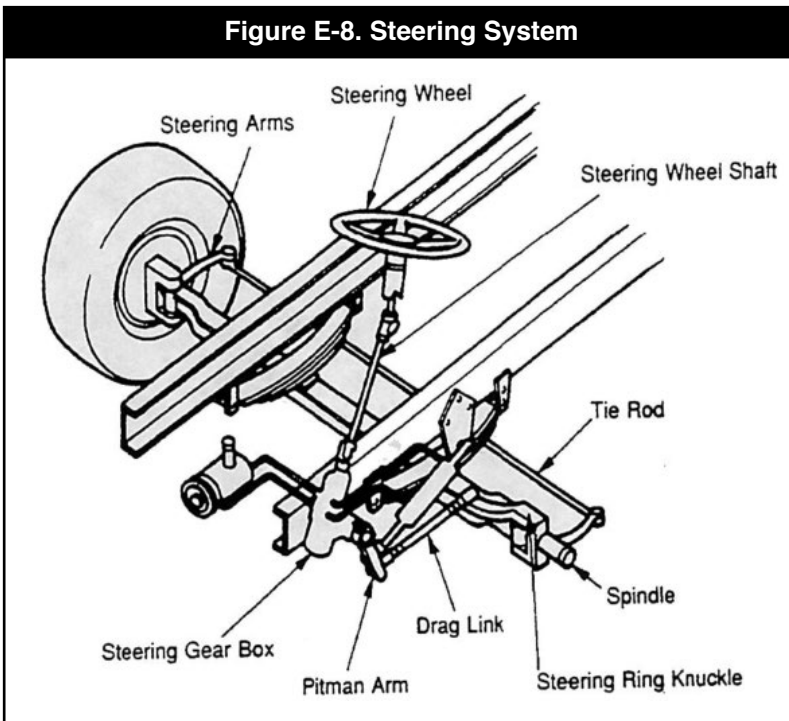

- Condition of windshield;
  - ❖ Check for damage.
  - ❖ Clean it if dirty. Never wipe a dry window or mirror; this can cause fine scratches. When cleaning the windshield, never move the wiper arms from side to side because this breaks the gear in the motor. You can lift the wiper straight off of the windshield and then drop it back into place after cleaning.
  - ❖ Check the windshield wiper arms for proper spring tension.
  - ❖ Check wiper blades for damage, “stiff” rubber, and secure attachment.
- Lights and reflectors;

- ❖ Parking, clearance and identification lights are clean, operating and proper color (amber at front).
- ❖ Reflectors are clean and proper color (amber at front).
- ❖ Front turn signal light is clean, operating and proper color (amber or white on signals facing forward).
- ❖ Left school bus eight-way light system – is clean and operating.

**Check Left Front**

- Check all items as for right front;
- Check left side stop arm and wing guard. The Stop sign should come out with the lights and indicators flashing alternately; and
- Check left front fender rear and crossover mirrors as the right front.

**Check Left Side**

- Left fuel tank(s);
  - ❖ Securely mounted, not damaged or leaking,
  - ❖ Cap(s) on and secure.
- Battery check;
  - ❖ Securely mounted,
  - ❖ Adequate fluid level,
  - ❖ No leaks.
- Condition of visible parts;
  - ❖ Transmission not leaking,
  - ❖ Exhaust system is secure, not leaking, not touching wires, fuel, or air lines,
  - ❖ Frame and cross members have no bends or cracks,
  - ❖ Air lines and electrical wiring are secured against snagging, rubbing and wearing;
  - ❖ Spare tire carrier or rack is not damaged (if equipped),
  - ❖ Spare tire and/or wheel is securely mounted in rack, and
  - ❖ Spare tire and wheel adequate (proper size, properly inflated).

**Check Left Rear**

- Check left rear tires, wheels and rims (previously outlined in this unit);
  - ❖ General condition,
  - ❖ Hub oil level adequate,
  - ❖ 2/32" tread depth,
  - ❖ Make sure there are no obstructions between the dual wheels.
- Suspension: Same as front right suspension (previously outlined in this unit);
  - ❖ Condition of spring, spring hangers, shackles, U-bolts,
  - ❖ Axle is secure.
- Brakes – Same as front right suspension (previously outlined in this unit);
  - ❖ Condition of brake drum(s),
  - ❖ Condition of hoses,
  - ❖ Slack adjuster (for air brakes),
  - ❖ Brake chamber (for air brakes).
- Lights and Reflectors;
  - ❖ Side-marker lights are clean, operating and proper color (red at rear, others amber),
  - ❖ Side-marker reflectors are clean and proper color (red at rear, others amber),

### **Check Rear Side**

- Lights and Reflectors;
  - ❖ Rear clearance and identification lights are clean, operating and proper color (red at rear),
  - ❖ Reflectors are clean and proper color (red at rear),
  - ❖ Tail lights are clean, operating and proper color (red at rear),
  - ❖ Rear turn signal is operating and proper color (white, red or amber at rear).
- License plate(s) is present, clean and secured;
- Splash guards are present, not damaged, properly fastened, not dragging on ground or rubbing tires;
- Rear emergency door and side emergency door exits open and close properly from outside the bus;
- Exhaust system;
  - ❖ Pipes, muffler, tailpipe and hangers are securely mounted without cracks, holes, or severe dents,
  - ❖ Muffler and pipes should not be touching wires, fuel hoses or air hoses,
  - ❖ No excessive smoke, hissing, vibration, or noise,
  - ❖ The tailpipe does not extend beyond two inches from the rear of the vehicle.

### **Check Right Rear**

- Check all items as on left side and fuel tank area including straps, cap, and signs of fuel leaks:

## **5. CHECK BRAKE SYSTEM**

Brakes are the most critical piece of safety equipment on your vehicle. You will need to make sure they are working properly before taking your bus on the road. This includes the parking brake and the service brake.

To test the parking brake:

1. Fasten seat belt;
2. Allow bus to move slowly forward; and
3. Apply parking brake. If the bus doesn't stop, it's faulty, and you must get it fixed before taking your bus on the road.

If your bus is equipped with hydraulic brakes, test for hydraulic leaks:

1. Pump the brake pedal three times;
2. Apply firm pressure to the pedal and hold for five seconds; and
3. The pedal should not move. If it does, there may be a leak or other problem. Get it fixed before operating the vehicle.

If your bus is equipped with air brakes, refer to Sections 5 and 10 of the Commercial Driver's License Manual for testing. The manual is available on PennDOT's Driver and Vehicle Services website, [www.dmv.pa.gov](http://www.dmv.pa.gov) under the Commercial Driver Information Center.

Here are some procedures for an air brake test:

- With the engine running, build the air pressure to the governed cut out (typically 100-125 psi) and shut off the engine. Turn the key, but do not start the engine; chock your wheels and release the parking brake. Check the air gauge to see if the pressure drops more than two psi in one minute. If the air loss is greater, check for leaks and fix before driving.
- Then fully apply pressure to the foot brake and hold for one minute. Check the air gauge to see if the pressure drops more than three psi. If the air loss is greater, check for leaks and fix before driving.
- Begin fanning off the air pressure by rapidly applying and releasing the foot brake. The low air warning devices (buzzer, light, flag) should activate before the pressure drops below 60 psi.
- Continue to fan off the air pressure. At approximately 40 psi to 20 psi, the parking brake valve should close by popping out.
- Check the air pressure build-up rate by starting the engine. When the engine is at operating RPM, the pressure should build from 85 to 100 psi within 45 seconds in dual air systems. If the vehicle has larger than minimum air tanks, the build-up time can be longer and still be safe. Check the manufacturer's specifications.

Regardless of what type of brake system your school bus is equipped with:

1. Release the parking brake;
2. Move forward at about five MPH;
3. Push brake pedal firmly; and
4. Watch for "pulling" to one side or any unusual brake pedal "feel" or delayed stopping action. These may indicate trouble, and you should have the bus serviced.

### **Automatic Slack Adjusters (ASAs)**

All airbrake vehicles manufactured since Oct. 20, 1994, are required to have automatic slack adjusters (ASAs). ASAs should not have to be manually adjusted except when performing maintenance on the brakes and during the installation of the brake adjusters. In a vehicle equipped with ASAs, when the pushrod stroke exceeds the legal brake adjustment limit, it is an indication a mechanical problem exists in the adjuster itself, a problem with the related foundation brake components or the adjuster was improperly installed.

The manual adjustment of an ASA to bring a brake pushrod stroke within legal limits is generally masking a mechanical problem and is not fixing it. Further, routine adjustment of most ASAs will likely result in premature wear of the adjuster itself. It is recommended when brakes equipped with ASAs are found to be out of adjustment, you take the vehicle to a repair facility as soon as possible to have the problem corrected. The manual adjustment of an ASA should only be used as a temporary measure to correct the adjustment in an emergency situation, as it is likely the brake will soon be back out of adjustment since this procedure usually does not fix the underlying adjustment problem. ASAs are made by different manufacturers and do not all operate the same. Therefore, the manufacturer's service manual for the specific ASA being used should be consulted prior to troubleshooting a brake adjustment problem.)

Once everything has been completed, check for all required papers, trip manifests, permits, etc., and secure all loose articles in driver's compartment.

## PREVENTIVE MAINTENANCE WHILE ON THE ROAD

The previous section detailed checks you should make before leaving on your daily route. This section deals with preventive maintenance while on the road. The section is divided into two parts: detecting abnormal vehicle behavior, and following good driving habits that will extend the life of the vehicle and its components.

### DETECTING ABNORMAL VEHICLE BEHAVIOR

Detecting abnormal vehicle behavior requires you to use most of your senses: sight, sound, smell, and touch. As a first step, you must learn to recognize the normal running condition of the vehicle while at the wheel so you can compare normal conditions with unusual steering, rattles, odd smells, or other conditions. For this reason, and as a vital safety practice, it is important to road test the vehicle every morning before picking up the first passenger. This is not to say that after the road test, your preventive maintenance responsibilities are over. Throughout a trip, you should constantly monitor the engine gauges and the general operating condition of the vehicle in the same manner as during the road test.

#### Continuous Checks

- Watch gauges and instruments for trouble:
  - ❖ Instruments;
  - ❖ Air pressure gauge (if you have air brakes);
  - ❖ Temperature gauges;
  - ❖ Pressure gauges;
  - ❖ Ammeter/voltmeter;
  - ❖ Use your senses (sight, sound, smell, feel) to check for problems.
- Check critical items when you stop:
  - ❖ Tires, wheels, and rims;
  - ❖ Brakes;
  - ❖ Lights.
- Watch your mirrors.
- If you see, hear, smell, or feel anything that might mean trouble, check it out.

#### Check Parking Brake

Check the parking brake again before pulling out onto the road.

- If your bus is equipped with a ratchet-type lever, you should feel a distinct clicking of the ratchet pawl and the lever should lock firmly into place when you apply the brake. When properly adjusted, this brake should be capable of holding the bus on a hill. If you detect excessive looseness or lever travel, the lever slipping out of locked position, the lever binding, or the brake not holding the bus on a hill, have the parking brake adjusted.
- If the parking brake is an over-center type, it should not take excessive effort to apply, but it should still prevent the vehicle from rolling on a grade or with the transmission in gear.
- If the bus is equipped with air brakes, pull out the parking brake control knob to engage the parking brake. Put the bus in low gear and pull against the parking brake. If the vehicle does not hold with the parking brake knob in the engaged position, have the rear brakes adjusted.

**Check Service Brakes**

Check the service brakes after the parking brake, preferably before reaching the highway. Test at low speeds by bringing the bus smoothly to a complete stop. Your bus should stop in a straight line without skidding, swerving, pulling to either side, grabbing, locking, or making excessive noise.

- For buses with hydraulic brakes, the brakes should not need to be pumped to have braking power and should not need excessive pedal effort to engage. If they need either, have the brakes adjusted.
- With air brakes, the bus should stop as described above, but you have an additional check. Since air pressure is being used to apply the brakes, you will see some loss of pressure (as indicated on the air pressure gauge). In general, a brake adjustment is required, if the gauge pressure drops by more than 10 lbs. during a single brake application.
- Check the air pressure gauge, and vacuum the gauge periodically while on the road.

**Check Transmission**

Automatic transmissions should not slip or produce harsh, jerking shifts. With a manual transmission, ensure all forward and reverse gears engage smoothly with no unusual metallic clashing noises, burning clutch smells or shifting difficulties. The clutch should engage easily and smoothly, without jerking, slipping excessively, or chattering. Also, with a properly adjusted clutch, the pedal should move freely for approximately the first 1 to 1½ inches. Greater or lesser amounts of free clutch travel, or freeplay as it is commonly called, may indicate clutch wear.

**Check Steering**

While the bus is moving straight ahead, check the steering for the amount of play or looseness in the wheel. Check for a binding feel or any unusual noises when making full turns. As with the other checks above, report any unusual conditions at once.

**Check Suspension**

To ensure safe control of the bus while on the road, check the suspension. The suspension may have a malfunction, if the bus sags at one end or corner or if it bounces excessively. Also check that the bus tracks properly and does not weave or sway when turning.

**Check Engine**

In addition to periodic gauge checks, especially oil pressure, temperature and ammeter/ voltmeter, listen for any unusual engine noises. Note any hesitation in acceleration or any power loss when going uphill. This behavior can indicate cylinder misfires, damaged valves, a restricted exhaust system, or inaccurate engine timing. All of these problems can cause early engine wear and excessive fuel consumption.

As stated earlier in this section, you should continually check the items mentioned above while on the road. However, it is especially important to make these checks before picking up your first passenger. Report any abnormal operating condition immediately.

**Check Your Tires**

As mentioned in the pre-trip inspection, pay particular attention to your tires: proper inflation, no unusual wear, and proper tread depth, 4/32" on front tires and 2/32" on rear tires.



## GOOD DRIVING HABITS

The second part of your on-the-road preventative maintenance responsibility is operating the vehicle properly through good driving habits. Most of the procedures to be covered in this section will have no immediate effect on the vehicle's operation, but if practiced regularly, they will significantly increase the lifespan of the vehicle components.

### Starting the Bus and Basic Operations

When starting your bus, don't engage the starter for more than 10 seconds. This could cause damage to the flywheel or other parts. Never operate a bus with an overheated engine or with low oil pressure. This can cause serious engine damage – pay attention to your gauges.

To ensure proper service length for tires and to avoid damage while driving, never operate your bus with flat or under-inflated tires. Driving over curbs, objects and into potholes can damage tires quickly as can rubbing tires against curbs.

Don't idle excessively. A diesel bus gets warm by driving it. You won't get heat until the bus is operating on the road. It will not get warm sitting and idling no matter how long you let it idle.

### Proper Use of the Clutch

The clutch is the most abused component in the bus because of frequent use and because many drivers do not understand its function. A clutch assembly will give many miles of trouble-free operation, if you drive properly and maintain the clutch properly.

Here are some pointers:

- Don't use the clutch as a brake. Many drivers incorrectly use the clutch as a brake. For example, they will stop on an incline and, by feathering the clutch (letting the clutch partially out), hold the bus from rolling. By so doing, they force the slipping clutch to hold the entire weight of the bus and passengers. This severe friction generates excessive heat, which greatly shortens the life of the clutch.
- Don't ride the clutch. The throw-out bearing is a component of the clutch that does not turn when the clutch pedal is released, its normal position during driving. "Riding the clutch" is when the weight of a driver's foot resting on the clutch pedal is enough to move the throw-out bearing forward until it makes contact with the pressure plate and spins at the same speed as the engine. This serves no purpose except to increase wear and cause premature destruction of the bearing. The bearing is engineered to last a certain length of time and is factory packed in enough grease for this usage. Excessive use will use up this grease and will burn out the bearing. When shifting, use the clutch briefly and smoothly to achieve maximum durability.
- Make sure the clutch is adjusted properly. Another term you may have heard is toeboard clearance or freeplay. This refers to the amount of travel of the clutch pedal between its highest position and the point where you can feel contact being made. This clearance must be maintained in order to prevent the throw-out bearing from turning. On most equipment, clearance should be approximately 1 to 1½ inches. Due to normal wear of the clutch, clearance decreases gradually. The clutch should be adjusted frequently to maintain freeplay. Alert your supervisor or mechanic, if the clutch needs to be adjusted.

**Proper Use of the Brakes**

Brakes are another commonly abused vehicle component. You can extend brake life if you follow a few pointers. By watching the traffic ahead, you can observe when you may have to stop; slow the bus by letting up on the gas pedal prior to the stop so the brakes will be used lightly and only for a short time. You can use the engine's braking power to slow the bus prior to making a stop and to control your speed on downgrades. When stopping, apply the brakes gently whenever possible and ease up on pedal pressure as speed drops so you are using very light pressure at the end of the stop. Do not:

- Disengage the clutch until the bus has almost stopped; and
- Brake quickly or harshly or for extended periods of time on downgrades.

Both of these actions cause excessive brake heat and shorten brake life and braking effectiveness. Delayed braking can result in abrupt stops and ultimately in crashes. For buses with automatic transmissions, refer to the section on shifting procedures in Unit F (Driving Fundamentals).

**Protection of the Rear Axle**

Protection of the rear axle is a third good driving habit. For long rear axle life, never spin the rear wheels on slippery surfaces (such as snow or ice) or loose surfaces (such as sand or gravel). If the rear wheels spin for a long time, the high speed will throw the lubricant out from between the gears, which can damage the differential assembly. In more extreme cases, the internal gears may seize and break the shaft. Also, if a spinning wheel suddenly hits dry pavement or solid ground, the resultant shock can totally destroy the differential.

**Proper Use of the Transmission**

Proper use of the transmission can save wear and tear on gears, clutch, engine, and brakes. Maintain a constant speed whenever possible to save fuel and reduce wear on drive line components.

**Manual Transmission.**

With a manual transmission, always start the vehicle moving in low gear, moving at a slow rate of speed. This will ensure proper lubrication of internal transmission and rear axle parts, and will avoid the possibility of lugging the engine or slipping the clutch. As you move faster, progressively shift the transmission to the gear that will maintain the desired road speed. When driving a vehicle with a manual transmission:

- Always start off in first gear when carrying a heavy load;
- With a four-speed transmission, use first through fourth gears on level ground;
- With a five-speed transmission under light load conditions, use second through fifth gears for normal driving;
- When going up hills, downshift to avoid lugging the engine;
- When going down a hill, use one gear lower than would be required to go up the hill. Using lower gears will help slow the bus down and prevent the brakes from overheating due to excessive use; and
- Stop completely before shifting into first gear or reverse.

**Automatic Transmission.**

For vehicles equipped with automatic transmissions, proper selection of the correct gear provides better control without undue wear on the transmission. Avoid using the accelerator to hold a vehicle with an automatic transmission on a hill. When driving a vehicle with an automatic transmission, use the gearshift as described in the owner's manual for better vehicle control. Shifts are especially helpful when approaching hills and grades. Before driving a bus equipped with an automatic transmission for the first time, consult the owner's manual for detailed operating instructions. While the preventive maintenance on-the-road checks and driving habits presented in this section are vitally important to the safe operation and long life of the vehicle, your single most important preventive maintenance responsibility is to immediately and accurately report any malfunctions.

## POST-TRIP PREVENTIVE MAINTENANCE PROCEDURES

Your maintenance responsibilities are not over until you stop the vehicle, check it over, and report its condition to your supervisor or maintenance department. Complete the following steps at the end of every trip:

- If possible, fill the fuel tank in the evening rather than waiting until the following morning, if this is one of your responsibilities. This will reduce the overnight condensation of water vapor inside the fuel tank.
- When parking your bus, after you set the parking brake and put the transmission in neutral, allow the engine to idle slowly as per manufacturer's recommendations. This will permit proper lubrication of all engine parts, and is of particular importance for diesel vehicles.
- While the engine is idling, check the interior for broken windows, ripped seats or other damage that should be repaired before the bus is used again. Check on and under the seats for sleeping students, books, clothes or other materials that may have been left by the students.
- Sweep the floor and steps of the bus. Enforcing a clean bus policy with your students will help you maintain your bus. Also, periodically washing the interior of the bus including seats, windows and windowsills is good practice.
- Check the exterior of the bus for burned out bulbs or other damage that needs to be repaired. Re-enter the bus, turn off all electrical equipment, shut off the engine, remove the keys, and secure the bus.
- Generally, drivers should remove the key from the ignition. Check with your supervisor for your local policy on this issue.

Remember that federal regulations in 49 CFR Section 396.11 require every motor carrier require its drivers to report, and every driver shall prepare a report in writing at the completion of each day's work on each vehicle operated, and the report shall cover at least the following parts and accessories:

- Service brakes, including trailer brake connections;
- Parking (hand) brake;
- Steering mechanism;
- Lighting devices and reflectors;
- Tires;
- Horn;
- Windshield wipers;
- Rear vision mirrors;

- Coupling devices;
- Wheels and rims; and
- Emergency equipment.

The regulation also details report contents, corrective actions and exceptions.

## **IMPORTANCE OF REPORTING PROBLEMS**

Clearly, your responsibilities as a school bus operator include reporting any and all abnormal conditions encountered during the day to your supervisor or maintenance department. This could be something you discovered in the pre-trip inspection, while the bus was in service, or after your trip. Failure to inspect equipment before each trip and failure to report defects and needed repairs cannot only create costly maintenance problems, it can also create an unsafe condition for you and your passengers. Remember, problems cannot be repaired, if they are not reported.

When reporting, be accurate in describing the problem; you do not need to diagnose. Mechanics will need accurate information on:

1. Location;
2. Timing;
3. Sounds; and
4. Other descriptive characteristics.

Write it down, pass it on, get it fixed.

Report anything affecting safety or possibly leading to mechanical breakdown. The vehicle inspection report tells the vehicle owner about problems that may need to be fixed. Keep a copy of your report in the vehicle for one day. That way, the next driver can learn about any problems you have found. Federal regulations outline additional recordkeeping requirements and timeframes. Refer to 49 CFR Sections 396.3 and 396.21.

## **FIVE BASIC ITEMS MECHANICS WANT YOU TO KNOW**

1. Understand and learn to read your gauges. Knowing your voltage meter, oil pressure and water temperature readings could save your engine.
2. When you first notice any type of repair that needs to be done, write it up immediately. This could prevent a major repair later and be less costly to fix.
3. If you drive a diesel bus, remember to let your bus idle as per manufacturer's recommendations in the lot before you turn it off. This will cool down the turbocharger and may extend engine life.
4. If you have a flat tire in a rear wheel, do not drive on it. A minor cost can turn into an expensive replacement.
5. The glow plug (if equipped with one) on the dash on a diesel bus will go out when the bus is ready to start.

# UNIT F - SAFE DRIVING

INTRODUCTION .....	F-3
THE DRIVING TASK .....	F-5
Information .....	F-5
Decision .....	F-6
Action .....	F-6
DRIVER CONDITIONS .....	F-7
Knowledge .....	F-7
Expectancy .....	F-8
Skills .....	F-8
Health .....	F-8
Illness .....	F-8
Drugs and Driving: Alcohol .....	F-9
The Truth about Alcohol .....	F-9
What is a Drink? .....	F-9
How Does Alcohol Work? .....	F-10
What Determines Blood Alcohol Concentration (BAC)? .....	F-10
How Does Alcohol Affect the Brain? .....	F-10
How Does Alcohol Affect Driving? .....	F-10
Drugs and Driving: Other Drugs .....	F-11
Concentration and Attitude .....	F-11
Aggressive Driving .....	F-11
Attention and Monitoring .....	F-13
Driver Fatigue .....	F-15
Warning Signs of Driver Fatigue .....	F-15
At-Risk Groups .....	F-15
Avoiding Consequences of Driving While Fatigued .....	F-16
Cell Phones and Texting While Driving .....	F-16
VEHICLE CONDITIONS .....	F-17
Pre-Trip Conditions .....	F-17
On-The-Road Conditions .....	F-18
ENVIRONMENTAL AND ROADWAY CONDITIONS .....	F-18
Scanning Ahead .....	F-18
Importance of Scanning Ahead .....	F-19
Know How Far to Scan .....	F-19
Look for Traffic .....	F-19
Check Mirrors .....	F-19
Driving on Slippery Surfaces .....	F-19
Before Your Trip .....	F-19
While on the Road .....	F-20
After Your Trip .....	F-21

Reduced Visibility . . . . .	F-21
Weather Conditions . . . . .	F-21
Bright, Glaring Sunlight . . . . .	F-21
Night Driving . . . . .	F-21
Equipment Adjustments . . . . .	F-22
Heavy Wind . . . . .	F-23
Highway Hazards . . . . .	F-23
Road Geometry . . . . .	F-23
Intersections and Right-of-Way . . . . .	F-24
Unregulated Intersection . . . . .	F-24
Regulated Intersection: Yield Control . . . . .	F-24
Regulated Intersection: Stop Control . . . . .	F-24
Regulated Intersection: Traffic Signals . . . . .	F-25
Circular Intersections . . . . .	F-25
Uniformed Police Officer . . . . .	F-26
Private Drive . . . . .	F-26
Crossing Main Highways . . . . .	F-26
Road Surface . . . . .	F-26
Roadside Conditions . . . . .	F-26
Pedestrian Hazards . . . . .	F-27
Vehicle Hazards . . . . .	F-27
Drivers in a Hurry . . . . .	F-27
Losing Control . . . . .	F-27
Lack of Communication by Other Drivers . . . . .	F-28
Failure of the Other Driver to Observe . . . . .	F-28
Inadequate Adjustment by the Other Driver . . . . .	F-28
Aggressive Driving by Other Motorists . . . . .	F-29
Slow-moving or Stopped Vehicles . . . . .	F-29
Multiple Vehicle Hazards . . . . .	F-29
Work Zones . . . . .	F-30
Motorcycles . . . . .	F-30
 CONTROLLING SPEED . . . . .	 F-30
Following Distances . . . . .	F-31
 STOPPING . . . . .	 F-32
Stopping Distance . . . . .	F-32
Speed and Traffic Flow . . . . .	F-33

# UNIT F- SAFE DRIVING

## INTRODUCTION

The social and economic cost of traffic crashes in the United States is tremendous. Over the last few years, the country has experienced millions of reportable crashes per year in which thousands of persons have been killed and millions injured. These are not just statistics; the numbers represent real people who are our families, friends and co-workers. The economic loss is estimated to be in the billions every year.

One piece of good news is school bus transportation is the safest mode of ground transportation. In Pennsylvania, for example, school bus crashes account for less than a ½ percent of the total number of vehicular crashes. In striving for the elimination of all crashes involving school buses, there needs to be an understanding of what causes them so that we can implement better, safer driving techniques as countermeasures. One way to understand crashes is to identify three primary contributing factors to crashes:

- The driver;
- The vehicle; and
- The road and its environment.

According to police crash reports, the following diagram represents these factors and the relative frequency of their occurrence.

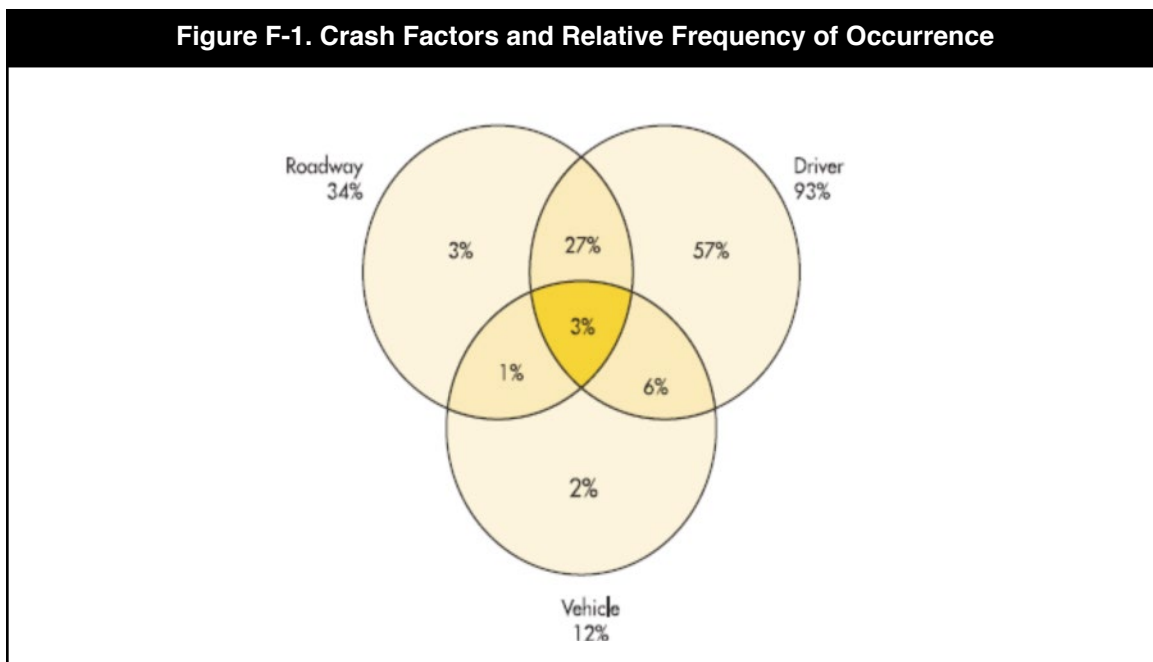

As shown, driver error is the cause of most crashes, followed by road condition, and vehicle defect or malfunction. A human factor may be speeding while operating a vehicle. In fact, Pennsylvania school bus crash statistics show the top five driver actions implicated when the school bus was the prime unit in the crash were: failure to stop; improper turn; speeding; tailgating; and other improper driving. “Distracted driving” and “careless backing” were other significant factors. All of these are human factors.

Vehicle factors may be mechanical failures, such as bad brakes or tires. Road-related factors can be limited sight distance, poorly marked roads or missing road signs, or sudden changes in roadway width. Weather is also a major factor affecting road conditions. Too often, drivers fail to consider wet roads or fog when they drive. Pennsylvania school bus crash statistics indicate school bus drivers were more likely to be noted for driving too fast for conditions in crashes occurring in rain-fog conditions and especially snow-sleet conditions, than in clear weather conditions. Remember: Safety first, schedule second!

When you consider road transportation as a system, it is clear that as school bus operators, you can directly control some factors, but not others. For example, you can control driver factors (how you operate a vehicle), and to a certain extent vehicular factors (practicing good preventive maintenance techniques as discussed in Unit E). On the other hand, as a school bus operator there is not much you can control in the roadway environment. You cannot engineer a roadway to eliminate shoulder edge drop-offs, nor can you control the weather. However, you can learn how to safely operate your bus, if you encounter dangerous roadway conditions.

Therefore, safe driving techniques can be applied to counteract many crash causes, especially those involving driver error and even some involving roadway and vehicular issues. Crashes can be reduced through the knowledge and practice of safe driving techniques. Learning safe driving procedures and techniques designed to help you, the driver, avoid getting yourself, your vehicle, and your passengers into hazardous situations are a critical part of your job as a school bus operator. A number of short courses on the basics of defensive driving are offered throughout the state. You should consider enrolling in one of these courses to improve your driving skills and to become aware of your limitations as a driver. There is nothing new or magical about the concept of defensive driving. The formula is simply:

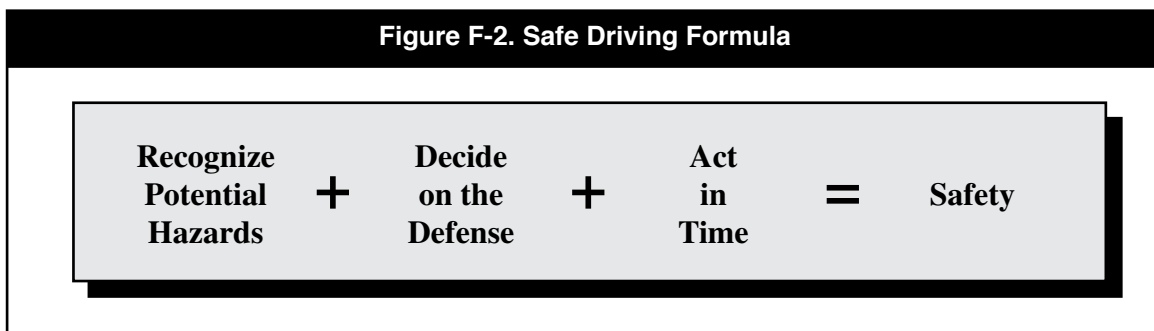

This unit considers how you can apply these steps to the following types of normal and unusual conditions you must face while driving a school bus.

This unit will focus on safe driving techniques for school bus operators geared towards reducing the number of crashes in the categories listed previously in this unit. It will focus on:

- The driving task;
- Your condition to drive (Driver);
- The condition of your vehicle (Vehicle);
- The weather and road conditions (Environmental and Roadway); and
- Road construction, pedestrians and other obstacles (Other).

Note that Unit H (Crash and Emergency Procedures) covers procedures and techniques for emergency and crash situations where the driver did not or could not avoid a potential hazard.



## THE DRIVING TASK

Although most of us take it for granted, driving is hard work because it requires us to do several things at the same time. This is especially true for school bus operators who have additional responsibilities, such as student

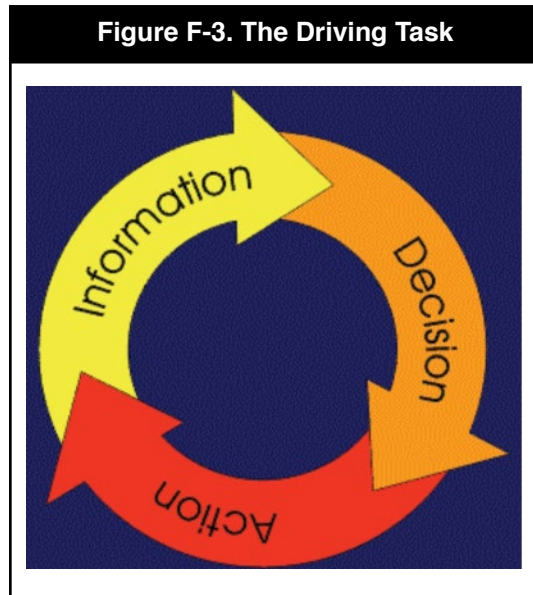

management and discipline; loading and unloading students; monitoring traffic, etc. When you drive a bus, you control the vehicle: slowing down, speeding up, and turning; anticipating what other road users might do; and deciding whether evasive actions are necessary. These tasks are to be accomplished simultaneous to steering the vehicle to get from where you were to where you need to be. Unfortunately, there are limits to how much information you can process at a time. When there is too much information to accurately and safely process, mistakes can happen.

There are three distinct phases to the task of driving: information, decision and action. Roadway information leads the bus operator to decide to do something and take action. The results of that action provide more information, which then starts the process over again. This can be shown graphically in Figure F-3.

### INFORMATION

School bus operators, indeed ALL drivers, need good information to perform the driving task safely. In this fashion, operators can properly PERCEIVE the information and RECOGNIZE its meaning. As the following points indicate, how drivers get information is important to safety:

- Signs have standardized shapes and colors to help drivers easily recognize their message. Most agencies rely on the Manual on Uniform Traffic Control Devices (MUTCD) for information on sign design and messages. For example, studies on human factors have shown most drivers can read only three or four familiar words at a glance, so signs are designed and installed to avoid overloading drivers with information. They also consider information needs of both older and novice drivers. If there are confusing sign messages, report them to your supervisor who can follow up with the appropriate entity responsible for traffic control devices in the area.
- Signs should be placed at locations where drivers expect them and can see them. Often the message is repeated for emphasis. As a school bus driver, pay attention to these messages that relay critical safety information. For instance, using chevron signs along the outside of a curve can reinforce a curve warning sign. Learn about the basics of traffic control devices so you can readily absorb and react to the information provided.
- Engineers avoid designing roads with sharp curves just over hillcrests to improve sight lines for drivers. Similarly, they use consistent design curve radii so drivers are not surprised by curves that are too sharp or too gradual.



## DECISION

As a school bus driver, you combine the information you gather with your driving experience to make driving decisions. It takes skill and experience to make the right decision. You must pay attention so you can process several information messages at once, and ignore what you do not need. These are skills that novice drivers are still learning and older drivers sometimes find difficult to process.

Hopefully, information and decision points are spread at sufficient distances on the roadway. It is easier to make several simple decisions, one after the other, than it is to make one complex decision in a hurry.

## ACTION

Action happens when you make a decision and act on it. The results of the action provide more information, which, as indicated above, starts the process over again.

For your trip to be a safe one, you need time to respond to different conditions. Reaction time is the time it takes for you to notice a condition, decide what to do about it and then act on it. The more information you must process, or the more complex the decision required, the longer it takes you to react. This concept is discussed in detail below.

While a perception-reaction time of 2.5 seconds is commonly used in highway design, driver response times can range from 1 second for a simple decision like initiating a panic stop to 15 seconds for a complex decision like choosing the correct exit in a convoluted highway interchange.

Further complicating the task of driving for the bus operator are distractions inside and outside the vehicle. Maybe you hear a cell phone ring or students are being unruly on the bus. Maybe you get a call on the radio from your dispatcher. Perhaps a student is talking to you or pointing out something of interest along the roadside. Maybe you are a bit behind schedule, and your students are slow to get onto the bus and get seated. Maybe the trip must be made during a severe rain or snowstorm. Possibly it is just a beautiful day to drive through a scenic area, and you are tempted to focus on something other than the road.

Whatever it is that draws your attention from the road, it is clear that driving a school bus requires the operator's full attention. This will be discussed later in this unit.

"Better late than never" is an old saying that applies to all drivers. You can't rush and drive cautiously at the same time. Establish a pattern for driving cautiously and stick with it, late or not. Drive according to the motto "Safety first...schedule second." Plan your schedule, so you always have plenty of time.

## DRIVER CONDITIONS

Human factors refer to people and the things they do, or fail to do, that can cause a crash. Human factors cover drivers whose attention is distracted, are tired or ill, (and may have taken medication that makes them drowsy), or use alcohol or drugs. Age also affects a driver's ability to be safe on the roadway. For example, older drivers often have vision problems at night, while younger drivers tend to take more risks on the road.

Therefore, you must be mentally and physically prepared to drive every minute of every trip. Your general attitude toward driving, whether you look upon driving a school bus as a privilege and high responsibility or as a chore to be done in as little time and with as little effort as possible, will determine, more than anything else, your safety record. Some temporary conditions, such as anger, worry or fear, can take your mind off of the road. A tendency to daydream can be just as dangerous, because driving requires concentration at all times.

Before operating a school bus, take mental stock of yourself: Are you mentally and physically ready to drive? Safe drivers are aware of their own deficiencies and constantly strive to overcome them. YOU are in control of these elements.

## KNOWLEDGE

Your experience in driving automobiles can provide a basis for learning to drive a school bus. Automobile and bus operation require similar knowledge, including rules of the road and general safe driving habits. The skills needed to operate the steering, transmission, lights, wipers, and other mechanical components of a bus are similar to those for an automobile. There is usually, however, a difference in scale. Most differences between automobile and bus operation are due to the relatively large size and weight of the bus. Always remember a bus has a longer stopping distance, slower acceleration, wider turning radius, and higher and wider clearances. Another difference is while school bus drivers sit higher and have a better forward view, there is much more reliance on mirrors for adequate rear and side viewing.

Evaluate your knowledge of state and local driving rules and regulations, driving fundamentals, emergency procedures, and defensive driving habits. If you are uncertain or have questions, ask before it's too late. As described above, school bus drivers need good information to operate their vehicles safely. Since much of the information is communicated through traffic control devices, learn about traffic control devices and methods by which they communicate information.

**Also, state laws applicable to all drivers (both cars and school buses) are not described in this manual. For information on these laws, check the following references:**

1. Pennsylvania Driver's Manual (Publication 95), available at [www.dmv.pa.gov](http://www.dmv.pa.gov).
2. The Pennsylvania Vehicle Code (Title 75), available at [www.dmv.pa.gov](http://www.dmv.pa.gov).
3. Commercial Driver's Manual (Publication 223), available at [www.dmv.pa.gov](http://www.dmv.pa.gov).
4. Chapter 71 of Title 67 – Transportation (Pennsylvania Code), available at [www.pacode.com](http://www.pacode.com).
5. Chapter 104 of Title 67 – Transportation (Pennsylvania Code), available at [www.pacode.com](http://www.pacode.com).
6. Chapter 171 of Title 67 - Transportation (Pennsylvania Code), available at [www.pacode.com](http://www.pacode.com).

## EXPECTANCY

As all drivers gain experience, they expect things to happen as they always have. For example, you would expect a green light on a traffic signal will be followed by a yellow light. Another example would be you adjust your speed as you perceive an upcoming curve, because it looks similar to other curves you have driven, and your experience tells you that you need to slow down. This is called expectancy. If a signal changes from green to red, or a curve becomes suddenly tighter halfway through, your expectancy is violated, and you may react in an erratic or incorrect way.

The more experienced you become, the greater the level of expectancy, which leads to quicker and more accurate reactions as long as your expectancy is met. A sudden change in road conditions, which violates your expectancy tends to increase your reaction time and increases the likelihood of you making an error because you take longer to understand the situation and respond to it. If extra time is not available, the result may be a crash. That is why expectancy violations cause problems, and removing expectancy violations helps improve safety.

Keep in mind, however, not to become complacent. Most likely you are on the same route day after day, and it can be easy to become complacent regarding driving habits. Defensive driving techniques and anticipating hazardous conditions is critical.

## SKILLS

If you need practice in driving maneuvers, operating safety equipment, or other driving-related skills, ask your certified school bus driver instructor or supervisor for help, then practice with your supervisor or on your own. If you have been involved in a crash, some school districts and/or employers will require you to complete remedial training with an instructor. Always practice in an empty bus rather than in one filled with students. Unit G and H provide you with descriptions of the many skills you will need to acquire to safely operate a school bus.

## HEALTH

Check yourself for fatigue, sickness, deficient eyesight, and deficient hearing. If you have any of these health problems, you should not drive until cleared by health services or your doctor.

For example, if you have problems with judging distance, or you know your depth perception is not as good as it might be or used to be (this is a normal eye-aging condition), it does not mean you may have to give up driving. You must be aware of the problem, however, and adjust your driving to it.

### Illness

Once in a while, you may become so ill you cannot operate your bus safely. If this happens to you, you must not drive. However, in case of an emergency, you may drive to the nearest place where you can safely stop.

## DRUGS AND DRIVING: ALCOHOL

Alcohol and drugs affect the driver and make them unfit to drive. Driving under the influence of alcohol is a serious violation of state law and a very dangerous mistake. People who drive under the influence are involved in crashes resulting in over 20,000 deaths every year. As a school bus driver, your personal decisions affect the lives of many others. You should know:

- How alcohol works in the human body;
- How alcohol affects driving;
- Laws regarding drinking and driving;
- Note that Pennsylvania has zero tolerance for drug and alcohol use by school bus and school vehicle drivers. Refer to Sections 1612, 1606 and 3802 of Title 75; and
- Legal, financial, and safety risks of drinking and driving.

If you have questions about the law, ask your supervisor to provide clarification.

### The Truth about Alcohol

There are many dangerous ideas about alcohol use. The driver who believes in these wrong ideas is more likely to get into trouble. Here are some examples:

TABLE F-1. Statements About Alcohol	
FALSE	TRUE
Alcohol enhances your ability to drive.	Alcohol is a drug that will make you less alert and reduce your ability to drive safely.
Some people can drink a lot and not be affected by it.	Everyone who drinks is affected by alcohol.
If you eat a lot first, you won't get drunk.	Food will not keep you from getting drunk.
Coffee and a little fresh air will help a drinker sober up.	Only time will help a drinker sober up; other methods just don't work.
Stick with beer – it's not as strong as wine or whiskey.	A few beers are the same as a few shots of whiskey or a few glasses of wine.

### What is a Drink?

It is the alcohol in drinks that affects human performance. It doesn't make any difference whether that alcohol comes from "a couple of beers," two glasses of wine, or two shots of hard liquor. All of the following drinks contain the same amount of alcohol:

- A 12-ounce glass of 5 percent beer.
- A 5-ounce glass of 12 percent wine.
- A 1½-ounce shot of 80 proof liquor.

## **HOW DOES ALCOHOL WORK?**

Alcohol goes directly from the stomach into the blood stream. A drinker can control the amount of alcohol he or she takes in by having fewer drinks or none. However, you cannot control how fast your body gets rid of alcohol. If you have drinks faster than your body can get rid of them, you will have more alcohol in your body and your driving will be more affected. The amount of alcohol in your body is commonly measured by the Blood Alcohol Concentration (BAC).

## **WHAT DETERMINES BLOOD ALCOHOL CONCENTRATION (BAC)?**

BAC is determined by the amount of alcohol you drink (more alcohol means higher BAC), how fast you drink (faster drinking means higher BAC) and your weight (a small person doesn't have to drink as much as a large person to reach the same BAC).

## **HOW DOES ALCOHOL AFFECT THE BRAIN?**

Alcohol affects more and more of the brain as BAC builds up. The first part of the brain that is affected controls judgment and self control. One of the bad things about this is it can keep drinkers from knowing they are getting drunk. And of course, good judgment and self control are absolutely necessary for safe driving.

As blood alcohol concentration continues to build up, muscle control, vision, and coordination are affected more and more. Eventually, a person will pass out. Alcohol can increase the effects of other drugs.

## **HOW DOES ALCOHOL AFFECT DRIVING?**

All drivers are affected by drinking alcohol. Alcohol affects judgment, vision, coordination, and reaction time. It causes serious driving errors, such as:

- Slower reactions to hazards;
- Driving too fast or too slow;
- Driving in the wrong lane;
- Running over the curb;
- Weaving;
- Straddling lanes;
- Quick, jerky starts;
- Not signaling, failure to use lights;
- Running stop signs and red lights; and/or
- Improper passing.

All of these increase the chances of a crash, losing your driving privilege, or injuring or killing yourself and/or others. Crash statistics show that the chance of a crash is much greater for drivers who have been drinking than for drivers who have not.

## **DRUGS AND DRIVING: OTHER DRUGS**

Besides alcohol, other legal and illegal drugs are common in our society. Laws prohibit you from possessing or using certain drugs while on duty. These same laws prohibit you from being under the influence of any “controlled substance,” including amphetamines, such as “pep pills” and “bennies,” narcotics, or any other substance that can make you unsafe.

While illegal drugs are always unlawful to possess and use, you should be aware that many medicines, prescribed and over-the-counter (e.g., cold medicines), can affect your eyesight, hearing and judgment. They may make you drowsy or otherwise affect your safe driving ability. While possession and use of a drug given to a driver by a doctor is permitted if the doctor informs the driver it will not affect safe driving ability, you should always read the labels on patent medicine bottles to check for possible side effects. Ask your doctor or pharmacist about prescriptions or over-the-counter medications you are taking to get a clear understanding of their effects and whether they will impair your ability to perform the task at hand. Also, keep in mind the interactions of different drugs can cause impairment. Ask your doctor or pharmacist.

The safest rule is not to mix drugs with driving at all. Mixing the use of alcohol and drugs while operating a school bus can lead to crashes resulting in death, injury and property damage. Drug abuse can lead to arrest, fines and jail sentences in addition to the loss of a person’s driving privilege.

## **CONCENTRATION AND ATTITUDE**

Being under emotional stress from home or work will often affect your ability to control the students on a loaded bus, so you will have to be extra cautious as you drive. You may be tired, dejected or depressed, making it hard to cope with a bus full of young, spirited children. During times of stress, ordinarily good drivers may miss stop signs and red lights, and may fail to yield the right-of-way. Under normal conditions, they would be less likely to commit these serious errors.

You must be alert to your own attitude. If you are under emotional stress and are unable to concentrate on your driving, or fear you cannot control your temper under stress, don’t drive. Under normal day-to-day stresses, your attitude can affect your good driving judgment. You must be aware of your attitude so you can be alert, think positively, keep yourself under control, and keep your mind on the job at hand.

It is extremely important you remain alert and attentive at all times. Even the shortest lapses into daydreaming or inattention can cause severe crashes to occur. Always be aware of what is happening in your surroundings and anticipate what other drivers will do and what road conditions will be in order to act appropriately.

### **Aggressive Driving**

One component of driving with the right attitude is not to engage in aggressive behavior while operating your bus. Speeding and other aggressive driving behaviors are among the leading causes of highway crashes and fatalities in Pennsylvania. However, many motorists don’t realize they in fact, aggressive drivers. Here are some questions to help you determine if you are an aggressive driver:

- Do you speed excessively?
- Do you tailgate slower vehicles?
- Do you race to beat red lights or run stop signs?
- Do you weave in and out of traffic?
- Do you pass illegally on the right?
- Do you fail to yield the right of way to oncoming vehicles?

If you answered yes to any of these questions, you may be an aggressive driver and are putting yourself, your passengers, and other people on the road with you at increased risk of a crash.

While a driver must commit two or more of the following 16 offenses to be categorized as an aggressive driving violation and/or crash, ANY of these behaviors is aggressive and not acceptable for school bus operators:

1. Making an illegal u-turn;
2. Improper/careless turning;
3. Turning from the wrong lane;
4. Proceeding w/o clearance after stop;
5. Running a stop sign;
6. Running red light;
7. Failure to respond to other traffic control device;
8. Tailgating;
9. Sudden slowing/stopping;
10. Careless passing or lane change;
11. Passing in a no passing zone;
12. Making improper entrance to a highway;
13. Making improper exit from a highway;
14. Speeding;
15. Driving too fast for conditions; and
16. Driver fleeing police (Police chase).

As illustrated by Pennsylvania school bus crash data, any of these behaviors is unacceptable when operating a school bus.

- For example, Pennsylvania school bus crash data indicated drivers involved in rear end collisions are very likely to be noted as tailgating.
- In fact, drivers noted as tailgating were 61 times more likely to be involved in a rear-end collision than drivers involved in collisions who were not noted as tailgating.
- Similarly, drivers noted as failing to stop were 33 times more likely to be involved in an angle collision than drivers who were not. (An angle collision occurs when two vehicles approaching from non-opposing angular directions collide.) These typically result from one vehicle failing to either stop or yield right of way from a Stop or Yield sign, running a red light, or not clearing an intersection when the conflicting movement's signal turned green.

The line is aggressive driving leads to a higher risk of crashing.



To mitigate this, follow these guidelines:

- **Plan ahead** – Allow yourself enough travel time to prevent a time crunch. Safety first, schedule second.
- **Concentrate** – Don't allow yourself to become distracted by students. Do NOT talk on your cell phone, eat or drink while driving.
- **Relax.**
- **Drive the posted speed limit** – Fewer crashes occur when vehicles are travelling at or about the same speed. Driving too fast can lead to “bottle-necking,” bringing traffic to a standstill and frustrating drivers.
- **Be late rather than unsafe** – Obviously schedule is important, but just be late, if safety will be compromised.
- **Set an example for younger passengers** – Children are keenly observant. Educating them at an early age through your actions will teach them the importance of being courteous.

While many people associate aggressive driving with road rage, they are two different behaviors. Road rage, which is a criminal offense, is often the result of aggressive driving behavior escalating into an assault with a vehicle or other dangerous weapon. NEVER take your anger out on someone else on the road. Sometimes incidents of road rage are caused by simple misunderstandings between drivers. One driver may make a momentary error in judgment that another driver sees as aggressive, though none was intended.

## ATTENTION AND MONITORING

As mentioned earlier, there are many things you must be aware of when you are driving a school bus. You must be able to divide your attention between the students, the road, other vehicles, and your own bus. At each point on your trip, you must focus your attention on the most important factor at that time. For example, you must carefully focus on the students crossing the street at loading and unloading zones.

First, determine what you need to observe, inside and outside the bus, while driving the bus. Inside the bus, you must be aware of the students and their behavior, the dashboard, your inside mirror, and the steering wheel. Outside the bus, you must observe other traffic, pedestrians, your outside mirrors, the road in all directions, and the surrounding area.

Next, prioritize your monitoring and attention. For example, it is critical to monitor student behavior especially when they are misbehaving, and before and after student pickup and dropoff as described in detail in Unit C. If behavior is taking too much attention away from your driving, stop the bus, and get control of the students.

On the dashboard, you must check the fuel gauge, oil gauge, temperature gauge, and speedometer. It is best to look at the gauges carefully at the start of the trip, and occasionally during the trip, especially if there seems to be a problem with the bus. The speedometer should be monitored throughout the entire trip to maintain a safe speed.

There is usually one inside mirror you must monitor, although a rearview mirror may be present on some Class C buses. The interior mirror is used to monitor the students, most frequently when there are behavioral problems. If you have a rearview mirror, monitor it frequently throughout the trip to watch the behavior patterns of the traffic behind the bus.

You should always be aware of and monitor your hand position on the steering wheel. As indicated in Unit G, your hands should be placed on opposite sides of the wheel, and the hand-over-hand method or the push-pull method should be used for turning.

Constantly monitoring the traffic in front of the bus is a necessity. Your eyes should move back and forth across the road, scanning the activity. Always be on the lookout for pedestrians, especially at intersections, near parks, houses, and parked cars. Use efficient eye scanning habits and a systematic search pattern to search for conflict situations.

There are many ways to pay attention to your surroundings while driving the bus. Use the method that is most comfortable to you and allows you to be more aware of everything around you. For example, when stopped at a bus stop and loading passengers, you should concentrate on the students outside the bus. Most of your time should be spent focusing on the cross view mirrors and directly at the students through the front and side windows, while monitoring other traffic through the side mirrors. When the bus is in motion, your attention is focused less on the cross view mirrors, and more on the road in front of the bus. Your view must alternate between the front window of the bus, the side mirrors, the rearview mirror (if present), the interior of the bus, and the dashboard. While looking at each of these in a systematic order, it is important you always remember to check everything.

More attention is needed on areas more critical for student's safety. It may be helpful to follow the guidelines presented in the following table for how often you should check things.

<b>TABLE F-2. Attention and Monitoring Guidelines</b>		
<b>How Often?</b>	<b>While Driving</b>	<b>At a Bus Stop</b>
Constantly	Other traffic; road in front of the bus.	Side mirrors; crossover mirrors; road in front and to the side of the bus; students loading the bus.
Frequently	Side mirrors; rearview mirrors; interior of the bus; area near road for pedestrians.	Interior of the bus; surrounding area.
Occasionally	Speedometer; controls on dashboard.	Control on dashboard.

Watching all of your mirrors, controls and surroundings is a lot to remember. Distractions while driving can affect your attention. The most common thing that will distract your attention is the students riding the bus. Be prepared for this, and be sure to know the guidelines for managing students discussed in Unit B. The road conditions also affect your ability to concentrate; however, drivers usually will concentrate better on days when the weather is bad. Remember, the highest rate of injury in Pennsylvania school bus crashes involved crashes where drivers were speeding and distracted, or speeding and tailgating. Pay attention and monitor your behavior.

Don't forget to pay careful attention when the weather is good, too; others will be enjoying the nice weather and may not be paying attention either. Surprisingly, Pennsylvania school bus crash data reveals head-on, backing, angle, and hit fixed object crashes are more likely to occur with no adverse weather conditions and on dry pavement than in adverse weather conditions. It appears from this that data drivers may be complacent in better weather. It is important to pay attention and be vigilant at all times.

## DRIVER FATIGUE

Illness, exhaustion or weariness from hard work or lack of sleep also can rob a driver of the extra edge of alertness necessary for greatest safety in driving. If you feel you are unable to operate the school bus safely, do not drive, and ask your supervisor for a replacement.

Statistics from the National Highway Traffic Safety Administration (NHTSA) estimate there are over 100,000 fatigue-related crashes each year in the United States. In most cases, these driving fatigue crashes occur because drivers don't recognize the dangers of drowsy driving.

According to research by NHTSA, the sleep-wake cycle determines when we get tired. In spite of individual variations, a specific amount of uninterrupted sleep is necessary for each 24-hour period, usually about eight hours, and subsequent alertness will be compromised without that amount of sleep. Additionally, sleeping less than four consolidated hours can impair performance for tasks requiring strict vigilance, like driving. When we begin to get drowsy, our reaction time slows, and it takes us longer to process information. As a result, fatigue can result in impaired performance for basic tasks needed for driving, and could ultimately lead to a driver veering off of the road or into oncoming traffic.

Note that because of the body's natural rhythms, there are two periods of maximal sleepiness in a 24-hour day—one roughly from 3 a.m.–5 a.m., and a second, less pronounced period, from 3 p.m.–5 p.m.

### Warning Signs of Driver Fatigue

The National Sleep Foundation warns there are numerous signs of driver fatigue including:

- Your eyes feel heavy;
- You blink and yawn frequently;
- You become less attentive to the road (miss your exit, don't activate your eight-ways when approaching a bus stop, etc.);
- Your head feels heavy, and you have trouble keeping your head up;
- You can't remember the last few miles driven;
- You drift from your lane or hit a rumble strip;
- You experience wandering or disconnected thoughts;
- You have difficulty focusing or keeping your eyes open;
- You tailgate or miss traffic signs; and
- You have to jerk your vehicle back into the lane.

### At-Risk Groups

Several groups are more likely to be involved in driving fatigue crashes, according to NHTSA. Men under the age of 30, shift workers and people who are chronically sleep deprived are more likely to drive drowsy and suffer driver fatigue injuries. Many school bus operators have second jobs. If fatigued from the first, it could lead to problems when operating a bus.

### Avoiding Consequences of Driving While Fatigued

There are ways to prevent driver fatigue, starting even before you get behind the wheel:

- Get a good night's sleep. While this varies from individual to individual, the average person requires about eight hours of sleep a night;
- Be alert and recognize early warning signs of fatigue;
- Avoid alcohol and medications (over-the-counter and prescribed) that may impair performance;
- Don't rely on your students, the radio or opening a window to keep you awake;
- Eat sensibly and avoid heavy meals; and
- Remember not to use any drug that hides fatigue - the only cure for fatigue is rest.

Clearly, your physical condition affects your ability to drive safely. Be sure to get plenty of sleep and only drive the school bus if you are in good physical and mental health. Finally, be as familiar with the route as possible. The better you know the roads, the more time you will be able to spend concentrating on the important things.

### CELL PHONES AND TEXTING WHILE DRIVING

Cell phones have grown enormously in popularity in the past decade, and research continues to quantify how cell phone calls and texting contribute to crashes. For example, a study conducted by the Insurance Institute for Highway Safety found motorists who use cell phones while driving are four times more likely to get into crashes serious enough to injure themselves. Along the same lines, according to the Human Factors and Ergonomics Society, drivers talking on cell phones are 18 percent slower to react to brake lights and take 17 percent longer to regain the speed they lost when they braked. A Virginia Tech study\* looked at the relative levels of distractions caused by various cell phone tasks and found the following:

<b>TABLE F-3. Relative Levels of Distraction Caused by Various Cell Phone Tasks</b>	
<b>CELL PHONE OR OTHER RELATED TASKS</b>	<b>RISK OF CRASH OR NEAR CRASH EVENT</b>
<b>Light Vehicle/Cars.</b>	
Dialing Cell Phone.	2.8 times as high as non-distracted driving.
Talking/Listening to Cell Phone.	1.3 times as high as non-distracted driving.
Reaching for an Object (i.e. electronic device, other)	1.4 times as high as non-distracted driving.
<b>Heavy Vehicles/Trucks</b>	
Dialing Cell Phone.	5.9 times as high as non-distracted driving.
Use/Reach for Electronic Device.	6.7 times as high as non-distracted driving.
Text Messaging.	23.2 times as high as non-distracted driving.

It is clear driver inattention is a leading cause of crashes, and talking on the phone and texting behind the wheel lead to distraction. In fact, anything your cell phone can do – hands free, texting, downloading music, navigation, etc., is distracting. The primary responsibility of the bus driver is to operate their bus safely. As described above, the task of driving requires full attention and focus. Using a cell phone can distract drivers from this task, risking harm to themselves and others. Available research indicates whether it is a hands-free or hand-held cell phone, the cognitive distraction is significant enough to degrade a driver's performance. This can cause a driver to miss key visual and audio cues needed to avoid a crash.

\* Information on the Virginia Tech Study can be found at:

[http://www.vtti.vt.edu/pdf/7-22-09-VTTU-Press\\_Release\\_Cell\\_Phonesand\\_Driver\\_Distraction.pdf](http://www.vtti.vt.edu/pdf/7-22-09-VTTU-Press_Release_Cell_Phonesand_Driver_Distraction.pdf)

As of March 8, 2012, it is illegal in Pennsylvania to use a wireless communications device to send, read or write a text-based communication while driving and while the vehicle is in motion. The law allows drivers to be pulled over and cited just for the texting offense and the penalty is a \$50 fine plus other costs. In addition, the use of hand-held mobile telephones for all drivers engaged in the operation of a commercial motor vehicle is prohibited in Pennsylvania except when it is necessary to communicate with law enforcement officials or other emergency services. Both the ban on texting for all drivers and the ban on cell phone use for commercial vehicle drivers were enacted by the Federal Motor Carrier Safety Administration in 49 CFR 392.80 and 392.82 and have been adopted in their entirety in Pennsylvania through 67 Pa.Code 231.

In summary, at times when the distractions are the greatest, you will need to find ways to maintain your concentration. Listed below are a few suggestions that may help. Your own methods for keeping your mind on safe driving or methods you learn from other drivers may work just as well.

- Observe traffic defensively — always be on the lookout for what the other driver might do;
- Visualize the route and what you are going to do;
- Make a concentrated effort to keep extra space between you and the vehicle ahead of you;
- Have a systematic pattern of mirror checks you always follow;
- Keep watch to maintain a safety circle around the bus;
- Remind yourself of the responsibility you have transporting students;
- Drive mindfully, not mindlessly — keep tuned in to the bus, all the sounds it makes and how it feels;
- Count the students as they get off the bus, and watch where they all go. Make sure the same number reach safe zones before proceeding; and
- Do not talk/text on your cell phone while driving.

## **VEHICLE CONDITIONS**

You must be aware of vehicle conditions before driving and constantly monitor your vehicle as you drive. This is discussed in detail in Unit E. Identifying a problem with your vehicle quickly can prevent a failure, which can result in a crash.

### **PRE-TRIP CONDITIONS**

The purpose of a pre-trip inspection is to identify problems that could cause a crash or breakdown. Each school district or contractor may have unique methods or procedures for completing and documenting a pre-trip inspection, so work with your supervisor to review system-specific policies and/or checklists. The key for you, the operator, is to complete your pre-trip inspection the same way each time to identify potential problems. Be sure you can adequately answer the following questions:

- Is the school bus you are assigned to drive in safe operating condition?
- Will it respond instantly and effectively to all controls?
- Have you checked it over?
- Did you report deficiencies to your supervisor and have they been corrected?

You are the driver and are responsible for the vehicle you are driving. Refuse to drive an unsafe bus. Remember, if these reported deficiencies are not corrected, you can report them to the area supervisor, school principal, school superintendent, state board of education, or state police.

You have to use and take advantage of all vehicle components. It is your responsibility to see they are complete, operational and safe. Correct deficiencies before your route, or if you are suspicious of a potential mechanical problem, report it, and have it checked.

## ON-THE-ROAD CONDITIONS

Mechanical problems that will create potentially hazardous conditions may develop during your route. Safe drivers use all their senses to constantly check the mechanical operation of the bus.

- Sight – Constantly check all gauges for proper readings, check lights, and watch for smoke or fire.
- Smell – Constantly check for telltale odors of smoke, exhaust fumes, gasoline, oil, and burning rubber.
- Sound – Listen for unusual noises, such as engine knocking or clashing gears.
- Touch – Often you will feel the first sign of trouble. Be alert for loss of steering, brakes, transmission, power, or other vehicular functions.

If you identify a mechanical problem during your route, be prepared to act. If you are at all uncertain whether the problem constitutes a safety hazard, stop the bus, call your supervisor and follow school district guidelines or procedures.

## ENVIRONMENTAL AND ROADWAY CONDITIONS

During the course of a school year, you will face a variety of environmental and roadway conditions demanding alert and skillful action. These conditions may include rain, ice, snow, mud, fog, flood waters, bright sun, and high winds, as well as potholes, edge drop-offs, missing or malfunctioning traffic control devices, and roadside hazards. While these conditions rarely cause crashes by themselves, they can make driving more hazardous than normal, especially when combined with human and/or vehicle factors.

Most likely, you will be driving over the same route twice a day during the school year. You'll become thoroughly acquainted with the route and, after a short time, may begin to take the road for granted. But conditions change rapidly: potholes develop during the spring thaw; grades can wash away; shoulders can become soft; railroad crossing approaches appear different depending on the time of day; loose gravel can accumulate; and slick spots can develop through accumulations of snow and ice, or oil deposits. Conditions are different each day, and you must be alert to detect these changes so as not to be caught unaware. Road conditions do not generally cause crashes by themselves. However, crashes related to road conditions often occur because drivers fail to adjust their driving behavior to road conditions. Your responsibility is to be ready for changing conditions, anticipate problems and adjust your driving behavior to match conditions.

## SCANNING AHEAD

To be a safe driver you need to know what's going on all around your vehicle.

All drivers must scan ahead and search for potential conflicts or hazardous conditions. Use a systematic search pattern and efficient eye scanning habits to identify conflict situations. To properly scan ahead:

- Have a clean windshield and properly adjusted mirrors;
- Develop the habit of scanning 360 degrees around the bus – front, sides and rear;
- Don't stare too long at a particular object, as you will be less aware of clues from your larger field of indirect vision; and
- Focus farther ahead as your speed increases, and slow down if your view becomes limited by hills or curves.

### **Importance of Scanning Ahead**

Because stopping or changing lanes can take a lot of distance, knowing your vehicle and what traffic is doing on all sides of you is very important. You need to look far enough ahead to make sure you have room to maneuver your bus safely.

### **Know How Far to Scan**

You should look 12 to 15 seconds ahead. That means looking ahead the distance you will travel in 12 to 15 seconds. At lower speeds, that's about one block; at highway speeds, it's about a quarter of a mile. If you're not looking that far ahead, you may have to stop too quickly or make quick lane changes. Looking 12 to 15 seconds ahead doesn't mean ignoring conditions that are closer. You need to shift your attention back and forth, near and far.

### **Look for Traffic**

Look for vehicles coming onto the highway, coming into your lane or turning. Watch for brake lights from slowing vehicles. By identifying these conditions far enough ahead, you can change your speed or change lanes, if necessary, to avoid a problem.

### **Check Mirrors**

When using your mirrors while driving on the road, check quickly. This means about 3 to 5 seconds of scanning time. Look back and forth between the mirrors and the road ahead. Check your mirrors every 5 to 8 seconds. Don't focus on the mirrors for too long. Otherwise, you will travel quite a distance without knowing what's happening ahead. Refer to Unit E for more information on mirror positioning and usage.

The use of your mirrors will greatly extend the view outside and around the bus. For example, the side mirrors allow you to see the traffic approaching from behind your bus and those passing you, in addition to the surroundings at loading and unloading zones. The crossover mirrors also allow a further view in front of the bus, most often at a loading or unloading zone. Carefully checking and rechecking these mirrors for students that may be in front of the bus during loading or unloading is essential.

You must be alert to all hazards. The key to your defense is timely recognition and avoidance. Always try to leave yourself an escape route.

## **DRIVING ON SLIPPERY SURFACES**

A roadway condition drivers often encounter is a slippery road surface. This may be the result of rain, snow, ice or even wet leaves, or standing water on the roadway. Expert drivers can safely control a vehicle on slippery surfaces. Also, by following proper procedures before, during and after your trips, you can help keep your vehicle in the best condition to operate as safely as possible on slippery surfaces, and maintain control while driving.

### **Before Your Trip**

- Start on time, but adjust driving to conditions; safety first...schedule second; and
- Ensure chains are secure for snow and icy conditions, if applicable.

**While on the Road:**

- Use windshield wipers at all times in rain, snow, sleet, and heavy fog;
- Use of headlights is mandatory;
- Check brakes immediately after driving through deep puddles or standing water. If they fail to work properly, pump the brakes to help dry them while the vehicle is moving. For air brakes, cautiously apply steady pressure;
- Set a regular speed, and drive slower than posted speed limit or what you would normally drive in dry road conditions, especially on bridges and in tunnels;
- Start the bus in the lowest appropriate gear for better traction, if ice or wet snow is on the driving surface. Loss of traction due to spinning the wheels during starting may cause the drive wheels to become stuck even more firmly. If on a crowned road or hillside, the bus may start to slide or fishtail off of the road under these conditions;
- To avoid getting stuck or spinning the wheels, try to keep the bus moving slowly and steadily forward in gear. If the wheels start to spin, let up slightly on the accelerator to allow them to take hold. If the bus stops, do not continue to spin the wheels in the hope of pulling out. In mud and soft sand, this will only dig the wheels in deeper;
- When approaching intersections and when stopping, pump the brakes once or twice so the wheels won't lock on the ice. With air brakes, use gentle, but steady pressure. Make turns smoothly and avoid applying the brake;
- Avoid skidding;
- Plan ahead for expected hazardous areas of the route. These include: icy bridges, stretches of road that have been slippery in the past, uphill stops, and intersections;
- For buses with manual transmissions, do not disengage the clutch until the bus is almost completely stopped;
- Maintain a greater than normal safe following distance from other vehicles; and
- When pulling onto the highway, allow for longer acceleration time required for school buses.

Estimate depth and extent of standing water partially or totally covering the roadway. When driving on snow- or ice-covered highways, judge the effect of traffic and temperature on road surface friction by noting whether other vehicles are skidding. Remember, bridges freeze before the road surface. If ice is melting on the highway, be alert for ice patches near underpasses, tree-lined areas, buildings or other shaded areas. Note spots where direct sunlight may have accelerated melting, and look for additional ice patches ahead on the highway.

You must drive slower to be able to stop in the same distance as on a dry road. Wet roads can double the stopping distance of your bus. Reduce speed by about one third (e.g., slow from 55 mph to about 35 mph) on a wet road. On packed snow, reduce speed by one half or more. If the surface is icy and impassable, stop driving as soon as you can safely do so and call for assistance.

**Black Ice** – Black ice is a thin layer clear enough you can see the road underneath it. It makes the road look wet instead of icy. Any time the temperature is below freezing and the road looks wet, watch out for black ice.



**Hydroplaning** – In some weather, water or slush collects on the road. When this happens, your vehicle can hydroplane. Hydroplaning occurs when a layer of water builds between the rubber tires of your bus and the road surface, leading to the loss of traction, and thus preventing the vehicle from responding to steering, braking or accelerating. It becomes, in effect, an unpowered and unsteerable sled. It does not take a lot of water to cause hydroplaning. Hydroplaning can occur at speeds as low as 30 mph, if there is a lot of water. Hydroplaning is more likely, if tire pressure is low or the tread is worn. (The grooves in a tire carry away the water; if they aren't deep, they don't work well.) Be especially careful when driving through puddles. The water is often deep enough to cause hydroplaning.

Remember to inspect your tires as outlined in Unit E for a tread depth of  $4/32$ " on the front tires and  $2/32$ " on the rear tires as per Section 171.36 of Title 67, and avoid standing water.

**After Your Trip:**

- Sweep water or snow from the bus, including the steps;
- Clear mud or snow from windows, mirrors, lights, roof, and reflectors; and
- Don't forget to complete your post-trip inspection procedures.

## **REDUCED VISIBILITY**

### **Weather Conditions**

When you think of bad weather you probably think of slippery road conditions, but rain, snow, fog, and smog also reduce visibility. Adjust your driving accordingly, and take the following precautions:

- Follow local pre-trip inspection guidelines;
- Keep the windshield clear. If snow or ice builds up on front or rear windows, stop the bus and remove it; and
- Don't hesitate to leave the roadway at a safe spot to sit out a heavy shower, snow squall or thick fog. However, always remember to keep in contact with your supervisor.

### **Bright, Glaring Sunlight**

While bright sun or glare may not be considered bad weather, they can create serious hazards for motorists. Don't be caught unprepared. Take the following special precautions for safe driving in bright sun:

- Carry sunglasses and use them when necessary;
- Adjust visors to block out direct sun;
- Avoid looking directly at the sun, bright reflections, or glare since they can affect your vision for several seconds; and
- Clean the windshield inside/outside.

### **Night Driving**

When examining national crash data for ALL vehicles, about half of traffic fatalities occur at night, although only about one quarter of travel occurs after dark. Although intoxication and fatigue contribute to the high rate of nighttime crashes, nighttime driving is inherently hazardous because of decreased driver visibility.

In Pennsylvania, approximately 6 percent of crashes involving a school bus occurred at night. While most of your trips as a school bus operator occur during daylight hours, there may be several times when you will be driving during hours of darkness. These may be during field trips or special events, or just early morning routes

during the winter. As nighttime hours increase, so does your exposure to the perils of night driving. Unlike the temporary hazards associated with snow and ice, the dangers of night driving exist all winter and, to a lesser extent, all year.

Why is night driving particularly challenging? The challenges are greater than during the day because many of the visual cues necessary for safe driving, such as warning signs and pavement markings, are harder to see. In addition, even drivers with the best visual acuity have reduced visual efficiency at night. Namely, your peripheral vision is sharply reduced, your depth of field is reduced and the low light makes it more difficult to focus on objects. Further, artificial light can't compare in efficiency to natural light, and the narrow beams of light from headlights give you an automatic case of tunnel vision. Daytime visual cues, such as colors, are nearly worthless at night.

At night, take the following driving precautions:

- **SLOW DOWN.** Just because the speed limit is 40 mph, it doesn't mean you have to drive that fast. Remember, the speed limit is an indication of the maximum safe speed during optimal driving conditions.
- Change other driving techniques. For example, don't overdrive your headlights. If you are driving at 55 mph, it will take you up to 300 feet to stop, while the average headlights will illuminate only 250 feet ahead.
- Increase your following distance behind the vehicle in front of you because distance perception is more difficult to judge at night.
- Exercise caution. It takes time for the average eye to adjust to night vision. Drive with special caution during this critical adjustment period. Avoid highway hypnosis caused by prolonged and forced staring.
- Don't look directly at oncoming lights. Visibility is affected considerably by oncoming headlights at distances of 3,000 feet or more. Staring at oncoming headlights will also distort your vision for up to seven seconds. That translates to a distortion lasting a distance of 565 feet when traveling at 55 mph.
- Don't look off into the darkness, because your eyes will have trouble adjusting to the road lights again. You may be able to learn to steer by the side light cast by cars ahead of you.
- Use pavement markings and delineators as guidance devices. Often, they form a corridor of reflected light in which a stalled car or pedestrian will show up as a blank spot.
- Your eyes need to adjust to night lighting and driving in dark conditions. If you are exposed to bright sunlight during the day, it will take your eyes longer to adjust, and it can impair your night vision considerably. Therefore, wear your sunglasses, if exposed to bright sunlight during the day.

## EQUIPMENT ADJUSTMENTS

- Keep headlights clean and make sure your windshield is clean inside and outside. Any reduction in the amount of light available to your eyes reduces your night vision.
- Always use low beams on sharp curves and when traffic is approaching. Your bright lights can blot out the warning glow of cars coming around the curve toward you. Also, keep headlights on low beam in cities or towns, and in fog or haze.
- Keep your instrument panel lights dim. If too bright, they produce unnecessary glare and distraction.
- If oncoming drivers fail to dim their lights, don't blind them with your high beams. This creates a hazard to yourself and your passengers.
- Don't tailgate.

- If it is necessary to stop the bus on the shoulder of an open highway, choose a spot visible for at least 500 feet to oncoming and following traffic (see Figure F-5). Turn off the headlights, but leave parking lights and/or hazard warning lights on.

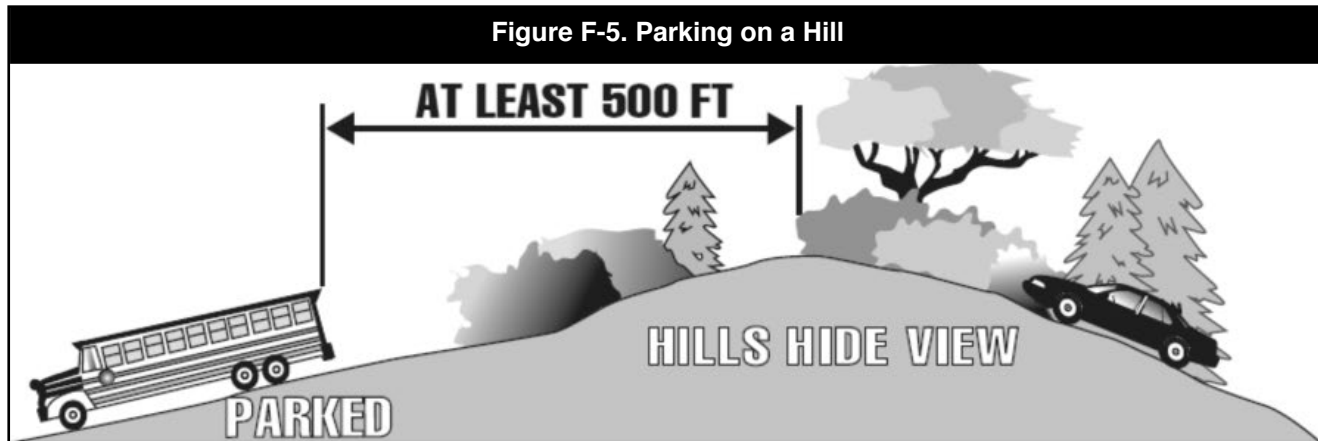

## HEAVY WIND

While loss of traction and limited visibility are the most common roadway and weather-related problems you will face, you should also be aware of and ready for potential hazards caused by heavy wind. Because of the height of a vehicle, the side of the bus acts like a sail, and a strong crosswind at the top of a hill or at the end of a tunnel, or even gusting winds on an open straight section of highway, can cause an unprepared driver to lose control of the bus. Passing large vehicles also may expose you to a sudden burst of a crosswind. Large vehicles can cause drafts; be careful when driving near them on the open highway.

## HIGHWAY HAZARDS

The shape, surface and roadside conditions of the highways you drive on each day can cause potential hazards. Whether you drive on major highways, country roads, city streets, or some combination of these, you must be prepared for potential hazards arising from these conditions.

You should be able to identify potential hazards arising out of the interaction between vehicles and highway. Any point in the highway where drivers are confronted with decisions represents a potential point of conflict. For example, a vehicle starting to exit from a freeway may suddenly return to the freeway, or drivers unfamiliar with route signs may be in the wrong lane and change lanes suddenly as two major routes split. A point where the highway becomes narrower also represents a potential source of conflict. At points where four lanes become two, other vehicles may change lanes suddenly.

### Road Geometry

The geometry of a highway describes features that affect or relate to its operational quality and safety. These features, which are visible to the driver and affect driving performance, include: roadway curvature; intersections and interchanges; number of lanes and lane width, presence of shoulders and curbs; channelization and medians; and other miscellaneous elements like driveways and bridges.

As a driver, pay attention to the shape of the road and the potential for unseen hazards around curves, over hills or in dips. By scanning the road ahead, and watching and heeding road signs and pavement markings, good drivers can detect and plan ahead, for such roadway geometric changes by slowing down to get a better view. When entering a curve or down shifting for a long downgrade, increase your following distance and travel at a reduced speed. Reduce speed and keep to the right when approaching the crest of hills and at highway dips.

## **Intersections and Right of Way**

School buses often come into conflict with other vehicles and pedestrians because their intended courses of travel intersect, and thus interfere with each other's routes. This occurs at points where roads and streets join, meet or cross — intersections.

Pennsylvania school bus crash data indicate over 60 percent of crashes, school bus the prime unit, occurred at intersections. One factor that might explain this is navigating through an intersection requires careful driving technique and experience, especially in a larger vehicle like a school bus. Another fact is simply there are many conflict points at an intersection, so your exposure is much higher.

Intersections can be different sizes and shapes depending on the angle(s) by which the roadways meet. Be prepared to stop each time you approach virtually any intersection.

The general principle establishing who has the right to go first at an intersection is called "right-of-way." This concept legally establishes who has the right to use the conflicting part of the road and who has to wait until the other does so. Right-of-way laws are designed to prevent collisions by prescribing what vehicle must move last. The law only names the vehicle that must yield right of way; it never states any vehicle expressly has the right to proceed.

In terms of right-of-way, there are basically two types of intersections: regulated and unregulated. Regulated intersections have traffic control devices, such as a signal or sign. Unregulated intersections have no traffic signals or signs. Use caution, even if a signal or a stop sign controls other traffic. Remember the clearance your bus needs, and watch for poles and tree limbs. Know the size of the gap your bus needs to accelerate and merge with traffic. When pulling out, never assume other drivers will brake to give you room.

### **Unregulated Intersection**

When approaching an unregulated intersection, you are required by law to reduce speed, check traffic to see you can proceed and continue to move only when others have yielded right of way to you. If another vehicle is already in or very near the intersection, you must yield right of way to that vehicle. When two vehicles arrive at an unregulated intersection at the same time, the vehicle on the left always yields right of way to the vehicle on the right.

### **Regulated Intersection: Yield Control**

Because of the restricted visibility, slow acceleration and length of a school bus, you must use extreme caution as you approach a yield sign. Approach the intersection where you must yield at a speed reasonable for the existing conditions, but slow enough to allow you to stop the bus and yield right of way to another vehicle in the intersection or to avoid a collision.

### **Regulated Intersection: Stop Control**

Drivers' responsibilities at stop-controlled intersections are stated in Section 3323(b) of Title 75, The Pennsylvania Vehicle Code. This section states "Duties at stop signs -- Except when directed to proceed by a police officer or appropriately attired persons authorized to direct, control or regulate traffic, every driver of a vehicle approaching a stop sign shall stop at a clearly marked stop line or, if no stop line is present, before entering a crosswalk on the near side of the intersection or, if no crosswalk is present, then at the point nearest the intersecting roadway where the driver has a view of approaching traffic on the intersecting roadway before entering. If, after stopping at a crosswalk or clearly marked stop line, a driver does not have a clear view of approaching traffic, the driver shall, after yielding the right-of-way to any pedestrian in the crosswalk, slowly pull forward from the stopped position to a point where the driver has a clear view of approaching traffic. The driver shall yield the right-of-way to any vehicle in the intersection or approaching on another roadway so closely as to constitute a hazard during the time when the driver is moving across or within the intersection or junction of roadways, and enter the intersection when it is safe to do so."

Simply put, you must completely stop at every intersection where there is a stop sign for your lane of traffic. Stop at the stop line or four feet in advance of the crosswalk. If neither are there, stop at the point nearest the intersecting roadway where the driver has a view of approaching traffic on the intersecting roadway before entering the intersection. Enter only when you have the best line of sight and can move the bus without interfering with the movement of another vehicle. Before proceeding you should look in all directions at least twice to check for approaching traffic. If the intersection is clear, proceed to move ahead or turn with caution.

### Regulated Intersection: Traffic Signals

Approach each traffic signal expecting it could change color at any moment. Always obey the color of the traffic signal:

- **Red light** – Stop completely at the stop line and wait for the green light before proceeding. Consult your district guidelines and procedures regarding making the “right on red”. This is a legal maneuver in Pennsylvania, but it might not be the safest to make in a school bus.
- **Yellow light** – Prepare to stop for the red light that will follow.
- **Green light** – Check to be sure approaching traffic is stopped and proceed with caution.
- **Flashing yellow light** – Slowly proceed with caution.
- **Flashing red light** – Stop completely, check for approaching traffic and proceed with caution when it’s safe to move (same as stop sign).

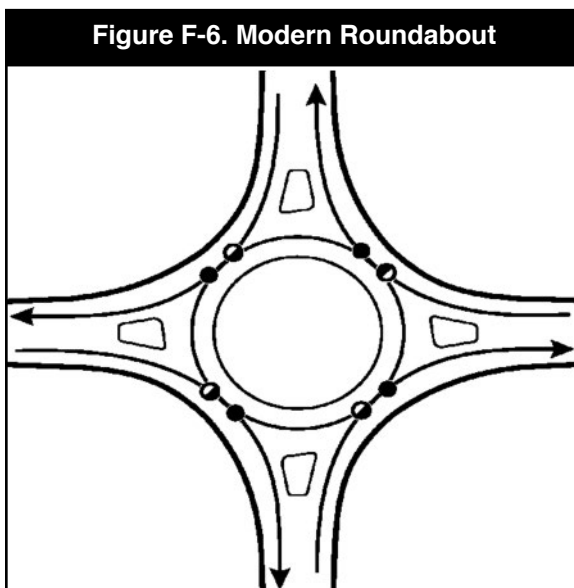

### Circular Intersections

Circular intersections, such as the modern roundabout, are becoming more common on Pennsylvania highways.

Here are a few tips for travelling through circular intersections:

1. Slow down as you approach the intersection.
2. Keep to the right of the painted or raised island separating entering traffic from exiting traffic. There may be a truck apron on which you may operate your bus.
3. Look left for traffic approaching in the circle.
4. Enter the roundabout (circle) by turning right when there is a safe gap in traffic approaching from your left. Yield to traffic already in the roundabout. If there is no traffic approaching, you may enter without stopping.
5. Do not pass bicyclists or other vehicles when in the roundabout.
6. When in the roundabout, do not stop (except to avoid a crash) – you have the right-of-way over entering traffic.
7. Use your right turn signal to indicate where you plan to exit the roundabout. Turn it on after you have passed the exit just before the one you plan to use.
8. If you miss your exit, just continue around the circle until you reach it again.
9. As you exit, yield to pedestrians who are in the crosswalk or are waiting to cross the exit lane.

**Uniformed Police Officer**

A uniformed traffic officer always has authority above regular traffic signs and signals. You must follow the officer's instructions regardless of the regular traffic devices. When an officer is directing traffic, there is usually a specific problem or hazard. There could be a crash ahead, malfunctioning traffic signal or missing sign. Always obey the officer's instructions, even if the regular traffic devices appear to be functioning properly.

**Private Drive**

When leaving a driveway, you must always yield right of way to the approaching vehicles on the roadway where you are entering. Check for approaching traffic and proceed with caution when it's safe to move (same as stop sign). Whenever possible, never back out of a driveway onto a highway.

**Crossing Main Highways**

Use extreme caution while crossing or entering a major highway. When moving from a complete stop, a school bus normally requires at least six seconds to cross and clear an average two-lane highway. Multi-lane highways, especially divided highways, require even more time. An automobile traveling at 55 mph can move 485 feet in six seconds. Before you move the bus onto a highway be certain you have enough time to safely clear the intersection. Always **check and recheck for approaching traffic**, before entering or crossing any road. Look first to the left, where the hazard of approaching traffic is closer. **The slogan for the school bus driver must be: "The school bus driver never has right of way."**

While driving the bus you must never take a risk. You should be a courteous driver, and remember the law requires you and all drivers to yield right of way to pedestrians and vehicles on narrow bridges, on the roadway, at intersections, and in any hazardous situation.

**Road Surface**

Another type of potential highway hazard is the road surface. Always scan ahead for changes in surface conditions that may require evasive maneuvering to avoid the loss of steering or braking control. The three most common problems are loose, rough and slippery surfaces.

- **Loose Surfaces** – Slow down for loose surfaces such as gravel, soft sand, soft shoulders, and wet leaves.
- **Rough Surfaces** – Detect surface irregularities on asphalt and concrete, such as potholes or cracked pavement. On a wooden surface, look for holes, bumps, cracks, loose boards, and slippery spots. Approach metal bridges slowly, as they tend to reduce steering control.
- **Slippery Surfaces** – Slippery surfaces were discussed earlier. Anticipate the smoothness of concrete or asphalt road surfaces at intersections, or other steering or stopping areas. Recognize areas of the highway soaked with oil or grease. Remember, the early part of a rainfall is the most dangerous.

**Roadside Conditions**

Another type of potential highway hazard is caused by conditions on the side of the road. Physical features of the roadside include: barriers (e.g., guiderail); obstacles (e.g., noise barriers, trees, utility poles, signs), and other miscellaneous features (embankment slopes, ditches, etc.). Under normal driving circumstances, these should pose no problem. They should, however, be included in your scanning as you drive and they should be evaluated for potential hazards, if you leave the highway suddenly.

## PEDESTRIAN HAZARDS

**Figure F-7. Rural Pedestrian Hazards**

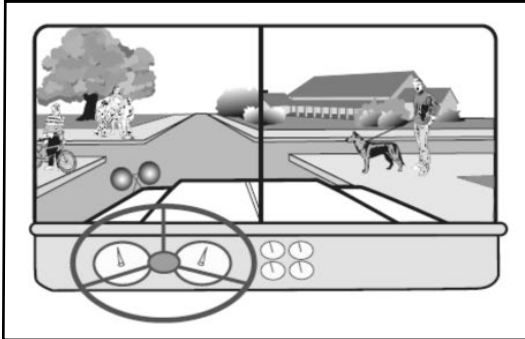

The presence of pedestrians, bicyclists, roller skaters, skateboarders, and animals on or near the highway increases the need for vigilant scanning. School bus stops are particularly dangerous areas as outlined in Unit C - approach them cautiously and alertly. When near playgrounds, residential areas and schools, be alert for children playing or darting into the path of your bus from behind vehicles, structures, or trees and bushes.

When driving on side streets, be alert for pedestrians entering or crossing your path from any direction. When making left and especially right turns at intersections, check carefully for pedestrians crossing the street into the path of the bus and for vehicles making right turns on red lights.

**Figure F-8. Urban Pedestrian Hazards**

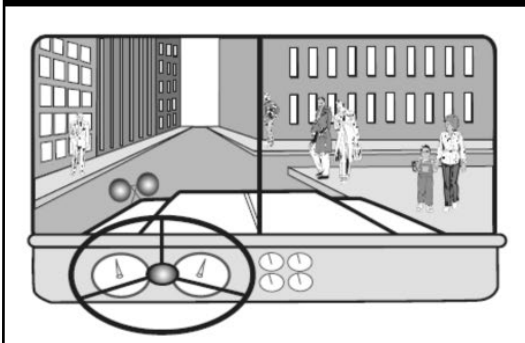

Be alert for animals that may cross into the path of the bus. Animals are much like children in their unpredictable behavior along roads. Wherever possible, slow down to avoid hitting animals; do not swerve to avoid them unless they are working horses pulling a buggy. Such action may cause partial or complete loss of control of the bus. (See Figures F-7 and F-8)

## VEHICLE HAZARDS

In general, when sharing the road with other vehicles, observe the driving behaviors of the other drivers. Scan 360 degrees around your bus for clues to any potentially hazardous conditions.

### Drivers in a Hurry

Drivers may feel your school bus is preventing them from getting where they want to go on time. Such drivers may pass you without a safe gap in the oncoming traffic, cutting too close in front of you. Other drivers entering the road may pull in front of you in order to avoid being stuck behind you, causing you to brake quickly. Be aware of these situations, and pay particular attention to drivers who are in a hurry.

### Losing Control

Recognize clues indicating another driver may lose control of their vehicle. Surface conditions that are slippery, or have loose gravel, ruts, or deep snow might reduce the oncoming driver's control (as well as your own).

Notice movements of the other vehicles. For example, you notice if an oncoming driver turns too sharply after an off-road recovery, or a driver approaching too fast from the side to stop or turn. Movements of your bus or another vehicle also may affect other drivers (such as stopping too quickly to allow a following vehicle enough time to stop).

**Lack of Communication by Other Drivers**

Look for clues to situations where the driver of another vehicle may execute a maneuver without signaling:

- A vehicle slowing down may be about to turn;
- A parked car with a driver in the driver's seat, engine running, or turned wheels may be about to pull out from the curb;
- A parked car with a driver in the driver's seat may be getting ready to exit his vehicle; and
- Pickup and delivery vehicles with backup lights on may be about to back into another street or driveway.

When another driver does signal, check other clues to verify it is the proper signal because a turn signal may have been left on from a previous maneuver. This is especially true of motorcycles.

Remember you, too, can fail to communicate. Always signal your intentions.

**Failure of the Other Driver to Observe**

Watch for clues another driver has not observed the bus and therefore may not be prepared to yield the right-of-way. These clues include the following:

- Other driver not responding to an upcoming intersection or to your signals;
- Other driver not looking at the road or what is in front of him/her (distracted by something in their own vehicle);
- Dirty windows, posts, trees, buildings, bright sunlight, or other objects obscuring or restricting the other driver's view; and
- Other driver's vehicle being detectable to you only by reflection, headlight glow or dust cloud.

**Inadequate Adjustment by the Other Driver**

Look for indications another driver is not adjusting properly to a situation. Be aware of hazardous situations arising when another driver fails to adjust for the following:

- Obstructions;
- Surface conditions;
- Pedestrians;
- Other vehicles; and
- Shape of the road.

Failure to adjust for these conditions may cause another driver to make potentially hazardous maneuvers. Know areas of your route where these situations are likely to occur, and exercise caution in these places.



**Aggressive Driving by Other Motorists**

NEVER take it personally when someone cuts you off or pulls in front of you. People don't want to be caught behind the school bus, so expect people to pull in front of you. Just let it go, and ignore it. If you encounter an aggressive driver, here are a few tips:

- Get out of their way and do not challenge them;
- Stay relaxed, avoid eye contact and ignore rude gestures;
- Don't block the passing lane, if you are driving slower than most of the traffic;
- Put your pride in the back seat and DO NOT RETALIATE. Do not challenge them by speeding up or attempting to hold-your-own in your travel lane. It is a serious distraction to focus your attention on a "contest" with another driver. You are less able to respond to traffic signals, signs and the actions of other vehicles or pedestrians as needed to avoid a crash;
- Do not try to teach another driver a lesson and do not insist on being right, even if you are right;
- Wear your seat belt as required by Section 171.144 of Title 67 and federal law in 49 CFR Section 392.16 (Use of Seat Belts). It will hold you in your seat and behind the wheel in case you need to make an abrupt driving maneuver, and it will protect you in a crash;
- Report aggressive drivers to the appropriate authorities by providing a vehicle description, license number, location and, if possible, driver and direction of travel;
- If you have a cell phone, and can do it safely, pull to the side of the road and call the police and/or your supervisor – many have special numbers (e.g. 911); and
- Do NOT discharge any students, if an aggressive driver pursues you. Call for help.

While many people associate aggressive driving with road rage, they are two different behaviors. Road rage, which is a criminal offense, is often the result of aggressive driving behavior that escalates into an assault with a vehicle or other dangerous weapons.

**Slow-moving or Stopped Vehicles**

Watch for indications another vehicle is slowing or may stop suddenly. Examples of slow-moving vehicles are farm vehicles, under-powered vehicles, horse-drawn vehicles, and trucks on hills. Frequently stopping vehicles include: buses, trucks carrying flammables at railroad crossings, garbage trucks, and postal and other delivery vehicles. Also watch for vehicles engaged in turning, exiting or entering the roadway, merging with other vehicles, or approaching controlled intersections or railroad crossings.

Amish buggies are dark in color and difficult to see in poor light and bad weather. After stopping, a horse and buggy often roll backward. When you pass a horse, do not drive too fast or blow your horn, as this may spook the horse. Also, to avoid scaring the horse after passing, leave enough space between your vehicle and the horse before pulling back into the right lane.

**Multiple Vehicle Hazards**

You should be able to recognize clues in a traffic pattern that may indicate potential conflict. Vehicles entering the highway from side roads, driveways, ramps, or parking spaces may cause another driver to change lanes or stop suddenly. A vehicle slowing or stopping may prompt another driver to steer around it. One vehicle may limit another's visibility, allowing the other driver to enter a potential conflict, as when an oncoming driver turns left.

### Work Zones

Whenever people are working on the road, it is a hazard. Road construction may cause narrower lanes, sharp turns or uneven surfaces. Other drivers are often distracted and drive unsafely. Workers and construction vehicles may get in the way. Drive slowly and carefully near work zones. Use your four-way flashers or brake lights to warn drivers behind you.

There should be traffic control devices to help you navigate through work zones. These devices are typically repetitive in nature, especially signing practices. For example, in a typical road work sign series, the first sign, ROAD WORK AHEAD, is a general warning to motorists. The second sign, ONE LANE ROAD AHEAD, alerts drivers what exactly they should expect. The third sign, FLAGGER AHEAD, tells what they need to do.

### Motorcycles

One vehicle you should pay particular attention to is the motorcycle. They are smaller and more narrow than a car, can be hard to see, and can hide in a blind spot. Keep these simple rules in mind:

1. Look for motorcycles...then look again. Look twice at intersections, especially when turning left;
2. Respect motorcyclists' rights. Motorcycles have all the privileges of any vehicle on the road. Give motorcycles a full lane, and treat them with courtesy and respect;
3. Anticipate a motorcyclist's maneuvers. Motorcyclists may change lane positions in response to road conditions, weather or other factors. Anticipate evasive actions. Small objects in a road you may not need to avoid in a bus may require evasive action by a motorcycle;
4. Allow plenty of following distance. Allow an extra second of following distance and room to respond to conditions on the road. Slow down in poor driving conditions; and
5. Check your blind spot. Make a visual check for motorcycles in your mirrors and check your blind spot before changing lanes.

## CONTROLLING SPEED

Driving too fast is a significant cause of crashes. Pennsylvania school bus crash data indicates speeding and tailgating are listed as factors in 18 percent of crashes involving school buses as the prime vehicle. In addition, the highest fatality rates for school bus incidents were associated with crashes involving the combination of speeding and other improper driving action, and driving on the wrong side of the road (often associated with speeding). Not surprisingly, the highest rate of injury in school bus crashes involved crashes where drivers were speeding and distracted, and speeding and tailgating. The common theme here is speeding.

You must adjust your speed depending on driving conditions. These include: traction, curves, visibility, traffic, weather conditions and hills. Data shows school bus drivers in crashes were more likely to have speeding indicated as a factor during adverse weather conditions than if there were no adverse conditions. You must make adjustments when you drive – different conditions require different techniques. Similarly, bus drivers in rear-end crashes are significantly more likely to be noted as tailgating. Rear end collisions involving a bus tend to be associated with a high number of injuries per crash.

You must drive safely when operating your bus and that means not driving too fast for conditions.

## FOLLOWING DISTANCES

Knowing the stopping distances required for different road conditions and speeds will help you determine safe following distances when driving. You must keep adequate distance between you and the vehicle in front of you. A good general rule for determining a safe following distance on the highway is to allow an absolute minimum of four seconds between the bus and the vehicle ahead under normal conditions. For each additional adverse condition, add another second. So, add a second if:

- You are traveling over 40 mph;
- You are driving on a wet or loose surface or other poor roadway condition;
- You are following motorcycles or large vehicles;
- You are following another school bus;
- You are driving at night;
- You are driving in adverse weather conditions; and
- You are being tailgated.

To adequately judge this, select a fixed object on the road or roadside ahead. When the vehicle ahead of you passes that mark, start counting until you reach that same spot. If you reach the same spot before your count is complete, you are following too closely.

Also keep in mind that in a large vehicle, it's often hard to see whether a vehicle is close behind you. You may be tailgated:

- **When you are traveling slowly** – Drivers trapped behind slow vehicles often follow closely, and
- **In bad weather** – Many car drivers follow large vehicles closely during bad weather, especially when it is hard to see the road ahead.

If you find yourself being tailgated, here are some things you can do to reduce the chances of a crash:

- **Avoid quick changes** – If you have to slow down or turn, signal early and reduce speed very gradually;
- **Increase your following distance** – Opening up room in front of you will help you avoid having to make sudden speed or direction changes that could surprise the driver behind you. Leaving room ahead also makes it easier for the tailgater to get around you;
- **Don't speed up** – It's safer to be tailgated at a low speed than a high speed; and
- **Avoid tricks** – Don't turn on your tail lights or flash your brake lights. Follow the suggestions above.

# STOPPING

Stopping a school bus smoothly and within the limits of safety is the sign of an expert driver. Good drivers have their vehicles under control at all times and know braking distances increase greatly as speed and vehicle weight increase. In addition to knowing the distance required to safely stop their bus under all driving conditions, skillful drivers use correct stopping procedures, which increase bus life and lower maintenance costs.

## STOPPING DISTANCE

Three components comprise total stopping distance:

- Perception Distance;
- Reaction Distance; and
- Braking Distance.

It is important to note that for buses equipped with air brakes, there is additional brake lag distance to account for. This makes the formula:

$$\begin{array}{r}
 \text{Perception Distance} \\
 \text{Reaction Distance} \\
 \text{Braking Distance} \\
 + \text{ Brake Lag Distance} \\
 \hline
 \text{Total Stopping Distance}
 \end{array}$$

Briefly, these components are:

- **Perception Distance** – The distance your vehicle travels from the moment your eyes see a hazard until your brain recognizes it. For an alert driver, that moment occurs in about three fourths of a second. The distance traveled in that three fourths of a second varies directly with the vehicle's speed of travel. For example, a vehicle moving at 55 miles per hour travels about 60 feet in three fourths of a second. Therefore, the average perception distance for an alert driver moving at 55 mile per hour is 60 feet.
- **Reaction Distance** – The distance traveled from the time your brain decides what to do and tells your foot to move from the accelerator until your foot pushes the brake pedal. The average, alert driver has a reaction time of about three fourths of a second, which also translates to 60 feet at 55 mph.
- **Braking Distance** – The distance it takes to stop once you have pressed the brake pedal and engaged the brakes. Assuming good brakes in normal driving conditions (dry pavement, level roadway, etc.), a bus moving at 55 mph usually will require about 170 feet of braking distance (over 4 and a half seconds).
- **Brake Lag Distance** – For vehicles with air brakes, there is approximately a half second delay in brake response time from the moment when you press the brake pedal to the point when the brakes engage. At 55 mph, this translates to 32 feet.

This braking distance is higher than what you experience in a car. The reason for this is a heavy vehicle requires more braking power to stop than a lighter one because the heavier vehicle creates more friction and heat for the brakes to absorb. The brakes, tires, springs and shock absorbers for heavy vehicles are designed to work best when the vehicle is fully loaded.

Looking at the above figures, the total stopping time at 55 mph is at least six and a half seconds under the BEST conditions. More significantly, the total stopping DISTANCE is about 322 feet at 55 mph.

Perception Distance	60 feet
Reaction Distance	60 feet
Braking Distance	170 feet
<u>+ Brake Lag Distance</u>	<u>+ 32 feet</u>
Total Stopping Distance	322 feet

In other words, your bus will easily travel the length of a football field in this time. If you double your speed, it will take about four times as much distance to stop. The vehicle will also have four times the destructive power in a crash.

By slowing down, you can greatly decrease the stopping distance of a school bus, and greatly increase the safety of pupil transportation.

The bottom line is whenever you are driving, plan to keep enough space in front of you so you can stop quickly, if necessary. If brakes and/or tires are not in proper working order, the braking distance, and thus the stopping distance, will be greater. Because stopping distance increases as speed increases, you must leave more space at faster speeds. Adverse weather conditions also increase stopping distance. Stopping a vehicle on roads covered with ice or sleet requires a distance at least five times greater than required in dry conditions. When driving in bad weather, further increase your following distance to compensate for increased stopping distances.

## **SPEED AND TRAFFIC FLOW**

When you're driving in heavy traffic, the safest speed is the speed of other vehicles. Vehicles going the same direction at the same speed are less likely to run into one another. Drive at the speed of the traffic, if you can do this without going at an illegal or unsafe speed. Keep a safe following distance.

The main reason drivers exceed speed limits is to save time. But anyone trying to drive faster than the speed of traffic will not be able to save much time. The risks involved are not worth it. Going with the flow of traffic is safer and easier. If you go faster than the speed of other traffic:

- You'll have to keep passing other vehicles. This increases the chance of a crash.
- It is more tiring. Fatigue increases the chance of a crash.

**THIS PAGE INTENTIONALLY LEFT BLANK**

# UNIT G - FUNDAMENTALS OF DRIVING A SCHOOL BUS

INTRODUCTION . . . . .	G-3
PREPARING TO DRIVE . . . . .	G-3
Vehicle Types . . . . .	G-3
Types of School Buses . . . . .	G-3
Type A (Cutaway Van) . . . . .	G-3
Type B (Integrated). . . . .	G-3
Type C (Conventional) . . . . .	G-3
Type D (Transit Type). . . . .	G-4
Reference Point Driving . . . . .	G-4
KNOW YOUR ROUTE . . . . .	G-5
FIELD TRIP / ATHLETIC TRIP CONCERNS. . . . .	G-5
STARTING AND OPERATING A DIESEL VEHICLE . . . . .	G-7
Diesel-Powered Motor Vehicle Idling Act: Act 124 of 2008 . . . . .	G-7
Pedal Misapplication . . . . .	G-7
STEERING AND TURNING YOUR BUS. . . . .	G-8
Steering Techniques . . . . .	G-8
Turning Procedures. . . . .	G-8
Rounding Curves . . . . .	G-8
Making Left and Right Turns. . . . .	G-9
Left Turn Procedures . . . . .	G-9
Right Turn Procedures . . . . .	G-10
BACKING . . . . .	G-11
Keep Students on the Bus . . . . .	G-11
Back and Turn Toward the Driver’s Side. . . . .	G-11
Look at Your Path . . . . .	G-11
Back Slowly and Smoothly . . . . .	G-11
Use a Helper Whenever Possible . . . . .	G-12
If No Helper Is Available . . . . .	G-12
MAKING A TURN-AROUND . . . . .	G-12
STOPPING . . . . .	G-13
Anti-lock Braking Systems . . . . .	G-13
How ABS Helps You . . . . .	G-13
Braking with ABS . . . . .	G-13
Braking if ABS is Not Working . . . . .	G-14
Safety Reminders. . . . .	G-14
General Stopping Technique. . . . .	G-14
Stopping Procedures for Standard Transmissions . . . . .	G-15

Low Speed Stopping . . . . . G-15  
 Stopping at Speeds Greater than 10 MPH. . . . . G-15  
 Stopping on an Upgrade. . . . . G-15  
 Stopping on a Downgrade . . . . . G-15

CHECKING OVERHEAD CLEARANCE . . . . . G-15

APPROACHING RAILROAD CROSSINGS . . . . . G-16  
 When a Bus Must Stop at a Railroad Crossing. . . . . G-16  
 Procedures for Stopping at a Railroad Crossing. . . . . G-17  
     Prepare to Stop . . . . . G-17  
     Stop the Bus. . . . . G-17  
     Look and Listen . . . . . G-17  
     No Approaching Train. . . . . G-18  
     Approaching Train . . . . . G-18  
     Multi-Track Crossings. . . . . G-18  
 Other Pointers for Dealing with Railroad Crossings . . . . . G-18

CROSSING DRAWBRIDGES . . . . . G-19

ENTERING AND EXITING THE FLOW OF TRAFFIC . . . . . G-20  
 General . . . . . G-20  
 Entrance and Exit Ramps . . . . . G-20

USING LANES AND POSITIONING ON THE HIGHWAY . . . . . G-21  
 General . . . . . G-21  
 Changing Lanes . . . . . G-21  
 Being Overtaken and Passed . . . . . G-22  
 Don't Direct Traffic . . . . . G-22  
 Overtaking and Passing . . . . . G-22

MOUNTAIN DRIVING AND STEEP DOWNGRADES . . . . . G-23  
 Before Starting the Downgrade. . . . . G-23  
 Using Gears Going Downhill. . . . . G-23  
     Use Lower Gears When Going Downhill . . . . . G-23  
     Be in the Right Gear Before Starting Downhill . . . . . G-23  
     Be Observant When Going Downhill . . . . . G-23  
 Proper Braking . . . . . G-24  
 Using Runaway Truck Ramps. . . . . G-24



# UNIT G

## FUNDAMENTALS OF DRIVING A SCHOOL BUS

### INTRODUCTION

Unit F provided you with some basic safe driving techniques for school bus operators geared towards reducing the number of crashes related to driver error, vehicle failure and hazardous roadway conditions. As you well know, operating a school bus requires additional, often specialized knowledge and skills to transport your students safely and efficiently to and from their destinations.

In addition to learning a pattern of special driving skills, you must practice each skill correctly until it becomes a habit. If you can minimize and eliminate crashes resulting from driver error, safe student transport will continue to be a hallmark of the school bus mode of transportation. The following procedures have been developed to assist you in driving a school bus safely. Remember, as a professional school bus operator, you are entrusted with the lives and safety of human cargo that cannot be measured in financial terms. Study, learn and practice the techniques.

### PREPARING TO DRIVE

As mentioned in previous units, your experience in driving automobiles can provide a basis for learning to drive a school bus. However, there is a significant difference in scale. To help prepare for this, you must recognize the differences in your vehicle and prepare to operate your vehicle BEFORE you pick up any student and remember safety is first and schedule is second.

### VEHICLE TYPES

One factor as to why school buses are the safest means of ground transportation in the United States is the stringent vehicle body design and construction standards they are built under and must adhere to. School buses are built so they sit above the crash line, are compartmentalized with high seat backs with padding to absorb full body impact, and have emergency exits to provide added safety. As a school bus operator, you do not need to become an expert on the construction of the vehicle you operate, but a general working knowledge of how your bus is built and the standards it must meet will give you a greater understanding and assist you in answering questions from the general public concerning “how safe” your passengers really are.

### TYPES OF SCHOOL BUSES

#### **Type A (Cutaway Van)**

A Type A school bus is a school bus converted from or having a body constructed upon a van-type truck or front-section vehicle chassis, with a left side driver’s door and the entrance doors behind the front wheels. This definition includes two classifications: Type A1, with a Gross Vehicle Weight Rating (GVWR) less than or equal to 10,000 pounds; and Type A2, with a GVWR greater than 10,000 pounds.

#### **Type B (Integrated)**

A Type B school bus is a school bus constructed utilizing a stripped chassis with the entrance door behind the front wheels. This definition includes two classifications: Type B1, with a GVWR less than or equal to 10,000 pounds; and Type B2, with a GVWR greater than 10,000 pounds.

#### **Type C (Conventional)**

A Type C school bus is a school bus constructed utilizing a chassis with a hood and front fender assembly without a left side driver’s door and with the entrance door behind the front wheels.

**Type D (Transit Type)**

A Type D school bus is a school bus constructed utilizing a stripped chassis with the entrance door ahead of the front wheels.

Most differences between automobile and bus operation are due to the relatively large size and weight of the bus. Always remember a bus has a longer stopping distance, slower acceleration, wider turning radius, and higher and wider clearances. Another difference is while school bus drivers sit higher and have a better forward view, there is much more reliance on mirrors for adequate rear and side viewing.

In preparing to drive, refer to Unit E; "Preventive Maintenance" procedures for a detailed review of the pre-trip inspection. Getting the bus ready for your daily run is an important part of safe driving. Always check your vehicle for safety defects or problems. State law and regulation require passengers and drivers in vehicles equipped with seat belts to wear them whenever the vehicle is in motion.

In summary:

- Complete your pre-trip inspection;
- Adjust your mirrors;
- Adjust your seat; and
- Fasten your seat belt.

**REFERENCE POINT DRIVING**

A reference point is some fixed object or point on your bus that when lined up with points outside the bus will give you consistent reference to judge when to turn, move, stop, line up your bus, or judge the amount of space available around your bus. Any point on the bus such as the door, outside mirrors, windshield center post, bus hood, front and rear bumpers, etc., can be used as a reference point. These points are easily detectable and readily seen by you in the driving position. The distance or guidelines outside the bus are then predetermined by direct measurement or observation before you use your bus for the first time. Once these points are determined and you are comfortable with the understanding of what each reference point is telling you, these points should remain constant.

Here are a few simple steps for determining reference points on your bus (get some help at first, if possible):

1. Position yourself comfortably in your driver's seat;
2. Pick an easily observable point on the hood or windshield of your bus;
3. With the help of someone outside your bus (if possible), on a conventional style bus, find the point on the ground where the edge of the hood lines up with the point on the ground directly in front of it. For a transit style bus, use some point on the windshield to mark your point on the ground in front of the bus;
4. Once you determine this point, note it in your mind and remember it for future reference; and
5. Remember to do this in your own bus, since the point of reference may change from bus to bus depending on the height of the driver's seat and the model of the bus.

For example, if the distance from your reference point to your front bumper measures 18 feet, you will know that whenever you are sitting in the driver's seat, the point on the ground you see directly in front of the hood of your bus is 18 feet from the front bumper. This will be helpful for determining the proper distance to stop at railroad grade crossings.

For determining reference points to the side or rear of your bus, make sure you are seated comfortably in your seat with seat belt attached. Then, mark points on the various outside rear view mirrors on either side of your bus.

To determine the point directly below your rear bumper, use a point in your left (or right) rear view mirror that lines up directly over the bottom of your left rear wheel well and your rear bumper. Now measure the distance from this point on the ground to the edge of your rear bumper. Remember this distance. You should use reference points on both left and right rear mirrors.

This rear reference point can be helpful when estimating the distance from your rear bumper to some point on the ground and can be especially helpful at a railroad grade crossing when determining the distance of your rear bumper from the track.

Finally, remember these measurements should be made and will only be applicable on level ground. Adjust your front and rear measurements when your bus is stopped on a sloped surface.

## **KNOW YOUR ROUTE**

You'll be more confident and be a safer driver when you become completely familiar with the route you drive. You must know what to do with hazards on your route. For example, some intersections are more hazardous due to limited sight or an area with poor drainage that floods.

Follow the local policy and procedures for reporting hazardous stops/routes. If possible, come up with a solution to the problem. Changing the bus route or bus stop location might solve the problem. The township road supervisor might be able to make some changes to the roadway to correct the problem. You could designate a place for your students to stand when the snow is piled up.

There are some hazards that are unavoidable. By being aware of the potential hazards on your route, you will be better prepared for the challenge.

On the route schedule you keep in your bus, make notes of the route hazards, so if there is ever a substitute bus driver on your route, they will have this knowledge, too.

## **FIELD TRIP / ATHLETIC TRIP CONCERNS**

Field trips can present some new situations you haven't experienced, if you are a new driver. Particular situations that might arise could include the following:

- Wondering if the bus will fit (on a street, in a parking area);
- One-way streets;
- Fueling;
- Tolls;

- Parking areas;
- Loading/unloading areas;
- Food and rest room availability;
- Security of area to park bus;
- Weather;
- Chaperones;
- Discipline;
- Medical problems and first aid;
- Terrain;
- Nighttime driving;
- Directions;
- Low clearance;
- Weight limit on bridges;
- Laws in other states; and
- Break downs.

If you are traveling out of state, make sure you have the proper credentials. This includes that you be at least 21 years of age, have the U.S. DOT physical (if employed by a contractor), and carry your log book (if applicable).

Here are some steps to help you be prepared for the field trip/athletic trip.

1. Become familiar with the route.
  - a. Look at a map, take a map with you, ask other drivers who have previously made the trip.
  - b. Drive the route in a car prior to the trip.
  - c. Find out if there are any detours or closed roads. You can call 511, which allows you to instantly access updated road and weather conditions, traffic information, and construction reports for specific routes, regions and cities. Also, refer to [www.511pa.com](http://www.511pa.com).
  - d. Plan an alternate route.
2. Know where parking is and ensure it is secure.
3. Have a full tank of fuel.
4. Make sure you cover the emergency evacuation procedures with students and chaperones.
5. Keep aisles and exits clear of baggage and equipment.
6. Carry emergency phone numbers for school personnel.
7. Know what to do and who to call, if you break down or have an emergency.
8. Communicate with the person in charge of the trip.
  - a. Get the name of the person in charge and their cell phone number.
  - b. Give the person in charge your name and cell phone number.
  - c. Agree on loading and unloading places and times.
  - d. Make sure you and the person in charge know how to get in touch with each other.
  - e. Make sure the person in charge knows where the bus will be parked.

## STARTING AND OPERATING A DIESEL VEHICLE

Guidelines for starting and driving your diesel bus, as well as proper gear shifting techniques are detailed in The Commercial Driver's Manual (Publication 223). Refer to this manual when practicing and refining your techniques. Keep in mind that smoothness in driving is one key to safe driving and good relations with your students. Gear shifting requires knowledge, skills and practice. You must learn the best range of speed for changing gears upward and downward, and you must shift gears without losing your view of the road. Over the course of your driving experiences, you may be required to shift gears in vehicles with standard transmissions and vehicles with automatic transmissions. No matter what transmission type you have, remember to always engage your parking brake when your vehicle is not in use.

### **DIESEL-POWERED MOTOR VEHICLE IDLING ACT: ACT 124 OF 2008**

Diesel vehicles are a significant source of emissions that contribute to elevated ozone and fine particulate concentrations in Pennsylvania. Diesel exhaust from school buses poses a health risk, particularly to children and drivers. Diesel exhaust contains small particles as well as smog-forming and toxic air pollutants. Exposure to diesel exhaust can cause lung damage and respiratory problems and can exacerbate asthma and existing allergies. Buses that idle outside schools can pollute the air inside the school building as well as outdoors.

In 2008, Act 124 (Diesel-Powered Motor Vehicle Idling Act) was passed, which reduces unnecessary idling of the main propulsion engine in diesel-powered motor vehicles, including trucks and buses. Essentially, Act 124 prohibits the owners and drivers of any diesel-powered motor vehicles with a gross weight of 10,001 pounds or more engaged in commerce from allowing the engine of the vehicle to idle for more than five minutes in any continuous 60-minute period. However, 35 P.S. Section 4603(c)(10) allows a school bus to idle a total of 15 minutes in a continuous 60-minute period to provide heat or air conditioning to students. This section also allows school buses transporting students with special needs to idle for an unlimited amount of time when it is necessary to maintain a safe temperature.

Keep in mind that while Act 124 preempts and supersedes local anti-idling ordinances or rules, more stringent idling restrictions imposed by counties of the first and second class (Allegheny and Philadelphia counties), continue in full force and effect, provided they are not amended, suspended or rendered invalid. Here are a few good tips:

- As a general rule, buses should be moving whenever the engine is on;
- The engine should be turned off as soon as possible after arriving at loading or unloading areas;
- The school bus should not be restarted until it is ready to depart; and
- Limit idling time during early morning warm up to what the manufacturer recommends (generally no more than five minutes).

### **PEDAL MISAPPLICATION**

Pedal misapplication occurs when the bus operator applies the accelerator instead of the brake. This error can result in serious crashes. The school environment presents a unique risk with respect to unintended acceleration from pedal misapplication. A typical loading or unloading operation at the school involves multiple vehicles and many children. Often, the children line up, wait or congregate near the buses exposing them to possible danger. Every bus at the loading area can introduce an opportunity for pedal misapplication, and the large number of children represents a potential increase in the severity of the outcome should pedal misapplication and unintended acceleration occur.

There are a few things you can do to help prevent pedal misapplication.

1. Become familiar with your vehicle. Be sure you practice operating your bus before picking up and dropping off students. This will give you familiarity with the location of your accelerator and brake. This is especially important if you are operating a bus that is not your regular bus. If you are unfamiliar with the pedal configuration of an alternate bus, practice first.
2. The National Transportation Safety Board (NTSB) recommends that at locations where you are boarding a large number of students at once (like a school), start your bus only after loading is complete.

## **STEERING AND TURNING YOUR BUS**

You must know the proper techniques for steering a school bus and must be able to make all turning maneuvers correctly and smoothly.

### **STEERING TECHNIQUES**

Proper steering requires the proper positioning of your hands on the steering wheel. Grip the wheel securely with both hands, putting your hands on opposite sides of the wheel. For example, this may mean placing your hands at the ten o'clock and two o'clock positions. One hand on the wheel is less than half as safe. Your hands should be on the outside of the steering wheel with your thumbs on the front of the wheel.

Two steering methods are recommended for school bus drivers. In the push-pull steering method, one hand pulls, and the other hand pushes. The hand-over-hand method also may be used, but you should be careful not to catch your thumb on the safety chain of your wristwatch, bracelet or clothing while steering. Never palm the steering wheel or turn it with a finger or thumb. If you have to steer quickly or jerkily, you are going too fast – slow down.

### **TURNING PROCEDURES**

To drive your school bus you must use the steering techniques described above while executing a number of different turning maneuvers. These maneuvers include rounding curves, and making left and right turns. The average speed limits on freeways and other roads on your route force you to use practiced skills and judgment to perform these maneuvers properly and safely. This includes being aware of the pivot or turning point of the bus while following the various turning procedures. For large school buses, the pivot point is located at the rear axle. The procedures described below are applicable in most driving situations. You always need to be aware of traffic around you before you make your turn.

#### **Rounding Curves**

Judge beforehand if you will be able to negotiate an upcoming curve at your present rate of speed. If you must brake, do so before entering the curve. Never plan to brake in the middle of a curve as this can cause skidding and loss of control. Use the following procedures when steering through curves (see Figure G-1):

1. Slow down, and look ahead for the sharpest point in the curve;
2. Brake, if necessary, before getting into the curve;
3. For curves to the right, move as close to the center line as is safe, and use the width of the lane while rounding the curve. This will help to smooth out the curve;
4. For curves to the left, enter the curve from the right edge of your lane; and
5. When you reach the midpoint of the curve, resume power and accelerate through the remainder of the curve.

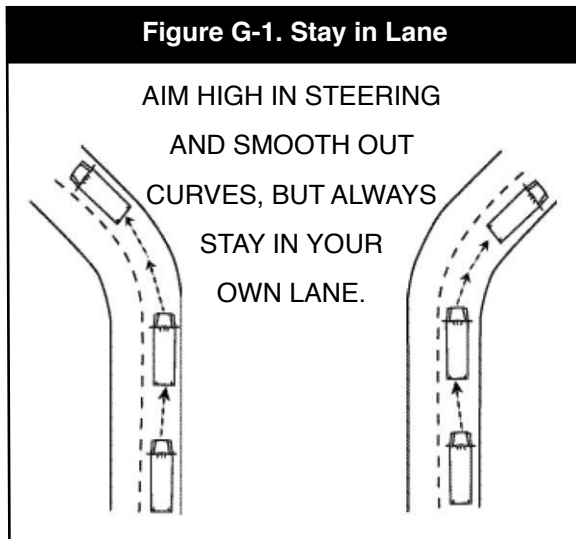

### Making Left and Right Turns

The procedures listed below will enable you to prepare for and make turns and to reenter the traffic pattern while maintaining proper lane positions. When making either a left or right turn, start signaling at least 100 feet before turning, if you are travelling at speeds of 35 mph or less, and at 300 feet if you are travelling at speeds over 35 mph. (See Figures G-2 and G-3.)

WHETHER MAKING A RIGHT OR LEFT TURN, BE AWARE THAT THE REAR OF YOUR BUS WILL PROJECT OUTWARD AS YOU ARE MAKING THE TURN. BE CAREFUL WHEN MAKING A LEFT OR RIGHT TURN WHEN YOU ARE NEXT TO ANOTHER VEHICLE OR OBJECT.

Keep in mind that Pennsylvania school bus crash statistics show improper turning was indicated as the third most common driver action in crashes when the school bus was the prime unit. Data also indicates that 38 percent of school bus prime unit crashes were angle crashes, which most commonly occur at intersections.

### Left Turn Procedures

Left turns in a school bus are generally not as difficult technique-wise to make as right turns, but they are more dangerous. Left turn collisions at intersections tend to be severe crashes. Be sure you have adequate gaps in opposing traffic to make your maneuver. Acceleration rates are different in a school bus than for a passenger vehicle, and you are driving a longer vehicle.

1. Get into the proper lane well in advance of the turn.
2. Give left turn signal early (at least 100 feet away, if you are travelling at speeds of 35 mph or less, and at 300 feet, if travelling at speeds over 35 mph).
3. Reduce speed and downshift to the proper gear needed to execute the turn. The speed through the turn will depend on the geometry of the intersection as well as traffic conditions.
4. Check traffic conditions to the front, rear and sides.
5. Position the bus to the left edge of the traffic lane.
6. Because you do not have the right-of-way (unless at a protected left turn phase at a signalized intersection), re-check traffic signals, signs, pedestrians, or vehicles for a clear right-of-way. Use both outside mirrors and check especially for vehicles attempting to pass the bus on the left side.
7. If you must stop before making the turn, keep the front wheels straight and the brake pedal pressed. This stopping procedure will prevent your bus from being shoved into the path of oncoming traffic, if you are struck from the rear. Also, leave a space of a few feet between your bus and the vehicle in front of you. You should be able to see the rear wheels of the vehicle in front of you. If not, you are too close.

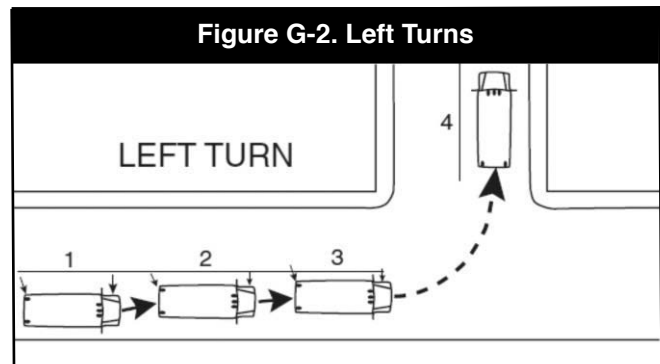

8. Check your left mirror and execute the turn smoothly without strain on the engine. Enter the highway in the left-most lane available. If multiple left-turn lanes exist, be mindful of proper lane usage, and stay in your lane as you make the turn. Steer wheels back into position; do not let the steering wheel spin wheels back.
9. After completion of turn, ensure that your turn signal is off.
10. After completing a left turn onto a multilane highway, pick up speed and move into the right lane as soon as possible.

### Right Turn Procedures

Right turns are more difficult because of the length of the bus and require practice. Knowing the pivot or turning point (located at the rear axle) of the bus is critical for right turns. This responsibility is the bus operators.

For right turns:

1. Get into the proper lane well in advance of the turn.
2. Give right turn signal early (at least 100 feet away, if you are travelling at speeds of 35 mph or less, and at 300 feet, if travelling at speeds over 35 mph).
3. Reduce speed and downshift to the proper gear needed to execute the turn. The speed through the turn will depend on the geometry of the intersection as well as traffic conditions.
4. Position the bus to the right edge of the traffic lane about four feet from the curb. The bus should not be far enough away from the curb to allow a vehicle to pass on the right between the bus and the curb.
5. Check for traffic signals, signs, pedestrians, and vehicles to determine clear right-of-way. Be sure to check for vehicles between right side of the bus and the curb. Use your mirrors!
6. Check your right mirror and execute the turn smoothly without strain on the engine. This is accomplished as soon as the front wheels pass the corner, turn wide to the right, swinging over the center of the side street (if necessary) in order for the rear wheels to clear the curb. Never shift gears during a turn. Keep an eye on the right mirror while turning. Be mindful of any pedestrians who may be standing at or near the curb. Also, watch out for parked cars.
7. Enter the right-most lane available, but leave enough room to make your turn. If your bus must cross into another lane in order to make the turn, make the lane crossover in the road that you are entering.
8. Steer wheels back into position; do not let steering wheel spin back.
9. Ensure your turn signal is off.

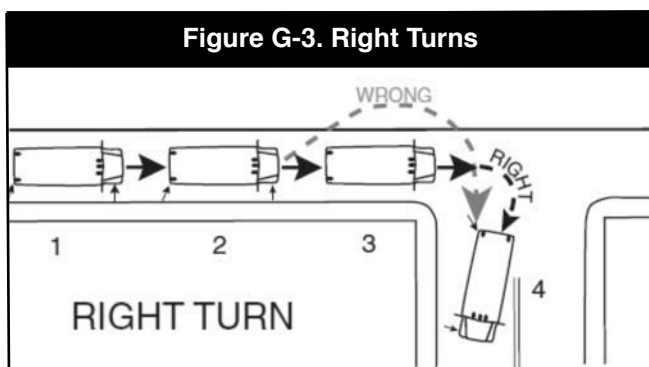

While Pennsylvania law allows all vehicles to make "right turn on red," unless otherwise designated, this maneuver may not be recommended when operating a school bus because of the size of the vehicle and its acceleration characteristics. Check with your contractor or local school district guidelines and procedures.



## BACKING

Because you cannot see everything behind your vehicle, **backing is always dangerous, even in the best circumstances**. This is supported by Pennsylvania school bus crash data, which indicates backing is a crash cause in over 5 percent of crashes involving school buses as the prime vehicle. This seems high considering the number of times backing is required, which supports the notion it is a dangerous maneuver. Pennsylvania school bus crash data shows backing crashes are four times as likely to occur in clear weather conditions as in adverse weather conditions. This may indicate drivers are complacent with this maneuver when weather conditions are good. ANY time you have to backup, be careful and follow the recommendations below.

Avoid backing whenever you can and avoid backing a bus from a side road to a main road. Unfortunately, there may be situations where backing is necessary, such as when you are at the end of your route and there is no better designated turn around area, or if you get lost on a road and encounter a bridge weight limit. If you know of a better area to turn around that would avoid backing, talk to your transportation coordinator about modifying your route.

School buses are also most often parked by backing into their location. When you park, try to park, so you will be able to pull forward when you leave. When you have to back, follow these rules:

**1. Keep Students on the Bus** – Keep all students on the bus. State regulation (Section 104.3(d) of Title 67) requires that if backing is required at or near a loading or unloading zone, all students must be seated on the bus during the backing. Never back a bus when students are outside, so either back up before drop-off or after-pick up. Be particularly aware of students who may be late and running to catch the bus.

**2. Back and Turn Toward the Driver's Side** – Plan your maneuver. Whenever possible, back toward the driver's side, so you can see better. Backing toward the right side is very dangerous because you can't see as well. If you back and turn toward the driver's side, you can watch the rear of your vehicle by looking out the side window and in the mirror.

When backing a bus, turn the top of the steering wheel toward the direction you want to go. This may take practice.

**3. Look at Your Path** – Look at your line of travel to be sure you know what is behind you before you begin. Don't take chances. Sometimes you can't see enough with your mirrors; it's much safer to get out and look, even if it means walking to the rear of the bus to determine whether the way is clear. By so doing, you may prevent a serious incident. If you need to walk to the rear of the bus, set the parking brake, turn off the motor and take the keys with you. Walk to the rear of the bus to determine whether the way is clear. Also check your clearance to the sides and overhead both in and near the path your vehicle will take. Then reenter the vehicle, check your mirrors and start backing.

**4. Back Slowly and Smoothly** – Always back as slowly as possible so you may make corrections before you get too far off course. Go slowly, so you can correct any steering errors more easily before you get too far off course. Going slowly means you can also stop quickly, if necessary.

**5. Use a Helper Whenever Possible** – If possible, have an adult (not a student) stationed on the driver’s side rear of the bus, so you can see him/her at all times in your mirror to warn traffic and act as your guide. If a helper is available:

- Agree on hand signals ahead of time, especially “Stop”;
- Position the helper out of the travel path, so you can see the helper and the helper can see the path of travel;
- Back slowly; and
- Stop immediately, if you lose sight of your helper.

Verbally communicate with the helper before you begin and while backing.

**6. If No Adult Helper is Available** – It may be necessary to use portable emergency warning devices to block off the lane of traffic the vehicle is backing into. Use the following procedure:

- a. Stop the bus in the correct position to back and activate the four-way hazard warning lights. If the bus does not have automatic back-up signals, use the horn. Remember, approaching traffic may not know you are backing, so using the four-way hazard lights and blowing the horn will help alert them to your maneuver;
- b. Signal for quiet on the bus;
- c. Using mirrors, ensure the way is clear to the rear and sides;
- d. Put transmission in reverse; and
- e. Using mirrors, back slowly and smoothly.

## MAKING A TURN-AROUND

Most bus routes are planned to eliminate turn-arounds and backing because they are extremely hazardous maneuvers. Unfortunately, there may be situations where turning around is necessary. Much like with backing, if you must turn your bus around at a loading zone, always load passengers being picked up before making the turn-around, and always unload passengers being discharged after making the turn-around. If at all possible, make a turn-around in twilight or darkness when an adult helper is present to stop traffic on any roadway used for the maneuver.

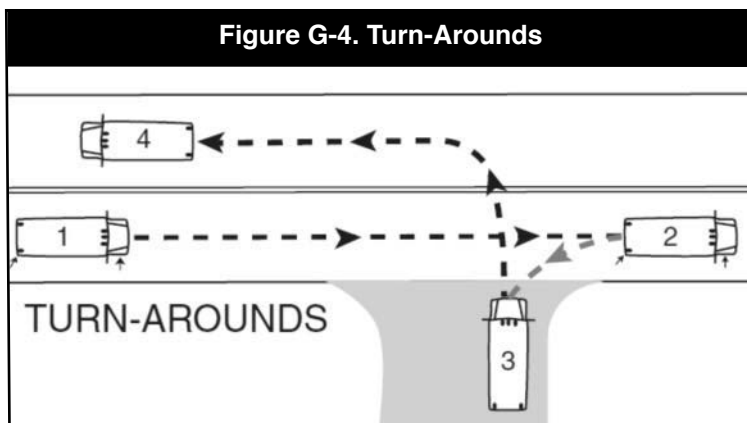

Because backing the bus is an extremely dangerous procedure, the safest way to turn around is to avoid backing and use a forward turn-around. Ideally, a turn-around should be made by selecting an adequately sized, safe area away from the road, such as a parking lot, where you can slowly move the bus forward in a wide circle to turn around. Otherwise, a turn-around should be made in the following manner (see Figure G-4):

1. Activate the four-way hazard warning lights at least 200 feet before your stopping point;
2. Stop the bus in the proper position on the highway, which is one full bus length ahead of the area into which you are backing;

3. Check traffic to the front and rear, as well as roadside obstacles such as poles, trees, mailboxes and culverts. Clearance on all sides of the bus is important. You should have traffic visibility for at least 500 feet in either direction;
4. Use all mirrors and look carefully in all directions to observe traffic and obstacles, back slowly and cautiously into the designated area (see backing information above); and
5. Make sure to check traffic both ways, reenter the highway, deactivate the hazard warning lights, and proceed with extreme caution.

## STOPPING

Unit F included detailed information on stopping requirements for school buses. Stopping a school bus smoothly and within the limits of safety is the sign of an expert driver. Good drivers have their vehicles under control at all times and know braking distances increase greatly as speed and vehicle weight increase. In addition to knowing the distance required to safely stop their bus under all driving conditions, skillful drivers use correct stopping procedures, which increase bus life and lower maintenance costs.

### Anti-lock Braking Systems

The U.S. DOT requires that anti-lock braking systems be on air brakes vehicles, (trucks, buses, trailers, etc.) built on or after March 1, 1998 and hydraulically braked trucks and buses with a gross vehicle weight rating of 10,000 lbs or more built on or after March 1, 1999. Many buses built before these dates have been voluntarily equipped with ABS. Your school bus will have a yellow ABS malfunction lamp on the instrument panel, if it is equipped with ABS.

### How ABS Helps You

When you brake hard on slippery surfaces in a vehicle without ABS, your wheels may lock up. When your front steering wheels lock up, you lose steering control. When your other wheels lock up, you may skid or even spin the vehicle. ABS helps you avoid wheel lock up and maintain control. You may or may not be able to stop faster with ABS, but you should be able to steer around an obstacle while braking, and avoid skids caused by over braking.

### Braking With ABS

ABS is designed to help the driver maintain control of the bus during emergency braking situations, not make the bus stop more quickly. ABS may shorten stopping distances on wet or slippery roads, and many systems will shorten stopping distances on dry roads. On very soft surfaces, such as loose gravel or unpacked snow, an ABS system may actually lengthen stopping distances. In wet or slippery conditions, you should still make sure you drive carefully, always keep a safe distance behind the vehicle in front of you, and maintain a speed consistent with the road conditions.

When you drive a vehicle with ABS, you should brake as you always have. In other words:

- Use only the braking force necessary to stop safely and stay in control; and
- Brake the same way, regardless of whether you have ABS on the bus.

However, in emergency braking, do not pump the brakes on a bus with ABS.

As you slow down, monitor your bus and back off of the brakes (if it is safe to do so) to stay in control.

**Braking if ABS is Not Working**

Without ABS, you still have normal brake functions. Drive and brake as you always have. Vehicles with ABS have yellow malfunction lamps to tell you if something is not working. The yellow ABS malfunction lamp is on the bus's instrument panel. As a system check on newer vehicles, the malfunction lamp comes on at start-up for a bulb check and then goes out quickly. On older systems, the lamp could stay on until you are driving over five mph. If the lamp stays on after the bulb check, or goes on once you are under way, you may have lost ABS control at one or more wheels. Remember, if your ABS malfunctions, you still have regular brakes. Drive normally, but get the system serviced soon.

**Safety Reminders**

- ABS does not compensate for bad driving habits, such as driving too fast, following too closely or driving less carefully;
- ABS won't prevent power or turning skids – ABS should prevent brake-induced skids, but not those caused by spinning the drive wheels or going too fast in a turn;
- ABS won't necessarily shorten stopping distance. ABS will help maintain vehicle control, but not always shorten stopping distance;
- ABS won't increase or decrease ultimate stopping power – ABS is an “add-on” to your normal brakes, not a replacement for them;
- ABS won't change the way you normally brake. Under normal brake conditions, your vehicle will stop as it always stopped. ABS only comes into play when a wheel would normally have locked up because of over-braking; and
- ABS won't compensate for bad brakes or poor brake maintenance.

Remember: The best vehicle safety feature is still a safe driver.

Remember: Drive so you never need to use your ABS.

Remember: If you need it, ABS could help to prevent a serious crash.

Remember: If your bus is equipped with ABS, do not pump the brakes in emergency situations.

**GENERAL STOPPING TECHNIQUE**

Use the right foot for all normal braking. A school bus is much heavier than smaller vehicles and requires the driver to begin braking sooner in order to stop smoothly. Feather the brake by reducing pressure on the brake pedal slightly just before the wheels stop rolling. This creates a smoother stop and happier passengers. A good driver anticipates stops as much as possible. This increases the margin of safety and helps save brake shoes. Avoid sudden stops.

## **STOPPING PROCEDURES FOR STANDARD TRANSMISSIONS**

Different procedures are required for stopping at low and high speeds or on an upgrade or downgrade. If you stop the bus for more than several minutes in a non-traffic situation, turn off the engine. This not only conserves fuel, but eliminates the possibility of poisonous carbon monoxide exhaust fumes entering the bus.

### **Low Speed Stopping**

When you are in a low gear or are traveling 10 mph or less, use the following stopping procedures:

1. Release the accelerator and when speed decreases to 3 to 5 mph, press the clutch pedal;
2. Apply the brakes gradually by increasing pressure;
3. To prevent the bus from jerking, reduce the brake pressure slightly, but not completely just before coming to a stop;
4. Place the gear shift lever into the neutral position; and
5. Release the clutch and remove foot from the clutch.

### **Stopping at Speeds Greater than 10 MPH**

When traveling in a higher gear, the procedure for stopping is as follows:

1. Release the accelerator and press the brake pedal;
2. When you reach the minimum speed for the next lower gear, downshift to that gear. Using the lower gear will reduce the buildup of heat and avoid excessive brake wear. This is also the case for automatic transmissions; and
3. Downshifting can be very effective and smooth if you use third gear for the slowing action in five-speed transmissions, and second gear in four-speed transmissions.

### **Stopping on an Upgrade**

When coming to a stop on an upgrade, you should:

1. Be aware of the traffic behind you;
2. Apply pressure on the foot brake lightly for a smooth stop;
3. Press clutch with left foot; shift into neutral;
4. Hold bus with hand brake, if necessary. Don't use the clutch as a brake; and
5. Allow an extra safety margin of space between the bus and the vehicle ahead.

### **Stopping on a Downgrade**

When coming to a stop on a downgrade, stop as you would on an upgrade, except downshift to reduce speed as necessary. If the downgrade is quite long and/or steep, use the "snub" braking technique discussed later in this unit.

## **CHECKING OVERHEAD CLEARANCE**

Hitting overhead objects is a danger. A typical school bus is not more than 12 feet in height, so make sure you always have enough room overhead. This not only includes on-the-road hazards, such as low hanging wires, overhanging branches, etc., but overhead hazards in your bus storage location such as wash bays and garage entrances. The clearance requirement for wires over a roadway is 18 feet, but over driveways is only 15 feet. This is a significant difference and one to be aware of if you have to turn a bus around, especially if the wires appear to be hanging low.

A few other points to keep in mind:

- If you aren't sure you have safe space to pass under an object, go slowly and watch carefully. This will allow you to stop, if you cannot make it. If you doubt you can make it, take another route. Pay attention to warnings posted in advance of and on low bridges or underpasses. These should be posted where the vertical clearance is less than 14'6 feet. A typical school bus is not more than 12 feet in height, so pay attention.
- Don't assume the heights posted at bridges and overpasses are correct. Repaving or packed snow may have reduced clearances since heights were posted.
- Some roads are narrow and are crowned such that it can cause a vehicle to tilt. This may result in problems for the bus clearing objects along the edge of the road, such as signs or trees. Where this is a problem, drive a little closer to the center of the road as long as you keep adequate side clearance from the center of the road. You do not want to sideswipe a vehicle travelling in the opposite direction with your mirrors or bus body.
- If you have to turn a bus around and back into an area, get out and check for overhanging objects, such as trees, branches or electric wires. It's easy to miss seeing them while you are backing. Also check for other hazards like culverts or mailboxes at the same time. Remember to turn off the bus and remove the keys from ignition, if students are on board.
- If you notice low overhanging branches along your route, consider reporting them to your supervisor who can notify the proper entity responsible for removing them. This can be important, especially with dead limbs overhanging the route, which are typically the ones to fall on the roadway after the first snow/ice storm.
- Know the height of your vehicle, including roof hatches and strobe lights.

## APPROACHING RAILROAD CROSSINGS

Crossing railroad tracks represents one of the greatest hazards in terms of mass injuries and fatalities for students riding in school buses. Planned safety procedures for vehicles crossing railroad tracks can help eliminate these crashes. Practice the procedures discussed below until they become automatic actions. At the same time, don't let repetition create a false sense of security.

Trains cannot stop quickly as its response is limited by its size, weight and the engineer's view down the track. A train cannot swerve to avoid a school bus. Also, due to their large size, trains appear to be moving more slowly than their actual speed. Drivers often mistakenly judge they have enough time to safely cross before the train reaches the crossing. Be aware of this fact and, whenever in doubt, wait for the train to pass. You have a number of young lives depending on you; always use extra caution when making decisions at railroad crossings.

### WHEN A BUS MUST STOP AT A RAILROAD CROSSING

State law (Section 3342 of Title 75, the PA Vehicle Code) requires all school buses, whether carrying passengers, to stop at all railroad crossings. The exceptions are:

- Crossings controlled by a police officer or flagman;
- Crossings regulated by a functioning highway traffic control signal transmitting a green light;
- Any crossing marked by the former rail operator with a "tracks out of service" sign; and
- An industrial or spur line crossing marked with an "exempt" sign.

## PROCEDURES FOR STOPPING AT A RAILROAD CROSSING

When you must stop your bus at a railroad crossing, Pennsylvania regulations (Section 71.4(2)(ii)(B) of Title 67) require you to always follow these procedures:

1. When approaching, activate 4-way hazard lights;
2. Stop between 15 and 50 feet from nearest the rail;
3. Apply parking brake, transmission in neutral;
4. Open door and window;
5. Look and listen;
6. Close door;
7. If clear, put in gear and release parking brake;
8. Proceed across tracks without shifting gears; and
9. Deactivate four-way hazard lights after crossing tracks.

What follows is a more detailed discussion of these steps.

### Prepare to Stop

1. Request complete silence from passengers, so you have minimal distractions. If necessary, turn off heaters to further reduce noise;
2. Turn off any AM-FM, 2-way or CB radios, or any other noise emitting devices not necessary for the safe operation of the bus;
3. As you approach, get the big picture: check traffic control devices; visibility of the crossing, tracks, terrain, and roadways on either side of the tracks; volume, type, and position of other traffic; sight distance down the tracks; and the amount of space on the other side of the track should you have to stop your vehicle shortly after crossing the track; and
4. Activate four-way hazard lights 100 to 200 feet in advance of the tracks.

### Stop the Bus

1. Follow stopping procedures described earlier in this unit;
2. Stop in a position permitting you to have a clear view of the tracks in both directions. The front bumper must be clear of tracks, at least 15 feet away and at most 50 feet away from the nearest rail;
3. Pull up, so you can see the tracks in both directions, if needed;
4. Remember to allow extra distance at any railroad grade crossing since trains overlap the track by about three feet.
5. Apply the parking (emergency) brake and shift into neutral.

### Look and Listen

1. Open service door and driver's window; make sure that you do not activate the eight-way light system;
2. Turn off any AM-FM, 2-way or CB radios, or any other noise emitting devices not necessary for the safe operation of the bus;
3. Look and listen through the open door and window; and
4. Never leave a bus to check for a train.

**No Approaching Train**

If you see and hear no signs of an approaching train, do the following:

1. Close service door;
2. Put the bus in low gear and release the parking (emergency) brake;
3. Look and listen a second time;
4. If clear, proceed across the track without shifting gears; and
5. Deactivate four-way hazard lights after clearing the tracks.

**Approaching Train**

A train cannot stop quickly. Trains always appear to be moving slower than they actually are. Follow these procedures when a train is approaching the crossing:

1. Hold bus in position and use the parking (emergency) brake;
2. After the train passes, proceed across the tracks as described above.

**Multi-Track Crossings**

At crossings with more than one set of tracks, do the following:

1. Check the crossbuck for a sign indicating the number of tracks at the crossing, if there is more than one;
2. Make sure no train is approaching on any of the tracks;
3. Only make one stop – not one stop per track; and
4. After a train passes, wait until other tracks become visible before proceeding. A second train may be approaching from the opposite direction.

**OTHER POINTERS FOR DEALING WITH RAILROAD CROSSINGS**

Here are a few additional safety tips to learn when driving over railroad grade crossings:

1. Learn about the various types of highway/rail grade crossing warning devices. Not only are you risking arrest, if you fail to respond properly to these devices, you are risking your life and the lives of your passengers. For example,
  - a. The “crossbuck” is a passive or “non-active” sign identifying a rail crossing. Always use extreme caution when passing over a crossing. You may proceed across a railroad highway/rail grade crossing only after a train has passed and/or you determine no train is approaching.
  - b. At multiple-track crossings, the number of sets of tracks governed by the crossing device is indicated by a number under the cross buck sign. If there are multiple tracks, there will be a number to indicate how many sets of tracks will be crossed.

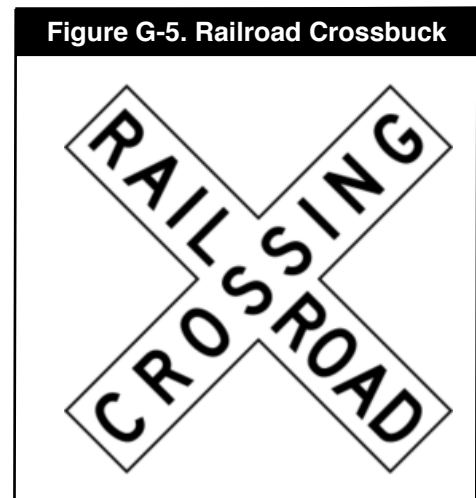



2. **REMEMBER**, no person shall drive any vehicle through, around or under any crossing gate or barrier at a railroad crossing while such gate or barrier is closed or is being opened or closed. If you encounter a situation where an automatic flashing light signal with gate is operating and no train has arrived after an extended period of time, report the lowered gate immediately, check for an alternate route or wait for assistance. No student can exit the bus to lift the gate.
3. Always follow directions of a police officer or flag person directing traffic at any highway/rail grade crossing.
4. Cross the tracks only after the train has cleared a position to cancel any warning devices activated, or at crossings with no automatic warning devices.
5. The drivers of manual transmission buses should place the gear in low starting gear. The driver should close the service door, look again in both directions, check for flashing signal lights, and then proceed across the tracks without stopping or changing gears.
6. The drivers of automatic transmission buses should proceed over the tracks using the normal driving gear. A good rule of thumb is to proceed in the lowest gear until you are clear of the tracks. This prevents the gear from changing while crossing the tracks.
7. Never drive onto a railroad track until you are certain there is adequate room ahead for your **ENTIRE** vehicle to clear the tracks completely. Know the length of your bus. It can be life threatening to begin to cross a set of tracks only to find you must stop your vehicle for traffic before you have completely cleared the tracks.
8. Never stop and backup the bus while crossing the tracks.
9. Hazard lights need to be activated approximately between 100 and 200 feet before and after stopping at the highway/rail grade crossing. Cancel your hazard lights when you have completely cleared the tracks, and your vehicle has traveled at least 100 feet from the tracks.

If for any reason your bus should become stalled on the tracks and a train is approaching, **IMMEDIATELY EVACUATE** your bus. The quickest method of evacuation would be the front- and rear-door method. The driver should assign a responsible student in each group to keep the children together. The driver must be able to see both groups of children. Students should be instructed to move away from the bus in a direction toward the train, but at a right angle to the train. (This is important, since upon impact, the bus and debris will be pushed down the track.) If the bus is stalled on the tracks and no train is in sight, the driver should evacuate the children from the front or back of the bus. The children should move to a safe place at least 200 feet away from the bus. They must not cross the tracks. All evacuation procedures need to be cleared by the district personnel.

## **CROSSING DRAWBRIDGES**

School buses are required to stop at drawbridges without a signal light or traffic control attendant at the gate. Stop at least 50 feet before the draw of the bridge. Look to make sure the draw is completely closed before crossing. After stopping, proceed when it is safe to do so. It is recommended you cross in low gear, so there will be no necessity for changing gears while traversing the drawbridge. Therefore, like railroad crossings, do not shift gears while crossing the draw span of any draw bridge.

You do not need to stop, but you must slow down and make sure it's safe when:

- A traffic light on the bridge is showing green; and
- The bridge has an attendant or traffic officer who controls traffic whenever the bridge opens.

## ENTERING AND EXITING THE FLOW OF TRAFFIC

While driving, you will frequently leave one traffic stream and become part of another or cross through a second stream of traffic. This may occur at intersections, or even simply picking up or discharging your students. In many cases, your vehicle movements will be regulated by traffic signs or signals. In other cases, the merging points will be controlled by your good judgment.

### GENERAL

Observe the following procedures when entering the flow of traffic:

1. Turn on the appropriate turn signal well before the point of entry;
2. If appropriate, stop just before the point of entry. In many cases you will already be stopped. If you are on a freeway acceleration lane marked with a yield sign, see the next section on ramps;
3. Check your mirror to ensure all passengers are seated;
4. Ensure no pedestrians are in the path of the bus;
5. Look left and right to see if there are any moving vehicles on the road you will enter;
6. Check all mirrors for clear space around the bus including behind you. If necessary, turn your head to check blind spots;
7. Yield the right-of-way to vehicles already on the road;
8. Look for a suitable gap in traffic and, with reasonable safety, accelerate smoothly into the roadway as quickly as possible; and
9. Turn off the turn signal after you are safely in your lane.

Observe the following procedures when exiting the flow of traffic:

1. Turn on the appropriate turn signal well before the point of exit;
2. Look left and right to see if there are any moving vehicles on the road you will be merging onto, especially if it is a deceleration lane;
3. Check all mirrors for clear space around the bus, including behind you. If necessary, turn your head to check blind spots;
4. Decelerate smoothly and, remember, school buses will take longer to stop; and
5. Turn off the turn signal after you have safely exited.

### ENTRANCE AND EXIT RAMPS

Observe the following procedures when driving on entrance or exit ramps. A school bus is slower to respond to changes in acceleration and deceleration, so you will need to adjust your driving habits accordingly. Enter or exit the expressway as safely and quickly as possible while accelerating or decelerating to the flow of traffic as needed.

1. Check and re-check the traffic ahead when entering the driving lane on an entrance ramp. Look specifically for vehicles stopped or slowing down.
2. When driving on a long entrance ramp with an acceleration lane marked with a yield sign, check the traffic ahead, and, if possible, allow the vehicles ahead to leave the acceleration lane before attempting to merge into the roadway. Use the acceleration lane to match speed with the main stream of traffic before entering a suitable gap.
3. Always use turn signals when merging.

4. If you are entering the main roadway from an entrance ramp without an acceleration lane or one with a stop control, stop before merging. Through the side window, observe the main stream of traffic and do not proceed until you detect a gap large enough for accelerating and merging safely and smoothly.
5. When approaching and entering an exit ramp, observe the speed of traffic and adjust your speed appropriately. Remember, posted speed limits for off ramps and on ramps are for automobiles, but may not be safe for larger vehicles. Watch for other vehicles that may be stopped or waiting in line at the end of the exit ramp.
6. Be prepared to stop.

## USING LANES AND POSITIONING ON THE HIGHWAY

Changing lanes, being passed by other vehicles, and passing other vehicles are maneuvers you will execute often while driving a school bus. The size of a school bus and the safety of your passengers require the use of proper procedures when executing these maneuvers.

### GENERAL

Follow these procedures:

- Always drive in the lane of traffic giving you the best maneuverability for your route (especially when making turns) and allows you the best defensive position for weather, traffic, and road conditions;
- Stay within one lane for normal driving; do not straddle lane markers;
- To maintain proper lane position, get the “big picture” of the road ahead. Always aim high in steering; don’t use white lines or other steering guides too close to the bus. Activate your four-way hazard warning lights when your speed is below the posted speed on open highways;
- Use parking lane for stopping and parking only;
- Where there is more than one lane for traffic in the same direction, travel in the right-most lane unless you intend to pass or turn left. Do not drive in the parking lane; and
- Drive at a safe following distance from other vehicles. A discussion of safe following distances can be found earlier in this unit.

### CHANGING LANES

When you drive a school bus in an urban/suburban area, you may have to change lanes frequently. Changing lanes with a school bus requires greater concentration and more careful use of mirrors than changing lanes with a car. If a lane change is necessary, always use extreme care.

On highways and streets with multiple lanes of traffic in the same direction, use these procedures to change lanes:

- When changing lanes, always signal your intention to change lanes with your turn signal. You must always use your turn signals at least 100 feet before turning, if you are driving less than 35 mph. If you are driving 35 mph or more, you must signal at least 300 feet before turning. Look for traffic approaching from behind you in the new lane.
- If your vision in the mirror is obscured by a blind spot, move your head and look up and down (vertically) or back and forth (horizontally) until you can see around the blind spot. If it helps, turn your head to view any possible blind spots at your side and rear.
- On multilane roads, look for vehicles in your lane and adjacent lanes about to enter the lane you wish to enter. Note their speeds, and be sure you can execute your lane change maneuver safely.

- Continually check your mirrors.
- Remember to disengage your turn signal.

## **BEING OVERTAKEN AND PASSED**

State law (Section 3345 of Title 75, the PA Vehicle Code) prohibits motor vehicles from passing a school bus when the bus has their red four-way flashers activated. Refer to Unit C. However, school buses are often overtaken and passed by other vehicles while operating on a roadway. In this situation, keep the following in mind:

- When there is no potential hazard, stay in right-hand lane and maintain your speed. Shadow the brake pedal and be prepared to stop quickly, if a hazardous situation arises from the passing vehicle.
- When on a narrow road, if following traffic builds up and a regular stop is not close by, you can consider pulling completely off of the road, using the right turn signal, and stop. Allow vehicles to pass, but never signal for them to pass. Keep your four-way flashers off. When traffic has passed and there is a sufficient gap to reenter the flow of traffic, use your left turn signal and resume your position on the road. If you cannot pull completely off of the highway, use this procedure only in legal passing zones.

## **DON'T DIRECT TRAFFIC**

Some drivers try to help out others by signaling when it is safe to pass. You should not do this; you could cause a crash.

## **OVERTAKING AND PASSING**

Usually you won't have to overtake and pass other vehicles, and school bus drivers should avoid passing other vehicles as much as possible. A driver usually will gain very little or nothing at all by passing, because any vehicle moving more slowly than a school bus is not likely to go very far before turning off. But, when it is necessary, use extreme caution and follow these procedures:

1. Observe the traffic ahead, and do not pass, if the lead vehicle is signaling a left turn, changing lanes in order to pass another vehicle, or passing pedestrians, cyclists, or animals;
2. Wait until your view of the road ahead and behind is clear and there is an acceptable gap in traffic;
3. On a two-lane road, check to be sure there is no oncoming traffic, and check traffic signs and road markings to determine, if passing is allowed;
4. Turn on the left turn signal at least 100 feet before turning, if you are driving less than 35 mph. If you are driving 35 mph or more, you must signal at least 300 feet before turning;
5. It is most dangerous to pass at night because you cannot see as far ahead, and it is more difficult to accurately judge distances and speed of approaching vehicles. If you can only see the headlights of an oncoming vehicle, you are likely to think it is further away than it really is. When clear, pull smoothly into the passing lane;
6. After moving past the vehicle at a safe speed, turn on the right turn signal, and then move back into the right lane when you are at least one and one-half bus lengths ahead of the passed vehicle; and
7. Turn off the right turn signal.

## **MOUNTAIN DRIVING AND STEEP DOWNGRADES**

In mountain driving, the force of gravity plays a major role. If you have a heavy load, you will have to use lower gears and go slower to climb hills. In coming down steep hills, gravity will tend to speed you up. You must go slow enough your brakes can hold you back without getting too hot. If the brakes become too hot, they may start to “fade.” This means you have to apply them harder and harder to get the same stopping power. If you continue to use the brakes hard, they can continue to fade until you can’t slow down or stop at all. You can avoid these dangers by going slow when going downhill.

### **BEFORE STARTING THE DOWNGRADE**

Two key elements for your driving procedures before you start the downgrade are:

1. Downshift as necessary to help control engine speed; and
2. Test your brakes by gently applying the foot brake to ensure they are functioning properly.

### **USING GEARS GOING DOWNHILL**

#### **Use Lower Gears When Going Downhill**

No matter how big your vehicle is, going down long, steep grades can cause your brakes to fail, if you go too fast. Using lower gears will help you keep from going too fast. Lower gears allow engine compression and friction to help slow the vehicle. This is true whether you have an automatic transmission or a manual transmission.

#### **Be in the Right Gear Before Starting Downhill**

If you have a large vehicle with a manual transmission, don’t wait until you have started down the hill to shift down. You might get hung up in neutral and lose the benefit of engine braking. You would find yourself coasting, which would be illegal and dangerous.

**YOU MAY HAVE TO USE LOWER GEARS GOING DOWN A HILL THAN WOULD BE REQUIRED TO GO UP THE HILL.**

With older buses, a rule for choosing gears is to use the same gear going down a hill you would need to climb up the hill. However, new buses have low friction parts and streamlined shapes for fuel economy. They may also have more powerful engines. This means they can go up hills in higher gears and have less friction and air drag to hold them back going down hills. Find out what is right for your bus.

#### **Be Observant When Going Downhill**

As your bus moves down the grade, continue checking traffic in all directions and stay in the right-most lane. Don’t forget to increase your following distance. Based on your observations of existing conditions, select a safe speed for going downhill based on the weight of your bus, length and steepness of grade, weather and road conditions. To maintain that speed, refer to the braking section below.

## PROPER BRAKING

When going downhill, brakes will always heat up. They are designed so brake shoes or pads rub against the brake drum or disks to slow the vehicle, which creates heat. Brakes are designed to take a lot of heat. However, brakes can be made to fail from excessive heat by attempting to slow down from too high a speed too many times or too quickly. Brakes will fade (have less stopping power) when they get very hot, and they can get to the point where they will no longer slow the vehicle.

The right way to use your brakes for long downhill grades is to go slow enough (use your gears) that a fairly sparing use of the brakes will keep your speed from increasing. If you go slowly enough, the brakes will be able to get rid of the heat, and they won't get too hot.

Forceful, intermittent braking (snubbing) is safer than light, continued braking. Letting up on the brakes from time to time will allow them to cool enough, so they don't become overheated. Light, continued pressure causes hot-spotting and in general makes the brakes run hotter, leading to increased probability of brake fade. Light, continued pressure also causes the brakes to wear faster, which is both a safety problem and a maintenance problem.

Therefore, select the right gear, go slow enough, and use forceful, intermittent braking (snubbing). This can be summarized in the following steps:

1. Select the right gear;
2. Go slow;
3. Apply the brakes just hard enough to feel a definite slowdown;
4. When your speed has been reduced to approximately 5 mph below your "safe" speed, release the brakes; and
5. When your speed has increased to your "safe" speed, repeat steps 1 and 2. This is also known as "snub" braking.

## USING RUNAWAY TRUCK RAMPS

Runaway truck ramps have been built on many steep mountain grades. These ramps are made to stop runaway vehicles safely without injuring drivers and passengers. Runaway truck ramps use a long bed of loose, soft material (pea gravel) to slow a runaway vehicle, sometimes in combination with an upgrade.

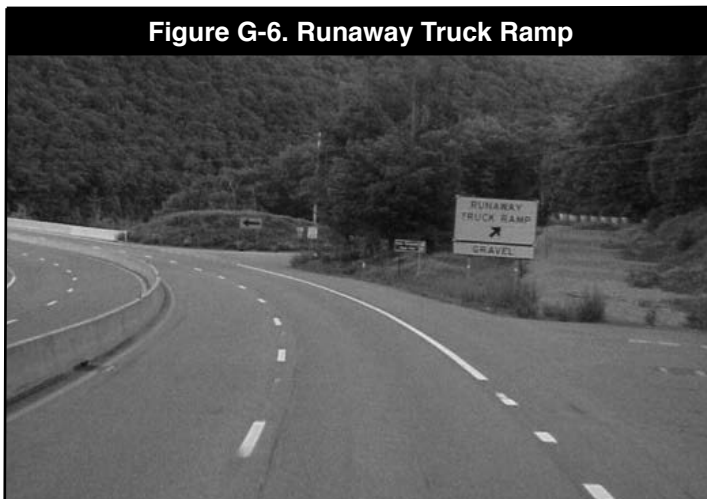

Know runaway truck ramp locations on your route. Look for signs indicating where ramps are located and use them if you lose your brakes. Also see the section "Loss of Brakes" in Unit H (Crash and Emergency Procedures).

# UNIT H - CRASH AND EMERGENCY PROCEDURES

INTRODUCTION . . . . .	H-3
EMERGENCY DRIVING TECHNIQUES . . . . .	H-3
Skid Control and Recovery . . . . .	H-3
Hydroplaning . . . . .	H-4
Tire Blowout . . . . .	H-5
Sound . . . . .	H-5
Vibration . . . . .	H-5
Feel . . . . .	H-5
Loss of Brakes . . . . .	H-5
Finding an Escape Route on Level Terrain or Upgrades . . . . .	H-6
Finding an Escape Route on Downgrades: Runaway Truck Ramps . . . . .	H-6
Sudden Loss of Visibility . . . . .	H-7
Water Splashed on Windshield . . . . .	H-7
Windshield Wiper Failure . . . . .	H-7
Headlight Failure . . . . .	H-7
Hood Flying Up . . . . .	H-7
Patch of Fog . . . . .	H-8
Whiteout from Snow . . . . .	H-8
Obstructions in the Path of the Bus . . . . .	H-8
Proper Braking . . . . .	H-8
Steering to Avoid Collision . . . . .	H-9
Choosing a Lesser Collision . . . . .	H-10
EMERGENCY PROCEDURES . . . . .	H-10
Crash Procedures . . . . .	H-11
Bus-Related Procedures . . . . .	H-11
Crash Scene Procedures . . . . .	H-12
Reporting Procedures . . . . .	H-13
Incident Reporting . . . . .	H-13
Mechanical Failure or Breakdown . . . . .	H-13
EVACUATING THE BUS . . . . .	H-14
When to Evacuate . . . . .	H-14
Existing or Imminent Smoke or Fire Condition . . . . .	H-14
Presence of Hazardous Materials . . . . .	H-14
Unsafe Position . . . . .	H-14
Bus Submersion or Immersion . . . . .	H-14
Evacuation Drills . . . . .	H-15
Front Door Evacuation Drill . . . . .	H-15
Rear Emergency Door Evacuation Drill . . . . .	H-16
Front and Rear Door Evacuation Drill . . . . .	H-18
Other Emergency Evacuation Procedures . . . . .	H-18

USE EMERGENCY EQUIPMENT.....	H-19
Portable Emergency Warning Devices .....	H-19
Pry Bar .....	H-20
Fire Extinguisher .....	H-20
Engine Fires .....	H-20
Other Fires .....	H-20
To Operate a Fire Extinguisher.....	H-20
List of Student Names.....	H-21
Spare Electrical Fuses .....	H-21
Seat Belt Cutter.....	H-21
Optional Equipment .....	H-21
 SCHOOL BUS SECURITY .....	 H-22
Why School Buses Can be Targets.....	H-22
School Bus Drivers .....	H-22
Characteristics of Suspicious Items .....	H-22
School Bus Safety and Security Checklist .....	H-23
Identifying Suspicious Behavior or Activities.....	H-23
Reporting Suspicious Items and Unusual Activities .....	H-23
 HOSTAGE AWARENESS .....	 H-24
Emotional Stages .....	H-24
Things “To Do” in a Hostage Situation .....	H-24
Things “Not to Do” in a Hostage Situation .....	H-24
Tips to Help You in a Hostage Situation .....	H-25



# UNIT H

## CRASH AND EMERGENCY PROCEDURES

### INTRODUCTION

Professional drivers don't depend on their skills to get them out of potentially dangerous situations. They depend on their judgment to avoid these situations. It's a lot easier to avoid of potentially dangerous situations than to get out of them. This was the focus in Units F and G. However, if you are involved in a crash or emergency situation, you will need to take certain emergency actions.

This unit is divided into two major sections. The first describes emergency driving techniques you can use as a last effort to avoid crashes. The second covers crash and emergency procedures, except for First Aid, which is covered in Unit I (Student Emergencies).

### EMERGENCY DRIVING TECHNIQUES

As you learned in previous units, driving factors such as light, weather, road, traffic, vehicle, and drivers are not usually all adverse at the same time; they come at the driver in groups. Weather conditions affect the amount of light available and the condition of the road. Light, especially too much light, can irritate a driver, and traffic conditions can do the same. Weather can affect traffic, slowing it down and making it more congested. Weather can affect vehicles as well, with the possibility of overheating in summer heat or having brittle parts break in the cold of winter. The school bus driver who adjusts his speed to adverse conditions, inspects the bus, keeps his bus in top mechanical condition, and remains alert and ready, has a better chance of remaining safe.

As a safe driver, you will be able to avoid most potentially dangerous situations through good driving habits, use of safety equipment, and proper observation. However, you may find yourself confronted with one of these five emergency driving conditions:

- Skid;
- Tire blowout;
- Loss of brakes;
- Sudden loss of visibility; or
- Objects, pedestrians and obstructions in the path of the bus.

Under these conditions, you must know what emergency driving techniques to use. Your responses must become automatic – you will not have much time to think about what you should do. The procedures in this unit are “last ditch” measures to prevent a crash, if at all possible.

### SKID CONTROL AND RECOVERY

Many factors can cause a school bus to go into a skid. During a skid, the tires lose proper traction with the road surface. Normal means of controlling the bus, including steering, braking and accelerating, won't work as usual — you must learn specific anti-skid techniques. Therefore, you must be able to detect a loss of traction in time to maintain or regain control of the bus.

Loss of traction may include:

- Skids caused when tires fail from under-inflation or from a blowout;
- Front wheel skids resulting from faulty brakes, slippery road surfaces or driving too fast for conditions;
- Rear wheel skids resulting from faulty brakes, driving too fast, accelerating too quickly on curves, or rough or slippery surfaces;
- A four-wheel locked brake skid resulting from jamming too hard on the brakes;
- Hydroplaning resulting from traveling too fast on a water-covered highway or from driving in water with under-inflated or worn tires; or
- Skidding resulting from oil film, wet leaves, loose surfaces, ice, or other slippery conditions.

Once you lose traction and the bus goes into a skid, you must be able to regain directional control. Controlling a skid requires controlled steering, smooth deceleration and controlled braking. If your school bus has lost traction and begins to skid, you will need to do the following:

1. Keep both hands on the steering wheel;
2. Stop braking to allow your rear tires to start rolling again;
3. If you have your foot on the accelerator, gradually lift your foot from the accelerator smoothly, not suddenly;
4. Turn quickly in the direction you want the vehicle to go;
5. Countersteer as your vehicle turns back on course. If you do not turn the steering wheel quickly in the other direction, you will skid in the opposite direction; and
6. Keep your eyes in the direction you want to go.

### **Hydroplaning**

Hydroplaning is a unique situation where your bus loses traction on a slippery surface. If your bus is traveling straight, it may begin to feel slightly loose. If there was a high level of road feel in normal conditions, it may suddenly diminish. If the drive wheels hydroplane, there may be a sudden audible rise in engine RPM and indicated speed as they begin to spin. In a broad highway turn, if the front wheels lose traction, the bus will suddenly begin to drift toward the outside of the bend. If the rear wheels lose traction, the back of the bus will begin to slide out sideways into a skid. If all four wheels hydroplane at once, the bus will slide in a straight line, again toward the outside of the bend if in a turn. When any or all of the wheels regain traction, there may be a sudden jerk in whatever direction that wheel is pointed.

To recover while traveling in a straight line, you should not turn the steering wheel of the bus or apply the brakes. Either action could put the bus into a skid from which recovery would be difficult or impossible. Instead, with no change in steering input, gently ease pressure off of the accelerator and engage the clutch. This will slow your vehicle and let the wheels turn freely; control should then return. If braking is unavoidable, lightly pump the brakes until hydroplaning has stopped.

If the rear wheels hydroplane and cause oversteer, you should steer in the direction of the skid until the rear tires gain traction, and then rapidly steer in the other direction to straighten the bus.

Do not accelerate again until you regain steering control.

Remember, on a bus with anti-lock brakes (ABS), don't pump the brakes. Apply the brakes as needed, allowing the ABS system to automatically pump the brakes. If you don't have ABS, don't panic and jam on the brakes. Don't brake at all or apply only light braking pressure until you regain steering control. On a bus with hydraulic brakes, light braking requires you to pump the brakes softly to slow the bus in a controlled manner.

On a bus with air brakes, use no brakes at all in a skid if possible — never pump the brakes. The brakes may catch or come on too quickly, further adding to the problem. You should learn what types of brakes your bus has and the proper method of fanning the brakes to gain control.

## TIRE BLOWOUT

You must recognize a tire blowout quickly because you only have a few seconds to react. If your front tire has a blowout, your bus will pull in the direction of the flat. If your rear tire blows out, the bus will swerve. Fortunately, most school buses have dual rear wheels, which can minimize swerving in case of a tire blowout, but you will still feel a pull. The major signs of tire failure are:

**Sound** – The loud “bang” of a blowout is an easily recognized sign. Because it can take a few seconds for your vehicle to react, you might think it is some other vehicle. But any time you hear a tire blow, you must assume it is yours and prepare to stop.

**Vibration** – If the vehicle thumps or vibrates heavily, it may be a sign one of the tires has gone flat. With a rear tire, it may be the only sign you get.

**Feel** – If the steering feels “heavy,” it is probably a sign one of the front tires has failed. Sometimes, failure of a rear tire will cause the vehicle to slide back and forth or “fishtail.” However, dual rear tires usually minimize this.

If a tire blows out:

1. Grip the steering wheel firmly and steer your vehicle straight down the center of your traffic lane;
2. Accelerate for a short period to help maintain steering. Once steering is controlled, let up on the accelerator and let the bus slow down;
3. Do not jam on the brakes – apply them slowly only after you have regained control of the steering;
4. If the bus starts to skid, follow skid control procedures outlined above;
5. Activate right turn signal, move slowly toward the right (out of the traffic lane), and stop;
6. Be sure to activate the hazard warning lights, not the school bus eight-way warning system; and
7. Set up portable emergency warning devices to warn other motorists of your position on the road.

This is discussed below.

## LOSS OF BRAKES

Anytime you lose your brakes, slow down as described below and attempt to maneuver the bus out of traffic before it comes to a stop, steering to avoid a crash. If this is impossible and the bus stops on the highway, activate hazard warning lights, place appropriate warning markers on the roadway, and evacuate the bus to a place of safety where the students can wait for help. Emergency parking and evacuation procedures are described later in this unit.

If you have brake failure:

- Downshift. Putting the bus into a lower gear will help to slow the bus;
- Sound the horn; and
- DO NOT TURN OFF THE ENGINE.

If your bus has a hydraulic braking system and you experience a partial or total loss of brakes:

- Pump the brake pedal firmly and very rapidly several times; and
- Use the parking brake. On a hydraulic brake bus, the parking brake is separate from the hydraulic brake system. It can be used to slow the bus, if the hydraulic system fails. Gradually apply the parking brake by pressing the release button or pulling the release lever at the same time you use the parking brake, so you can adjust the brake pressure and keep the wheels from locking up.

If your bus has air brakes, a warning buzzer will alert you to the loss of air pressure and to the possibility of the rear brakes locking when air pressure drops to approximately 30 psi. If locking should occur, causing the bus to go into a skid, follow skid control procedures.

### Finding an Escape Route on Level Terrain or Upgrades

While slowing the bus, look for an escape route — an open field, wide shoulder, side street or escape ramp. Turning uphill is a good way to slow and stop the bus. Make sure the bus does not start rolling backward after you stop. Put it in low gear, apply the parking brake and, if necessary, roll back into some obstacle that will stop the bus.

### Finding an Escape Route on Downgrades: Runaway Truck Ramps

Going slowly enough and braking properly will almost always prevent brake failure on long downgrades. Once



the brakes have failed, however, you are going to have to look outside your bus for something to stop it.

Your best hope is a runaway truck ramp provided on many highways with dangerous downgrades (see Figure H-1). If there is one, there will be signs telling you about it. Use it. Every year, hundreds of drivers avoid injury to themselves, their passengers and others as well as damage to their vehicles by using these runaway truck ramps.

Some runaway truck ramps use soft gravel that resists the motion of the vehicle and brings it to a stop. Others turn uphill, using the hill to stop the bus and soft gravel to hold it in place. Be prepared to use the ramp if necessary. If your route includes a long downgrade with a runaway truck ramp, be sure you know where it is.

If there is an upgrade within the clear distance ahead, stay on the road and allow the upgrade to slow the bus; then select a path for leaving the highway. If no upgrade is within the clear distance ahead, select a path for leaving the highway that will minimize injuries and property damage.

If no runaway truck ramp is available, and no upgrade is within clear distance ahead, take the least hazardous escape route you can — such as an open field, or a side road that flattens out or turns uphill. Make the move as soon as you know your brakes don't work. The longer you wait, the faster the bus will go and the harder it will be to stop.

## **SUDDEN LOSS OF VISIBILITY**

The following can cause a sudden loss of visibility while driving:

- Water splashed on the windshield;
- Windshield wiper failure;
- Headlight failure;
- Hood flying up;
- Patch of fog; and
- White out from snow.

Until you regain normal visibility, you must use cues other than normal visual ones to help you control the bus.

### **Water Splashed on Windshield**

If water is splashed on the windshield:

1. Remove your foot from the accelerator and turn on the wipers;
2. While doing so, apply the brakes cautiously; and
3. Look out the side windows to keep sight of the road.

### **Windshield Wiper Failure**

If windshield wipers fail during rain, sleet or snow:

1. Look out the side windows to keep sight of the road;
2. Apply the brakes cautiously; and
3. Activate your turn signal to get off of the road and stop. Activate hazard warning lights.

### **Headlight Failure**

If the headlights fail, immediately:

1. Hit the dimmer switch to determine if a portion of your lights may be functional;
2. Activate the hazard warning lights;
3. Try to keep sight of the road;
4. Brake slowly; and
5. Steer out of traffic lane, and stop.

Try to use available light along the way to keep sight of the road. In an extreme emergency, a good source of available light would be the flashing hazard lights on the school bus.

### **Hood Flying Up**

If the hood flies up:

1. Look out the left and right windows to help keep your sense of direction;
2. Apply brakes moderately;
3. Activate your turn signal;
4. Steer out of the traffic lane to stop; and
5. When stopped, activate the hazard warning lights, not the school bus eight-way warning lights.

**Patch of Fog**

If you enter a patch of thick fog limiting your vision:

1. Activate the low beams and hazard warning lights and slow down;
2. Use the center or edge lines on the highway to guide you;
3. If the fog is severe, stay in your lane, use your 4-ways, and proceed cautiously; and
4. Activate strobe light, if equipped.

Under no circumstances should you park your vehicle on the highway. In fog it is especially important to watch for other vehicles that have slowed abruptly or stopped on or near the road.

**Whiteout from Snow**

If snowfall is creating a condition where your visibility is severely restricted:

1. Remove your foot from the accelerator and turn on the wipers;
2. While doing so, apply the brakes cautiously;
3. Look out the side windows to keep sight of the road; and
4. Steer out of the traffic lane to stop, if necessary, and activate the hazard warning lights.

**OBSTRUCTIONS IN THE PATH OF THE BUS**

Occasionally, objects may suddenly cross your path while you are operating the bus, such as a pedestrian, vehicle, construction barrier, bicyclist, etc. If these are in your direct path, you must take evasive action. Always remember you are more likely to avoid hitting anything, if you have been practicing good scanning patterns, anticipating problem areas and mentally practicing taking effective evasive action repeatedly until it becomes completely automatic.

You must instantly choose between trying to stop in time and selecting an “escape route,” which is free from other, more hazardous obstacles. Evasive action is simply the exercise of your fundamental driving maneuvers under conditions of stress — limited time, space and distance.

You must decide which of the following evasive actions you should perform:

- Proper use of brakes;
- Steering to avoid collision;
- Quick maneuvering, with or without braking;
- Leaving the highway for an escape route free from other more hazardous obstacles; or
- Choosing a lesser collision.

**Proper Braking**

Generally, drivers tend to apply the brakes at the first sign of trouble. While effective in most instances, braking can lock the wheels and cause loss of steering control, making it impossible to steer away from a collision. For effective evasive action, you must sometimes avoid the temptation to jam on the brakes.

On the other hand, you may decide that braking to a stop is the best evasive action you can take to avoid the obstruction. This will depend on how fast you are going, how far away you are from the object, how good your tires are, and whether the road is wet or dry.

For example, if someone suddenly pulls out in front of you, your natural response is to hit the brakes. This is a good response if there’s enough distance to stop and you use the brakes correctly.

You should brake in a way that will keep your vehicle in a straight line and allow you to turn if it becomes necessary. Braking methods were discussed in Unit G.

With controlled braking, you apply the brakes as hard as you can without locking the wheels. Keep steering wheel movements very small while doing this. If you need to make a larger steering adjustment or if the wheels lock, release the brakes. As soon as the wheels start rolling, apply the brakes fully again. It can take up to one second for the wheels to start rolling after you release the brakes, Re-apply the brakes as soon as you can.

On a bus with anti-lock brakes (ABS), don't pump the brakes. Apply the brakes firmly, allowing the ABS system to automatically pump the brakes.

### **Steering to Avoid Collision**

Stopping is not always the safest thing to do in an emergency. When you do not have enough room to stop, you may have to steer to avoid a crash. In many cases, you can turn to miss a hazard faster than you can stop. Therefore, if it's not instantly obvious you can stop in time; you must choose to steer the bus in an alternative path. In order to accomplish this, you must be able to quickly recognize the best escape route. At a glance, decide if a possible escape path is free from other, more hazardous obstacles.

You should avoid swerving the bus, as sudden swerves can be very dangerous, risking your passengers' safety. Because the bus is so big and heavy, it can't swerve sharply to avoid an object or leave the pavement with any great degree of control. Swerving risks overturning the bus. Steer firmly and as gradually as possible to clear the obstruction, and use the brakes, when necessary, as outlined in the previous sections. If possible, avoid steering left, into the opposite lane of traffic. Here are a few tips:

1. **Keep both hands on the steering wheel** – To turn quickly you must have a firm grip on the steering wheel with both hands. The best way to have both hands on the wheel in the event of an emergency is to keep them there all of the time.
2. **Know how to turn quickly and safely** – A quick turn can be made safely, if it is done the right way. Here are some points safe drivers use:
  - a) Do not apply the brake while you are turning. It is very easy to lock your wheels while turning. If that happens, you may skid out of control;
  - b) Do not turn any more than needed to clear whatever is in your way. The more sharply you turn, the greater the chances of a skid or rollover; and
  - c) Be prepared to "countersteer," that is, to turn the wheels back in the other direction, once you have passed whatever was in your path.
3. **Know where to steer** – If an oncoming driver has drifted into your lane, moving to the right is best. If that driver realizes what has happened, the natural response will be to return to his or her own lane.
  - a) If something is blocking your path, the best direction to steer will depend on the situation;
  - b) If you have been using your mirrors, you'll know what lane is empty and can be safely used;
  - c) If the shoulder is clear, going right may be best. No one is likely to be driving on the shoulder but someone may be passing you on the left. You will know if you have been using your mirrors; and
  - d) If you are blocked on both sides, a move to the right may be best. At least you won't force anyone into an opposing traffic lane and a possible head-on collision.

4. **Leaving the road** – In some emergencies, you may have to drive off of the road. It may be less risky than facing collision with another vehicle. Most shoulders are strong enough to support the weight of a large vehicle and, therefore, may offer an available escape route. Here are some guidelines to follow if you do leave the road.
  - a) **Avoid Overbraking** – If possible, avoid using the brakes until your speed has dropped to about 20 mph. Then, brake very gently to avoid skidding on a loose surface;
  - b) **Keep One Set of Wheels on the Pavement if Possible** – This will help maintain control; and
  - c) **Stay on the Shoulder** – If the shoulder is clear, stay on it until your vehicle has come to a stop.
5. **Returning to the road** – If you are forced to return to the road before you can stop, do the following:
  - a) If at all possible, stop the bus first. Be careful of fixed objects such as utility poles, mail boxes and parked cars that may be blocking your path;
  - b) Hold the wheel tightly and turn sharply enough to get right back on the road safely;
  - c) Be aware your tires might grab unexpectedly and you could lose control; and
  - d) When both front tires are on the paved surface, “countersteer” immediately. The two turns should be made as a single “steer-countersteer” move.

### Choosing a Lesser Collision

In any case where collision is absolutely unavoidable, try to reduce speed as much as possible. Also, avoid a head-on collision; collision at an angle reduces the force of impact. Remember, you’re more likely to avoid hitting any obstruction in the path of the bus, if you always anticipate the unexpected. Mentally practice effective evasive action until it becomes automatic.

## EMERGENCY PROCEDURES

Crashes are events that can cause injury, death or property damage. If you have a crash or find yourself in some other emergency situation, you should know the proper procedures to follow and the proper use of emergency equipment on the bus.

As a bus driver, you must be prepared for any kind of emergency situation. It doesn’t happen very often, but there is always the possibility of a crash, mechanical breakdown or other emergency. In any case, your first priority is to see all students are as safe as possible. It is important in an emergency to remain calm. Some rules to remember if your bus is involved in a crash are represented by the word “**KNOW.**”

**K = Keep** all students on the bus calm. It is safer for the students to remain on the bus if there is no other immediate danger.

**N = Notify** authorities. Always call for help. Use an available cellular phone, two-way radio or other communication device on your bus; know who you should call and how to do so. If you do not have any means of communication on the bus, you may need to identify a responsible bystander to make a call for assistance. **Only in EXTREME EMERGENCIES should older, responsible students be sent for help. Refer to your school district policy and Unit I for additional information.**

**O = Off** of the road. If you break down, try to position the bus completely off of the road and away from other dangers. If it is not possible to do this, remember to evacuate the students and take them to a safer location.

**W = Warning** devices. Use portable emergency warning devices that satisfy current state regulations (at least three portable emergency reflective triangles) to warn other motorists of your position on the road.



## CRASH PROCEDURES

The Pennsylvania Vehicle Code requires that the driver of a vehicle involved in an accident shall immediately by the quickest means of communication give notice to the nearest office of a duly authorized police department if the accident involves: 1) injury to or death of any person; or 2) damage to any vehicle involved to the extent that it cannot be driven under its own power in its customary manner without further damage or hazard to the vehicle, other traffic elements, or the roadway, and therefore requires towing.

With careful driving habits, you may never be involved in a crash. However, the fact remains a percentage of school bus drivers will be involved in a crash sometime in their driving career. Pennsylvania crash statistics show of the approximately 40,000 Pennsylvania school bus operators, about 13 percent have been involved in one or more crashes.

If you have a crash, **CARRY OUT THE LOCAL POLICY AND PROCEDURES AS QUICKLY AS POSSIBLE.** These include bus-related and scene-related procedures. The following should serve as a guide.

### Bus-Related Procedures

Immediately after a crash, your first actions take place in and around the bus.

1. **Assess the situation.** You should immediately do the following:
  - a. Stop the bus in as safe a place as possible;
  - b. Set the parking brake, turn off all lights and electrical switches and turn off the ignition switch; and
  - c. Remain calm, assess the situation, plan your actions, and reassure the students. Refer to Unit I on Student Emergencies.
2. **Be alert for fire.** If a smoke or fire condition is present or imminent, evacuate the students. Do NOT fight the fire unless all of your students have been evacuated safely, are in a secure location and you feel comfortable re-approaching the bus to fight the fire. Evacuation procedures and use of fire extinguishers are described later in this unit. In determining the potential for fire, check for the following:
  - a. Ruptured fuel tank or fuel lines;
  - b. Hot tires, which may catch fire;
  - c. Presence of smoke; and
  - d. Possible electrical fire or sparks.
3. **Be alert for hazardous materials.** Check for and identify any possible hazardous materials that present or may present a danger to you and your passengers. Evacuate the students, if a danger exists from the following hazardous materials:
  - a. Chemicals;
  - b. Vapors; and
  - c. Other toxic substances.
4. **Assess the students.** Check for injury to students. Keep the students on the bus unless conditions such as the possibility of fire or other dangers warrant their removal. This is the easiest way to account for all students.

## CRASH SCENE PROCEDURES

Once you have taken the above procedures, your next steps should consider the crash scene.

1. **Notify authorities.** Notify state or local police and summon medical aid, if required; notify school administrators as required by local school policy. In most cases, you should not leave the bus unattended to go for help. Ask several passing motorists or pedestrians to notify the proper authorities, if necessary. In an emergency, always follow local school policy, especially in regard to sending students to obtain assistance. You should use the “Three W’s” when communicating:
  - Who: bus number, number of students and types of vehicles involved;
  - Where: location of bus or directions to the scene; and
  - What: what kind of help is needed and nature of the problem(s).
2. **Protect the scene.** Protect the students and the bus, from further crashes and injuries by placing warning devices to warn other drivers, and evacuate the bus, if necessary, or both. Protect the scene from traffic and people, so evidence is not destroyed.
3. **Cooperate with the crash investigation.** After you have handled all potential dangers to your passengers, cooperate with officials investigating the crash. You should ONLY discuss the facts of the crash with those officially concerned (police, school officials, insurance personnel). Do not discuss the crash with other motorists or passers-by. Be patient, evaluate questions, and give clear and concise answers to any questions asked by officials. Only respond to the questions asked; don’t add your own opinion.

State law requires you to carry a list of every student passenger’s name on the bus in case of a crash or emergency. Provide this information, along with any relevant information about the school bus (e.g., make, model, vehicle number, owner, insurance information), to officials investigating the crash. All such information, including emergency telephone numbers, a seating chart of all passengers (if applicable), and local directives covering crashes and emergencies should be contained in an emergency packet carried on the bus. Contact your insurance carrier to obtain a proper packet.

A driver involved in a crash is required to give his or her own name, address, driver’s license number, and other pertinent information to any other driver involved, and to obtain the same information from any other driver(s) involved in the crash. Get the names, addresses and license numbers of all witnesses’ – both for and against you.

A school bus driver involved in a crash meeting Federal Highway post-crash testing thresholds is also required to submit to testing for alcohol and controlled substances. Note: Pennsylvania state law requires testing after any reportable crash in a school bus.

4. **Keep students at the scene.** During the crash investigation, do not release any of your students to anyone unless instructed by school administration officials or unless medical aid is required. Always keep students on the bus unless the situation requires emergency evacuation.

**Keep the following in mind when speaking with others involved in the crash or bystanders:**

- **ADMIT NOTHING;**
- **PROMISE NOTHING; AND**
- **DO NOT ARGUE.**

## REPORTING PROCEDURES

**Every crash must be reported to your supervisor. There are no minor crashes involving a school bus!**

Remember the information you need for your crash report:

- School bus ID number;
- Driver's name, address and driver's license number;
- Date, time, weather, and direction of travel;
- Damage to vehicle;
- Name of owner of other vehicle or property, address, license number, make and model of vehicle, and damage to other vehicle;
- Injuries to persons involved, their names, addresses, extent of injuries;
- List of passengers on the bus and in other vehicle(s);
- Names and addresses of passengers in other vehicles;
- Name of insurance companies involved;
- Name of police at scene; and
- Diagram of crash scene.

In addition to any local crash reports, the owner or operator of any school bus involved in a crash is required by state law:

- Within 24 hours, to report the crash to the chief school administrator or the authorized representative of the school district, private school, or parochial school that either employs or contracts the service of the owner or operator.
- Within five days, School Bus Crash Report (DL-739) must be completed whenever there is any injury or property damage, regardless of how slight. Complete the form even when students aren't on the bus at the time of the crash. After completing the form, submit it to PennDOT. You should check with your employer and school district regarding who will fill this form out. In some cases, the driver will fill this out, in others, the safety director.

### Incident Reporting

Because of the possibility of liability suits, drivers are responsible for reporting all incidents occurring in or around their buses during their runs. Remember, your passengers are your first responsibility in any incident. You should report all incidents to your supervisor. He or she will take any appropriate action, if necessary.

## MECHANICAL FAILURE OR BREAKDOWN

In the event of a mechanical breakdown, know what to do, how to do it and when it should be done.

The following is a suggested procedure:

1. Stop the bus as far to the right of the road as possible or on the shoulder of the road;
2. Keep the students on the bus. However, if the location of the bus is unsafe, evacuate the students to a safer location (see evacuation procedures in the next section);
3. Activate hazard warning lights and place warning devices on the highway (see the section on using emergency equipment later in this unit);
4. Contact the proper school authorities and give the location of the bus and a description of the breakdown; and
5. See that arrangements are made for all students to be delivered to their destination.

## EVACUATING THE BUS

In certain crash and emergency situations, you may need to evacuate the students from the bus. You should know when to evacuate the bus and the procedures for evacuating a bus. These procedures are practiced in required evacuation drills. In any situation requiring evacuation, remain calm and take charge of the situation. As the bus driver, YOU are the leader. Review procedures below for guidance in situations where you are incapacitated.

### WHEN TO EVACUATE

Usually, students remain on the bus during an emergency. Four situations, however, require that you evacuate the bus — existing or imminent smoke or fire condition, presence of hazardous materials, unsafe position of the bus, or vehicle submersion or immersion.

#### Existing or Imminent Smoke or Fire Condition

Stop the bus and evacuate it immediately, if the engine or any portion of the bus is smoking or on fire. An existing fire near the bus or the presence of gasoline or other combustible material is considered as “danger of fire.” Evacuate students as described below.

- Evacuate students through the door farthest from the fire or potential source of fire;
- Evacuate students closest to the danger first;
- Give the students a specific location to go to that is far away from the bus but still within your visual range; and
- Give clear, concise and EXACT instructions.

#### Presence of Hazardous Materials

If any hazardous materials are present in or near the bus, evacuate the students. This includes vapors or fumes, which may enter the bus from outside sources and may be dangerous to the passengers.

#### Unsafe Position

In the event the bus is stopped due to a crash, mechanical failure, road conditions, or human failure, determine immediately whether it is safer for the passengers to remain in the bus or to evacuate. You must evacuate when:

- The final stopping point of the bus is in the path of any train or adjacent to any railroad tracks.
- The position of the bus might change and increase the danger. For example, evacuate if a bus comes to rest near a body of water or cliff where it could still move and go into the water or over the cliff.
- The location of the bus creates the danger of collision. In normal traffic conditions, the bus should be visible for a distance of 300 feet or more. A position over a hill or around a curve where such visibility does not exist should be considered reason for evacuation (see Figure H-2).

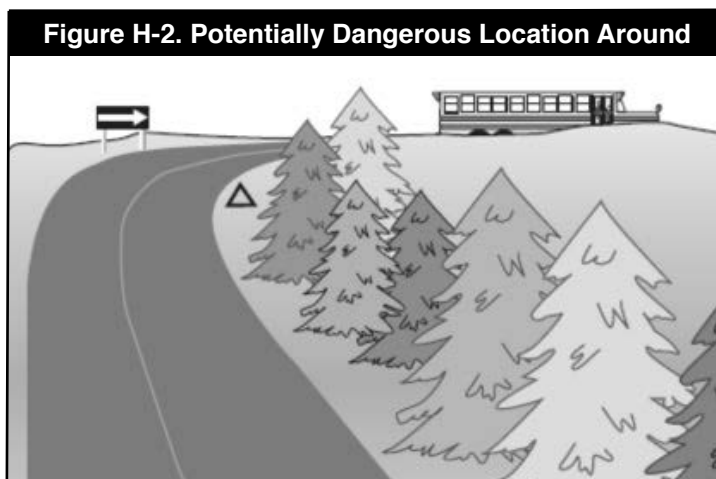

#### Bus Submersion or Immersion

In the very unlikely event the bus has driven off of the roadway and into a body of water and is submerged or immersed, evacuate students out of the nearest most usable exit.

In all these cases, carry out the evacuation as safely as possible.

## EVACUATION DRILLS

In an emergency, the students may panic and rush to the exit causing the emergency door to become jammed by everyone trying to get out at the same time. So that students know what to expect during an evacuation, State law requires each student who is transported in a school bus to participate in emergency evacuation drills in the first week of school and in March of every school year. This includes all students even if they may only ride a bus on special trips. In fact, drills should be conducted more frequently. While state law does not require evacuation drills for school vehicles, they are highly recommended as a matter of safety preparedness for both students and drivers alike.

Everyone involved in drills should keep these points in mind:

- Safety of the students is of the utmost importance and must be considered first. Getting them off of the bus safely, quickly and in an orderly fashion is the objective.
- All drills should be supervised by the principal or by persons assigned to act in a supervisory capacity and held on school property. You are responsible for conducting the drill in an organized manner.
- In a real emergency, you might be incapacitated and unable to direct the student emergency evacuation. During the drill, be sure to review procedures with students, so they know what to do if you are unable to help. Don't assign a student as a leader without written consent from a parent or legal guardian.
- During the drill, students should be instructed how and where to get help if the driver is unable to do so. Instructions and telephone numbers should be posted or otherwise carried in the bus. Students should be instructed to enlist several bystanders to go for help, since some of those asked might not want to get involved in the situation.
- Students should be instructed on how to use the radio, and the location of emergency equipment on the bus.
- Follow local policies in conducting evacuation drills and emergency procedures.
- Explain to all passengers the procedures to be followed if an evacuation is necessary. The following recommended procedures may be adapted to your local situation.

### Front Door Evacuation Drill

In the interest of safety, all drivers should regularly conduct an emergency evacuation drill through the front door with each bus load of students, when they unload at school (see Figure H-3).

Follow these steps:

1. Stop the bus at the normal unloading location or pre-selected location on the school grounds;
2. Set parking brake, turn off engine and remove ignition key;
3. In buses with a manual transmission, select either the first gear or reverse position. In buses with automatic transmissions, select either the park position or neutral with the parking brake on;
4. Stand, open the front door, face the students, and get their attention;
5. Tell them, "Do what I say — remain absolutely quiet";
6. Then say, "Front door emergency evacuation drill—remain seated";
7. Direct two student helpers (appointed at the beginning of the year or each month) to their positions. Assign one helper to lead the students to a designated location away from the bus where the students quietly remain in order. Assign the other helper to stay outside the front door to count and assist passengers as they leave;
8. Instruct students to leave all belongings such as books and lunch containers on the bus and tell them they can be retrieved after the drill is completed;

9. Turn and face the front of the bus, standing between the first row of occupied seats;
10. Starting with the right-hand seat, tap the shoulder of the student nearest the aisle to indicate that those occupants should move out. Say, "Walk — don't run. Use hand rails." At the same time, hold your hand before the occupants in the left-hand seat in a restraining gesture;
11. When the students in the right-hand seat have moved far enough to clear the aisle, dismiss the occupants of the left-hand seat;
12. Continue this procedure as described, right and left seats alternately, until the bus is empty;
13. When the last seat is empty, walk to the front of the bus and check to be sure everyone is out;
14. Leave the bus and take the helper at the front door with you and join the passengers and the other helper;
15. Evaluate the evacuation drill, pointing out improvements needed and commending students on activities well done;
16. Have students return to the bus in an orderly manner to retrieve their belongings before entering the school. Have students who are to continue to another school remain on the bus, and proceed on your route; and
17. Complete any reports as required by local policy.

Figure H-3. Front Door Evacuation

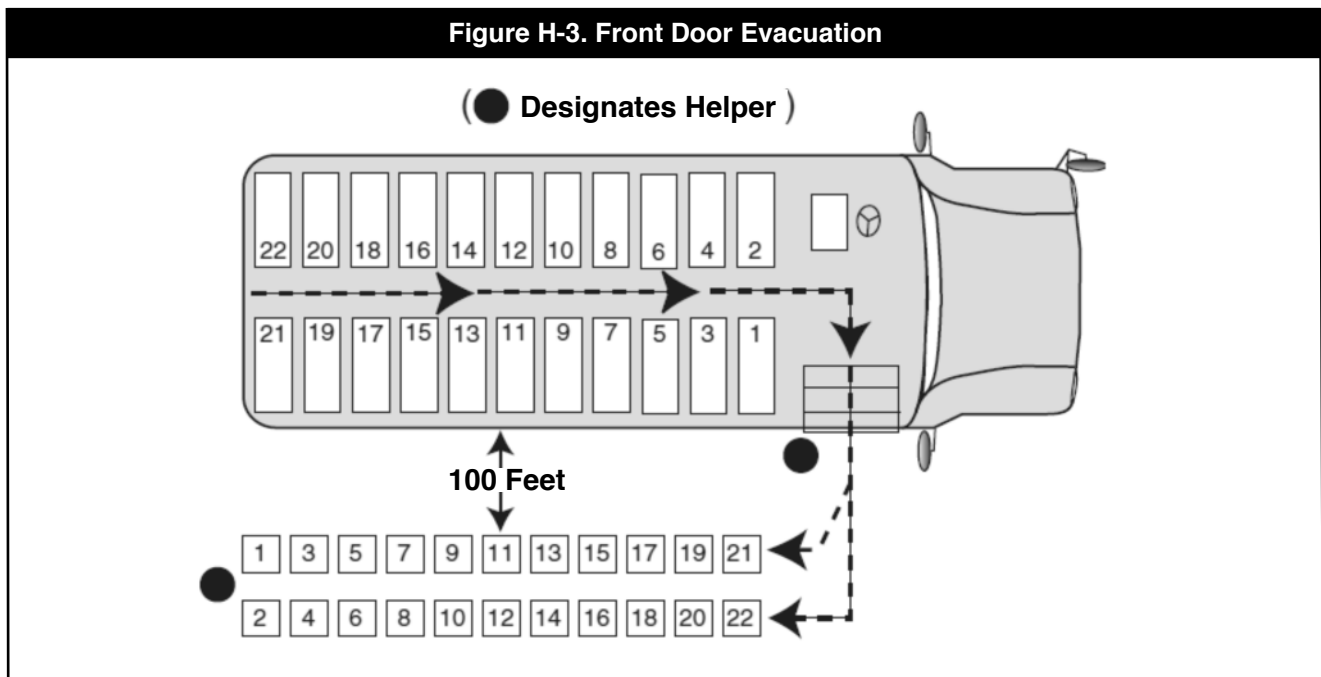

### Rear Emergency Door Evacuation Drill

The rear emergency door evacuation drill should be practiced as often as possible with elementary and secondary students (see Figure H-4). In some cases, the rear emergency door evacuation drill may be used for demonstration purposes only and not practiced by students in order to prevent unnecessary injury performing the drill.

1. Follow steps 1-3 of the Front Door Evacuation Drill;
2. Stand facing the students, get their attention and tell them, "Do what I say — remain absolutely quiet";
3. Then say, "Rear door emergency evacuation drill — remain seated";

4. Instruct students to leave all belongings such as books and lunch containers on the bus and tell them they can be retrieved after the drill is completed;
5. Walk to the rear of the bus and face rear door;
6. Use left hand to restrain occupants of right rear seat;
7. Open the rear emergency door;
8. Assign two helpers to sit in the left rear seat. Have the helpers exit out the rear emergency door. Assign the helpers to assist passengers getting out of the bus: one helper assists the passengers as they exit the bus, and the other leads passengers to a designated location away from the bus where they remain quietly in order;
9. Face the doorway and move between the left rear seats to clear the aisle;
10. Instruct students in right rear seats to leave the bus. Have them assume a semi-squat position as they exit the bus. Instruct helpers to grasp a passengers' wrist or forearm with one hand and to place their other hand under a passengers' shoulder as the passenger exits the bus. Caution students not to bump their heads when leaving through the rear door;
11. Tell students in the next left seat to leave the bus. Keep control at the rear door to prevent any pushing or shoving. Students who are injured, disabled or in a condition that may be aggravated by exiting out the rear door (e.g., overweight, pregnant) should not be required to participate in the drill. They should leave the bus with the driver through the front door and join the other students when the drill is completed;
12. Continue the above procedure, alternating left and right seats until the bus is empty;
13. When the last student has exited, walk to the front of the bus and check to make sure everyone is out; and
14. Join the students and conclude the drill as described in steps 15-17 of the Front Door Evacuation Drill.

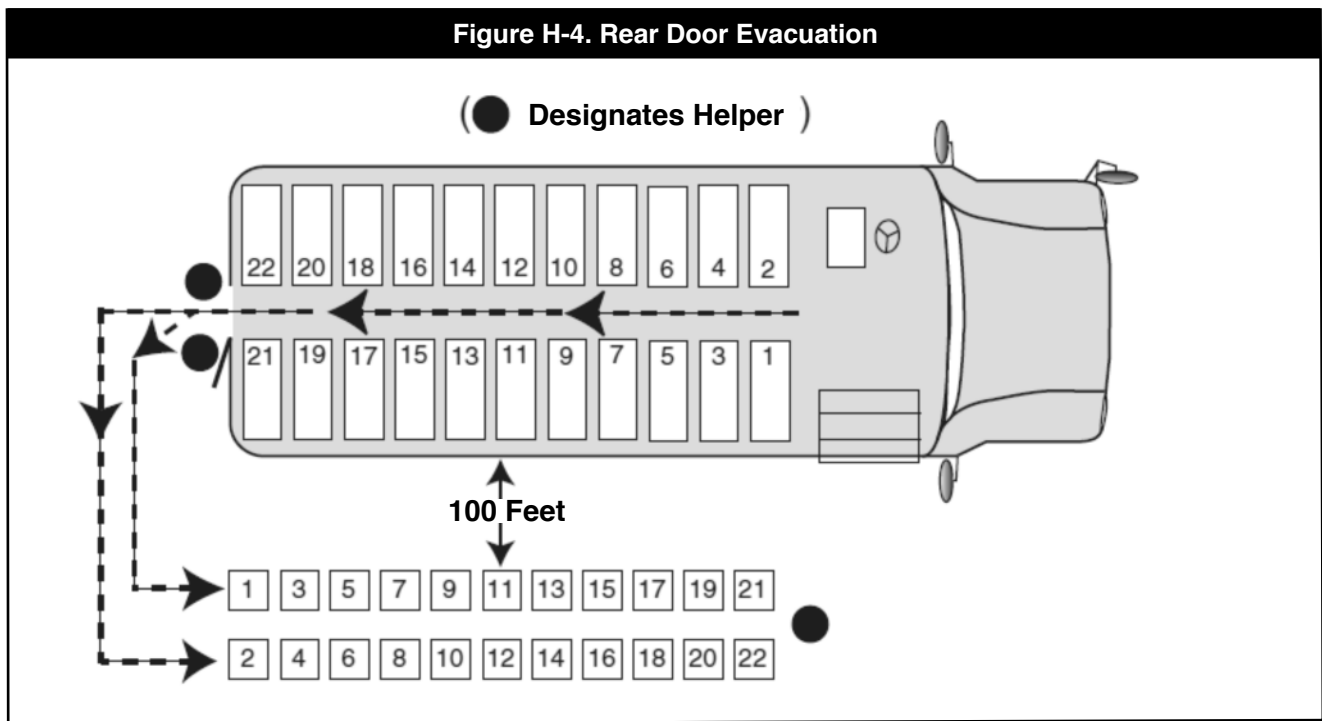

### Front and Rear Door Evacuation Drill

A combination of the procedures used for the front door and rear door evacuations also can be used for an evacuation drill in which students leave the bus through the front and rear doors (see Figure H-5). Procedures for the front door evacuation are used for students in the front half of the bus; and procedures for the rear door evacuation are used for students in the rear half of the bus. The only exception to using these procedures as described above would be the command given at the beginning of the drill: “Front and rear door emergency evacuation drill — remain seated.” In a real emergency, this type of evacuation would require the shortest amount of time to get the passengers off of the bus. However, it is dependent upon both doors being available for safe evacuation. This drill should be used for elementary and secondary students. Student helpers should be properly instructed on how to assist students out of the rear of the bus. Helpers should reach up and lift students down as they exit the rear emergency door. Again, this drill may be performed as a demonstration only.

**Figure H-5. Front and Rear Door Evacuation**

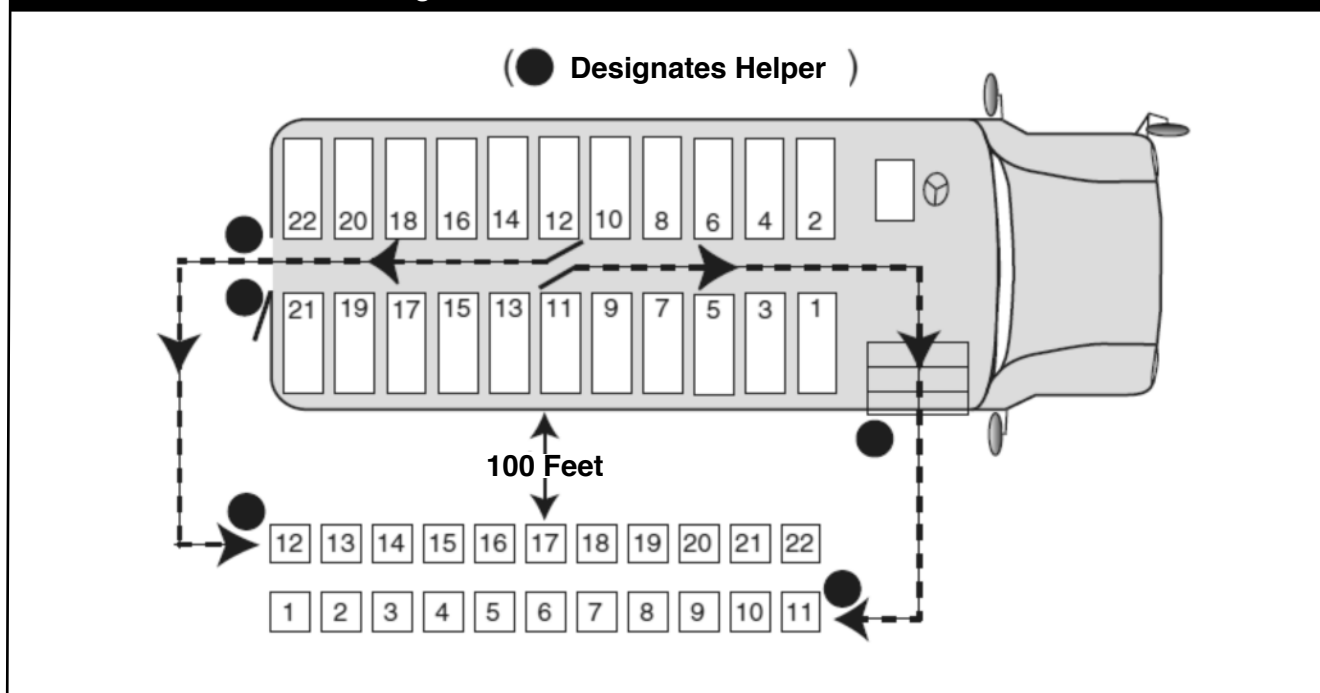

### Other Emergency Evacuation Procedures

In an actual emergency, it might be necessary to evacuate students through the bus windows or roof vent. Maintain order as much as possible in these situations and work to evacuate all passengers as quickly and safely as possible. Before leaving the bus, you should always check under all seats to make sure no students are on the floor. This applies to all types of evacuations. Also keep in mind the fastest way to evacuate the bus may be to have half the students exit through the front door and half through the rear, if feasible.



## USING EMERGENCY EQUIPMENT

When an emergency or crash happens, it's too late to learn how and where to use emergency equipment. All school buses are required to carry the following:

- First Aid Kit;
- Portable emergency warning devices (at least three portable emergency reflective triangles);
- Pry bar;
- Fire extinguisher;
- List of student names with their assigned pick-up and delivery times;
- Spare electrical fuses unless the bus has circuit breakers;
- Seat belt cutter (also known as a web cutter) is required in every school bus equipped with passenger seat belts; and
- Body Fluid Clean-Up Kit.

You should know the location and operation of this equipment. The use of emergency devices is discussed below. The First Aid Kit is discussed in Unit I.

### PORTABLE EMERGENCY WARNING DEVICES

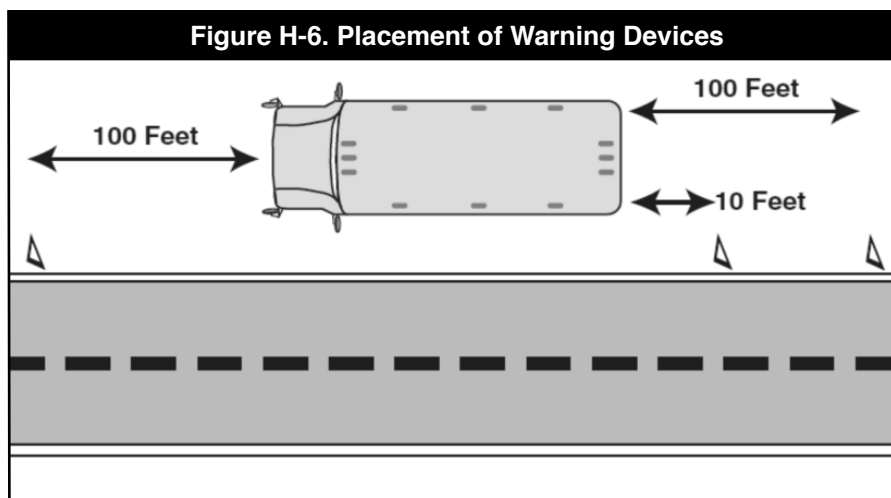

Buses in service are equipped with at least three triangular reflectors, which serve as warning devices as per Section 171.83 of Title 67. They are encased in a container in the driver's compartment. You will use three reflectors to warn oncoming vehicles of a disabled bus as per Section 167 of Title 67. Older buses may be equipped with round reflectors, red flags, or flares, which should be placed according to the

procedures given below for reflectors (see Figure H-6). Use of flares is not recommended unless placed by first responders.

1. **First Reflector** – Place the first reflector along the roadway side of the bus within 10 feet of the front or rear corner to mark the location of the bus.
2. **Second Reflector** – Place the second reflector about 100 feet behind the bus on the shoulder or lane you are stopped in. If there is a hill or curve preventing oncoming traffic from seeing the bus, place the reflector up to 500 feet behind the bus.
3. **Third Reflector** – Place the third reflector about 100 feet in front of the bus again using greater distances if conditions warrant.

## PRY BAR

The pry bar is located close to the driver's compartment as per Section 171.65 of Title 67. Use it to pry open doors, windows or other parts in the event of a crash where damage to the vehicle prevents easy exit by normal means.

## FIRE EXTINGUISHER

A portable fire extinguisher must be located in an accessible location in the driver's compartment of every school bus as per Section 171.51 of Title 67. Fire extinguishers work by either cooling the burning substance or by cutting off the supply of oxygen to it. Before using a fire extinguisher, make sure it is properly charged. A gauge is mounted at the top of the extinguisher to indicate it is fully charged. If the needle on the indicator stays in the charged area, the extinguisher is properly charged. If the needle is in the overcharged or undercharged areas, report it to your mechanic. This should be checked as part of your pre-trip inspection (refer to Unit E).

Only try to extinguish a fire, if you know what you are doing and it is safe. Your first priority is to evacuate all students and quickly get them somewhere safe. Do NOT waste your time fighting a fire when you need to get students off the bus.

If you do have to fight a fire, here are a few tips:

**Engine Fires** – With an engine fire, turn off the engine as soon as you can. DO NOT open the hood, if you can avoid it. Aim extinguishers through louvers, radiator or from the underside of the vehicle.

**Other Fires** – Only try to extinguish a fire, if you know what you are doing and it is safe:

- If possible, stand upwind from the burning material to prevent standing in smoke and heat;
- Do not walk into unburned material that could catch fire in a back flash and cause injury to you;
- When using the extinguisher, stay as far away from the fire as possible;
- Point the fire extinguisher at the base of the fire and use a sweeping motion. Do not aim the extinguisher at the flames;
- Position yourself upwind. Let the wind carry the extinguisher to the fire rather than carrying the flames to you; and
- Continue until whatever was burning has been cooled. Absence of smoke or flame does not mean the fire is completely out or cannot restart.

### To operate a fire extinguisher:

1. Remove it from the bracket;
2. Pull the safety pin by breaking the seal;
3. Hold it in an upright position;
4. Aim it at the base of the fire;
5. Squeeze the handle to discharge the extinguisher; and
6. Squeeze and release as necessary to control the fire.

The extinguisher will only last approximately eight seconds. No matter how much you use it, you must recharge the fire extinguisher or replace it with a substitute before the next run.

These instructions are applicable to most fire extinguishers, but you should check and be familiar with the instructions for the extinguisher on your bus. You should try to have actual hands-on use of the fire extinguisher during training.

## LIST OF STUDENT NAMES

Every bus must have a list of names for all students who ride the bus and the appropriate pick-up and delivery time for each student. This list can be used to account for the students in an emergency. Although not required, a seating chart for students on the bus is strongly recommended. It can also be helpful in emergency situations.

## SPARE ELECTRICAL FUSES

All buses should carry the proper spare electrical fuses in case a fuse is blown. The location of these varies by bus type and manufacturer. If the bus is equipped with circuit breakers, this is not necessary.

**Figure H-7. Seat Belt Cutter**



## SEAT BELT CUTTER

If your school bus is equipped with one, the seat belt cutter will be mounted in a visible location in the driver's compartment. See Figure H-7.

## OPTIONAL EQUIPMENT

Although not required, the following equipment may be carried on every school bus, especially those used to transport students with disabilities. This is not an all-inclusive list.

- Vomit odor absorbent, basin or pail (water in jug), sponge, and plastic bags;
- Tissues and paper towels;
- Plastic or other waterproof material for seats;
- Blankets and sheets to use as protection in cold weather;
- Sand or other substance for traction on ice; and
- Clean rags, gloves, or pads for motor check-up en route in case of suspected trouble.

These all must be securely fastened in the vehicle and not blocking the aisle way.

---

# SCHOOL BUS SECURITY

## WHY SCHOOL BUSES CAN BE TARGETS

1. They are relatively unprotected and vulnerable;
2. They have predictable routes and schedules;
3. They have the potential for a large number of casualties;
4. There are schools all over the nation;
5. They have unquestioned access to high-value destinations;
6. They represent an emotional target; and
7. The effects of a terrorist attack on school buses would be demoralizing.

## SCHOOL BUS DRIVERS

You, as a school bus driver, are the eyes, ears and protectors of your communities the same as the Neighborhood Watch Program. You know your routes and know what is usual and unusual. Therefore, you need to be informed on how to react in security-related situations.

1. Learn state and school district security guidelines;
2. Be aware of suspicious activity or behavior in areas around school buses, school bus facilities and schools;
3. Notice and report any unusual conditions of vehicles, those belonging to the school district and those vehicles that may enter into parking lots or facilities. Pay attention to suspicious people or vehicles in the school bus area outside a school or at school bus stops;
4. Be vigilant with respect to strange packages, items or substances, which are brought on or around school buses;
5. Know who your supervisory contacts are in the school district and have their phone numbers immediately available;
6. Recognize threats and how to properly handle them;
7. Learn emergency operating plans and procedures, and stay familiar with the operation of emergency equipment. For example, remove keys from the ignition when your bus is unattended;
8. Inspect your bus whenever you have left it unattended for any length of time; and
9. Keep a clean bus.

## CHARACTERISTICS OF SUSPICIOUS ITEMS

1. Items that are abandoned or hidden in an unusual place;
2. Items having leaking gas, vapor, odor, or suspicious substance, including excessive grease;
3. Any items containing exposed wires or timer;
4. Any items having an attached message with a threatening note or suspicious markings; and
5. Any canister, propane style tank, metal box, bottle, or out of place items.

## SCHOOL BUS SAFETY AND SECURITY CHECKLIST

You need to be vigilant when checking the following items in a pre-trip inspection, or anytime you have left the bus unattended for any length of time.

1. **Seats:** Look for lumps, bulges, damaged upholstery, and any suspicious packages on a seat;
2. **Floor Surface:** Look for modifications to material/unusual thickness;
3. **Passenger Compartment:** Smell for strange odors, raised floor, unusual welds, unusual items, or excessive weight;
4. **Exterior Surface:** Look for missing screws, unusual scratches, welds, signs of tampering, or recent paint;
5. **Undercarriage:** Look for items taped or attached to the frame or fresh undercoating;
6. **Engine Compartment:** Look for odd wires or liquids, unusual welds or new tape;
7. **Tires:** Look for unusual odor from air valve;
8. **Fenders:** Look for unusual thickness.

## IDENTIFYING SUSPICIOUS BEHAVIOR OR ACTIVITIES

Suspicious activities are anything you may feel is unusual or out of place. In addition, pay particular attention to the following:

1. Anyone appearing interested in school facilities, vehicles or their surroundings;
2. Anyone who has been sighted within a school, or school bus stop numerous times;
3. Anyone who has put a package in a public place and left quickly;
4. Anyone soliciting information on school facilities, buses or schedules;
5. Anyone taking pictures or videotaping areas of school bus facilities, schools or school bus stops;
6. Anyone looking lost or wandering around at school bus stops or school grounds, or anyone who seems to be somewhere they are not supposed to be;
7. Anyone showing disruptive or potentially distracting behavior; anyone showing an unusual interest in employees or students, the school or school bus locations; anyone wearing a uniform who appears to not be part of the setting;
8. Anyone wearing clothing that is not appropriate for the weather;
9. Any person possessing a weapon or dangerous item; and
10. Using a vehicle in a suspicious way (illegally parked, erratic driving, following).

### Reporting Suspicious Items and Unusual Activities

1. Remain alert and calm. Be as observant as possible, paying attention to the location of the item or device;
2. **IMMEDIATELY** report suspicious items and behavior to your dispatcher or local authorities. If you suspect a serious situation, call 911 right away;
3. Be able to report the location, color, year, make, model, and license plate number. Be sure to include the direction of any suspicious vehicles;
4. Never touch a suspicious item. You need to move as far away as possible and be aware you could be injured by flying glass or debris; and
5. **DO NOT USE** your radio or cell phone within 300 feet of the timer or device.

**YOU CANNOT IDENTIFY SUSPICIOUS BEHAVIOR BASED ON STEREOTYPES OF RACE, COLOR OR ETHNICITY.**

# HOSTAGE AWARENESS

## EMOTIONAL STAGES

If you find yourself in a hostage situation, you need to understand the feelings you will experience:

1. **Denial:** It is common for the victim to feel that “this can’t be”, “this is not happening to me,” or “it is just a joke.”
2. **Belief of immediate rescue:** Do not mislead yourself by thinking you will be rescued right away. It is to your advantage for the situation to take time to resolve. There is more of an opportunity for negotiation with the captor, which can lead to a peaceful resolution; and
3. **Loss of immediate reality:** Make a determined effort to stay focused. Avoid the temptation to let your thoughts center around your family/loved ones, and what might become of them if something should happen to you.

## THINGS “TO DO” IN A HOSTAGE SITUATION

1. **Bond with your captor:** Try to relate to them and build a relationship of understanding and sympathy;
2. **Be human:** Do not allow the captor to view you as an object instead of a person. Let your captor know you are a father or mother and there are people who depend on you, even if there are none. Avoid having your face covered. This dehumanizes a person;
3. **Take mental notes:** Without being obvious to the captor, note hair color, any scars, tattoos, or other identifying marks. Estimate height and weight;
4. **Expect to be arrested:** Law enforcement personnel will detain everyone until identification can be verified. Captors have exchanged clothing with hostages in an effort to escape. Your district will have officials on the scene to identify you;
5. **Keep a low profile:** Speak only when spoken to; do not initiate conversation;
6. **Think pleasant thoughts:** The incident could go on for hours. Avoid falling into depression, and remain confident you will be released;
7. **Remain strong for your students:** Even though you may have had a difficult time with the students all year, they will look to you for leadership in an emergency. If you maintain your composure, it will help them to do the same; and
8. **Remember you are a primary witness for investigators:** It is vital you write down everything that occurred during the hostage situation from onset to resolution. Do this as soon as possible while the events are still fresh in your mind. Do not speak to the media. Your district officials on the scene should shield them from you. Follow district policy regarding any future media contact.

## THINGS “NOT TO DO” IN A HOSTAGE SITUATION

1. **Do not make any threats:** Remember the captor is holding you against your will with some type of weapon. Do not behave, or speak in a manner that may be perceived by the captor as threatening;
2. **Do not stare or glance at your captor:** Keeping your eyes down will give the appearance of submission. Do not appear aggressive in your body language or facial expressions;
3. **Do not interfere:** Do not volunteer to assist the captor in any way. Do not interfere with the actions of the captor. For instance, he/she may be irritated with crying students and strike the students to quiet them. Remember you are being held at gun/knife point. Challenging the captor will increase the risk of further harm to yourself and/or the students;

4. **Do not negotiate for your own release:** Only the police will conduct negotiations. If you involve yourself, you may jeopardize a peaceful resolution to the hostage situation;
5. **Do not negotiate for the release of the students:** Do not make offers or promises of money or possessions in exchange for the release of the students. Only the police can negotiate; and
6. **Do not be arrogant:** Give the captor whatever they want. Do not resist. It could result in harm to yourself and/or the students.

## TIPS TO HELP YOU IN A HOSTAGE SITUATION

1. **Help keep the peace:** Prevent anyone from getting hurt. Consider your actions, so as not to put yourself or your passengers at risk;
2. **Be patient:** If you as the driver show patience, then your students will be more prone to follow your lead;
3. **Remain calm:** Try not to show fear, the students are looking to you as an example;
4. Know that 99 percent of all situations are resolved through negotiations: **Negotiations may take time, but remember time is on your side;**
5. **Do not be confrontational:** Don't be a hero, unnecessary harm to you or your passengers may result from your actions;
6. **Communicate:** If possible, try to make your location and situation known as soon as possible, if the hostage taker has not made contact. (Microphone keyed open);
7. **Be a good witness:** Make a mental picture of the hostage-taker(s) and any weapons. The driver preferring to stay with their students may not have the choice. This information may be vital for the police in determining the next move to help the remaining hostages;
8. **Attempt to get along:** You should cooperate with your captor and do as you are told. Comply with reasonable demands, but the key is not to offer help;
9. **If the police try to enter the bus:** Try to avoid giving away police positions or actions, by your actions or facial expressions. Captors could pick up on them. Be prepared for loud noise and follow instructions quickly;
10. **Help avoid getting caught in a hostage situation:** Report any suspicious person immediately. Do not wait for something to happen or get out of control;
11. **Call the police:** This is the best action a driver can do. Avoid becoming caught in the situation before it occurs; and
12. **Know your passengers:** Knowing your passengers and their needs can be vital in such emergencies. Their medical needs may allow for you to communicate with emergency medical personnel in a hostage situation.

**THIS PAGE INTENTIONALLY LEFT BLANK**



# UNIT I - STUDENT EMERGENCIES

INTRODUCTION . . . . .	I-2
MEDICAL LIABILITY . . . . .	I-3
The Good Samaritan Act. . . . .	I-3
FIRST AID PROCEDURES . . . . .	I-4
Setting Priorities . . . . .	I-4
Hazard Control . . . . .	I-4
Specific Hazards in an Emergency. . . . .	I-4
Obtaining Emergency Medical Assistance . . . . .	I-5
Use Responsible Helpers . . . . .	I-5
Treatment Priorities . . . . .	I-6
Performing Triage . . . . .	I-6
Treatment Procedures . . . . .	I-6
Seizures . . . . .	I-6
Fractures . . . . .	I-7
Allergic Reaction: Bites and Stings . . . . .	I-8
Allergic Reaction: Anaphylactic Shock . . . . .	I-8
Asthma . . . . .	I-9
Bites . . . . .	I-10
External Bleeding . . . . .	I-10
Internal Bleeding. . . . .	I-10
Choking . . . . .	I-11
Dehydration . . . . .	I-11
Diabetes . . . . .	I-12
Heat Stroke. . . . .	I-13
Hyperventilation . . . . .	I-13
Nose Bleeds . . . . .	I-13
Traumatic Brain Injury. . . . .	I-13
REPORT ALL INCIDENTS . . . . .	I-14
FIRST AID EQUIPMENT . . . . .	I-14
First Aid Kit . . . . .	I-14
Body Fluid Clean-Up Kit . . . . .	I-15
Cleaning Body Fluid Spills . . . . .	I-15

# UNIT I - STUDENT EMERGENCIES

## INTRODUCTION

Part of your responsibility as a school bus driver requires you to be prepared to act appropriately in emergency and crash situations. Your actions in these situations can mean the difference between life and death for one or more of the students on your bus. Contact your employer for a copy of your school district's guidelines and procedures for handling student emergencies.

**CONTAINED IN THIS UNIT ARE ONLY GENERAL GUIDELINES. YOU MUST FOLLOW YOUR LOCAL SCHOOL DISTRICT PROCEDURES AND GUIDELINES REGARDING RECEIVING FIRST AID TRAINING AND ADMINISTERING FIRST AID ON YOUR SCHOOL BUS.**

**FIRST AID AND EMERGENCY CARE ARE ONLY TEMPORARY STEPS TAKEN UNTIL MORE ADVANCED TREATMENT CAN BE OBTAINED, EITHER AT THE SCENE OF AN INCIDENT OR AT A HOSPITAL.**

You are not expected to be a paramedic; however, your company or district may require you to take First Aid courses, when available. Regardless, it is your responsibility to check the First-Aid Kit and Body Fluid Clean-Up Kit on a regular basis to assure it is present and sealed. Make sure to familiarize yourself with its contents and how each item is used. If you feel the medical emergency is beyond your knowledge, immediately call for emergency assistance.

First Aid is defined by the American National Red Cross as the immediate and temporary care given to the victims of crashes and sudden illness until the services of a physician can be obtained.

Emergency care is a process involving assessment, priority setting and continual reassessment. Other important aspects of emergency care include clearly describing what happened and knowing how to use the supplies and equipment used in performing this care.

Your top priority in the event of a crash or sudden illness is to keep the situation from getting worse until help arrives. You must perform only those emergency procedures for which you are properly trained, but remember your most important responsibility is to manage the overall scene until help arrives. In some situations, the time it takes for help to arrive may allow you to maintain the scene and provide emergency care to one or more injured persons. However, do not become so involved in specific problems you are unable to manage the entire scene. You need to learn procedures that will enable you to do the following:

- Control hazards at the scene;
- Evaluate injuries or illnesses;
- Enlist the help of others;
- Contact the emergency medical services system in your area;
- Maintain control of non-injured students during the crisis; and
- Control access to your students. Release students only to authorized persons. Keep students at the scene until evaluated.

While this unit provides a basic overview of emergency care procedures, local guidelines and procedures should always be followed.

# MEDICAL LIABILITY

## THE GOOD SAMARITAN ACT

Anyone who gives First Aid should be concerned about their liability when emergency care is necessary. The basic legal principle, which most directly applies to you as a bus driver is the Good Samaritan concept. In Pennsylvania and many other states, specific legislation has been passed to provide first-aiders with an exclusion from civil liability. A copy of Pennsylvania's Good Samaritan Act is reprinted here for your reference.

**Figure I-1. Pennsylvania Good Samaritan Act**

**PENNSYLVANIA GOOD SAMARITAN ACT  
PUBLIC LAW 697, NUMBER 122**

Section 8332, Nonmedical good Samaritan civil immunity.

- a) General Rule – Any person who renders emergency care, first aid or rescue at the scene of an emergency, or moves the person receiving such care, first aid and rescue to a hospital or other place of medical care shall not be liable to such person for any civil damages as a result of any acts or omissions in rendering the emergency care, first aid or rescue, or moving the person receiving the same to a hospital or other place of medical care, except any acts or omissions intentionally designed to harm or any grossly negligent acts or omissions which result in harm to the person receiving the emergency care, first aid or rescue or being moved to a hospital other place of medical care.
- b) Exceptions –
  - 1) This section shall not relieve a driver of an ambulance or other emergency or rescue vehicle from liability arising from operation or use of such vehicle.
  - 2) In order for any person to receive the benefit of the exemption from civil liability provided for in subsection (a), he shall be, at the time of rendering the emergency care, first aid or rescue or moving the person receiving emergency care, first aid or rescue to a hospital or other place of medical care, the holder of a current certificate evidencing the successful completion of a course in first aid, advanced life saving or basic life support sponsored by the American National Red Cross or the American Heart Association or an equivalent course of instruction approved by the Department of Health in consultation with a technical committee of the Pennsylvania Emergency Health Services Council and must be performing techniques and employing procedures consistent with the nature and level of the training for which the certificate has been issued.

**As you can see, the legal protection provided by Pennsylvania's Good Samaritan Act requires you to be currently certified in emergency care by the American National Red Cross, the American Heart Association or, in a similar course, approved by the Pennsylvania Department of Health.**

This unit is intended only to present some basic guidelines concerning your actions in a medical emergency; **IT IS NOT A FIRST-AID COURSE.** To meet the criteria described in the Good Samaritan Act, you need to successfully complete a course approved by the Pennsylvania Department of Health in consultation with the Pennsylvania Emergency Health Services Council (PEHSC) for Layperson and Good Samaritan.

The following organizations offer approved courses:

- American Academy of Pediatrics
- American Red Cross
- American Safety and Health Institute
- Carey Program
- Coyne First Aid, Inc.
- EMS Safety Services
- Emergency First Care Program
- Hart Fitness Consulting
- Life Emergency Safety Training
- Medic First Aid
- National Safety Council of Western PA
- National Ski Patrol
- US Army, Department of Combat Medic
- Western PA Safety Council

It is recommended that you also refer to Pennsylvania Department of Health EMS Information Bulletin #051.

This bulletin may be accessed via the following link:

[http://www.dsf.health.state.pa.us/health/lib/health/ems/bulletin/emsib\\_51\\_state\\_recognized\\_cpr\\_programs.pdf](http://www.dsf.health.state.pa.us/health/lib/health/ems/bulletin/emsib_51_state_recognized_cpr_programs.pdf)

## FIRST AID PROCEDURES

This section describes priority setting and procedures in emergency situations.

### SETTING PRIORITIES

First Aid and emergency care are techniques applied to one or more victims of a crash or illness. As a school bus driver, you cannot focus all of your attention solely on the ill or injured student(s). You must consider many other factors including:

- Hazards that could make the situation worse;
- Obtaining emergency medical assistance, if necessary;
- The seriousness of the injuries or illnesses;
- The safety of all healthy passengers; and
- Your own safety.

### Hazard Control

In Unit H (Crash and Emergency Procedures), you learned about many situations, which could affect the health and safety of everyone on your bus. Prevention and prompt action are the key elements in keeping minor emergencies from developing into serious problems. Remember what you have already learned about safely parking and evacuating the bus (if there is no other option), fire control and safety in maneuvering the bus.

### Specific Hazards in an Emergency

Be aware of these hazards:

- **Existing or Imminent Fire** – Few crashes result in fire or explosion, but you must always be alert to the presence of combustible fuel and ignition sources. Electrical fires may also start in the engine compartment due to faulty wiring or conditions other than a crash;
- **Hazardous Materials** – Identify any chemicals, vapors or other toxic substances, which present a danger to you and the others involved. Refer to Unit E on Preventive Maintenance, which identify a few of these materials found in the engine compartment;
- **Unsafe Site** – If an injury or crash occurs, be sure to park the bus in the safest position possible to avoid another crash. If at all possible, get the bus off of the roadway; and
- **Distractions** – If other circumstances don't prevent it, keep all passengers on the bus to make it easier to control them.

### **Obtaining Emergency Medical Assistance**

Once hazards have been identified and controlled to the best extent, you need to get an idea of the nature of the crash, a rough estimate of how many students or others are injured, and the relative seriousness of their injuries. You should do this quickly and call for help, so it can get to the scene as soon as possible. Just about every school bus should be equipped with a two-way radio, and most likely there will be a cellular phone in your bus (your own or a student's). You may need to use these to call for ambulance, rescue, fire, or police services.

If you don't have one of these in your bus or if they have been damaged in a crash, or if you are in a "dead spot" with no service, calling for help can be more difficult. Who is going to make the call? Where will the call be made and what will be said? Since you should avoid leaving the bus and its passengers, you may need to identify a responsible bystander to make a call for assistance. Sometimes it's a good idea to send two bystanders to call the emergency services system. This increases the chance an accurate call will be made. Sometimes the second person may provide a calming influence.

It may be helpful to use your cell phone to call 911 for help so that emergency personnel can pinpoint your location using GPS. When calling for help, give specific instructions concerning the items below. The following is a priority listing:

1. The exact location or precise directions to your location;
2. The exact nature of the problem, illness or injury (to the extent possible);
3. The number of people injured; and
4. A description of the type of vehicles involved (in the case of a crash).

### **Use Responsible Helpers**

It should be clear by now you have many areas of concern in an emergency situation. Adult bystanders and responsible students can be very important resources you may need to use. Knowing your passengers can be a big advantage, if you find yourself in a situation requiring immediate assistance. Make it a point to know the students on your bus. Selecting the right helper in an emergency is always difficult, but the more you know about your students, the better your chances are of making a good choice. **You should follow local School District procedures and guidelines when using student helpers in emergency situations. This is especially important when making the decision to send students to get assistance in an emergency. Do so only if local procedures and guidelines permit and the situation warrants it. Only in EXTREME EMERGENCIES should older responsible students be sent for help.**

Never send an elementary school student. You should also consider sending two students, rather than just one. This will increase their safety and security, they can support each other, and the chances of accurate information being passed on are increased. Ambulance crews often need the help of bystanders, so it is reasonable to think you might need help, too.

### Treatment Priorities

Once help has been summoned, assess the injuries or illnesses of each student. **YOU MUST FOLLOW YOUR LOCAL SCHOOL DISTRICT PROCEDURES AND GUIDELINES REGARDING RECEIVING FIRST AID TRAINING AND ADMINISTERING FIRST AID ON YOUR SCHOOL BUS. Keep in mind, provisions of the Good Samaritan Act may not apply if you are not certified through one of the previously mentioned courses.**

You will find two situations where it is necessary to help set treatment priorities:

- When you have one student with more than one injury, the injury treated first may be important; and
- When you have more than one student injured, you must select the order in which you can begin to help everyone in need. You must be organized and do one thing at a time.

### Performing Triage

In either case, you need to evaluate all injuries or illnesses quickly to determine where help is needed most. This process is called triage and is necessary in evaluating multiple problems in one individual or in evaluating multiple injured/ill persons. After a brief evaluation of each injury or illness, you can decide what to do first.

While performing triage, it is important you do not treat any injury until you have found all problems requiring help. If more than two or three students are injured, you should spend no more than 15 or 20 seconds in the evaluation of each injured person.

**DON'T FORGET TO CALL YOUR SUPERVISOR/DISPATCHER TO REPORT ALL INCIDENTS.** Use your best judgment when following local school district procedures and guidelines. In general, if injuries are minor, treat them yourself; when in doubt, call. If they are major, get emergency medical help. The following procedures should help you recognize issues and provide you with some basic procedures to follow. Remember, reporting incidents is important from a liability point of view as well.

## TREATMENT PROCEDURES

**Contact your employer for a copy of your school district's policies and procedures for handling student emergencies and your role in treatment. WHAT IS CONTAINED IN THE FOLLOWING SECTION ARE ONLY GENERAL GUIDELINES. YOU MUST FOLLOW YOUR LOCAL SCHOOL DISTRICT PROCEDURES AND GUIDELINES REGARDING RECEIVING FIRST AID TRAINING AND ADMINISTERING FIRST AID ON YOUR SCHOOL BUS.**

### Seizures

Seizures often are a symptom of a variety of central nervous system problems including epilepsy. There are several levels of seizure activity, but the type of seizure most important to you is when the student becomes unconscious. In addition to losing consciousness, the muscles of the person experiencing the seizure alternately flex and contract. This creates the jerking, sometimes violent, motion often described as "fits."

Your main concern is to maintain an open airway so the student can breathe and to protect the student from injuring themselves or others around them. If a student has a seizure, allow it to run its course and perform the following steps:

1. Lay the student down if they are not already on the floor;
2. Protect them from injury as much as possible by moving any possible objects the student could injure themselves on, and cushion their head;
3. Monitor their airway and position their body to permit the adequate exchange of air; and
4. Do not put fingers or other objects in the student's mouth during a seizure.

Most seizures are brief and may only last a minute or two. After the seizure is over, check their breathing if they are still unconscious.

When consciousness returns after a seizure, the student may be quite confused and disoriented. Be very considerate of their emotional state by providing as quiet and private a recovery environment as possible, given the circumstances. It is important to manage the other students around them.

After the seizure, always call your dispatcher. They will help determine whether further medical treatment is necessary. If the student has a history of seizures, they may be quite familiar with their own seizures and post seizure behaviors and may be able to help you.

### **Fractures**

Any break or crack in a bone is defined as a fracture. While fractures may cause other complications like bleeding and shock, any fracture by itself is not a life threatening emergency. The location of a fractured bone may complicate other important body functions like breathing. When any part of the spine is fractured, there is a danger of paralysis as a result of associated spinal cord damage.

If you see any of the following signs or symptoms, suspect the underlying bone might be fractured:

- Pain at the site of injury;
- Pain on movement;
- Swelling;
- Discoloration; and
- Crooked or misaligned bones.

Remember, even if someone can walk on an injured ankle or move an injured arm, a bone may still be fractured. The only sure way to determine if a bone is fractured is to X-ray the area of injury and to have the X-ray and the injury evaluated by a physician.

If you suspect a fracture of a bone, which makes it difficult or impossible for the individual to move, always call your dispatcher and 911 for emergency medical help. Without proper training and splint materials, your options are limited until further help arrives.

Since fractures are not generally life threatening, you have time to take control of the situation and to keep it from worsening. The basic objective of fracture care is to prevent the movement of joints above and below a fracture site. In most cases, you don't need splint materials to accomplish this, as long as you do not have to move the injured person. If help is on the way and the injured person is in a safe location, there is no immediate threat to life and no reason to move them.

If there is great urgency to move an injured student, as in the case of a fire, drag them along the long axis of their body. Pull the student by their outstretched hands or shoulders. If possible, place the injured person on a coat or blanket to make dragging him or her easier.

### Allergic Reaction: Bites and Stings

Bites and stings are treated as ingested poisons and can result in allergic reactions. Snakes, bees, spiders and wasps are some of the creatures that can bite or sting a student. These bites and stings can sometimes cause violent reactions in some students who may be allergic to them.

#### 1. Signs and symptoms:

- Puncture marks;
- Anxiety;
- Pale, cool skin with progressive onset of sweating;
- Rapid, weak pulse;
- Rapid, shallow breathing or breathing difficulties;
- Difficulty swallowing and speaking;
- Blurred vision;
- Abdominal pain;
- Nausea and/or vomiting;
- Headache;
- Intense pain at site of bite; and
- Localized redness and swelling.

#### 2. Care and treatment:

- Apply direct pressure over bitten area;
- Find out if the student has any allergies to stings or bites; and
- Use cold compress, if available, to reduce swelling.

### Allergic Reaction: Anaphylactic Shock

There are many types of shock, caused by a variety of circumstances ranging from emotional crisis to massive blood loss. One of the most unusual and fast-acting types of shock is the type occurring after an extremely allergic reaction. This type of shock is called anaphylactic shock and is commonly caused by bee stings.

If a student experiences an allergic reaction of any kind, it may quickly turn into a life threatening emergency. Anaphylactic shock can cause, within minutes, swelling in the airway to a degree an individual will not be able to breathe. The only way this condition can be corrected is through medication. Many seriously allergic people always carry their own medication with them. If this medication is not present, you must do everything possible to see the allergic person immediately gets to an emergency department or to paramedics. A few minutes may mean the difference between life and death. Learn local procedures and guidelines regarding what to do in the case of allergic reactions.

One method of treating anaphylaxis is injection of epinephrine using an autoinjector. Each school district and employer should have their own procedures and guidelines on your role in the use of an autoinjector – if you don't know your district/employer's procedures and guidelines, ask. What you CAN do is the following:

- Know all appropriate emergency numbers to call and request an Advanced Life Support Unit, if a reaction occurs;
- Use those numbers as quickly as possible, if you have not been trained on the use of an autoinjector or it is not within your district's procedures and guidelines for drivers to use them;
- Consider having the food-allergic child sit near the driver;
- Enforce the "no food on the bus" policy;
- If you have received training, know which children carry an autoinjector and where they carry it; and
- Consider working with your school district to implement an epinephrine hand-off system. Some parents pass the epinephrine to the driver who gives it to the school nurse once the bus arrives at school. The process is reversed for the ride home in the afternoon. CAUTION NOTE: Due to the number of hand-offs and people involved in this process, there is a greater risk of leaving the epinephrine either at school or on the bus.



Anaphylactic shock is somewhat unusual as compared to most other shock conditions you may encounter. Most shock conditions are more gradual in their onset and should be anticipated in all injuries. Listen to your students, if they warn you of an onset of symptoms. By being aware shock may develop; you may be able to prevent it before you see clear signs or symptoms. In summary:

**1. Signs and symptoms:**

- Itching;
- Red, raised, blotchy skin (hives);
- Wheezing;
- Confusion;
- Weakness;
- Pale color;
- Unconsciousness;
- Unable to speak more than one or two words;
- Sitting straight up or with hands on knees;
- Gasping for breath;
- Pursing lips to breathe; and
- Using neck muscles to take breaths.

**2. Care and treatment:**

- Call your dispatcher and report the situation;
- Call 911 immediately; and
- If your district procedures and guidelines allow, you are qualified and you have received training administer epinephrine.

**Asthma**

Asthma is a respiratory condition in which the student suffers constricted passages in the lower airway and it becomes progressively more difficult to breathe. Asthma can be a life threatening condition that may develop suddenly, or over several days.

Students with asthma are subject to unexpected severe attacks. Minor respiratory infections such as colds, flu and seasonal changes can cause the condition to worsen.

**1. Signs and symptoms:**

- Pale, cool, clammy skin;
- Shortness of breath, using all the chest and diaphragm muscles to breathe;
- Wheezing-a high pitched raspy sound when breathing;
- Anxiety, exhaustion, a rapid or weak pulse; and
- Severe asthma attack-collapse, leading to eventual respiratory arrest.

**2. Care and treatment:**

- Call your dispatcher and report the situation;
- Sit the student comfortably upright;
- Be calm and reassuring;
- Assist the student with locating their inhaler and allow them to use inhaler, if they are able; and
- Know and follow your school district procedures and guidelines!

**Bites**

Bites from other children are one of the most common First-Aid problems on a bus. For care and treatment:

1. Clean bite with antiseptic wipe and place a band aid on the bite; and
2. Report biting incident to your supervisor.

**External Bleeding**

After a serious incident like a crash, there are several types of bleeding that can occur. External bleeding is associated with wounds caused by cutting, perforating or tearing the skin. Serious wounds involve damage to blood vessels.

**1. Types of wounds:**

- **An incision** – is the type of wound made by “slicing” with a sharp knife or sharp piece of metal;
- **A laceration** – is a deep wound with associated loss of tissue;
- **An abrasion** – is a wound where the skin layers have been scraped off;
- **Puncture sore** – wounds are perforations, and may be due to an object like a pencil; and
- **Amputation** – is the loss of a limb by trauma.

**2. Care and treatment:**

- Make sure you have called your dispatcher and emergency medical personnel for serious wounds;
- Use universal precautions to protect yourself from bloodborne pathogens;
- Apply pressure to the wound to stop bleeding by using a sterile bandage; and
- Raise and support the injured part above the level of the heart. Elevation of an injured limb forces the blood to flow to the heart and keeps the blood from pooling in the lower part of the affected limb.

**Internal Bleeding**

Internal bleeding can be visible or concealed, and may occur after a crash. If there is no evidence of bleeding, this can be very serious and medical attention is required immediately.

- Visible internal bleeding: Self evident;
- Bleeding in the lungs: Frothy, bright red blood coughed up by the student; and
- Bleeding in the stomach: May look like dark coffee grounds or red blood in vomit.

**1. Signs and symptoms (if none of the above are present):**

- Pale, cool, clammy skin;
- Thirst;
- Rapid, weak pulse;
- Rapid, shallow breathing;
- Guarding of the abdomen, in fetal position;
- Pain or discomfort;
- Nausea and/or vomiting; and
- Swelling.

**2. Care and treatment:**

- Get expert medical help.
- If you can, position the student on his/her back; elevate legs, if possible;
- Give nothing by mouth.

**Choking**

Younger children often put things in their mouth, which may result in choking. The first sign may be coughing. Coughing with an object in the airway will generally dislodge it. **If you have a student who is choking, do not slap them on the back.**

**1. Signs and symptoms:**

- Difficulty or absence of breathing;
- Inability to speak or cough;
- Agitation and distress – grabbing the throat and eventual collapse.

**2. Care and treatment:**

- Check mouth and clear any obstructions that may have come loose.
- Stand behind the student and wrap your arms around the student's waist.
- Make a fist with one hand.
- Place the thumb side of the fist against the student's abdomen in the midline and slightly above the navel.
- Grasp the fist with the other hand and press the fist into the student's abdomen with a quick upward thrust.
- Each new abdominal thrust should be a separate and distinct movement.
- Repeat thrusts until student expels the obstruction.

**Dehydration**

Dehydration is a condition caused by the loss of fluids from perspiration and prolonged exposure to heat and humidity. Sometimes a student may be dehydrated on your bus, especially in your afternoon runs when students are returning home and/or returning from field trips. When fluid loss exceeds input through drinking, dehydration occurs. Prolonged dehydration will lead to shock and could be fatal.

**1. Signs and symptoms:**

- Pale, cool, clammy skin;
- Rapid breathing;
- Profuse and prolonged sweating;
- Thirst;
- Loss of skin elasticity;
- Sunken eyes in children.

**2. Care and treatment:**

- Give cool water to drink, if available.

## Diabetes

Diabetes is a condition caused by an imbalance of sugar or glucose in the blood. Because all human cells require sugars as food, the body takes in complex sugars in a normal diet. So the body's cells can use these sugars, the body, through an organ called the pancreas, secretes a protein hormone called insulin, which attaches to the sugars. This allows the cells to recognize the sugars as food and absorb the necessary glucose. Unfortunately, this condition is becoming more and more prevalent among school-aged children. Students with Type 1 diabetes and some students with Type 2 diabetes require insulin to survive. It is not expected that you check students' blood glucose levels or administer insulin or glucagon, but you may be able to recognize students for symptoms of high and low blood glucose, and assist the student in an emergency.

Understand and be aware that although hypoglycemia normally occurs at the end of the day, it may happen at the beginning of the day, if the student has not eaten breakfast.

### 1. Signs and Symptoms:

- Hot, dry skin;
- Smell of acetone (nail polish remover) on the breath;
- Drowsiness or change in mood;
- Unconsciousness, progressing to coma;
- Profuse sweating;
- Grayish skin color;
- Hunger;
- Confused or aggressive behavior;
- Rapid pulse;
- May appear drunk;
- Seizures.

### 2. Care and treatment:

- If conscious, give sweet drink, if available (avoid diet sodas).
- Repeat, if student responds.
- Assist with medication and encourage ingestion of food high in carbohydrates.
- **DO NOT** attempt to give an insulin injection.
- At the beginning of the school year, identify any students on the bus who have diabetes, if possible.
- Sometimes you will be provided a copy of the student's Quick Reference Emergency Plan, which a parent or school nurse may have. This can contain important treatment information that can help a student in distress. Keep it on the bus in a known, yet secure, place, and work with your school district to make sure substitute drivers know about the plan.
- Be aware of where the students with diabetes normally keep their supplies.
- Treat the student with diabetes the same as other students, except to respond to medical needs and perhaps allowing them to eat snacks on the bus.
- Provide input to the student's school health team when requested.
- Communicate with the parents, school nurse and/or trained diabetes personnel regarding any concerns about the student.
- Respect the student's confidentiality and right to privacy.

**Heatstroke**

Heatstroke should not be confused with sunstroke. Sunstroke is a common ailment suffered by those who remain in the sun too long. Heatstroke is potentially fatal. The body's temperature regulation center in the brain has been rendered inoperable, and the temperature continually rises, causing eventual brain damage. Be aware of this on your bus runs in warmer weather, especially in the afternoon.

**1. Signs and symptoms:**

- Flushed, hot, dry skin;
- The student has stopped sweating;
- Rapid pulse, gradually weakening;
- Irrational or aggressive behavior;
- Staggering;
- Fatigue;
- Visual disturbances, headache, vomiting; and
- Collapse and seizures.

**2. Care and treatment:**

- Give fluids and water, if the person is conscious.
- Cool the student as much as possible.

**Hyperventilation**

Hyperventilation can be stress related or deliberate over-breathing. By deliberately over-breathing, the student causes the blood's carbon dioxide level to fall, resulting in distressing symptoms. There have been incidents of students hyperventilating on purpose for the "rush." Be aware of this behavior, and put a stop to it.

**1. Signs and symptoms:**

- Rapid respirations;
- Rapid pulse;
- Shortness of breath;
- Pressure, tightness or pain across the chest;
- Anxiety;
- Blurred vision;
- Tingling in fingers and toes;
- Hand and finger spasms;
- Fainting.

**2. Care and treatment:**

- Reassurance;
- Remove the cause of anxiety, if possible;
- If the student has fainted, lay the student down with their legs elevated.

**Nose Bleeds**

When a student's nose bleeds, there are some immediate things you can do to stop the bleeding: Keep the trunk of the body so it is higher than the heart, tilt the head forward, and compress the nostril for five to 10 minutes.

**Traumatic Brain Injury or Concussion**

Traumatic brain injury is characterized as either closed head injury or open head injury. Open head injuries occur when the skull has been fractured or the tissue around the brain has been pierced. Closed head injuries or concussions, which can be harder to detect, do not pierce the tissue around the brain or fracture the skull. Closed head injuries or concussions generally occur from an impact to the head.

Traumatic brain injuries or concussions can result from a sudden jarring or impact within the bus, regardless of whether or not the student strikes their head. However, it is of particular concern if a student hits his or her head during the jarring or impact. Any time a student hits his or her head, traumatic brain injury or a

concussion may occur, such as in a crash, or if the bus has run over a curb or large rock, or has been on an extra bumpy road and has been violently jarred.

Depending on the severity of the injury, damage to the brain can be mild, moderate or severe. A key point is that a person suffering from traumatic brain injury may show no symptoms at all, but if symptoms are present, they can vary and may include headache, slurred speech, dilated pupils, hearing loss, seizures, paralysis, loss of consciousness, memory loss, coma, nausea or vomiting, dizziness, confusion and blurred vision.

If the bus you are driving has been impacted or intensely jarred, it is important to stop the bus in a position of safety, ask the students if anyone was hurt and if anyone hit their head during the incident. Any time a student indicates to you or a fellow student that they hit their head on the bus, call for medical assistance. Do not move the student or your bus -- unless you need to move your bus to a safer location -- to prevent possible further injury to the student, as traumatic brain injury, no matter how slight, could have serious, life-altering effects. It is extremely important not to ignore instances where a student has hit his or her head while on your bus.

## REPORT ALL INCIDENTS

**It is critical to report all medical problems, which occur on your bus to the proper authorities as dictated by local procedures and guidelines.** Reporting incidents is important from a liability point of view because students may fail to tell the school nurse or their parents of problems requiring attention. Know your students and any pre-existing problems, which they might have so you may be better prepared to deal with them. Careful observation of your students may indicate the presence of medical problems of which you have not been informed. While many parents will inform you of their child's medical problems, others wish to keep such information confidential. Follow local procedures and guidelines when trying to obtain information about student medical conditions. When possible, inform substitute drivers of any medical problems of students on your route, but keep confidentiality in mind. Work with your supervisor regarding the release of information.

## FIRST-AID EQUIPMENT

First-aid supplies and equipment are important in providing the best care possible. Remember to follow your local school district procedures and guidelines regarding administering first aid on your school bus.

### FIRST-AID KIT

The First-Aid Kit on your bus should be removable and supplied with anything you might need in an emergency. The contents of your First-Aid Kit may vary according to local procedures and guidelines; however, current state regulations (Section 171.52 of Title 67) require that the First-Aid Kit on a school bus must contain at least 10 items including:

1. Two, 1-inch x 2 1/2-yard rolls of non-latex adhesive tape;
2. 24 sterile gauze pads, 3 inches x 3 inches;
3. 100, 3/4 inch x 3 inches adhesive bandages;
4. Eight, 2-inch bandage compresses;
5. Ten, 3-inch bandage compresses;
6. Two, 2 inches x 6 yards sterile gauze roller bandages;
7. Two, non-sterile triangular bandages approximately 40 inches x 36 inches x 54 inches with two safety pins;



8. Three sterile gauze pads, 36 inches x 36 inches;
9. Three sterile eye pads;
10. One pair rounded end scissors.

In addition to the items above, the First Aid Kit or Body Fluid Clean-up Kit (discussed below) must contain:

1. One pair of non-latex surgical gloves;
2. One mouth barrier.

The kit should be mounted in accordance with manufacturer's instructions in full view and in an accessible place in the driver's compartment. Its location should be clearly marked, and you should check its contents often. The pre-trip inspection described in Unit E (Preventive Maintenance) calls for a daily check of the First Aid Kit. It is your responsibility to replace any of the contents immediately after you use them or after noticing something has been removed. Consult your supervisor about procedures for obtaining new First Aid supplies.

**Figure I-3. Body Fluid Clean Up Kit**



### **BODY FLUID CLEAN UP KIT**

Every school bus is required to have a removable and moisture proof Body Fluid Clean Up Kit. It must be securely placed or mounted in an easily accessible location and labeled as a Body Fluid Clean Up Kit. Take all steps to protect yourself from exposure. Keep in mind that you are not automatically infected, if you are exposed to blood or other bodily fluids; the amount needs to be large enough to overcome your immune system. If you feel you have been exposed, consult a medical professional.

### **Cleaning Body Fluid Spills**

Thorough hand washing is the best tool to prevent the spread of infectious diseases. When cleaning up body fluid spills, you need to do the following:

1. Always wear disposable gloves. You need to wear disposable gloves whenever you might come in contact with blood or potentially infectious materials. If gloves are not available, or unanticipated contact occurs, hands and other affected areas should be washed with soap and running warm water immediately after contact. If not possible, wipe your hands thoroughly with the germicidal wipe provided in the Body Fluid Clean Up Kit.
2. Small spills can be cleaned with paper towels or tissues. After the bodily fluid is removed, use clean paper towels, soap and water or disinfectant wash to clean the area. For larger spills you can use the packet of solution to solidify body fluids in your Body Fluid Clean Up Kit.
3. Remove gloves and place into the plastic bag with the waste and other cleaning materials. Upon returning to the bus garage, remove the plastic bag and dispose in accordance with school district procedures and guidelines.
4. The driver must wash their hands with soap and running warm water for at least 30 seconds.
5. It is always a good idea to carry hand sanitizer, extra gloves and band aids as long as they are properly secured in the bus.

**WHEN HANDLING BODY FLUIDS, ALWAYS REMEMBER TO PROTECT YOURSELF!**









# **PENNSYLVANIA SCHOOL BUS DRIVER'S MANUAL**

**Pennsylvania Department of Transportation  
Harrisburg, PA**