

## JRC SCIENTIFIC AND POLICY REPORTS

# Guidance for European Structural Design of Glass Components

Support to the implementation, harmonization  
and further development of the Eurocodes

### AUTHORS:

M. Feldmann, R. Kasper  
and

B. Abeln, P. Cruz, J. Belis, J. Beyer, J. Colvin, F. Ensslen, M. Eliasova, L. Galuppi,  
A. Geßler, C. Grenier, A. Haese, H. Hoegner, R. Kruijs, K. Langosch, Ch. Louter,  
G. Manara, T. Morgan, J. Neugebauer, V. Rajcic, G. Royer-Carfagni, J.  
Schneider, S. Schula, G. Siebert, Z. Sulcova, F. Wellershoff, R. Zarnic

### EDITORS

S. Dimova, A. Pinto, M. Feldmann, S. Denton

2014



European Commission  
Joint Research Centre  
Institute for the Protection and Security of the Citizen

Contact information

Silvia Dimova

Address: Joint Research Centre, Via Enrico Fermi 2749, TP 480, 21027 Ispra (VA), Italy

E-mail: [silvia.dimova@jrc.ec.europa.eu](mailto:silvia.dimova@jrc.ec.europa.eu)

Tel.: +39 0332 78 9063

Fax: +39 0332 78 9049

<http://eurocodes.jrc.ec.europa.eu/>

<http://elsa.jrc.ec.europa.eu/>

This publication is a Scientific and Policy Report by the Joint Research Centre of the European Commission.

Legal Notice

Neither the European Commission nor any person acting on behalf of the Commission is responsible for the use which might be made of this publication.

Europe Direct is a service to help you find answers to your questions about the European Union

Free phone number (\*): 00 800 6 7 8 9 10 11

(\*): Certain mobile telephone operators do not allow access to 00 800 numbers or these calls may be billed.

A great deal of additional information on the European Union is available on the Internet.

It can be accessed through the Europa server <http://europa.eu/>.

JRC 86637

EUR 26439 EN

~~ISBN~~ 978-92-79-35094-8 (print)

~~ISSN~~ 1018-5593 (print)

doi: 10.2788/5523

Luxembourg: Publications Office of the European Union, 2014

© European Union, 2014

Reproduction is authorised provided the source is acknowledged.

Printed in Italy

## Foreword

The **construction sector** is of strategic importance to the EU as it delivers the buildings and infrastructure needed by the rest of the economy and society. It represents more than **10% of EU GDP and more than 50% of fixed capital formation**. It is the largest single economic activity and it is the biggest industrial employer in Europe. The sector employs directly almost 20 million people. Construction is a key element not only for the implementation of the **Single Market**, but also for other construction relevant EU Policies, e.g. **Sustainability, Environment and Energy**, since 40-45% of Europe's energy consumption stems from buildings with a further 5-10% being used in processing and transport of construction products and components.

The **EN Eurocodes** are a set of **European standards** which provide common rules for the design of construction works, to check their strength and stability against live extreme loads such as fire and earthquakes. In line with the EU's strategy for smart, sustainable and inclusive growth (EU2020), **Standardization** plays an important part in supporting the industrial policy for the globalization era. The improvement of the competition in EU markets through the adoption of the Eurocodes is recognized in the "Strategy for the sustainable competitiveness of the construction sector and its enterprises" - COM (2012)433, and they are distinguished as a tool for accelerating the process of convergence of different national and regional regulatory approaches.

With the publication of all the 58 Eurocodes Parts in 2007, the implementation in the European countries started in 2010 and now the process of their adoption internationally is gaining momentum. The Commission Recommendation of 11 December 2003 stresses the importance of training in the use of the Eurocodes, especially in engineering schools and as part of continuous professional development courses for engineers and technicians, which should be promoted both at national and international level. It is recommended to undertake research to facilitate the integration into the Eurocodes of the latest developments in scientific and technological knowledge.

In May 2010 **DG ENTR issued the Programming Mandate M/466 EN to CEN concerning the future work on the Structural Eurocodes**. The purpose of the Mandate was to initiate the process of further evolution of the Eurocode system. M/466 requested CEN to provide a programme for standardisation covering:

- Development of **new standards or new parts** of existing standards, e.g. a new construction material and corresponding design methods or a new calculation procedure;
- Incorporation of **new performance requirements and design methods** to achieve further harmonisation of the implementation of the existing standards.

Following the answer of CEN, in December 2012 DG ENTR issued the Mandate M/515 EN for detailed work programme for amending existing Eurocodes and extending the scope of structural Eurocodes. In May 2013 CEN replied to M/515 EN. Over 1000 experts from across Europe have been involved in the development and review of the document. The CEN/TC250 work programme encompasses all the requirements of M/515 EN, supplemented by requirements established through extensive consultation with industry and other stakeholders. Publishing of the complete set of new standards is expected by 2019.

**The standardisation work programme of CEN/TC250 envisages that the new pre-normative documents will first be published as JRC Scientific and Policy Reports, before their publication as CEN Technical Specifications.** After a period for trial use and commenting, CEN/TC 250 will decide whether the Technical Specifications should be converted into ENs.

This pre-normative document is published as a part of the JRC Report Series “Support to the implementation, harmonization and further development of the Eurocodes” and presents **Guidance for European Structural Design of Glass Components. It was developed by CEN/TC250 Working Group (WG) 3 on structural glass.** The purpose of its work is to develop structural design rules for glass components in a stepwise procedure that finally should result into a new Eurocode on design of structural glass.

This JRC Scientific and Policy Report presents the scientific and technical background of the design of glass components, basing on a complete state-of-the-art overview of the existing national codes or rules, and on the most recent scientific knowledge. It presents a harmonized European view on the contents and the technical rules of the future Eurocode on design of glass components.

**The editors and authors have sought to present useful and consistent information in this report. However, users of information contained in this report must satisfy themselves of its suitability for the purpose for which they intend to use it.**

The report is available to download from the “Eurocodes: Building the future” website (<http://eurocodes.jrc.ec.europa.eu>).

Ispra, December 2013

**Silvia Dimova and Artur Pinto**

*European Laboratory for Structural Assessment (ELSA)*

*Institute for the Protection and Security of the Citizen (IPSC)*

*Joint Research Centre (JRC)*

**Markus Feldmann**

*RWTH Aachen, Convenor of CEN/TC250 WG3*

**Steve Denton**

*Parsons Brinckerhoff, Chairman of TC250*

## Report Series “Support to the implementation, harmonization and further development of the Eurocodes”

In the light of the Commission Recommendation of 11 December 2003, DG JRC is collaborating with DG ENTR and CEN/TC250 “Structural Eurocodes”, and is publishing the Report Series “**Support to the implementation, harmonization and further development of the Eurocodes**” as JRC Scientific and Policy Reports. This Report Series includes, at present, the following types of reports:

1. **Policy support documents**, resulting from the work of the JRC in cooperation with partners and stakeholders on “Support to the implementation, promotion and further development of the Eurocodes and other standards for the building sector”;
2. **Technical documents**, facilitating the implementation and use of the Eurocodes and containing information and practical examples (Worked Examples) on the use of the Eurocodes and covering the design of structures or its parts (e.g. the technical reports containing the practical examples presented in the workshop on the Eurocodes with worked examples organized by the JRC);
3. **Pre-normative documents**, resulting from the works of the CEN/TC250 and containing background information and/or first draft of proposed normative parts. These documents can be then converted to CEN technical specifications.
4. **Background documents**, providing approved background information on current Eurocode part. The publication of the document is at the request of the relevant CEN/TC250 Sub-Committee;
5. **Scientific/Technical information documents**, containing additional, non-contradictory information on current Eurocode part, which may facilitate its implementation and use, or preliminary results from pre-normative work and other studies, which may be used in future revisions and further developments of the standards. The authors are various stakeholders involved in Eurocodes process and the publication of these documents is authorized by relevant CEN/TC250 Sub-Committee or Working Group.

**Editorial work** for this Report Series is **performed by the JRC** together with partners and stakeholders, when appropriate. The publication of the reports type 3, 4 and 5 is made after approval for publication by CEN/TC250, or CEN/TC250 Coordination Group, or the relevant Sub-Committee or Working Group.

The publication of these reports by the JRC serves the purpose of implementation, further harmonization and development of the Eurocodes. However, it is noted that neither the Commission nor CEN are obliged to follow or endorse any recommendation or result included in these reports in the European legislation or standardization processes.

The reports are available to download from the “Eurocodes: Building the future” website (<http://eurocodes.jrc.ec.europa.eu>).

## **Acknowledgements**

This report has been prepared for the development of a future European design standard on structural glass under the aegis of CEN/TC250. Both CEN/TC250 and JRC acknowledge the substantial contribution of the many international experts of CEN/TC250/WG3, CEN/TC129/WG8, COST Action TU0905 and others, who have supported the works by their essential input and reviews.

### **Markus Feldmann**

*RWTH Aachen, Chairman of CEN/TC250 WG3*

Reference of the front picture:

Pilkington Planar Glazing, St Thomas's Hospital, UK  
(c) ME Construction Ltd, Unit 3 Baden Place, Crosby Row, London, SE1 1YW  
(c) Suburbia Photography, 47 Mayflower Way, Farnham Common, Bucks, SL2 3UA

# Contents

1	Introduction and General .....	1
1.1	Establishing of a Eurocode on Structural Glass.....	1
1.2	Eurocode rules applicable to glass structures.....	3
1.3	Structuring of the Eurocode.....	6
2	Material properties.....	15
2.1	Glass.....	15
2.1.1	General .....	15
2.1.2	Characteristics of annealed glass.....	15
2.1.3	Toughened glass.....	20
2.1.4	Breakage pattern.....	21
2.1.5	Definition of the zones 1 to 4.....	23
2.1.6	Test methods according to EN 1288 .....	25
2.1.7	Statistical evaluation of the bending strength .....	27
2.1.8	Quality control by non-destructive methods, stress optics .....	28
2.2	Interlayer .....	28
2.2.1	General .....	28
2.2.2	Viscoelastic behaviour of interlayers .....	28
2.2.3	Determination of the viscoelastic behaviour with “small size” tests .....	29
2.2.4	Determination of the viscoelastic behaviour in the panel-torsion-test.....	30
2.2.5	Durability of PVB interlayer .....	33
2.2.6	Design shear modulus of PVB- interlayer in dependence of temperature and time during wind loading.....	34
3	Products .....	39
3.1	General .....	39
3.2	Float glass.....	40
3.2.1	General .....	40
3.2.2	Geometrical properties .....	40
3.2.3	Surface processing .....	41
3.2.4	Forming.....	41
3.3	Patterned glass .....	42
3.4	Wired glass .....	43
3.5	Drawn sheet glass.....	43
3.6	Thermally toughened glass (TTG).....	43
3.7	Heat strengthened glass (HSG) .....	46
3.8	Laminated and laminated safety glass .....	47

3.9	Thermally curved glass .....	50
3.10	Chemically strengthened glass.....	51
3.11	Insulating glass .....	51
3.12	Channel shaped glass.....	52
4	Principles and Basic Rules for the design of glass components and safety approach.....	55
4.1	General .....	55
4.2	Classification of structural elements of glass .....	61
4.3	Secondary structural elements: robustness and residual capacity.....	62
4.3.1	General .....	62
4.3.2	Composition and strength of the glass section .....	62
4.3.3	Supports and bearing concept.....	63
4.3.4	Failure scenario.....	63
4.3.5	Further general construction rules .....	65
4.4	Primary structural elements: glass-robustness and damage tolerance .....	66
4.5	Special loading situations .....	68
4.5.1	Seismic structures .....	68
4.5.2	Blast loads .....	70
4.6	Potential classification of glass components.....	74
5	Mechanical basics and verification approach for monolithic and laminated plates and beams .....	79
5.1	General .....	79
5.2	Linear and non-linear plate theory .....	79
5.3	Plates with monolithic sections of glass under transverse loading .....	80
5.4	Mechanical description of the viscoelastic behaviour of interlayers .....	81
5.5	Bending behaviour of laminated sections due to transversal or axial loading .....	83
5.6	Bending behaviour of laminated sections due to transversal loading without axial load .....	85
5.7	Post-glass breakage strength of laminated glass .....	88
5.8	Numerical analysis and experimental testing.....	89
6	Design of secondary structural glass components .....	93
6.1	Calculation of monolithic plates .....	93
6.2	Consideration of the shear bond of laminated glass panels.....	93
6.3	Insulating glass plates .....	94
6.4	Linearly supported glazing.....	98
6.5	Point fixed glazing .....	100
6.5.1	General .....	100
6.5.2	Clamping systems.....	101
6.5.3	Point fixings with drilled holes.....	102
6.5.4	Adhesively bonded point fixings .....	107
6.5.5	Embedded systems.....	108
6.6	Glass Floors.....	108



6.7	Horizontal Glazing accessible for maintenance .....	110
6.8	Retaining Glass Barriers and Glass Parapets.....	110
6.9	Cold bent glass .....	116
6.10	Glass in Photovoltaic applications (PV modules).....	117
6.11	Reinforced glass components with enhanced redundancy .....	118
7	Design of primary structural components.....	119
7.1	General.....	119
7.2	Shear panels.....	120
7.2.1	Buckling of shear panels with single point load introduction at the corners along the diagonal (corner loaded shear panels).....	120
7.2.2	Buckling of continuously supported shear panels .....	124
7.2.3	Influence of the connection stiffness.....	126
7.3	Beams with bending about the strong axis – Lateral torsional buckling .....	126
7.3.1	Monolithic sections.....	126
7.3.2	Lateral torsional buckling of glass beams with laminated cross sections .....	128
7.4	Columns.....	136
7.4.1	General .....	136
7.4.2	Consistent buckling curves for monolithic pane-like glass columns .....	137
7.4.3	Experimental tests of monolithic glass columns.....	140
7.4.4	Buckling of columns with laminated sections.....	143
7.4.5	Critical load of laminated bars under axial loads with blocked end slip .....	146
7.4.6	Interaction of axial loads with bending moments .....	150
7.4.7	Consideration of short term – long term loading effects on the stability .....	150
7.4.8	Conclusions .....	150
7.5	Beam-columns .....	151
7.6	Hybrid structures and hybrid glass components with enhanced pre- and post-failure performance .....	151
8	Joints and Connections .....	159
8.1	General.....	159
8.2	Bolted connections.....	159
8.2.1	Detailing of a structural bolted connection of bolts in shear in glass holes.....	160
8.2.2	Analytical verification of a bolted connection in glass .....	160
8.2.3	Elastic response of an in-plane loaded solid pane.....	161
8.2.4	Approximation and engineering formula .....	168
8.3	Friction Joints.....	169
8.4	Adhesive bonding.....	171
8.4.1	General .....	171
8.4.2	Types of adhesive .....	173
8.4.3	Present state of standardization .....	175
8.4.4	Current research .....	177

8.4.5	Proposals for the calculation .....	178
8.4.6	Future prospects .....	178
9	Concluding Remarks .....	181
10	References .....	183

# 1 Introduction and General

## 1.1 Establishing of a Eurocode on Structural Glass

In modern architecture and civil engineering Structural Glass has got more and more importance because of its transparency, filigran appearance and lightening functions. This can be seen by the variety and huge number of recent structural applications, ranging from simple glass barriers to glass elements with important primary functions like floors, columns or shear panels. With today's available products of glass (suitable for structural purposes) architects and civil engineers are able to design and erect innovative buildings [86].

However at present only national codes are available for the design of structural glass, and so far, despite of a considerable amount of scientific knowledge of the structural behaviour, these codes usually refer to secondary applications only and rarely to applications with primary structural function.

It was therefore the wish of the industry and the European Commission to launch the works on the codification of structural design of glass in order to

- Provide design techniques representing the latest state of the art and recognised research,
- Provide a common pool of design approaches, and
- Achieve a harmonized safety level, both ensuring a free trading of prefabricated structural glass elements.

For this reason a Working Group (WG) 3 on structural glass was created within CEN TC 250 "Structural Eurocodes" that is commissioned to elaborate corresponding design code. The specific purpose of these works of WG 3 is to develop structural design rules for glass components in a stepwise procedure that finally should result into a new Eurocode on the Design of Structural Glass.

In view of this, as the first step, the present Scientific and Policy Report has been prepared including proposals for rules for the design of glass or of what content future rules should be. It also contains a presentation of the scientific and technical background. As guidance it further gives a complete state-of-the-art overview related to the design of glass components.

The document also represents a European harmonized view of the technical contents that in a second step – after agreement with the Commission and the Member States – could be used as a basis for standardisation that will indicate necessities of the code up to code-like formulations of selected items. Further, as a kind of review it reflects and refers to the existing state of the art, existing national codes or rules and the latest scientific knowledge.

Figure 1-1 illustrates the European code environment for the preparation of the Scientific and Policy Report for Structural Glass with regard to the "three columns" of the European codification of structural issues:

- Specifications of structural material and products,
- Rules on structural design,
- Rules on execution and erecting of structures.

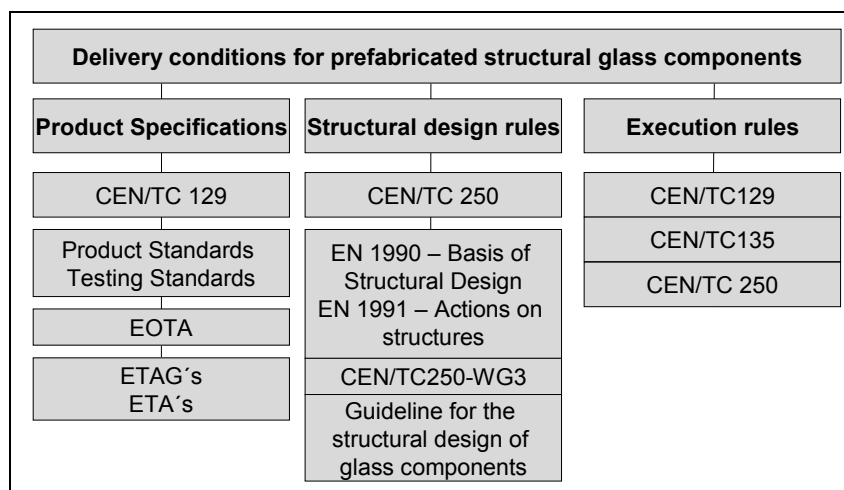


Figure 1-1 European code environment for the preparation of the Scientific and Policy Report for Structural Glass with regard to the “three columns” of codification

The governing standard gives the “Delivery conditions for prefabricated structural glass components” that refers to “Product Specifications”, “Structural Design rules” and “Execution rules” and is the reference standard for the compliance-assessment and CE-marking of prefabricated structural glass components.

“Product specifications” comprise both product- and testing standards as well as EOTA-Guidelines and ETA’s; they provide the product properties used in design. The reference from the design guidance to the supporting standards like product specifications and execution standards requires consistency that will be achieved by simultaneous work on these standards, for which cooperation is provided already in early stages of the drafting between CEN/TC 250, CEN/TC 129, CEN/TC 135 and EOTA.

Preliminary works that have been done so far are listed in Figure 1-2.

#### 1. JRC-Initiative (2007)

JRC-Report: Purpose and justification for new design standards regarding the use of glass products in civil engineering works

#### 2. CEN/TC250 – ASCE (2007)

Coordinated List of Contents

#### 3. CEN/TC50 – Medium-Term Strategy (2009)

CEN/TC250 – JRC-Report N798:

- Item 3.3.1 Structural Glass
- Annex B: Technical Guidance for the design of glass structures:
  - Part 1: Generic rules
  - Part 2-11: Particular applications

#### 4. European Commission: Programming Mandate M/466 (2010)

#### 5. CEN/TC250: Preparation of Standardisation Programme:

Working Procedure

Figure 1-2 Prior and preliminary works

The initial start of works on European design rules for glass-components took place in 2007 following a JRC-initiative, which included all stakeholders and resulted in a JRC-Report “Pur-

pose and justification for new design standards regarding the use of glass products in civil engineering works”, see Figure 1-3, addressed to the Commission.

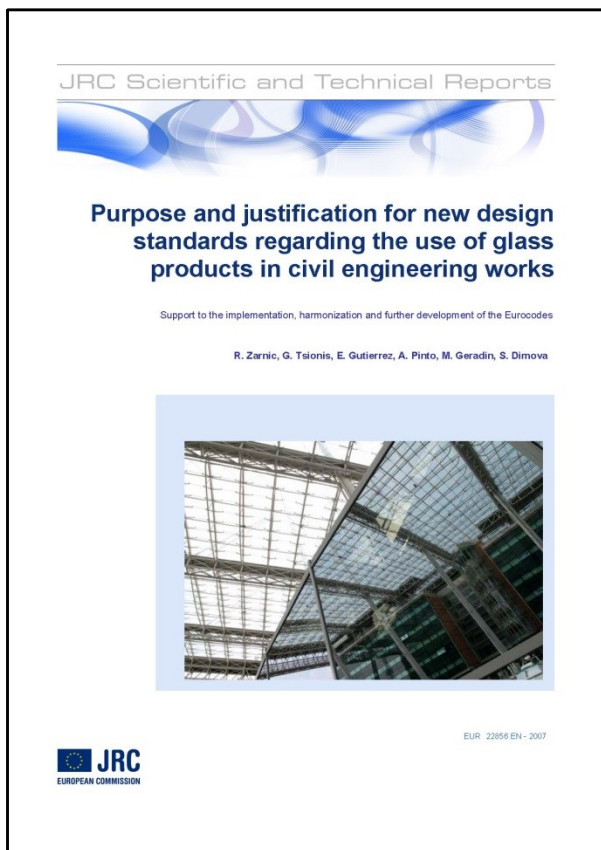


Figure 1-3 JRC-Report “Purpose and justification for new design standards regarding the use of glass products in civil engineering works” [86]

## 1.2 Eurocode rules applicable to glass structures

Necessary, also the Eurocode for the design of structural glass and its preceding scientific and policy report (SaP- report) should fit to the normative background of structural design in civil engineering to provide a harmonized level of safety throughout the different construction materials. In particular the general specifications of the basis of design (EN 1990) as well as those of the application of loads and their combinations should be considered. The question of “where” a structural glass design is located within the framework of the Eurocode system and what basic requirements in terms of loading, safety level and reliability are generally to be met will be discussed in the following.

The Eurocodes consist of the governing EN 1990 – Eurocode – Basis of Structural Design – which concretises the “Essential Requirements” by design principles and application rules and of EN 1991 – Eurocode 1 – Actions on structures and of EN 1992 – Eurocode 2 to EN 1999 – Eurocode 9 with design rules for concrete structures, steel structures, composite structures, timber structures, masonry structures, geotechnical design, design in seismic regions and aluminium structures, Figure 1-4.

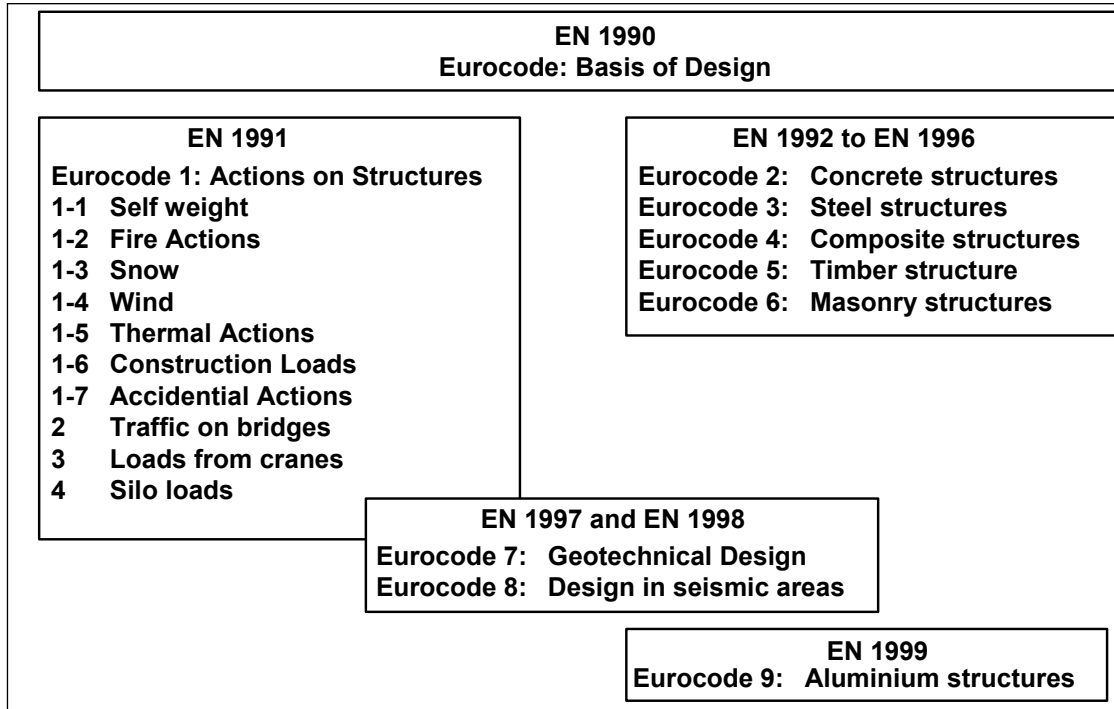


Figure 1-4 Survey of the existing Eurocodes, missing: Eurocode on Structural Glass

The Eurocodes are “living documents”; so far they do not yet contain design rules for glass structures though the design principles and application rules in EN 1990 apply also to such. An overview on further Eurocodes, suitable for glass and steel- glass structures is given in Figure 1-5.

EN 1990 – Eurocode: Basis of structural design			
EN 1991	Actions on structure	EN 13474	Design of glass components
Part 1-1	Self weight and imposed loads on floors and roofs	EN 1993	Design of steel structures
Part 1-2	Fire actions	Part 1-1	Basis and buildings
Part 1-3	Snow	Part 1-4	Stainless steels
Part 1-4	Wind	Part 1-8	Joints and connections
Part 1-5	Thermal actions	Part 1-10	Tension elements
Part 1-6	Construction loads	Part 2 -A	Requirements for bearings
Part 1-7	Accidental actions	EN 1337	Structural bearings

Figure 1-5 Eurocodes suitable for glass and e.g. steel glass structures

EN 1990 specifies the general methodology of limit state verifications for the

- Ultimate limit state including robustness,
- Serviceability limit state,
- Durability,

where for glass structures the damage tolerance in the ultimate limit state is a particular concern.

Due to the peculiarities of glass, like the brittle behaviour and the randomness of the strength, glass structures require a design process different from the approach used for “traditional” building materials.

The design philosophy will be based on the concept of “fail safe”, according to which in a glass structure the crisis of one or more components must not impair the safety of the whole structure to safeguard human lives. Adequate safety can be guaranteed by referring to the concepts of hierarchy, robustness and redundancy that can provide the ductility which is lacking within the material or in a single structural element. It is essential to check that the structure is able to redistribute loads in case of breakage of some structural elements by providing alternative routes for the stresses.

To consider failure consequences in the ultimate limit state, EN 1990 specifies reliability classes, Figure 1-6, with different failure probabilities that may be used to classify different types of glass structures and glass products as single glass panes or laminated glass panes according to the use and support conditions. The failure probability to be achieved must be in accordance with Figure 1-6. The related reliability index  $\beta$  (1 year or 50 years) must be chosen depending on the definition of the loads and their quantiles (e.g. 98%-quantiles for the wind pressure from the wind speed are typically defined for a 1 year re-occurrence).

In relation to the failure consequences of EN 1990 a special classification for glass components is necessary to consider the risk after failure. In chapter 4.5 this matter is discussed in detail.

<b>ULS – failure consequences</b>	<b>Reliability Class</b>	<b><math>p_f</math> (1 year)</b>	<b><math>p_f</math> (50 years)</b>	<b>Reliability index <math>\beta</math> (1 year)</b>	<b>Reliability index <math>\beta</math> (50 year)</b>
Small	1	$10^{-5}$	$5 \times 10^{-3}$	5.2	4.3
Normal	2	$10^{-6}$	$10^{-4}$	4.7	3.8
Extraordinary	3	$10^{-7}$	$10^{-5}$	4.2	3.3
<b>SLS – failure consequence</b>					
normal			$10^{-2}$	2.9	1.5

Figure 1-6 Reliability classes according EN 1990 [38]

For the normal reliability class the design values of actions effects  $E_d$  and resistances  $R_d$  can be derived as a function of the statistical parameters of  $E$  and  $R$  and the reliability index  $\beta = 3.8$ , Figure 1-7.

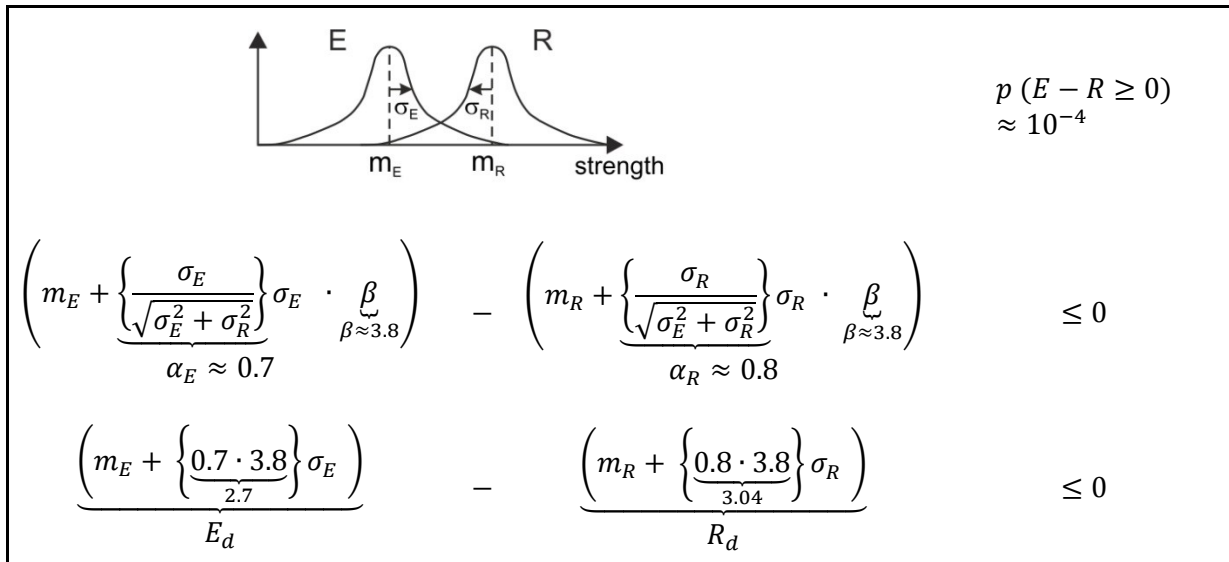


Figure 1-7 Statistical interpretation of design values

This definition of  $E_d$  is expressed as the effect of a combination of actions with the permanent action  $G$  and the leading variable action  $Q_{k1}$  and the accompanying variable action  $Q_{k2}$ , see Figure 1-8.

<i>Action effects</i>	$\leq$	<i>Resistance</i>
$E_d$	$\leq$	$R_d$
$\left\{ \begin{array}{l} E_d = \gamma_G G + \gamma_{Q1} Q_{k1} + \gamma_{Q2} \Psi_{0,2} Q_{k2} \\ E_d = \gamma_G G + \gamma_{Q1} \Psi_{0,1} Q_{k1} + \gamma_{Q2} Q_{k2} \end{array} \right\}_{max}$	$\leq$	$\frac{R_k}{\gamma_M}$
$\gamma_{Qi} Q_{ki} =$ leading actions		$R_k =$ characteristic value for $R$
$\gamma_{Qi} \Psi_{0i} Q_{ki} =$ accompanying actions		$\gamma_M =$ partial factor for $R$

Figure 1-8 Use of design values for ULS

The definition of  $R_d$  is used for the statistical evaluation of tests. However for glass structures resistances  $R$  depend not only on extreme values of actions as for other materials but also on other characteristics as load duration, humidity, etc. that are normally not mentioned in action codes. Nevertheless, the Eurocode specifications may be used, because these effects are included in the definition of resistances.

### 1.3 Structuring of the Eurocode

The survey on the existing national codes for the design of structural glass shows that most of them have principles for the general treatment of the material considering its specific brittleness and have further rules for standard situations. However a thorough consideration of all design cases is missing. Nevertheless some national rules aim at modern limit state design and also take account of recent results of strength evaluation. Note that there are differences in evaluating the strength according to prEN16612 [37] and other national approaches.



Generally the consideration of glass in structures is led by the classifying of the elements according to failure scenarios, Figure 1-9. For the first instance static loading is taken into account, for balustrades also dynamic loading and simulation methods exist.

The applications of glass components can be classified in structural or non-structural. Non-structural applications are simple window glazing. This anticipated “EC10” on Structural Glass will rather define “Secondary” and “Primary” Glass Components, see Eurocode Outlook No. 1. This classification is explained in chapter 0.

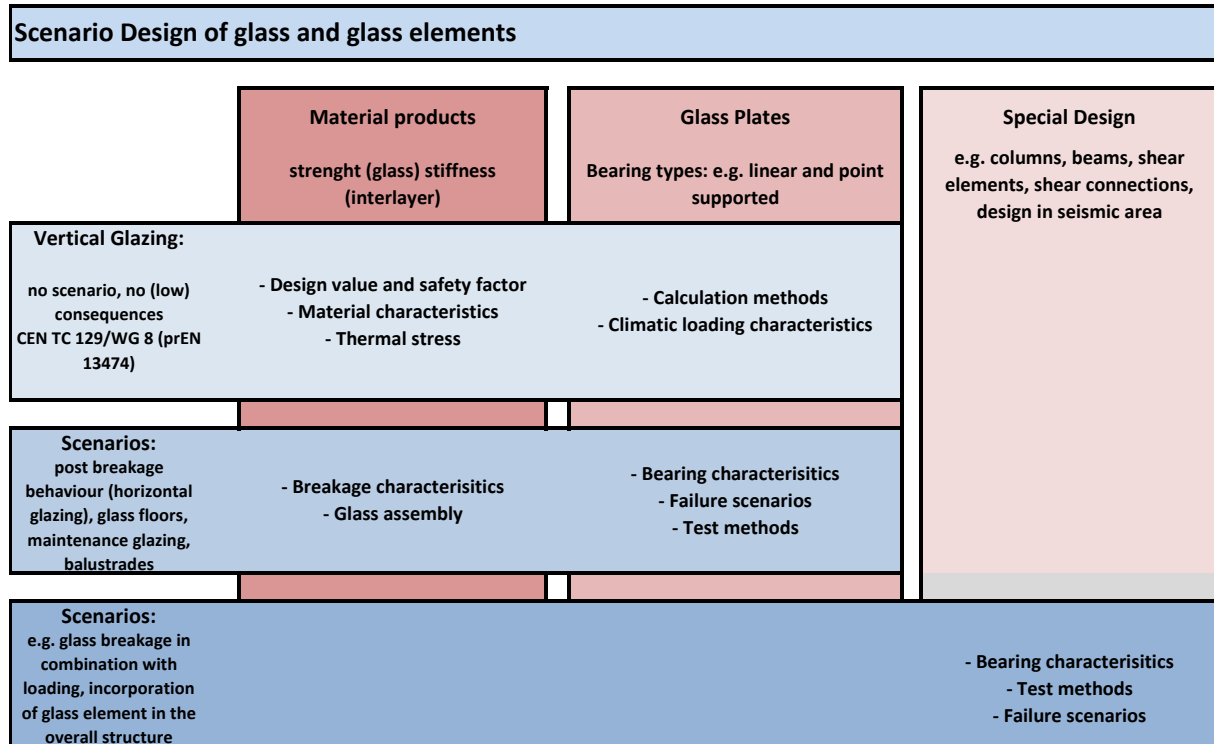


Figure 1-9 Scenario design of glass and glass elements of different structural importance

## Code Review No. 1

The review on existing national codes for some member states is shown in the following figures (no claim to be complete).

Rules in Germany			
	<b>Material products</b> strenght (glass) stiffness (interlayer)	<b>Glass Plates</b> Bearing types: e.g. linear and point supported	<b>Special Design</b> e.g. columns, beams, shear elements, shear connections, design in seismic area
no scenarios	DIN 18008-1		
Scenarios: post breakage behaviour (horizontal glazing)	DIN 18008-1	DIN 18008-1 (linear supported) DIN 18008-3 (point supported)	
Scenarios: glass floors, maintenance glazing, balustrades	DIN 18008-1	DIN 18008-4,-5 and -6	
Rules in Austria			
	<b>Material products</b> strenght (glass) stiffness (interlayer)	<b>Glass Plates</b> Bearing types: e.g. linear and point supported	<b>Special Design</b> e.g. columns, beams, shear elements, shear connections, design in seismic area
no scenarios	ÖNORM B 3716-1		
Scenarios: post breakage behaviour (horizontal glazing)	ÖNORM B 3716-1	ÖNORM B 3716-2 (linear supported) ÖNORM B 3716-5 (point supported)	
Scenarios: glass floors, maintenance glazing, balustrades	ÖNORM B 3716-1	ÖNORM B 3716-3 and -4	
Rules in Czech republic			
	<b>Material products</b> strenght (glass) stiffness (interlayer)	<b>Glass Plates</b> Bearing types: e.g. linear and point supported	<b>Special Design</b> e.g. columns, beams, shear elements, shear connections, design in seismic area
Scenarios: balustrades	ČSN 74 3305 Ochranná zbradlí		

Dutch regulations			
	Material products strenght (glass) stiffness (interlayer)	Glass Plates Bearing types: e.g. linear and point supported	Special Design e.g. columns, beams, shear elements, shear connections
Scenarios: (low) consequences breakage behavior, all applications	NEN2608 NEN3569 (risk of injury)		
Scenarios: post breakage behaviour, all applications	NEN2608 (riks of life)		
Scenarios: e.g. glass breakage in combination with loading, incorporation of glass element in the overall structure			NEN2608
British Regulations			
	Material products strength (glass) stiffness (interlayer)	Glass Plates Bearing types: e.g. linear and point supported	Special Design e.g. columns, beams, shear elements, shear connections, design in seismic area
Vertical Glazing: no scenario, no (low) consequences CEN TC 129/WG 8 (prEN 13474)	EN glass product standards	BS 6262 vertical glazing Glass & Thermal Safety (Pilkington)	
Scenarios: post breakage behaviour (horizontal glazing), glass floors, maintenance glazing, balustrades	EN 12600 EN glass product standards	BS 6262-4 safety glass usage BS 5516 sloping glazing BS6180 barriers CWCT TN66, TN67, TN92	
Scenarios: e.g. glass breakage in combination with loading, incorporation of glass element in the overall structure	None	None	Ad-hoc calculations and tests

Rules in France				
	Material products strenght (glass) stiffness (interlayer)	Glass Plates Bearing types: e.g. linear and point supported	Special Design e.g. columns, beams, shear elements, shear connections, design in seismic area	
Vertical Glazing: no scenario, no (low) consequences	NF DTU 39 P3 - Thermal fracture	NF DTU 39 P4 - Mechanical resistance / Cahier CSTB 3488 Structural glazing kits / Cahier CSTB 3574 Points		
Scenarios: post breakage behaviour (horizontal glazing), glass floors, maintenance glazing, balustrades	NF DTU 39 P5 -Security		Fiche Technique 47 - Impact resistance equivalence with EN 14019 / Cahier CSTB 3448 Glass floors and stairs / Cahier CSTB 3034 Glass balustrades	
Scenarios: e.g. glass breakage in combination with loading, incorporation of glass element in the overall structure				Project of document regarding seimsic actions / Glass beams and columns lateral torsional buckling

Technical Recommendations in Italy				
	Material products strenght (glass) stiffness (interlayer)	Glass plates Bearing types: e.g. linear and point supported	Special Design e.g. columns, beams, shear elements, shear connections, design in seismic area.	Safety criteria for glazing applications
Vertical Glazing: no scenario, no (low) consequences	UNI 7143 UNI/TR 11463 CNR-DT 210	UNI 7143 UNI/TR 11463 CNR-DT 210	CNR-DT 210	UNI 7697
Scenarios: post breakage behaviour (horizontal glazing)	CNR-DT 210	CNR-DT 210	CNR-DT 210	
Scenarios: glass floors, maintenance glazing, balastrades	CNR-DT 210	CNR-DT 210	CNR-DT 210	UNI 7697

The future Eurocode on the Design of Structural Glass should have an appropriate structuring that complies with the European approach of a material related design code in civil engineering and with the basic reference normative documents such as EN 1990 [38] and EN 1991 [39].

### Eurocode Outlook No. 1

- (1) *The main structure may be as follows:*
  - 1<sup>st</sup> part: *Basis of design of glass structures, materials and products*
  - 2<sup>nd</sup> part: *Secondary structural elements*
  - 3<sup>rd</sup> part: *Special design of primary elements*
- (2) *Apart from the calculative assessment methods, in each of the parts, the specific detailing should be addressed for achieving necessary redundancy and robustness in view of the particular material behaviour of glass.*

**Eurocode Outlook No. 2**

(1) *The structuring of the Eurocode on structural glass should comply with the CEN TC 250 rules for a material specific design code. In combination with the particular necessities of structural glass the structure of the first part of the Eurocode may be as follows:*

- 1 *General*
  - 1.1 *Scope*
  - 1.2 *Normative References*
  - 1.3 *Assumptions*
  - 1.4 *Distinction between principles and application rules*
  - 1.5 *Terms and definitions*
  - 1.6 *Symbols*
  - 1.7 *Conventions*
- 2 *Basis of design*
  - 2.1 *Requirements*
    - 2.1.1 *Basic requirements*
    - 2.1.2 *Robustness and redundancy*
    - 2.1.3 *Reliability management*
    - 2.1.4 *Durability*
    - 2.1.5 *Design working life*
  - 2.2 *Principles of limit state design*
  - 2.3 *Basic variables*
  - 2.4 *Verification by the partial factor method*
  - 2.5 *Design assisted by testing*
- 3 *Materials*
  - 3.1 *General*
  - 3.2 *Glass for structures*
    - 3.2.1 *Material properties*
      - 3.2.1.1 *Body of the panel*
      - 3.2.1.2 *Edge of the panel*
      - 3.2.1.3 *Corner of the panel*
      - 3.2.1.4 *Hole of the panel*
    - 3.2.2 *Prestress isotropy*
    - 3.2.3 *Spontaneous breakage induced by NiS-inclusions – Heat soak testing*
  - 3.3 *Interlayer*
  - 3.4 *Laminated glass*
  - 3.5 *Insulating glass*
- 4 *Durability*
- 5 *Ultimate limit state and corresponding design scenarios*
  - 5.1 *General and principles*
  - 5.2 *Secondary and primary structural elements of glass*
  - 5.3 *Static resistance and corresponding scenario*
  - 5.4 *Residual resistance and corresponding post failure scenario*
  - 5.5 *Seismic Ultimate Limit State*
    - 5.5.1 *Generals and principles*

- 5.5.2 *Additional requirements*
  - 5.5.2.1 *“Primary” seismic members*
  - 5.5.2.2 *“Secondary” seismic members*
  - 5.5.2.3 *Interaction between glass and surrounding structure*
- 6 *Serviceability limit state*
  - 6.1 *General and principals*
  - 6.2 *Vertical deflections*
  - 6.3 *Horizontal deflections*
  - 6.4 *Vibrations*
  - 6.5 *Seismic Serviceability Limit States*
- (2) *The second part of the Eurocode may be structured as follows:*
  - 1 *General – Design of secondary structural elements*
  - 2 *Vertical glazing*
    - 2.1 *Principles and definitions*
    - 2.2 *Façade glazing*
      - 2.2.1 *Specific requirements, design scenario and classification*
      - 2.2.2 *Linearly supported glazing*
      - 2.2.3 *Point supported glazing*
      - 2.2.4 *Additional rules for insulating glass*
    - 2.3 *Retaining glass barriers and parapets*
      - 2.3.1 *Specific requirements, design scenarios and classification*
      - 2.3.2 *Linearly supported glazing*
      - 2.3.3 *Point supported glazing*
  - 3 *Horizontal glazing*
    - 3.1 *Principles and definitions*
    - 3.2 *Overhead glazing, accessible and non-accessible for maintenance*
      - 3.2.1 *Specific requirements, design scenarios and classification*
      - 3.2.2 *Linearly supported overhead glazing*
      - 3.2.3 *Point supported overhead glazing*
      - 3.2.4 *Additional rules for insulating glass*
    - 3.3 *Glass floors*
      - 3.3.1 *Specific requirements, design scenarios and classification*
      - 3.3.2 *Linearly supported glass floors*
      - 3.3.3 *Point supported glass floors*
      - 3.3.4 *Additional rules for insulating glass*
- (3) *The third part of the Eurocode may be structured as follows:*
  - 1 *General – Design of primary structural elements*
  - 2 *Principles, ultimate limit states and corresponding design scenarios*
  - 3 *Cross-sectional resistance*
    - 3.1 *Bending about the weak axis and axial loading*
      - 3.1.1 *Monolithic sections*
      - 3.1.2 *Laminated sections*
    - 3.2 *Bending about the strong axis and axial loading*
      - 3.2.1 *Monolithic sections*
      - 3.2.2 *Laminated sections*
  - 4 *Buckling resistance*
    - 4.1 *Flexural buckling of panels*

4.1.1	<i>Panels under axial in-plane loads and out of plane loads</i>
4.1.1.1	<i>Monolithic sections</i>
4.1.1.2	<i>Laminated sections</i>
4.1.1.2.1	<i>Uniform loading</i>
4.1.1.2.2	<i>Combined short and long term loading</i>
4.1.2	<i>Combined loading under axial loads and bending</i>
4.1.3	<i>Load introduction and bearings</i>
4.2	<i>Lateral torsional buckling of in-plane-loaded panels</i>
4.2.1	<i>Monolithic sections</i>
4.2.2	<i>Laminated sections</i>
4.2.2.1	<i>Uniform loading</i>
4.2.2.2	<i>Combined short term and long term loading</i>
4.2.3	<i>Load introduction and bearings</i>
4.3	<i>Shear plate buckling of combined in-plane and out-of-plane loaded panels</i>
4.3.1	<i>In-plane corner loaded panels</i>
4.3.1.1	<i>Monolithic sections</i>
4.3.1.2	<i>Laminated sections</i>
4.3.1.2.1	<i>Uniform loading</i>
4.3.1.2.2	<i>Combined short and long term loading</i>
4.3.1.3	<i>Load introduction and bearings</i>
4.3.2	<i>Continuously edge supported panels</i>
4.3.2.1	<i>Monolithic sections</i>
4.3.2.2	<i>Laminated sections</i>
4.3.2.2.1	<i>Uniform loading</i>
4.3.2.2.2	<i>Combined short and long term loading</i>
4.3.2.3	<i>Load introduction and bearings</i>
5	<i>Joints and Connections</i>
5.1	<i>Bolts in shear</i>
5.2	<i>Friction joints</i>
5.3	<i>Adhesive bonding</i>
5.4	<i>Connections for earthquake resistance</i>
6	<i>Design in seismic areas</i>

In the following this report describes first the material properties of glass and interlayers (chapter 2). Only properties in view of structural applications are discussed, further physical and/or chemical properties are disregarded within the scope of this report. The mechanical background, the safety approaches as well as its explication in the different design situations are presented.

Thereafter different glass products are introduced (chapter 3), before design rules and safety requirements are described (chapter 4). The mechanical basics of the element plate with monolithic and laminated section are given in chapter 5.

Secondary and primary structural elements are described separately in chapters 6 and 7. At the end chapter 8 is dealing with connection types.

The grey boxes have two functions. First, the “Codes Reviews” give an overview on the existing codes like design or product standards. There give an idea about the state of the technology for the products and the applications. The information does not claim for completeness. Second, the “Eurocode Outlooks” predefine the needed standardisation tasks for the future Eurocode.



## 2 Material properties

### 2.1 Glass

#### 2.1.1 General

The following explanations mostly refer to those properties that are important in view of the load carrying capacity and the durability of structural glass. Other properties like e.g. transmission values, effects of coatings, insulation values of windows are assumed to be not relevant in combination with a Eurocode for the design of structural glass. Further references to the material characteristics can be found in [96].

#### 2.1.2 Characteristics of annealed glass

In its rigid state, glass can be regarded as an “amorphous solid”. Because of this the mechanical behaviour of glass is very brittle without any plastic deformation capacity. Under loading the strain response to the stress is perfectly linear with sudden failure.

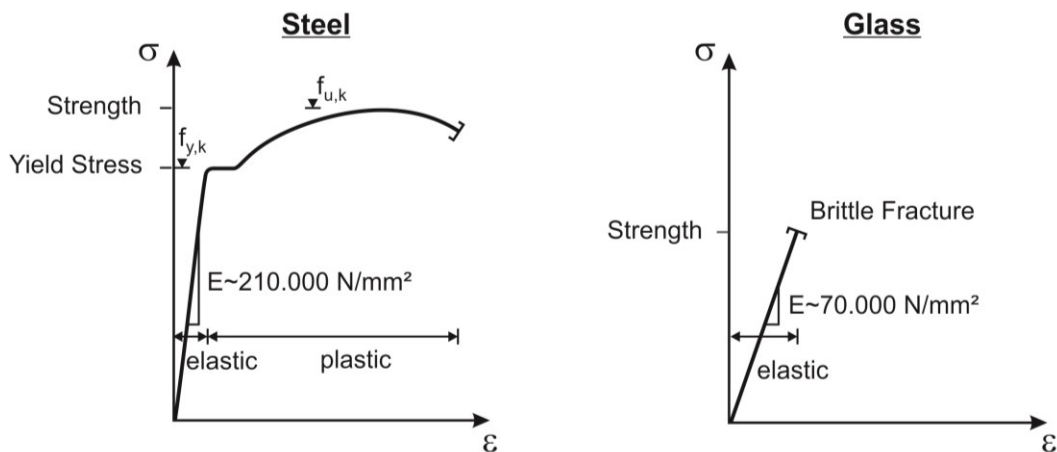


Figure 2-1 Stress-strain relation of glass and steel

Based on physical calculations the theoretical tensile strength results into 5000 MPa up to 8000 MPa. However due to structural defects on the surface (Griffith flaws) the real strength is much lower. Since high stress concentrations occurring in the cracks cannot be redistributed because of the lack of ductility, the bending strength of annealed glass in reality reduces to about 30 – 80 MPa. Depending on the size of the surface crack the bending tensile strength is controlled by the onset of a hypercritical crack growth without any plastic deformations. This results into a sudden breakage of the glass. On the other hand subcritical crack growth occurs due to potential so-called stress corrosion under expositions like water or humidity together with long-term loading. That is the reason why the bending strength of annealed glass e.g. due to permanent loads is lower than for loads with a short duration.

The bending strength of a float glass panel depends on a variety of influencing factors; the following gives an overview:

Size of the crack: By fracture mechanics the relation between the size of the crack and the stresses due to external strains can be described. Thereby the surface damage of the glass is assumed to be dependent on the age of the panel (by which the size and frequency of the crack is growing). For mode *I* the crack depth is related to the stress concentration factor  $K_{IC}$ :

$$a_{all.} = \left( \frac{K_{IC}}{\sigma_c \cdot Y \cdot M_k} \right)^2 \cdot \frac{l}{\pi} \quad (2-1)$$

with

$Y$  crack geometry factor

$M_K$  body geometry factor

$\sigma_c$  tension stresses on the surface of the body

Surface side of the glass panel: According to which of the two surface sides is considered the bending strength of the two float panel surfaces of freshly produced float glass is different. Namely the “tin”-side, having been in contact with the liquid tin bath during production, provides a lower bending strength compared to the other side that has been exposed to the air. This may be due to the atomic diffusion of tin or, more likely, due to the contact with the transport rollers. However this difference between the strength of the two surfaces disappears quickly when glass is in use.

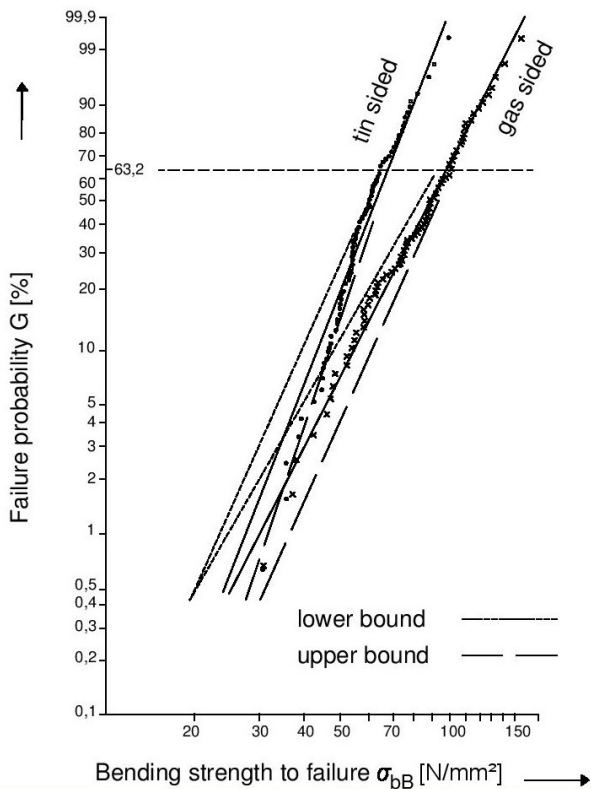


Figure 2-2 Weibull distribution of the bending strength related to the gas- and the tin-side (freshly produced float glass) [108]

**Size effect:** The reliability  $Z$  as the inverse of the breakage probability  $G$  is distributed according to Weibull and depends on the normalized strength ( $f/\theta$  to a defined fractile) and the scatter index  $\beta$ :

$$Z = 1 - G = e^{-\left(\frac{f}{\theta}\right)^\beta} \quad (2-2)$$

The reliability according to Weibull can be explained by the “weakest-link”-analogy. Here, a cut-out of a glass component is to be compared with a chain consisting of  $n$  chain links. Under constant loading the total reliability  $Z_{tot}$  is lower than the reliability  $Z_i$  of a single chain element; it is rather the product of all single reliabilities:

$$Z_{tot} = \prod_{i=1}^n Z_i \quad (2-3)$$

If all chain links are assumed to have the same properties, it applies accordingly

$$Z_{tot} = Z^n = e^{n \ln Z} \quad \text{respectively} \quad Z_{tot} = e^{\frac{n}{n_0} \ln Z^{n_0}} \quad (2-4)$$

Transferred to a glass plate of the area  $A$  that yields

$$Z_A = e^{\frac{A}{A_0} [\ln Z_0]} \quad \text{and} \quad Z_A = e^{\frac{A}{A_0} \left[ -\left(\frac{f}{\theta}\right)^\beta \right]} \quad (2-5)$$

For two areas  $A_1$  and  $A_2$  the ratios as follows can be derived:

$$\frac{f_{A_1}}{f_{A_2}} = \left(\frac{A_2}{A_1}\right)^{\frac{1}{\beta}} \quad \text{respectively} \quad \frac{f_{A_0}}{f_A} = \left(\frac{A}{A_0}\right)^{\frac{1}{\beta}} \quad (2-6)$$

Hence the ratio  $\alpha(A)$  of the bending strength of panels with different areas but the same specific reliability is

$$\alpha(A) = \left(\frac{A}{A_0}\right)^{\frac{1}{\beta}} \quad (2-7)$$

That means that the larger a glass panel is the lower is the bending resistance.

**Influence of the stress distribution:** Equation (2-6) can be written to

$$\frac{f_{A_1}^\beta A_1}{f_{A_0}^\beta A_0} = 1,0 \quad (2-8)$$

Summing up all finite quotients one obtains

$$\frac{f_{A_1}^\beta A_1}{f_{A_0}^\beta A_0} + \frac{f_{A_2}^\beta A_2}{f_{A_0}^\beta A_0} + \dots + \frac{f_{A_n}^\beta A_n}{f_{A_0}^\beta A_0} = \frac{\sum_{i=1}^n f_{A_i}^\beta A_i}{f_{A_0}^\beta A_0} = n \quad (2-9)$$

Whilst defining

$$nA_0 = \sum_{i=1}^n A_i = A_{ges} = A \quad (2-10)$$

the equivalent strength  $f_{A,eq}$  of an area  $A$  with partial areas  $A_i$  that are loaded by uniform stress can be compared to the equivalent strength  $f_{A,eq}$  of the same area but loaded with non-uniform stress. However both should have the same maximum bending stress  $\sigma_{max}$ . The equivalent strength  $f_{A,eq}$  then:

$$f_{A,eq} = \left[ \frac{\sum_{i=1}^n f_{A_i}^\beta A_i}{A} \right]^{\frac{1}{\beta}} := \alpha(p) \cdot \sigma_{max} \quad \text{respectively} \quad \alpha(p) = \left[ \int \left( \frac{\sigma(A)}{\sigma_{max}} \right)^\beta \frac{dA}{A} \right]^{\frac{1}{\beta}} \quad (2-11)$$

Influence of the load duration: The ratio of the reference strength  $f_{0,A_0}$  coming from a reference test (with defined load duration, exposition and reference area) to the equivalent reference strength  $f_{eq}$  (with different load duration, exposition and reference area) is:

$$\left[ \frac{f_{eq,V}}{f_{0,A_0}} \right]^n = \frac{S_0 \cdot t_0}{S_V \cdot t_V(A)} \quad (2-12)$$

with

$S, n$  constants of subcritical crack propagation [86] whereby  $S_0$  is evaluated under standardised conditions and  $S_V$  under current conditions

$t_0$  reference time period

$t_V$  current time period

$t_V(A) = t_V \cdot \alpha(A)$ , see (2-7).

The damage accumulation law according to *Miner's* rule can be adopted:

$$\sigma_{eq} = \left[ \frac{\sum_V S_V \cdot \sigma_{eq,v}^n \cdot t_V(A)}{S_0 \cdot t_0} \right]^{\frac{1}{n}} \quad (2-13)$$

and the factor for the time duration can be written:

$$\alpha(t) = \left[ \frac{\sum_V S_V \cdot t_V(A)}{S_0 \cdot t_0} \right]^{\frac{1}{n}} \quad (2-14)$$

As simplification of  $\alpha(t)$  the formula for the modification factor  $k_{mod}$  is given in [45] taking into account the load duration  $k_{mod}$  can be determined from (2-15) by assuming a constant surrounding medium ( $S_V = S_0$ ) and a current time period of 5 sec (related to fracture tests), see Code Review No. 2:

$$\alpha(t) = k_{mod} = \left( \frac{t_V(A)}{t_0} \right)^{1/n} = \left( \frac{5 \text{ sec}}{t} \right)^{1/n} \quad (2-15)$$

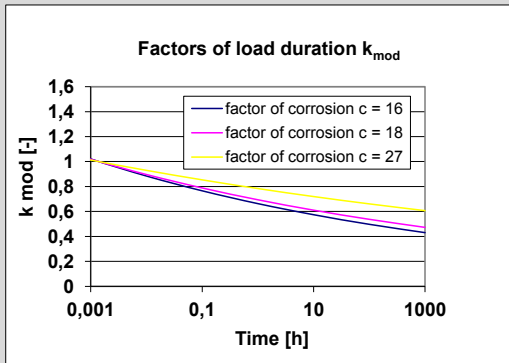
## Code Review No. 2

### Design standards:

NEN 2608 [45]:

$$\text{Factor of load duration } k_{mod} = \left(\frac{5}{t}\right)^{1/c}$$

$t$ : load duration in seconds;  $k_{mod,min} = 0,25$ ,  $k_{mod,max} = 1$ ,  $c$ : constant of corrosion, for all edge zone  $c = 16$ ; no edge zone and surface of laminated glass adjacent to the interlayer  $c = 18$ ; no edge zone and surface adjacent to a hermetical sealed cavity, the humidity in the cavity is at maximum 10%  $c = 27$ ; no edge zone and other situations  $c = 16$



prEN 16612 [37]: Factor of load duration  $k_{mod} = 0,663t^{-1/16}$  with factor of corrosion  $c = 16$ ,  $t$  in [h]

CNR-DT-210 [55]: The Italian CNR-DT-210, suggests the expression  $k_{mod} = 0,585t^{-1/16}$ .

The types of loading are connected with specified load duration. The specification of the load durations are not unified in the different countries, see

Code Review No. 25 et seq..

Load duration	Type of loading and $k_{mod}$ [44]	Type of loading and $k_{mod}$ [48]	Type of loading and $k_{mod}$ [37]
Permanent	Permanent load and permanent climatic loading ( $p_{\Delta H}$ ) 0,25	Permanent load and climatic load 0,6	Dead load, self-weight 0,29
middle	Climatic loading ( $p_{\Delta T}$ and ( $p_{\Delta p_{me}}$ )) and snow 0,4	Snow, personnel loading on glass floors and driveable floors 0,6	Yearly temperature variation 0,39 Snow 0,44 Barometric pressure 0,5 Daily temperature variation 0,57
short	Horizontal traffic load and wind [44] 0,7	Horizontal traffic load, maintenance load and wind 0,7	Wind (short, multiple) 0,7 Personnel loads (short, single gust) 0,89 Wind (single gust) 1,0

### Code Review No. 3

*Technical recommendation:*

The Italian CNR-DT-210 [55] takes into account of the effects of the type of stress (uniaxial, biaxial etc.). This is because failure is triggered by the growth of a dominant crack in mode I, and the probability of having a dominant crack at right angle to the principal tensile stress is higher, e.g., if the state of stress is equibiaxial, rather than uniaxial.

Influence of the exposition: Based on equation (2-12) an exposition factor can be derived:

$$\alpha(S_V) = \left[ \frac{\sum_V \left( \frac{\sigma_{maxV}}{\sigma_{max}} \right)^n \cdot S_V \cdot t_V(A)}{\sum_V S_V \cdot t_V(A)} \right]^{\frac{1}{n}} \quad (2-16)$$

The crack growth rate  $v$  is related to the stress concentration factor and parameters  $S$  and  $n$  are depending on the surrounding. In the literature the following values are given [106].

Table 2-1 Parameter  $n$  and  $S$  depending on the surrounding medium

	Temperature	$n$	$S$
Defect under water	35 °C	16	5
Humidity 50%	25 °C	18.1	0.45
Humidity 10%	25 °C	27	0.87
Snow	2 °C	16	0.82
Vacuum		70	250

As can be seen the number of parameters influencing the surface bending resistance of annealed glass is relatively large. Particularly the expositions like to sand, dust and water may strongly influence. Since the parameters in Table 2-1 are depending on the chemical glass composition, they have to be considered in the product codes. However the national regulations are dealing with them differently.

The short back of a limited bending strength of annealed glass can – to some extent - be overcome by thermal pre-stressing. Detrimental exposition effects can be avoided by laminating the load carrying glass layers thus protecting it.

### 2.1.3 Toughened glass

#### 2.1.3.1 Toughening process

Glass has no crystallisation temperature but a so-called transformation temperature. At higher temperatures the state of the glass is changing from an elastic material to a “liquid” with viscoelastic and at the end to a liquid with viscous properties.

The glass melt consisting of sand, quartz and soda has a temperature of about 1100-1200°C. For the post-processing of glass the so-called glass transformation temperature  $T_G$  (about 650°C) is important. Around that transformation temperature range the material prop-

erties are viscoelastic. These properties are used to induce residual stresses in the glass by heating up the glass panel up to 650° and cooling down very fast.

### 2.1.3.2 Strengthening effect

Due to the toughening process (heating the glass panel up to 650 °C and cooling down) the distribution of residual stresses takes place in form of a parabola over the glass thickness, see Figure 2-3. In the plate the prestress vectors are always parallel to the surface; parts next to the surface are in compression (which are closing the GRIFFITH cracks), whereas around the centre tension stresses are present. This is due to the retarded cooling of the inner part of the glass pane whilst the cooling of the surface is accelerated; the restrained contraction of the centre therefore provokes tension in the interior of the glass pane. Also at the edges and next to a hole surface pressure stresses are present.

The effects of the pre-stressing are:

- The bending strength of the glass gets much higher compared to float glass.
- In case of breakage a thermally toughened glass panel breaks into small glass pieces (particles or dices) caused by the pre-stress energy. Without tempering annealed glass breaks into large shards. Initially, thermal toughening has been developed for the automotive industry to avoid injuries and so it is also called “safety glass”. In relation to building application there is still a risk if a panel breaks in a façade and glass pieces sticking together fall down.
- The risk of breakage caused by e.g. accidental impact is considerably lower compared to float glass.

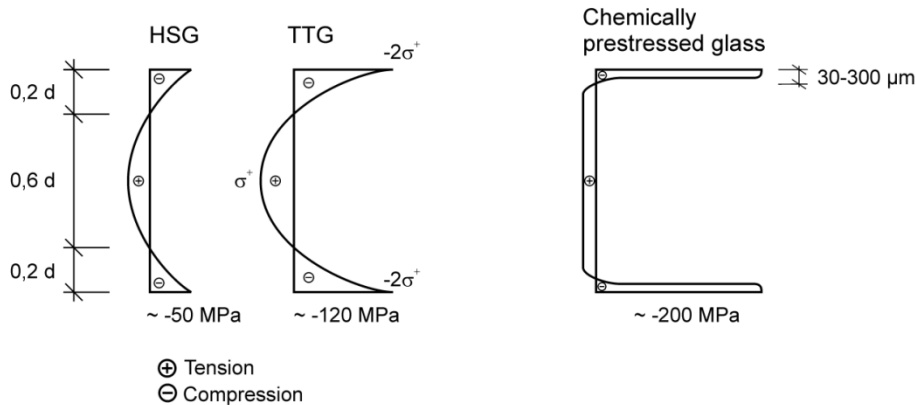


Figure 2-3 Schemes of different prestress-distributions across the plate section depending on the glass type

### 2.1.4 Breakage pattern

The higher the prestressing, the smaller the shards or glass particles become after breakage for a given thickness. The reason for this is the induced energy that releases along the total lengths of the crack pattern (higher prestressing ~ higher crack energy ~ greater total length of cracks ~ smaller particles), see Figure 2-5.

Figure 2-4 shows the interconnection of the occurring crack pattern with the degree of pre-stress for float, heat strengthened and toughened safety glass. Note that, to reach a “good”

crack pattern for heat strengthened glass as for float, no (or only a few) “island-shards” should occur.

Only some are specified destructive methods exist to determine the bending strength as well as the quantity and homogeneity of the pre-stressing. In such a test a small glass plate (360 mm x 1100 mm) is to be destroyed under a loading-free situation. Depending on the product (heat strengthened or thermally toughened glass) specified criteria have to be fulfilled e.g. a minimum number of broken glass particles.


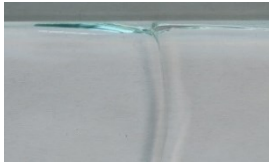
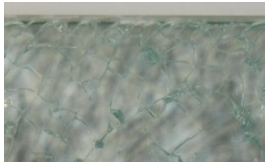
	Annealed glass / float glass	Heat strengthened glass (HSG)	Thermally toughened glass (TTG)
Characteristic bending strength $f_k$	45 N/mm <sup>2</sup>	70 N/mm <sup>2</sup>	120 N/mm <sup>2</sup>
Detail “breakage structure” (near to the edge)			
Degree of surface pre-stress	~ 0 MPa	~ 30-50 MPa	> 90 MPa

Figure 2-4 Interconnection of the occurring crack pattern with the degree of prestress for float, heat strengthened and toughened safety glass

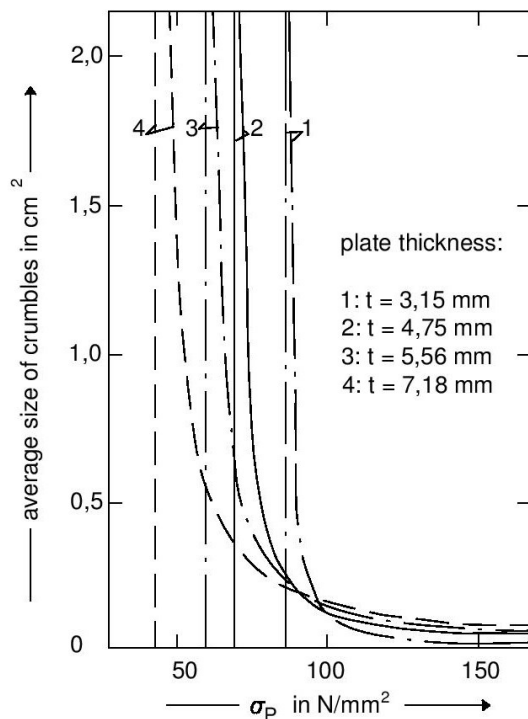


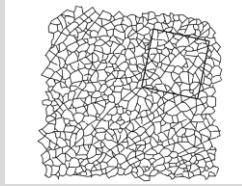
Figure 2-5 Size of the glass splinters depending on the level of prestressing [111]

## Code Review No. 4

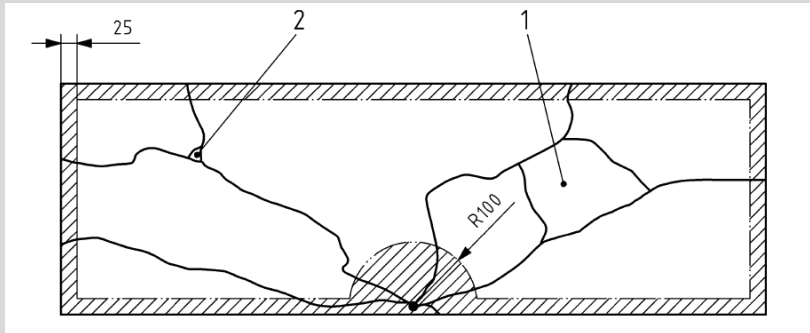


Product standard:

EN 12150-1 [11]: The number of glass pieces in a square of 50 mm x 50 mm is an indicator for the quality of a thermally toughened glass panel. The higher the induced stresses are the higher the number of glass pieces is.



EN 1863 [10]: Heat strengthened glass should have a breakage structure similar to float glass. The number and size of so-called “island” pieces like No.1 or 2 is limited in the product standard.



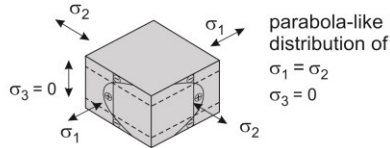
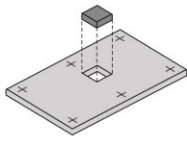
Technical Approvals, Building regulations:

In Germany, the glass producers control also the breakage structure of glass panels up to the largest producible format of heat strengthened or thermally toughened glass panels, because the validity of the small scale tests is limited [47].

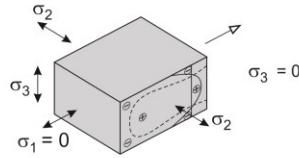
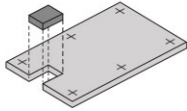
### 2.1.5 Definition of the zones 1 to 4

When speaking of “strength”, the bending strength is meant. However it is known that in a glass panel the bending strength differs significantly depending on the position where it is obtained. In view of these four characteristic zones are distinguished: the interior or body zone (zone 1), the edge of the panel (zone 2), the corner strength (zone 3) and the edge of a hole (zone 4).

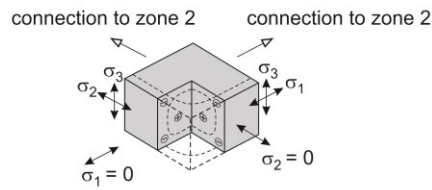
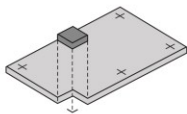
Zone 1 - interior surface



Zone 2 - edge



Zone 3 - corner



Zone 4 - hole

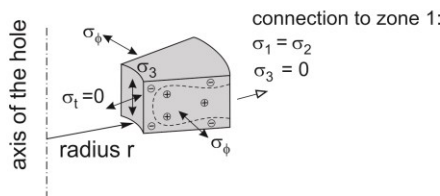
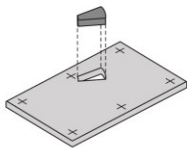


Figure 2-6 Definition of zone 1 to 4 and residual stress distribution

**Eurocode Outlook No. 3**

- (1) *The Eurocode should provide in its first part specifications on the glass tensile strength, the differentiation of which should be according*
  - *to the different degree of thermal prestress*
  - *to the different load duration and exposure, in particular for annealed glass*
  - *to the considered location in the panel (body, edge in dependence of the finishing, corner, hole),*
  - *to the gradient of stress (bending or normal force), as the stress intensity factor for a constant tensile stress distribution across the section is higher than for sloped stress distribution due to bending*
  - *eventually to the considered area.*
- (2) *Thereby the statistical evaluation method, the test procedure, the distribution fractile and the confidence interval has to be considered.*
- (3) *Additional requirements should be made on the size and homogeneity of particles after breakage as well as on the isotropy of the prestressing.*
- (4) *Reference should be made to the existing product standards and also the test standards.*

### 2.1.6 Test methods according to EN 1288

However, the recent European standards define only the bending strength of zone 1 (body) and zone 2 (edge).

#### Code Review No. 5

Test standard:

EN 1288 [20]: Determination of the bending strength of glass

EN 1288-1: Fundamentals of testing glass:

Definition of the terms:

effective bending strength  $\sigma_{beff}$  = average value taken into account the nonuniform stress distribution

bending strength  $\sigma_{bB}$  = bending strength that induce the break of the test specimen

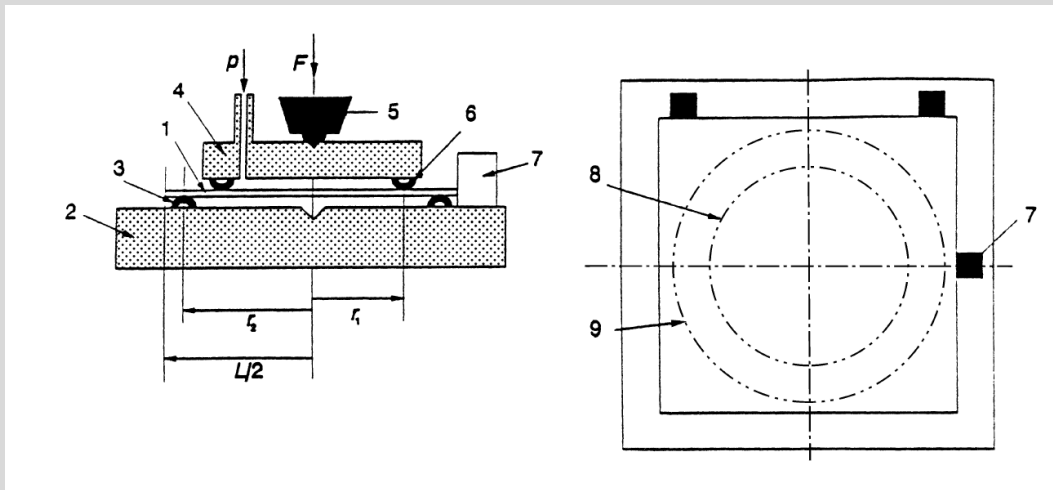
equivalent bending strength  $\sigma_{beqB}$ : bending strength e .g. of patterned glass

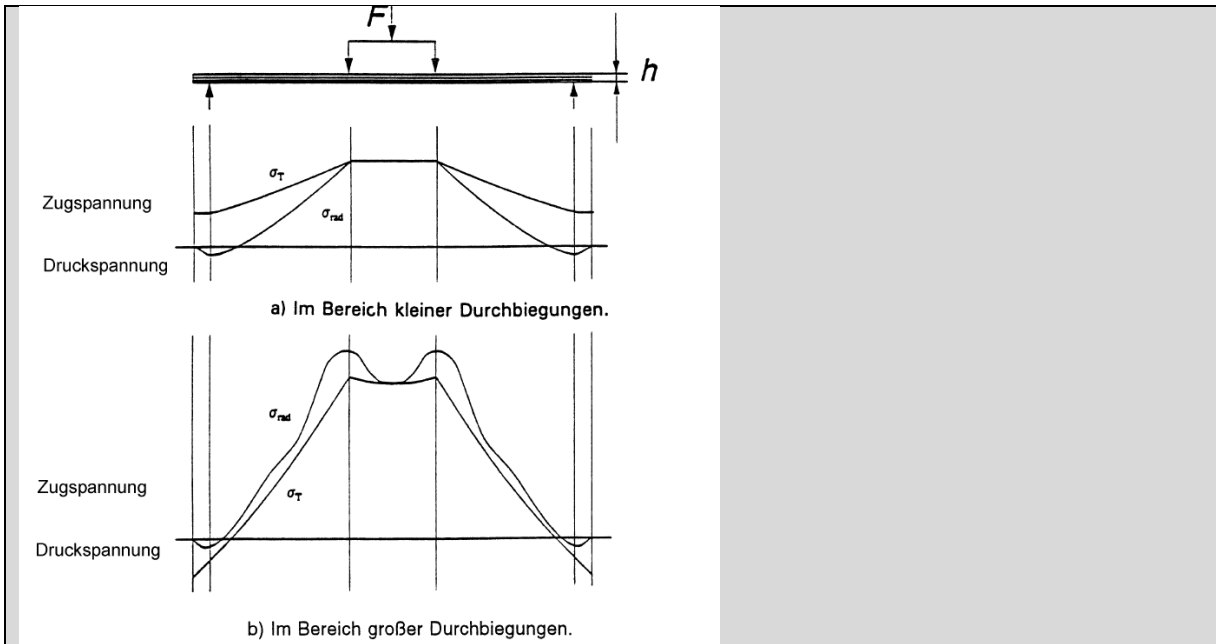
EN 1288-2: Coaxial double ring test on flat specimens with large surface areas:

This test method is only applicable for flat glass. Depending on the thickness tolerances also patterned glass can be tested.

The coaxial double ring test avoids the influence of the edges. In the case of small deflection and  $p = 0$  a coaxial stress situation is present in the circle with the radius  $r_1$ . In the case of large deflections local stress concentrations occur under the circular pressure ring. This can be avoided by a combined ring and pressure load  $F + p$ . A nonlinear evaluation method is given in the test standard to evaluate the failure strength.

The stress rate during test should be  $2 \pm 0,4 \text{ N/mm}^2$ .





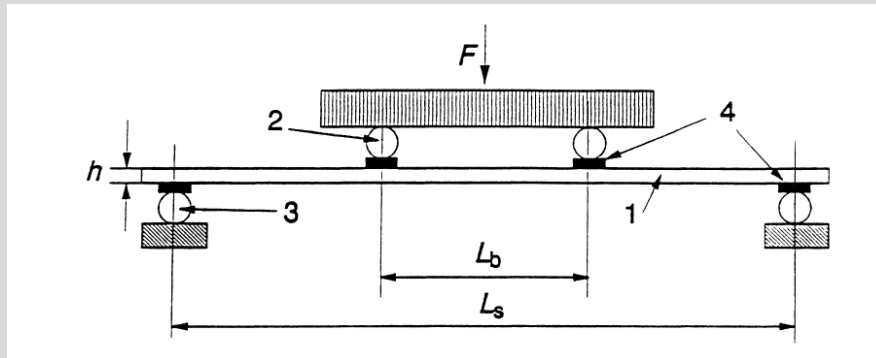
$p$ : pressure,  $F$ : load,  $r_1 = 300 \pm 1 \text{ mm}$ ,  $r_2 = 400 \pm 1 \text{ mm}$ ,  $L = 1000 \pm 4 \text{ mm}$

*EN 1288-3: Test with specimen supported at two points (four point bending):*

*This test method is only applicable for flat glass. Patterned glass can be tested without restrictions.*

*The test results are influenced by the bending strength of the edges. For slender test specimen the evaluation of the results can be done by the linear beam theory. In the case of large test specimen the Poisson effect has to be taken into account. The Poisson effect evokes a stress concentration near to the edges and a discharging of the inner part. The strength can be evaluated from all broken test specimen or only from "edge breaks".*

*The stress rate during test should be  $2 \pm 0,4 \text{ N/mm}^2$ .*

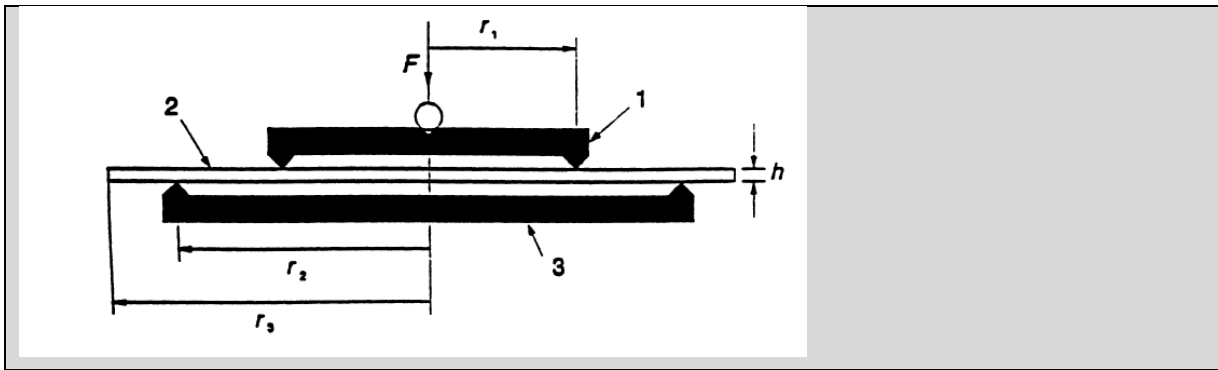


$L_b = 200 \text{ mm}$ ,  $L_s = 1000 \text{ mm}$

*EN 1288-5: Coaxial double ring test on flat specimens with small test surface areas:*

*This test method is only applicable for flat glass. Patterned glass cannot be tested.*

*The advantage is the coaxial loading of the glass panel, but the bending strength is up 300% higher compared to the methods in part 2 or 3.*



It is evident that for structural glass elements a more specific differentiation is needed:

- Zone 2: edge strength (additionally to the bending strength the strength due to in-plane loading)
- Zone 3: corner strength
- Zone 4: holes (bending and in-plane loading)

So far there are no standardised test methods to determine the strength of zone 2 to 4 for structural applications. Against this background several research projects have been carried out to evaluate strength values for these zones [117][124].

#### Eurocode Outlook No. 4

*Whilst referring to EN 1288 [20], however, within the scope of a new Eurocode on structural glass, the test specification must be enlarged by test methods defining procedures for zone 2 (in-plane loading) and zone 4 (bending and in-plane loading).*

#### 2.1.7 Statistical evaluation of the bending strength

The statistical evaluation of the strength values for glass differs compared to other construction materials.

#### Code Review No. 6

##### Product standards:

*EN 12150 [11]/ EN 1863 [10]: The mechanical strength is related to a specified breakage probability and load duration. The characteristic values for heat strengthened glass and thermally toughened glass relate to short time loading (e.g. wind loads), 5% breakage probability and a confidence interval of 95%.*

##### *Most important strength values:*

$$f_{ck, float} = 45 \text{ N/mm}^2$$

$$f_{ck, heat \text{ strengthened glass}} = 70 \text{ N/mm}^2$$

$$f_{ck, thermally \text{ toughened glass}} = 120 \text{ N/mm}^2$$

##### Design standards:

*In the Italian CNR-DT-210 [55], the strength of glass is interpreted through a statistical Weibull distribution. The 45 MPa strength is considered to be a nominal value of strength to be used in cal-*

*culations. Material partial safety factors are calculated on the basis of full probabilistic (level III) methods for paradigmatic cases.*

## Code Review No. 7

### *Technical approval:*

*In the technical approval for channel shaped glass [74][75], in contrast to flat glass in EN 12150 [11] /EN 1863 [10], the profile bending strength is to be evaluated with a 5% breakage probability and a confidence interval of 75% according to EN 1990 [38].*

## Eurocode Outlook No. 5

(1) *The Eurocode should specify an appropriate statistical evaluation to determine the strength referring to the corresponding strength distribution in terms of mean value, standard deviation and further of probabilistic approach.*

### 2.1.8 Quality control by non-destructive methods, stress optics

Non-destructive quality control of tempered glass panels (TTG and HSG) can be carried out with the use of optical devices. Here, is to differentiate between methods that locally measure the amount of stress and on the other hand methods that visualise the qualitative homogeneity or isotropy of the pre-stress over the plate.

The local methods take account of the birefringence effect of glass, the qualitative methods are based on light polarisation effects and their visualisation techniques.

The measurements taken using these methods are found to be operator dependent and not easily repeatable even by the same operator. Therefore any measurements using these methods should only be taken as general qualitative indicators and not as quantitative values for design or glass selection purposes.

## 2.2 Interlayer

### 2.2.1 General

In general, interlayers are of polymer or ionomer materials. They show a significant time- and temperature dependency. This characteristic is also influencing the static behaviour of glass laminates under different loading situations. Some basics concerning the viscoelastic effects, appropriate testing methods and a design method are described hereafter. Further references to the material characteristics can be found in [154] [155] [156].

### 2.2.2 Viscoelastic behaviour of interlayers

There are various investigations on the creep and relaxation behaviour of the interlayer, mostly of PVB, in laminated glass panels, all of them using different test setups, evaluation and interpretation techniques. As a result the proposed time dependent shear moduli according to different authors are different [150] [159] [160] [161] [162] [163].

Differences may be reasoned by the different test setup, different sizes and theoretical approaches. However there is the need on having a reliable elasticity-time-law to benefit from the composite effect of laminated glass, in particular ionomer interlayers.

### 2.2.3 Determination of the viscoelastic behaviour with “small size” tests

Generally, mechanical tests are performed with methods that apply at specific ranges of time domain depending on the load time that is necessary to investigate. The frequency of dynamic action in engineering analysis generally ranges from  $10^{-9}$  to  $10^0$  Hz. Higher frequencies are useful in the study of impacts and explosions. The most common test methods that are able to determine the rheological properties of polymer materials are reported in the following.

#### Transient experiments

Typical transient experiments are “creep” and “stress” relaxation. In a creep experiment, a constant stress is applied to a specimen and the corresponding strain is recorded as a function of time; using this procedure, the creep compliance is obtained. On the other hand, in a stress relaxation experiment, a constant strain is imposed to a specimen and the corresponding stress is determined, thus obtaining the shear relaxation modulus.

#### Periodic experiments

If stress (or strain) applied on a viscoelastic material is varied periodically with sinusoidal law, the strain (or stress) will also alternate with the same law and frequency, but the course will be out of phase. In case of sufficiently small deformations, material functions such as relaxation modulus or creep compliance are independent on the amplitude of strain or stress applied to the specimen. These conditions are satisfied in the linear viscoelastic range. If, at a given temperature, a strain is imposed according to

$$\gamma = \gamma_0 \sin \omega t \quad (2-17)$$

It can be easily shown [110] that, in the linear range, the stress can be expressed as:

$$\tau = \gamma_0 (G' \sin(\omega t) + G'' \cos(\omega t)) \quad (2-18)$$

where the shear storage modulus  $G'(\omega)$  and the shear loss modulus  $G''(\omega)$  of the material are functions of the angular frequency  $\omega$  only. If stress is applied according to a sinusoidal time law, the same definitions can be set up for the creep functions. This test method, referred to as “forced vibrations”, applies at a frequency range of  $10^{-2}$  to  $10^2$  Hz.

Among the periodic experiments, the free oscillation (for example, torsional oscillation) covers in general a frequency range of 0.01 to 25 Hz, the upper limit being set by the dimensions of the specimen when becoming comparable to the wavelength of the stress waves in the specimen. The viscoelastic properties are obtained from the value of the constant angular frequency  $\omega_c$  of the specimen and the gradually decreasing amplitude of the oscillation. At higher frequencies, the wavelength of displacement becomes too short with respect to the dimensions of specimen; in such cases, the propagation of travelling waves can be observed and the velocity and the attenuation of waves provides the components of the complex Young’s modulus. Longitudinal and flexural waves in thin strips can cover in general a frequency range from the order of  $10^2$  to  $10^7$  Hz.

Given a certain frequency  $\omega$ , different values of  $G'(\omega)$  and  $G''(\omega)$  can be found if periodic tests are performed at different temperatures. It was observed that, if one represents  $G(\omega)$  [110]. A general form for the description of the shift value  $a_T$  as a function of  $(T - T_0)$ , commonly accepted in the analysis of polymers, was proposed by *William Landel* and *Ferry* (WLF equation):

$$\log a_T = \frac{-c_1^0(T - T_0)}{c_2^0 + T - T_0} \quad (2-19)$$

Once the mathematical constants  $c_1^0$  and  $c_2^0$  have been determined, obtaining from superposition of experimental points determined at various temperatures, it is possible to build the master curve at the reference temperature  $T_0$  for the viscoelastic constants and to represent master curves for different reference temperatures.

## Code Review No. 8

### Test standard:

*prEN 16613 [22]: differentiation of isotropic and non-isotropic interlayer materials*

*Test methods: dynamic shear test method and bending tests*

*Determination of:*

- *Glass transition temperature*
- *Stiffness depending on a range of frequencies and a range of temperature*
- *Master curve and WLF-Parameters*
- *Definition of stiffness families*
- *Derivation of the shear transfer coefficient  $\omega$  to calculate an effective thickness of a glass laminate*

### 2.2.4 Determination of the viscoelastic behaviour in the panel-torsion-test

With these existing “small size”-tests the time and temperature dependent stiffness behaviour of interlayers can be determined. However they show some shortcomings in view of the size-effect. Therefore, in the following a “large-size-test” in form of a panel-torsional-test is described. A further possibility is a four-point-bending test. They are suited in particular since herewith large panels with real geometrics can be investigated. Because the composite area of the interlayer is large enough, influences from the edges are minimized. The test methods give good results for interlayer materials with a shear stiffness  $G < 10$  MPa.

By means of the so-called panel-torsion-test [166] [167] [169] the time and temperature dependent mechanical behaviour of laminated glass panels can be well observed. Further to the fact that it minimizes effects from edges it also takes into account the bonded glass surface (substrate) which expectedly may change the mechanical behaviour compared to that obtained from pure interlayer.



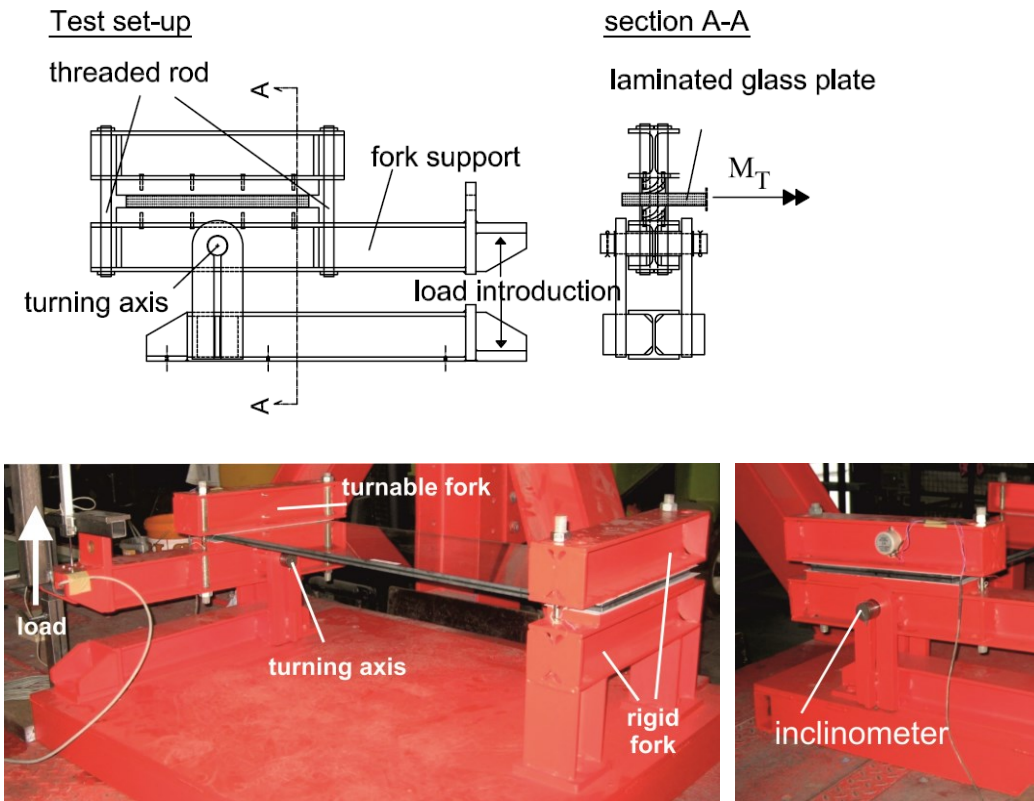


Figure 2-7 Test set-up and measurement devices at the panel-torsion-test

In the test setup the laminated panels are friction-free clamped at the two ends. This will be realized by two steel sections positioned to a “fork” at each end. To avoid friction as far as possible; the contact planes of the section flanges are covered with PTFE-layers (Teflon). One pair of steel sections is fixed rigid to the lower structure, whereas the other is turnable about a rotation axis. At the turnable side the load introduction as well as the load- and the rotation-measurement (twist measurement by an inclinometer) are positioned. With the PTFE-layers avoiding friction, the small shift of the longitudinal axis of the panels against the turning axis of the apparatus does not produce an additional constraint and thus can be neglected.

Also to test the temperature influences, the whole set-up can be conducted in a climate chamber.

Test-specimens can be laminated glass panels with ambiguous glass compositions. The dimensions should be 1100 mm x 360 mm or larger. Either the rotation is kept constant and the relaxing twist-moment is measured or, inversely, the twist moment is kept constant and the creeping rotation angle is going to be measured. Evaluations of some tests on 2 x 6 mm HSG respectively 2 x 5 mm HSG with each 1.52 mm thick PVB are shown in Figure 2-9.

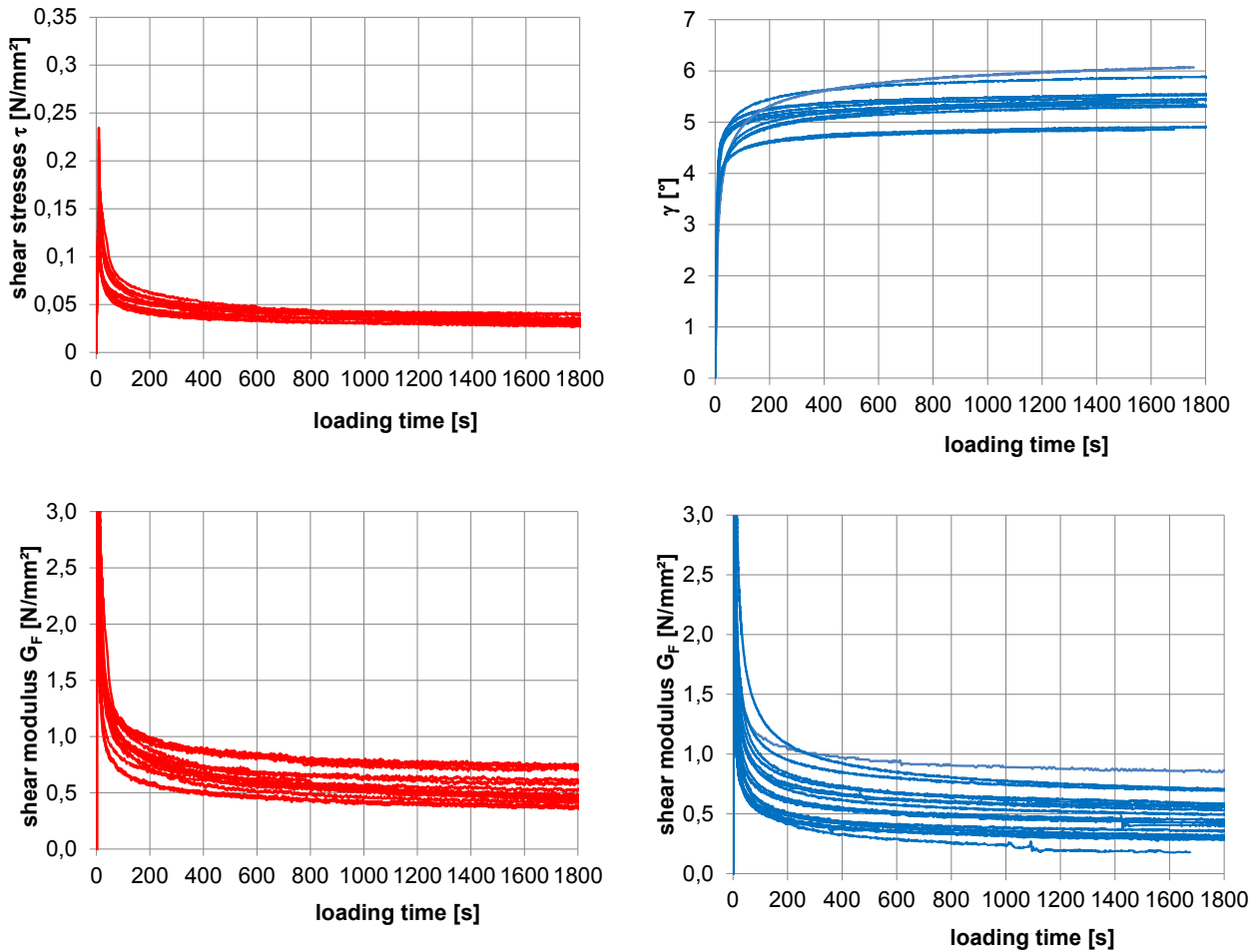


Figure 2-8 Relaxation- and creep-history as well as the respective development of the shear modulus from the panel-torsion-tests of laminated glass panes with PVB,  $T = 23 \text{ }^{\circ}\text{C}$

The shear modulus and the stresses can be determined either according to the extended bending and torsion theory or according to the “sandwich theory with torsion” [166] [167]. Solving the differential equation according to the first mentioned theory:

$$I_T^{eq} = \frac{1}{\frac{1}{S_{11}} + \frac{S_{12}^2}{S_{11}^2} \frac{1}{\tilde{T}_{22}}}, \quad (2-20)$$

using the coefficients according to Table 2-2. Alternatively the equivalent torsional stiffness can be derived by the sandwich theory:

$$I_T^{eq} = \frac{2}{3} B \cdot d^3 + 2B \cdot d(t+d)^2 \left( 1 - \frac{\tanh(\lambda_T B/2)}{\lambda_T B/2} \right) \quad (2-21)$$

with 
$$\lambda_T^2 = \frac{2 \cdot G_F}{G \cdot t \cdot d} \quad (2-22)$$

Table 2-2 Coefficients  $S_{ik}$  and function  $\tilde{T}_{22}$  for torsion

Laminated glass with two equal layers	
$S_{11}$	$\frac{8}{3} \cdot B \cdot \left[ -\left(\frac{1}{2}t\right)^3 + \left(d + \frac{1}{2}t\right)^3 \right]$
$S_{22}$	$\frac{1}{2} \cdot B \cdot d$
$S_{12}$	$B \cdot \left[ \left(\frac{1}{2}t\right)^2 - \left(d - \frac{1}{2}t\right)^2 \right]$
$S_{\varphi,22}$	$\frac{1}{12} \frac{B^3}{t}$
$\tilde{T}_{22}$	$-\frac{S_{12}^2}{S_{11}} + S_{22} + \frac{G_F}{G} S_{\varphi,22}$

The results of (2-20) and (2-21) are only slightly differing, see Figure 2-9.

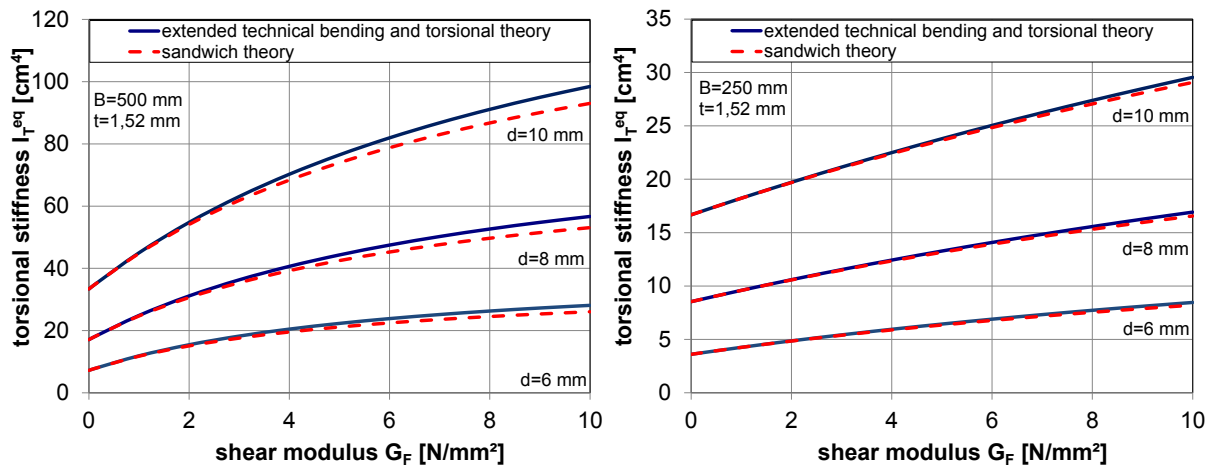


Figure 2-9 Comparison of the equivalent torsional stiffness according to (2-20) and to (2-21) for different modulus of shear

## 2.2.5 Durability of PVB interlayer

In [161] it is shown that moisture penetration of a PVB-interlayer at the edge zones of laminated safety glass (LSG) is the only major influencing factor on the durability: hence, shear behaviour and adhesion characteristics change. Other, neither a significant endangering of structural safety nor a change in load-carrying behaviour has an only local deterioration of the interlayer of large-scale architectural LSG panes.

In order to avoid visual damages of LSG (whitening or delamination of interlayer) in outdoor applications, it is recommended to protect edges thoroughly and effectively (e.g. canopy with stepped LSG), or generally avoid water access resp. penetration.

With respect to structural elements under high compressive loading (e.g. columns) delamination could be significant due to possible instabilities (e.g. local buckling). For glass constructions with point fixings instabilities could not be excluded in case of delamination.

When considering LSG used for photovoltaic applications severe problems with functionality may occur if moisture concentration exceeds specific values.

Aging of the interlayer due to UV-radiation and temperature is dependent on its intensity and duration and can mostly be neglected because of high dosage of UV-blocker inside the interlayer. Moreover, UV-aging is resulting in a stiffer material behaviour, and therefore not adversely affecting the structural safety.

The assumption of a general aging factor for LSG completely reducing adhesion of glass-interlayer can be abandoned.

### **2.2.6 Design shear modulus of PVB- interlayer in dependence of temperature and time during wind loading**

Apart from the pure physical description of the time-dependant viscoelastic behaviour of PVB layers, there is the question of what value should be used in a static calculation respectively for the design under combined action. This value should be considered as an effective value, taking into account the

- lower occurrence probability of higher temperatures combined with high wind loading and
- exposure time (time period) of wind gust load which is assumed to be sinusoidal.

Whereas in some countries the shear modulus for the PVB layer it is allowed to be taken into account, at least for short term loading, in other countries this is generally not allowed, even not for short term wind loading (see Code Review No. 20 and Code Review No. 39). Therefore, further investigation and knowledge on a safe and at the same time realistic value is needed.

In [150] [170] it is suggested, to simulate a time- and temperature- dependent distribution of the effective shear modulus by evaluating the wind load, exposure time of gust and associated temperature. For this, in a simulation, laminated glass panes with different geometry and cross-sections are loaded by these spectral values. The 2%- fractile of this distribution can be regarded as characteristic stress. By evaluating this 2%- fractile of the stress- distribution of sections with unknown shear modulus but containing information on exposure time and temperature and equalling this with the 2%- fractile of the spectrum without temperature and exposure time, then the relevant shear modulus  $G_k = G_d$  can be derived.

In Figure 2-10 the correlation of the maximum of exterior air temperatures with the gust wind velocities for a city in Germany is shown. These evaluations have been performed for a variety of locations in Germany representing middle Europe. In further investigations it came out, that the correlation of the temperature of the glass with gust velocity, Figure 2-11, depends on whether the panel is being weathered from two sides or only from one side, i.e. the other side is exposed to the interior of a building.

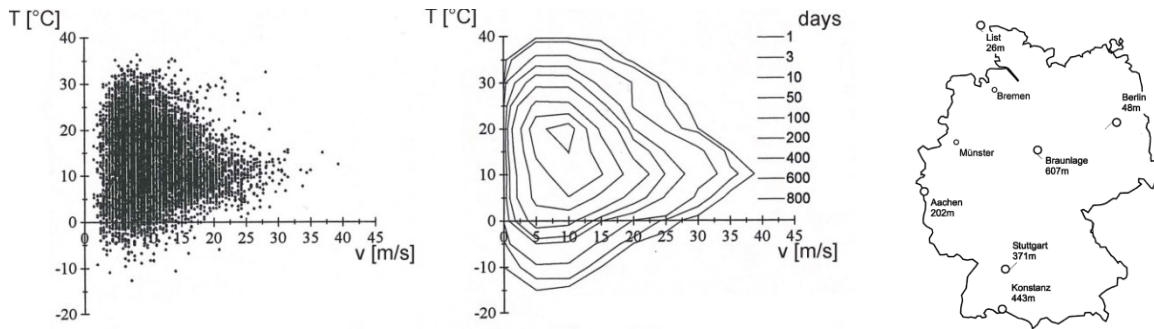
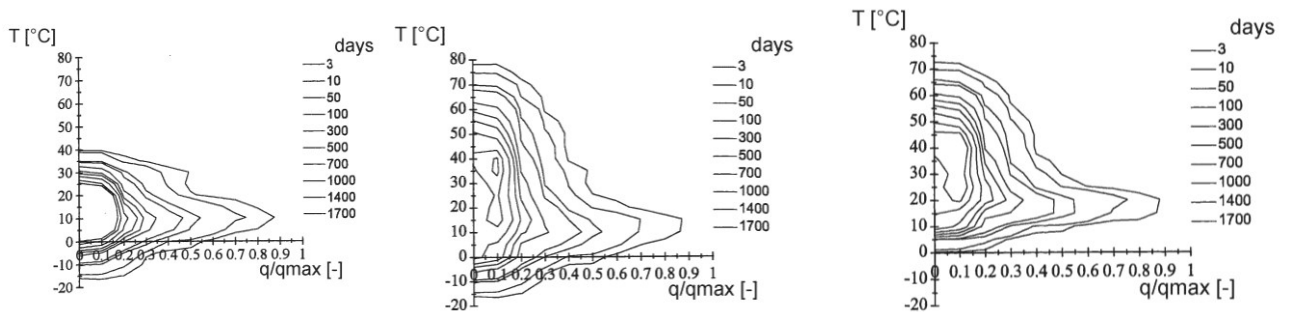


Figure 2-10 Correlation of maximum gust wind speed and maximum exterior temperatures for the city of Aachen and overview of other considered locations [150]



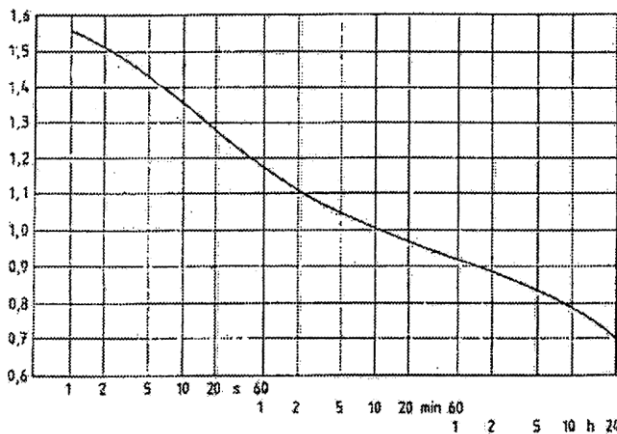
Maximal exterior temperature

Temperature of the assembly (exterior temperature on both sides of the assembly)

Temperature of the assembly (exterior temperature on one side, 23°C on the other side)

Figure 2-11 Correlation gust - wind load with air- temperature as well as correlation of the gust wind load with the temperature of the structure; interpolated lines are of same occurrence probability, extreme values per day in 100 years [150] (Germany)

Using the dependencies of the mean wind velocities respectively the gust factor on the regarded interval as shown in Figure 2-11, the wind velocities as well as the wind pressures for 3 seconds, 10 minutes and 24 hours can be determined. Thereby, due to the similarity, the 24 hour interval can be also considered as a 96 hour interval which is regarded to be the time in which a storm is moving over a geographical location.



$$v_{3s} = \frac{1,47}{1,56} v_{1s} = 0,94 v_{1s}$$

$$v_{10min} = \frac{1}{1,47} v_{3s} = 0,68 v_{3s}$$

$$v_{24h} = \frac{0,70}{1,47} v_{3s} = 0,48 v_{3s}$$

Figure 2-12 Gust factor  $G_B$  in 10 m height above ground, related to 10 minutes as equalising interval [150]

$$q_{3s} = q_{max}$$

$$q_{10min} = 0,68^2 q_{max} \approx 0,50 q_{max}$$

$$q_{24h} = q_{96h} = 0,48^2 q_{max} \approx 0,25 q_{max}$$

As a simplification, for each peak wind load incidence also the surrounding longer lasting wind pressures can be obtained. This is important since for longer exposure times the shear modulus drops significantly. Using Boltzmann's law, the so obtained wind pressures can be introduced into the function of the time dependant shear moduli  $G(t)$  so that finally, the stresses can be calculated. Further considering the relation of glass and air temperature according to Figure 2-11, simplified relations of glass-temperature to time and wind load are obtained, Figure 2-13.

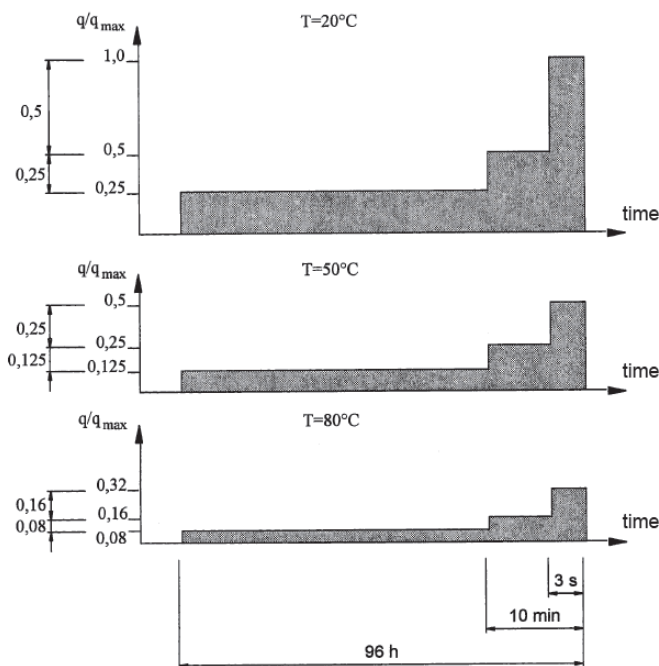


Figure 2-13 Wind load depending on glass temperature and exposure time of the gust [150]

With the correlation according to Figure 2-11 and Figure 2-12, then the bending stresses  $\sigma_{max,v}$  can be calculated. By variation of the sectional composition, colour and geometry a minimum value for the shear modulus of  $G_w = 0.4 \text{ N/mm}^2$  can be obtained.

Using a similar procedure for the load case „snow“ a shear modulus of  $G_s = 0.6 \text{ N/mm}^2$  is obtained [150]. These derivations however are only valid for linear problems, e.g. panels with transverse loading whereas for nonlinear problems (such as buckling) the values should be treated with further estimation as to whether the resulting difference is of significance.

An alternative and very simple recommendation shows Figure 2-14. Both for the case “exterior – exterior” as well as for the case “exterior – interior”, show that for ambient exterior temperatures  $> 25^\circ\text{C}$ , the characteristic wind load drops down to 50% of the maximum characteristic wind load. Assuming that there is no composite action at temperatures above  $25^\circ\text{C}$ , but a minimum shear modulus of  $G = 0.6 \text{ N/mm}^2$  is up to  $25^\circ\text{C}$  active during a three second interval (gust time period), then the following rules may be derived:

- The laminate can be calculated for 50% of the wind load without composite action and
- with a shear modulus of  $G = 0.6 \text{ N/mm}^2$  for 100% of the wind load.
- When stability needs to be considered the deflection due to 50% wind load without composite action has to be taken as the initial imperfection (together with the geometrical eccentricity) for subsequent calculation of the short term stability effect using the elastic shear modulus of  $G = 0.6 \text{ N/mm}^2$ .

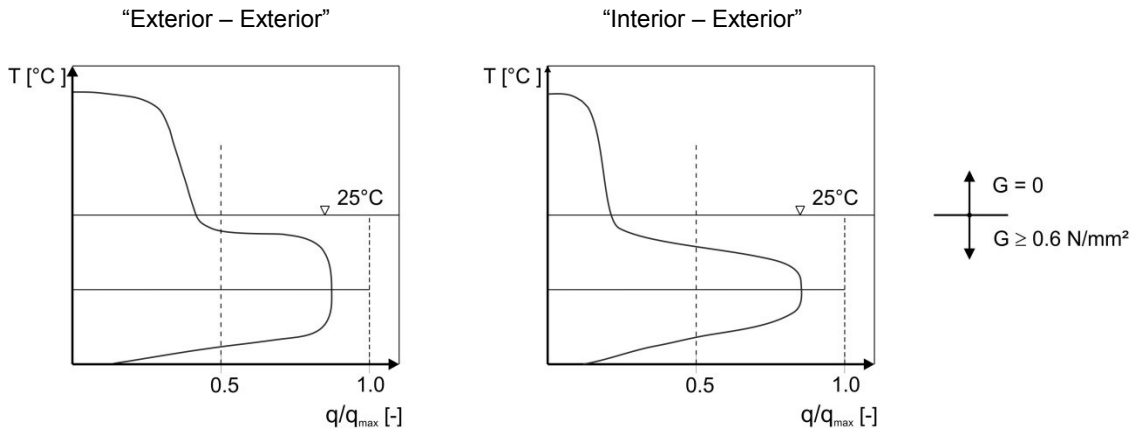


Figure 2-14 Temperature- loading curve with  $q/q_{max} = 0.50$  at  $T = 25^\circ\text{C}$

The proposal as presented refers to the limit states considering loading without reversal. When cyclic loading occurs, further considerations will apply. To expand this to some general European approach similar correlations should be made in other geographical regions.

### Eurocode Outlook No. 6

- (1) *The Eurocode should include a design concept for laminated glass that takes into account the different climatic conditions in Europe (correlation of gust-factor and temperature) to evaluate a safe shear modulus.*
- (2) *The Eurocode should enable transient calculation depending on the viscoelastic behaviour of the different interlayers taking into consideration thermal effects and load duration in a mechanically consistent way.*





### 3 Products

#### 3.1 General

Figure 3-1 shows a chart of the processing steps of the glass production. In the following chapters the glass products respective process are described and special characteristics are pointed out.

#### Eurocode Outlook No. 7

(1) *The Eurocode should refer to flat or bent glass in annealed, heat strengthened or thermally toughened quality.*

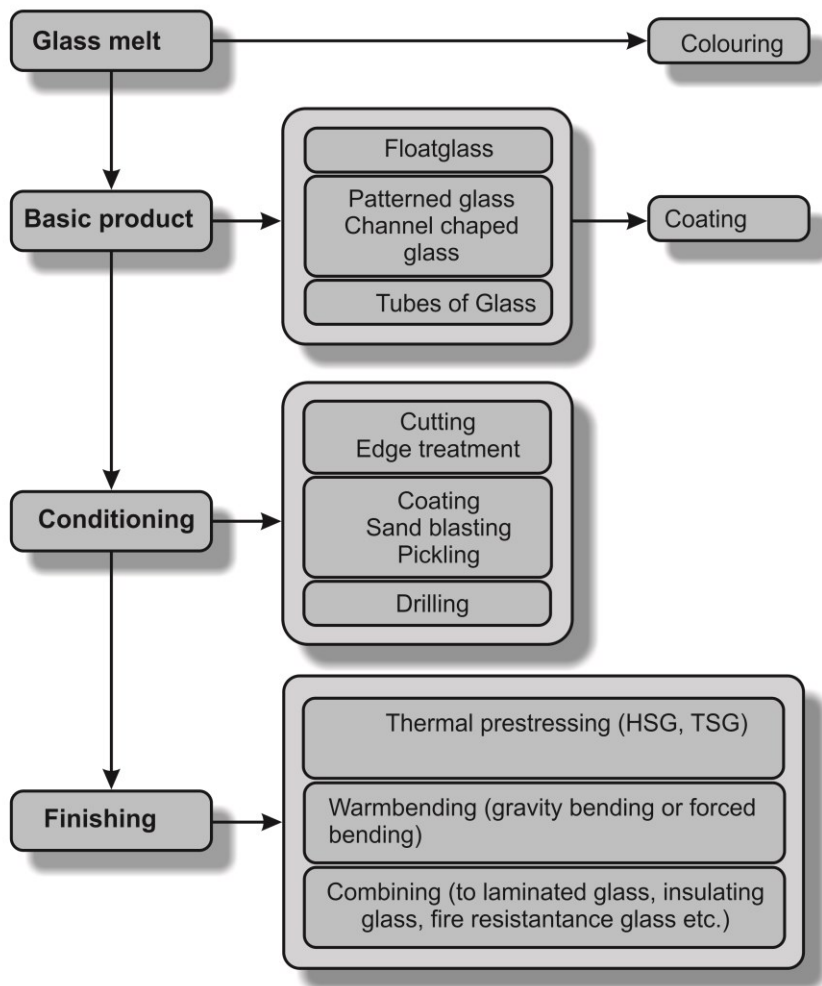


Figure 3-1 Overview of the most important glass products and the steps of processing

## 3.2 Float glass

### 3.2.1 General

Float glass, as the most important glass product, is the general material used for windows, facades, interior glazing and automotive applications. From the basic product it can be processed to thermally toughened glass (chapter 3.6), heat strengthened glass (chapter 3.7), laminated glass (chapter 3.8), curved glass (chapter 3.9) or chemically strengthened glass (chapter 3.10). The denomination “float glass” originates from the glass process where the glass melt “floats” on a liquid bed of tin. Meanwhile, the float process is the most common production technique. Compared to patterned glass (chapter 3.3) the thickness of panels is constant. Float glass is cooled down very slowly, hence there are only very few residual stresses induced in the panels (“annealed glass”).

### Code Review No. 9

Product standard:

*EN 572-2 [2]: The product standard for float glass specifies a bending strength of 45 MPa for zone 1. This value is not a property that the glass has to fulfil but can be regarded as a calculative stress limit.*

German building Regulations [47]:

*The characteristic bending strength of 45 MPa must be confirmed by the producer.*

Tabelle 2: Überprüfungen der charakteristischen Biegefestigkeit von 45 N/mm<sup>2</sup> [5 % Fraktile, 95 % Aussagewahrscheinlichkeit], jeweils Mindest-Mittelwert in N/mm<sup>2</sup>

Probenanzahl	Variationskoeffizient				
	0,28	0,25	0,20	0,15	0,10
5	n.z.*	n.z.*	n.z.*	83	51
10	n.z.*	n.z.*	88	59	43
20	128	102	71	52	41
30	110	91	66	50	40

\* nicht zulässig

### 3.2.2 Geometrical properties

The material properties are described in chapter 2.1. The maximum dimensions of standard float glass panels are 3.21 m x 6.0 m [2]. But also larger glass panels can be delivered on special request. The following nominal thicknesses are generally available:

- 2, 3, 4, 5 and 6 mm with a tolerance of 0.2 mm
- 8, 10 and 12 mm with a tolerance of 0.3 mm
- 15 mm with a tolerance of 0.5 mm and
- 19 and 25 mm with a tolerance of 1.0 mm.

The production of 25 mm thick glass is very limited due to the costs and manufacturing challenges.

## Code Review No. 10

*Design codes:*

*DIN 18008 [44]/NEN 2608 [45]: These design codes deal with individual glass panes of nominal thicknesses from 3 to 19 mm.*

*DIN 18008 [44]/prEN 16612 [37]: The design value of the thickness is the nominal value.*

*NEN 2608 [45]: The design value of the thickness is the nominal value minus the tolerance.*

## Eurocode Outlook No. 8

- (1) *A design value for the thickness should be defined according to EN 1990 [38].*
- (2) *For PV applications the minimum thickness should be reduced to values of 1,5 mm to 2 mm.*

### 3.2.3 Surface processing

The **surface properties** of float glass depend on different **types of processing**:

- Abrading the surface like polishing, grinding, etching or sandblasting,
- Coating like metalizing, printing or enamelling.

In view of structural purposes the surface treatment may have a detrimental effect on the bending strength of the glass panels.

## Code Review No. 11

*EN 1096 [8]:*

*The product standard for coated glass does not give a bending strength depending on the type of coating.*

## Eurocode Outlook No. 9

- (1) *The Eurocode should define if and for which types of coatings a potential strength reduction can be neglected.*

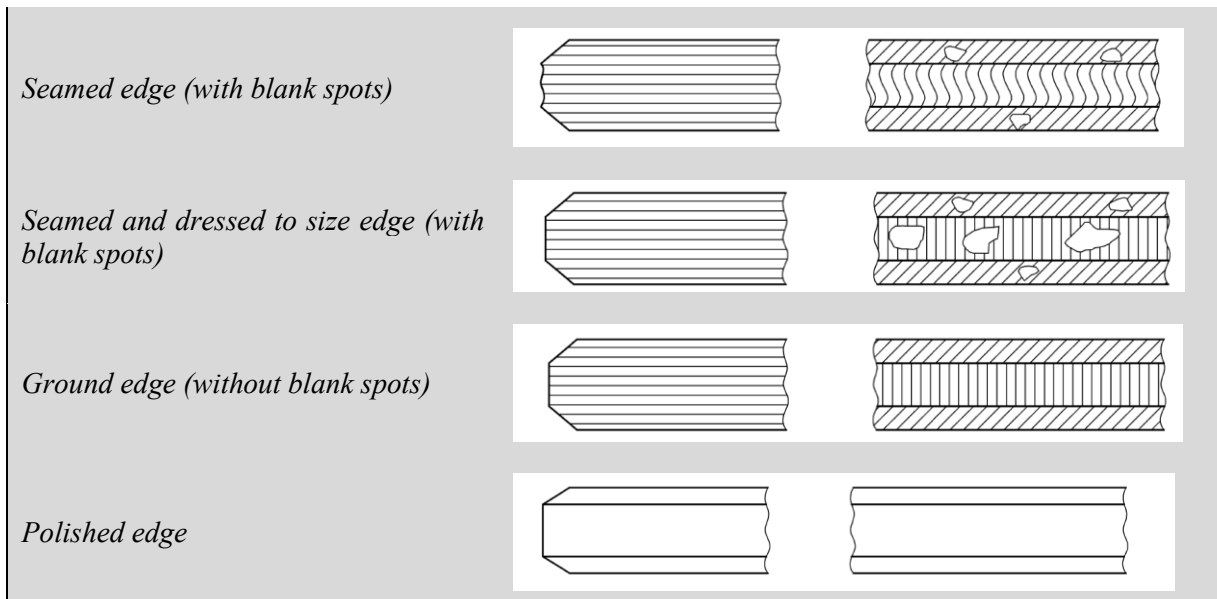
### 3.2.4 Forming

In advance to processing such as toughening, the glass panes have to be already cut. There are different types of edge processing.

## Code Review No. 12

*Product standards:*

*EN 12150 [11] / EN 1863 [10]:*



### 3.3 Patterned glass

The surface of patterned glass is characterised by a special texture being imprinted in the hot glass. Like float glass patterned glass is annealed. There is a variety of surface patterns available. Difficulties arise whilst determining a defined thickness. Therefore the nominal thickness of patterned glass is measured at four points. Hereby, the size of the measurement device has a diameter of  $50 \pm 5$  mm [5]. Naturally, the thickness tolerances are much higher compared to float glass. Patterned glass panels can be processed to thermally toughened glass. Compared to float glass patterned glass is basically used only for non-structural applications with low failure consequences.

### Code Review No. 13

Product standard:

EN 572-5 [5]:

The product standard for patterned glass does not specify a bending strength.

German building Regulations [47]:

The characteristic bending strength of patterned glass is specified to 25 MPa. The value must be confirmed by the producer.

Tabelle 3: Überprüfungen der charakteristischen Biegefestigkeit von 25 N/mm<sup>2</sup> (5 % Fraktile, 95 % Aussagewahrscheinlichkeit), jeweils Mindest-Mittelwert in N/mm<sup>2</sup>

Probenanzahl	Variationskoeffizient				
	0,28	0,25	0,20	0,15	0,10
5	n.z.*	n.z.*	n.z.*	46	28
10	n.z.*	n.z.*	49	33	24
20	71	57	39	29	23
30	61	51	37	28	22

## Eurocode Outlook No. 10

- |  |
|--|
| <p>(1) <i>The Eurocode should define a method to determine the bending strength of different classes of patterned glass in consistent manner.</i></p> <p>(2) <i>Reference should be made to the existing product standards and also to the test standards.</i></p> |
|--|

### 3.4 Wired glass

Glass can also be produced with a wire netting inside. This product was used as a “safety glass” in some countries. Its main use is as fire resistance glass. For some application (small panels) wired glass is being used in other applications, e.g. for monolithic overhead glazing.

## Code Review No. 14

Product standard:

*EN 572-6 [6]: The product standard for wired patterned glass does not specify a bending strength.*

Design Code:

*DIN 18008-2 [44]: Linearly supported glazing: Wired patterned glass is allowed for small overhead glazing with a maximum span of 0,7 m and an edge cover of 15 mm.*

## Eurocode Outlook No. 11

- |  |
|--|
| <p>(1) <i>The Eurocode should define for which temperature difference wired glass can be applied or give methods to determine glass stresses from temperature loads.</i></p> |
|--|

### 3.5 Drawn sheet glass

Until the 1960ies drawn sheet glass was the standard product for flat glass. Nowadays drawn sheet glasses are fully replaced by float glasses. This product may still be relevant but only for renovation projects. Drawn sheet glass can be treated as float glass.

## Code Review No. 15

Product standard:

*EN 572-4 [4]: The product standard for drawn sheet glass does not specify a bending strength.*

### 3.6 Thermally toughened glass (TTG)

Basic product for thermally toughened glass is float glass or patterned glass. For structural applications mainly thermally toughened glass made of float glass is used, whereas thermally toughened patterned glass is used e.g. for solar applications.

The following explanations mainly refer to thermally toughened glass made of float glass.

Caused by the tempering process the surface of thermally toughened glass may become uneven so that optical warping effects can be observed. This property is not interesting for

the structural application but it has to be taken into account when further processing to a laminated section.

## Code Review No. 16

*Product standard:*

*EN 12150 [11]: The product standard for thermally toughened glass specifies a characteristic bending strength of 120 MPa for zone 1.*

Thermally toughened glass made of float glass is generally available in the following thicknesses: 2, 3, 4, 5, 6, 8, 10, 12, 15, 19 and 25 mm (25 mm is not a standard product). Thermally toughened glass made of patterned glass is produced in thicknesses of 3, 4, 5, 6, 8 and 10 mm.

For architectural applications, thermally toughened 2 mm and 3 mm glass are not standard product since most architectural grade furnaces do not have sufficient quench power. Newly, thin pre-stressed glass is used in the middle of triple insulating glass panels to reduce weight, these panels are pre-stressed, but the level of pre-stressing is often undefined.

If further fabrication procedures are necessary, they generally have to be performed prior to the tempering process. For instance very important fabrication procedures are:

- Drilling the glass panel. Here a minimum distance to the edges, a minimum distance between the holes (pitch) and a minimum diameter of the respective hole should be considered.
- Edge processing as specified in the product standard.

## Code Review No. 17

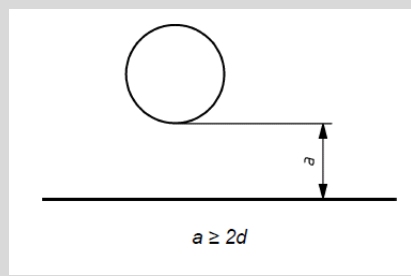
*Product standard:*

*EN 12150 [11]: The standard for thermally toughened glass gives specifications for the minimum distance of holes to the edges, the minimum distance to the edges, the minimum diameter and the minimum distance between two holes. The specifications are dealing with cylindrical holes and are applied in the scope of manufacturing drilled glass panels.*

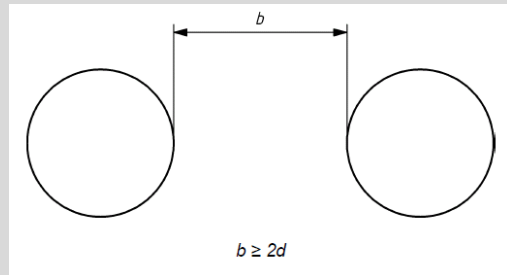
*The diameter of holes,  $\varnothing$ , shall not, in general, be less than the nominal thickness of the glass. For smaller holes, the manufacturers should be consulted.*

*In general, the limitations on hole positions relative to the edges of the glass pane, the corners of the glass pane and to each other depends on: the nominal glass thickness ( $d$ ); the dimensions of the pane ( $B$ ,  $H$ ); the hole diameter ( $\varnothing$ ); the shape of the pane and the number of holes.*

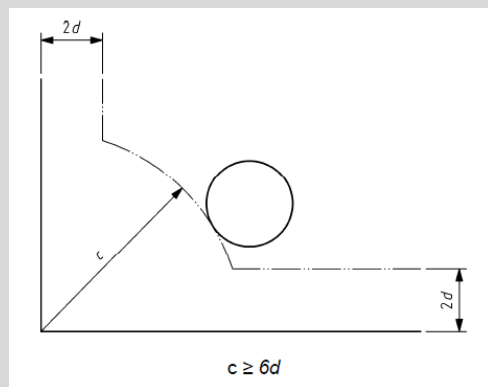
*The recommendations given below are those which are normally available and are limited to panes with a maximum of 4 holes.*



*The distance,  $a$ , of the edge of a hole to the glass edge should be not less than  $2d$ .*



*The distance,  $b$ , between the edges of two holes should be not less than  $2d$ .*



*The distance,  $c$ , of the edge of a hole to the corner of the glass should be not less than  $6d$ .*

Design standards:

Design Rules for “loaded” holes can be found in: DIN 18008-3 [44], ÖNORM B 3716-5 [48], NEN 2608 [45]

The characteristic bending strength of thermally toughened glass is given in the product standard:  $f_k = 120 \text{ N/mm}^2$  (see Code Review No. 16).

During the tempering process an enamelling can be burned in. The potential detrimental effect on the bending resistance must be taken into account (therefore for enamelled thermally toughened glass:  $f_k = 90 \text{ N/mm}^2$ ).

There is a risk of spontaneous breakage of thermally toughened glass due to nickel sulphide inclusions (NiS) in the glass melt. The reason for NiS-spontaneous fracture is lying in traces of nickel and sulphur in the glass melt forming inclusions that over time undergo a phase change and develop an internal local pressure – with the result of breakage. This phenomenon appears normally during the first ten years after installation of a glass panel, also occurrences are known until 20 years after manufacturing. The risk of critical NiS inclusions of float glass produced in Europe is around 1 in 10 tonnes of glass [116].

To minimize the risk of a spontaneous glass breakage toughened glass can be subjected to a second process, a “heat soak test” to produce heat soaked toughened glass. The risk is significantly reduced by heat soaking depending on the heating rate and the holding time.

### Code Review No. 18

Product standards:

*DIN 18516-4 [50]: The product standard for claddings for external walls made of thermally toughened glass specifies a procedure for the heat soak test.*

*EN 14179-1 [14]: The product standard specifies a heat soaked thermally toughened glass.*

National Building Regulations:

*E.g. in Germany the “Bauregelliste” (official list of codes and products to be used in construction) [47] specifies the product ESG-H (heat soaked TSG). The heat soak test procedures differ from the mentioned product standards.*

Design Standards:

*NEN 2608 [45]: The Netherland design code demands heat soaked thermally toughened glass for CC2 applications.*

*DIN 18008 [44]: The German design codes demand ESG-H e.g. for facades.*

### Eurocode Outlook No. 12

- (1) *A harmonized Heat-soak-test under consideration of the recent research results should be specified in the Eurocode. The application of such a Heat-soak-test should be required for special secondary elements and for all primary elements. Recent research progress allows for specification of a relation between the failure probability due to a nickel sulphide inclusion and a Consequence class.*
- (2) *Depending on the application (Photovoltaic or thin insulating glass units) a definition of different levels of prestress between thermally toughened glass and heat strengthened glass might be meaningful.*
- (3) *The Eurocode should define which types of enamels lead to the value of 90 MPa.*

## 3.7 Heat strengthened glass (HSG)

Like thermally toughened glass the so-called heat strengthened glass is also pre-stressed through a thermal treatment. Basically, the level of pre-stressing is significantly lower whereas the process is more challenging. Heat strengthened glass is intended for glass with a higher resistance than float but with a breakage structure with large pieces comparable to annealed glass. The applications are mainly laminated glass panels used for components with residual resistance requirements and an aspired higher bending strength than float glass.

Compared to chapter 3.6 above the following points are different:

- Heat strengthened glass made of float glass, patterned glass or drawn sheet glass is produced with a nominal thickness of 2, 3, 4, 5, 6, 8, 10 and 12 mm.
- The level of pre-stressing is lower, so the breakage pattern is characterized by relatively large shards with references to the destructive test of the product standard.



- The bending strength of heat strengthened glass made of float glass is  $f_{k,Zone 1} = 70$  N/mm<sup>2</sup>.
- There is effectively no significant risk of collapse due to NiS-spontaneous breakage, also because heat strengthened glass is normally used as a laminated glass.

### Code Review No. 19

Product standard:

EN 1863 [10]: The product standard for heat strengthened glass specifies a characteristic bending strength of 70 MPa for zone 1.

National Building Regulations:

Due to the difficult production process for heat strengthened glass, e.g. in Germany a special Technical Approval is prescribed.

### 3.8 Laminated and laminated safety glass

A laminated glass is a combination of two or more glass layers connected with an interlayer such that the cross section responds mechanically with a composite effect. There are different types of interlayers available with various properties (chapter 2.2).

Depending on the composition of the laminated glass the variety of properties is intended for, e.g.:

- Fire resistance
- Impact resistance
- Acoustic insulation
- Burglar glass

For structural glass the following properties are important being fulfilled from laminated safety glass:

- Sticking of broken glass pieces
- Limitation of a gap
- Residual resistance
- Minimisation of the injury risk

Historically the laminated safety glass has been developed for the automotive industry to avoid injuries in case of accidents. The standard interlayer material so far has been PVB (polyvinyl butyral) with viscoelastic properties. The stiffness highly depends on the load duration and the temperature (chapter 2.2), especially at temperatures larger than 25°C the shear modulus drops drastically. A simple PVB-interlayer has a thickness of 0.38 mm. Normally two layers (0.76 mm), four layers (1.52 mm) or for special applications six layers (2.28 mm) can be combined.

Other interlayer materials are also used for various applications, including cast-in-place resins (usually polymethyl methacrylate or polyester), EVA, polyurethane and ionomer.

Ionomer interlayers developed for hurricane glazing, offer further resistance properties of laminated glass in terms of high shear stiffness and strength, also at temperatures between

25°C and 50°C, and thus provides very good residual resistance. Stiffer grades of PVB interlayer are now beginning to penetrate the market and some of these products are comparable in stiffness to the ionomer interlayers – particularly at the lower temperature ranges.

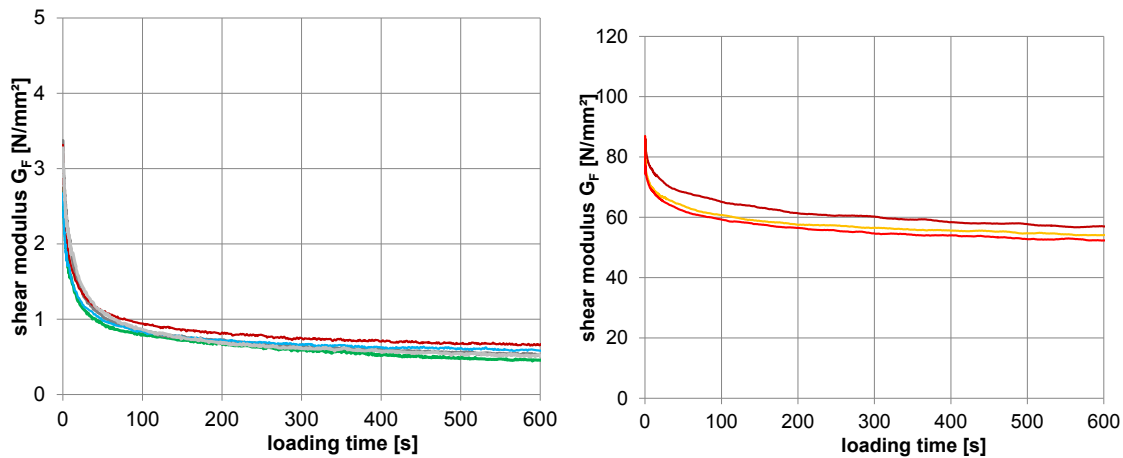


Figure 3-2 Shear modulus depending on the loading time ( $T = 23^{\circ}\text{C}$ ), left: PVB, right: Ionomer

In terms of the static behaviour of glass components (plates, columns or beams) the stiffness of the interlayer is important.

Difficulties arise when determining the relevant shear stiffness of the interlayer. The product standard does not give stiffness values or a harmonised test procedure for the determination of these different stiffness values (s. chapter 2.2)

It is remarkable that European countries are dealing with the shear stiffness of the interlayer materials in rather different ways. In some countries there are stiffness values given in the design code, e.g. for PVB, other countries demand a technical approval for laminated glass, so that the properties of the interlayers are warranted, and yet others do not allow for entry of the shear stiffness at all.

## Code Review No. 20

Product standard: EN ISO 12543 [13]: No shear modulus is given in the product standard.

Test standard: prEN 16613 [22]: Tests methods for the determination of the shear stiffness are specified.

Technical approvals: Technical approvals exist with proved shear modulus for PVB and Ionomer (e.g. [77]).

Design standard, e.g.:

DIN 18008 [44]: In cases of shear bond is favourable, it is not allowed to be taken into account. However, it must fully be taken into account, if the shear bond is unfavourable. A laminated glass panel can be assumed as monolithic if a dynamic loading is acting on the panel. A shear bond can be assumed by using a product with a technical approval.

NEN 2608 [45]: Formulas are given to calculate a shear transfer factor with the “Prony”-series of PVB.

ÖNORM B 3716 [48]: For short time loading a shear modulus of  $G = 0,4 \text{ N/mm}^2$  can be assumed. For unfavourable shear effects a monolithic behaviour must be assumed. The background to this

*value is documented in chapter 2.2.5.*

### **Eurocode Outlook No. 13**

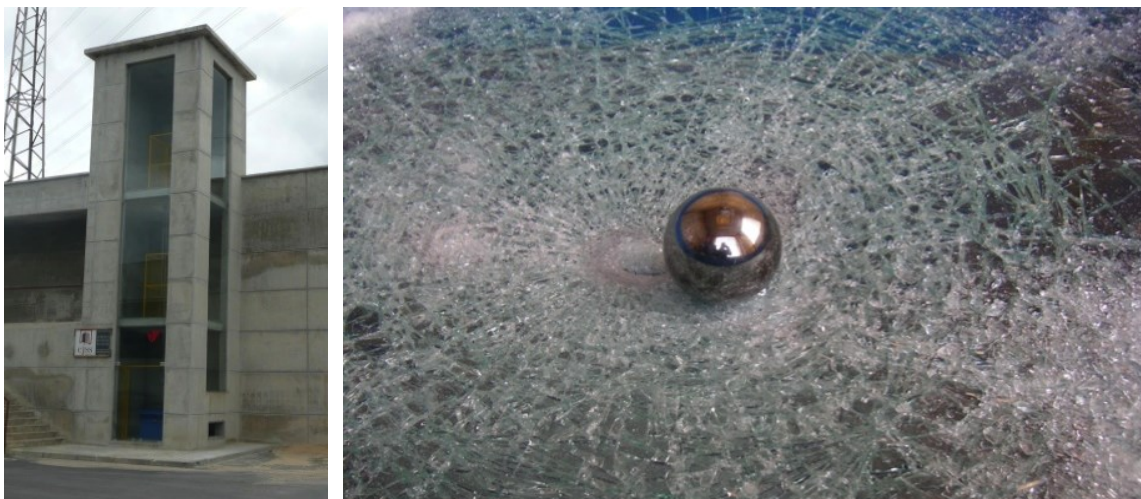
- (1) *The Eurocode should specify the minimum allowable shear modulus of those interlayers that have passed an approval procedure. Thereby the time- and temperature-dependencies should be taken into account in a way that is as simple as possible, but also should give the opportunity to make transient calculations based on polymer mechanical models.*
- (2) *The referred testing procedures should be performed and evaluated such that the results can be regarded as realistic and safe sided for structural applications and should give enough information to enable transient calculations.*

Fire glazing is also laminated glass. The laminates can be made of different types of glass (e.g. float glass or thermally toughened glass) connected with special fire interlayers and/or materials like PVB. There are three different types of fire glazing [16] (fire resistance classifications):

- E: protection of fire and smoke
- EW: protection of fire and smoke as well as reduce of thermal radiation (limited to 15 kW/m<sup>2</sup>)
- EI: protection of fire and smoke as well as reduce of thermal radiation in terms of an insulation

For design calculations the laminate of the fire glazing can be treated as normal laminated glass depending on the type of interlayer. The mechanical behaviour of the interlayer should be proved by testing.

In terms of safety, several test and classification standards have been published (see Code Review No. 21). The manner of testing is depending on the intended application of the glass component.



*Figure 3-3 Test tower for 9 m high hard body drop and glass specimen broken but not perforated after hard body drop test [127]*

## Code Review No. 21

### Test standards:

EN 12600 [21]: Pendulum test – Impact test method and classification for flat glass, see Code Review No. 51.

EN 356 [23]: Testing and classification of resistance against manual attack

EN 1063 [24]: Testing and classification of resistance against bullet attack

EN 13541 [25]: Testing and classification of resistance against explosion pressure

### 3.9 Thermally curved glass

Basically, thermally curved glass panels are made of float glass. There are four different types of production methods used to introduce the curvature:

- Gravity bending and annealing: After heating the glass panel up to 600 °C, under use of gravity the glass panel “sags” into the desired form. Afterwards the glass panel is cooled down slowly to anneal it. An annealed curved glass panel shows similar strength qualities like to annealed flat glass.
- Gravity bending and quenching in a mould: After heating the glass up to 600°C, under use of gravity the glass panel “falls” into the desired form into the mould. With the glass still in the mould it is cooled down very fast. Depending on the cooling rate the glass panel provides a quality in terms of pre-stressing like heat strengthened or thermally toughened glass.
- Gravity bending and quenching in a bending quench: After heating up the glass panel up to 600°C, under use of gravity the glass “falls” into the desired form set by the quench, after which is cooled down very fast. Depending on the cooling rate the glass panel provides a quality in terms of pre-stressing like heat strengthened or thermally toughened glass.
- Pressure bending: After heating up to 600 °C, the glass panel is pressed in the desired form (in general only cylindrical shape, but it can be curved in two directions) and cooled down very fast. Depending on the cooling rate the glass panel provides a quality in terms of pre-stressing like heat strengthened or thermally toughened glass.

The process is more difficult compared to the production of flat glass especially in view of a reliable pre-stress. Further, processing to laminated glass or insulation glass is common.

No product standards exist for curved glass panels that may give a bending strength. Despite of this curved glass is frequently used.

However, recent results have shown that the quality of curved glass, particularly that produced by gravity bending and quenching in a mould, is not quite comparable to flat glass. This concerns not only the geometrical tolerances but also the strength values. The quality control should therefore be much more severe than for flat glass.

With regard to the design rules, there are special issues that should be taken into account for curved glass: The climatic loading of insulating glass panels is higher compared to flat glass, which is caused by the higher geometrical stiffness. Further, the effects of deformations of the substructure should carefully be taken into account as curved glass responds to support-displacements with significantly higher inner forces and stresses.

**Code Review No. 22**Product standard:

*ISO/DIS 11485: Curved Glass: This draft specifies the product “curved glass”. However, there are no strength values given. Concerning the homogeneity of the residual stresses of curved thermally toughened glass the specified quality and the defined “values” are relatively low.*

Technical approval:

*In Germany, there are technical approvals existing for curved annealed glass and curved laminated glass. Technical approvals for thermally toughened glass are under preparation.*

**3.10 Chemically strengthened glass**

Chemical strengthening represents a different method to improve the bending resistance of annealed glass. Compared to thermally strengthened glass, where the breakage structure changes totally caused by the pre-stressing, the influence of the chemical strengthening is limited to some micrometres into the material’s depth close to the surface. The peak strengthening is higher, but due to the low inner penetration depth it can be “easily” damaged by scratching. In general, the use of chemically strengthened glass is for optical reasons (higher quality). Some further application fields can be found in the aeronautical industry.

The bending strength of chemically tempered glass is given to  $f_{k,Zone 1} = 150 \text{ N/mm}^2$ , but it is well known that the scatter of the strength values is very large.

Compared to thermal pre-stressing, only relative small pane sizes are able to be chemically pre-stressed.

**Code Review No. 23**Product standard:

*EN 12337 [12]: The product standard of chemically heat strengthened glass specifies a characteristic strength value of  $150 \text{ N/mm}^2$  for chemically strengthened glass.*

**Eurocode Outlook No. 14**

- (1) *The design of chemically prestressed glass should not be considered in the Eurocode if it is not possible to define characteristic values for different types of qualities and ensure quality management.*

**3.11 Insulating glass**

Insulating glass is one of the most important glass products. It can be made of all the glass types mentioned before. To obtain an insulation effect two or more glass panels are connected together by an edge seal. As the cavity between the glass panels is gas-tight (width of 12 up to 22 mm) it can be filled with dehumidified air or inert gas to improve the effectivity of the insulation. In the market double (two glass panels with one cavity) or triple glazing (three glass panels with two cavities) are available.

The durability of an insulation glass unit is about 20 (to 30) years. After this time a loss of the insulation property can be observed by the occurrence of white or grey humidity traces in the interior of the cavity.

Due to the closed cavity there is an additional inner loading that has to be taken into account. The so-called “climatic loading” originates from climatic effects (change of temperature or ambient air pressure) and the different altitude on site compared to that in the factory. These effects cause stresses that have to be taken into account in the mechanical assessment of the glass (chapter 6.1) (see Code Review No. 44).

Further, there are different types of systems and materials used for the edge bond of insulating glass units that will not be further explained here.

### **Eurocode Outlook No. 15**

- (1) *Eurocode should consider the climatic loading action effects, at least in cases where they have negative influences on the safety.*
- (2) *Apart from the product standards, the Eurocode should specify the expected lifetime of insulating glass in view of the structural verification and its supposed time period which may be different from those of the product standards.*

### **3.12 Channel shaped glass**

In Europe channel shaped glass is known to be produced only by two factories. The basic product is manufactured similar to patterned glass. The difference is that while the hot glass is still plastically deformable “two wings” are bent into a U-section, so that a profile is created with high geometrical stiffness after cooling. A processing to insulating glazing or laminated glass is not possible, but thermally toughened glass can be produced.

There is a European standard to determine the profile bending strength. Channel shaped glass is used for vertical applications like facades. The application rules so far available are specified in a technical approval.

### **Code Review No. 24**

Product standards:

*EN 572-7 [7]: This standard specifies the geometrical properties and tolerances of channel shaped glass but does not give any strength values.*

*prEN 15683 [15]: This standard specifies thermally toughened channel shaped glass.*

Test standard:

*EN 1288-4 [20]: This standard specifies a test method analogous to the application of channel shaped glass (vertical installation with distributed loading). The bending resistance is given as “profile bending resistance” assuming that the tests are evaluated linearly although there is a significant geometrical non-linearity existing.*

Technical approvals:

*In Germany Technical approvals exist for the application of annealed channel shaped glass [74] [75].*

## **Eurocode Outlook No. 16**

(1) *Also due to limited number of producers the design of channel shaped glass should not be considered in the Eurocode.*





## 4 Principles and Basic Rules for the design of glass components and safety approach

### 4.1 General

What differentiates the design of structural glass elements from almost any other construction material is the fact that glass can break unexpectedly and without fault of the design or engineer. Perhaps the glass edge was scratched or chipped during manufacture or transportation; or perhaps the glass has sustained surface damage during service due to a hard body impact which went unnoticed; or perhaps the glass contained an impurity such as Nickel Sulphide which has subsequently changed phase and size in service. Whatever the reason, the designer of a structural glass system must bear in mind that any element of the structure might break unexpectedly at some point during the service life of the material and when this happens, the structural integrity of the overall system must not be compromised to the extent that progressive collapse of the entire structure is initiated.

According to the design concept of EN 1990 – Eurocode 0 [38] the **verification in the Serviceability Limit State (SLS)** is mainly aimed at the limitation of the deflection of the structural elements. The limits depend on the application cases or the support conditions; however, concerning the design of structural glass, they are different according to the recent national codes across the European countries.

The **verification in Ultimate Limit state (ULS)** is intended to fulfil the structural safety, thus it has to be carried out under very small occurrence probabilities of overloading and lower material strength. For structural glass the safety assessment can be performed by a limitation of the stresses under relevant load combinations. If there are several vector components of stresses then, unlike for other materials, the maximum principal stresses have to be considered.

The definition of the design value  $R_d$  for glass components is different in the various European member states. Parameters are:

- Annealed or tempered glass
- Plate or in-plane loading
- Time duration of the loading
- Material safety factor
- Redundancy of laminated glass
- Reduction of the design value caused by edge effects
- Consideration of special applications
- Reduction depending on the glass surface profile (e.g. float glass or drawn sheet glass, as produced, sandblasted or polished)
- Type of production method in case of thermally toughened glass (vertical or horizontal)

Examples can be taken from the following Code Reviews. Figure 1-7 explains the statistical interpretation of design values for the verification in the ULS.

**Code Review No. 25**

<i>Design standard: Calculation of <math>R_d</math> according to DIN 18008 [44]</i>	
<i>Prestressed glass</i>	<i>Annealed glass</i>
$R_d = \frac{k_c \cdot f_k}{\gamma_M}$	$R_d = \frac{k_{mod} \cdot k_c \cdot f_k}{\gamma_M}$
<i>Material partial factor</i>	
$\gamma_M = 1.5$	$\gamma_M = 1.8$
<i>Coefficient respecting the type of construction <math>k_c</math></i>	
$k_c = 1.0$	$k_c = 1.8$ for linearly supported panels, otherwise $k_c = 1.0$
	Factor of load duration/corrosion $k_{mod}$ : $k_{mod,permanent} = 0.25$ $k_{mod,middle} = 0.40$ $k_{mod,short} = 0.70$ Definition of the load duration: see Code Review No. 2
	Reduction on 80% at the glass edge
In case of laminated glass the resistances can be increased by 10%.	

**Code Review No. 26**

<i>Design standard: Calculation of <math>R_d</math> according to prEN 16612 [37] and prNBN S23-002 [49]</i>	
<i>Prestressed glass</i>	<i>Annealed glass</i>
$R_d = \frac{k_{mod} \cdot k_{sp} \cdot f_{g,k}}{\gamma_{M,A}} + \frac{k_V \cdot (f_{b,k} - f_{g,k})}{\gamma_{M,V}}$	$R_d = \frac{k_{mod} \cdot k_{sp} \cdot f_{g,k}}{\gamma_{M,A}}$
<i>Material partial factor</i>	
$\gamma_{M,V} = 1.2$	$\gamma_{M,A} = 1.8$
<i>Strength</i>	
$f_{g,k}$ : Characteristic value of the bending strength of annealed glass	
$f_{b,k}$ : bending strength according to the product standard of prestressed glass	
Factor of load duration $k_{mod} = 0.663t^{-1/16}$	
$t$ : load duration in hours; $k_{mod,min} = 0.25$ , $k_{mod,max} = 1$ , Definition of the load duration: see Code Review No. 2.	
$k_V$ : Strengthening factor of prestressed glass (depending on the manufacturing process), 1.0 for horizontal toughening, 0.6 for vertical toughening	
$k_{sp}$ : factor for the glass surface profile, e.g. 1.0 for float glass and 0.75 for patterned glass	

**Code Review No. 27**

<i>Design standard: Calculation of <math>R_d</math> according to Ö B 3716 [48]</i>	
<i>Prestressed glass</i>	<i>Annealed glass</i>
$R_d = \frac{k_{mod} \cdot k_b \cdot f_k}{\gamma_M}$	
<i>Material partial factor: <math>\gamma_M = 1.5</math> for Float, Laminated glass made of float, heat strengthened glass, thermally toughened glass and <math>\gamma_M = 2.0</math> for wired glass and patterned glass</i>	
<i>Coefficient depending on the type of loading <math>k_b</math>: <math>k_b = 1.0</math> perpendicular to the plate and <math>k_b = 0.8</math> in-plane loading</i>	
<i>Factor of load duration/corrosion <math>k_{mod}</math>:</i>	
$k_{mod} = 1.0$	$k_{mod,permanent} = 0.6; k_{mod,middle} = 0.6; k_{mod,short} = 1.0$
<i>Reduction on 80% at the glass edge</i>	

**Code Review No. 28**

<i>Design standard: Calculation of <math>R_d</math> according to NEN 2608 [45]</i>	
<i>Prestressed glass</i>	<i>Annealed glass</i>
$R_d = \frac{k_{mod} \cdot k_a \cdot k_e \cdot k_{sp} \cdot f_k}{\gamma_{M,A}} + \frac{k_z \cdot k_e \cdot (f_{b,k} - k_{sp} \cdot f_{g,k})}{\gamma_{M,V}}$	$R_d = \frac{k_{mod} \cdot k_a \cdot k_e \cdot k_{sp} \cdot f_k}{\gamma_{M,A}}$
<i>Material partial factor</i>	
$\gamma_{M,V} = 1.2$	$\gamma_{M,A} = 1.8$ if wind is the dominant load $\gamma_{M,A} = 2.0$ for remaining loads
<i>Coefficient depending on the type of loading <math>k_e</math></i>	
$k_e = 1.0$ perpendicular to the plate $k_e = 0.62$ in-plane loading for heat strengthened glass $k_e = 1.0$ in-plane loading for thermally toughened glass	$k_e = 0.8$ perpendicular to the plate $k_e = 0.62$ in-plane loading
$k_a$ non-linearity: $k_a = 1.644 \cdot A^{1/25}$ with $A =$ Area of the loading in $[mm^2]$	
<i>Factor of load duration <math>k_{mod} = \left(\frac{5}{t}\right)^{1/c}</math>, <math>t</math>: load duration in seconds; <math>k_{mod,min} = 0.25</math>, <math>k_{mod,max} = 1</math>; <math>c</math>: constant of corrosion</i>	
$k_{sp}$ : factor for the glass surface profile, e.g. 1.0 for float glass and 0.8 for patterned glass	
<i>Zone – coefficient <math>k_z</math>: Zone 1: <math>k_z = 1.0</math>; Zone 2: <math>k_z = 1.0</math> for heat strengthened glass, <math>k_z = 0.9</math> for thermally toughened glass; Zone 3 (edge): <math>k_z = 0</math>; Zone 4: <math>k_z = 1.0</math> for heat strengthened glass, <math>k_z = 0.65</math> for thermally toughened glass</i>	

## Code Review No. 29

### Design standard:

ASTM E1300 – 12ae1 [52]:

The maximum allowable stress (allowable) is a function of area ( $A$ ), load duration in seconds ( $d$ ), and probability of breakage ( $P_b$ ):

$$\sigma_{\text{allowable}} = \left( \frac{P_b}{k \cdot (d/3)^{7/n} \cdot A} \right)^{1/7}$$

where:

$\sigma_{\text{allowable}}$  = maximum allowable surface stress,

$P_b$  = probability of breakage,

$k$  = a surface flaw parameter,

$d$  = the duration of the loading,

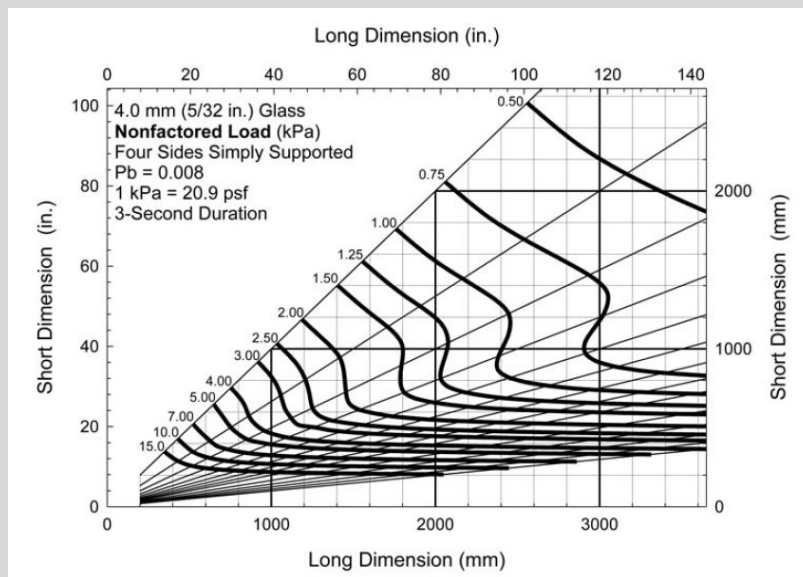
$A$  = the glass surface area, and

$n = 16$  for AN (Annealed glass).

Procedure do design secondary glass elements:

1. The specifying authority shall provide the design load (including load safety factor)
2. The non-factored load (NFL) can be derived based on design charts. NFL is a uniform lateral load that a glazing out of annealed glass (defined by size, glass thickness and supporting condition) can sustain, based upon a given probability of breakage (8/1000) and load duration (3 sec).

Example of a design chart:



3. The influences of a thermal pre stress and load durations different from 3 sec are considered in glass type factors (GFT)

**TABLE 1 Glass Type Factors (GTF) for a Single Lite of Monolithic or Laminated Glass (LG)**

Glass Type	GTF	
	Short Duration Load (3 s)	Long Duration Load (30 days)
AN	1.0	0.43
HS	2.0	1.3
FT	4.0	3.0

**TABLE 2 Glass Type Factors (GTF) for Double Glazed Insulating Glass (IG), Short Duration Load**

Lite No. 1 Monolithic Glass or Laminated Glass Type	Lite No. 2 Monolithic Glass or Laminated Glass Type					
	AN		HS		FT	
	GTF1	GTF2	GTF1	GTF2	GTF1	GTF2
AN	0.9	0.9	1.0	1.9	1.0	3.8
HS	1.9	1.0	1.8	1.8	1.9	3.8
FT	3.8	1.0	3.8	1.9	3.6	3.6

**TABLE 3 Glass Type Factors (GTF) for Double Glazed Insulating Glass (IG), Long Duration Load (30 day)**

Lite No. 1 Monolithic Glass or Laminated Glass Type	Lite No. 2 Monolithic Glass or Laminated Glass Type					
	AN		HS		FT	
	GTF1	GTF2	GTF1	GTF2	GTF1	GTF2
AN	0.39	0.39	0.43	1.25	0.43	2.85
HS	1.25	0.43	1.25	1.25	1.25	2.85
FT	2.85	0.43	2.85	1.25	2.85	2.85

4 For insulating glazing an additional load share factor (LS) is defined:

**TABLE 5 Load Share (LS) Factors for Double Glazed Insulating Glass (IG) Units**

NOTE 1—Lite No. 1 Monolithic glass, Lite No. 2 Monolithic glass, short or long duration load, or Lite No. 1 Monolithic glass, Lite No. 2 Laminated glass, short duration load only, or Lite No. 1 Laminated Glass, Lite No. 2 Laminated Glass, short or long duration load.

NOTE 2—Values are approximated. Use Vallabhan and Chou (3) for alternate method. See Appendix X3 for basis of these values.

Lite No. 1		Lite No. 2																				
Monolithic Glass		Monolithic Glass, Short or Long Duration Load or Laminated Glass, Short Duration Load Only																				
Nominal Thickness	2.5 (3/32)	2.7 (lami)		3 (1/8)		4 (5/32)		5 (9/32)		6 (1/4)		8 (5/16)		10 (3/8)		12 (1/2)		16 (5/8)		19 (3/4)		
mm (in.)	LS1 LS2	LS1 LS2	LS1 LS2	LS1 LS2	LS1 LS2	LS1 LS2	LS1 LS2	LS1 LS2	LS1 LS2	LS1 LS2	LS1 LS2	LS1 LS2	LS1 LS2	LS1 LS2	LS1 LS2	LS1 LS2	LS1 LS2	LS1 LS2	LS1 LS2	LS1 LS2		
2.5 (3/32)	2.00 2.00	2.73 1.58	3.48 1.40	6.39 1.19	10.5 1.11	18.1 1.06	41.5 1.02	73.8 1.01	169. 1.01	344. 1.00	606. 1.00											
2.7 (lami)	1.58 2.73	2.00 2.00	2.43 1.70	4.12 1.32	6.50 1.18	10.9 1.10	24.5 1.04	43.2 1.02	98.2 1.01	199. 1.01	351. 1.00											
3 (1/8)	1.40 3.48	1.70 2.43	2.00 2.00	3.18 1.46	4.83 1.26	7.91 1.14	17.4 1.06	30.4 1.03	68.8 1.01	140. 1.01	245. 1.00											
4 (5/32)	1.19 6.39	1.32 4.12	1.46 3.18	2.00 2.00	2.76 1.57	4.18 1.31	8.53 1.13	14.5 1.07	32.2 1.03	64.7 1.02	113. 1.01											
5 (9/32)	1.11 10.5	1.18 6.50	1.26 4.83	1.57 2.76	2.00 2.00	2.80 1.56	5.27 1.23	8.67 1.13	18.7 1.06	37.1 1.03	64.7 1.02											
6 (1/4)	1.06 18.1	1.10 10.9	1.14 7.91	1.31 4.18	1.56 2.80	2.00 2.00	3.37 1.42	5.26 1.23	10.8 1.10	21.1 1.05	36.4 1.03											
8 (5/16)	1.02 41.5	1.04 24.5	1.06 17.4	1.13 8.53	1.23 5.27	1.42 3.37	2.00 2.00	2.80 1.56	5.14 1.24	9.46 1.12	15.9 1.07											
10 (3/8)	1.01 73.8	1.02 43.2	1.03 30.4	1.07 14.5	1.13 8.67	1.23 5.26	1.56 2.80	2.00 2.00	3.31 1.43	5.71 1.21	9.31 1.12											
12 (1/2)	1.01 169.	1.01 98.2	1.01 68.8	1.03 32.2	1.06 18.7	1.10 10.8	1.24 5.14	1.43 3.31	2.00 2.00	3.04 1.49	4.60 1.28											
16 (5/8)	1.00 344.	1.01 199.	1.01 140.	1.02 64.7	1.03 37.1	1.05 21.1	1.12 9.46	1.21 5.71	1.49 3.04	2.00 2.00	2.76 1.57											
19 (3/4)	1.00 606.	1.00 351.	1.00 245.	1.01 113.	1.02 64.7	1.03 36.4	1.07 15.9	1.12 9.31	1.28 4.60	1.57 2.76	2.00 2.00											

5 The load resistance (LR) is defined by the product:  $LR = NFL \times GFT \times LS$

6 If the load resistance LR is less than the specified design load, then other glass types and thicknesses may be evaluated to find a suitable assembly having LR equal to or exceeding the specified design load.

**Code Review No. 30**

<i>Design standard: Calculation of <math>R_d</math> according to CNR-DT 210 [55]</i>
<i>Prestressed glass and annealed glass</i>
$R_d = \frac{k_{mod} \cdot k_{ed} \cdot k_{sf} \cdot \lambda_{gA} \cdot \lambda_{gl} \cdot f_{g,k}}{R_M \cdot \gamma_M} + \frac{k'_{ed} \cdot k_v \cdot (f_{b,k} - f_{g,k})}{R_{M,v} \cdot \gamma_{M,v}}$
<i>Material partial factor</i>
$\gamma_M = 2.55$ and $\gamma_{M,v} = 1.35$
<i>Multiplicative factor for annealed and prestressed glass, dependent on the class of consequence</i>
$R_M = \begin{cases} 0,7 & \text{I class} \\ 1 & \text{II class} \end{cases}$ and $R_{M,v} = \begin{cases} 0,9 & \text{I class} \\ 1 & \text{II class} \end{cases}$ ; class I and II according to EN 1990
<i>Strength</i>
$f_{b,k}$ : bending strength according to the product standard
<i>Factor of load duration <math>k_{mod} = 0.585t^{-1/16}</math></i>
$t$ : load duration in hours
$k_{ed}$ and $k'_{ed}$ : Coefficients on the edge and/or holes finishing
$k_{sf}$ : Coefficient dependent on the surface treatments
$k_v$ : Coefficient dependent on the prestress (or chemical) treatment
<i>Size effect coefficients</i>
$\lambda_{gA} = \left( \frac{0.24 \text{ m}^2}{k \cdot A} \right)$ , $0.75 \leq \lambda_{gA} \leq 1$ ; $A$ = loaded surface; $k$ = boundary condition coefficient
<i>Edge quality coefficients</i>
<i>polished edges:</i> $\lambda_{gl} = \left( \frac{0.1667 \cdot 0.45 \text{ m}}{k_b \cdot l_b} \right)^{1/5}$
<i>ground edges:</i> $\lambda_{gl} = \left( \frac{0.0741 \cdot 0.45 \text{ m}}{k_b \cdot l_b} \right)^{1/12.5}$
$\lambda_{gl} \leq 1$
$l_b$ : Length of the edge subjected to traction
$k_b$ : Coefficient dependent on traction distribution

Some countries require the **verification or the residual resistance** in form of an additional testing of a sufficient performance (background safety) of the supports together with an appropriate glass composition.

In the scope of the theoretical verification of accidental scenarios these have to be specified additionally, e.g. for horizontal insulating glass panels consideration of a breakage of the upper glass panel (Germany and Austria); or for horizontal laminated glass consideration of the breakage of one glass panel (Austria). The verification can be performed by considering a reduced material partial factor, i.e. use of the accidental load combination.

As another example: For sloped glazing in the UK the requirements for the glass composition depend on the installation height. Here, also the philosophy concerning the type of glazing is different compared to other countries, because also monolithic thermally toughened glass is allowed for horizontal applications.

In the following chapters the regulations together with the scope of application and the support conditions will be explained.

### Code Review No. 31

*Design Standards:*

*DIN 18008 [44]: Definition of the residual load-bearing capacity: "ability of a glazing structure to remain stable over a sufficient period for a specified damage and under defined external effects (load, temperature, etc.)." For usual applications the residual load-bearing capacity is fulfilled if standard bearing conditions and requirements for the glass assembly are used. Only for maintenance glazing and glass floors test conditions are defined in the standard.*

*NEN 2608 [45]: The verification of the residual resistance is mandatory. The accidental design combination of EN 1990 [38] is used for this purpose.*

### Eurocode Outlook No. 17

- (1) *The Eurocode should harmonize the different views on the safety concepts and residual load-bearing capacity among Europe in a consistent manner, e.g. using different classes.*

## 4.2 Classification of structural elements of glass

According to their structural importance, the loading and the failure consequences glass elements can be classified as secondary or primary element.

Characteristics of secondary elements are, that they do not take any loads from other elements or members of the superior structure and that in most cases they are loaded transversally. Examples are horizontal glazing, barriers made of glass or glass floors. Usually accessible and safe-guarding glass panels are also classified as secondary elements. However, in these domains of application the risk of failure and damage is rising. Therefore for these types of secondary elements, higher levels of safety and reliability should be required.

Secondary glass elements can be further classified according to their position, either "overhead" or "vertically".

As the predominant transversal loading produces bending stresses in the glass section, for linearly supported panes the bending resistance of zone 1 and zone 2 of the glass panels is most relevant. For point-supported glass panes additionally the bending resistance of zone 4 is also of importance. In national regulations mostly, if at all there are any design rules for structural glass, so far only the design of "standard secondary elements" is specified.

Whereas the characteristics of primary elements are, that in general they are also loaded by in-plane loads and that they can take loads from the superior (overall) structure or from other elements. Despite of available research results, there are no national or international codes in which standardized design rules can be found for the assessment of primary structural

elements of glass. Therefore, at present, for primary structural glass in most cases a unique verification will be necessary.

### 4.3 Secondary structural elements: robustness and residual capacity

#### 4.3.1 General

There are the same requirements on reliability and safety for glass structures as for other materials. However as glass always fails suddenly, i.e. no ductile post-breakage behaviour is available, special attention has to be paid for special constructive and detailing issues to obtain fail safe structures:

- Creation of redundancy and residual capacity,
- Protection against impact,
- Avoidance of contact with hard materials (e.g. steel),
- Reduction of the splinter occurrence.

The first three points aim at creating “robust” respectively “damage tolerant” structures or elements. That means, the structure must be safe and reliable such that it does not fail with unacceptable consequences, even in accidental cases. Therefore, robustness is a very important aim of the design, the level of which however depends on the structural role of the element.

For example for secondary elements that are neither accessible nor safe-guarding, the residual capacities should be such, that sufficient retention can be ensured after unscheduled breakage of a glass pane or layers of it. Thus the residual capacity depends on the

- Composition and strength of the glass section,
- Supports and bearing concept,
- Failure scenario.

#### 4.3.2 Composition and strength of the glass section

Structures with monolithic glass sections exhibit only poor residual capacities, thus mostly they are only used in case of vertical applications without any additional requirements. Adequate sections fulfilling higher requirements are therefore laminated or laminated safety glasses made of float, heat strengthened or thermally toughened glass, according to the structural purpose.

Regarding the composition of such cross-section, apart from the type of glass the residual capacity depends also on the strength of the interlayer. As an example, a fully linearly supported laminated glass panel of two layers of float glass, connected by a strong interlayer like a PVB-sheet, provides excellent residual capacity after breakage. In the area of a crack, the sectional bending forces are deviated via the upper glass layer in compression and the PVB-sheet in tension. Prerequisite to that is that the interlayer is able to carry tension forces. Compared to that a laminated section comprising only of fully toughened glass layers does not provide any residual load bearing capacity unless the interlayer is sufficiently stiff - as in the case of an ionomer. The behaviour after breakage of both layers with a PVB interlayer then, can be compared with a “wet towel” or with a “pancake”, whereas a laminated section of heat strengthened glass-layers, or a combination of heat strengthened and toughened



glass layers, provides a similar post breakage residual capacity similar to that of layers of float (due to significantly larger shards, clamping together). Note that the post breakage residual capacity of laminated glass is the better, the “better” the support conditions are, see next chapter.

#### 4.3.3 Supports and bearing concept

Another determining factor for the residual load carrying capacity after breakage is the type of support and its concept. For instance glass pieces can pull out of the fixations of the substructure after breakage and drop down, with a high potential of injuring people if the supports are not adequate despite of having large glass shards. Therefore a two-sided line-type support should not be used, unless the type of glass is laminated made of float or heat strengthened quality. Known from experience, sufficient residual capacities can be achieved if there are other parts of the substructure underneath the glass panel (rails, beams, transversal elements etc.) that may serve as additional support in case of breakage. Also point-supports together with laminated glass are favourable, as the point-supports can carry horizontal or in-plane forces produced by the interlayer (membrane) after breakage.

#### 4.3.4 Failure scenario

Unless other knowledge is available, the assessment of residual post breakage load carrying capacity should be performed by testing. Thereby the failure scenario assumes the breakage of glass layers over a residual life time under the action of a defined residual loading. It can be assumed a failure of all glass layers or a failure of only accessible glass layers. The type of damage and the magnitude of loading may be determined by the third party in advance.

Whereas a failure of the secondary structure of glass may occur by unforeseen impact or similar, however the integrity and health of human people must not be affected. That concerns not only persons underneath the glass panel but also persons who may fall against the glass panel. In that case no big injuries should be allowed.

For accessible and safe guarding elements of glass the load bearing resistance, their further specific functions and the associated splinter effects are to be assessed specifically. In general, these investigations are carried out together with the residual capacity verifications.

Regardless of what type or concept the support is, there are exceptions for vertical glazing in dependence on the height of mounting position or on the dimension of the glass pane.

### Code Review No. 32

*National Building Regulations:*

*In Germany [47] e.g. for glazing up to 4.0 m above ground, or for glazing of greenhouses or for roof-windows with Areas < 1.6 m<sup>2</sup>, there are no special rules to be obeyed. Reason for this is a drastically reduced risk of damage in these cases.*

**Eurocode Outlook No. 18**

- (1) *The corresponding failure scenario should be adapted individually using different classes of failure consequences.*
- (2) *Different European countries require different levels of post breakage safety. This should be managed by values or rules that may be adjusted by the national application documents (NAD).*

Bomb blast is a specific scenario which can engage a glazed façade, requiring further characteristics of robustness and damage tolerance to preserve integrity and health of human people. To such respect, special attention should be paid to the possible generation of glass splinters, to their energy and related flight trajectory (see chapter 4.5.2).

As a consequence, a clear definition (by analysis and by testing) of the post-breakage behaviour of a glass element becomes of paramount importance in this case and the application of laminated glass, as well as of appropriate supports, are key features of an effective design.

**Code Review No. 33**Test Standards:

*EN 13541 [25]: This European Standard specifies a test method, performance requirements and classification for explosion pressure resistant glazing for use in buildings. It concerns a method of test against blast waves generated using a shock tube or similar facility to simulate a high explosive detonation. The classification is only valid for tested glass sizes of about 1 m<sup>2</sup>. Based on theoretical considerations and/or experimental work, the results can be used for estimating the explosion-pressure-resistance of other glass sizes.*

*EN 13123-1 [26]: This European Standard specifies the criteria which windows, doors and shutters shall satisfy to achieve a classification when submitted to the test method described in EN 13124-1. It concerns a method of test against blast waves generated by using a shock tube facility to simulate a high explosive detonation in the order of 100 kg to 2 500 kg TNT at distances from about 35 m to 50 m.*

*EN 13123-2 [26]: This European Standard specifies the criteria which windows, doors and shutters shall satisfy to achieve a classification when submitted to the test method described in EN 13124-2. It concerns a test method against blast waves in open air resulting from high explosives that can be carried by hand and placed a few metres from a target. Controlled measurement of the actual blast on the face of the test specimen being difficult, costly and subject to inaccuracy, consistency of the blast forces is therefore controlled in this standard by the characteristics of the explosive charge and its location.*

*EN 13124-1 [27]: This European Standard specifies a conventional test procedure to permit classification of the explosion resistance of windows, doors and shutter together with their infill. It concerns a method of test against blast waves generated by using a shock tube facility to simulate a high explosive detonation in the order of 100 kg to 2 500 kg TNT at distances from about 35 m to 50 m.*

*EN 13124-2 [27]: This European Standard specifies a test procedure to permit classification of the explosion resistance of windows, doors and shutters together with their infill. It concerns a test method against blast waves in open air resulting from high explosives that can be carried by hand and placed a few metres from a target.*

*ISO 16933 [28]: This ISO Standard provides a structured procedure to determine the air-blast resistance of glazing and sets forth the required apparatus, procedures, specimens, other requirements and guidelines for conducting arena air-blast tests of security glazing. Seven standard blasts simulating vehicle bombs and seven standard blasts simulating smaller satchel bombs that can be used to classify glazing performance are incorporated in this International Standard. Classification and ratings are assigned based on the performance of glazing loaded by air-blast pressures and impulses.*

## Eurocode Outlook No. 19

- (1) *Eurocode should specify the glass strength (for annealed, heat strengthened and thermally tempered glass) for very fast loading conditions, like blast events based on experimental and theoretical data to be evaluated in research.*
- (2) *Eurocode should alert the reader about the importance of a “fully dynamic approach” (i.e. both material properties and structure response) in the analysis for designing against blast loads. This also means that the sub-structure has to be taken into consideration next to applying test results from small size elements to full scale facades.*

### 4.3.5 Further general construction rules

The design of glass components should be performed with regard to the following:

- A glass-steel-contact or a glass-glass-contact must be avoided.
- The glass panels should be fixed in their positions with brackets or frames without excessive constraint.
- The materials of the supports must be durable for the expected life time.
- The drying of humidity near to the edges of laminated glass has to be enabled.

Recommendations like these are described in the design standards or in execution rules.

Thermal stresses should be considered in cases where relevant potential heat absorption is present. This may be caused by e.g. partial shading or coatings. E.g. in Germany, there is no thermal stress calculation method present but an appropriate type of glazing (e.g. tempered glass) is chosen in case of a potential risk of breakage due to thermal stresses. In other European countries calculation methods are present to take into account the load case “thermal stress”.

## Code Review No. 34

### Design Standards:

*NF P78-201; NF-DTU 39 [59]: The standard allows a rational choice of glass as a consequence of possible thermally induced stresses, which in turn are consequence of thermal gradients in the glass pane. Essentially, this document allows the calculation of thermal gradients in the glass pane and a comparison with allowable values.*

*It accounts for:*

- *Boundary conditions, e.g. frame inertia, stores, ventilation, proximity to heating devices, shadows, etc.*
- *Climatic conditions, e.g. seasonal environmental temperatures, solar irradiation, etc.*

- *Special installation conditions, e.g. stepped glass, overhanging glass panes, sliding doors, etc.*

*It proposes three calculation methods, of different level, to ascertain the temperature gradients in the glass pane:*

- 1) *Calculation in transitory state: this is the most general and precise one, applicable to any condition; it is quite complicated and it requires to deal with it by means of a numerical computing method.*
- 2) *Calculation in steady state: it is a simplified approach, it can be applied only in case of low inertia frames (as defined in the standard). It allows a less precise and more conservative result.*
- 3) *Hand calculation in steady state: it is a simplified approach, it can be applied only in case of low inertia frames (as defined in the standard). It allows a less precise and more conservative result.*

*Finally, the calculated temperature gradients can be compared with allowable ones, depending upon thermal treatment of glass, edge finishing and shape, frame thermal inertia, etc.*

*A European draft for a thermal stress calculation method exists [51]. This draft is based on design methods used in the UK [86], Belgium [87] and France [59]. The results of the calculation are a necessary type of glass (annealed or tempered) and a necessary edge finishing depending on the thermal restraints. Thereby the design value is the allowable temperature difference  $\Delta T$  in the glass plane. Values are given in the product standards.*

*Furthermore the ASTM-Code E2431-06 185 [53] gives a method to calculate the resistance of annealed glass to thermal loading. The failure modus due to thermal stresses is given by the edge resistance of zone 2. According to EN 1990 in [51] there is no relation between a failure probability and the material resistance. The values are rather based on experience. Nevertheless the ASTM-Code [53] gives a relation between the glass size, the thermal load and the edge resistance.*

## **Eurocode Outlook No. 20**

- (1) *A calculation method for the load case “thermal stresses” should be established in the Eurocode. The existing methods should be analysed and adjusted to fit with the Eurocode safety framework (mean value, standard deviation and design value). This means that also the loads from other Eurocodes have to be adopted to the specific need in glass design.*

## **4.4 Primary structural elements: glass-robustness and damage tolerance**

If structural glass is used for primary elements, the field where available standards and codes regulate the design and define the level of safety is left. This is for instance the case for columns, shear panels used for bracing systems, lattice girders with glass elements, beams subject to bending etc.

Here, apart from the theoretical assessment of the ultimate load bearing capacity a considerable robustness has always to be verified additionally, the requirements of which are of course significantly higher as those for secondary elements. However despite of a good degree of scientific and technical knowledge, rules on this have not been introduced in codification so far.

Thus for primary elements of glass normally a unique verification procedure will apply. Thereby an individual safety concept with regard to the loading and unforeseen breakage

has to be elaborated. This comprises also the assigns use of the structure, damage likelihood, damage consequences and the adjunct risk of damage respectively failure. Finally an increased quality assessment of material, fabrication and erection should be installed.

Characteristics of robustness and damage tolerance of primary structural elements may be:

- Redundancies of the overall structure. Herewith the creation of background load carrying mechanisms is meant, that can be activated and which prevent a total failure of the building or whole structure.
- Redundancies of the cross-section. This can be achieved by the choice of laminated glass with an adequate composition and balance of strength, size of shards, strength of interlayer and ductility of interlayer, in order to provide a safe residual capacity in case of breakage of one of the glass layers. Although this requirement is already necessary within the scope of secondary elements, here they are higher as no failure of the element can be allowed due to the fact that primary elements take over loads of the global structure.
- Protection against hard impact. Like for secondary elements the load carrying inner glass layers are to be protected against any hit or any impact. Thus they are to be protected by outer layers of glass in a laminated package. The edges of the load carrying “core layers” should or may (according to the use of the element) also be protected against hard impact. Contrary to secondary elements again the requirements here are considerably higher.
- Prevention of Steel-Glass-Contact or contact with hard materials. Not only an unscheduled contact with hard materials, such as steel or concrete has to be generally avoided, but also in the design of the load introduction special attention must be paid in view of a smooth distribution of the load and avoidance of stress peaks. This may be enabled by the use of reliable mortar fillings/layers or polymeric components.
- Protection of people against splinters and shards that may fall down or threaten people else how: this is analogous to secondary elements.

About fire actions there should be clarifications whether fire is a design issue for the component or not. If so, then protective means (fire glass) or additional robustness and/or redundancy measures (background safety in case of failure of glass due to fire) need to be applied.

The wall-like or pane-like glass columns of the Rheinbach-pavillon, Figure 4-1, may serve as an example for the above mentioned considerations. The roof of which is solely carried by vertical laminated glass panes. These glass-columns are oriented towards two perpendicular directions in the ground layout, so that they also take over the lateral bracing of the building. That means that forces from tension, compression and wind moments (and also from impact and imperfections) are introduced in plane of the glass panels. Additionally, transverse loads (wind loads) have to be carried perpendicular to the plane of the glass.



Figure 4-1 Centre of German Glazing handcrafters in Rheinbach, Germany

## 4.5 Special loading situations

### 4.5.1 Seismic structures

In a seismic area the seismic action has to be considered [55]. Experiences show that the collapse of secondary glass components may result in a high number of death and injuries.

Eurocode 8 gives the rules for considering of seismic actions and for their combination with other actions. Thus, the action effects  $E_d$  may include also seismic effects. In seismic areas, the verification of ULS is intended to include **Seismic Ultimate Limit State verification**. What regards the earthquake resistance of buildings, three different categories of glass members are identified: (1) Earthquake resisting structural elements entirely made of glass; (2) Structural elements made of glass and other materials, of recognized ductility; (3) Glass members not pertaining to the earthquake resisting structure but relevant for the inhabitant safety, typically interior wall panels in glass, or curtain walls at the building perimeter.

The first category, in accordance with 5.5.2.1 of EN 1990 shall be designed and constructed to withstand the design seismic action without cracking (defined for combination see 6.4.3.4 of EN 1990). In terms of EN1998, this assumes a behaviour factor  $q = 1$ . Thus, a glass structure shall retain its structural integrity after the seismic event.

The design seismic action for the no-collapse requirement is expressed in terms of the seismic action associated with a reference probability of more than 2% within the reference return period.

Buildings whose earthquake resisting structure incorporates elements made of glass and other materials, shall be designed, so that the glass structure shall withstand without cracking the stresses computed in the loading combination including the reference seismic action (i.e. the combination 6.4.3.4 of EN 1990).

Glass members not pertaining to the earthquake resisting structure but relevant for the inhabitant safety, shall withstand without collapse the stresses computed in the loading combination including the reference seismic action.

In the calculation model of the entire building, the strength and stiffness of secondary elements is neglected on the assumption that, in case of a failure of any one of them, the ultimate resistance of the primary system nevertheless is guaranteed. However particular care should be taken in case of lateral actions coming from earthquake excitations. The stiffness provided by secondary elements in their plane may be such that they contribute significantly

to the interstory lateral stiffness, even if, due to the minimal ductility, no allowance is actually given to such stiffness in the calculation model.

Under these premises two requirements are specified:

- Under ultimate limit states, the strength and resistance of the structural system, based on primary elements only, shall be checked, and the secondary elements shall be verified for the lateral loads directly applied onto them, and for the displacements imposed by the compliance to the deformations of the primary system.
- Under damage limitation states, in case the contribution of secondary members to the overall system stiffness is relevant, this contribution shall be taken into account, and the resulting stresses on the glass secondary elements shall be added to the lateral loads directly applied onto them.

In general damage limit states are analysed for loading conditions that are less severe than under ultimate limit states, and the first loading combination in ultimate limit states is governing the design.

While, as already mentioned, damage limit states are analysed for loading conditions that are less severe than under ultimate limit states. The additional stiffness provided by secondary elements may result under seismic conditions in damage limit states requirements that are governing the design.

A secondary structural element is by definition also a secondary seismic member (element).

The interstory drifts of the building are deemed to be limited in accordance with the requirement of displacement compatibility with respect to the glass elements. This secondary seismic member and its connections shall be designed and detailed to avoid cracking during the seismic event associated with the no-collapse requirement. Moreover, a secondary member and its connection shall withstand the self-weight and the out-of-plane load, when subjected to the displacements caused by the most unfavourable seismic design condition. Due allowance of second order effects ( $P - \delta$  effects) should be made in the design of secondary seismic members.

Glass secondary structural elements in seismic areas should be constructed after the hardening of the concrete structures or the assembly of the steel frame. These elements can be in contact with the structures (i.e. without special separation joints), but shall be without structural connection to it.

Independently from the safety margin of the compatibility verification, for the secondary structural elements appropriate measures should be taken to avoid cracking, brittle failure and disintegration of the glass during an earthquake due to the drift of the structure. Conversely, the partial or total out-of-plane collapse of the elements is unlikely, since the strength-to-mass ratio of a glass element is very high.

The Seismic Ultimate Limit State verification of the primary seismic members has to consider that the contribution given by the glass structure to the seismic action resisting system include no ductility. Accordingly, the glass structure may belong to the lateral and vertical force resisting system only, while it cannot belong to the energy-dissipation systems.

Consequently, the Seismic Ultimate Limit State verifications have to be based on linear analyses with energy behaviour factor equal to one (i.e. no energy dissipation and no ductility).

A primary seismic member and its connections shall be designed and detailed to carry loads from the overall structure or from other elements (superior order), in addition to its self-weight and the out-of-plane load, when subjected to the displacements caused by the most unfavourable seismic design condition.

If the seismic action resisting system includes dissipative system (e.g. hybrid seismic structure composed of the glass system and another system, such as reinforced concrete or a steel frame), the design is required to comply with the hierarchy of resistance. To this end, the failure of the glass system is only allowed to occur for displacements greater than those produced by the seismic action associated with the no-collapse requirement. Such hierarchy of resistance aims at ensuring an overall dissipative and ductile behaviour, as it is displayed by the structures made of different material from glass. Moreover, the hierarchy of resistance aims at avoiding brittle failure or a premature formation of unstable mechanisms. To this end, resort shall be made to the capacity design procedure, which is used to obtain the hierarchy of resistance of the various structural components and failure modes necessary for ensuring a suitable plastic mechanism and for avoiding brittle failure modes.

The connection of primary seismic members shall be verified with the seismic action associated with the no-collapse requirement. The verification has to consider both relative displacements and internal actions.

### Code Review No. 35

*Technical recommendation:*

*Proposition de fiche (CSTB et SNFA) [72]:*

*Seismic action is divided in two types of solicitations: a dynamic solicitation due to ground movement and a static deformation induced by building floor drift. The amplitude of calculated action depends on building importance, type of ground and seismicity region. In France, the application of seismic reglementation based on Eurocode 8 led to recommendations on façade conception and dimensioning. The validation criterion has been chosen as no elements fall, with performance conservation for important buildings (hospitals, firehouses...).*

*The experimental tests carried out on glass façades (curtain walls and structural glazing kit) showed a large elastic deformability of the metallic frame under dynamic solicitation (succession of increasing accelerations until 16 m/s<sup>2</sup> at different frequencies between 1 and 15 Hz applied on a 3 m x 3 m mock-up) inducing few systems degradations. Degradations have been observed during floor drifting (static cyclic increasing displacement until 60 mm at the head of a 3 m x 3 m mock-up) with glass breakage.*

*Recommendations concern calculation of anchoring to the structure, dimensioning of metallic frame, type of glass to use.*

### Eurocode Outlook No. 21

- (1) *The Eurocode should give rules for glass components (secondary and primary) built in seismic areas unless they will be considered in Eurocode 8 (EN 1998) [43]. In any case the rules should comply to EC 8 general provisions.*

#### 4.5.2 Blast loads

In the last years the protection against terroristic attacks became an additional issue. When analysing bomb attacks the leading risk is actually to be heavily injured by highly accelerated



glass splinters. Therefore the performance requirements of potentially attacked buildings often contain a certain level of blast load enhancement of the façade and in particular the glazing. This enhancement is specified by a load assumption – described by a positive impulse and a peak reflected pressure – and a performance requirement – described by the allowed flight distance of glass splinters in a norm size test box. This means that laminated safety glass is allowed to break, but the glass splinters should be kept attached to the foil, or if the splinters were detached, they must not be accelerated too much.

The acceleration of the glass splinters could be limited if significant shares of the blast load energy is absorbed before the laminated glass breaks. This absorption could be achieved by plastic deformation of classical façade components or by adding additional crash elements [121].

As a result of the detonation of an explosive charge a pressure shock wave spreads initially spherical in all directions, until it is reflected by surfaces (buildings, ground). Through the explosion, a very large amount of energy is released within a few nanoseconds. The pressure increase is in a time range of nanoseconds and the duration of the overpressure phase in the range of milliseconds. The short period of overpressure is characterized by the peak overpressure  $p_{10}$  and by the time  $t_d$ . The integration of pressure over time results in the specific impulse  $I$ . The overpressure phase is followed by a negative pressure phase which is longer than the overpressure phase; the magnitude of the negative pressure is usually much lower than the magnitude of the overpressure.

Above all other influences the effective mass of explosive material, but also its height  $h_0$  above the ground and the distance to the building  $R$  (usually called standoff distance) affect the pressure time history of an explosion. The mass of the explosive material  $W$  is usually defined as the TNT equivalent mass (TNT= trinitrotoluene, commonly used military explosive). Other parameters are possible obstacles, such as protective walls or upstream buildings, as well as the type and geometry of the building itself. A parameter usually defined in the common practice is the scaled distance  $Z$ :

$$Z = \frac{R}{\sqrt[3]{W}} \quad (4-1)$$

The peak reflected overpressure  $p_r$  is formed by the reflection of the incident plane shock wave which encounters a surface under some angle. The ratio of the peak reflected overpressure and incident peak overpressure is called the reflection factor. The reflection factor therefore depends on the incident peak overpressure and on the angle between the shock front and the surface.

Once the reflection factor is known, the reflected pressure time history can be derived, which has a similar time history as the incident pressure if interaction effects are neglected. Figure 4-2 shows a typical reflected pressure-time history of an explosion in air.

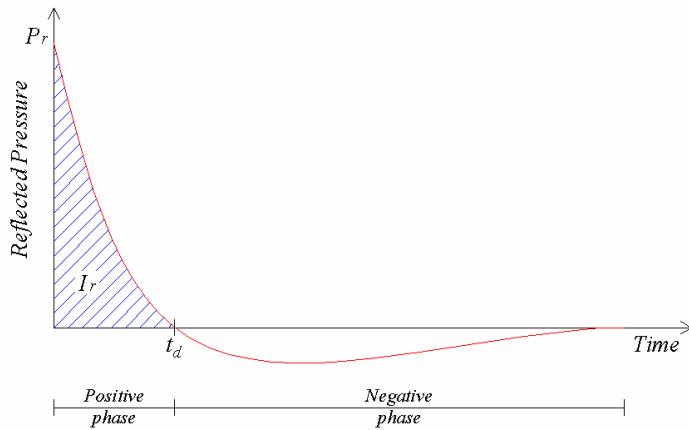


Figure 4-2 Schematic diagram of pressure time history of an explosion in air.

The determination of the complete reflected pressure time history is essential for the structural analysis, because using only the reflected peak pressure the design will typically result to become oversized.

Since it is very complex to determine the complete pressure time history due to a detonation and all reflection effects, standardized explosion load assumptions were set out first in the United States and then internationally ([73] [33] [97]). These explosion load assumptions provide a linear triangular history for the reflected pressure. The reflected pressure is characterized by the reflected peak overpressure  $p_{r0}$  and by the positive pulse  $I_r$ . The duration of the overpressure phase in this linear approach is defined by:

$$t_{d,lin} = \frac{2i_r}{\hat{P}_{r0}} \quad (4-2)$$

The influence of the negative phase is neglected in these standardized approaches. This is justified for the dynamic calculation of rigid or heavy structures (e.g. reinforced concrete structures), because the negative phase hardly affects the structural response in these cases. On the other hand the negative phase can affect significantly the structural response of lighter and more flexible systems with lower natural frequencies [98][99]. Despite this influence, which is present in cable net facades for instance, only standardized explosion load scenarios in accordance with US or ISO standard are specified in most cases. It is assumed that the failure of the façade to the internal side is the critical design intent. Therefore the impact on people in the interior of the building should be minimized. A failure of the system to the outside due to the negative phase is accepted.

In Code Review No. 36 and Code Review No. 37 the essential design loads are grouped according to the US GSA/ISC standard and according to the international ISO standard. The given quantities of explosives (TNT equivalent mass) and the so-called stand-off specify which explosives would create these loads in a ground detonation in front of a large façade.

To protect persons behind the facade from major injuries, an explosion-resistant function of the facade is frequently specified. Most specifications refer to a classification of the performance condition according to the US GSA standard (see Code Review No. 38). The GSA method classifies facades into six protection and risk classes.

### Code Review No. 36

*Design Standard: DSA [73]: Explosion scenarios of the US General Services Administration (GSA/ISC)*

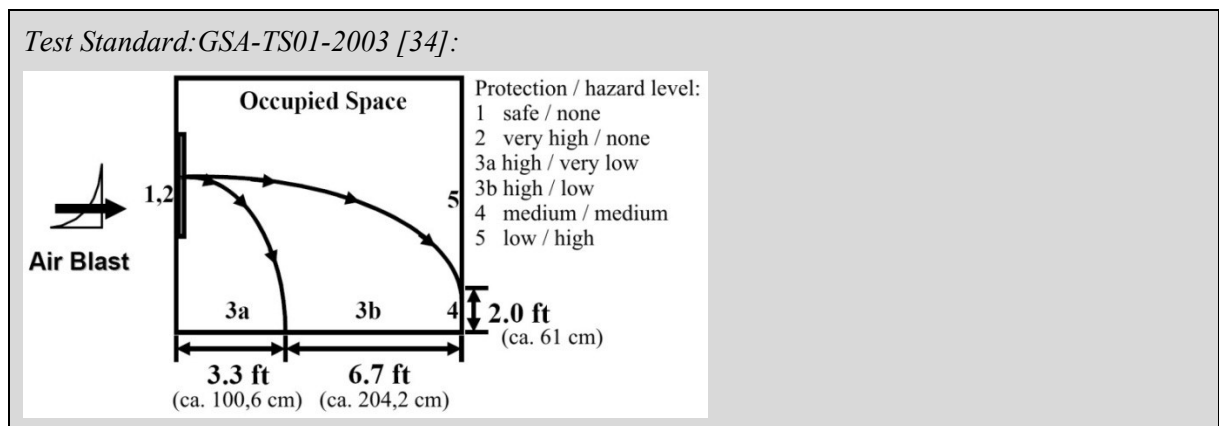
scenario	$\hat{p}_{r,0}$ [kPa]	$i_r$ [kPa ms]	$t_{d,lin}$ [ms]	mass TNT [kg]	stand-off [m]
GSA C	27,58	193,06	14,0	47,5	30
GSA D	68,95	675,71	19,6	340	34

### Code Review No. 37

*Test Standard: ISO 16933 [33]: Explosion scenarios (vehicles bombs) of the ISO 16933, Annex C1*

Class	Peak reflected overpressure	Reflected Impulse	Length of overpressure phase (linear)	Stand-off 100 kg TNT in front of small mock-up (3,15m x 3,15m)	Equivalent explosion scenario in front of large facade
	$\hat{p}_{r,0}$ [kPa]	$i_r$ [Pa s]	$t_{d,lin}$ [ms]	Stand-off [m]	TNT [kg]
EXV 45	30	180	12	45	30
EXV 33	50	250	10	33	30
EXV 25	80	380	9,5	25	40
EXV 19	140	600	8,6	19	64
EXV 15	250	850	6,8	15	80
EXV 12	450	1200	5,3	12	100
EXV 10	800	1600	5,0	10	125

### Code Review No. 38



<i>GSA/ICE performance conditions for window system response</i>			
<i>Performance Condition</i>	<i>Protection Level</i>	<i>Hazard Level</i>	<i>Description of Window Glazing Response</i>
<i>1</i>	<i>Safe</i>	<i>None</i>	<i>Glazing does not break. No visible damage to glazing or frame.</i>
<i>2</i>	<i>Very High</i>	<i>None</i>	<i>Glazing cracks but is retained by the frame. Dusting or very small fragments near sill or on floor acceptable.</i>
<i>3a</i>	<i>High</i>	<i>Very Low</i>	<i>Glazing cracks. Fragments enter space and land on floor no further than 3.3 ft. from the window.</i>
<i>3b</i>	<i>High</i>	<i>Low</i>	<i>Glazing cracks. Fragments enter space and land on floor no further than 10 ft. from the window.</i>
<i>4</i>	<i>Medium</i>	<i>Medium</i>	<i>Glazing cracks. Fragments enter space and land on floor and impact a vertical witness panel at a distance of no more than 10 ft. from the window at a height no greater than 2 ft. above the floor.</i>
<i>5</i>	<i>Low</i>	<i>High</i>	<i>Glazing cracks and window system fails catastrophically. Fragments enter space impacting a vertical witness panel at a distance of no more than 10 ft. from the window at a height greater than 2 ft. above the floor.</i>

#### 4.6 Potential classification of glass components

As mentioned before, the philosophy concerning the required type of glazing and the consideration of failure scenarios is different throughout the European countries. The following review shows an extract of national regulations concerning the classification of glazing and allowed types of glass for roof glazing without any additional requirements like maintenance scenarios.

And further, the following Eurocode Outlook gives an overview of the most used types of glass components and their type of loading. The proposed classification is related to the risk of consequences in case of a system failure.

#### Code Review No. 39

<i>Design Standards:</i>
<i>DIN 18008 [44]: The German design code distinguishes between “horizontal” and “vertical” glazing. The limit is reached when the panel is tilted with 10° out of the vertical.</i>
<i>ÖNORM B 3716 [48]: In Austria the limit is defined to 15° out of the vertical.</i>
<i>BS 5516 [54]: In the UK the limit is defined to 15° out of the vertical.</i>

#### Code Review No. 40

<i>Design Standards: Roof or canopy glazing</i>
---

*BS 5516 [54]: In the UK three categories are specified concerning the risk of injuries of glazing: Risk of injuries sustained from broken glazing falling, Risk of injuries sustained from objects falling through the glazing and Risk of injuries through the glazing while standing on it. The following regulations are related to injuries sustained from broken glazing falling:*

*Roof or canopy glazing up to five metres above floor level:*

- *Single glazing: thermally toughened glass, laminated glass or wired glass*
- *Insulating glass unit: the lower pane should be one of the types mentioned before, if the lower pane is thermally toughened glass, the upper pane should be also one of the types mentioned before.*

*Roof or canopy glazing over 5 m up to 13 m above floor level:*

- *Single glazing: laminated glass or wired glass, or thermally toughened glass with a thickness  $d \leq 6$  mm and an area  $A \leq 3$  m<sup>2</sup>*
- *Insulating glass unit: the lower pane should be one of the types mentioned before, if the lower pane is thermally toughened glass, the upper pane should be also one of the types mentioned before.*

*Roof or canopy glazing over 13 m above floor level:*

- *Single glazing: laminated glass or wired glass*

*Insulating glass unit: the lower pane should be one of the types mentioned before.*

*DIN 18008 [44]:*

*Linearly supported glass panels: The glass pane must be laminated glass made of float or heat strengthened glass ( $d_{\min,PVB} = 0.76$  mm). The minimal thickness of one glass pane is 4 mm. There are further restrictions concerning the support conditions: e.g. for glass panes supported at two opposite edges the span is limited to 1.20 m. The rule is also valid for glass panes supported at four edges with length/width-relation of 3:1. Wired glass panes are allowed up to a span of 0.8 m.*

*Horizontal point fixed glazing: laminated glass made of heat strengthened glass ( $d_{\min,PVB} = 1.52$  mm).*

*In case of an insulated glass unit it is the lower glass pane that must fulfil the requirements.*

*ÖNORM B 3716 [48]:*

*Linearly supported glass panels: Only laminated glass made of float or heat strengthened glass is allowed for a single sloping glass panel or the lower pane of an insulation glass unit. The span for glass panes supported at two opposite edges is also limited to 1.20 m.*

*Horizontal point fixed glazing: laminated glass made of heat strengthened glass*

*NBN S23 [49]: Laminated glass is required for the lower glass pane. There is no specification concerning a breakage structure.*

## Code Review No. 41

*Design Standards:*

*NEN 2608 [45]: NEN2608 gives a model that predicts the level of failure of a glass element in function of consequence and the level of exposition to a treat. There are always at least two combinations of actions that have to be met:*

- *fundamental combination without broken plies and*
- *accidental combination with broken plies (the number of broken plies can be derived with*

the “Fine and Kinney method”, NEN 2608, Annex D).

Constructional safety according to the Fine en Kinney method [45][170]

*Fine and Kinney allows to estimate the risk (RD) caused by an event. This is based on the probability of damage, exposure and the effect of that damage. The probability of that risk is than related to the level of damage of that structural member.*

*To assess the level of damage on a structural element the model of Fine and Kenny could be used. Step 1 to 3 as described below can be used for that purpose. The side of the structural element where the damage could occur is called the attack side. Only when the structural element is reachable it can be damaged by an attack.*

*NOTE For example. A floor or a wall with  $RS < 70$  in this model can only have lateral damage at one side of the element. Damage at two sides is only possible when both sides are accessible. When both sides are accessible they have to be considered separately. The leading situation must be considered in 5.4(2) and (4). When the damaged element can't directly be restored in accordance with 5.4(6), then 5.4(2) must be applied, taking into account damage arising from both attack sides.*

*Step 1: Determine the attack side of the member.*

*Step 2: Determine the risk of damage pro attack side  $RD = PD \times ED \times EFFD$*

*with  $RD$  = risk of damage  $PD$ ,  $PD$  = probability of damage (intentionally or unintentionally),  $ED$  = exposure to the risk of damage,  $EFFD$  = effect of the damage ( $PD$ ,  $ED$  and  $EFFD$  according the tables below)*

*Step 3: Determine pro attack side the level of damage according to the table below*

Example 1: Glass beam of a roof structure

*The inner side of the glass roof could be cleaned using a telescopic boom lift.*

*probability of damage  $PD$ : possible  $\rightarrow PD = 6$*

*exposure of risk  $ED$  = few times a year  $\rightarrow ED = 1$*

*effect of damage  $EFFD$  = several dead  $\rightarrow EFFD = 40$*

*Risk of damage  $RD = 6 \times 1 \times 40 = 240$*

*The event of breakage of two lateral plies must be considered.*

*Engineer judgment; it is also possible that the telescopic boom lift breaks a complete structural member of the main beam.*

Example 2: Roof plates

*The roof is walkable for cleaning and maintaining purpose.*

*probability of damage  $PD$ : possible  $\rightarrow PD = 6$*

*exposure of risk  $ED$  = few times a year  $\rightarrow ED = 1$*

*effect of damage  $EFFD$  = one dead  $\rightarrow EFFD = 15$*

*Risk of damage  $RD = 6 \times 1 \times 15 = 90$*

*In this case only the upper sheet of the plate can be reached so the event of breakage of this sheet must be considered.*

<i>Risk of damage <math>RD = PD \times ED \times EFFD</math></i>	<i>Damage of the structural element that have to be taken into account in the structural analysis</i>	
<i><math>RD &lt; 70</math></i>	<i>Lateral damage on one side</i>	
<i><math>70 &lt; RD &lt; 400</math></i>	<i>Lateral damage on two sides</i>	
<i><math>RD &gt; 400</math></i>	<i>Complete failure of one structural element (only when all components of that member are accessible)</i>	

<i>probability of damage intentionally or unintentionally =</i>	<i>Exposure to risk of damage = <math>ED</math></i>	<i>Effect of damage = <math>EFFD</math></i>
---	---	---

<i>PD</i>					
<i>Virtually impossible</i>	<i>0,1</i>	<i>Rare</i>	<i>0,5</i>	<i>First aid</i>	<i>1</i>
<i>Practical impossible</i>	<i>0,2</i>	<i>Few times a year</i>	<i>1</i>	<i>Minor injury</i>	<i>3</i>
<i>Possible but highly unlikely</i>	<i>0,5</i>	<i>Monthly</i>	<i>2</i>	<i>Severs injury</i>	<i>7</i>
<i>Only possible on long term</i>	<i>1</i>	<i>Weekly</i>	<i>3</i>	<i>One dead</i>	<i>15</i>
<i>Unusual but possible</i>	<i>3</i>	<i>Daily</i>	<i>6</i>	<i>Several dead</i>	<i>40</i>
<i>Possible</i>	<i>6</i>	<i>Constantly</i>	<i>10</i>	<i>Disaster, many dead</i>	<i>100</i>
<i>Can be expected</i>	<i>10</i>				

## Eurocode Outlook No. 22

- (1) *The Eurocode should take into account different load combinations for different classes of structural glazing. Special Consequences classes for glass should be specified, further differentiating those of EN 1990, i.e. the indicated classes do not comply with those of the current EN 1990.*
- (2) *A classification can be:*
  - CC0: Elements only responsible for its on stability, no personal loading. There are low consequences when the element fails.*
  - CC1: Elements only responsible for its own stability, personal loading. There are rather low consequences when the element fails.*
  - CC2: Primary elements or elements only responsible for its own stability, personal loading. There are medium consequences when the element fails.*
  - CC3: Primary elements. There are serious consequences when the element fails.*
- (3) *The Eurocode should establish a model to predict the consequences of a glass failure and to determine the accidental scenario.*





## 5 Mechanical basics and verification approach for monolithic and laminated plates and beams

### 5.1 General

The most frequent types of transverse loading on glass panes are continuously or equally distributed loads such as wind, snow, self-weight or traffic loads.

Whereas for small deflections ( $w < t$ ) the plate behaves linearly, for greater deformations a considerably non-linear effect becomes important (for length-to-width-ratios of 1:1 to 3:1). Because then a part of the transverse load is being carried by membrane forces due to the sagging of the plate. The occurring membrane forces are anchoring in an inner circumferential ring so that no exterior anchoring is needed. This effect is associated with in-plane deformations. Because of that, generally, in-plane and out-of-plane effects are to be considered together. The theory assumes the evenness of the cross-section according to Bernoulli and further the law of Hooke. Both assumptions are fulfilled perfectly by monolithic glass.

Today mostly glass panes are calculated numerically using FEM, in particular in cases when they are point supported. However a short description of the analytical interdependencies explains these effects.

### 5.2 Linear and non-linear plate theory

**Linear plate theory.** The well-known differential equation of a transversally loaded plate

$$\frac{E d^3}{12(1-\mu^2)} \left( \frac{\partial^4 w}{\partial x^4} + 2 \frac{\partial^4 w}{\partial x^2 \partial y^2} + \frac{\partial^4 w}{\partial y^4} \right) = q(x, y) \quad \text{respectively} \quad (5-1)$$

$$B \Delta \Delta w = q(x, y) \quad (5-2)$$

gives sufficiently exact solutions for stress and deformation in general when the deflections  $w$  are small with  $w < t$ .

**Second order effect.** The plate equation can be extended by moments from in-plane normal forces/stresses multiplied by the occurring deformations (or eccentricities)

$$\frac{E d^3}{12(1-\mu^2)} \left( \frac{\partial^4 w}{\partial x^4} + 2 \frac{\partial^4 w}{\partial x^2 \partial y^2} + \frac{\partial^4 w}{\partial y^4} \right) = d \left( \sigma_x \frac{\partial^2 w}{\partial x^2} + 2 \tau_{xy} \frac{\partial^2 w}{\partial x \partial y} + \sigma_y \frac{\partial^2 w}{\partial y^2} \right) + q(x, y) \quad (5-3)$$

or in another form

$$B(w'''' + 2w'''' + w'''' ) = d(\sigma_x w'' + 2\tau_{xy} w' + \sigma_y w'') + q(x, y) \quad (5-4)$$

For particular cases the equations can be reduced either to the bending differential equation of a beam or to the buckling differential equation of a column.

**Plate with bending together with in-plane membrane deformations (solid-distortion).**

When formulating the equilibrium at an arbitrary infinite element as well as the compatibility

of the strains and couple both information via the law of Hooke, this leads to the elastic non-linear plate-membrane differential equation according to *Airy* (without temperature restraint):

$$\frac{\partial^4 \phi}{\partial x^4} + 2 \frac{\partial^4 \phi}{\partial x^2 \partial y^2} + \frac{\partial^4 \phi}{\partial y^4} = 0 \quad \text{respectively} \quad \phi'''' + 2\phi'''' + \phi'''' = 0 \quad \text{or} \quad \Delta \Delta \phi = 0 \quad (5-5)$$

with *Airy's* stress-functions

$$\frac{\partial^2 \phi}{\partial x^2} = \phi'' = \sigma_x = \frac{N_x}{d}, \quad \frac{\partial^2 \phi}{\partial y^2} = \phi'' = \sigma_y = \frac{N_y}{d}, \quad -\frac{\partial^2 \phi}{\partial x \partial y} = -\phi'' = \tau_{xy} = \frac{N_{xy}}{d} = \tau_{yx} \quad (5-6)$$

respectively in the format

$$\left( \frac{\partial^2}{\partial y^2} - \mu \frac{\partial^2}{\partial x^2} \right) \sigma_x + \left( \frac{\partial^2}{\partial x^2} - \mu \frac{\partial^2}{\partial y^2} \right) \sigma_y - 2(1 + \mu) \frac{\partial^2}{\partial x \partial y} \tau_{xy} = 0 \quad (5-7)$$

By this the membrane differential equation is coupled to the plate differential equation via the out-of-plane deformations. This system then is non-linear describing the membrane effects e.g. caused by larger out-of-plane deformations. The so extended geometrical relationships

$$\varepsilon_{xx} = \frac{\partial u}{\partial x} + \frac{1}{2} \left( \frac{\partial w}{\partial x} \right)^2, \quad \varepsilon_{yy} = \frac{\partial v}{\partial y} + \frac{1}{2} \left( \frac{\partial w}{\partial y} \right)^2, \quad \varepsilon_{xy} = \frac{\partial u}{\partial y} + \frac{\partial v}{\partial x} + \frac{\partial w}{\partial x} + \frac{\partial w}{\partial y} \quad (5-8)$$

lead to the coupled non-linear differential equation system

$$B \Delta \Delta w = d (\ddot{\phi} w'' - 2\dot{\phi}' \dot{w}' + \phi'' \ddot{w} + q(x, y)) \quad (5-9)$$

$$\Delta \Delta \phi = E (\dot{w}'^2 - w'' \ddot{w}) \quad (5-10)$$

From these equations it can be seen that also under pure transverse loading the plate will response with membrane effects, too, and moreover these equations also show the already mentioned circumferential compression ring. However, this becomes only relevant at deformations  $> t$ , which is frequently the case in glass design.

### 5.3 Plates with monolithic sections of glass under transverse loading

The solutions for the plate equation are basically of the form (e.g. [172])

$$w = k_w \frac{a^4}{E t^3} \cdot q \quad \text{and} \quad \sigma = k_\sigma \left( \frac{a}{t} \right)^2 \cdot q \quad (5-11)$$

where the factors considering the geometry and boundary (support) conditions can be taken from the bibliography as far as an analytical calculation is preferred.

For example some solutions for rectangular and a square plate-formats are given in Figure 5-1, both for max. stress and deformation, each of them according to a linear and to a non-linear calculation. Note that the location of the relevant combination of  $\sigma_x$  and  $\sigma_y$  of the max. principal stresses are moving with increasing loading, see Figure 5-2. The calculations have been performed with appropriate computer-software [177] which is in particular dedicated to

glass-problems. By using [177] also flexible elastic edge supports, lifting corners in case not-prevented uplift, etc., can easily be considered.

Special attention has to be paid to the influence of a deformable substructure or support on the occurring stresses. This should always be checked, in particular when the full non-linear theory has been used so that in the end sufficient safety is still provided.

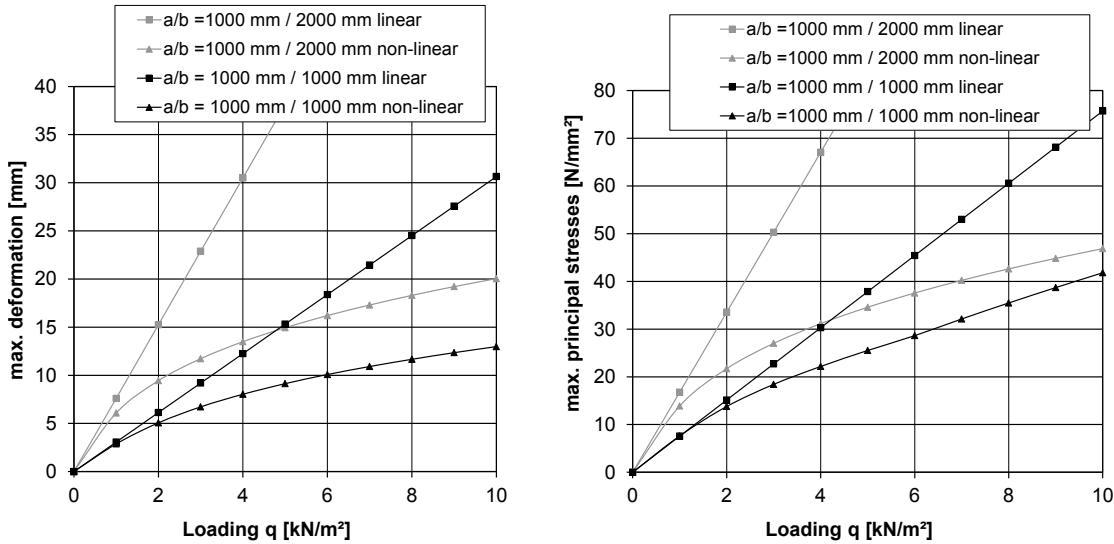


Figure 5-1 Max. deformations and max principal tension stresses of two differential glass panels (1000 mm x 1000 mm and 1000 mm x 2000 mm, linearly supported at the 4 edges according to Navier conditions) of the same thickness ( $t = 6$  mm) varying the theory of calculation (linear – non-linear) [94]

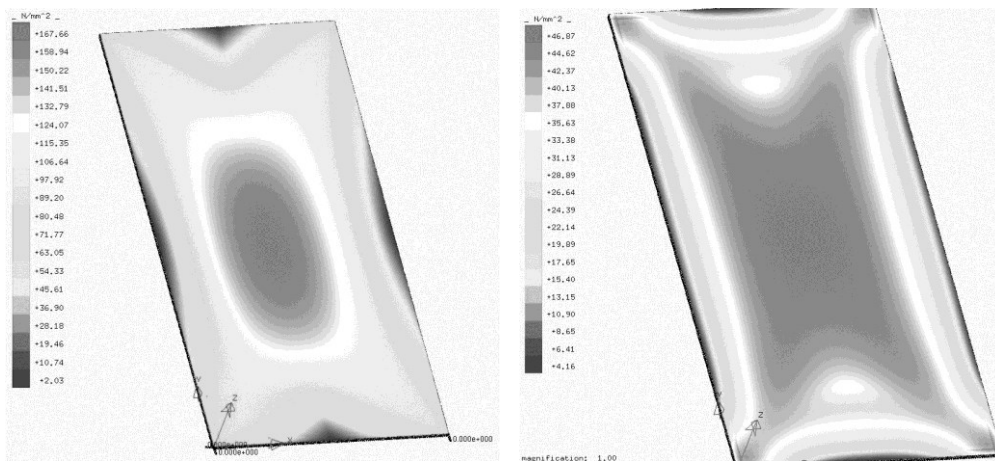


Figure 5-2 Distribution of principal tension stresses by using linear theory (left hand side) and non-linear calculation (right hand side) – Geometry of pane:  $a/b = 1000$  mm x 2000 mm [94]

## 5.4 Mechanical description of the viscoelastic behaviour of interlayers

Mechanically the viscoelastic behaviour can be described by exponential functions, either for a Kelvin-model or from a Maxwell-model, see Table 5-1.

Table 5-1 Viscoelastic Kelvin- and Maxwell-models and their functions for creep and relaxation [233]

model	3-parameter Kelvin <sup>(K)</sup> -model	3-parameter Maxwell <sup>(M)</sup> -model
scheme		
diff. equation	$\sigma + p_1 \cdot \dot{\sigma} = q_0 \cdot \varepsilon + q_1 \cdot \dot{\varepsilon}$	
creep function	$J_{ret}(t) = \frac{p_1}{q_1} + \frac{q_1 - p_1 \cdot q_0}{q_0 \cdot q_1} \left( 1 - e^{-\frac{q_0 \cdot t}{q_1}} \right)$	
relaxation function	$E(t) = q_0 + \left( \frac{q_1}{p_1} - q_0 \right) \cdot e^{-\frac{t}{p_1}}$	
parameter	$p_1^K = \frac{\eta_1}{E_0 + E_1}; q_0^K = \frac{E_0 \cdot E_1}{E_0 + E_1}; q_1^K = \frac{E_0 \cdot \eta_1}{E_0 + E_1}$	$p_1^M = \frac{\eta_1}{E_1}; q_0^M = E_0; q_1^M = \frac{E_0 + E_1}{E_1} \cdot \eta_1$
parameterized diff. equation	$\frac{1}{\lambda_{ret}} \left( \frac{1}{E_0} + \frac{1}{E_1} \right) \sigma + \frac{1}{E_0} \dot{\sigma} = \frac{1}{\lambda_{ret}} \cdot \varepsilon + \dot{\varepsilon}$ $\lambda_{ret} = \frac{\eta_1}{E_1}$	$\dot{\sigma} + \frac{1}{\lambda_{ret}} \cdot \sigma = \frac{E_0}{\lambda_{ret}} \cdot \varepsilon + (E_0 + E_1) \cdot \dot{\varepsilon} \quad \lambda_{ret} = \frac{\eta_1}{E_1}$
parameterized creep function	$J_{ret}(t) = \frac{1}{E_0} + \frac{1}{E_1} \left( 1 - e^{-\frac{t}{\lambda_{ret}}} \right)$	$J_{ret}(t) = \frac{1}{E_0 + E_1} \left( 1 + \frac{E_1}{E_0} \left( 1 - e^{-\frac{E_0}{(E_0 + E_1)} \frac{t}{\lambda_{ret}}} \right) \right)$
parameterized relaxation function	$E(t) = \frac{E_0}{E_0 + E_1} \left( E_1 + e^{-\frac{E_0 + E_1}{\eta_1} t} \right)$	$E(t) = E_0 + E_1 \cdot e^{-\frac{t}{\lambda_{ret}}}$

Both Kelvin- or Maxwell-models describe exactly the same, when comparing Kelvin with Maxwell whilst identifying the corresponding parameter  $E_i$  and  $\eta_i$  there is a difference according to what model is considered. For simplicity normally the Kelvin-model is used for creep and the Maxwell-model for relaxation.

The real elastic time behaviour of plastics however is highly multi parametric. To cope with this, a series of exponential functions is introduced, for creep by a serial addition of Kelvin-models, and by relaxation in a parallel composition of Maxwell-models, see Table 5-2.

Table 5-2 Generalized multi parametric Kelvin- or Maxwell- models and the functions for creep and relaxation [94]

model	generalized Kelvin-model	generalized Maxwell-model
scheme		
differential equation	$\sigma + \sum_{i=1}^n p_i \cdot \frac{\partial^i \sigma}{\partial t^i} = q_0 \cdot \varepsilon + \sum_{i=1}^n q_i \cdot \frac{\partial^i \varepsilon}{\partial t^i}$	
creep function	$J_{ret}(t) = \frac{p_1}{q_1} + \sum_{i=1}^n \frac{q_i - p_i \cdot q_{0,i}}{q_{0,i} \cdot q_i} \left( 1 - e^{-\frac{q_{0,i}}{q_i} t} \right)$	
relaxation function	$E(t) = q_0 + \sum_{i=1}^n \left( \frac{q_i}{p_i} - q_0 \right) e^{-\frac{t}{q_i}}$	
parameterized creep function	$J_{ret}(t) = \frac{1}{E_0} + \sum_{i=1}^n \frac{1}{E_i} \left( 1 - e^{-\frac{t}{\lambda_{ret,i}}} \right) \text{ with } \lambda_{ret,i} = \frac{\eta_i}{E_i}$	*
parameterized relaxation function	*	$E(t) = E_0 + \sum_{i=1}^n E_i \cdot e^{-\frac{t}{\lambda_{rel,i}}} \text{ with } \lambda_{rel,i} = \frac{\eta_i}{E_i}$

With creep or relaxation curves obtained from tests the parameters of the exponential series with a suitable number of elements can be determined.

### 5.5 Bending behaviour of laminated sections due to transversal or axial loading

By considering the composite action of the interlayer of laminated glass panes, which are bent about their weak axis, a realistic and economic design can be achieved. Therefore the partial section forces in the single layers, the slip between the layers and the stresses in the glass should be determined realistically. For further derivation according to the sandwich theory a shear gap of a laminate with two layers with  $d_1$  and  $d_2$  is considered. The sheet with a thickness  $t$  has a shear modulus  $G_F$ , which can be transformed to a shear stiffness  $K_S$  of the elastic gap:

$$K_S = \frac{G_F}{t} \cdot B \tag{5-12}$$

with

$$q_s(x) = K_s \cdot s(x) \tag{5-13}$$

where  $s(x)$  is the slip-function and  $q_s(x)$  the distributed horizontal load, both along the gap, the formulation of equilibrium is

$$\frac{dM(x)}{dx} - V(x) = \frac{dM_1(x)}{dx} + \frac{dM_2(x)}{dx} + \frac{dF}{dx} \cdot z - V(x) = 0 \tag{5-14}$$

$$\frac{dV(x)}{dx} + Nw''(x) + q_z(x) = 0 \tag{5-15}$$

$$\frac{dF(x)}{dx} - q_s(x) = 0 \tag{5-16}$$

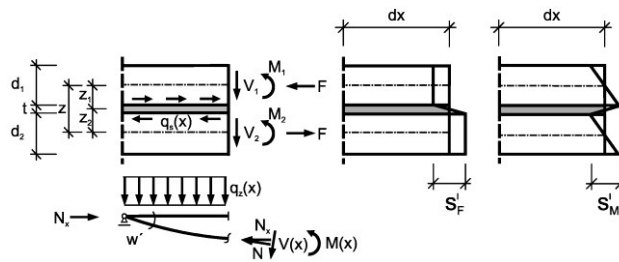
In the skin-layer, generally, there are partial bending moments  $M_i(x)$  and layer forces  $F(x)$  the amount of which is equal in both of the layers. The forces generate with their corresponding distance reduced static moments according to Steiner.  $Nw''(x)$  is the change of deviation of the sectional normal force  $Nw'(x)$  due to the axial load  $N$ .

It is assumed that the interlayer is not compressible; hence the curvatures at a certain longitudinal position are identical in each of the layers. Further the transverse shear forces are distributed according to the bending stiffness of the single layers.

$$w_1''(x) = -\frac{M_1(x)}{EI_1} = w_2''(x) = -\frac{M_2(x)}{EI_2} \tag{5-17}$$

$$w_1'''(x) = -\frac{dM_1(x)}{EI_1} = w_2'''(x) = -\frac{dM_2(x)}{EI_2} \tag{5-18}$$

two-layered-laminate



three-layered laminate

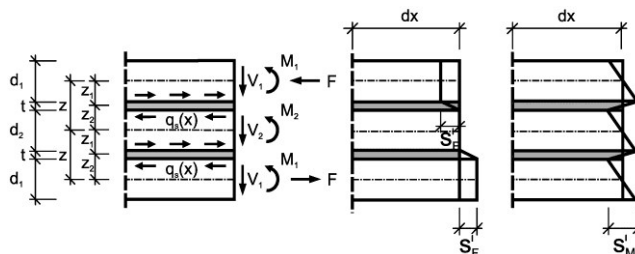


Figure 5-3 Sectional forces and slip differentials from strain and curvature for a symmetrical two-layered and a symmetrical three-layered laminate [232]

The change of the slip shall be  $s'(x)$ . It is the sum of the strain differences of the adjacent outer glass fibre of two layers at a common gap, each of them due to longitudinal extending from tension or compression as well as due to the curvature from bending.

$$s'(x) = w_1''(x) \cdot z_1 + w_2''(x) \cdot z_2 - F(x) \left( \frac{1}{EA_1} + \frac{1}{EA_2} \right) \quad (5-19)$$

$$s''(x) = w_1'''(x) \cdot z_1 + w_2'''(x) \cdot z_2 - \frac{dF(x)}{dx} \left( \frac{1}{EA_1} + \frac{1}{EA_2} \right) \quad (5-20)$$

$$s''(x) = -\frac{1}{EI_1} \frac{dM_1(x)}{dx} \cdot z - \frac{dF(x)}{dx} \left( \frac{1}{EA_1} + \frac{1}{EA_2} \right) \quad (5-21)$$

After some algebraic steps it follows:

$$s''(x) = -\frac{z}{EI_1 + EI_2} (V(x) - q_s(x) \cdot z) + q_s(x) \left( \frac{1}{EA_1} + \frac{1}{EA_2} \right) \quad (5-22)$$

Further differentiating leads to the general non-homogeneous slip-differential-equation.

$$\begin{aligned} s'''(x) - \frac{1}{E} \left[ \frac{N + K_s \cdot z^2}{I_1 + I_2} + \left( \frac{1}{A_1} + \frac{1}{A_2} \right) K_s \right] \cdot s''(x) \\ + \frac{N \cdot K_s}{E^2 (I_1 + I_2)} \left( \frac{1}{A_1} + \frac{1}{A_2} \right) \cdot s(x) = \frac{z}{E(I_1 + I_2)} q_z'(x) \end{aligned} \quad (5-23)$$

## 5.6 Bending behaviour of laminated sections due to transversal loading without axial load

In case  $N = 0$  the equation from (5-23) is reduced and after integrating two times the generally known slip-differential-equation of second order comes out to

$$s''(x) - \alpha^2 s(x) = -\beta \cdot V(x) \quad (5-24)$$

$$\text{with } \alpha^2 = \frac{K_s}{E} \left( \frac{z^2}{I_1 + I_2} + \frac{1}{A_1} + \frac{1}{A_2} \right) \text{ and } \beta = \frac{z}{E(I_1 + I_2)} \quad (5-25)$$

For the shear gap of a symmetrical 3 layered laminate  $\alpha^2$ ,  $\beta$  and  $z$  are according to Figure 5-3 and/or Table 5-3.

For the slip differential equation the homogeneous solution can be determined from the characteristic equation

$$\lambda^2 - \alpha^2 = 0 \text{ and } \lambda_{1,2} = \pm \alpha \quad (5-26)$$

and

$$s_H(x) = C_1 \cdot e^{\alpha \cdot x} + C_2 e^{-\alpha \cdot x} \quad (5-27)$$

The particular solution is

$$s_p(x) = \frac{\beta}{\alpha^2} V(x) \quad (5-28)$$

$$s(x) = s_H(x) + s_p(x) \quad (5-29)$$

The constants  $C_1$  and  $C_2$  can be found by formulating the boundary conditions. By this the slip function  $s(x)$  and the force flow  $q_s(x) = K \cdot s(x)$  become known. Defining equilibrium at the separated single layers leads to

$$F(x) - \int_0^x q_s(x) dx = 0 \quad (5-30)$$

$$V(x) + \int_0^x q_z(x) dx = 0 \quad (5-31)$$

$$M(x) - V(x) \cdot dx = M_1(x) + M_2(x) + F(x) \cdot z - V(x) \cdot dx = 0 \quad (5-32)$$

so that  $F(x)$ ,  $M_i(x)$ ,  $V(x) = V_1(x) + V_2(x)$  and  $M(x)$  can be determined.

The stresses then are

$$\sigma_i(x) = \pm \frac{F(x)}{A_i} \pm \frac{M_i(x)}{W_i} \quad (5-33)$$

$$W_{i,eff}(x) = \frac{M(x)}{\sigma_i(x)} \quad (5-34)$$

$$w(x) = - \int_0^x \int_0^x \frac{M_i(x)}{EI_i} dx dx \quad (5-35)$$

Note, that the effective values  $W_{eff}$  generally are no more constant along the axis, they rather depend on the position  $x$ . Thereby an exception represents the sinusoidal shaped moment distribution: laminated beams with that curvature (originating from sinusoidal transverse loading or from non-linear bending due to axial loads). Table 5-4 gives solutions for different loading cases under the assumption that the slip at the ends of the laminated beam is not blocked.

Finally it should be remarked that the same methodology applies for laminated plates analogously.

Table 5-3 Cross sectional parameters [94]

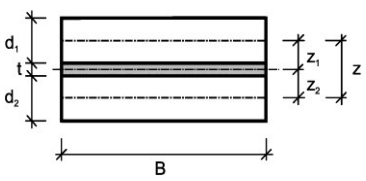
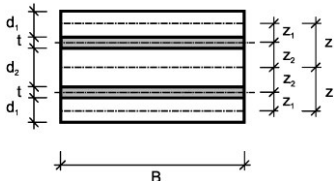
		
$K_s$	$\frac{G_F(t) \cdot B}{t}$	$\frac{G_F(t) \cdot B}{t}$
$\alpha^2$	$\frac{K_s}{E} \left( \frac{(z_1 + z_2)^2}{I_1 + I_2} + \frac{1}{A_1} + \frac{1}{A_2} \right)$	$\frac{K_s}{E} \left( \frac{2(z_1 + z_2)^2}{2I_1 + I_2} + \frac{1}{A_1} \right)$
$\beta$	$\frac{(z_1 + z_2)}{E(I_1 + I_2)}$	$\frac{(z_1 + z_2)}{E(2I_1 + I_2)}$
$Y$	$(I_1 + I_2)$	$(2I_1 + I_2)$
$\psi$	$(z_1 + z_2)$	$2 \cdot (z_1 + z_2) = 2 \cdot z$



Table 5-4 Overview of the slip and sectional functions and forces for different load cases, free slip at the ends [94]

	loading 1	loading 2
static system		
homogenous solution $s_H$	characteristic equation: $\lambda^2 - \alpha^2 = 0 \Rightarrow \lambda_{1,2} = \pm \alpha \Rightarrow s_H(x) = C_1 e^{\alpha x} + C_2 e^{-\alpha x}$	
slip function $s(x)$	$-\frac{\beta \cdot P}{2 \cdot \alpha^2} \left[ 1 - \frac{\cosh\left(\alpha\left(x_1 - \frac{L}{2}\right)\right)}{\cosh\left(\frac{L}{2}\alpha\right)} \right]$	$s_I(x_{I,1}) = -\frac{\beta \cdot P}{\alpha^2} \frac{\sinh b \alpha}{\cosh(a+b)\alpha} \sinh \alpha x_{I,1}$ $s_{II}(x_{II,1}) = -\frac{\beta \cdot P}{\alpha^2} \left[ 1 - \frac{\cosh a \alpha}{\cosh(a+b)\alpha} \cosh \alpha(x_{II,1} - b) \right]$
slip distribution		
$m(x_1)$	$\frac{K_s \cdot \beta}{2 \cdot \alpha^2} \left[ x_1 - \frac{L}{2} - \frac{\sinh\left(\alpha\left(x_1 - \frac{L}{2}\right)\right)}{\alpha \cosh\left(\frac{L}{2}\alpha\right)} \right]$	$m_I = \frac{K_s \cdot \beta}{\alpha^2} \left[ \frac{\cosh(\alpha x_{I,1}) \sinh(\alpha b)}{\alpha \cosh(\alpha(a+b))} - b \right]$ $m_{II} = \frac{K_s \cdot \beta}{\alpha^2} \left[ x_{II,1} - b - \frac{\cosh(\alpha a) \sinh(\alpha(x_{II,1} - b))}{\alpha \cosh(\alpha(a+b))} \right]$
$W_{i,eff}(x_1)$	$4 \cdot \frac{(L - 2x_1)}{\left[ \pm \left( \frac{-m}{B \cdot d_i} \right) \pm \frac{d_i}{2Y} \left( \frac{L}{4} - \frac{x_1}{2} + \psi \cdot m \right) \right]}$	$W_{i,eff,I}(x_{I,1}) = \frac{b}{\left[ \pm \left( \frac{-m_I}{B \cdot d_i} \right) \pm \frac{d_i}{2Y} (b + \psi \cdot m_I) \right]}$ $W_{i,eff,II}(x_{II,1}) = \frac{b - x_{II,1}}{\left[ \pm \left( \frac{-m_{II}}{B \cdot d_i} \right) \pm \frac{d_i}{2Y} (b - x_{II,1} + \psi \cdot m_{II}) \right]}$
$F(x_1)$	$-P \cdot m$	$F_I(x_{I,1}) = -P \cdot m_I$ $F_{II}(x_{II,1}) = -P \cdot m_{II}$
$M_i(x_1)$	$\frac{P \cdot I_i}{Y} \left[ \frac{L}{4} - \frac{x_1}{2} + \psi \cdot m \right]$	$M_{i,I}(x_{I,1}) = \frac{P \cdot I_i}{Y} [b + \psi \cdot m_I]$ $M_{i,II}(x_{II,1}) = \frac{P \cdot I_i}{Y} [b - x_{II,1} + \psi \cdot m_{II}]$
$M(x_1)$	$\sum M_i(x_1) + F(x_1) \cdot \psi = P \cdot \left( \frac{L}{4} - \frac{x_1}{2} \right)$	$M_I(x_{I,1}) = \sum M_i(x_{I,1}) + F(x_{I,1}) \cdot \psi = P \cdot b$ $M_{II}(x_{II,1}) = \sum M_i(x_{II,1}) + F(x_{II,1}) \cdot \psi = P \cdot (b - x_{II,1})$
$\sigma(x_1)$	$\frac{M(x_1)}{W_{i,eff}(x_1)}$	$\max \left[ \frac{M(x_{I,1})}{W_{i,eff}(x_{I,1})}; \frac{M(x_{II,1})}{W_{i,eff}(x_{II,1})} \right]$

Table 5-5 Continuation of the Table 5-4 [94]

	Loading 3	Loading 4
static system		
homogenous solution $s_H$	characteristic equation: $\lambda^2 - \alpha^2 = 0 \Rightarrow \lambda_{1,2} = \pm \alpha$	
	$\Rightarrow s_H(x) = C_1 e^{\alpha x} + C_2 e^{-\alpha x}$	$\Rightarrow s_H(x) = C_1 e^{\alpha \frac{\pi x}{L}} + C_2 e^{-\alpha \frac{\pi x}{L}}$
slip function $s(x)$	$s(x_1) = -\frac{\beta \cdot q}{\alpha^2} \left[ x_1 - \frac{\sinh(\alpha x_1)}{\alpha \cdot \cosh\left(\frac{L}{2} x_1\right)} \right]$	$s(x) = \frac{V_z \cdot \beta}{\left(\frac{\pi}{L}\right)^2 + \alpha^2} \cos\left(\frac{\pi x}{L}\right)$
slip distribution		
$m(x_1)$	$\frac{K_s \cdot \beta}{\alpha^2} \left[ \frac{x_1^2}{2} - \frac{L^2}{8} + \frac{1}{\alpha^2} - \frac{\cosh(\alpha x_1)}{\alpha^2 \cosh\left(\frac{L}{2} \alpha\right)} \right]$	$\frac{K_s \cdot \beta}{\left(\frac{\pi}{L}\right)^2 + \alpha^2}$
$W_{i,eff}(x_1)$	$8 \cdot \left[ \pm \left( \frac{-m}{B \cdot d_i} \right) \pm \frac{d_i}{2Y} \left( \frac{L^2}{8} - \frac{x_1^2}{2} + \psi \cdot m \right) \right]$	$\left[ \pm \left( \frac{m}{B \cdot d_i} \right) \pm \frac{d_i}{2Y} (1 - \psi \cdot m) \right]$
$F(x_1)$	$-q \cdot m$	$V_z \cdot m \cdot \frac{L}{\pi} \cdot \sin\left(\frac{\pi x}{L}\right)$
$M_i(x_1)$	$\frac{q \cdot I_i}{Y} \left[ \frac{L^2}{8} - \frac{x_1^2}{2} + \psi \cdot m \right]$	$\frac{V_z \cdot \frac{L}{\pi} \cdot I_i}{Y} \cdot \sin\left(\frac{\pi x}{L}\right) \cdot [1 - \psi \cdot m]$
$M(x_1)$	$\sum M_i(x_1) + F(x_1) \cdot \psi = q \left( \frac{L^2}{8} - \frac{x_1^2}{2} \right)$	$\sum M_i(x) + F(x) \cdot \psi = V_z \cdot \frac{L}{\pi} \cdot \sin\left(\frac{\pi x}{L}\right)$
$\sigma(x_1)$	$\frac{M(x_1)}{W_{i,eff}(x_1)}$	$\frac{M(x)}{W_{i,eff}(x)}$

Further methods to calculate the stresses and deformations in glass sandwich structures can be found in the literature [165] [166] [168].

## 5.7 Post-glass breakage strength of laminated glass

The fail-safe approach to structural glass design should include that, due to an unforeseen event (accidental loads, vandalism, etc.), glass components can fragment in whole or in part. Thus, it has to be checked that for this limit condition the element maintains a load-bearing capacity sufficient to cope with permanent loads, together with part of the variable loads. It is

also important to verify that the constraints are properly designed to retain the glass under the large deformations occurring in the post-glass-breakage phase.

Therefore three possible resistance mechanisms can be distinguished for laminated glass, as illustrated in Figure 5-4 [178].

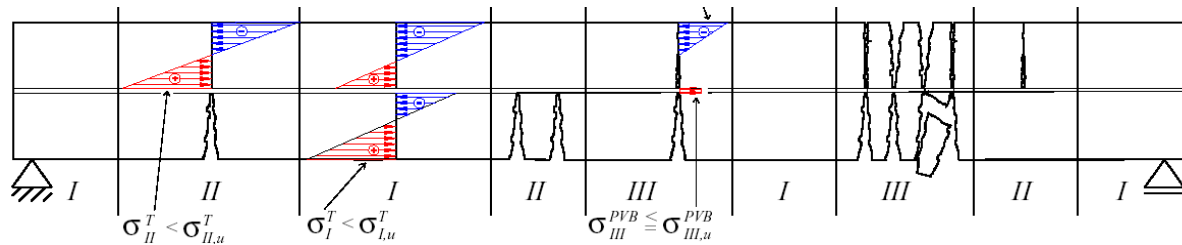


Figure 5-4 Resistance mechanisms in the post glass breakage phase [178]

Mechanism *I* develops when the glass sheets forming the laminated package are sound. In this condition the classical Euler Bernoulli assumptions may be considered valid in each one of the composing glass panes. The stress distribution of tension and compression along the glazed section depends heavily upon the mechanical characteristics of the material used as an interlayer, because it provides the shear coupling between the panes. The structural behaviour is well represented by the theory of composite plates. This phase ends when one of the layers breaks, reaching the glass strength limit.

Due to pre-existing internal defects, rupture of the first plate can also take place in sections where the internal actions do not reach the maximum values. In the case of strain driven tests, when the stresses are compatible with the strength of the material, the entire load is carried by the plate that remains sound (mechanism *II* of Figure 5-4). In this condition, the interlayer can only retain the glass shards. If the distance between two cracked sections is large enough, the polymer still allows the transfer of shear stresses in the area between two consecutive slits.

If the test is stress driven, breakage of the first pane usually leads to a sudden decrease of the load-bearing capacity, producing a chain reaction that breaks all the other panes (mechanism *III*, Figure 5-4). The glass is no longer able to transfer tensile stresses, but the fragments may still carry compressive load due to contact, while the polymer can provide the tensile force necessary to withstand bending moments. At this stage, the load bearing capacity depends significantly upon the size of the fragments and, therefore, it is influenced by the type of glass (annealed, heat strengthened, heat tempered).

## Code Review No. 42

### *Design Code:*

*Italian CNR-DT-210 [55] provides empirical formulas to estimate the size of the glass shards and, consequently, the bending stiffness of the laminated package when all glass panes are broken.*

## 5.8 Numerical analysis and experimental testing

Where no analytic solutions are available FEM can be used. The reliability of FE-model should be proven by a benchmark. Attention should be paid that not only one benchmark is

sufficient, it should be rather be proven by several benchmark showing different stress states.

In order to obtain reliable and safe sided numerical results it is necessary to use complex non-linear time-dependent finite element models (including material and geometrical non-linearity). Those models must be able to take into account a wide range of specific aspects of glass structures, such as: the brittle nature of glass, the slenderness of glass elements, the viscoelastic and time-dependent behaviour of the interlayers, the interface properties, the existence of point supports and adhesive joints, the existence of residual stresses and stress gradients, etc.

A full specification of the requirements of a proper numerical analysis is not within the scope of this report. However, some general recommendations can be stated as follows:

Results should be consolidated and not depending on a further refinement (i.e. there are prior model congruence investigations).

As far as they have a potential negative influence on the corresponding load and design situation, all restraints from boundary conditions and loading should be considered. As far as the influences are potentially positive on the corresponding load and design situation they have to be neglected.

- The element mesh must be sufficiently refined in order to achieve an acceptable accuracy and to ensure that the obtained results do not depend on a further refinement;
- The elements and integration rules used must realise the local and global behaviour of the structure;
- All relevant effects from the detailing and tolerances should be taken into account;
- Constraint relations are necessary to guarantee the displacement compatibility at the nodes and, preferably, along the element edges when adjacent elements are of different types, material or thickness;
- Proper support constraints must be imposed with special attention to nodes on symmetry axes.

Only a deliberate use of an appropriate model will make possible the full understanding of the structural response and the derivation of a comprehensive set of rational rules for the design of those structural elements.

The experimental test setups and procedures must be properly defined in order to obtain realistic and valuable results. To assure the reproducibility of those experiments or to make possible their simulation by numerical models, special attention must be paid to the strategies of displacement and force control and to the documentation of the main characteristics of the sensors, transducers and acquisition data systems used.

To conclude, there is an urgent and unequivocal need of promoting guidelines of best practise for both numerical analysis and experimental tests and for disseminating reliable results and benchmarks.

### **Eurocode Outlook No. 23**

- (1) *Apart from rules for the supplication of FEM the Eurocode should give best practice examples for both numerical analysis and experimental tests as well for reliable results and benchmarks.*
- (2) *Since this matter is still under research, the scientific discussion is not yet finalized. Therefore, it should be treated with appropriate care. Thus any respective guidelines in the Eurocode, for the first instance, should be informative.*



## 6 Design of secondary structural glass components

### 6.1 Calculation of monolithic plates

The calculation of the stresses and deflections can be done with the linear plate theory (FEM or tables); it is allowed to take account of the non-linear theory. The stress values to be determined are the maximum principal stresses.

If the deflections exceed the thickness of the plate then the non-linear effect gets significant for a glass panel with four supported edges as described, the effect vanishes for a length-to-width-ratio of more than 3:1 and finally there is no non-linear effect anymore for a glass panel supported linear at two opposite edges. However, in the first instance it is not always necessary to choose the non-linear theory.

Thermally strengthened glass panels may have holes or cuttings. These have to be carefully modelled with FEM to take into account the stress concentration in these regions.

### 6.2 Consideration of the shear bond of laminated glass panels

The static behaviour of a laminated glass panel depends on the stiffness of the interlayer and the size of the glass panel. The stiffening effect is higher in case of large and thin glass panels and lower in case of small and thick glass panels. As described in chapter 2.2 the material properties of PVB or other interlayers depend on the loading time and the temperature. The statically stiffness value of the interlayer can be assumed as constant for a fixed loading time at a defined temperature.

A precise calculation of laminated glass usually requires the (numerical) solution of differential equations. In numerical computations, it can be modelled conveniently by layered shell elements that take into account the dependent stiffness between glass and interlayer, but most of the commercial numerical codes do not contain such elements. On the other hand, a full 3-D analysis is complicated and time consuming. This is why, in the design practice and especially in the preliminary design, it is very useful to consider approximate methods for the calculation of laminated glass. The common practical approach is the definition of the deflection- and stress-effective thickness: That is the (constant) thickness of a homogeneous beam/plate that, under the same boundary and loading conditions of the considered situation, presents the same bending behaviour in terms of stresses and deflection, respectively.

The existing design codes are dealing in different ways with the shear stiffness of the interlayer (Code Review No. 39). On the one hand there are different philosophies concerning the material properties, on the other hand there are various conflicting calculation methods.

Further references to this topic can be found in (e.g. [179]).

**Code Review No. 43**

<u>Design standards:</u>
<i>DIN 18008 [44]: The shear stiffness of the interlayer is neglected in the current DIN 18008. Thus for the static verification a laminated glass panel is calculated assuming as independent single layers not being connected to each other. Only in case of the simulation of an impact load a full shear bond can be taken into account.</i>
<i>prEN 16612 [37]: The overall glass thickness is substituted by an effective thickness that takes into account the laminated effect by using a shear transfer factor <math>\omega</math>. This shear transfer factor refers to a glass panel size of 3000 mm x 2000 mm supported at the four edges [22]. The shear transfer factor is depending on the load duration.</i>
<i>NEN 2608 [45]: The thickness of the laminated glass is substituted by an effective thickness, but the used shear transfer factor is depending on the size of the glass panel, bearing conditions, load configurations and the load duration.</i>
<i>ÖNORM B 3716 [48]: For short loading time like winds loads a value of <math>G = 0.4 \text{ N/mm}^2</math> for PVB-sheets is accepted. The value is also used for FEM calculation with sandwich elements.</i>
<i>Technical recommendation: CNR-DT-210 [55]: Italian CNR-DT-210 provides very accurate formulas for the evaluation of the deflection- and stress-effective thickness for both laminated glass beams and plates, accounting for the boundary/ loading condition and size effect.</i>
<i>Technical Approvals (e.g. [78]): Here, the shear stiffness value <math>G</math> is given depending on the type of loading (wind, horizontal traffic loading, snow and dead load). The shear stiffness can be used for the FEM with sandwich elements that can cover the mechanical properties of the interlayer. Furthermore, theoretical solutions like the sandwich theory or the extended bending and torsional theory exist.</i>
<i>Whereas the positive effect (increasing of the bending resistance) of the shear stiffness is to be neglected (e.g. [44]), the negative effect of the shear stiffness (increasing of the effective climatic loading of insulating glass panels due to bending stiffness increase) must always be taken into account.</i>

**Eurocode Outlook No. 24**

<p>(1) <i>As described in chapter 5.5 and 5.6 the effective value <math>W_{\text{eff}}</math> is not constant over the plate. Therefore the simplified methods using a shear factor <math>\omega</math> should be analysed in view of an accepted method for a simplified design.</i></p> <p>(2) <i>The consideration of the interlayer stiffness should be allowed in case a value of <math>G_{\text{interlayer}}</math> can be given fulfilling the requirements of EN 1990 on the reliability. The interlayer stiffness should also be determined in dependence on the load distribution and the ambient temperature in combination with the load duration.</i></p> <p>(3) <i>Eurocode should enable both quasi-static and transient FEM calculations based on mechanical models.</i></p>
--

**6.3 Insulating glass plates**

Due to the enclosed air cavity between the single glasses an additional loading has to be taken into account for the design of insulating glass units. The so-called climatic loading acts as an inner load due to the change of temperature or of the air pressure and the difference of altitude in relation of the place of production and installation (e.g. [145]), see Figure 6-1.



Thereby the disadvantageous effects from summer and winter conditions have been specified in the rules. The effective climatic loading is depending on the deformability of the single glass panels, thus on the thickness and the size of the glass panel. The higher the deformability the lower is the climatic loading. Compared to wind and snow loads the climatic loading is not predominant for large glass panels, whereas for the design of small glass panels it becomes decisive. Till now the standards contain an analytic calculation method which is based on the plate theory for rectangular flat glass panels.

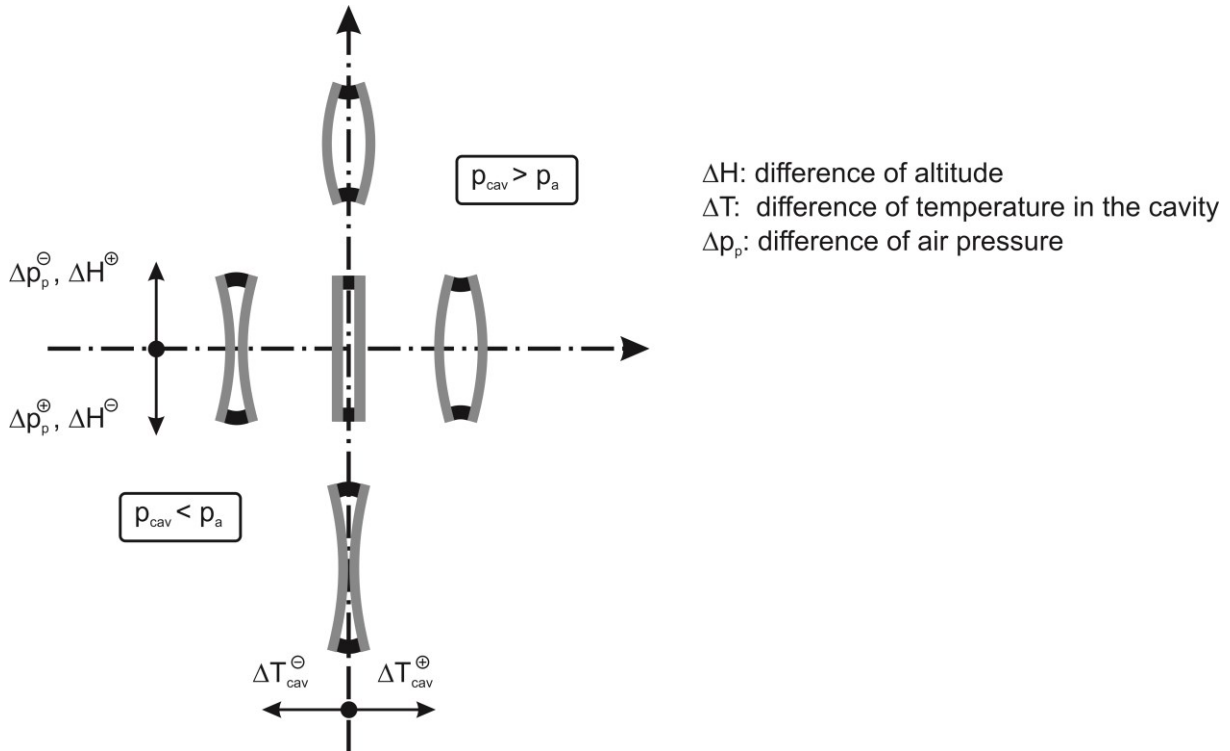


Figure 6-1 Change of the internal pressure  $p_{cav}$  depending on the change of temperature, the change of the air pressure and the altitude  $H$  in relation of the place of production and installation [94]

For the analysis of climatic loading the non-linear effect of the glass panels can be neglected. The reason is that the deformation of the glass panel is lower for the non-linear theory thus the stresses in the glass panels are significantly lower, although the climatic loading is higher.

In the case we have insulating glass with laminated glass panels load cases like “with composite effect” and “without composite effect” have to be considered, because the stiffer the glass plates behave the higher the internal pressure is.

There are no realistic theoretical models that consider the stresses in the edge bond and there are no investigations concerning its failure mode. Note that a failure of the edge bond normally is not considered to impair the safety but may actually limit the life time of the insulating glass unit in terms of the insulating effect. In practice the design of the edge bond is only based on the experience of the glass producer without any scientific background. The parameters of the edge bond are depending on the type of edge bond (materials), the resistance of its connected parts and on effects in the interface between glass and the edge bond.

The external loads like wind, snow or personnel loads are acting on the whole insulating glass panel. This is described by the so-called “coupling effect”. The distribution as what panel gets what amount of any external load is depending on the stiffness of the single glass panels of the insulating glass and the point of action (inside or outside).

With regard to the mechanical analysis of the glass plates it can be observed that several member states are determining the effective climatic loading and the load coupling with the same calculation model (*Feldmeier* [145]). For simple plane and linear supported glass panels analytic algorithms are available to determinate the stresses due to climatic actions based on the plate bending theory coupled with Bernoulli’s gas theory. This method is given in the design standards for double glazing (see Code Review No. 44). Additionally the general methods for double and triple glazing are given in the Code Review which can easily be adapted to any dimensions and forms. For the coupling of line or punctual loads also analytic methods for rectangular panes are available [145]. For point supported or curved glass panels the climatic loading can be determined with the aid of FEM and also with the general method given in the Code Review.

## Code Review No. 44

### Design Standards:

*DIN 18008 [44], NEN 2608 [45], ÖNORM B 3716 [48], prEN 16612 [37], BS 5516 [54], NBN S23002 [49]:*

*The climatic loading is based on the isochore pressure of a total stiff volume and it is composed by the difference of the altitude*

$$\Delta p_{H,0} = 0.012 \frac{\text{kPa}}{\text{m}} \cdot (H - H_p),$$

*the difference of temperature*

$$\Delta p_{T,0} = 0.034 \frac{\text{kPa}}{\text{K}} \cdot (T - T_p) \text{ and}$$

*the difference of the air pressure*

$$\Delta p_{p,0} = p_a - p_p$$

*The effective climatic loading and the load distribution of external loading  $p_{ex,i}$  is depending on the deformability of the glass panel and is taken into account by the insulating unit factor.*

### ***Simplified Method for rectangular double insulating glass units due to distributed loading:***

*Stiffness partition for pane 1:  $\delta_1 = \frac{d_1^3}{d_1^3 + d_2^3}$*

*Stiffness partition for pane 2:  $\delta_2 = \frac{d_2^3}{d_1^3 + d_2^3}$*

*Characteristic length of the unit with the volume coefficient  $B_V$  according to the Kirchhoffsche*

*Plate Theory:  $a^* = 28,9 \cdot \sqrt[4]{\frac{d_a^3 \cdot d_i^3 \cdot d_{cav}}{d_a^3 + d_i^3} B_V}$*

*Insulating unit factor:  $\varphi = \frac{1}{1 + \left(\frac{a}{a^*}\right)^4}$  with  $a$  = length of the short edge*

*Loading of pane 1:  $(\delta_1 + \varphi \cdot \delta_2) \cdot p_{ex,1} + (1 - \varphi) \cdot \delta_2 \cdot p_{ex,2} - \varphi \cdot \sum p_{i,0}$*

*Loading of pane 2:  $(\delta_1 + \varphi \cdot \delta_2) \cdot p_{ex,1} + (1 - \varphi) \cdot \delta_2 \cdot p_{ex,2} + \varphi \cdot \sum \Delta p_{i,0}$*

***Basic Method for double insulating glass units for any formats dimensions (circular, triangle or***

**also curved glass panels) due to distributed loading:**

$$\text{Insulating unit factor: } \varphi = \frac{1}{1 + \alpha + \alpha^+}$$

$$\text{Relative volume change for the panes: } \alpha = \frac{v_p \cdot P_a}{V_{pr}} \text{ and } \alpha^+ = \frac{v_{p^+} \cdot P_a}{V_{pr}}$$

with

atmospheric pressure  $p_a = 100 \text{ kN/m}^2$ , volume of the cavity  $V_{pr}$  and the volume change of the glass pane due to a unit pressure of  $1 \text{ kN/m}^2$   $v_{p,i}$ .

The load distribution is equal to the formula given above for the simplified method. The value  $v_{p,i}$  can be calculated for any dimensions and forms with FEM.

**Basic Method for triple insulating glass units for any formats dimensions (circular, triangle or also curved glass panels) due to distributed loading:**

$$\text{Insulating unit factor for cavity 1: } \varphi_1 = \frac{1}{1 + \alpha_1 + \alpha_1^+}$$

$$\text{Insulating unit factor for cavity 2: } \varphi_2 = \frac{1}{1 + \alpha_2 + \alpha_2^+}$$

$$\text{Relative volume change for panes beside cavity 1: } \alpha_1 = \frac{v_{p,1} \cdot P_a}{V_{pr,1}} \text{ and } \alpha_1^+ = \frac{v_{p,1^+} \cdot P_a}{V_{pr,1}}$$

$$\text{Relative volume change for panes beside cavity 2: } \alpha_2 = \frac{v_{p,2} \cdot P_a}{V_{pr,2}} \text{ and } \alpha_2^+ = \frac{v_{p,2^+} \cdot P_a}{V_{pr,2}}$$

with  $\alpha_1^+ = \alpha_2$

$$\text{Definition of } \beta = 1 - \varphi_1 \cdot \varphi_2 \cdot \alpha_1^+ \cdot \alpha_2$$

Internal pressure differences in the cavities:

$$\Delta p_1 = p_{ex,1} \cdot \frac{\varphi_1 \cdot \alpha_1}{\beta} - p_{ex,3} \cdot \frac{\varphi_1 \cdot \alpha_1 \cdot \varphi_2 \cdot \alpha_2}{\beta} + \left( \sum \Delta p_{i,0} \right) \varphi_1 \cdot \frac{1 + \varphi_2 \cdot \alpha_1^+}{\beta}$$

$$\Delta p_2 = p_{ex,1} \cdot \frac{\varphi_1 \cdot \alpha_1 \cdot \varphi_2 \cdot \alpha_2}{\beta} - p_{ex,3} \cdot \frac{\alpha_2^+ \cdot \varphi_2}{\beta} + \left( \sum \Delta p_{i,0} \right) \varphi_2 \cdot \frac{1 + \varphi_1 \cdot \alpha_2}{\beta}$$

$$\text{Loading of pane 1: } p_{ex,1} - \Delta p_1$$

$$\text{Loading of pane 2: } \Delta p_1 - \Delta p_2$$

$$\text{Loading of pane 3: } \Delta p_2 - p_{ex,3}$$

The characteristic values for the climatic loading are depending on the climatic situation. There are no harmonized regulations for these values.

NEN 2608 [45]: Also, an analytic model for load distribution between the panes of a double glass unit or concentrated load is available.

## Eurocode Outlook No. 25

- (1) The characteristic values of the climatic loading must be determined depending on the individual climatic situation (north and south) and the probability of occurrence. If not given by EN 1991, Eurocode should establish probabilistic values for the different types of climatic loads.
- (2) As the presented procedure for the calculation of the climatic loading is almost identical in a lot of the member states, it is assumed that the general method can be introduced into the Eurocode.

## 6.4 Linearly supported glazing

The most glass panels are linearly supported at the glass edges. They are assembled to sub-structures which can be

- Windows with frames made of wood, plastics, steel or aluminium
- Rail-post structured facades
- Curtain walls
- Structural sealant glazing
- Roof structures, etc.

The glass panels can be supported linearly at the four edges, at three edges or at two opposite edges. A hybrid support-system is possible in terms of four linearly supported edges for pressure loads and two linearly supported edges for suction loads.

For indoor applications very heavy glass panels (like glass floors) may solely be supported against pressure loads disregarding any suction loads (chapter 6.5.4).

Normally the glass panels are simply clamped at the edges. In case of structural sealant glazing the glass panels are connected to an adapter frame. The adhesive connection is made of a silicone sealant.

In-plane loading should be avoided; moreover the in-plane support conditions should be statically determined. The glass panels are mainly loaded by perpendicular loads like self-weight, wind or snow loads, climatic loading or personal loading (balustrade or floors).

The type of glazing can be:

- Monolithic glass panels
- Laminated glass panels
- Insulating glass panels combining either of two the types mentioned above

All flat or curved products of glazing above can be used for linear supported glass panels.

The support conditions are assumed fixed perpendicular to the glass plate if the deflection of the substructure is limited to  $L/200$  related to the length of the panel. Larger deflections of the substructure can be treated like “Cold deflection” of glass panels, mechanically similar to settlement displacements.

Curved glass panels show much lower stresses caused by outer loading due to the high geometrical stiffness compared to flat glass panels. In case of curved insulating glass units the high stiffness and the associated low deformability lead to a very high effective climatic loading and have to be taken into account properly. Whereas for flat glass the limiting value for a “stiff” substructure can be fixed to  $L/200$ , the situation for curved glass is different because small deflections of the substructure induce high stresses in a curved glass panel. This is one of the reasons why several national design codes are non-applicable for curved glass panels.

The necessary edge cover of the linear support is varying depending on the type of glazing (monolithic or insulating glass panel), the size of the glass panel and the robustness requirements. E.g. the edge cover can be 7 up to 15 mm, while these values are purely empirical. An upper limit of the edge cover is recommended to avoid high stress gradients in a glass plate because the covered parts at the edges may cause a temperature and stress

gradient. Hereby, the glass edge resistance (zone 2) determines the resistance of glass against thermal stresses. There are different methods in Europe to deal with this problem. For critical situations (high thermal absorption of the glass, etc.) as a deemed to satisfy recommendation a thermal tempered glass should be used unless sophisticated calculation methods open solutions for other glass qualities.

For vertical and horizontal glazing without personal loading or impact loading there may be different constructive requirements to be fulfilled.

For non-broken linear supported glass panels there is a risk of slipping off the glass support if the deflections exceed a certain value. The limitation of the deflection and a proper control of the minimum edge cover prevent this scenario.

The standard systems and requirements for balustrades, floors or horizontal glazing accessible for maintenance are described in the following chapters.

### Code Review No. 45

<u>Construction Rules:</u>
<i>DIN 18545 [80]: This execution standard specifies the minimum needed edge covering.</i>
<i>DIN 18008-1 and DIN 18008-2 [44]: The support conditions of a glass plates are assumed to be fixed out of plane at the edges but free in plane. The limit value such that a stiff substructure can be assumed may be <math>L/200</math> along the considered edge.</i>
<i>BS 6262 [60]: Minimum edge cover is recommended for vertical glazing.</i>
<i>BS 5516 [54]: Minimum edge cover is recommended for sloping glazing.</i>
<i>BS 6180 [61]: Minimum edge cover is recommended for barrier infill panes.</i>
<i>prEN 12488 [85]: This European standard gives principal assembly rules for vertical and sloping glazing. It does not apply e.g. for channel shaped glass, structural sealant glazing, point fixed glazing, etc..</i>

### Code Review No. 46

<u>Design standards:</u>
<i>DIN 18008-2 [44]: Glass types which fulfil the residual resistance requirements:</i>
<ul style="list-style-type: none"> <li>• <i>Vertical glazing: e.g. monolithic glass panels made of heat strengthened or float glass must be supported at all edges in case of an installation height <math>&gt; 4</math> m, heat soaked thermally toughened glass is needed in a case of an installation height <math>&gt; 4</math> m</i></li> <li>• <i>Horizontal glazing: e.g. the lower glass panel must be made of laminated glass (only heat strengthened or float glass layers); limitation of the span for glass panels with only two linear supports <math>&lt; 1,2</math> m; minimal thickness of the PVB interlayer 0,76 mm,</i></li> <li>• <i>Application conditions: e.g. minimal edge cover 10 mm, minimum are two opposing linear supported edges; appropriate setting of the glass panels (number and position of the setting blocks); limitation of the layer thicknesses ratio (<math>d1 / d2 = 1.5</math>) of the glass laminate</i></li> <li>• <i>Serviceability Limit State (SLS): For linear supported glass panels the deflection limit (Ser-</i></li> </ul>

*serviceability Limit State is set to  $L/100$ . In case of exceeding this limit the verification can be done by proofing an edge cover after deformation of 5 mm.*

- *Ultimate Limit State (ULS): See*
- *Code Review No. 25*

*Accidental Scenario for horizontal glass panels: Verification with lower load partial factor for the failure of one glass panel (accidental design combination)*

*BS 6262 [60] (vertical glazing) and BS 5516[54] (sloping glazing):*

- *Frames/supports should not deflect more than  $span/175$  (for insulating glass units) or  $span/125$  (single glazing) in order to be considered as supporting members.*
- *Marked safety glass must be used in locations where human impact is possible.*
- *Sloping overhead glass is required to be an appropriate safety glass (monolithic heat soaked toughened glass is allowed for low level overhead use).*
- *ULS of the glass from load charts.*
- *SLS: Glass deflection limit  $span/65$  or 50 mm whichever is smaller.*

## **Eurocode Outlook No. 26**

- (1) *Eurocode should give rules on the detailing of linear supports in dependence of the design situation, scenario and consequence class.*
- (2) *Eurocode should also indicate limits in how far a flexibility of the support-system has to be taken into account in view of the stress verification of the glass.*

## **6.5 Point fixed glazing**

### **6.5.1 General**

Point fixings are widely applied in glass engineering for connecting glass facade or roof panels to the supporting substructure. These point fixings can be located at the edge of the glass panels or at the surface of the glass panel, see Figure 6-2. Furthermore, the point fixings can be executed by means of clamping systems, drilled holes, embedded connections or adhesive connections. These point fixing systems are subsequently discussed in the following sections.

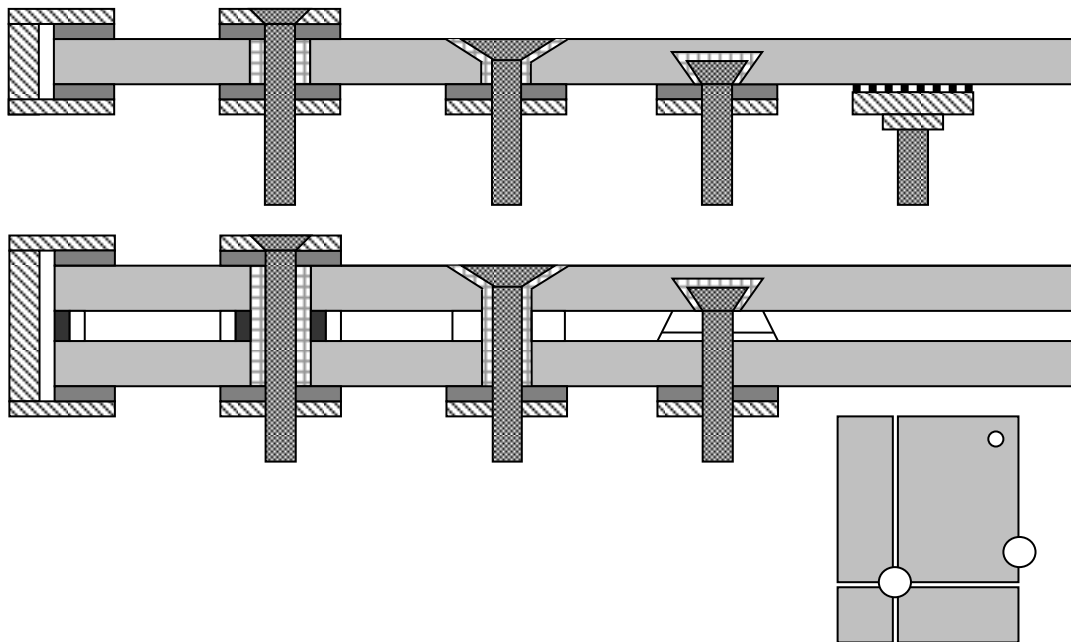


Figure 6-2 Types of point fixings

### 6.5.2 Clamping systems

Point supported glass panels have no linear support at the glass edges; but one possibility for fixing are punctual clamping systems near the edges. Also combinations of a linear supporting system (e.g. for pressure loads) with a punctual clamping system (e.g. for suction loads) have been often executed.

Due to the local load introduction stress concentrations near the clamping occur and should be analysed, the results of which strongly depend on the stiffness of the interfaces.

There are a lot of clamping systems on the market with a European technical approval.

The residual resistance of punctual clamped glass panels is inferior compared to linear supported glass panels. And also, the risk of slipping off the supports after a glass breakage is higher. The treatment may be different from country to country.

### Code Review No. 47

Design standards:

DIN 18008-3:

Glass types (which fulfil a residual resistance) covering the requirements:

- Vertical glazing: Monolithic Glass made of thermally toughened glass (heat soaked, at least 6 mm thick), laminated safety glass made of annealed glass, thermally toughened glass or heat strengthened glass, insulating glass
- Horizontal glazing: Only a combination of linear support for pressure loads and clamping for suction loads is allowed. Post breakage behaviour must be considered, either by comparing the geometry with already approved geometries or by experiment. Laminated glass made

*of annealed glass or heat strengthened glass is necessary.*

- *Application conditions: Size of clamping surface at least 1000 mm<sup>2</sup> and clamping depth at least 25 mm*
- *Serviceability Limit State (SLS): Calculation of the maximum deflection  $f_{max}$  by appropriate means, finite element analysis is recommended. Validation of FEM is provided by verification models. Experimentally determined spring stiffness of the point fixing can be considered. Test setups are provided in the annex of the standard. Friction between interlaying materials must not be considered.  $C_d = 1/100$  of the effective span.*
- *Ultimate Limit State (ULS): Point fixing: Calculation of the maximum load capacity on the basis of technical building regulations, if possible. If not, experimental determination of the maximum load capacity considering different load directions. Glass: Calculation of the maximum tensile stress  $\sigma_{max}$  by appropriate means, FEM is recommended. Validation of FEM is provided by verification models. Experimentally determined spring stiffness of the clamping system can be considered. Test setups are provided in the annex of the standard. Friction between interlaying materials must not be considered.*

*BS 6180 [61] and BS 6262 [60]: These standards give basic advices on bolted and non-bolted point fixings.*

## Eurocode Outlook No. 27

- (1) *The Eurocode should take into account the design of glazing with punctual clamping systems.*
- (2) *Thereby the stresses around the clamping have to be assessed by appropriate means like FEM, analytical procedures or combined methods.*
- (3) *Whilst using FEM, the degree of elements and meshing have to guarantee:*
  - *Results are consolidated and do not depend on a further refinement (prior model congruence investigation)*
  - *All relevant effects from the detailing and tolerances should be taken into account.*
  - *As far as they have a potentially negative influence on the corresponding load and design situation, all restraints from boundary conditions and loading should be considered. As far as the influences are potentially positive for the corresponding load and design situation they have to be neglected.*

### 6.5.3 Point fixings with drilled holes

Compared to clamping systems a drilling is needed to produce the hole and to connect the point fixing with the glass panel. Depending on the type of point fixing different geometries of drillings are available, see Figure 6-3.

Thermal pre-stressing is an issue in the borehole area, especially because this area is often crucial. It must be assured that the level of pre-stress is at least as high as it is in the body. If not, the design value for load-bearing resistance must be reduced. Optical stress measurements have proven [117] [124] that a sufficient thermal pre-stressing (pressure on the borehole surface) can develop in the hole area for cylindrical and conical holes (depending on the size of the hole and the distance to the edges).

The more complex the borehole geometry is, the more difficult the proof of sufficient pre-stress will get. In some cases (e.g. blind hole) optical measurement is impossible with existing methods and indirect FEM simulations may give an answer, but the results are highly



depending on the parameters of the heat transfer coefficient [206]. Blind holes and the corresponding point fixing can be used in Germany with a specific technical approval [79].

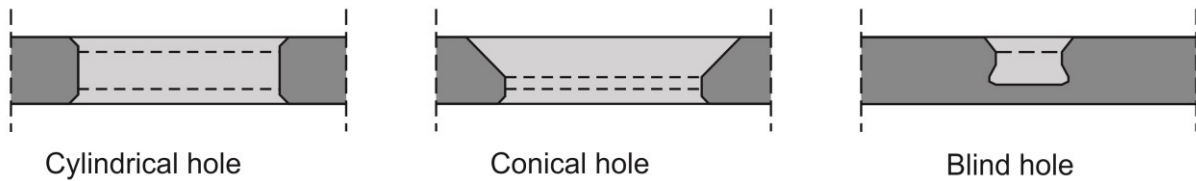


Figure 6-3 Different geometries of drillings

Point fixings are generally made of stainless steel and provide an interface material to avoid any direct steel glass contact. The bearing capacity and the durability of the point fixings should be technically approved. A point fixing can be fully fixed or it can allow for rotations (like joints). So far, systems with blind holes can only be proved by testing.

For the described types of point fixings only heat strengthened and thermally toughened glass should be used because a high material resistance near the holes is needed.

The behaviour of the residual resistance depends on the glass composition and the glass product. Furthermore, the size and the thickness of the panel and the distance between the point fixings and its size are important.

On the basis of several tests for point supported glazing with drillings different levels of risk after a glass breakage can be defined:

- vertical glazing made of a single thermally toughened glass: in case of breakage small glass pieces are falling down
- vertical glazing made of laminated heat strengthened glass (PVB interlayer): this provides a very high residual resistance
- vertical glazing made of laminated thermally toughened glass (PVB interlayer): there is a risk of pulling out of the point fixing and therefore falling down of a large laminated glass panel
- horizontal glazing made of laminated heat strengthened glass (PVB interlayer): very high residual resistance

Also other combinations can have a good residual resistance by using ionomer interlayer.

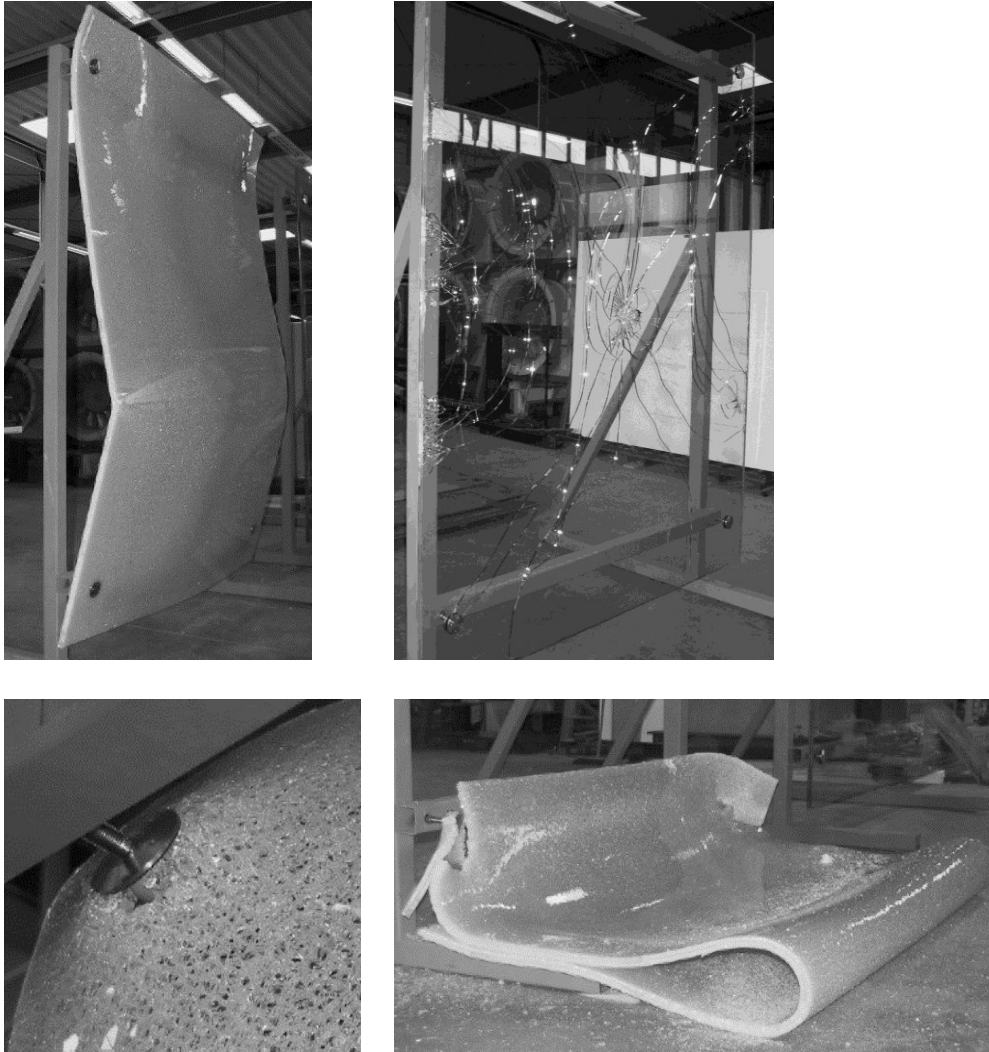


Figure 6-4 *Residual resistance of laminated punctual supported glass panels made of heat strengthened or thermally toughened glass*

Because of the geometry of drilled holes, the concentrated load introduction and the absence of ductility the design of a point supported glass panel must be carried out very properly to determine the stress concentrations near to the hole. The stress concentrations are depending on the size of the point fixing, the stiffness of the interfaces, the degree of freedom of the point fixing and the position of the joint.

The aforementioned effects and the composite effect of laminated glass may also be considered within the scope of point supported glass panels. There are no satisfying (practise oriented) analytic models available so that FEM calculations are recommended. Adequate results can only be achieved by using contact elements between the different materials (glass, interface, point fixing, etc.) and by considering the different material stiffness of the interfaces.

### Code Review No. 48

Design Standards:

*DIN 18008-3 [44]:*

*Glass types which can be used, the residual resistance is covered by these requirements:*

- *Vertical glazing: Laminated Safety Glass made of Thermally Toughened Glass or Heat Strengthened Glass (either heat soaked or not) (Interlayer: PVB  $d = 1.52$  mm)*
- *Horizontal glazing: Laminated Safety Glass made of Thermally Toughened Glass (at least  $2 \times 6$  mm, Interlayer PVB  $d = 1.52$  mm). Post breakage behaviour must be considered, either by comparing the geometry with already approved geometries or by experiment.*

*Application conditions:*

- *Boreholes must be placed at least 80 mm from the glass edge or from a neighbouring borehole.*
- *Only double disk point fittings for cylindrical boreholes are regulated.*
- *The disk diameter must be at least 50 mm.*
- *The clamping depth must be at least 12 mm.*

*Serviceability Limit State (SLS): Calculation of the maximum deflection  $f_{max}$  by appropriate means, finite element analysis is recommended. Validation of FEM is provided by verification models. Experimentally determined spring stiffness of the point fixing can be considered. Test setups are provided in the annex of the standard. Friction between interlaying materials must not be considered.  $C_d = 1/100$  of the effective span.*

*Ultimate Limit State (ULS):*

- *Point fixing: Calculation of the maximum load capacity on the basis of technical building regulations, if possible. If not, experimental determination of the maximum load capacity considering different load directions.*
- *Glass: Calculation of the maximum tensile stress on the glass surface by appropriate means, finite element analysis is recommended. Validation of FEM is provided by verification models. Experimentally determined spring stiffness of the point fixing can be considered. Test setups are provided in the annex of the standard. Friction between interlaying materials must not be considered.*

*Simplified design method:*

*A simplified design method for calculation of the maximum tensile stress  $\sigma_{lmax}$  on the glass surface can be used if the following requirements are met:*

- *The glazing consists of monolithic or laminated glass only, insulating glass units are not considered*
- *Double disk point fixings are used*
- *No additional non-load bearing holes are present. If so, stress concentration at those holes has to be especially calculated.*
- *The clearance fit must be at least 1 mm.*

*Mechanical Model of the simplified design method: The method is based on the concept of splitting the whole problem into local and global areas according to St. Venant's principle. Stress concentration at the borehole can be calculated by transformation of the support reactions into local stress components using stress component factors and by superposing a global stress component multiplied by a stress concentration factor which takes the global behaviour of the plate into account.*

*The global behaviour of the plate can be calculated by finite element analysis using a very simple model which consists of shell elements to represent the glass and spring elements representing the point fixing. The model show single node supports which mechanically end up in stress singularities. But due to St. Venant's principle there is no need to represent the borehole and the point fixing in detail, because any stress singularity at the single node support will not contribute to the design equation and therefore can be neglected.*

**Superposition**      **Local components**      **Global component**      **(SLG-Method)**

$F_z \leftrightarrow \sigma_{Fz}$       res  $F_{xy} \leftrightarrow \sigma_{Fxy}$       res  $M_{xy} \leftrightarrow \sigma_{Mxy}$        $\sigma_g = \max \sigma_1 (r = 3 \cdot \varnothing_{\text{Borehole}})$

*The design value of the action (stress) results from*

$$E_d = \sigma_{Fz,d} + \sigma_{Fxy,d} + \sigma_{M,d} + k \cdot \sigma_{g,d}$$

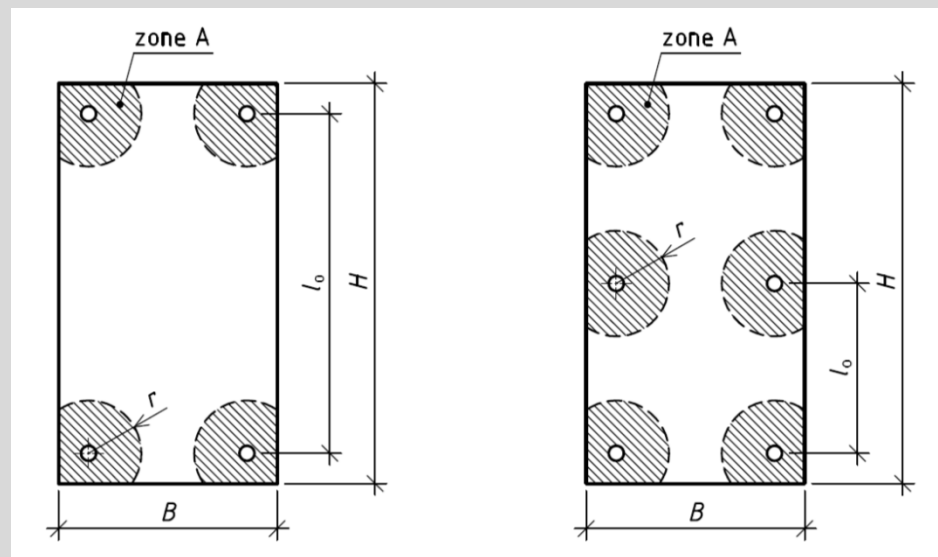
with  $\sigma_{Fz} = \frac{b_{Fz}}{d^2} \cdot \frac{t_{ref}^2}{t_i^2} \cdot F_z$ ,  $\sigma_{Fxy} = \frac{b_{Fxy}}{d^2} \cdot \frac{t_{ref}}{t_i} \cdot F_{xy}$ ,  $\sigma_M = \frac{b_M}{d^3} \cdot \frac{t_{ref}^2}{t_i^2} \cdot M_{xy}$

*Stress component factors b depend on the type of point fixing and the geometry of the borehole and are provided for a variation of parameters in the standard.*

**NEN 2608 [45]:** Like described in Code Review No. 28 a potential reduction of pre-stress is taken into account in zone 4 (hole zone)

*Related to the shear stiffness of a laminated glass the code defines a zone A with radius r ( $r = 10t$  with  $t =$  thickness of the glass laminate) around the point fixings, for which the shear interaction*

coefficient is regarded as 0 for all loads and load durations.



*Cahier CSTB 3574 [68]: This document gives rules for glazing with point supports. It defines conception and fabrication recommendations on glass elements and supporting structure. It describes loading conditions and dimensioning methods for glass plates with several support methods (four points, six points, two points and a line...). The experimental procedure is defined to ensure glass and structural point resistance.*

## Eurocode Outlook No. 28

- (1) *The Eurocode should take into account the design of glazing with drilled point supports.*
- (2) *Thereby the stresses around the holes have to be assessed by appropriate means like FEM, analytical procedures or combined methods.*
- (3) *Whilst using FEM, the degree of elements and meshing have to guarantee:*
  - *Results are consolidated and do not depend on a further refinement (prior model convergence investigation)*
  - *All relevant effects from the detailing and from tolerances should be taken into account.*
  - *As far as they have a potentially negative influence on the corresponding load and design situation, all restraints from boundary conditions and loading should be considered. As far as the influences are potentially positive for the corresponding load and design situation, they have to be neglected.*
- (4) *For an analytical assessment the concept of “structural stresses” should be applied. Thereby the acting global moments have to be calculated, the local stress amplification however then should be superposed. The local stress amplification should be taken from a catalogue in which each system may be characterized.*

### 6.5.4 Adhesively bonded point fixings

Adhesive bonding provides an alternative for drilled connections. The main advantage of these adhesive bonds is that they do not require any drilling and thus avoid mechanical damaging of the glass. Furthermore, the load is spread over a relatively large surface, which reduces local stressing of the glass. Adhesive connections can be executed using adhesives

such as epoxies, acrylates, polyurethanes and silicones. In addition, stiff (ionomer) interlayers and transparent addition cured silicon foil material are currently gaining interest for creating adhesive connections [125][126]. However, due to the uncertainties about the durability and long-term behaviour of adhesive connections, their application in practice is currently limited and additional retaining devices are needed. Further research into adhesively bonded fixings is thus required. More information is included in chapter 8.4.

### 6.5.5 Embedded systems

The advent of new ionomere interlayers has had important influence in recent improvements of glass fixing systems. Embedded solutions based on the combination of the lamination process and the assembly of glass fittings have the capability of combining most of the advantages of available mechanic as well as of adhesive fixing solutions. These systems improve the strength, safety, durability and appearance of frameless laminated glazing, offering new possibilities especially under severe environmental conditions.

The incorporation of the metallic fitting into the laminated glass, Figure 6-5, improves the distribution of the applied loads between both glass components of the laminate, giving a significant increase in load bearing capacity while at the same time reducing the glass thickness required.

The absence of exterior bolts, caps or washers or holes at the external glass surface, allows the use of a wider variety of glass types. Fixing securely to the inner structural glass component of an insulated unit avoids cold-bridging as the external glass surface is not penetrated with fittings. This results in a more thermally efficient façade.

These high performance laminated systems offer: increased strength and durability; reduced glass and structure weights; longer spans with reduced fixings; advanced post glass breakage security; visibly improved clarity; structural glass fin and beam applications.

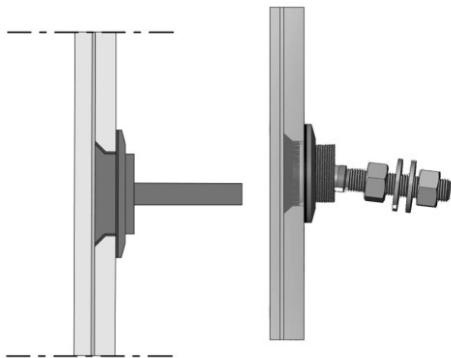


Figure 6-5 Embedded glass fixing system [127][128]

## 6.6 Glass Floors

Glass floors are horizontal glazing structures loaded by the self-weight of the glass, rarely wind or snow loads for outdoor applications and vertical live load. The upper glass layer gets often treatment to fulfil a certain slip resistant.

This type of application is considerably high because of the high risk of a glass breakage due to falling objects or persons. Code Review No. 49 gives an overview of the requirements in some national design standards. The loads given in EN 1991 are also indicated in the Review to demonstrate the actual non consistency between the national glass standards and the European load codes.

### Code Review No. 49

<i>Design standards: Requirements concerning floor glass laminate and of its design</i>
<p><i>DIN 18008-5 [44]:</i></p> <p><i>Glass products: The standard glass composition is consisting of at least three glass layers.</i></p> <p><i>Loading: according to EN 1991-1-1, additional dead load + single load (50 mm x 50 mm)</i></p> <p><i>Design ULS: all glass layers can be taken into account</i></p> <p><i>Design ULS: accidental design scenario</i></p> <p><i>Design SLS: all glass layers can be taken into account, maximal deflection L/200</i></p> <p><i>Residual resistance: test procedure (impact body is the “Torpedo”-impact body = hard impact) or constructive requirements (e.g. the two bottom glass layers should be float glass or heat strengthened glass to fulfil a good residual post failure capacity or resistance, edge covering, minimal glass thickness and maximal span).</i></p>
<p><i>ÖNORM B 3716 [48]:</i></p> <p><i>Glass products: The load carrying layer must be made of a laminated glass with an additional abrasion layer. Thermally toughened glass is only allowed in combination with float or heat strengthened glass. The minimal thickness of the PVB-sheet is 0.76 mm.</i></p> <p><i>Loading: according to EN 1991-1-1, additional dead load + single load (category F with 150 mm x 150 mm and category G with 250 mm x 250 mm)</i></p> <p><i>Design ULS: the abrasion layer cannot be taken into account</i></p> <p><i>Design SLS: the abrasion layer cannot be taken into account, maximal deflection L/100</i></p> <p><i>Residual resistance: accidental design scenario</i></p>
<p><i>Cahier CSTB 3448 [70]: This document gives rules for glass floors and stairs installation. It defines conception and fabrication recommendations. It describes the dimensioning method with specific loads, loading combinations and validation criteria. It gives the calculation method for two-sided and four-sided supported rectangular glass plates.</i></p>
<p><i>EN 1991 [39]: Depending on the type of usage different categories are defined. The single load has a load distribution area of 50 mm x 50 mm.</i></p>

### Eurocode Outlook No. 29

<p>(1) <i>The Eurocode should specify the verification of glass floors for static, dynamic and post failure scenarios. The consequence classes have to be specified. Composed laminates, bearing concepts and maybe an adequate test method should be proposed.</i></p> <p>(2) <i>In the scope of this, Eurocode should indicate also that the substructure always has to provide the same safety against impact as the glass.</i></p>
--

## 6.7 Horizontal Glazing accessible for maintenance

Compared to simple horizontal glass panels the risk of breakage and of course the loading is higher if the glass panel is accessible for maintenance. The considered scenario is that a person falls down onto the glass panel, the glass panel breaks but the person remains lying on the broken system. This impact is comparable to glass barriers but additionally a residual bending resistance has to be taken into account.

### Code Review No. 50

*Design standards: Requirements concerning the glass laminate and of its design*

*DIN 18008-6 [44]:*

*The background of these requirements is in line with the requirements of the “industrial injuries corporation”.*

*Glass products: Laminated glass panel made of two layers heat strengthened or float glass, thickness of the PVB layer 1.52 mm, in case of an insulating glass panel the lower glass panel should be fulfilled the above condition, the upper panel must be laminated glass or a thermally toughened glass*

*Loading: according to EN 1991-1-1 + single load of 1,5 kN (150 mm x 150 mm)*

*Design ULS and SLS: according to DIN 18008-1*

*Residual Resistance: a test procedure has to be fulfilled to verify the system under a dynamic impact; alternatively a dynamic calculation method is given.*

*CWCT Technical Notes (TN66 [62], TN67 [63], TN92 [64]): These technical notes give test method for post breakage load bearing capability. The critical part of the test is that with all glass panes broken the glass must sustain the weight of one or two persons (depending on glass size) for 30 minutes without collapsing.*

### Eurocode Outlook No. 30

- (1) *The Eurocode should specify the verification of horizontal glazing accessible for maintenance for static, dynamic and post failure situations. Adequately composed laminates and bearing concepts should be proposed.*
- (2) *In the scope of this, Eurocode should indicate also that the substructure always has to provide the same safety against impact as the glass.*

## 6.8 Retaining Glass Barriers and Glass Parapets

Glass barriers are vertical glazing loaded by e.g. wind and climatic loading (in case of insulating glass) and a horizontal personnel line load. All of the above mentioned fixings (linear or punctual) can be used.

Depending on the bearing type different “retaining glass barriers” categories have been defined. The meaning and the anticipated security levels of these categories are differing and are not in line with the categories of buildings according to EN 1991, see Code Review No. 50.

Concerning the needed safety level, the construction types are distinguished: either with an additional independent load supporting hand rail or rather the glass is only carrying the hori-



zontal personnel load. The corresponding impact level must be chosen depending on the defined categories.

Depending on the support conditions and the required safety level the recent regulations demand special types of glass assembling to fulfil a certain residual resistance and to minimize the risk of injuries. These requirements are based on many tests that have been carried out in the last century.

A linearly supported floor-to-ceiling glazing is one of the simplest types of barrier glazing. It has an excellent load bearing resistance and if laminated glass is used the risk of injuries is low. Preferably float glass should be used because of the high residual resistance after breakage. For insulating glazing two laminated glass panels or one laminated and one thermally toughened glass panel can be combined. If there is an independent hand rail in front of the floor-to-ceiling- glazing the necessary safety level is lower.

The line loads have to be taken into account for the static verification of the glazing. Additionally, the behaviour due to a horizontal impact is considered in form of dynamic impact verification.

There is a European test procedure for the classification of glass products under impact loading [21], see Code Review No. 51. In that standard a pendulum test with a soft impact body is specified, the testing scenario of which is deemed to be adequate to the impact of a person falling towards the glass panels. The European standard is related to a specific size (length and width of the panel) and the aim is to classify the glazing type. However there is no statement concerning larger glass panels, the substructure stiffness and the resistance of the support connections.

The static verification can be easily done by the aid of FEM, for the dynamic verification two different procedures are present. The verification can be done by impact tests with the original parameters (size of the glass panel, type of laminate and the original substructure) or dynamic calculation methods.

The dynamic calculations two methods may be used:

Method 1: Simulation of the shock of the impact body according to EN 12600 by using transient numerical methods. This method has been proofed by experimental and numerical analysis in several researches works (e.g. [131]). The model must consider the time dependence of the impact by taking into account the elastic impact between the impact body and the glass. The result is the stress evolution in the glass panel during the impact. The contact formulation between the impact body and the glass is influenced by the contact stiffness. Further explanations are given in [132] [133].

Method 2: Simplified method on the basis of the double-mass-oscillator. Equivalent loads must be evaluated depending on the resonance mass of the glass and the equivalent stiffness of the glass panel. With the calculated “equivalent static loads” the stresses can be evaluated using plate or beam theory. The simplified method has been evaluated both for linearly supported glass panels at four edges and at two opposite edges.

The action for both methods is set equal to an impact energy of  $E_{Basis} = 100 \text{ Nm}$ . This value is derived from the mass of a human body (80 kg), an impact speed of  $v = 2.04 \text{ m/s}$  with 60% resonance mass:

$$E = E_{Basis} = \frac{1}{2} \cdot 80 \text{ kg} \cdot 0,6 \cdot (2,04 \text{ m/s})^2 = 100 \text{ Nm}$$

This energy is equal to a falling height of 200 mm of the standardised impact body (mass 50 kg, tire pressure 4.0 bar).

## Code Review No. 51

### Test Standards:

EN 12600 [21]:

The test must be done for one glass size (847 mm x 1910 mm). The glass panel is linearly supported at all edges.

The classification is depending on the drop height of the impact body. For each drop height (190 mm, 450 mm or 1200 mm) the glass can be specified depending on the mode of breakage:

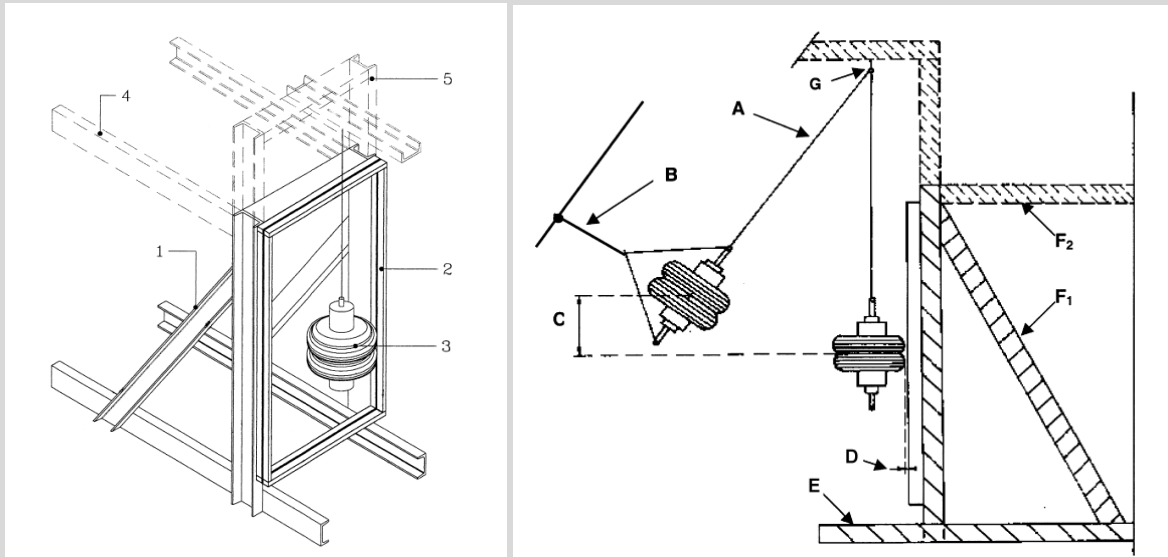
Type A: numerous cracks appear forming separate fragments with sharp edges, some which are large, typical of annealed glass.

Type B: numerous cracks appear, but the fragments hold together and do not separate, typical of laminated glass.

Type C: disintegration occurs, leading to a large number of small particles that are relatively harmless, typical of toughened glass.

Falling height for the classification:  $\Delta H_{Class 1} = 1200 \text{ mm}$ ,  $\Delta H_{Class 2} = 450 \text{ mm}$ ,  $\Delta H_{Class 3} = 190 \text{ mm}$

The classification is according the highest falling height without breakage or the breakage pattern of the glass .



Fiche Technique 47 [71]: This document gives the height for a double tire impact test to have an equivalence with the previous French impact test norm NF P 08-302 (impact with a heavy soft bag of 50 kg) for glass façades safety validation.

## Code Review No. 52

### Design Standards:

EN 1991-1-1 [39], Table 6.1:

*Categories dependent on the utilisation of the building:*

*Category A: living space*

*Category B: office space*

*Category C: area with gathering*

*Category D: shopping space*

*The categories are related to*

- *vertical live load for floors and balconies and*
- *horizontal line loads for core walls and barriers.*

*DIN 18008-4 [44]:*

*The classification is according to the type of structure. It is not related to the type of utilisation .*

*Verification ULS for static loading: according to DIN 18008-1*

*Verification SLS for static loading according to DIN 18008-1*

*Verification ULS for dynamic loading: verification of the glass and the related connection (linear support or point fixings), the verification of the dynamic loading is possible according method 1 and 2 explained above. Beyond that, some systems are given (glass type, size and boundary conditions) which have been proofed by testing (empirical approach).*

*Falling height for verification by testing:  $\Delta H_{Cat.A} = 900 \text{ mm}$ ,  $\Delta H_{Cat.B} = 700 \text{ mm}$ ,  $\Delta H_{Cat.C} = 450 \text{ mm}$*

*Falling height for verification by calculation:  $\Delta H = 200 \text{ mm}$*

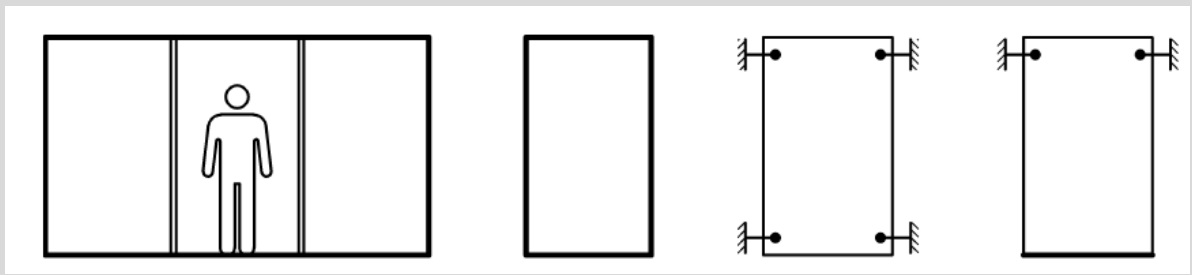
$$R_d = \frac{k_{mod} \cdot f_k}{\gamma_M} \text{ with } \gamma_M = 1,0 \text{ and}$$

$$k_{mod,thermally \text{ toughened glass}} = 1.4; k_{mod,heat \text{ strengthened glass}} = 1.7; k_{mod,float \text{ glass}} = 1.8$$

*Definition of barrier classes and allowed type of glazing:*

*Edge protection of the glass panels is necessary apart from point supported laminated glass panels with a sufficient residual resistance after breakage.*

*Category A*



*General requirements:*

- *Laminated glass*
- *In the case of insulating glass: combination of laminated glass and monolithic thermally toughened glass*

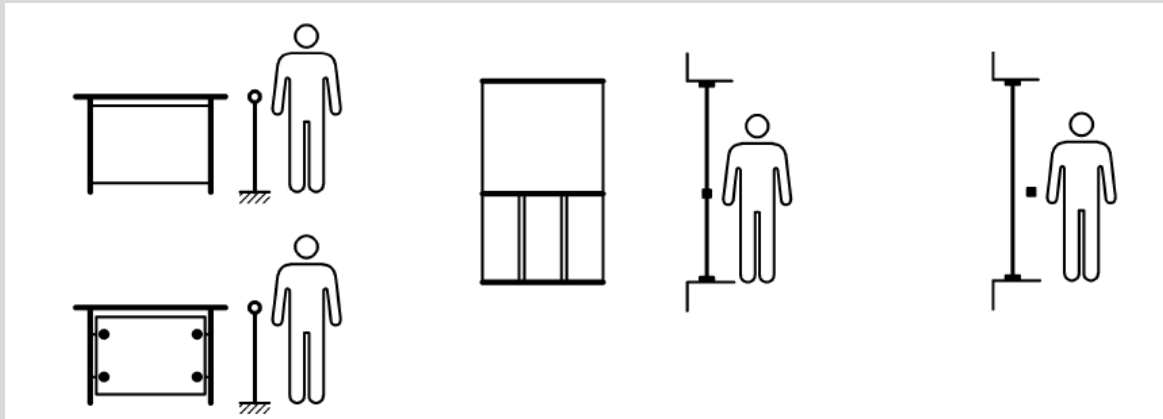
*Category B*



General requirements:

Laminated glass

Category C



C1

C2

C3

General requirements:

- Laminated glass; apart from panels with linear supported at all edges also monolithic thermally toughened glass is allowed (C1 and C2)
- Insulating glass panes: see insulating glass panels category A

BS 6180 [61]:

There are effectively 4 levels: domestic, commercial, light crowd, heavy crowd.

Loads are line load, concentrated load and uniformly distributed load. (Typically for glass, the thickness is determined by the concentrated load (smaller panes) and line load (larger panes)).

Any glass types can be used provided appropriate risk analysis has been undertaken and the glass is a safety glass according to EN 12600.

CSN 74 3305 [65]:

Types of barrier glazing:

A: 4-sided supported glazing (infill panel) with self-supporting handrail

B: 4-sided supported glazing where the handrail is supported by the glazing

C: 4-sided supported glazing with the balustrade function without handrail

Recommended types of glass:

All kind of laminated safety, monolithic thermally toughened glass (only if the person is not falling into the glazing, e.g. sloping balustrades of stairs) or insulating glass units with at least one safety laminated glass pane

All kind of laminated safety made of thermally toughened or heat strengthened glass

All kind of laminated safety

*D: 3-sides or 2-sides supported or point supported glazing*

*All kind of laminated safety glass, in case of point-supported glass with drilled holes the glass must be chemically, heat strengthened or thermally toughened (Heat-Soak-Test recommended)*

*E: self-supporting glass balustrade with continuous handrail or without handrail*

*All kind of laminated safety glass with chemically, heat strengthened or thermally toughened glass (with Heat-Soak-Test), the version without handrail is only allowed inside without public traffic*

*General requirements for the supports:*

*Group A,B,C:*

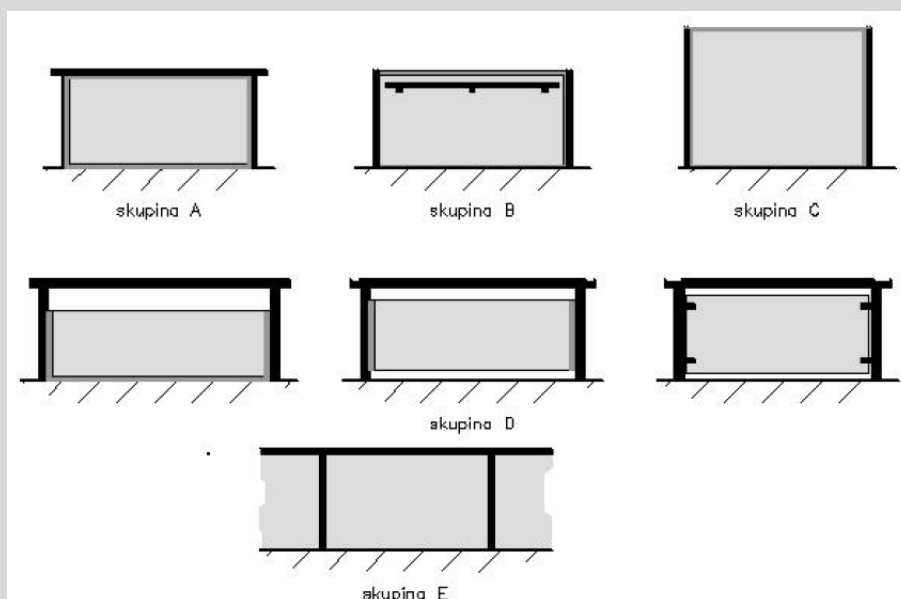
*Edge cover minimum 12 mm, but at least 1.5 times the thickness of the glass*

*Group D:*

*Edge cover minimum 18 mm, in case of point supported glass tests are necessary*

*Group E:*

*The edge clamping is described in detail. The detail is in line with the requirements for categorie B of DIN 18008-4 [44].*



*ULS: Horizontal loading according to EN 1991-1-1 (line load)*

*Impact test or given glass types already proved by testing*

*Cahier CSTB 3034 [69]: This document defines the experimental procedure dedicated to glass cantilever balustrades. The experimental campaign is composed of railing tests, impact tests and cyclic tests (for external balustrades only) and application depends on type of anchoring. Criteria are based on residual deformation after tests.*

## Eurocode Outlook No. 31

(1) For the dynamic impact, Eurocode should allow for both a theoretical and an experimental

*verification to prove the load capacity of the glass under soft impact.*

- (2) *The system, the design scenario, the consequence class and the failure limits have to be specified. Especially the definition of the impact energy for the respective components and the impact location should be given.*
- (3) *The notations must be unified to avoid misunderstandings between the basis of design, the Eurocode and the national documents used so far.*
- (4) *The requirements should or may consider modifications through NADs.*
- (5) *In the scope of this, Eurocode should indicate that also the substructure always has to provide the same safety against impact as the glass.*

## 6.9 Cold bent glass

Cold bending of glass is a technique suitable for large glazed surfaces with low curvature. A cold bent glass panel is not a product but rather is a construction method. That's the reason why it is classified in this report as a secondary structural element.

The glass is produced flat and then it is bent on site during installation, pushing or pulling an edge or a corner of it, so to reach the desired deflection and curvature.

Two kinds of curvature can be distinguished:

- Bending in a cylindrical shape (single curvature), when opposite edges of glass remain parallel and two edges result curved.
- Warping in a double curvature shape, when one corner is displaced and edges remain straight but no more parallel.

A further possibility of cold bending is the "laminated cold bent glass", here the glass panels are bended and laminated with a stiff ionomer interlayer. Apart from a small elastic recovery after the lamination process the laminate keeps its form. The result of this is a glass product because the glass producer is directly responsible for the form and the durability related to the bending. Furthermore, since the market is dominated by only one producer, so the Eurocode should not deal with this.

Glass is quite flexible, thanks to its low elasticity modulus (around 70 000 MPa), so it is possible to bend it considerably without breakage. Nevertheless, some special care should be taken to the following issues:

- Cold bending procedure induces a permanent strain, and consequently a permanent stress, in the glass pane, which should be considered when evaluating its strength and in combination with external loads. As a matter of fact, it is known that glass strength is sensitive to load duration.
- When dealing with bending laminated glass, consideration should be given to the stress induced in the interlayer and to the misalignment of the glass plies at their edges, resulting in an exposition of the interlayer rim, with possible consequences of edge delamination effects. However, it should also be considered that the creep of the polymeric interlayer material, subjected to such permanent strain, will end up in a relaxation of it and in consequent fading of the stress in the interlayer and thus a decrease of stress in the glass pane in the whole (because of the loss of shear collaboration between the glass plies). Because of such effect, at least two stages should be considered in the analysis: first, an installation stage, when the deformation load is

applied in a reasonably short time (some minutes) and the laminated glass results to become more stiff; influence of temperature on the interlayer shear modulus should also be considered in this stage; second, a long term stage, when the polymeric interlayer has already crept and the laminated glass pane results to be less stiff (as far as this load contribution is concerned).

- When cold-bending insulating glass, special attention should be given also to the stresses induced in the sealing polymer, in the polymeric interlayer and in the spacer. Exceeding stresses could result in a loss of moisture tightness of the isolating unit.
- Whatever the restraining system of glass to its supporting structure (i.e. silicone joint, rebate cover, point fixing, etc.), such restraint will support a not-negligible load, because of the cold bending, and therefore its strength and deformation shall be verified.

### Eurocode Outlook No. 32

- (1) *Since cold bending affects the effective strength of glass, the Eurocode should address cold bent glass. This applies for both, monolithic and laminated sections. However for laminated glass the viscous behaviour of the interlayer should be considered with regard to where, when and how the curvature is introduced.*
- (2) *For laminated glass it should be considered, where, when and how the curvature is introduced.*
- (3) *It should be considered that also stability and stiffness behaviour of cold bent glass is different compared to pure flat glazing.*
- (4) *Eurocode should give specifications on how to treat respectively verify the resulting forces on the substructure.*

### 6.10 Glass in Photovoltaic applications (PV modules)

Glass is the main material for photovoltaic applications. Till now, the standards do not provide a level of safety here comparable to existing glass standards or design standards. Code Review No. 53 gives an overview of existing test standards.

In general the application of PV modules can be distinguished between structural (e.g. roof glazing or facades) or non-structural.

### Code Review No. 53

#### Test standards:

*EN IEC 61646 [29] and EN IEC 61215 [30]: The goal of these standards is to determine the electrical and thermal characteristics of the tested modules including a mechanical load test, where one specimen is subjected to a distributed surface load of 2.4 kN/m<sup>2</sup> or 5.4 kN/m<sup>2</sup>. In addition these standards define a hail test and a thermic cycling test to ensure the electric functionality but it do not consider sufficiently the glass-specific material behaviour, in particular under thermal loads.*

*EN IEC 61646 does not consider sufficiently the time-dependent behaviour of the strength of annealed float glass and, as the tests are carried out at room temperature, a certain shear transfer between the upper and the lower glass plate is active due to the lamination sheet. This shear trans-*

*fer often does not exist in the real installation situation under solar radiation with the usual viscoelastic lamination sheets (PVB, EVA).*

*EN IEC 61730 [31][32]: This standard defines requirements for the construction of PV modules, to ensure the electrical and mechanical functionality for the designated lifetime. The tests refer to IEC 61646 respectively IEC 61216 and define additionally a pendulum impact test for a proof of safety of the broken module.*

*Design Standard: VDE 0126-21 [58]: According to this standard PV modules must meet the requirements of the German glass standards, depending on the application.*

### **Eurocode Outlook No. 33**

- (1) *A proof of the bearing capacity by calculation should be done in the future according to the Eurocode. Additionally, the load case temperature has to be considered more precisely since variable temperature profiles over the cross-section or in plane can lead to design relevant principal tensile stresses.*
- (2) *Mechanical bearing capacity tests should be defined, based on the fundamentals of structural design, e.g. according to EN 1990 Appendix D. Hence, with a test sequence which includes the real actions (storage conditions, load type and duration, temperature, etc.) and a sufficient number of specimens, the design value of the resistance can be determined and opposed to the design value of the impact loads.*
- (3) *The consequence classes should be specified.*
- (4) *Adequately types of glass should be proposed, e.g. if a connection socket is installed on the surface area of the module, then the drilled rear glass must be considered and should be thermally toughened.*

## **6.11 Reinforced glass components with enhanced redundancy**

An interesting and promising method to enhance the redundancy and residual resistance of glass components, such as glass panels and glass beams, is the incorporation of reinforcement in the glass component. This reinforcement (e.g. steel, timber, GFRP or CFRP) can be bonded to the glass by means of adhesives or by means of PVB and ionomer interlayers. Upon glass failure the reinforcement bridges the crack(s) in the glass and carries the tensile force. This allows the component to still carry significant load even if the glass is (extensively) fractured. Various reinforcement solutions and bonding techniques are currently under development in a scientific context, e.g. [186][189][190][236] [241][243], and some solutions have already found practical application in realized projects, e.g.[191][205]. Points of continuing investigation are particularly the performance of the adhesive bond between glass and reinforcement, and the overall structural performance of the reinforced glass component under various environmental and loading conditions (see chapters 7 and 8.4).

Reinforced glass components are very promising due to their significant robustness and redundancy. Although the general proof of concept is already extensively provided, further research may focus in detail on the structural performance of these reinforced glass components under various loading conditions. Furthermore, additional research into the performance of the adhesive bond between the glass and the reinforcement is needed.



## 7 Design of primary structural components

### 7.1 General

Like previously explained glass can be used as primary structural components which are a part in the overall structural system. For these situations the glass elements have to be designed with higher requirements on robustness and redundancy, see chapter 0. Also special considerations have to be taken whether fire action is a relevant issue and if so, which protection measures (additional fire glass) or redundancy design (safeguard protection etc.) should be performed.

Further references to the stability of glass components can be found in (e.g. [210]).

#### **Eurocode Outlook No. 34**

- (1) *For the design of primary structural elements and for each design case, the Eurocode should provide rules for*
  - *Cross-sectional layer composition of laminates to achieve robustness and redundancy against failure of one or more glass-layers (on the level of the cross section),*
  - *Background safety measures in the component itself in case of failure of a glass pane (on the component level),*
  - *Additional components that can take over the load bearing in case of failure of a complete component (on the structural building level).*
- (2) *The post-failure-measures should be designed under a reduced safety factor-regime both for static loading only as well as for the dynamic impact eventually combined with other occurring actions.*
- (3) *For the cross-sectional laminate design it should be distinguished between “protection layers” and “load carrying (core) layers”. The load carrying (core) layer itself can consist of laminates again, the breakage pattern and strength of which should be a major design issue.*
- (4) *To ensure the full protection against hard impact the free edges have to be protected so that the load carrying core layers are not likely to be destroyed from the edges.*
- (5) *Considerations should be taken on how strong and intensive the impact energy is such that the thickness and quality of the protection layers as well as the kind of edge protection can be chosen. Basically the same applies for the choice of interlayer and its thickness.*
- (6) *On the component level sufficient safeguard protection can be achieved by additional glass panes that take over the structural loads in case of failure of an entire glass panel. These additional structural systems may be activated only once the glass panel has (totally) failed.*
- (7) *Analogously similar safeguard protection should be considered on the structural building level.*
- (8) *To some extent on each of the levels, an “overdesign” of the cross-section, the component or the whole structural ensemble can fulfil the robustness-requirements, too.*
- (9) *In any case, the necessity of the different measures and its combinations should be determined in advance by both a global and a local failure probability analysis for the relevant scenarios. Therefore the requirements for “yielding” from specific consequence classes have to be considered. Alternatively a deterministic approach can be allowed in those cases*

where sufficient knowledge and experience from prior application and/or research work is available.

## 7.2 Shear panels

### 7.2.1 Buckling of shear panels with single point load introduction at the corners along the diagonal (corner loaded shear panels)

If shear panels are added to lattice girders with missing diagonals (such as „Vierendeel-systems“) filling the rectangular openings, these “glass fillings” can take over the diagonal propping forces. By that very transparent steel-glass truss works can be obtained, Figure 7-1.

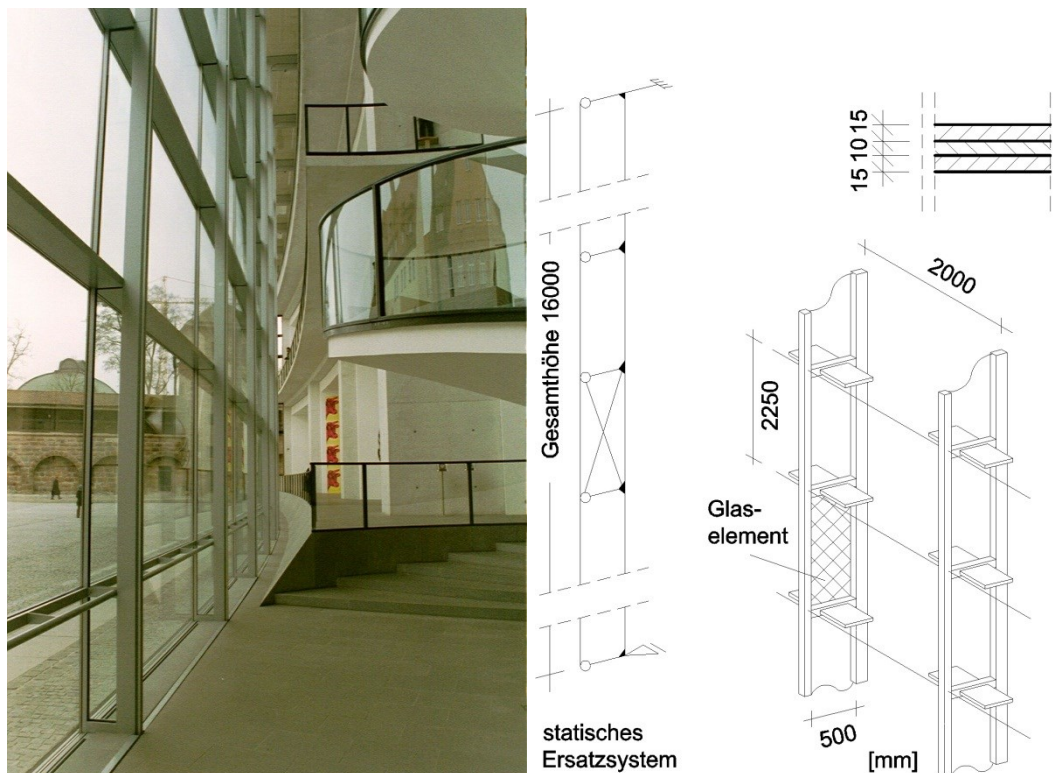


Figure 7-1 Steel-glass lattice (“ladder”) girder with glass-shear panels replacing the diagonals

Thereby the shear panel is loaded under an inner compression force acting along its diagonal. Thus it can be regarded as a compression beam with variable flexural inertia continuously supported along its axis. The continuous support is enabled by the “other” diagonal perpendicular to the considered diagonal in compression, Figure 7-3. Thus, the glass panel has to be supported at all four corners.

As the glass fillings are loaded by a distinct linear in-plane compression force they are to be assessed against flexural buckling. It should be noted that if the support at the edges would be continuous instead of punctual at the corners, the flexural buckling phenomenon would change over to a shear plate buckling problem.

In [150] corner loaded shear panels have been investigated with different detailing of the glass corners and load introduction. By calculating the elastic critical load  $D_{cr}$  of panels with e.g. square geometries by means of the FEM the related slenderness

$$\bar{\lambda} = \sqrt{\frac{f_K}{\sigma_{cr}}} = \sqrt{\frac{f_K}{\frac{D_{cr}}{b/40-t}}} \quad (7-1)$$

Can be achieved for monolithic glass sections. Experiments [150] then led to the following buckling curve, Figure 7-2

$$\chi = \frac{0,8}{\bar{\lambda}^2} \quad (7-2)$$

It is remarkable, that this buckling curve is almost identical with the buckling curve that has been derived for flexural buckling of glass columns, see later equation (7-43).

That strongly indicates that, regardless of what type, topology and geometry of different test specimens, they all lead to nearly the same buckling curve.

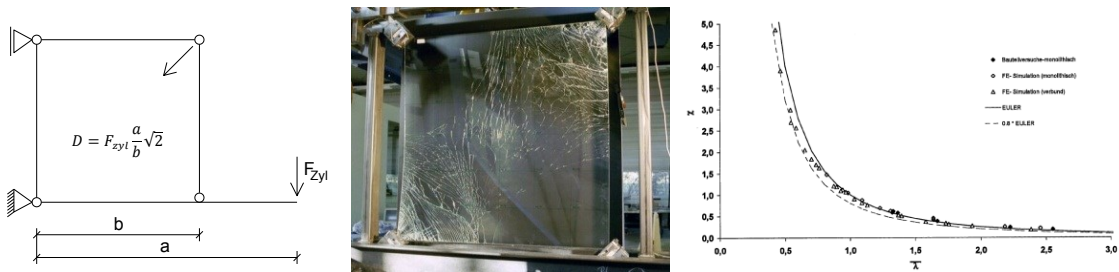


Figure 7-2 Corner loaded Glass panels with compression force acting along its diagonal and resulting buckling curve [150]

In case there is at the same time a transverse loading  $p$  existing (plate loading), then with good accuracy the so-called “crossing-beams-model” can be applied, Figure 7-3, with a single load at the point of the beam intersection. The so obtained buckling beam with a spring in its middle the following differential equation:

$$M = P \frac{2\ell}{4} - Cw \frac{2\ell}{4} + Nw = -EIw'' \quad (7-3)$$

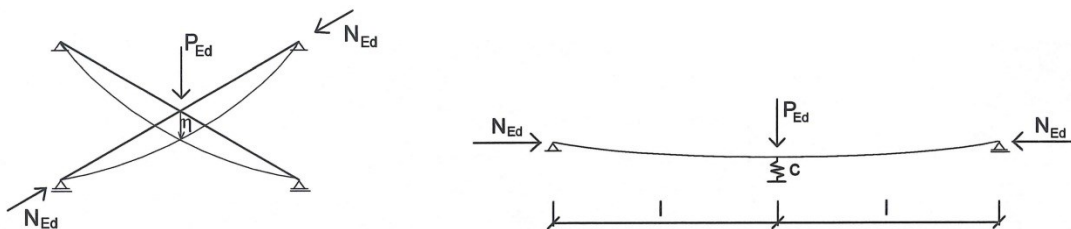


Figure 7-3 Model with crossing beams for corner loaded shear panels and beam under axial compression with substituting spring in the centre

Due to the spring the deflection shape is multimodal; however for square geometries a sinusoidal deflection shape can be used and the slight deviations of

$$w = a \sin \frac{\pi x}{2\ell} \quad (7-4)$$

can be neglected compared to the real deformation curve. The moment at centre point then reads

$$P \frac{\ell}{2} - Ca \frac{\ell}{2} + Na = EI \left( \frac{\pi}{2} \right)^2 a \quad (7-5)$$

Referring to Euler's elastic critical load it leads to

$$a = \frac{P \frac{\ell}{2}}{\frac{EI\pi^2}{\ell} \left[ I - \frac{N}{EI\pi^2} + \frac{C\ell^3}{2EI\pi^2} \right]} \quad (7-6)$$

$$\text{and } M = P \frac{\ell}{2} \frac{I}{\left[ I - \frac{N + C\ell/2}{N_{cr}} \right]} \quad (7-7)$$

The spring stiffness is obtained by

$$a = P \frac{\ell^3}{2EI\pi^2} \quad \text{and} \quad C = 2 \frac{EI\pi^2}{\ell^3} = \frac{2N_{cr}}{\ell} \quad (7-8)$$

By this the moment can be determined to

$$M = \frac{P\ell}{4} \frac{I}{I - \frac{N}{2N_{cr}}} \quad (7-9)$$

and the moment magnification by the non-linear or second order effect is

$$M'' = M' \frac{I}{I - \frac{N}{2N_{cr}}} \quad (7-10)$$

With the utilisation factor  $\bar{d}$  for the compression force  $D = N$  using a linear interaction

$$\bar{d} = \frac{N}{N_R} \chi = \frac{D}{D_R} \chi = \left( I - \frac{M}{M_R} \right) \quad (7-11)$$

and  $N/N_{cr} = \bar{\lambda}^2$

$$M'' = M' \frac{I}{I - \bar{d}\chi\bar{\lambda}^2} \quad (7-12)$$

is obtained, that means with  $\chi = 0,8/\bar{\lambda}^2$  the available moment related to the pure moment capacity reads as follows

$$\frac{M^I}{M_R} = (1 - \bar{d})(1 - 0,4\bar{d}) \quad (7-13)$$

or generally with the utilisation factors  $\bar{p} = p/p_R$  and  $\bar{d}$  :

$$\bar{p} = (1 - \bar{d})(1 - 0,4\bar{d}) \quad (7-14)$$

The interaction curve  $\bar{d}(\bar{p})$  is depicted in Figure 7-4.

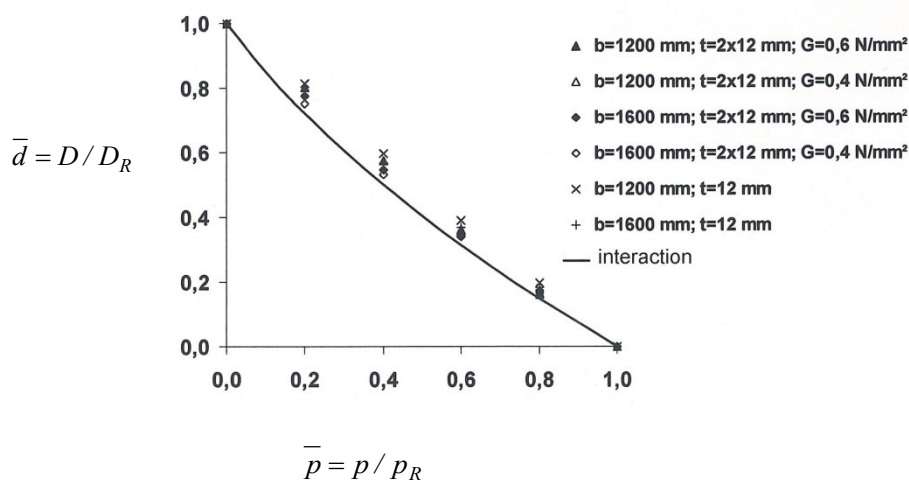


Figure 7-4 Interaction curve, normalised for corner loaded square panels under diagonal compression load  $\bar{d} = D/D_R$  with transverse plate loading  $\bar{p} = p/p_R$  [150]

### Eurocode Outlook No. 35

- (1) The shear buckling verification of shear panels (regardless of what type of load introduction) can be performed either by a non-linear numerical investigation or by using appropriate buckling curves. The Eurocode on Structural Glass should allow for both methodologies.
- (2) The imperfection assumption of the buckling curves should coincide with the imperfections that are used for alternative non-linear numerical analysis.
- (3) The imperfections for panels of glass in shear are due to two reasons:
  - a. The geometrical and inherent structural imperfections that can be measured by experiments via Southwell-procedure.
  - b. The tolerances from erecting and assembling the plate into the frame. Due to the slenderness of glass panels erecting tolerances may appear. Whereas in the experiments those tolerance are often avoided, in practise they should be assumed additionally to be a constant value of 3.0 mm.
- (4) Reliable interlayer shear stiffness values in dependence on time and temperature can be taken into account.
- (5) The non-linear effect of different load durations on the buckling strength should be taken

into account unless the laminate is calculated without any composite effect.

- (6) The non-linear interaction of shear loads with transverse loading (wind, snow, gravity, climatic loading in case of insulating glass ...) has to be considered.
- (7) The Eurocode should give best practise examples for the detailing of the load introduction points.

## 7.2.2 Buckling of continuously supported shear panels

Shear stresses in glass shear panels can be introduced also continuously along the edges, additionally to those from load introductions in the corners. Mostly the edges are realized by adhesive bonding techniques (or clamping). It is clear that the continuous edge support increases the buckling resistance. To take this into account a thorough buckling investigation by FEM or other means is necessary.

### Code Review No. 54

#### Technical recommendation:

CNR-DT-210 [55]: A buckling verification approach for monolithic and laminated glass panels continuously supported and subjected to in-plane shear loads has been proposed in the Italian CNR-DT-210 document.

For monolithic panels, the stability check can be performed by comparing the design shear load  $V_{Ed}$  with the shear buckling strength  $V_{b,Rd}$ , where  $V_{b,Rd}$ , in accordance with buckling approaches commonly used for structural panels composed of traditional construction elements, is defined as  $V_{b,Rd} = \chi A \tau_d$ .

Based on contributions available in literature, the characteristic shear strength  $\tau_k$  is assumed equal to the characteristic tensile strength  $\sigma_k$ . At the same time, the buckling coefficient  $\chi$  is calculated as suggested in EC3 for steel structures:

$$\chi = \frac{1}{\Phi + \sqrt{\Phi^2 - \bar{\lambda}^2}} \leq 1,$$

with

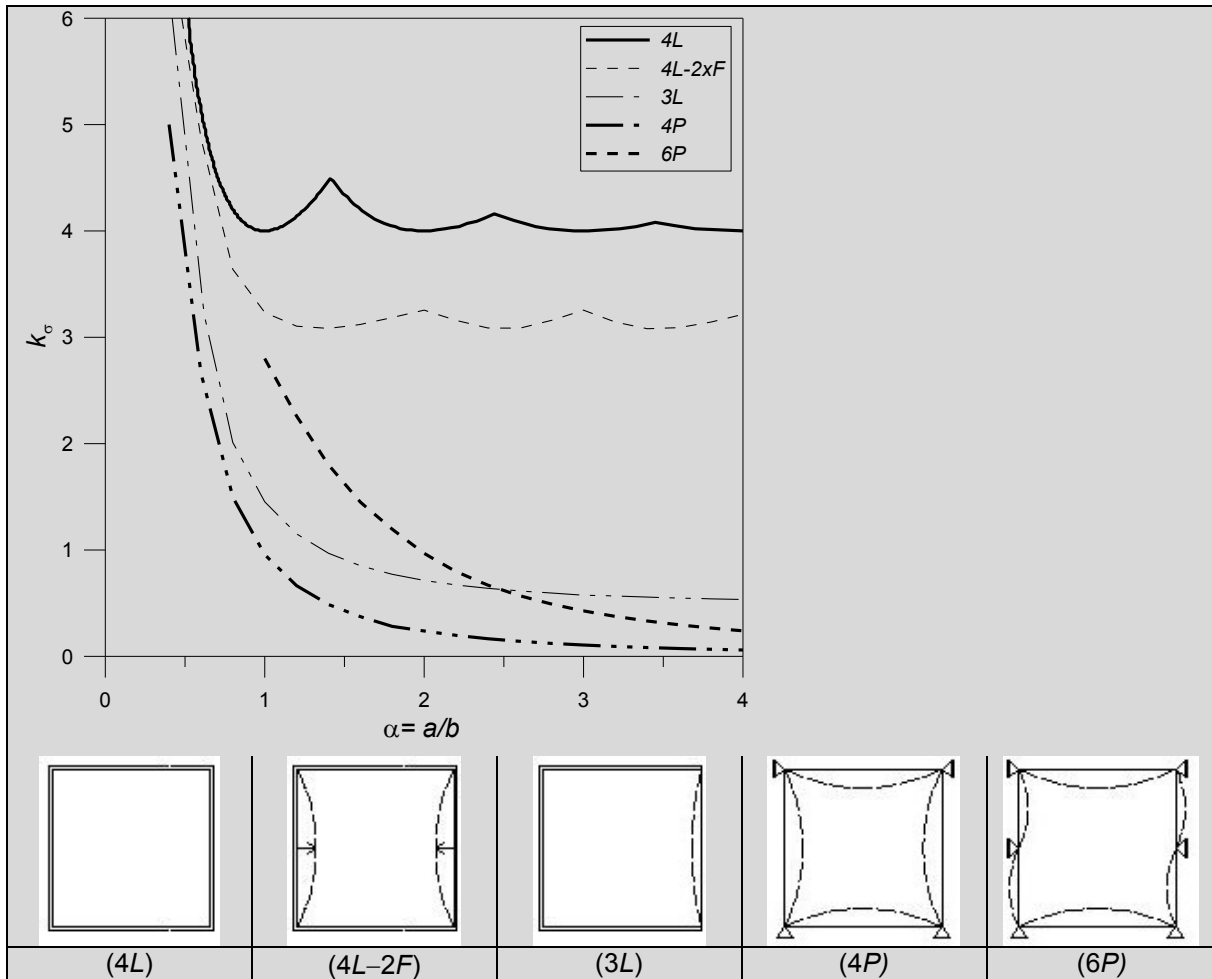
$$\Phi = 0.5 [1 + \alpha(\bar{\lambda} - \alpha_0) + \bar{\lambda}^2],$$

$\bar{\lambda}$  the normalized slenderness ratio,  $\alpha$  and  $\alpha_0$  appropriate imperfection factors.

An initial geometrical imperfection proportional to the first modal shape of the panel, of maximum amplitude  $w_0 = L/1000$  is taken into account. Based on experimental results and contributions available in literature, buckling occurs when reaching a maximum tensile strength equal to  $\sigma_k/1.4$  or equivalently at the attainment of a maximum transversal displacement  $w_{max} = L/300$ . Both these aspects are taken into account in the estimation of  $\chi$  for monolithic panels composed of various glass types, by means of imperfection factors  $\alpha = 0.49$  and  $\alpha_0 = 0.50$  calibrated by numerical and experimental predictions.

The same verification approach (with  $\alpha = 0.49$  and  $\alpha_0 = 0.50$ ) is proposed, also for the stability check of panels composed of laminated glass. In this case, an equivalent thickness formulation derived from Wolfel-Bennison simplified approach is used.

The same verification approach is suggested, both for monolithic or laminated glass, also for panels not continuously supported along the four edges. In this case, appropriate buckling coefficients  $k_\sigma$  are proposed for various boundary conditions.



### Eurocode Outlook No. 36

- (1) *In principle the same issues apply as for corner loaded shear panels.*
- (2) *For the reliability and verification approach for linear edge bonding see chapter 8.4.*
- (3) *The shear buckling verification of shear panels (regardless of what type the load introduction is) can be performed either by a non-linear numerical investigation or by using appropriate buckling curves. The Eurocode on Structural Glass should allow for both methodologies.*
- (4) *The imperfection assumption of the buckling curves should coincide with the imperfections that are used for the alternative non-linear numerical analysis.*
- (5) *The imperfections for panels of glass in shear are due to two reasons:*
  - a. *The geometrical and inherent structural imperfections that can be measured by experiments via Southwell-procedure.*
  - b. *The tolerances from erecting and assembling the plate into the frame. Due to the slenderness of glass panels erecting tolerances may appear. Whereas in the experiments those tolerances are often avoided, in practise they should be assumed additionally with a constant value of 3,0 mm.*
- (6) *Reliable interlayer shear stiffness values in dependence on time and temperature can be taken into account.*
- (7) *The non-linear effect of different load durations on the buckling strength should be taken into account unless the laminate is calculated without any composite effect.*

(8) *The non-linear interaction of shear loads with transverse loading (e.g. wind, snow, gravity, climatic loading in case of insulating glass panels) has to be considered.*

### 7.2.3 Influence of the connection stiffness

Glass panes are increasingly being used to the stabilization of one storey buildings by acting as shear walls and thus replacing conventional bracings. This is the case for glass pavilions and some timber or steel frames or facades. The behaviour of such structural systems mainly depends on the stiffness of the connections.

The use of mechanical models to predict the behaviour of joints has a long tradition in the fields of steel and composite structures. The component method proposed in Eurocodes 3 [40] and 4 [42] is based on the association of springs that model the different components of a joint. Recent research results [209] demonstrate that these models are applicable for the purpose of the non-cracking pre-design of panes acting as a shear wall, because they are able to predict the in-plane stiffness and the force necessary to obtain a certain horizontal in-plane displacement at the top.

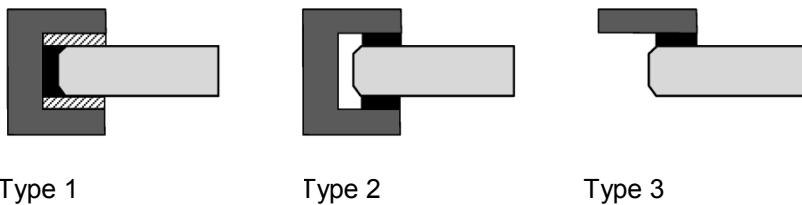


Figure 7-5 Adhesive bonded glass panes [209]

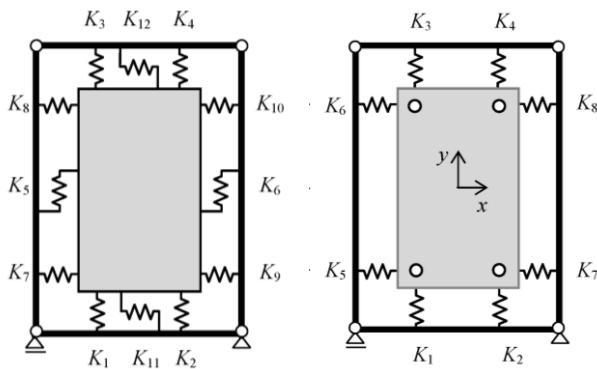


Figure 7-6 Mechanical model for circumferentially adhesive bonded glass panes and for glass panes with point support fixings [209]

## 7.3 Beams with bending about the strong axis – Lateral torsional buckling

### 7.3.1 Monolithic sections

A beam which is bent about the axes of greatest flexural rigidity may buckle laterally at a certain critical value of the load. This lateral buckling is of importance in the design of beams without lateral support, provided the flexural rigidity of the beam in the plane of bending is large in comparison to the lateral bending rigidity i.e. of the weak axis. As long as the load on such a beam is below the critical value, the beam will be stable. As the load is increased,



however, a condition is reached at which slightly deflected (and twisted) from of equilibrium becomes possible. The plane configuration of the beam is now unstable, and the lowest load at which this critical condition occurs represents the critical load for the beam, a phenomenon which is called lateral torsional buckling.

For beams in bending of monolithic glass, to obtain this failure mode, the cross-section must be rather slender a narrow rectangle; thickness (width)  $t$  and depth (height)  $h$ . The elastic critical moment is given in Figure 7-1 for different loading situations (without further analytical derivation that may be based on either equilibrium or energy approach). The constants  $c_1$  and  $c_2$  are given in Table 7-4.

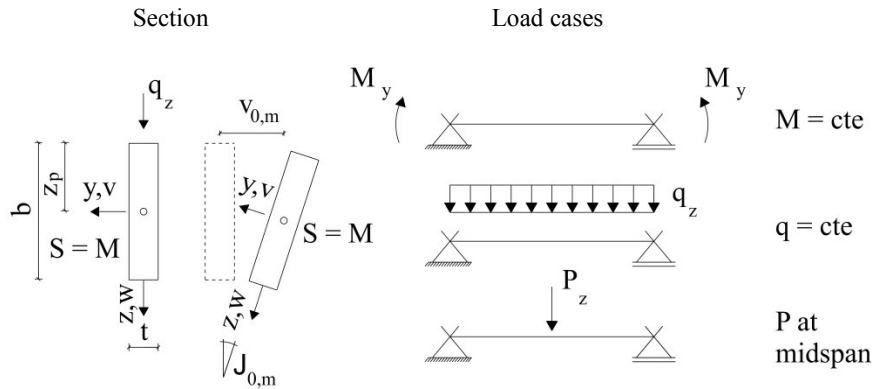


Figure 7-7 Loading situations

Table 7-1 Formula for  $M_{cr}$

Type of load	Critical moment
$M_y = cte.$	$M_{cr} = \frac{\pi}{\ell} \sqrt{E \cdot I_z \cdot G \cdot I_t}$
$q_z = cte.$ $P_z$ at midspan	$M_{cr} = \frac{I}{c_1} \cdot N_{ki} \left( \frac{1}{2} \cdot \frac{c_2}{c_1} \cdot z_p^M + \sqrt{\left( \frac{1}{2} \cdot \frac{c_2}{c_1} \cdot z_p^M \right)^2 + \frac{G \cdot I_t}{E \cdot I_z} \cdot \left( \frac{\ell}{\pi} \right)^2} \right)$

By a non-linear analysis basically the non-linear behaviour such as flexural buckling can be found. That was verified by experiments also for glass beams. Thereby for monolithic sections an effective imperfection of  $e_0 = L/400$  [136] was found.

As always this allows now two options for the verification

- The non-linear analysis by a second order calculation using  $e_0$ .
- The use of buckling curve that are derived in advance with  $e_0$ .

However a second order analysis seems often too laborious for ordinary cases, then the use of buckling curves is quicker. By

$$\bar{\lambda}_{LT} = \sqrt{\frac{M_{cr}}{M_{el}}} \quad \text{with} \quad M_{el} = \frac{t \cdot h^2}{b} \cdot f_t \cdot M_{cr} \quad \text{see Table 7-1.} \quad (7-15)$$

the verification format becomes

$$\frac{M_{Ed}}{\chi(\bar{\lambda}_{LT}) \cdot M_{el,d}} \leq 1,0 \quad (7-16)$$

It is interesting to note, that the onset  $\bar{\lambda}_0$  can be discussed similar as for flexural buckling. The limiting value is here also the tension strength at the edge.

Several research projects analysed the behaviour of monolithic glass beams and developed buckling curves [135][136][137][225].

### 7.3.2 Lateral torsional buckling of glass beams with laminated cross sections

For the assessment of lateral torsional buckling (LTB) of glass beams with monolithic sections the elastic theory can be applied directly (see the preceding chapter) as long as the imperfections for initial lateral deflection coupled with the initial twist  $v_0$  and  $\vartheta_0$  are known, as well as the stress limits  $\sigma_{Rd}$  (depending on time and load-combination). However, when LTB-problems with beams of laminated glass the sandwich effect needs consideration together with the non-linear, temperature- and time-dependant behaviour of the interlayer.

As a first approach and on the safe side, the composite action of the interlayer may be neglected and the beam can be treated as the sum of single beams with monolithic sections of the single glass layers, i.e. only the additive effect is considered. However, mostly this would lead to old-fashioned and heavy solutions. Critical load cases inducing LTB-problems often only appear over a short time period and therefore, despite of relaxation effects, the interlayer does provide sufficient shear stiffness to increase the LTB-resistance. So it is for economy reasons to consider composite action with regard to LTB.

In the following, the approach and the most important steps for a recently developed calculation and design concept [166] is presented by which the lateral torsional buckling behaviour of laminated glass beams can be verified. The concept takes into account the time- and temperature-dependant stiffness of the interlayer and further it considers the lamination influence by means of an extended warping approach. The concept is generally valid as long as the deformations are small and the material parameters are known, i.e. it does not depend on a specific type of interlayer or glass. It has been verified by finite element simulations as well as by experimental results, which is going to be shown.

The lateral and torsional deflections of simply supported glass beams that are loaded according to Figure 7-7 and have initial imperfections  $v_0$  respectively  $\vartheta_0$  according to Figure 7-8 can be described by basic non-linear equations [166] [167] given in Table 7-2 and Table 7-3 using the coefficients according to Table 7-4.

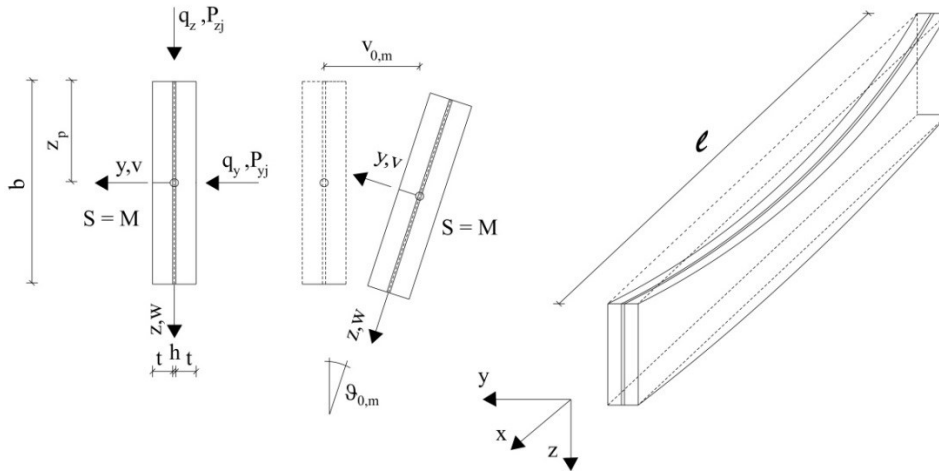


Figure 7-8 LTB of laminated glass beams: denominations and imperfection approach

Table 7-2 Lateral deformations

$M_y = cte.$	$v(x)^{Th.II} = \frac{\frac{G \cdot I_t}{E \cdot I_z} \cdot M_y \cdot \vartheta_0 + \frac{M_y^2}{E \cdot I_z} \cdot v_0}{G \cdot I_t \cdot \left(\frac{\pi}{l}\right)^2 - \frac{M_y^2}{E \cdot I_z}} \cdot \sin\left(\frac{\pi}{l} x\right)$
$q_z = cte.$	$v(x)^{Th.II} = \frac{c_1 \cdot \frac{G \cdot I_t}{E \cdot I_z} \cdot M_y \cdot \vartheta_0 + c_1^2 \frac{M_y^2}{E \cdot I_z} \cdot v_0}{G \cdot I_t \cdot \left(\frac{\pi}{l}\right)^2 - \frac{c_1^2 \cdot M_y^2}{E \cdot I_z} + c_2 \cdot M_y \cdot z_p \cdot \left(\frac{\pi}{l}\right)^2} \cdot \sin\left(\frac{\pi}{l} x\right)$
$P_z$ at midspan	

Table 7-3 Torsional deformations

Type of load	non-linear rotation
$M_y = cte.$	$\vartheta(x)^{Th.II} = \frac{\frac{M_y^2}{E \cdot I_z} \cdot \vartheta_0 + \left(\frac{\pi}{l}\right)^2 \cdot M_y \cdot v_0}{G \cdot I_t \cdot \left(\frac{\pi}{l}\right)^2 - \frac{M_y^2}{E \cdot I_z}} \cdot \sin\left(\frac{\pi}{l} x\right)$
$q_z = cte.$	$\vartheta(x)^{Th.II} = \frac{\vartheta_0 \left( \frac{c_1^2 \cdot M_y^2}{E \cdot I_z} - c_2 \cdot \left(\frac{\pi}{l}\right)^2 \cdot M_y \cdot z_p \right) + c_1 \cdot \left(\frac{\pi}{l}\right)^2 \cdot M_y \cdot v_0}{G \cdot I_t \cdot \left(\frac{\pi}{l}\right)^2 - \frac{c_1^2 \cdot M_y^2}{E \cdot I_z} + c_2 \cdot M_y \cdot z_p \cdot \left(\frac{\pi}{l}\right)^2} \cdot \sin\left(\frac{\pi}{l} x\right)$
$P_z$ at midspan	

Table 7-4 Coefficients  $c_1$  and  $c_2$

	$c_1$	$c_2$
$q_z = cte.$	$\frac{2}{3} + \frac{2}{\pi^2} = 0,8693$	$\frac{8}{\pi^2} = 0,8106$
$P_z$ at midspan	$\frac{2}{\pi^2} + \frac{1}{2} = 0,7026$	$\frac{8}{\pi^2} = 0,8106$

Thereby the torsional stiffness  $G \cdot I_T$  and the bending stiffness about the weak axis  $E \cdot I_Z$  are highly influenced by the shear stiffness of the interlayer  $G_F$  the amount of which can be determined by evaluation of relaxation tests, for example at  $-10^\circ\text{C}$ ,  $0^\circ\text{C}$  or room temperature  $23^\circ\text{C}$ . For this purpose a good evaluation procedure has been found using the “torsional test”, see chapter 2.2.4. By that it has been found for PVB interlayers, that a lower bound for the short term shear stiffness (up to 1h load duration) can be assumed to  $G_F = 0.2 \text{ N/mm}^2$  at higher temperatures  $> 20^\circ\text{C}$ . For long term loading (more than 1h load duration) the shear modulus of PVB interlayers converges to zero at higher temperatures  $> 20^\circ\text{C}$  [166].

However as this is true only for PVB, for stiffer interlayer material such as Ionomer sheets there might be also a value different from zero also for a long term time period.

The equations for calculating the critical bending moments about the strong axis, which also strongly depend on the shear stiffness of the interlayer, have been given in Table 7-1. The influence of the shear modulus  $G_F$  on stiffness and stress can be determined according to the “Extended bending and torsion theory” [166]. As shown in Figure 7-9 for bending and in Figure 7-10 for torsion, it considers the displacements in the shear gap by further degrees of (“step-like”) warping deformations  $\omega_\delta$  and  $\omega_\phi$  additional to the rigid body warping deformations  $\omega_N$  due to normal forces,  $\omega_B$  due to bending and  $\omega_T$  due to torsion.

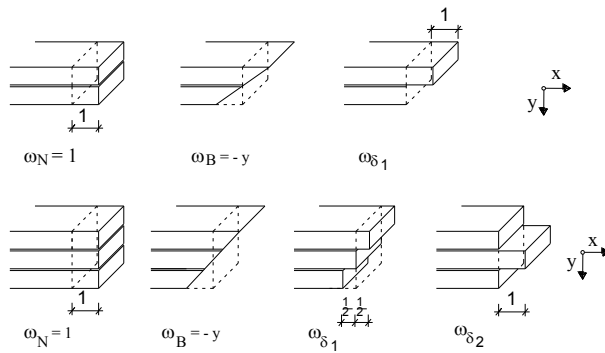


Figure 7-9 Rigid body warping and additional step-like warping deformations  $\omega_N$  and  $\omega_\delta$  for bending

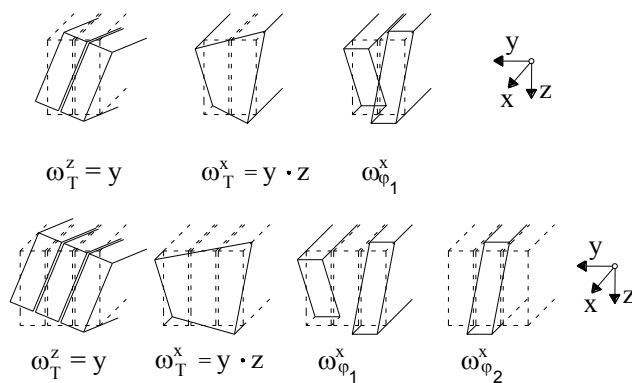


Figure 7-10 Rigid body warping  $\omega_T^z$  and  $\omega_T^x$  and additional warping deformation  $\omega_\phi$  for torsion

By solving the differential equations of the extended bending and torsion theory we obtain the equivalent geometric stiffness is obtained

$$I_T^{eq} = \frac{I}{\left( \frac{I}{S_{11}} + \frac{S_{12}^2}{S_{11}^2} \frac{I}{\tilde{T}_{22}} \right)} \quad (7-17)$$

Here the coefficients  $S_{ik}$  and the function  $\tilde{T}_{22}$  are given in Table 7-5, see also chapter 2.2.4, and

$$EI_z^{eq} = \frac{I}{v_B(L/2)} \cdot \frac{5}{384} \cdot L^4 \cdot q_y \quad \text{for } q = \text{const.} \quad (7-18)$$

$$EI_z^{eq} = \frac{I}{v_B(L/2)} \cdot \frac{1}{48} \cdot L^3 \cdot P_y \quad \text{for a single load } P \text{ at midspan,} \quad (7-19)$$

The solutions for  $v_B(L/2)$  are given in Table 7-6. Table 7-6 gives also the solutions for the calculation of the stresses  $\sigma_{xx}$  that originate from the lateral deformation  $v$  and the rotational deformation  $\vartheta$ .

Table 7-5 Coefficients  $S_{ik}$  and function  $\tilde{T}_{22}$  for torsion

	Laminated glass with 2 layers	Laminated glass with 3 layers
$S_{11}$	$\frac{8}{3} \cdot b \cdot \left[ -\left(\frac{1}{2}h\right)^3 + \left(t + \frac{1}{2}h\right)^3 \right]$	$\frac{8}{3} \cdot b \cdot \left[ -\left(\frac{1}{2}t+h\right)^3 + \left(\frac{3}{2}t+h\right)^3 + \left(\frac{1}{2}t\right)^3 \right]$
$S_{22}$	$\frac{1}{2} \cdot b \cdot t$	$2 \cdot b \cdot t$
$S_{12}$	$b \cdot \left[ \left(\frac{1}{2}h\right)^2 - \left(t - \frac{1}{2}h\right)^2 \right]$	$2 \cdot b \cdot \left[ \left(\frac{1}{2}t+h\right)^2 - \left(\frac{3}{2}t+h\right)^2 \right]$
$S_{\varphi,22}$	$\frac{1}{12} \frac{b^3}{h}$	$\frac{1}{6} \frac{b^3}{h}$
$\tilde{T}_{22}$	$-\frac{S_{12}^2}{S_{11}} + S_{22} + \frac{G_F}{G} S_{\varphi,22}$	

Table 7-6 Solutions  $v_B(\ell/2)$  for bending

	Laminated glass with 2 layers	Laminated glass with 3 layers
$B_{11}$	$2 \cdot b \cdot t$	$3 \cdot b \cdot t$
$B_{22}$	$\frac{2}{3} b \cdot \left[ \left(t + \frac{1}{2}h\right)^3 - \left(\frac{1}{2}h\right)^3 \right]$	$\frac{2}{3} \cdot b \cdot \left[ -\left(\frac{1}{2}t+h\right)^3 + \left(\frac{3}{2}t+h\right)^3 + \left(\frac{1}{2}t\right)^3 \right]$
$B_{33}$	$t \cdot b$	$\frac{1}{2} \cdot b \cdot t$
$B_{13}$	$t \cdot b$	$0$

	Laminated glass with 2 layers	Laminated glass with 3 layers
$B_{23}$	$\frac{1}{2}b \cdot [t^2 + h \cdot t]$	$\frac{1}{2} \cdot b \cdot \left[ -\left(\frac{3}{2}t + h\right)^2 + \left(\frac{1}{2}t + h\right)^2 \right]$
$\tilde{B}_{33}$	$-\frac{B_{13}^2}{B_{11}} - \frac{B_{23}^2}{B_{22}} + B_{33}$	$-\frac{B_{23}^2}{B_{22}} + B_{33}$
$S_{\delta,33}$	$\frac{b}{h}$	$\frac{b}{2 \cdot h}$
$\tilde{v}_B(\ell/2)$	$\frac{5 \cdot q_y \cdot \ell^4}{384 \cdot E \cdot B_{22}}$	$\frac{P_y \cdot \ell^3}{48 \cdot E \cdot B_{22}}$ (P at midspan)
$\xi_3$	$\frac{G_F \cdot \tilde{S}_{\delta,33} \cdot \ell^2}{E \cdot \tilde{B}_{33}}$	
$\Phi_{M,3}$	$\frac{8}{\xi_3} \left( 1 - \frac{1}{\cosh\left(\frac{\sqrt{\xi_3}}{2}\right)} \right)$	$\frac{2 \cdot \tanh\left(\frac{1}{2}\sqrt{\xi_3}\right)}{\sqrt{\xi_3}}$ (P at midspan)
$\Phi_{V,3}$	$\frac{B_{22}}{\tilde{B}_{33}} \cdot \frac{48}{5 \cdot \xi_3} (1 - \Phi_{M,3})$	$\frac{\tilde{B}_{22}}{\tilde{B}_{33}} \cdot \frac{12}{\xi_3} (1 - \Phi_{M,3})$ (P at midspan)
$\tilde{v}_{\delta 1}(\ell/2)$	$-\frac{B_{32}}{B_{22}} \cdot \Phi_{V,3} \cdot \tilde{v}_B(\ell/2)$	
$v_B(\ell/2)$	$\tilde{v}_B - \frac{B_{32}}{B_{22}} \cdot \tilde{v}_{\delta 1}$	
$M_{\tilde{\omega}_B}(\ell/2)$	$\frac{q_y \cdot \ell^2}{8}$ (q = const.)	$\frac{P_y \cdot \ell}{4}$ (P at midspan)
$\tilde{\omega}_{\delta 1}$	$-\frac{B_{31}}{B_{11}} - \frac{B_{32}}{B_{22}} \cdot y + \omega_{\delta 1}$ with $\omega_{\delta 1} = \begin{cases} 1 & \text{für } -(t + \frac{1}{2}h) < y < -\frac{1}{2}h \\ 0 & \text{für } \frac{1}{2}h < y < t + \frac{1}{2}h \end{cases}$	$\frac{B_{23}}{B_{22}} y + \omega_{\delta 1}$ with $\omega_{\delta 1} = \begin{cases} -1/2 & \text{für } -(\frac{3}{2}t + h) < y < -(\frac{1}{2}t + h) \\ 0 & \text{für } -\frac{1}{2}t < y < \frac{1}{2}t \\ 1/2 & \text{für } \frac{1}{2}t + h < y < \frac{3}{2}t + h \end{cases}$
$\sigma_{xx}$	$M_{\tilde{\omega}_B} \left( -\frac{\tilde{\omega}_B}{B_{22}} - \frac{\tilde{r}_3 \cdot \Phi_{M,3}}{\tilde{B}_{33}} \cdot \tilde{\omega}_{\delta 1} \right)$	

In order to verify the calculative assumptions pilot tests have been performed at simply supported beams out of monolithic and laminated glass. Thereby the hydraulic jack was laterally fixed so that this was also the horizontal boundary condition for the test specimen. The torsional rotations of the ends of the beams have been prevented (fork support) whereas the end supports were allowed to move laterally, see Figure 7-11. The load has been applied deformation controlled using different linear displacement-time-ramps to check the influence of the loading and unloading speed.

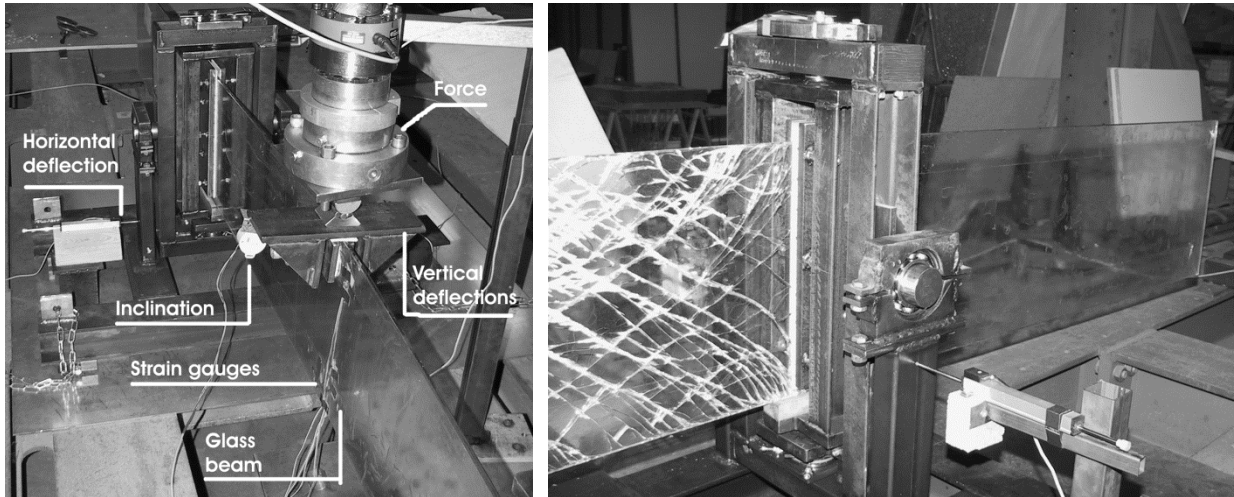


Figure 7-11 LTB- tests at beams of glass [166]

Figure 7-12 shows the load-time curves and displacement–time curves for a testing rate of  $v_B = 0.5 \text{ mm/s}$ , once for a linear displacement-time-ramp up to  $P_u$  (ULS test), and once as a holding test with a vertical jack displacement up to approximately  $0.9 \times P_u$ . The ultimate load here is proportional to  $P_{ki} = f(G_F(23^\circ\text{C}, t))$ .

Note: In case of load controlled testing (here not applied) no decreasing can occur and further, the beams will fail always due to sudden material breakage.

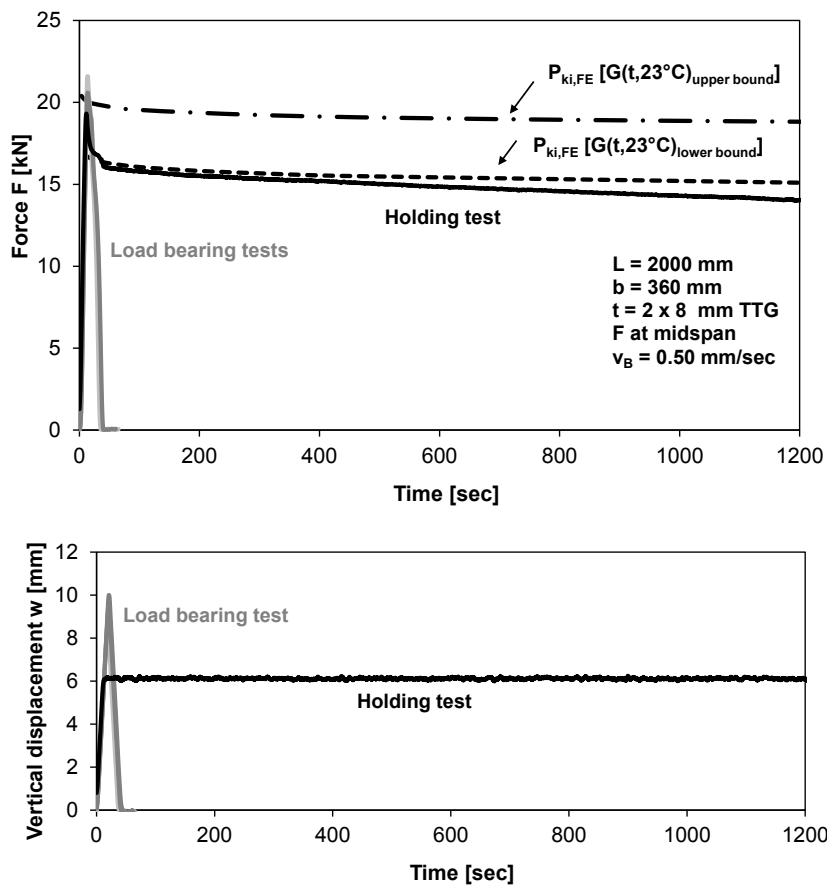


Figure 7-12 Test results with displacement-time-ramps and holding tests ( $v_B = 0.50 \text{ mm/s}$ ) [166]

To check the possibility of a recalculation with a constant shear modulus  $G_F$  Finite-Element simulations have been carried out with different “kept constant”  $G_F$ -values (Figure 7-13).

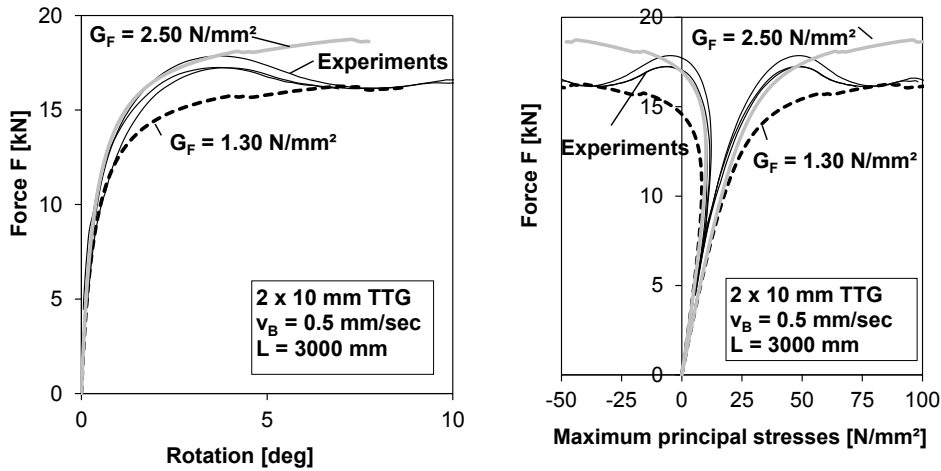


Figure 7-13 Comparison of the load-deformation curves from tests with those from FEM for different constant values of the interlayer shear modulus  $G_F$  [166]

Figure 7-14 and Figure 7-15 show examples for the load- deformation and load- stress development for monolithic and for laminated glass. Figure 7-16 gives an overview over the stresses across the depth of the section having a loading level of  $0.80 \cdot M_{cr}$ .

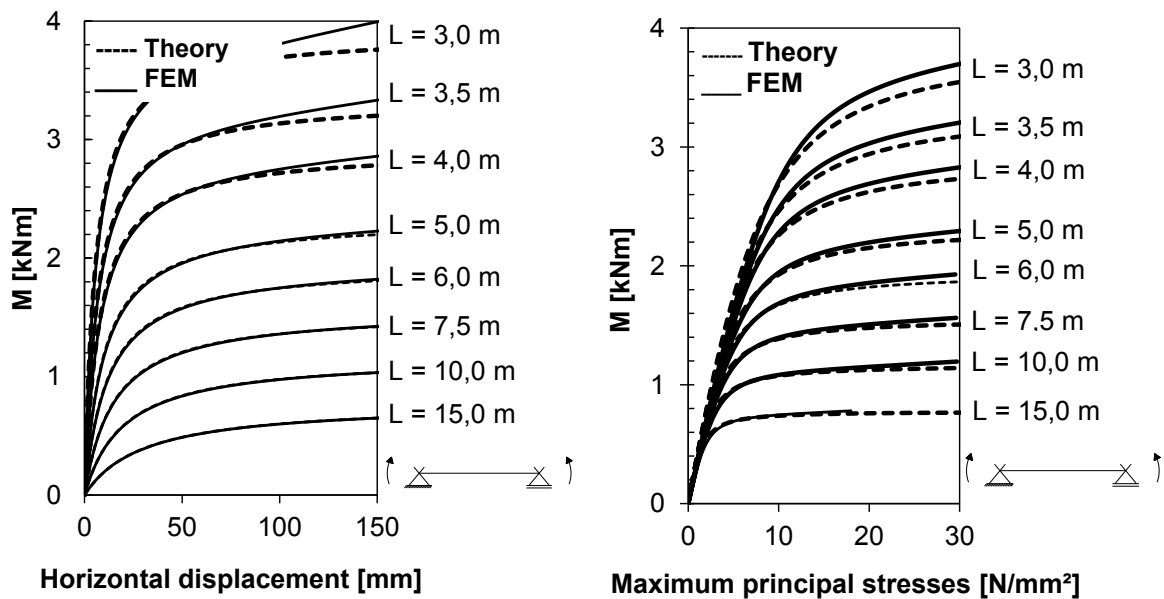


Figure 7-14 Load-deformation and load-stress evolution for monolithic glass ( $h = 500 \text{ mm}$ ,  $t = 10 \text{ mm}$ ,  $L = \text{variable}$ ) [166]



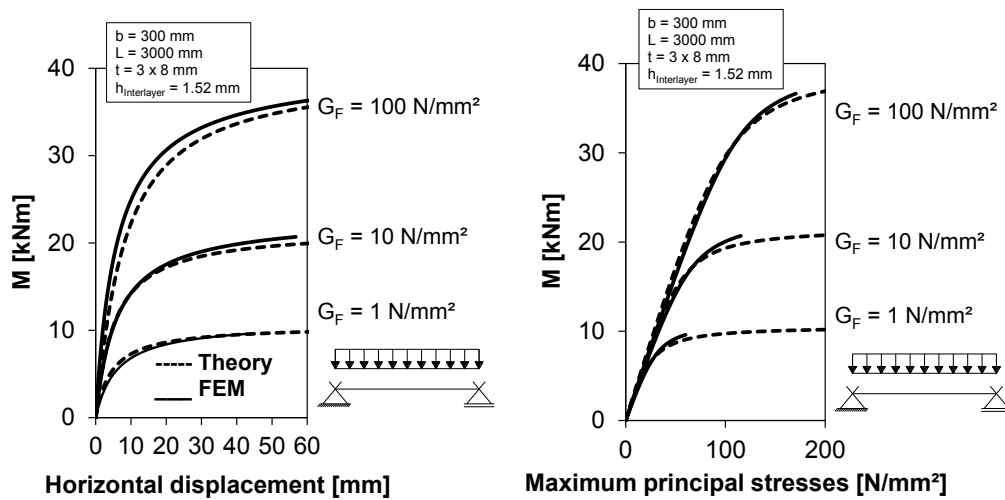


Figure 7-15 Load-deformation and load-stress evolution for laminated glass (triple glazing) [166]

M = cte.  
 t = 2 x 8 mm  
 h = 1.52 mm  
 b = 300 mm  
 L = 7500 mm  
 $G_F = 1 \text{ N/mm}^2$

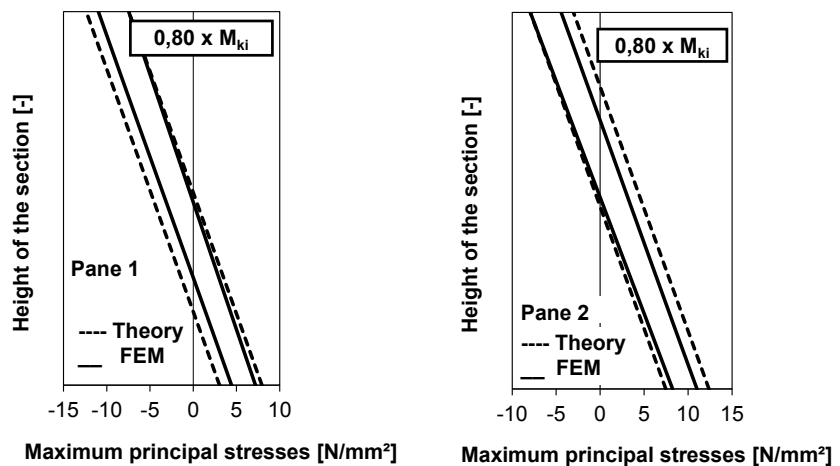


Figure 7-16 Stress distribution across the depth of the laminated glass beam (double glazing) [166]

The comparative calculations show that up to a moment loading of 80% of the critical moment the analytic calculation leads to sufficiently accurate results.

As a consequence, the consideration of the interlayer shear stiffness in the design of a laminated glass beam subject to LTB is really worthwhile, even for very low stiffness (e.g.  $G_F = 1.0 \text{ N/mm}^2$ ), as the significant increase of the critical moment shows. This gain is governed decisively by the increased weak axis bending stiffness. The occurring stresses become relevant before attaining the critical moment.

### Code Review No. 55

Technical recommendation:

CNR-DT-210 [55]: A buckling verification approach and a buckling verification curve for geometrically imperfect, monolithic and laminated glass beams have been proposed in the Italian CNR-

*DT-210 document.*

*A buckling verification curve is proposed for the stability check of glass beams in out-of-plane bending. Also in this case, the proposed buckling curve is defined like in EC3 for steel structures. The imperfection factors  $\alpha = 0.26$  and  $\alpha_0 = 0.20$  are calibrated by experimental and numerical results available in literature for monolithic or laminated glass beams of various glass types, subjected to constant bending moments, distributed lateral loads or concentrated forces at mid-span, and with initial imperfections of different size. For laminated glass beams, the same stability check can be performed by means of the Wolfel-Bennison equivalent thickness approach.*

*AS 1288 [66]: The Australian Design Standard for Glass gives a recommendation in the form not to exceed the critical bending moment divided by the factor 2.0. Basic formulas for the calculation of  $M_{crit}$  are given.*

## Eurocode Outlook No. 37

- (1) *As for buckling columns or for shear panels the LTB-verification of beams can be performed either by a full non-linear numerical investigation or by using appropriate buckling curves. The Eurocode on Structural Glass should allow for both methodologies.*
- (2) *The imperfection assumption of the buckling curves should coincide with the imperfections that are used for the numerical non-linear analysis.*
- (3) *Reliable values for interlayer shear stiffness in dependence on time and temperature can be taken into account.*
- (4) *The non-linear effect of different load durations on the buckling strength should be taken into account unless the laminate is calculated without any composite effect.*
- (5) *The boundary conditions at the supports and the position of load introduction has to be considered in particular. The Eurocode should give best practise examples for the detailing of the load introduction and bearing supports.*

## 7.4 Columns

### 7.4.1 General

Also for columns laminated sections are necessary in order to achieve sufficient robustness against impact as well as to achieve redundancy. The design of such load bearing glass structures necessitates the knowledge about the stability behaviour of laminated glass panes and appropriate technical rules. However, the load bearing capacity of monolithic glass columns must be analysed and thus known first.

Several research projects in Europe were dealing with the load bearing capacity of glass columns. For pane-like glass columns made of heat strengthened and thermally toughened glass design rules under axial loading have been derived. These rules have been verified by existing buckling tests, new experimental tests and numerical simulations.

The proposed design rules are verified by existing buckling tests ([86] [225] [226] [227] [228]) and by experimental tests and numerical simulations [229].

## Code Review No. 56

Technical recommendation:

*CNR-DT-210 [55]: A buckling curve has been proposed for monolithic and laminated glass col-*

umns affected by an initial sine-shaped imperfection has been proposed in the Italian CNR-DT-210 document.

In this case, the design axial load  $N_{Ed}$  is compared with the design buckling strength of the column  $N_{b,Rd}$ , with  $N_{b,Rd} = \chi A \sigma_d$ . The imperfection factors  $\alpha$  and  $\alpha_0$  required for the estimation of  $\chi$  are calibrated for geometrically imperfect glass columns affected by maximum sine-shaped imperfections up to  $w_0 = L/400$ , as suggested in recent contributions of literature.

Based on experimental predictions collected for monolithic and laminated glass columns in numerous papers available in literature, as well as on results obtained by numerical simulations, the values  $\alpha = 0.71$  and  $\alpha_0 = 0.60$  are proposed. Again, for laminated glass columns, the stability check can be performed with the same buckling curve, by means of the Wolfel-Bennison equivalent thickness approach.

#### 7.4.2 Consistent buckling curves for monolithic pane-like glass columns

The inhomogeneous differential equation for slender glass columns under an axial compression force  $N_E$  using a sinusoidal imperfection  $e(x) = e_0 \cdot \sin(\frac{\pi \cdot x}{l})$ , Figure 7-17, can be expressed by

$$w''(x) + \frac{N_E}{EI} \cdot w(x) = -\frac{N_E}{EI} e(x) \quad (7-20)$$

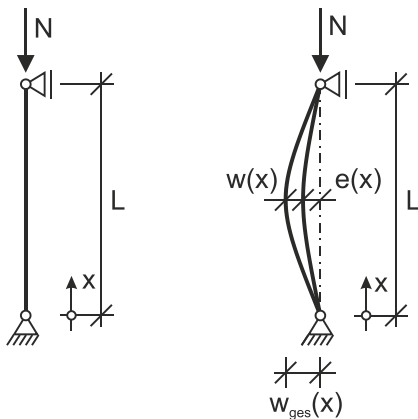


Figure 7-17 Origin, perfect and deformed imperfect system of a slim column,  $e(x)$ =imperfection,  $w(x)$ = bending ordinate

Assuming that bending and imperfection shape are affine, the total deflection in the middle of the column  $w_{ges}(x = \frac{l}{2})$  results from both the initial imperfection  $e_0$  and flexural bending deflection  $w$  due to the normal force and reads

$$w_{ges} = w + e_0 = e_0 \cdot \frac{l}{l - \frac{N_E}{N_{cr}}} \quad (7-21)$$

for which  $N_{cr}$  is the Euler buckling force

$$N_{cr} = \frac{\pi^2 \cdot EI}{l_k^2} \quad (7-22)$$

The stress equation according to 2<sup>nd</sup> order theory using the magnification factor

$$\frac{I}{I - \frac{N_E}{N_{cr}}} \quad (7-23)$$

reads as follows:

$$\sigma = -\frac{N_E}{A} \pm \frac{N_E \cdot e_0}{W} \cdot \frac{I}{I - \frac{N_E}{N_{cr}}} \quad (7-24)$$

If the values of the imperfection  $e_0$  and the permissible stress  $f_u$  are known, the buckling stability can be assessed by equation (7-26) and (7-27) in the form of a stress verification. However, as the magnitude of the compressive strength of glass differs from that of the tensile strength, the verification of buckling resistance must fulfil both a compression and a tension check:

$$\sigma_t = -\frac{N_E}{A} + \frac{N_E \cdot e_0}{W} \cdot \frac{I}{I - \frac{N_E}{N_{cr}}} \leq f_{u,t} \quad \text{and} \quad f_{u,t} = \begin{cases} 70 \frac{N}{\text{mm}^2} & \text{for HSG} \\ 120 \frac{N}{\text{mm}^2} & \text{for TTG} \end{cases} \quad (7-25)$$

$$\sigma_c = -\frac{N_E}{A} - \frac{N_E \cdot e_0}{W} \cdot \frac{I}{I - \frac{N_E}{N_{cr}}} \leq f_{u,c} \quad \text{and e.g. } f_{u,c} = -500 \frac{N}{\text{mm}^2} \quad (7-26)$$

In view of a consistent verification format, which avoids the double check for both the compression and tensile case, buckling curves are to be proposed for monolithic pane-like glass columns, which are independent of the glass strength but are able to separate the range of the compressive strength from that of the tensile strength. The background for this purpose are buckling curves in the intended established European format

$$\chi_t = \frac{N_u(\bar{\lambda}_t)}{A \cdot f_{u,t}} \quad (7-27)$$

which depends on the non-dimensional slenderness

$$\bar{\lambda}_t = \sqrt{\frac{A \cdot f_{u,t}}{N_{cr}}} \quad (7-28)$$

Reference value of the strength shall be the standardized tensile strength  $f_{u,t}$  (index “t” at  $f_{u,t}$ ,  $\bar{\lambda}_t$  and  $\chi_t$ ). The stress equation (7-26) then reads using the variables  $\bar{\lambda}_t$  and  $\chi_t$ :

$$0 = -\chi_t + \chi_t^2 \cdot \bar{\lambda}_t^2 + \chi_t \cdot \eta - 1 + \chi_t \cdot \bar{\lambda}_t^2 \quad (7-29)$$

$$\text{and } \eta = \frac{e_0 \cdot A}{W} \quad (7-30)$$

Implementing a parameter  $e_0(\bar{\lambda}_t)$  considering the effect of the geometric imperfection of the glass member

$$e_0(\bar{\lambda}_t) = \alpha \cdot \bar{\lambda}_t \cdot \frac{W}{A} \quad (7-31)$$

equation (7-30) can be written in the *Ayrton-Perry*-format:

$$(1 + \chi_t) \cdot (1 - \chi_t \cdot \bar{\lambda}_t^2) = \chi \cdot \alpha \cdot \bar{\lambda}_t \quad (7-32)$$

The solution of equation (7-33) is the function of the buckling curves  $\chi_t(\bar{\lambda}_t)$  for that range of slenderness, in which tensile failure is decisive

$$\chi_t = \frac{I}{\phi_t + \sqrt{\phi_t^2 + \bar{\lambda}_t^2}} \quad (7-33)$$

with

$$\phi_t = \frac{I}{2} \cdot (-1 + \alpha \cdot \bar{\lambda}_t + \bar{\lambda}_t^2) \quad (7-34)$$

Analogously, but with different sign, equation (7-27) describes that range of slenderness, in which the compression failure is decisive

$$\chi_c = \frac{n_f}{\phi_c + \sqrt{\phi_c^2 - n_f \cdot \bar{\lambda}_t^2}} \quad (7-35)$$

$$\text{with } n_f = \left| \frac{f_{u,c}}{f_{u,t}} \right| = \begin{cases} 7,14 \text{ for HSG} \\ 4,17 \text{ for TTG} \end{cases}; \quad \chi_c = \frac{N_u(\bar{\lambda}_t)}{A \cdot f_{u,t}} \quad (7-36)$$

$$\text{and } \phi_c = \frac{I}{2} \cdot (1 + \alpha \cdot \bar{\lambda}_t + n_f \cdot \bar{\lambda}_t^2) \quad (7-37)$$

The variable  $\alpha$  results from the equation (7-32) and can be written as:

$$\alpha = \frac{e_0 \cdot A}{W \cdot \bar{\lambda}_t} = \frac{e_0}{l} \cdot \sqrt{3} \cdot \pi \cdot \sqrt{\frac{E}{f_{u,t}}} \quad (7-38)$$

Using an effective imperfection value e.g.  $e_0 = L/400$  (this effective imperfection was verified in [225][227][229] for buckling test with centric normal force), so  $\alpha^{HSG} = 0.430$  and  $\alpha^{TTG} = 0.329$  yield from equation (7-38).

As a result Figure 7-18 shows the so derived buckling curves with non-dimensional slenderness relating to tensile strength for heat strengthened and toughened safety glass. Thereby the range, in which the failure due to reaching the compressive strength or due to reaching the tensile strength is decisive, is visible.

The intersection point of the buckling curves  $\chi_t(\bar{\lambda}_t)$  with  $\chi_t = 1.0$  can be considered as a horizontal curve shift like the European buckling curves for steel columns [230] incorporate. For attaining a formal compatibility with the European buckling curves the buckling curves for glass columns can be written:

$$\chi_t^* = \frac{I}{\phi^* + \sqrt{\phi^{*2} - \bar{\lambda}_t^2}} \quad \text{with } \bar{\lambda}_t \geq \begin{cases} 0.89 (= \bar{\lambda}_{t,0}) \text{ for HSG} \\ 0.92 (= \bar{\lambda}_{t,0}) \text{ for TTG} \end{cases} \quad (7-39)$$

$$\text{and } \phi^* = \frac{I}{2} \cdot (1 + \alpha \cdot (\bar{\lambda}_t - \bar{\lambda}_{t,0}) + \bar{\lambda}_t^2) \quad (7-40)$$

$$\text{and } \chi_t^* = 1,0 \quad \text{with } \bar{\lambda}_t < \begin{cases} 0.89 (= \bar{\lambda}_{t,0}) \text{ for HSG} \\ 0.92 (= \bar{\lambda}_{t,0}) \text{ for TTG} \end{cases} \quad (7-41)$$

Equation (7-40):  $\chi_t^* = f(\bar{\lambda}_t, \bar{\lambda}_{t,0})$  and equation (7-41):  $\phi^* = f(\bar{\lambda}_t, \bar{\lambda}_{t,0})$  are not identical with the equation (7-34):  $\chi_t = f(\bar{\lambda}_t)$  or the equation (7-35):  $\phi_t = f(\bar{\lambda}_t)$  respectively. Two buckling curves depending on the respective glass strength are remaining. Therefore, in order to avoid different buckling curves for heat strengthened and toughened safety glass the value for  $\alpha$  has to be equalized. For this purposes the  $\alpha$ -value for heat strengthened glass should be selected also for the toughened safety glass:  $\alpha^{HSG} = \alpha^{TTG, new} = 0.430$ . In this case the effective imperfections are  $e_0^{HSG} = l/400$  and  $e_0^{TTG} = l/306 \cong l/300$  [188]. Thus the proposal for consistent buckling curves in the European form reads (Figure 7-19) assuming for both glass qualities  $l/300$  on the safe side.

$$\chi = \frac{l}{\phi + \sqrt{\phi^2 - \bar{\lambda}_t^2}} \quad (7-42)$$

$$\phi = \frac{l}{2} \cdot (1 + \alpha \cdot (\bar{\lambda}_t - \bar{\lambda}_{t,0}) + \bar{\lambda}_t^2); \quad \bar{\lambda}_{t,0} = 0.89; \quad \alpha = 0.43; \quad \chi(\bar{\lambda}_t < 0.89) = 1.0. \quad (7-43)$$

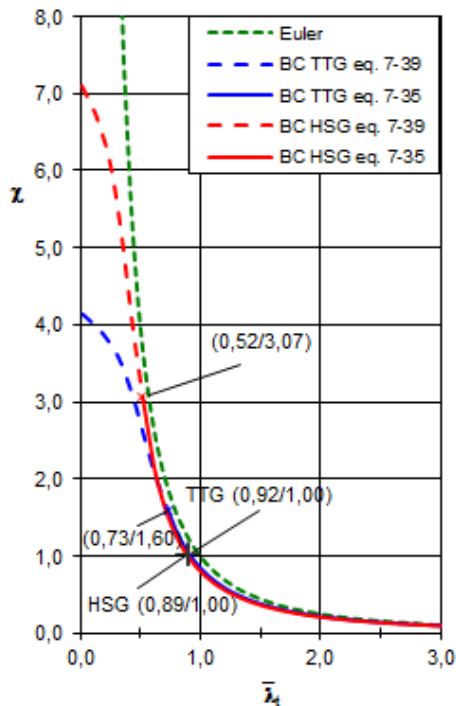


Figure 7-18 Buckling curves for monolithic glass columns: thermally toughened and heat strengthened glass

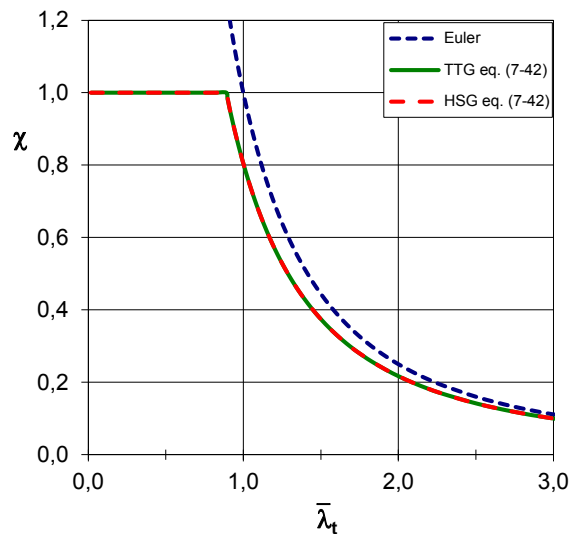


Figure 7-19 Consistent buckling curves for monolithic glass panes with heat strengthened and thermally toughened glass sections

### 7.4.3 Experimental tests of monolithic glass columns

In a research project analytic buckling curves have been verified by experimental tests on monolithic pane-like glass columns. The glass columns were simply supported at its ends according to Euler's case II. The experimental set-up for buckling and in particular the design of the bearings is according to [225], Figure 7-20. For those hinged bearings at the ends of the glass panes shaft constructions that fit to the groove inside of the bearing roller was provided. In each of the grooves the glass pane was put on a 6 mm block of aluminium and

was fastened using adjusting screws, by which a steel mounting plate with an interlayer of *Klingsil* C4500 was pressed against the glass surface.

The proof load then was applied by a hydraulic jack fixed on the upper bearing and was measured by a load cell. Further the lateral deformation in the middle of the glass pane was measured by a displacement transducer. The full description of the project can be found in [229].

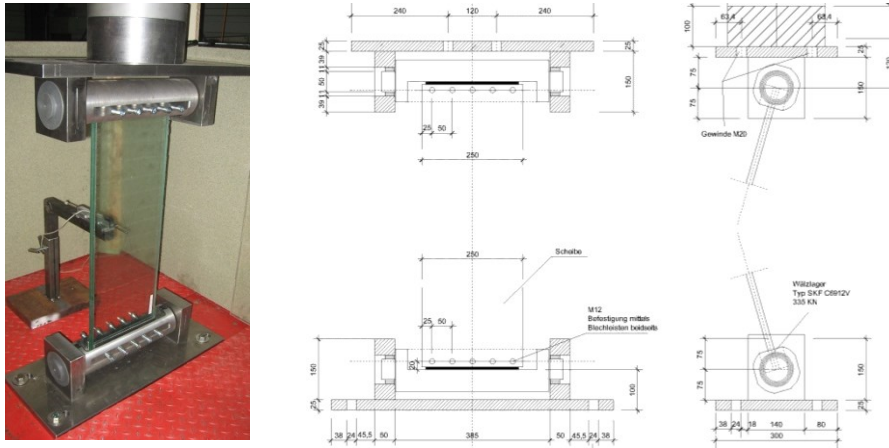


Figure 7-20 Experimental set-up for buckling of glass-panes according to [225]

Buckling tests are to be evaluated with the measured, real section dimensions and length. The effective imperfection  $e_0$  (which include all imperfections from the installation the glass columns in the set-up and from the set-up itself) was determined by the so-called “Southwell Plots” [226] [229] and was considered within the numerical and analytical calculations.

The experimental force-displacement-curves and force-stress-curves should be compared to the analytical and numerical calculation, see examples in Figure 7-21.

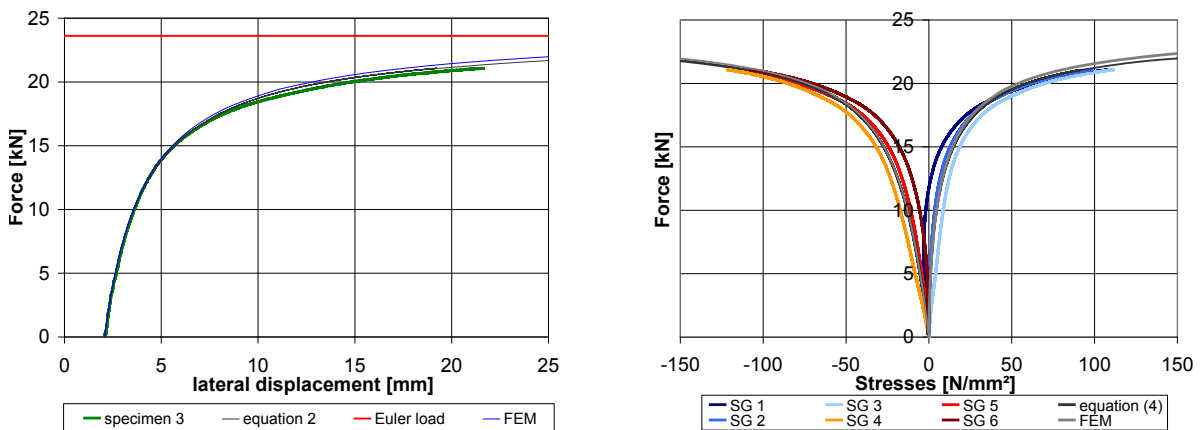


Figure 7-21 Example: experimental force-displacement-curve (left) and force-stress-curve (right) for the test specimen No. 3 including the analytical and numerical calculations [229]

Figure 7-22 illustrates the comparison of some buckling tests [229] being centrally loaded as well as all buckling tests being eccentrically loaded. The force-displacement-curves of equal section dimensions and lengths agree each to another except specimen no. 10 and 4.

It is also well visible that the buckling failure occurs on a lower load level in case of columns of heat strengthened glass than in case of columns of toughened safety glass.

Specimen no. 5 with regular eccentricity showed a premature collapse, Figure 7-22. The reason for this traces back to the fact that the glass pane showed defects or flaws in the area of the edges. Therefore the results of specimen no. 5 were ignored in the further evaluations.

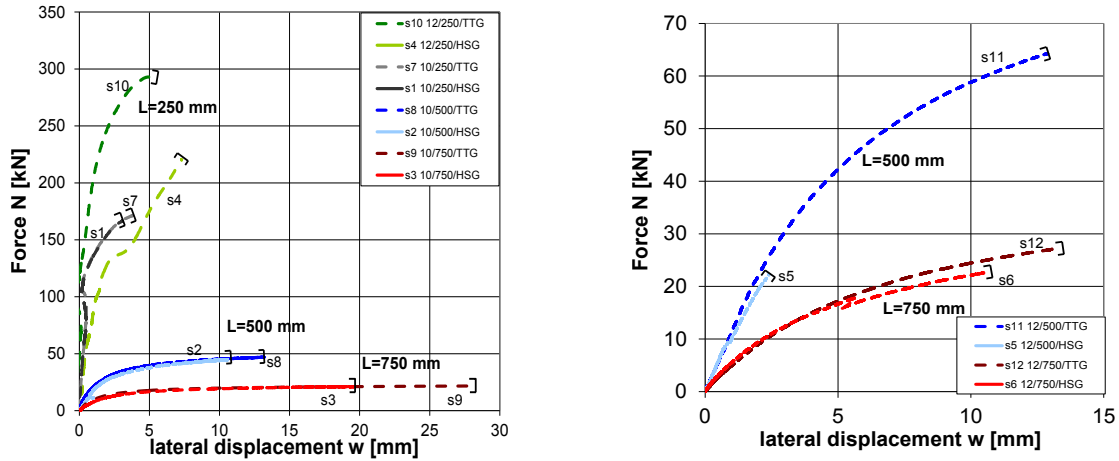


Figure 7-22 Load-Deformation behaviour of buckling tests at glass panes with monolithic section with centric normal force (left) as well as with normal force and eccentricity  $e_p = 3.0$  (right)

Figure 7-23 shows the comparison of all results of specimen without eccentricity to the proposal according to equation (7-36) considering different  $\alpha$ -values as well as to the consistent buckling curves according to equation (7-43) considering uniform  $\alpha$ -values.

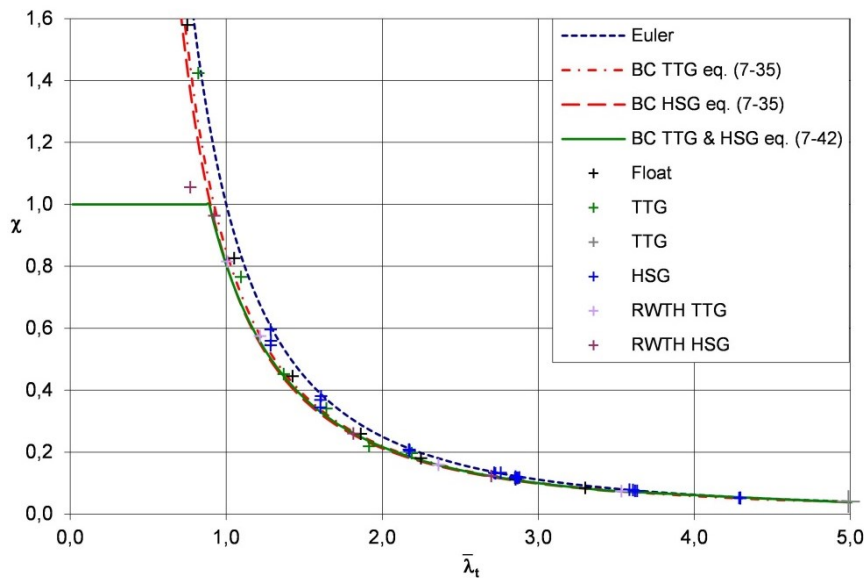


Figure 7-23 Comparison of the analytic buckling curves for monolithic glass columns to experimental test results without regular eccentricity

Moreover, Figure 7-24 presents the comparison of all experimental buckling results having a regular eccentricity  $e_p$  (the eccentricity was intentionally provided to study the effect of installation tolerances) to equation (7-36) including an effective imperfection  $e_0^{HSG} = L / 400 + e_p$  for



heat strengthened glass respectively  $e_0^{TTG} = L/300 + e_p$  for toughened safety glass. A value representing an installation tolerance is useful and should be considered in the design calculations. The value for this may be (as proposed here)  $e_p = 3.0 \text{ mm}$  being aware that this value need not to be in conformity to any tolerance standards.

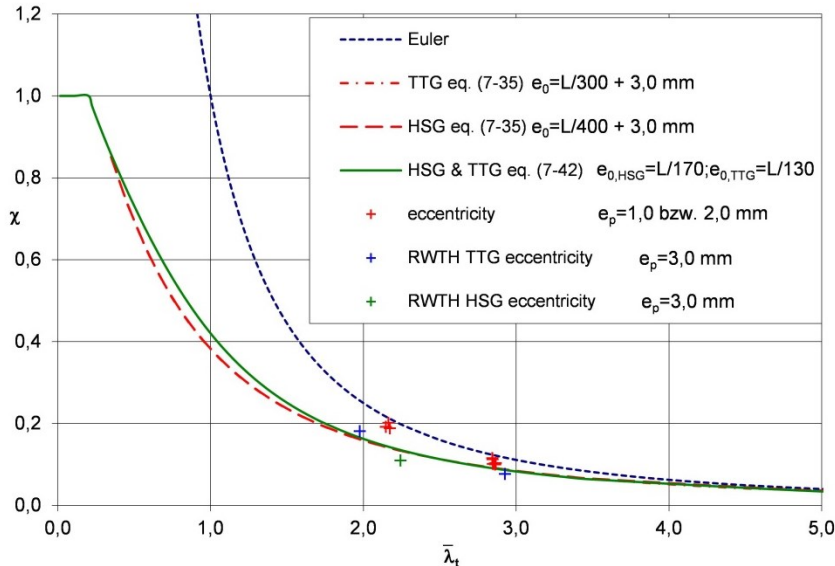


Figure 7-24 Comparison of the analytic buckling curves for monolithic glass columns to the experimental test results with eccentricity  $e_p$

If the effective imperfections  $e_0^{HSG} = L/400 + e_p$  or  $e_0^{TTG} = L/300 + e_p$  respectively is implemented in equation (7-36), according to equation (7-43) the common variables  $\alpha_{HSG} = \alpha_{TTG} = 1,0$  and  $\bar{\lambda}_{t,0} = 0,2$  can be determined whilst meeting the format of the European buckling curves. The effective imperfections then can be adjusted in a way so that the values of  $\chi(\bar{\lambda})$  consider  $e_0^{HSG} = L/400 + e_p \cong L/170$  and  $e_0^{TTG} = L/300 + e_p \cong L/130$  respectively. For the determination of the partial safety factors  $\gamma_M$  the corresponding effective imperfections are also taken into an account.

The partial safety factor  $\gamma_M$  was evaluated according to EN 1990 annex D considering 75% confidence probability and a 5% fractile for the characteristic value or rather a 0.1 % fractile for the design value taking into account of real geometries and strengths. Resulting  $\gamma_M$  - values were between 1.28 and 1.49. However they will be smaller when more tests will be available (limited number of buckling test at time being).

#### 7.4.4 Buckling of columns with laminated sections

Using laminates as glass columns with axial loading normally the slip at the load introduction point may be hindered. However in the following, on the safe side, a free slip displacement of one glass layer to another at the load introduction point shall be assumed (Figure 7-25).

The solution by using the slip differential equation is given in chapter 5.5 and 5.6 (loading 4, see Table 5-5).

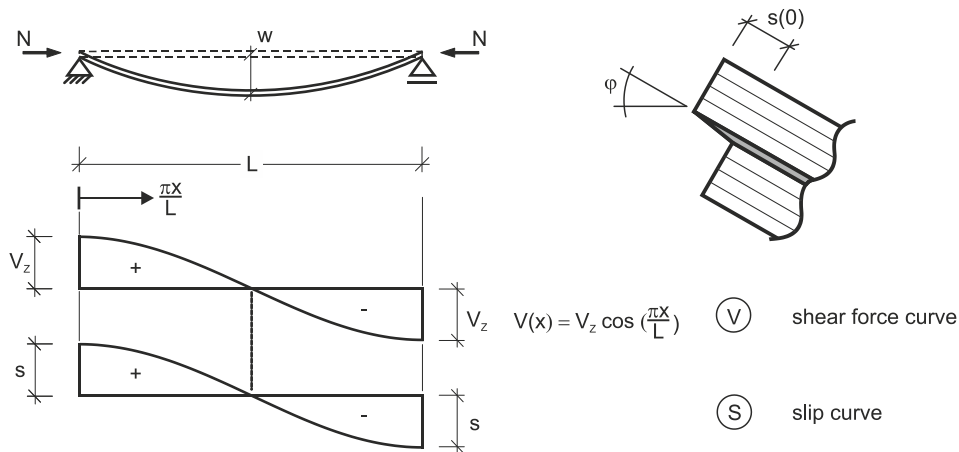


Figure 7-25 Buckling member with shear force curve  $V_z$  and slip curve [232] [233]

With the solution for “loading 4” in Table 5-5 the partial stress equations of every glass layer can be determined

$$\sigma_i(x) = \pm \frac{F(x)}{A_i} \pm \frac{M_i(x)}{W_i} \quad (7-44)$$

$$\sigma_i(x) = \frac{V_z}{B \cdot d_i^2} \cdot \left( \frac{L}{\pi} \right) \sin\left( \frac{\pi x}{L} \right) \left[ \pm d_i \cdot m \pm \frac{6I_i}{\sum I_i} (1 - \psi_s \cdot m) \right]. \quad (7-45)$$

The total deflection  $w_{total}(x)$  of the laminate can be written as

$$w_{total}(x) = - \int_0^x \int_0^x \frac{M_i(x)}{EI_i} dx dx = \frac{V_z}{E \sum I_i} \cdot \left( \frac{L}{\pi} \right)^3 \sin\left( \frac{\pi x}{L} \right) [1 - m \cdot \psi_s] \quad (7-46)$$

With the total deflection and the total moment of the laminated glass the Euler buckling force is

$$N_{crit} = \frac{M(x)}{w_{total}(x)} = \frac{V_z \cdot \frac{L}{\pi} \sin\left( \frac{\pi x}{L} \right)}{\frac{V_z \cdot L^3}{E \pi^3 \sum I_i} [1 - \psi_s \cdot m] \sin\left( \frac{\pi x}{L} \right)} = \frac{\pi^2 E \cdot I_{eff}}{L^2} \quad (7-47)$$

so that the effective moment of inertia reads (equalling the results of [234] [240]):

$$I_{eff} = \frac{\sum I_i}{1 - \frac{K_s \cdot \beta_s \cdot \psi_s}{\left( \frac{\pi}{L} \right)^2 + \alpha_s^2}} = \frac{\sum I_i}{1 - \psi_s \cdot m} \quad (7-48)$$

The here presented derivations will be now transferred to the buckling case of laminated glass columns, so that the stress equation reads

$$\sigma(x) = \frac{N}{\sum A_i} \pm \frac{N \cdot e_o}{W_{i,eff}} \frac{1}{1 - \frac{N}{N_{crit}(I_{eff})}} \sin\left( \frac{\pi x}{L} \right) \quad (7-49)$$

for which the lateral deformation for laminated glass under axial load is

$$w(x) = \frac{e_0}{N} \frac{N}{N_{crit}(I_{eff})} \sin\left(\frac{\pi x}{L}\right) \quad (7-50)$$

The analytical equations have been verified by experimental tests on laminated glass columns. The glass columns were simply supported at its ends according to Euler's case II. The experimental set-up for buckling and in particular the design of the bearings is similar to [229], see Figure 7-20. The load was applied centric by a hydraulic jack fixed on the upper bearing and was measured by a load cell. Further the lateral deformation in the middle of the glass pane was measured by a displacement transducer [231] [233].

Specimens of double and triple laminated glass columns were tested in flexural buckling under consideration of the time- and temperature- dependent material properties. In the following the flexural buckling tests of triple laminates are presented. The dimensions of the specimen were 250 mm x 750 mm and the sectional properties were 6/10/6 mm or 5/10/5 mm of tempered glass. The tests were performed force controlled (18 kN/s, 35 kN/h) as well as displacement controlled (1 mm/s and 2.5 mm/h) in each case at a slow and fast loading rate. The temperature corresponds to room temperature about 23°C. The specimens were loaded to failure. It could be observed, that by many tests only the middle glass pane was broken and the outside glass panes were intact. Moreover in a few cases, failure was induced by delamination.

Figure 7-26, left, illustrates the experimental results of buckling tests on triple laminates with 5/10/5 mm of tempered glass. The force-displacement-curves show clearly the influence of the loading rate on the bearing behaviour of laminated glass columns. The tests with the fast loading rate have higher carrying capacity as the slow loading tests. Moreover it is visible, that the curves of force controlled tests continuous increases whereas the curves of displacement controlled tests, after reaching the maximum, drops down.

Figure 7-26, right, shows the comparison of two buckling tests to analytical calculations. It is clear, that analytical predictions come to a good agreement with the experiments when considering of using a constant value for the shear modulus  $G_F$ .

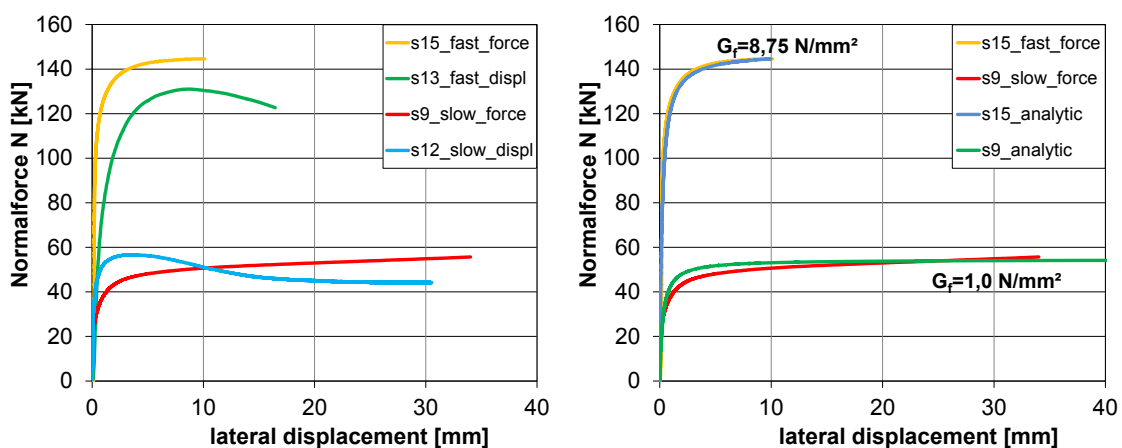


Figure 7-26 Load-Deformation behaviour of buckling tests using the example of specimens with 5 / 10 / 5 mm tempered glass and different loading rates (left) and comparison to analytical calculations

Laminated glass for columns requires knowledge on its stability behaviour, and furthermore, it requires analytical equations for the stability verification. In this context stress and deflec-

tion equations for double and symmetric triple laminates based on the slip differential function were derived ((7-48), (7-49) and (7-50)), in which the shear modulus  $G_F$  of the interlayer can be implemented.

The results provide a basis for the consideration of the composite action for the design of laminated glass structures under axial loading.

#### 7.4.5 Critical load of laminated bars under axial loads with blocked end slip

A beam in buckling with pinned ends consisting of a laminate with blocked slip between the layers at the ends is shown in Figure 7-27. For the first instance (case A) no shear transmission between the layers along the axis is assumed. The critical load of the beam and its corresponding buckling length respectively the effective bending inertia is needed. For this configuration the conditions at the end points are of special interest. Conversely to laminated beams with free end slip at the end points inner moments  $M_i$  and normal forces in the layers  $F_i$  occur. E.g. for symmetrical two layered laminate the relationship  $-2M_i = F_i \cdot t$  exists (note that in previous considerations the thickness was denominated as “ $d$ ” instead of “ $t$ ”). Effectively the end slip restraint leads to an increase of the critical buckling load and therefore also to an increase of the ultimate axial force.

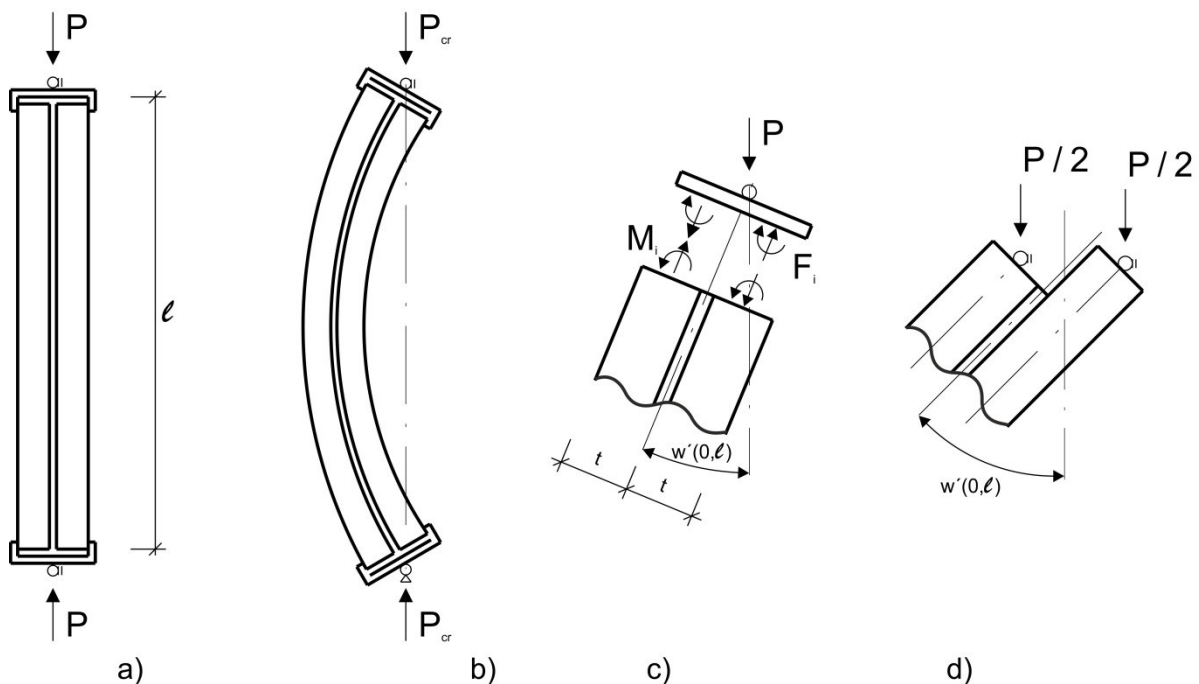


Figure 7-27 Laminated buckling beam, a) to c) with restraint slip at the ends, d) with free end slip

For the determination of the buckling load the end slip restraint shall be modelled by an equivalent torsional spring. For this a half of the symmetric system can be considered as a very slender frame, the restraint effect of the head plate (=rail or beam of the frame) on top can be substituted by an equivalent torsional spring. As a very important point, thereby the elongation respectively the shortening of the layers (columns of the frame) have to be taken into account, otherwise no correct buckling shape can be found. The reason lies in the very high slenderness of the regarded structure. Figure 7-28 shows the situation.

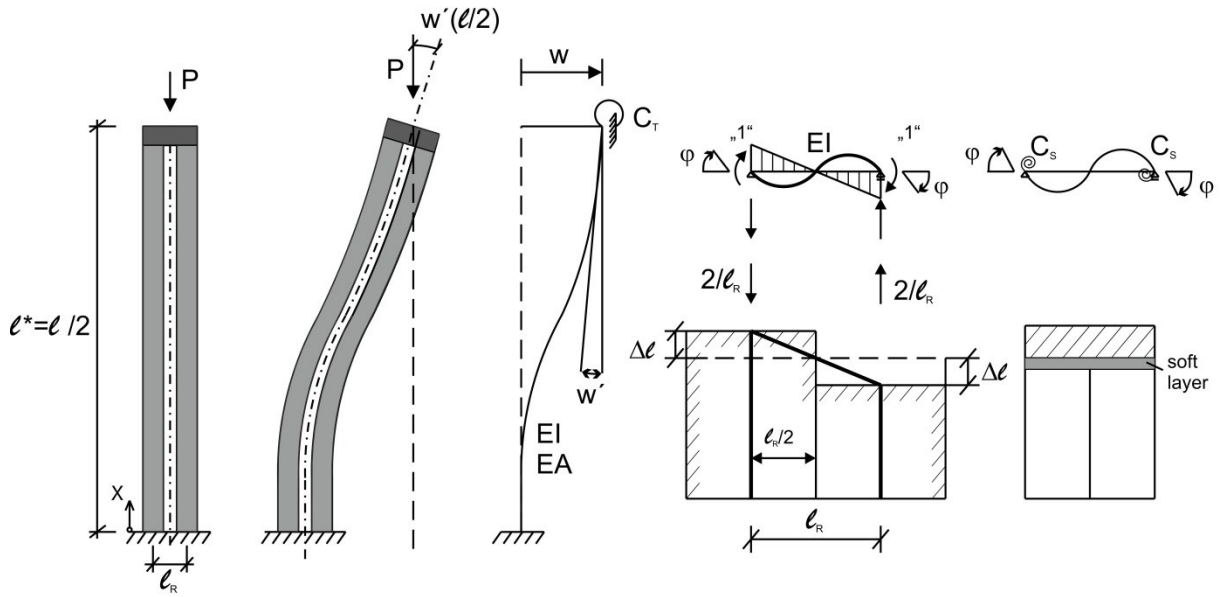


Figure 7-28 Half system: buckling shape and substitution of the top restraint by an equivalent torsional spring, taking into account of the longitudinal elongation/compression of the glass-layers

By applying a virtual moment of the magnitude “1” at the isolated top plate the corresponding rotation angle at the ends of the plate can be expressed as

$$\varphi = \frac{1 \cdot \ell_R}{6 EI_R} + \frac{\Delta \ell}{\ell_{R/2}} \quad \text{and} \quad \Delta \ell = \frac{2}{\ell_R} \cdot \frac{\ell^*}{EA} \quad \text{so that} \quad (7-51)$$

$$\varphi = \frac{\ell_R}{6 EI_R} + \frac{4 \Delta \ell^*}{\ell_R^2 EA} = \frac{\ell_R}{6 EI_R} \left[ 1 + \frac{24 I_R \ell^*}{\ell_R^2 A} \right] \quad (7-52)$$

For a soft layer between the head plate and the glass, this can be described with an additional spring  $C_S$ . The rotation under unit moment then is

$$\varphi = \frac{\ell_R}{6 EI_R} \left[ 1 + \frac{24 I_R \ell^*}{\ell_R^3 A} \right] + \frac{1}{C_S} \quad (7-53)$$

As it is:  $C_T = I/\varphi$  the torsional spring  $C_T$  reads

$$C_T = \frac{6 EI_R}{\ell_R} - \frac{I}{1 + \frac{24 I_R \ell^*}{A \cdot \ell_R^2}} \quad \text{or} \quad C_T = \frac{I}{\frac{1}{C_S} + \frac{\ell_R}{6 EI_R} \left[ 1 + \frac{24 I_R \ell^*}{\ell_R^2 A} \right]} \quad (7-54)$$

For  $I_R \rightarrow \infty$ ,  $C_S \rightarrow \infty$  the torsional stiffness is according to the rule of l'Hôpital:

$$C_T(I_R \rightarrow \infty, C_S \rightarrow \infty) = \frac{EA \ell_R^2}{4 \ell^*} \quad (7-55)$$



where  $\beta_s$  and  $\alpha_s$  are cross-sectional parameter, see the previous chapters. From the derivation of the differential equation of slip the occurring Moment at the head plate  $M$  can be calculated:

$$M = V \frac{\ell}{\pi} \sin \frac{\pi \cdot x}{\ell} = (V_1 + \Delta V) \frac{\ell_2}{\pi} \sin \frac{\pi \cdot \ell_2}{\ell_2} \quad (7-58)$$

Using the elastic torsional spring stiffness  $C_T = M / \phi$  and  $\Delta V = \phi \cdot P$

$$\Delta V = (V_1 + \phi P) \cdot \frac{\ell_2}{\pi} \cdot \frac{P}{C_T} = \frac{V_1 \ell_2 P}{\pi C_T - P \ell_2} \quad (7-59)$$

can be obtained. With the equation above, recalling that  $P = P_{cr}(\ell_1)$

$$\frac{\left(\frac{\pi}{\ell_2}\right)^2 + \alpha_s^2}{\left(\frac{\pi}{\ell_1}\right)^2 + \alpha_s^2} - \frac{I}{I - \frac{\pi C_T}{P_{cr}(\ell_1) \ell_2}} = 0 \quad (7-60)$$

the partition of  $\ell_1$  and  $\ell_2$  has been derived.

As

$$P_{cr} = \frac{E \sum I_i}{I - \frac{\ell_R \cdot K \cdot \beta_s}{\left(\frac{\pi}{\ell_1}\right)^2 + \alpha_s^2}} \cdot \frac{I}{\ell_1^2} \quad \text{and} \quad \ell_1 = \ell^* - \ell_2 \quad (7-61)$$

a closed solution of  $\ell_1$  is rather complex, thus a determination of how the proportion of  $\ell_1$  to  $\ell^*$  is, this can easily be done by trial and error. Further, by using the rule of de l'Hôpital some special values can be obtained:

1)  $I_R = \infty$  and  $K = \infty$

$$I - \frac{I}{I - \frac{\pi \cdot C_{T,f}}{P_{cr,full}} \cdot \frac{I}{\ell_2}} = I \rightarrow \ell_1 = \ell^*, \ell_2 = 0 \quad (7-62)$$

2)  $I_R = 0$  and  $K = 0$

$$I - \frac{I}{I - \frac{\pi \cdot C_T}{P_{cr,single}} \cdot \frac{I}{\ell_2}} = I \rightarrow \ell_1 = \ell^*, \ell_2 = 0 \quad (7-63)$$

3)  $I_R = \infty$  and  $K = 0$ ; 2-layered:  $t = \ell_R$  (7-64)

$$C_T = \frac{EA \ell_R^2}{4\ell^*}; \quad I = 2 I_1; \quad P_{cr} = \frac{2EI_1\pi^2}{\ell_1^2}; \quad \alpha_s = 0$$

$$\left(\frac{\ell_1}{\ell_2}\right)^2 - \frac{I}{I - \frac{3\ell_1^2}{2\ell_2\ell^*\pi}} \rightarrow \ell_1 = 0,65 \ell^*, \ell_2 = 0,35 \ell^*$$

This solution is in agreement with the solution given in [237] where  $\ell_1 = 0,64 \ell^*$  and  $\ell_2 = 0,36 \ell^*$ .

It comes that the critical load does not change a lot whilst increasing the interlayer stiffness by factors of 10. The reason lies in the increasing buckling length, parallel to the shear stiffness increases. That means that the blocked slip at the end by the head plate is the predominant factor and also, that the time dependent viscoelastic effect of interlayers will not play that much important role as it does for buckling bars with free end –slip.

Finally it needs to be mentioned that all further verifications can be done as for buckling bars with free end slip with  $\ell_B = \beta \cdot \ell$  if the buckling factor is derived.

#### 7.4.6 Interaction of axial loads with bending moments

Suggestions for the consideration of axial loads with bending moments for columns are given e.g. in [239].

#### 7.4.7 Consideration of short term – long term loading effects on the stability

Thoughts to this point are given in e.g. [238].

#### 7.4.8 Conclusions

On the basis of the second order theory, buckling curves for glass columns are derived from the stress equation, which could be transferred into the format of European buckling curves for steel components. The comparison of the proposed analytic buckling curves to experimental buckling tests as well as to the numerical calculations shows a good prediction of the proposed buckling curves. For the effective imperfections the following values are proposed:

- $e_0 = L/400$  for heat strengthened glass and
- $e_0 = L/300$  for thermally toughened glass.

However, in practice, installation tolerances have always to be considered. These have conservatively been estimated by a value of 3.0 mm for glass columns with a thickness of 12 mm. Considering this, effective imperfection values of  $e_0^{HSG} = L/400 + 3.0 \text{ mm}$  or  $e_0^{TTG} = L/300 + 3.0 \text{ mm}$  respectively come out. By this the basis for the implementation of buckling curves as proposed in technical rules or codes are laid down.

Up to now the research work has led to results on the consideration of improved buckling lengths, the interaction of axial loads with bending and the non-linear effect of the load duration of different loading types. However further investigations on load introduction, long term behaviour etc. are necessary.



## Eurocode Outlook No. 38

- (1) *Instead of using a full non-linear analysis the stability assessment of glass columns can be performed by buckling curves.*
- (2) *The imperfection assumptions of the buckling curves should coincide with the imperfections that are used for the alternative non-linear analysis.*
- (3) *The imperfection assumptions for columns for glass consist of two elements comprising*
  - a. *The geometrical and inherent structural imperfection that can be measured by experiments may be according to the Southwell-procedure. These imperfections can be regarded as proportional to the length and so far can be assumed to  $L/400$  for HSG and  $L/300$  for TTG respectively in sinoidal shape along the axis.*
  - b. *Unlike to other materials, due to the slenderness of glass panels additionally erecting tolerances may appear in reality. However whereas in the experiments those tolerances are often avoided. In practice they should be assumed to be a constant value of 3.0 mm along the axis.*
- (4) *Reliable interlayer shear stiffness values in dependence on time and temperature can be taken into account.*
- (5) *If possible the occurring end slip of the laminate should be prevented by constructive measures (end plate bonded with epoxy resin). Otherwise the occurring end-slip should be assessed.*
- (6) *In case of blocked end slip the corresponding buckling length can be modified.*
- (7) *The non-linear effect of different load duration on the buckling strength should be taken into account unless the laminate is calculated without composite effect.*
- (8) *The non-linear interaction of axial loads with bending moments has to be considered.*
- (9) *The failure load prediction model should be carried according the European format and calibrated such that  $\gamma_{M_2}$  can be applied.*
- (10) *Eurocode should give examples for best practice design of the load introduction points.*

## 7.5 Beam-columns

The consideration for the buckling behaviour of beams, columns and shear panels can be enlarged for combined loading, e.g. beam-columns.

## 7.6 Hybrid structures and hybrid glass components with enhanced pre- and post-failure performance

Hybrid glass components offer enhanced pre- and post-failure performance. In general, a hybrid glass component is composed of glass – as the main load-carrying material – and an additive material (e.g. steel, timber, GFRP or CFRP) which is adhesively bonded to the glass or fixed mechanically without any adhesive or sealing material. This additive material provides extra load-carrying capacity, extra stability or extra redundancy to the glass component. However, hybrid structural component can be designed in way that structural glass share load-bearing capacity with the constituent structural elements made of additive materials, in particular wooden ones. Glass beams can for instance be provided with additional

steel flanges to obtain enhanced load-carrying capacity and extra lateral torsional buckling stability, as studied by e.g. [245][247][254] see Figure 7-30. Furthermore, glass beams can be provided with a steel reinforcement section to obtain enhanced post-breakage performance and extra redundancy, as under investigation by e.g. [186][190], see Figure 7-30 (b) and chapter 6.11. Moreover, hybrid steel-glass or timber-glass shear wall systems can be created to realize hybrid structures with glass as the main stabilizing material, as studied by e.g. [192][204][193][194], see Figure 7-31.

Various hybrid glass component solutions are currently under investigation, mainly in an academic context. However, the number of applications in practice is currently limited and further investigations may be needed. In this respect the adhesive bond between the glass and the additive material and the overall response of the hybrid component is of specific interest.

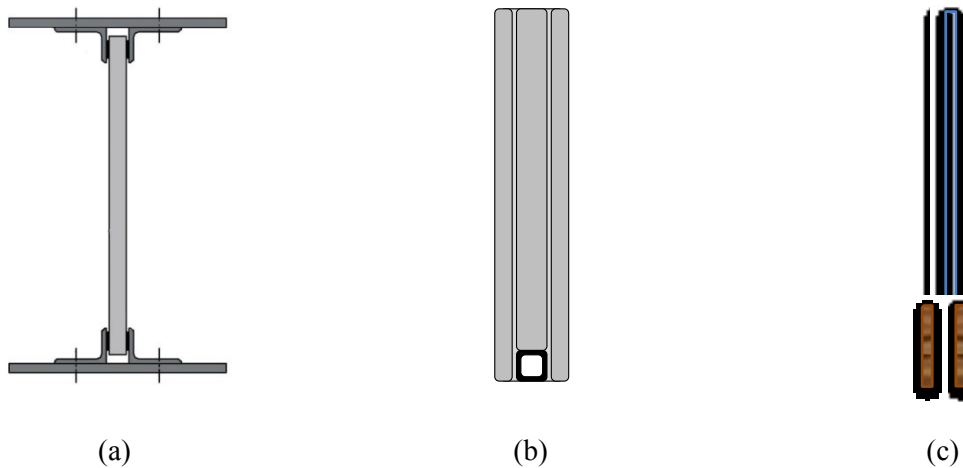


Figure 7-30 Hybrid glass solutions; (a) steel-glass I-section beams [254]; (b) reinforced glass beam [186]; (c) glass-wood friction joint [193]

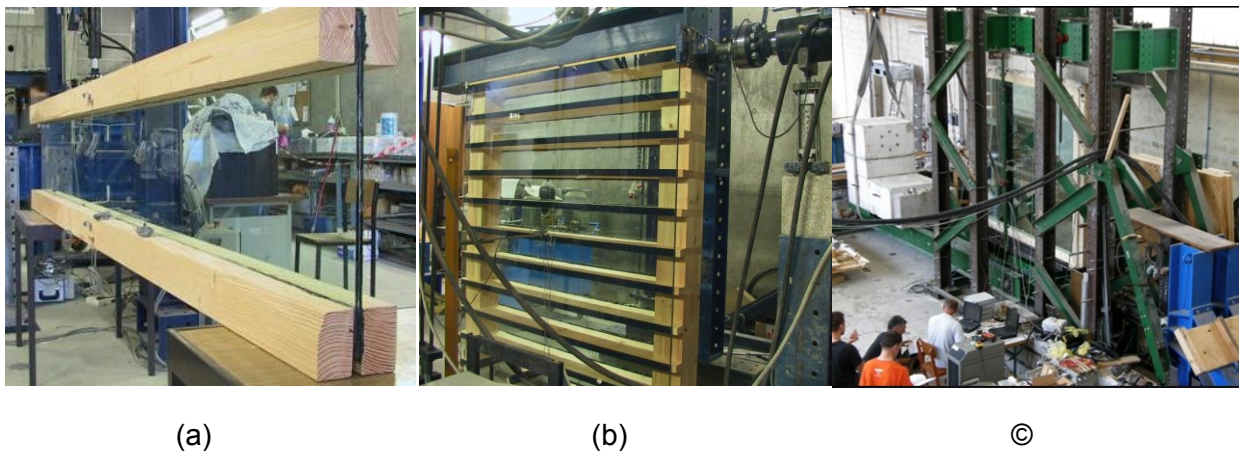


Figure 7-31 Timber-glass composite beams; (a) beams [241]; (b) panels [242]; (c) glass-infilled frame panels [194]

A recent research project [272] considered a façade element as a framed glass pane or – mechanically – as a slab/pane with – laterally connected edge beams.

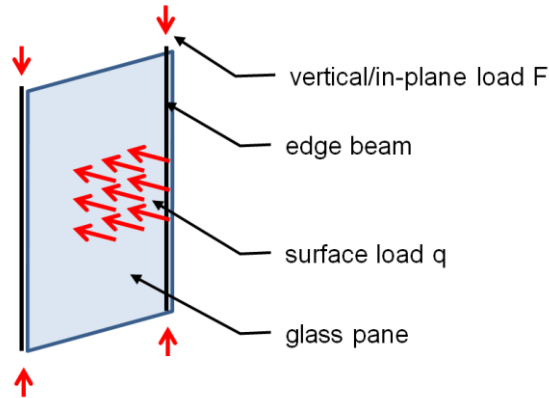


Figure 7-32 Slab/pane with laterally connected edge beams

For such a system different load paths were examined: loading uniformly along the horizontal glass edge, loading on the glass edge concentrated near the corner, loading of the edge beam and combinations of these load paths. It showed that for realistic dimensions of the elements (glass and edge-beam) the load transfer directly through the edge beam is the most effective one, combining the highest load carrying capacity with the stiffest behaviour.

Applying the vertical load directly on the edge beam, the structure can be considered as a laterally loaded compression member, subject to buckling risk. In a parametric study the load deformation behaviour of the vertically and laterally loaded structure was analysed. It showed that taking only the resistance (moment of inertia) of the edge beam itself into account, would be very uneconomic, as the glass pane adds considerable stiffness to the structural behaviour.

Based on these results the effective stiffness of the structure was investigated for various situations and boundary conditions. Interpreting the effective stiffness as a joint stiffness of the edge beam and the glass pane, it can be expressed as

$$EI_{eff} = EI_{EB} + b_{eff}/B \cdot EI_{GP} \quad (7-65)$$

with  $EI_{EB}$  as the bending stiffness of the edge beam,  $b_{eff}$  as the effective width of the glass pane,  $B$  as the total width of the glass pane and  $EI_{GP}$  as the total bending stiffness of the glass pane.

The investigation revealed an interesting result: the aspect ratio  $a$  (width/height) is the only decisive influence factor for the effective width of the glass. All other parameters (e.g. stiffness ratios, pre-load) only have little or no influence. The following graph shows the effective width as a function of the aspect ratio.

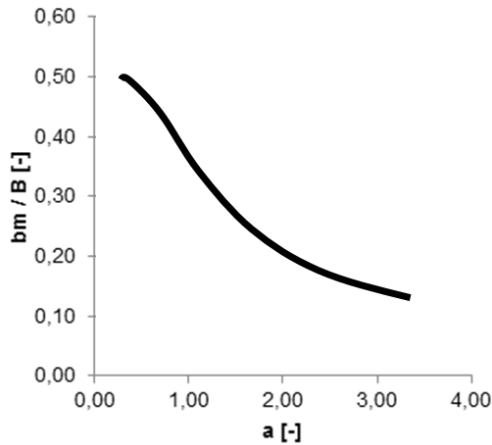


Figure 7-33 Effective width as a function of the aspect ratio

Having determined the initial deformation figure for the lateral load  $q$  with no vertical force applied ( $F=0$ ), the load deformation behaviour of the edge beam – and with that the load deformation behaviour of the structure for the vertical load – can be determined by applying the analogy of a pre-deformed compression member using the analytical solution [237].

$$w = w_0 + w_0 \frac{\varepsilon^2}{\pi^2 + \varepsilon^2} \quad (7-66)$$

with  $w_0$  as the deformation  $w(q)$  at the centre of the edge beam and  $\varepsilon$  as

$$\varepsilon = H \cdot \sqrt{\frac{F}{EI}} \quad (7-67)$$

with  $H$  as member height,  $F$  as vertical load, and  $EI$  as the effective stiffness  $EI_{eff}$  ( $b_{eff}$ ).

By using this formulation, the static calculation can be done according to EC3, taking into account the stiffening effect of the glass pane by using  $EI_{eff}$  instead of  $EI_{EB}$ . Even damaged or partially damaged structures (broken glass layers) can be considered by using a reduced thickness for the determination of  $EI_{GP}$ .

The combination of laminated timber frame and laminated glass presents an innovative approach for achieving improved earthquake resistance of buildings. Timber frame can be easily inserted in any type of structural system and at the same time enables the efficient and safe load transfer from the structural system to the inserted glass panel. To achieve adequate post-fracture behavior of the glass panel, heat strengthened laminated glass is used to provide high load bearing capacity after the potential cracking of the glass during an earthquake or extreme wind action. Panels composed of laminated or cross-laminated timber and laminated glass have a wide range of applications, among which the building refurbishment and earthquake strengthening of frame structures presents only one of the possibilities. They can be used as an integral load-bearing panel in prefabricated timber structures composed both from solid timber panels or frame timber panels and as a shear wall in any kind of structural systems.

The research cooperation of University of Zagreb [195] and University of Ljubljana [196] [197] resulted in development of new type of structural component made of timber frame and laminated glass infill. The initial properties of bare frame, glass panels and glass infilled tim-

ber frame have been experimentally studied, where main tests were carried out in device presented in Figure 7-31 (c). Partners have extended research cooperation to Institute of Earthquake Engineering and Engineering Seismology, IZIS, Skopje, Macedonia [198] where shake table testing of prototype structure have been carried out [199].

A universal shear wall test setup [201] (Figure 7-31 (c)) was developed and installed at Faculty for Civil and Geodetic Engineering of University of Ljubljana in 1999. The main idea of the device was to use a gravity load induced by ballast as a constant vertical load and a displacement controlled hydraulic actuator as a driver of the cyclic horizontal load. The main challenge was to simulate realistic boundary conditions that may occur during the action of an earthquake. In reality, the boundary conditions may change during an earthquake excitation because of changes of the building characteristics due to development of damages. Therefore, the testing device should allow the altering of boundary conditions from one to another test run. Following this idea, the set-up can be easily adapted to various boundary conditions applied to tested panels. Basically, three major cases of boundary conditions are most likely to appear in reality:

- Shear cantilever mechanism, where one edge of the panel is supported by the firm base while the other can freely translate and rotate.
- Shear wall mechanism, where the firm base supports one edge of the panel while the other can translate only in parallel with the lower edge and rotation is fully constrained.
- Restricted rocking mechanism, where one edge of the panel is supported by the firm base while the other can translate and rotate as much as allowed by the ballast that can translate only vertically without rotation.

Test set-up with adaptable boundary conditions enables testing by utilizing different loading protocols, from simple monotonous to more complex cyclic ones. Cyclic testing can be carried out following the protocols EN 12512:2001 [35], ISO 16670:2003 [36] or any other as, for example CUREE protocol [202]. Wooden frames with glass infill were tested monotonously following the protocol of EN 594 and cyclically according to ATC-1994 [203] applying all there above described boundary conditions [200] [201].

For all tested specimens was common that the majority of damage was concentrated in timber frame joints, as they are the weakest part of the hybrid wall. The laminated glass panels remained intact during the entire test. The punched steel plate connector used in one of joints in addition to steel bolt, efficiently limited the propagation of damages and contributed to better response of specimens in comparison to those without steel plates. Test results shows that friction force is playing an important role in sharing resistance to in-plane acting load with frame joints. The considerable amount of energy was dissipated by friction. Hysteretic response of the specimens provided the information on ductility, stiffness degradation and viscous damping.

The whole hybrid shear wall shows considerably robust behavior. Damage propagation in joints up to their local failure does not lead to failure of tested specimen that was able to dissipate the induced energy due to wood-to-glass friction. Moreover, performance of joint detailing can be further improved to achieve higher deformation capacity. Learning from experiments and from the mathematical model that is under development, new series of specimens will be tested. The major improvement of next specimens will be in critical details of frame joints.

The objective of above described racking tests was to obtain data for development of computational model of tested type of structural element that can be used for prediction of inelastic response of buildings made of glass-infilled timber frames on seismic action. To obtain dynamic parameters and study the phenomena of response of this type of structures on seismic action, shaking table tests were carried out [199].

Box-type models were constructed of two glass-infilled timber frames made of simple laminated wood and corner joints fixed by single bolt and punched metal plates. The mass of 9.6 tons was added atop of model. Four types of real earthquake actions were subsequently applied to model: El Centro 1940, N-S, California, USA; Petrovac 1979 Montenegro; Kobe 1995 E-W, Japan, and Friuli 1976 E-W, recorded in Tolmezzo, Italy. The inelastic behavior of model was achieved after application of full scale Kobe earthquake that was applied last in subsequent application of other three full-scale earthquakes. The damages caused by Kobe earthquake were limited to upper joints of frame, but their extent was much lower than in the case of racking load at its ultimate stage.

The performed tests showed clearly the behavior of the glass infilled wooden frames and failure mechanism under strong earthquake motion. It is manifested by slip of the glass along the wooden frame and permanent deformations of the wood, without any damage in the glass. The panels dissipated energy trough sliding of the glass, development of damages in frame corners and activating of the still connectors that anchor frame to r. c. fundaments. The seismic tests proved that the innovative composite panel could be considered as promising structural system, in which the load-bearing structural glass and the wood are working together, conforming to each other in beneficial manner. The dynamic tests results showed very good agreement with the results obtained during the racking tests of the panels.

Regarding design of wood-glass panels as wall diaphragms, all assumptions from EN 1995-1-1 Part 9.2.4.1.(1)–(7) [41] general could be used. The in-plane design shear (racking) strength  $F_{v,Rd}$  against a force  $F_{v,Ed}$  acting at the top of a cantilevered wall that is secured against uplift and sliding by vertical actions and/or anchorage, should be determined using the simplified method for the wall construction defined in EN 1995-1-1; Part 9.2.4.3.1 .

The external forces  $F_{i,c,Ed}$  and  $F_{i,t,Ed}$  (see Figure 7-34) from the horizontal action  $F_{i,v,Ed}$  on wall  $i$  should be determined from EN 1995-1-1 (9.32)

$$F_{i,c,Ed} = F_{i,t,Ed} = \frac{F_{i,v,Ed} h}{b_i} \quad (7-68)$$

where  $h$  is the height of the wall.

These external forces can be transmitted to either the adjacent panel through the vertical panel to panel connection or to the construction above or below the wall. When tensile forces are transmitted to the construction below, the panel should be anchored with stiff fasteners. Compression forces in the vertical members should be checked for buckling in accordance with EN 1995-1-1, (6.3.2.) Where the ends of vertical members bear on horizontal framing members, the compression perpendicular to the grain stresses in the horizontal members should be assessed according to EN 1995-1-1 (6.1.5.)

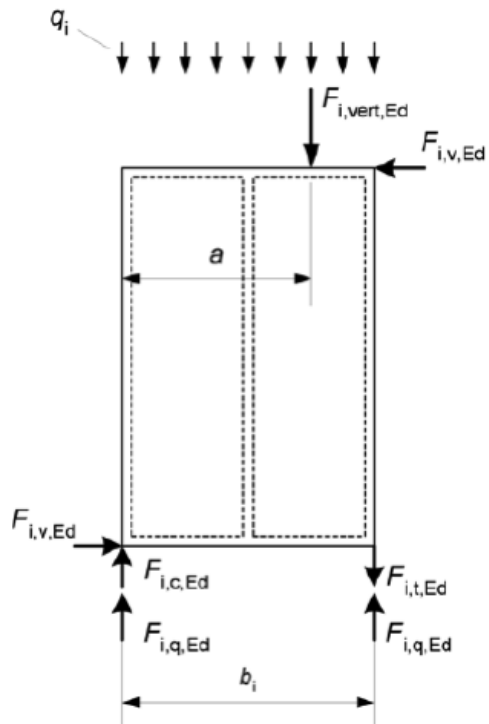


Figure 7-34 Distribution of forces acting on panel due to lateral loading





## 8 Joints and Connections

### 8.1 General

For primary structures, joints are playing an important role for the transfer of the sectional forces from one element to another. The most important jointing techniques are:

- Mechanical transmission of single forces by bolts in drilled holes. The clearance between shank and hole-bearing has to be filled with a well-fitting hard plastic bush or a mortar that eliminates detrimental stress-peaks. Care is needed with mortar selection as a material which is too hard can have detrimental effects if the forces on the bolt are eccentric. Bolted connections can easily be disassembled without damage of the main components of the connection.
- Mechanical transmission of distributed forces by friction joints. Friction joints consist of metal clamping devices and a friction producing interlayer between the metal- and glass-surface. Friction is produced by pre-stressing normal to the planes; therefore, shear forces can be activated. Friction joints can easily be disassembled without destroying the components of the joint.
- Transmission of single, linear and areal distributed forces by adhesive bonding. Adhesive bonding allows a variety of jointing details so that at the same time it acts mechanically and produce tightness in the joint. However they cannot be disassembled without destroying the connection.

By the use of jointing techniques single glass-panes can be assumed such that they form a profile of bending section. In that case the forces are continuously, the inner static state is predominantly non-determined and in case of spot damages at the joints often a sufficiently stress redistribution allows for a robust joint.

Generally to attain sufficient robustness, in advance to the design of a joint, the damage tolerance of the joint and the elements to be jointed together should be clarified.

For point-supported glass panes additionally the bending resistance in the area of the hole edge is also of importance. In national regulations, if there are rules of design of structural glass, mostly only the design of standard secondary elements of glass is specified. For point-supported glass panes, additional local stress occurs.

### 8.2 Bolted connections

In-plane load glass panes are used more and more due to its high mechanical capacity, Figure 8-1, therefore also joints have to be developed that allow for a transmission of high loads. For this bolted connection are very suitable. Therefore the analytic needs to be shown of how a bolt in shear procedures what pressure distribution in the bearing of the hole and further, of what the stress pattern in the glass is. As always, due to the missing stress-redistribution ability of glass, the domain of the elasto-statics cannot be left. This will lead to rather completed equations that in the end need to be simplified.

In the following an analytical model will be proposed and should be understood as a complementary tool to the Finite-Element-Calculation.

Very important is that basically the prediction of the real stress peaks in and in the vicinity of the contact areas of shank to bearing-wall is not possible. Therefore the principle of avoiding steel-glass contact has to be further obeyed thoroughly. This means that always a durable, stress-peaks-eliminating interlayer material (plastics-modified mortar) has to be provided in the clearance between bolt-shank and glass-bearing.

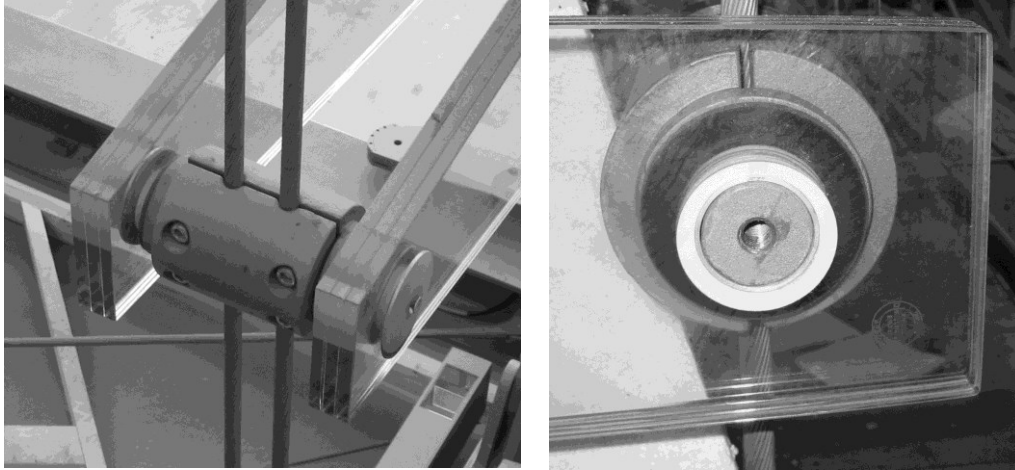


Figure 8-1 Details of bolt connections of glass in the entrance glazing of the New Berlin main station

### 8.2.1 Detailing of a structural bolted connection of bolts in shear in glass holes

The design layout of a bolted connection should always be double-lapped, so that eccentricity moments and non-welcome prying forces can be avoided. The components of a bolt in shear in glass holes are shown in Figure 8-1.

Generally structural glass panes subject to be assemble by bolted connections are of laminated glass. Using laminated glass with drilled holes, a certain backfill of the holes can be expected in the range of tolerances of EN ISO 12543 [13]. This results into the effect of a non-uniform pressure distribution. However, the mortar in the clearance equalizes this effect, Figure 8-1, between mortar and bolt shank there has to be provided an additional ring of aluminium with the thickness of about  $t_{alu} = 2.0$  mm.

The thickness of the mortar (= half of clearance) should be in the range of  $5.0 < t_{mortar} < 12.0$  mm. Using HILTI-Hit-mortar, then in this range an elastic load deformation behaviour can be assumed.

Remark: the use of only plastic – or aluminium ring might be advantageous for simplicity reasons during assembly, however this is not to be recommended as amount and scatter of the reachable ultimate loads are very unfavourable [248]. The following explications therefore, only refer to the detailing as described above Figure 8-1.

### 8.2.2 Analytical verification of a bolted connection in glass

So far, bolted connections have been exclusively calculated by FEM. Analogous to the calculation of point-supports, special care must be taken for the choice of elements and meshing the FE-grid. The question of an adequate and sufficient FE-model is frequently a matter of discussion. For despite of the consideration of the mortar in the FE-model, slight variations of element-type and meshing produce significant stress derivations. Up to now there are no real rules for the choice of the “correct” available FE-model.

Because of this, rather often, there is the opinion that bolted connections only can be designed by testing. This disregards the existence of analytical calculation means, that - adequately prepared – deliver good solutions with regard to time consumption and preciseness. However, they are only applicable to “standard” geometrics.

The following explications are essentially based on [250]. At first the analytical basics on the elastic solid differential equations are touched and then the practical application and preparation is presented (procedural recipe) [248] [249] [251] [252].

### 8.2.3 Elastic response of an in-plane loaded solid pane

The transformation of *AIRY*'s differential equation for an in-plane loaded solid pane (without temperature resistant)

$$\sigma_r = \frac{1}{r} \frac{\partial \Phi}{\partial r} + \frac{1}{r^2} \frac{\partial^2 \Phi}{\partial \varphi^2} \quad (8-1)$$

and the stress function according to *AIRY*

$$\sigma_\varphi = \frac{\partial^2 \Phi}{\partial \varphi^2} \quad (8-2)$$

into polar coordinates leads to stresses

$$\tau_{r\varphi} = \frac{\partial}{\partial r} \left( \frac{1}{r} \frac{\partial \Phi}{\partial \varphi} \right) \quad (8-3)$$

$r$  = radial distance

and  $\varphi$  = angle of radius

By that the stress-states of glass panes with arbitrary geometry can be described. However, what makes the procedure difficult is the search for the function of *AIRY*.

A simple reduction of the procedure can be found for a bolted connection with  $n$  bolts in a row in a glass strip of the width  $b_m$ , Figure 8-2. The strip is loaded at the butt with the total force  $P_{x,total}$ . Considering a single hole  $m$  with the force  $P_{x,m}$ , then – with sufficient distance to the hole-boundary a continuous load in sections perpendicular to the row-axis before and behind the hole can be observed:  $p_{x,m,before}$  and  $p_{x,m,behind}$  the amount of these distributed loads is still unknown. This solid element is subject to a stress-state that can be split up into two parts (Figure 8-2):

- a non-symmetric part (stress-state 1) that shows bearing stresses and net-section stresses,
- a symmetric part (stress-state 2) that shows only net-sections stresses.

In order to attain correct results compared to the original configuration, the boundary loading for the non-symmetrical state 1 are defined with “ $p/2$ ” and for the symmetrical state 2 with “ $q$ ” to

$$q - \frac{1}{2} p = p_{x,m,li} \quad (8-4)$$

$$q + \frac{1}{2}p = p_{x,m, re} \quad (8-5)$$

$$p_{x,m} := \frac{P_{x,m}}{b_m} \quad (8-6)$$

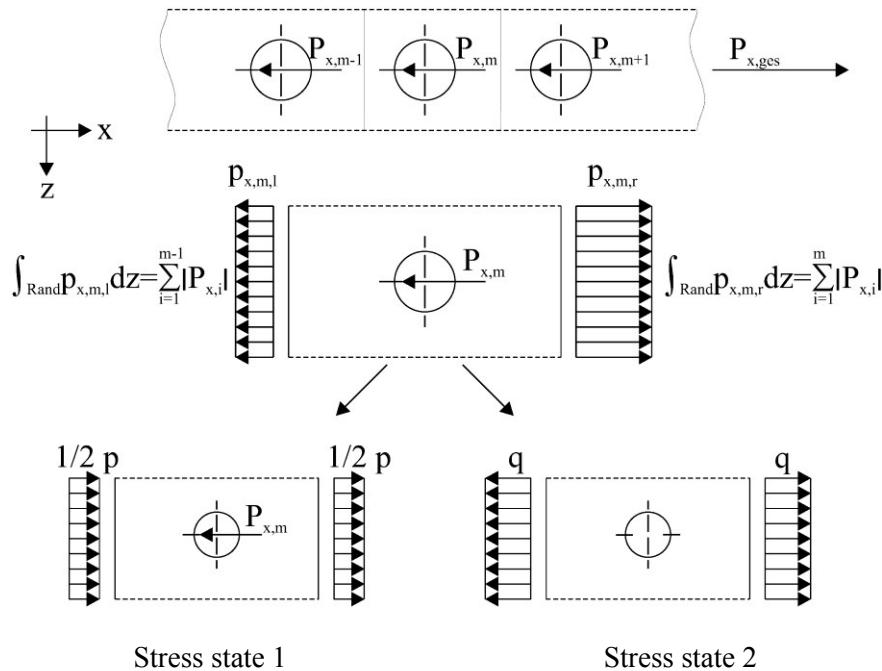


Figure 8-2 Definition of the stress states 1 und 2

**Stress State 1.** Firstly for a plate element loaded by a bolt in bearing the pressure distribution  $p(\varphi)$  has to be determined, Figure 8-3. This can be realized by a cosinus-series [250] [251]:

$$p_H(\varphi) = p_o + \sum_{n=1}^{\infty} p_{H,n} \cdot \cos n \varphi \quad (8-7)$$

Thereby it is assumed to have no clearance. In the series, Figure 8-3, the pressure distribution of each element is in internal equilibrium except of the element  $p_{H,1} \cos(1 \cdot \varphi)$ , this is in equilibrium with the outer load  $P_x$ . Apart of ( $p_0 = 1.0$ ) only the element  $p_{H,1}$  can be determined via the boundary condition.

$$\int_0^{2\pi} p_{H,1} a \cos^2 \varphi d \varphi = P_x \quad (8-8)$$

resulting into

$$p_{H,1} = \frac{P_x}{a \pi}; \quad a = \text{hole radius} \quad (8-9)$$

All other elements cannot be determined analytically due to the lack of further boundary conditions. Integrating over  $0 \div 2\pi$  there are only useless solutions with

$p_{H,1} = p_{H,2} = p_{H,3} = \dots p_{H,u} = 0$  ; respectively for other integration-arcs the boundary conditions are lacking. To overcome this, the FEM can be used producing a vector

$$\bar{p}(\varphi) = \bar{p}_H = \begin{bmatrix} p_0 \\ p_1 \\ \vdots \\ p_{n-1} \\ p_n \end{bmatrix} \text{ to } \bar{v} = \frac{a}{P_x} \bar{p} \quad (8-10)$$

with  $\bar{v}$  according [249]. A sufficient accuracy will be reached when approximately 20+1 serial elements are determined. By this the bearing pressure  $\sigma_r(a, \varphi) = p_H(\varphi)$  are known under the assumption of friction-free conditions. These pressures then can be introduced into the function of *AIRY*  $\varphi_H(r, \varphi)$  at the bearing are by

$$\Delta\Delta\Phi_H(r, \varphi) = 0 \quad (8-11)$$

The radial, tangential and shear stresses in the plate (resulting from the non-symmetric loading) can be determined

$$\begin{aligned} \sigma_{r,H}(r, \varphi) = & -\frac{p_0 a^2}{t r^2} - \frac{1-\mu}{4t} p_1 \frac{a}{r} \left[ \frac{3+\mu}{1-\mu} + \frac{a^2}{r^2} \right] \cdot \cos \varphi \\ & - \frac{1}{2t} \sum_{n=2}^{\infty} p_n \frac{a^n}{r^n} \left[ (n+2) - n \frac{a^2}{r^2} \right] \cdot \cos n \varphi \end{aligned} \quad (8-12)$$

$$\begin{aligned} \sigma_{\varphi,H}(r, \varphi) = & +\frac{p_0}{t} \frac{a^2}{r^2} + \frac{1-\mu}{4t} p_1 \frac{a}{r} \left( 1 + \frac{a^2}{r^2} \right) \cdot \cos \varphi \\ & + \frac{1}{2t} \sum_{n=2}^{\infty} p_n \frac{a^n}{r^n} \left[ (n-2) - n \frac{a^2}{r^2} \right] \cdot \cos n \varphi \end{aligned} \quad (8-13)$$

$$\begin{aligned} \tau_{r,\varphi,H}(r, \varphi) = & 0 + \frac{1-\mu}{4t} p_1 \frac{a}{r} \left( 1 - \frac{a^2}{r^2} \right) \cdot \sin \varphi \\ & - \frac{1}{2t} \sum_{n=2}^{\infty} p_n \frac{a^n}{r^n} n \left( 1 - \frac{a^2}{r^2} \right) \cdot \sin n \varphi \end{aligned} \quad (8-14)$$

with

$r, \varphi$  polar coordinates, seen from the hole centre

$p_i$  terms of the series

$a$  hole radius

$t$  thickness of the glass pane

$\mu$  *Poisson's* ratio

The solutions are exact if the dimensions of the considered glass element are infinite.

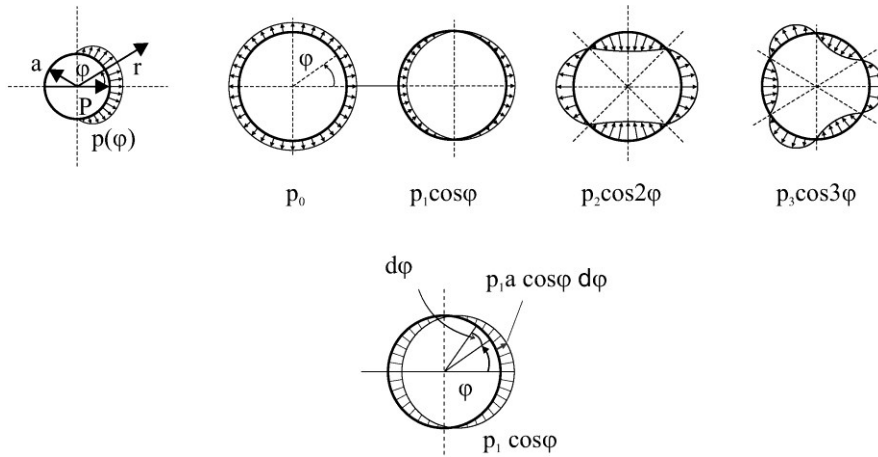


Figure 8-3 Stress State 1

**Stress State 2.** The symmetrical stress state originates from an infinite plate with hole under tension and can also be determined by solving of  $\varphi$  with  $\Delta\Delta\varphi = 0$ . The solutions for  $\sigma_r$ ,  $\sigma_\varphi$  and  $\tau_{r,\varphi}$  are

$$\sigma_{r,N}(r, \varphi) = \frac{p}{2t} \left[ 1 - \frac{a^2}{r^2} + \left( 1 - \frac{4a^2}{r^2} + \frac{3a^4}{r^4} \right) \cos 2\varphi \right] \quad (8-15)$$

$$\sigma_{\varphi,N}(r, \varphi) = \frac{p}{2t} \left[ 1 + \frac{a^2}{r^2} - \left( 1 + \frac{3a^4}{r^4} \right) \cos 2\varphi \right] \quad (8-16)$$

$$\tau_{r,\varphi}(r, \varphi) = \frac{p}{2t} \left[ -1 - \frac{2a^2}{r^2} + \frac{3a^4}{r^4} \right] \sin 2\varphi \quad (8-17)$$

see Figure 8-4.

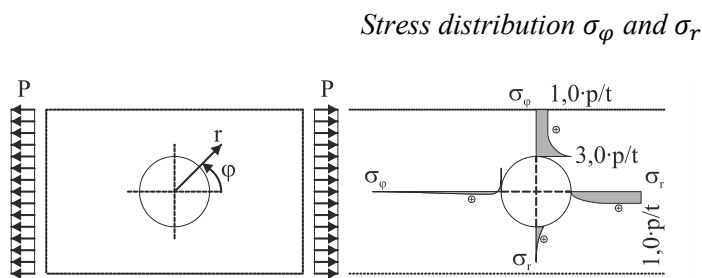


Figure 8-4 Stress State 2

For a plate element with a finite width  $b_m$  and with  $p_x / 2 = P_x / (2 \cdot b_m) = (p_1 a \pi) / (2 b_m)$  the following results ( $p_1 =$  series element from antimetric loading).

$$\sigma_{r,N}(r, \varphi) = \frac{p_1 a \pi}{4t b_m} \left[ 1 - \frac{a^2}{r^2} + \left( 1 - \frac{4a^2}{r^2} + \frac{3a^4}{r^4} \right) \cos 2\varphi \right] \quad (8-18)$$

$$\sigma_{\varphi,N}(r, \varphi) = \frac{p_1 a \pi}{4t b_m} \left[ 1 + \frac{a^2}{r^2} - \left( 1 + \frac{3a^4}{r^4} \right) \cos 2\varphi \right] \quad (8-19)$$

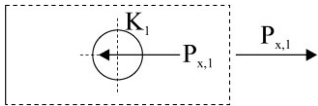
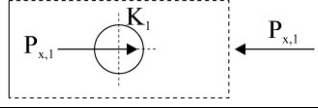
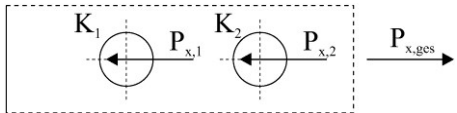
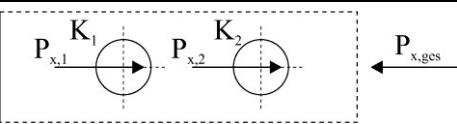
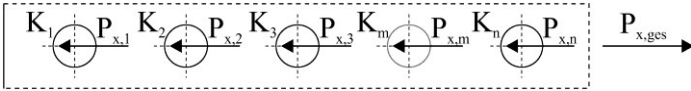
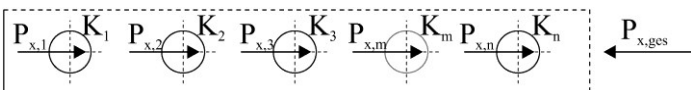
$$\tau_{r,\varphi,N}(r,\varphi) = \frac{p_l a \pi}{4t b_m} \left[ -1 - \frac{2a^2}{r^2} + \frac{3a^4}{r^4} \right] \sin 2\varphi \quad (8-20)$$

**Superposition and  $K_m$ -values.** As explained, the superposition of the symmetric and anti-symmetric stress state allows for the determination of the resulting stress state. Thereby the system definition is such, that the anti-symmetric stress state results from the single-bolt-consideration and is split up into a pulling and a pushing edge loading. The symmetric stress state is a pure net-section stress due to the stresses passing the hole. With the product  $K_m \cdot p_{x,m} / 2$  the amount of the passing stressing is described as a multiple of 1/2 (for the rest of the forces  $P_{x,i \neq m}$ ). Then, by  $2 \cdot (p_{x,m} / 2)$  from the anti-symmetric state a bolt force can be put. It becomes clear, that the method is also valid for non-equal forces  $P_{x,i}$ . For the values  $K_m$  the general format reads:

$$K_m = 2 \frac{\sum_{i=1}^m |P_{x,i}|}{|P_{x,m}|} - 1 \quad (8-21)$$

E.g. for a hole at the edge the  $K$ -value is  $K_1 = 1.0$  so that there is not further loading on the edge. For the neighbouring hole  $K_2 = 3.0$  can be obtained, see Table 8-1.

Table 8-1  $K_m$ -values

Equilibrium system	$K_m$ -value
	$K_1 = 1$
	$K_1 = -1$
	for $P_{x,1} = P_{x,2}$ it is: $K_1 = 1$ $K_2 = 3$
	for $P_{x,1} = P_{x,2}$ it is: $K_1 = -1$ $K_2 = -3$
	For ambiguous holes $m \leq n$ $K_m = 2 \frac{\sum_{i=1}^m  P_{x,i} }{ P_{x,m} } - 1$
	For ambiguous holes $m \leq n$ $K_m = 1 - 2 \frac{\sum_{i=1}^m  P_{x,i} }{ P_{x,m} }$

**Resulting Stress State.** The superposition of the described split stress states yield into the total stress states. By that the stress states of arbitrary lap-joints can be calculated provided, that the holes have sufficient distance each to another (otherwise the single stress states influence each other)

**Tangential stresses:**

$$\begin{aligned} \sigma_{r(SL_{tot})}(r, \varphi, \xi) = & -\frac{p_0}{t} \cdot \frac{a^2}{r^2} - \frac{1-\mu}{4t} p_1 \frac{a}{r} \left[ \frac{3+\mu}{1-\mu} + \frac{a^2}{r^2} \right] \cdot \cos \varphi \\ & - \frac{1}{2t} \sum_{n=2}^{\infty} p_n \frac{a^n}{r^n} \left[ (n+2) - n \frac{a^2}{r^2} \right] \cdot \cos n \varphi \\ & + K_m \frac{p_1 a \pi}{4t b_m} \left[ 1 - \frac{a^2}{r^2} + \left[ 1 - \frac{4a^2}{r^2} + \frac{3a^2}{r^4} \right] \cdot \cos 2 \xi \right] \end{aligned} \quad (8-22)$$

$$\begin{aligned} \sigma_{p(SL_{tot})}(r, \varphi, \xi) = & +\frac{p_0}{t} \cdot \frac{a^2}{r^2} - \frac{1-\mu}{4t} p_1 \frac{a}{r} \left[ 1 + \frac{a^2}{r^2} \right] \cdot \cos \varphi \\ & + \frac{1}{2t} \sum_{n=2}^{\infty} p_n \frac{a^n}{r^n} \left[ (n-2) - n \frac{a^2}{r^2} \right] \cdot \cos n \varphi \\ & + K_m \frac{p_1 a \pi}{4t b_m} \left[ 1 + \frac{a^2}{r^2} - \left[ 1 + \frac{3a^2}{r^4} \right] \cdot \cos 2 \xi \right] \end{aligned} \quad (8-23)$$

**Shear stresses:**

$$\begin{aligned} \tau_{r,\varphi(SL_{tot})}(r, \varphi, \xi) = & 0 + \frac{1-\mu}{4t} p_1 \frac{a}{r} \left[ 1 - \frac{a^2}{r^2} \right] \cdot \sin \varphi \\ & + \frac{1}{2t} \sum_{n=2}^{\infty} p_n \frac{a^n}{r^n} \left[ 1 - \frac{a^2}{r^2} \right] \cdot \sin n \varphi \\ & + \frac{1}{2t} \sum_{n=2}^{\infty} p_n \frac{a^n}{r^n} \left[ 1 - \frac{a^2}{r^2} \right] \cdot \sin n \varphi \\ & + K_m \frac{p_1 a \pi}{4t b_m} \left[ -1 - \frac{2a^2}{r^2} + \frac{3a^4}{r^4} \right] \cdot \sin 2\xi \end{aligned} \quad (8-24)$$

For instance, by means of the FEM, it can be shown that the analytical solution is valid for  $b_m \geq 5d_0$  with sufficient accuracy. For similar widths the stresses are to be magnified by the values of Table 8-3. For widths of  $b_m < 3d_0$  the equations are not more applicable.

The parameters  $K_m$  can also be used for oblique acting forces. Thereby the components of the forces in x- and y-direction have to be separately treated.

**Constructive influences.** After the elasto-statically analytics, assuming perfect and tolerance-free relations, now the realistic imperfections and constructive boundary conditions have to be taken into account. The effects of this have already been determined by FEM [249] [250]. The influencing factors are:

1. deviation of the pressure distribution from the theory by
  - geometry of the mortar filled clearance
  - stiffness of mortar
  - bolt diameter  $d_b$
  - amount of clearance between bolt- and aluminium-ring
  - non symmetric pressure distribution over one glass layer.
2. The configuration of the joint



- edge distance of the holes  $e_1$  and  $e_2$
  - pitch of the holes  $p_1$  and  $p_2$
3. manufacturing/fabrication tolerances
- mismatch of hole position in the glass layers of the laminated pane
  - clearance  $\Delta s$  of the bolt in the ring
  - unscheduled eccentricity of the bolt in the hole.

The results of the parameter investigations by FEM are prepared in form of stress-amplification-factors  $k_i$ .

Defining a joint configuration  $e_1$  and  $p_1$  as edge- and pitch-distance in direction of the load and  $e_2$  and  $p_2$  are the edge- and pitch-distances perpendicular to the load direction, then the width  $b_m$  should be the minimum of  $(2e_1, 2e_2, p_1$  and  $p_2)$ , but  $b_m \geq 3d_0$ . Product and manufacturing standards on hole and edge distances certainly have to be regarded further on.

The values  $k_1$  up to  $k_5$  can be taken from the following tables.

**Table 8-2**  $k_1$  to consider unscheduled pressure distribution over the thickness  $t$ ;  $e_y$  is the distance of the mid-point of two conjunct glass panels (till now, only one simulation series is present)

$e_y$	[mm]	0	10	15	20	30	45
$k_1$	-	1.0	3.5	4.8	6.1	8.7	12.6

**Table 8-3**  $k_2$  to consider small effective width,  $b_m \geq 3 d_0$

$b_m$	$b_m \geq 5 d_0$	$3 d_0 \leq b_m < 5 d_0$
$k_2$	1.0	1.2

**Table 8-4**  $k_3$  to consider small edge distances

$e_1, e_2$	$1.5 d_0$	$2.5 d_0$	$3.5 d_0$	$> 3.5 d_0$
$k_3$	1.21	1.09	1.03	1,0

**Table 8-5**  $k_4$  to consider small hole distances  $p_1, p_1 \geq 3 d_0$

$p_1$	$3 d_0$	$5 d_0$	$7 d_0$	$9 d_0$	$\gg 9 d_0$
$k_4$	1.23	1.10	1.06	1.04	1.0

**Table 8-6**  $k_5$  to consider a displacement of laminated glass, related to a symmetrical 2-layered laminate. The ratio of layer-shift to hole-clearance (fitted with mortar) should be less than 0.5 and the ratio of hole-clearance and hole-diameter should be between 0.07 and 0.2)

Glass product	2-layered laminate	Monolithic glass
$k_5$	1.2	1.0

The value  $k_6$  together for the consideration of the hole clearance  $\Delta s$  with  $\Delta s/d_{bolt} \leq 0.02$ , for the consideration of an eccentricity of  $e/b_{mortar} \leq 0.4$  and for the consideration of the whole range of drilling diameters  $22 \text{ mm} \leq d_0 \leq 60 \text{ mm}$  with  $0.5 \leq d_{bolt}/d_0 \leq 0.77$  are commonly treated with the factor  $k_6 = 1.5$ .

### 8.2.4 Approximation and engineering formula

Now for monolithic and symmetric double layered laminated glass with a total thickness of  $b_m \leq t_{\text{total}} \leq 45 \text{ mm}$  the derived stress equation can be replaced by a simple design formula. Prerequisite to that is further that the polymeric-modified mortar provides an elastic modulus of 1000 MPa ÷ 5000 MPa.

$$\sigma_{\varphi, \max} = \left( \prod_{i=1}^6 k_i \right) \left( 0,40 + 1,50 \frac{a \cdot K_m}{b_m} \right) \cdot \frac{P_d}{a \cdot t} \leq f_{t,d,l} \quad (8-25)$$

with

$P_d$  resulting design force of the considered or relevant bolt

$d_0$  hole diameter

$t$  glass thickness of one layer

$k_i$  factors considering constructive influences

$b_m$  width in [mm]

$K_m$  equilibrium parameter

$f_{t,d}$  design tension strength at the hole edge

Summing up the general design procedure is as follows:

1. Determination of the sectional forces at the whole joint
2. Distribution of the forces on the single bolts under consideration of eventual non-uniformities
3. Determination of the width  $b_m$  in dependence of edge and pitch distance and their min.-values
4. Determination of  $k_i$
5. Calculation of  $K_m$
6. Applying of engineering formula.

### Code Review No. 57

#### Product standard

*The mechanical and material properties of the use clearance infill material, e.g. polymeric modified mortar, should be specified in a standard. E.g. for Hilti HIT-mortar there exists an ETA respectively Technical Approval.*

#### Design standard

*Rules on load carrying bolted connections so far are not known.*

### Eurocode Outlook No. 39

- (1) *Within the design of bolted connections, the reification of the glass can be performed by an adequate numerical investigation (FEM).*
- (2) *Thereby all detailing effects as described have to be taken thoroughly into account.*
- (3) *Alternatively, for simple joint configurations, safe sided design formulas as presented may be also used, accounting for the same safety conditions.*

- (4) For this the application boundaries in dependence of the calculation theory should clearly be described.
- (5) Eurocode should give examples or indications for best practise design.

### 8.3 Friction Joints

Friction joints are a very interesting alternative for the transmission of shear forces from pane to pane. They are considerably flexible, as with friction shear forces can be transmitted not only “discontinuously” but also linearly or “continuously”. By clamping along the whole edges of glass panes large “profiles” of glass are obtained, see Figure 8-5. Very beneficial is that they are detachable. With the respective detailing at the edges (step formed edges of laminated glass panes) they even do not need any holes for pre-stressed bolts.

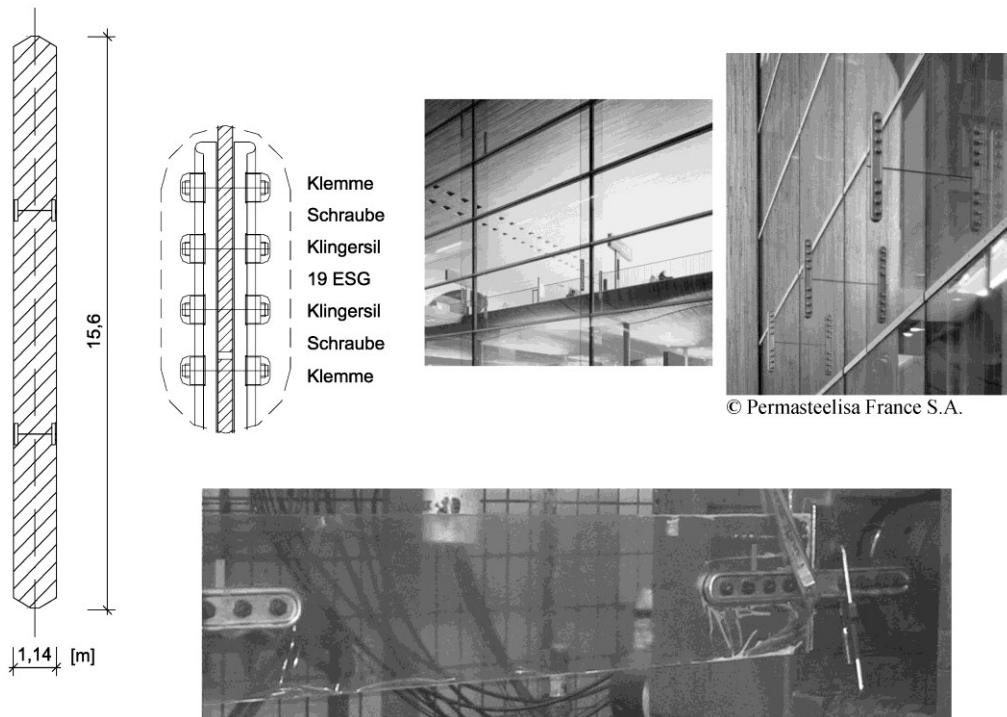


Figure 8-5 Example: Glass fins of the façade of Terminal 2E of the Airport “Charles de Gaulle”, Paris

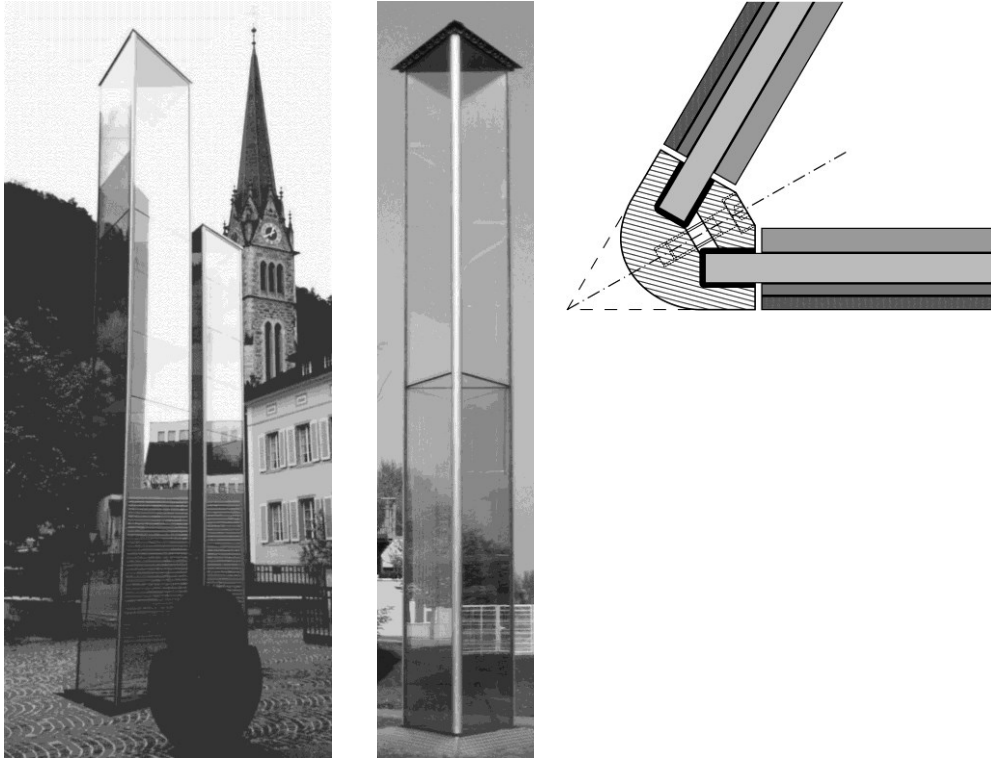


Figure 8-6 Triangular glass stele with friction joints at the edges

The principle of friction joints in glass structures refers to that of pre-stressed joints in steel structures. Pre-stressing of the contact surfaces by high-strength-bolts of grade 8.8 or 10.9 enables considerably high friction forces for the transmission of shear stresses. The layout of a friction connection is always realised by the use of clamping laps of steel, stainless steel, aluminium or rarely with titanium. Therefore, in the gap between metal lap and glass a special interlayer material has to be provided. This interlayer must be compressible, durable, and reliable, with low creep behaviour and at the same time able to produce a sufficient high friction coefficient. It is clear that this interlayer should also provide a good stress distribution effect ensuring a smooth stress introduction with no detrimental stress peaks. Furthermore sufficient high friction coefficients should be developed. Finally steel-glass-contact has to be avoided both in the friction gap as well as in the hole where possibly a pre-stressed bolt is located.

The layout of discontinuous friction joints should have only two shear gaps. A positive effect is that the friction effect then is “doubled”. The following example may show the potential shear transmission capacity of a clamping point with three bolts M20, 10.9, each of them with a pre-stressing force  $R_p = 160 \text{ kN}$ . Having two shear planes, in each of them a special non-creeping prestress-able and durable interlayer material is located, e.g. “Klingersil C 42” of 2.0 mm thickness with a friction coefficient of about  $\mu \cong 0.15$ , the resulting characteristic shear force resistance of this joint would be

$$S_{Rk} = n_s \cdot n_b \cdot \mu \cdot 0.15 \cdot 160 = 2 \cdot 3 \cdot 0.15 \cdot 160 \cong 140 \text{ KN}$$

For the design value a safety coefficient has to be considered, ranging between  $\gamma_M = 1.25$  and  $\gamma_M = 1.5$ . Apart from the above mentioned mechanical and durability properties a proper and thorough cleaning of the glass surface is necessary (grease-free and dirt-free). The

same applies for the steel surfaces; the surface-evenness has to fulfil highest requirements. Each step of the fabrication has to be well documented and proofed.

Suitable glass qualities may be heat strengthened or thermally toughened glass. The glass surface must not be roughened by grinding, pickling or acid treatment (possibly to improve the friction coefficient), as the so induced surface damages reduce significantly the glass strength. Laminated toughened glass should not be clamped over the whole glass layer compound (package), because of the reduction of pre-stress by creep of the interlayer. Eventually, if laminated glass is used, it is recommendable to provide a stepwise edge detail such that the inner (load carrying glass layer) can directly be clamped. If punctual (discontinuous) joints are used together with laminated glass, the protective glass layers should be spared in such way that the steel-laps can be integrated in the cross-section of the glass.

The drillings should be oversized, so that tolerances from manufacturing and mounting as well as from eventually occurring displacements under load do not lead to a steel-glass-contact. For this, also a protection layer surrounding the shank of the bolt should be provided. Further, the clamping lap surfaces should be even, possibly milled, the laps themselves relatively stiff, such that the force transmission can be enabled “as calculated”.

Beside of the friction verification, the verification of the glass stresses in the area of the joint (net-section, bearing area) has to be carefully be performed. This is – in most cases – to be done by adequate FEM-modelling and eventually by additional testing. For a pre-design it may be indicated that especially in case of long, acting joints under a single load (dependent on the elasticity/plasticity of the configuration) stress peaks may occur at the ends of the joints. These stress- and force-peaks may reduce the overall shear force resistance of the joint.

## **Eurocode Outlook No. 40**

- (1) *Within the design of friction connections, different failure modes have to be considered*
- a. *Failure due to slipping*
  - b. *Glass failure*
- Both failure modes have to be assessed using elastic theory.*
- (2) *Only materials with assessed mechanical properties and durability should be used.*
- (3) *The preparation of the friction joints should be sufficiently controlled during fabrication.*
- (4) *Post breakage residual capacity should be ensured.*

## **8.4 Adhesive bonding**

### **8.4.1 General**

Steel is a predictable, well researched material for structural applications, whereas glass is an elastic and brittle material without any capacity for plasticizing, less well researched for structural uses and not amenable to simplified design. To benefit from the advantageous behaviour of both materials, adhesive bonding as an innovative joining technique becomes increasing important and popular. Hybrid joining with bonding technique allows for contemporary transparent and load bearing structures where each material is used in an optimized

way according to its material properties. These hybrid elements offer main advantages regarding load carrying capacity, stability behaviour, ductility and robustness.

The bonding technology itself is a modern solution to connect different materials without energy input or weakening the cross section by holes. It is used in other industry such as automotive or aviation industry as well as the ship building industry with great success and has been established there for years. The connection of steel sheeting or steel profiles and glass structures has been already applied there, for example bonding the windscreens of cars, busses, trucks or trains on the load bearing substructure in order to increase the global torsional stiffness.

On the contrary in civil and façade engineering bonding is still predominantly used for sealing applications or for bonding of structures with minor structural importance (tiles, parquets, dowels and bolts). One positive example for the use of structural bonds in civil engineering is the reinforcement of concrete structures with bonded steel or CFRP sheets. In façade engineering structural silicone glazing (SSG) applications with “structural” silicones have been successfully applied since 30 years, but in the majority of cases with additional mechanical retaining systems. That is why and where the recent research projects and innovative building projects come in [253] – [264].

First of all, compared to conventional joining techniques in glass and steel constructions like bolted connections or welding, bonded joints show the following major advantages and disadvantages:

- Connection of materials with different properties (hybrid connection of steel and glass)
- Components are not weakened by holes (simultaneous saving of costs)
- Constant stress propagation caused by a continuous connection
- Vibration damping due to the lower Young’s-modulus of the bonding
- Saving of weight caused by the absence of bolts and the use of thinner raw material
- Economy of space, lightweight construction
- Visual appearance is not disrupted by fastenings and connectors
- Compensations of tolerances
- Lower resistance compared to the connected materials
- Elaborate manufacturing process and surface pre-treatment
- Durability influenced by ageing, high temperature, humidity and UV-radiation
- Long-term behaviour influenced by creeping
- Limited fire-resistance

The disadvantages must be balanced or minimized by an appropriate joint design such as sufficient bonding geometries, appropriate loadings (predominant shear, avoidance of peel loadings, limited temperature loadings) and adequate adhesive selection. Care needs to be taken when considering adhesives with modulus of 50 MPa or greater, as these are capable of causing glass failure by “plucking” glass if the interface is imperfect and the forces on the adhesive joint are eccentric. Especially in other application fields a large number of bonding materials is available that would be appropriate for use in structural steel applications, whereas cold hardening one- or two-component adhesives or UV-curing ones are the most practical for structural application for civil engineering aspects.

### 8.4.2 Types of adhesive

Requirements on adhesive layer are mainly focused on strength and stiffness so far but in particular have to take into account the deformation capability. Consequently the whole bonded joint has to be rigid enough to provide an optimal structural interaction between both substrates, but on the other hand it has to be flexible enough to redistribute the stress peaks in critical points and to compensate pertinent different temperature elongation.

Concluding the cured bonded joint has to meet the following static and constructional requirements:

- Load transfer of primarily shear forces (peel forces and eccentricities should be avoided if possible),
- Reduction of stress peaks (by sufficient deformation capability or ductile elasto-plastic behaviour of the adhesive material and/or respectively geometrical design of the adhesive connection),
- Compensation of constraint forces due to possible thermal expansion,
- Compensation of fabrication tolerances (gap-filling behaviour).

Common adhesives can be divided according to their modulus of elasticity and shear modulus into flexible-elastic (i.e. silicones, modified silicones and polyurethanes) and rigid (i.e. epoxy resin, acrylates). Stiff adhesives offer extremely high strength but very low elongation in comparison with elastic adhesives, which show elongation at break even more than 250%. A new development in the field of stiff cross-linked adhesives is toughened modified ones with considerable enhanced ductility.

Concluding there are four main adhesives systems applicable for steel and façade structures:

- Epoxy resins
- Polyurethanes
- Acrylates
- Silicones

For these groups there do already exist a huge range of possible adhesives with completely different curing mechanism, mechanical behaviour, ageing resistance, application behaviour, etc. In addition, stiff ionomer or structural transparent addition cured silicon materials are currently gaining interest for creating adhesive connections between glass and metal components [267].

Originally, adhesives classified according to their chemical structure or curing mechanism [265]. From an engineering point of view an adhesive classification according to the final polymeric structure is more expedient. Such more engineering-like attempt is e.g. made in [269] which distinguishes between elastomers, thermoplastics and duromers. Whereas thermoplastics do not show cross-linking between the molecular chains, elastomers are slightly and duromers are highly cross-linked. Hereby elastomers and duromers are in amorphous state while thermoplastic can present amorphous or semi-crystalline state. To describe the mechanical behaviour of amorphous polymers three temperature ranges are distinguished:

- energy-elastic range
- glass transition temperature

- entropy-elastic region.

Those three regions are described by measurement of the glass transition and its characteristic delaminating value glass transition temperature  $T_g$ . Normal procedures for its determination are the Differential Scanning Calorimetry (DSC), the Dynamic-Mechanic-Analysis (DMA) or the Thermo-mechanical Analysis (TMA) [260].

Table 8-7 attempts to classify common used adhesive systems regarding the applicability for steel-glass joints – as far it is possible at all in such a general manner. Especially polyurethanes show a wide spectrum of different properties, so that a valuation is hard to be made.

Table 8-7 General comparison of different adhesive systems [262]

	Tension and shear strength	Stiffness	Ductility	Viscosity	Temperature resistance	Ageing behaviour	UV resistance	Transparency, colour
Epoxy resin	+++	+++	+	+++	++	++	++	+
Polyurethane	++	+++	++	++	++	++	++	++
Acrylate	++	++	++	++	++	+++	+++	+++
Silicone	+	+	+++	+	+++	+++	+++	+

Figure 8-7 shows a general correlation between elastic properties and Young’s modulus, whereupon a decrease of the Young’s modulus from two component epoxy resins to one component polyurethanes simultaneously goes along with a ductility and deformability increase.

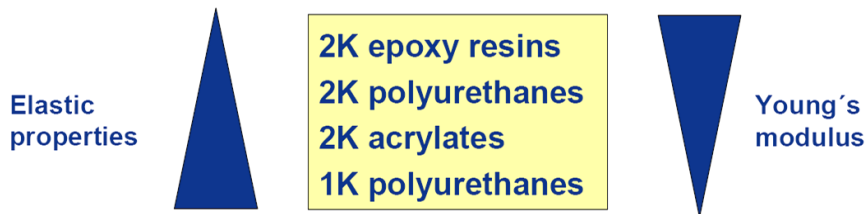


Figure 8-7 Connection between stiffness and elasticity for common adhesive systems [260]

Practical application of different types of polymer adhesives depends on their behaviour under loading. During the selection, special emphasis has to be devoted to the UV stability and long-time behaviour of chosen adhesives. UV unstable adhesives, like most of the polyurethanes, have to be protected from UV lights by using special primer coating also on the side of the glass pane, because there is a risk of UV lights propagation also by the reflection inside the glass pane.

From the author’s view definitely two-component adhesives or adhesives with booster system should be used for bonded structural glass connections, where the width of the connection is too big (over 30 mm) for humidity curing. From previous research came out, that one-component adhesives (mainly polyurethanes), which are cured by air humidity, cannot harden for depths wider than ca. 15 mm in a reasonable period of time. The booster component provides uniform hardening of the adhesive layer, process of curing doesn’t depend on air



humidity and the whole curing is finished in hours and not in days as for one component adhesives. Alternatively UV-curing adhesives can be used which cure on demand, but in many cases show significant shrinkage during the curing process.

Another important task of the connection design is to find an optimal adhesive thickness, which fulfils the requirements on stiffness and load carrying capacity, provides sufficient elongation (or shear strain) and also compensates possible geometrical imperfections and balances tolerances of the connected surfaces during the fabrication. All adhesives should be also chosen regarding to their open time and pot-time, which is very important in respect to fabrication criteria. Some of adhesives can be applied by gap-filling, but other more viscous ones have to be compressed by the components that have to be connected. The final choice of adhesive is additionally influenced by arising temperature elongations as well as susceptibility for creeping and ageing.

Ageing is a process that strongly depends on the adhesive system. Ageing, corrosion and temperature changes occur under natural atmospheric exposure. According to the climatic zone these effects are more or less pronounced and can lead to chemical and molecular changes in the adhesives structure. Commonly affected are the boundary layer and the adhesion between adhesive and substrate surfaces, but there is also a considerable influence to the cohesion of the adhesive itself. Besides a reduction of the adhesion and a tendency for adhesive interface failure because of peeling stresses or stress peaks, ageing effects go along with embrittlement and a decrease of strength.

### **8.4.3 Present state of standardization**

On European level the European Organization for Technical Approvals (EOTA) was established as an umbrella organization that is responsible for the European standardization process. It consists of the regulatory and certifying authorities of each single member state, which are responsible for the granting of European Technical Approvals. Germany e.g. is represented by the *Deutsches Institut für Bautechnik (DIBt)*.

Main task of the *EOTA* is the development of guidelines for *European Technical Approvals (ETAGs – European Technical Approval Guidelines)*, the coordination of the granting procedure of European Technical Approvals (ETAs) and the continuation and survey of existing ETAs.

In European Technical Approval Guidelines (ETAG) for the member states the specific characteristics of products or product families are defined and how to use them. They contain product requirements and information about necessary test methods and evaluation criterions for the test evaluation.

Structural bonded glass and façade structures are regulated by the ETAG 002 [269]. This European Technical Approval Guidelines represents a guidance for the European technical approval of Structural Sealant Glazing Systems and is subdivided into three parts:

- Part 1: Supported and unsupported systems
- Part 2: Coated Aluminium Systems
- Part 3: Systems incorporating profiles with thermal barrier

Here the structural glass facade is considered as a composite structure of glass, adhesive and substructure, where the adhesive connection is exclusively carried out as linear, circum-

ferential and factory-made silicon joint. In the meantime acrylic foam tapes are also in the scope of application according to ETAG 002.

The general application of these structural bonded façade elements is distinguished in supported or unsupported glass elements, where the former implies an extra support for dead loads. For insulated glass or laminated glass every single pane must be vertically supported supplementary. Mechanical restraint system may be installed for cases of adhesive failure depending on the supplementary national requirements.

Today there are some single applications of bonding in façade engineering which are generally known as Structural Sealant Glazing Systems (SSGS), where “structural” silicones or acrylic adhesive foams are used for joining stainless steel or aluminum substructures with glass panes. All existing structures for building envelopes are commonly in compliance with the ETAG 002 Guidelines [269]. Besides the narrowly limited uses cases according to ETAG 002 there are some realized-reinforced glass beam projects [270]. In principle the application of bonded steel-glass structures is possible for a lot of façade, roofing and ceiling components, which must offer transparency and load-bearing functions and which were not governed by fire resistance requirements.

## Code Review No. 58

*ETAG 002 [269]:*

*Devices to reduce danger in the event of bond failure may be required by national regulations”.*

*Application rules for ETAG 002 [269] in Germany:*

- *Up to 8 m only type 1 and 2 facades with self-weight support are admitted, above 8 m only facades of type 1 with retaining device to reduce danger in case of bond failure*
- *Façade type 3 and 4 without self-weight supports are only provided for single-pane safety glass (ESG) so far, but not allowed in Germany*
- *The inclination angle of the bonded façade structure has to range between 7° and 90°. In some single cases inclination of 10° against the vertical and up to 20° to the inwardly are admissible [268].*
- *The use of silicon-based adhesives and adhesives tapes requires an ETA.*
- *Bonded structures made of insulated glass or safety glass are only permitted as type 1 or 2 systems if all single panes are supported.*
- *An application as safeguarding glazing is not allowed.*
- *The application is limited to facades with wind suction loads less than 2,2 kN/m<sup>2</sup>, which is not always complied for corner regions [268].*
- *There are also restrictions regarding adhesives, surfaces and manufacturing:*
- *Only silicones or silicone-based sealants and adhesive tapes are regularized. Polyurethanes, epoxy resins or acrylates are not included.*
- *The application of silicones or acrylic adhesives tapes requires general type approval for the type of construction.*
- *All bonds must be linear, circumferential and have to be applied under shop conditions. Deviation from rectangular bonding geometry (aspect ratio from 1:1 to 1:3), dual-flank adhesion, or interrupted or punctual bonds are not provided.*
- *Bonding on site or repair measures is not included.*
- *The substrates are limited to uncoated or organically coated glass, stainless steel or anodized aluminum substrates; organic coated, powder-coated or galvanized substrates are excluded.*
- *In all cases a minimum adhesive thickness of 6 mm has to be applied.*

*Application rules for ETAG 002 [269] in Italy and in the Netherlands:*

*The ETAG 002 is applied without restriction.*

*Cahier CSTB 3488-V2 [67]: This document gives rules for structural glazing installation. It defines conception and fabrication recommendations on glass elements, structural sealant and metallic structure. It describes loading conditions and dimensioning methods for insulating glass units and structural sealant. Experimental procedure is defined to ensure sealant resistance. It gives the calculation method to dimension the secondary sealant of glazing kits under climatic actions.*

*EN 13022-1 [82]: European Standard on glass products that specifies requirements for the suitability for use of supported and unsupported glass products for use in “Structural Sealant Glazing” (SSG) applications (same types as per ETAG 002). It is considered as a supplement to the requirements specified in the corresponding standards with regard to verifying the suitability for use in SSG systems. It contains rules for calculation of glass thickness and silicon bonding thickness and requirements for assembly.*

*EN 13022-2 [83]: European Standard for assembling and bonding of glass elements in a frame, window, door or curtain walling construction, or directly into the building by means of structural bonding of the glass element into or onto framework or directly into the building. It gives information to the assembler to enable him to organize his work and comply with requirements regarding quality control. It contains assembly rules in terms of tests and Factory product control.*

*EN 15434 [84]: European Standard for the evaluation of conformity and the factory production control of sealant in case of structural applications in curtain walling systems covered by ETAG 002.*

Concluding, the range of application of the ETAG 002 is restricted to (by the example of Germany):

For building purposes the current regulations of the ETAG 002 are resulting in self-weight supports by setting blocks and the avoidance of systematic creeping loads for bonded connections. The dimensions of the adhesive joints are around 15 mm width and 6 mm thickness.

#### **8.4.4 Current research**

Current research regarding adhesive bonding for glass structures can be divided into the following three connections types

- punctual bonded joints (e.g. point supports)
- linear bonded connections (e.g. hybrid beams or façade connections)
- two-dimensional, plane bonded joints (e.g. overlapping joints of glass beams)

The geometry, stiffness and load carrying capacity of the adhesive joint are of central significance for the structural behaviour of the bonded connection. This implies the detailed knowledge of the mechanical values and the durability of the adhesives. Particularly discontinuities in the boundary areas require a closer examination.

The aim of current research projects [263], [264], [262] is to derive simple design recommendations for bonded steel-glass elements, taking into consideration the common safety specifications of glass thus avoiding extensive finite element calculations. To achieve this, a systematic approach is generally adopted:

- Determination of requirements for the adhesive joint;
- Design of the joining geometry;
- Adhesive selection;
- Determination of mechanical values by standardized test;
- Development of small scale test specimen (push-out or pull-out specimens) with significance concerning;
- Determination of tensile and shear capacity by means of small scale specimen;
- Transfer to real structural elements;
- Derivation of design recommendations.

The basis for this approach is the knowledge of the slip and elongation characteristic of the adhesive joint arising from the context of the building structure, such as defining the structural and geometrical requirements for the adhesive joint. Depending on the connection type it is useful to determine the slip-strain behaviour. In a next step appropriate adhesives are chosen and the mechanical values are determined, which were then taken over to small-scale push-out tests and verified by large scale component tests. Finally, resulting design recommendations are derived.

#### 8.4.5 Proposals for the calculation

The current research [263], [264] and the findings within the workgroup bonding of the German Professional Association for Structural Glazing [266] reveals that the visco-elastic adhesive behaviour predominantly influences the mechanical behaviour and therefore cannot be ignored in design proposals. The mechanical behaviour strongly depends on **temperature, strain rate and strain energy input** which define whether the adhesive behaves more energy-elastic or entropy-elastic. These three parameters significantly influence the mechanical behaviour and must be implicitly taken into account for future calculation methods. Up to now there is no existing calculation method which is able to describe the adhesive behaviour for all conditions (temperature, strain-rates, direction and size of loading) – regardless of ageing. It will turn out if a calculation method based on stresses is still reasonable or a strain based calculation method under consideration of temperature and strain rate is more applicable. Fundamental approaches for a future design concept are addressed in [264].

Nevertheless there are approximate calculations of adhesives based on springs, beddings, analytical models, linear concepts, non-linear material parameters for FEA, etc. which are at present useful to explain the adhesive mechanical behaviour for strongly limited applications (e.g. special temperature ranges, strain-rates, selected loadings and load directions, special components like point-supports [263] or hybrid beams [273], [275], [262]) - but the overall design concept is missing. Here especially the determination of adequate material parameters is part of ongoing research.

These restrictions and lack of knowledge does not at all mean that bonded structures cannot be applied, but each application – even applications according to ETAG 002 – must be treated and checked by experts individually.

#### 8.4.6 Future prospects

In parallel to the on-going research on bonded joints in steel or façade structures a draft of a guidelines regarding fabrication and monitoring of bonded connections in structural glazing has been introduced by the German Professional Association for Structural Glazing (FGK)

and will be continuously developed further and filled with content. This draft has already been adapted to the general form of the European Standards, which is based on the three columns “products”, “design” and “execution”. With an existing European regulation for structural silicone glazing (SSG) according to ETAG 002 [269] the scope of the guidelines draft is emphasized on bonded joints outside existing products rules, see Figure 8-8. Here it is shown that envisaged bonded connections will be classified in eight main categories which allow for a distinct definition of different design cases. In addition safety concepts have to be developed to ensure a reliable design procedure and a durable building structure.

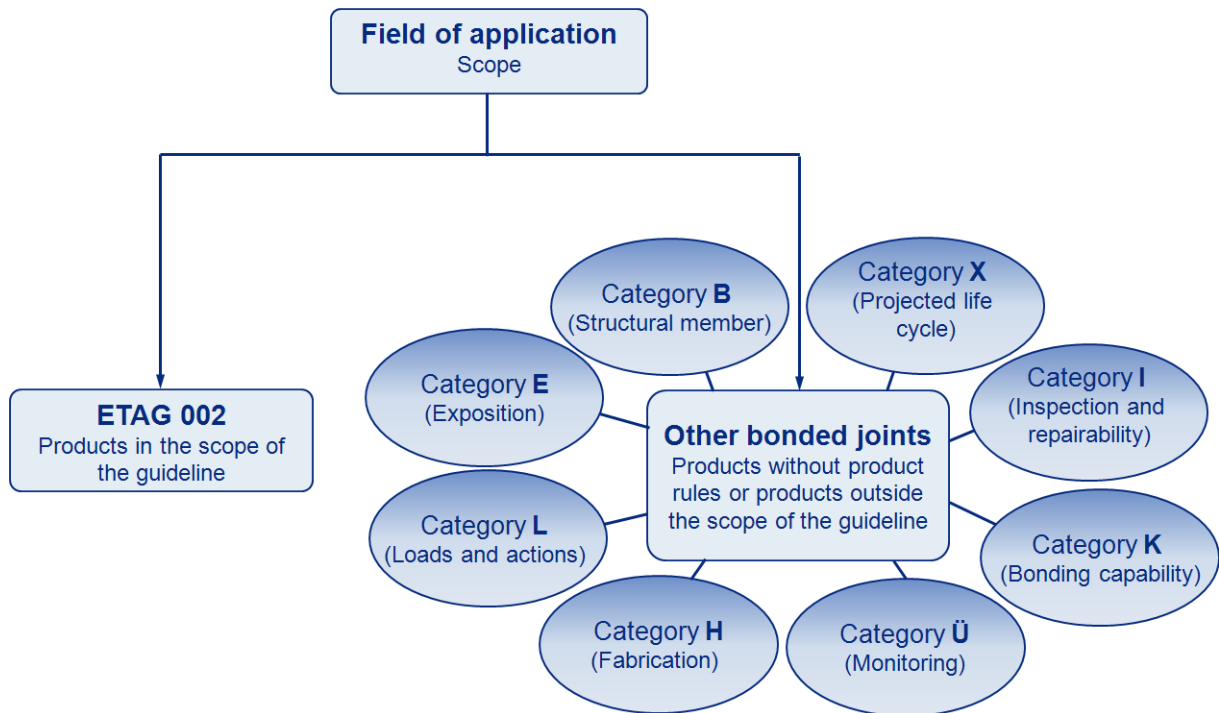


Figure 8-8 Classification of structural bonds

Core of this guidelines draft is a division of structural bonded joints into different connection classes to describe their carrying behaviour clearly and to design them according to the static relevance of the bonded connection. Further the draft guidelines propose a structural classification and the division of bonded connections in continuous and discontinuous joints. Accordingly continuous joints are assemblies or components such as hybrid bonded beams [262] or structural glazing elements [264], that offer due to their plane or distinctive linear bonding geometry or because of their structural integrity a more ductile and redundant behaviour. In opposite discontinuous joints are cross sections, connections or details like point fittings [263] and lap joints, that show a brittle behaviour as a result of their punctual or small bonding surface without structural redundancy.

### Eurocode Outlook No. 41

- (1) *The Eurocode on Structural Glass should provide rules for the design of bonded glass components. The complexity of this matter is considerably high, hence the specific existing standards have to be regarded. In any case the reliability of the used bonding systems has to be verified.*

(2) *The standardization of materials other than silicone seems to be difficult at the moment with regard to ageing effect on adhesives. For structural calculation of rubber-like behaving adhesives especially of silicones, Eurocode should enable a local concept of the estimation of stresses and strains based on polymer mechanics, hyperelastic material laws for silicones and advances ageing methods allowing a lifetime prediction.*

## 9 Concluding Remarks

Compared to other building materials prestressed glass provides a considerably good ratio of strength to self-weight.

To exploit this beneficial characteristic, however, the hurdles appear to be rather high. The reason is the very brittle behaviour of glass that requires special care and attention for design, detailing and erecting. It is always an engineering challenge to design structural glass such that the lack of ductility can be overcome.

Nevertheless engineers succeed more and more in achieving amazing designs and constructions. With the work of engineers and architects the on-going product developments, increasing scientific knowledge and research results as well as the now growing treasure trove of experience lead to more acceptance.

At present, different European countries have developed national codes for rules for the design of structural glass, mostly for secondary elements. The results of these codes differ, e.g. in terms of level of safety, and thus prevent free trading within the EU. Further, despite of the meanwhile large pool of research results for the use of structural glass in primary structures, respective design rules are lacking to a big extent. This hinders the development of sustainable buildings, especially in the very important field of multi-functional facades, contributing crucially to the energetic performance.

Therefore, so far, the development of modern design of structural glass is standing at the crossroads. A common European design code is needed,

- to overcome obstacles of free trading of structural glass elements resulting from different state of the art levels and design approaches,
- to achieve an equalized technical, economical and safety level,
- to enable the further development of a future oriented industrial sector and
- to allow for new sustainable constructions with a significantly improved energetic balance both for the embodied resources as well as for resources needed for use and service.

Thus, in agreement with the European Commission, CEN/TC250 has committed within WG 3 “Structural Glass” to establish the Scientific and Policy Report that shall serve as

- first European guidance for the design of structural glass,
- compilation of the state of the art, scientific knowledge and existing design approaches of structural glass,
- proposal for structure and content of a future Technical Specification of design rules for structural glass and
- prenormative background to a future Technical Specification of design rules for structural glass.

The present Scientific and Policy report, here, is reflecting the existing design approaches, gives a survey on the different explications for the variety of design cases and gives suggestions on structure and content of a future Technical specification of design rules for structural glass. Furthermore it shows the potentials in design of primary structures, already prepared in view of possible codification options.





## 10 References

### Products

- [1] EN 572-1: Glass in building - Basic soda lime silicate products – Definitions and general physical and mechanical properties
- [2] EN 572-2: Glass in building - Basic soda lime silicate products – Float glass
- [3] EN 572-3: Glass in building - Basic soda lime silicate products – Polished wired glass
- [4] EN 572-4: Glass in building - Basic soda lime silicate products – Drawn sheet glass
- [5] EN 572-5: Glass in building - Basic soda lime silicate products – Patterned glass
- [6] EN 572-6: Glass in building - Basic soda lime silicate products – Wired patterned glass
- [7] EN 572-7: Glass in building - Basic soda lime silicate products – Wired or unwired channel shaped glass
- [8] EN 1096: Glass in building - Coated glass
- [9] EN 1279-1: Glass in building – Insulating glass unit
- [10] EN 1863: Glass in building - Heat strengthened soda lime silicate glass
- [11] EN 12150: Glass in building - Thermally toughened soda lime silicate safety glass
- [12] EN 12337: Glass in building – Chemically strengthened soda lime silicate glass
- [13] EN ISO 12543: Glass in building - Laminated glass and laminated safety glass
- [14] EN 14179: Glass in building - Heat soaked thermally toughened soda lime silicate safety glass
- [15] prEN 15683: Glass in building – Thermally toughened soda lime silicate channel shaped glass
- [16] EN 357: Glass in building - Fire resistant glazed elements with transparent or translucent glass products - Classification of fire resistance
- [17] ASTM C 1036 Specification for Flat Glass
- [18] ASTM C 1048 Specification for Heat Treated Flat Glass – Kind HS, Kind FT Coated and Uncoated Glass
- [19] ASTM C 1172 Specification for Laminated Architectural Flat Glass

### Test Standards

- [20] EN ISO 1288: Glass in building – Determination of the bending strength of glass
- [21] EN 12600: Glass in building – Pendulum test – Impact test method and classification for flat glass
- [22] prEN 16613: Glass in building – Laminated glass and laminated safety glass – Determination of the interlayer mechanical properties testing
- [23] EN 356: Glass in building - Security glazing – Testing and classification of resistance against manual attack
- [24] EN 1063: Glass in building - Security glazing – Testing and classification of resistance against bullet attack
- [25] EN 13541: Glass in building - Security glazing - Testing and classification of resistance against explosion pressure
- [26] EN 13123: Windows, doors and shutters - Explosion resistance - Requirements and classification
- [27] EN 13124: Windows, doors and shutters - Explosion resistance

- [28] ISO 16933: Glass in building – Explosion resistant security glazing - Test and classification for arena air blast loading
- [29] EN IEC 61646: Thin-film terrestrial photovoltaic (PV) modules - Design qualification and type approval
- [30] EN IEC 61215: Crystalline silicon terrestrial photovoltaic (PV) modules – Design qualification and type approval
- [31] EN IEC 61730-1: Photovoltaic (PV) module safety qualification – Part 1: Requirements for construction
- [32] EN IEC 61730-2: Photovoltaic (PV) module safety qualification – Part 2: Requirements for testing
- [33] ISO 16933:2007 Glass in building - Explosion-resistant security glazing – Test and classification for arena air-blast loading
- [34] US General Services Administration: GSA-TS01-2003: Standard Test Method for Glazing and Window Systems, Subject to Dynamic Overpressure Loadings, 2003
- [35] EN 12512:2001. Timber structures - Test methods – Cyclic Testing of Joints made with Mechanical Fasteners
- [36] ISO 16670:2003. International Standard, Timber structures – Joints Made with Mechanical Fasteners – Quasi-Static Reversed-Cyclic Test Method. First edition 2003-12-15.

#### Design Standards / Technical recommendations

- [37] prEN 16612: Glass in building – Determination of the load resistance of glass panes by calculation and testing (NA 005-09-25 AA N 870, CEN/TC129/WG8 – N312)
- [38] EN 1990: Eurocode – Basis of structural design
- [39] EN 1991: Eurocode 1 – Actions on structures
- [40] EN 1993: Eurocode 3 – Design of steel structures
- [41] EN 1995: Eurocode 5 – Design of timber structures
- [42] EN 1994: Eurocode 4 – Design of composite steel and concrete structures
- [43] EN 1998: Eurocode 8 – Design of structures for earthquake resistance
- [44] DIN 18008: Glass in building - Design and constructions rules
  - Part 1: Terms and general bases
  - Part 2: Linearly supported glazing
  - Part 2: Linearly supported glazing, correction of DIN 18008-2
  - Part 3: Point fixed glazing
  - Part 4: Additional requirements for anti-drop device
  - Part 5: Additional requirements for accessible glazing
  - Part 6: Additional requirements for glazing
- [45] NEN 2608: Glass in building - Requirements and determination method
- [46] DIBt: Technische Regeln für die Verwendung von linienförmig gelagerten Verglasungen (2006)
- [47] Bauregelliste A, Bauregelliste B und Liste C - Ausgabe 2010/1. DIBt Mitteilungen Sonderheft Nr. 39 vom 30. Juni 2010, Verlag Ernst & Sohn, Berlin 2010.
- [48] ÖNORM B 3716: Glass in building – Structural glass construction
  - Part 1: Basic principles
  - Part 2: Linear glazing's
  - Part 3: Fall protection glazing's
  - Part 4: Accessible, walkable and trafficable glazing's
  - Part 5: Point fixed glazing and special structures
- [49] prNBN S23-002: Verre dans la construction - Vitrierie – Calcul des épaisseurs de verre

- [50] DIN 18516-4: Cladding for external walls, ventilated at rear - Tempered safety glass, requirements, design, testing
- [51] Draft for prEN (no number): Glass in building – Thermal stress calculation method (NA 005-09-25 AA N 854, CEN/TC129/WG8 – N1326)
- [52] ASTM E1300 -12ae1 Standard Practise for Determining Load Resistance of Glass Buildings
- [53] ASTM E2431-06: Determining the Resistance of Single Glazed Annealed Architectural Flat Glass to Thermal Loadings
- [54] BS 5516: Patent glazing and sloping glazing for buildings
- [55] CNR-DT-210: CNR-DT 210/2012 Istruzioni per la Progettazione, l'Esecuzione ed il Controllo di Costruzioni con Elementi Strutturali di Vetro
- [56] UNI 7143 (1972); Vetri piani. Spessore dei vetri piani per vetrazioni in funzione delle loro dimensioni, dell'azione del vento e del carico neve.
- [57] UNI/TR 11463. Vetro per edilizia. Determinazione della capacità portante di lastre di vetro piano applicate come elementi facenti funzione di tamponamento. Procedura di calcolo
- [58] DIN VDE 0126-21: Photovoltaic in building (draft)
- [59] NF DTU 39 P3: building works - glazing and mirror-glass works - part 3 : calculation memorandum for thermal stress travaux de bâtiment. travaux de miroiterie-vitrierie. partie 3 : mento calculs des contraintes thermiques
- [60] BS 6262: Glazing for buildings
- [61] BS 6180: Barriers in and about buildings
- [62] CWCT TN 66: Safety and fragility of glazes roofing: guidance on specification
- [63] CWCT TN 67: Safety and fragility of glazed roofing: testing and assessment
- [64] CWCT TN 92: Safety method for assessing glazing in class 2 roofs
- [65] CSN 74 3305: Safety balustrades
- [66] AS 1288:1989 Glass in buildings
- [67] Cahier CSTB 3488-V2: Vitrages extérieurs collés
- [68] Cahier CSTB 3574: Vitrages extérieurs attachés (VEA) faisant l'objet d'un Avis Techniques
- [69] Cahier CSTB 3034: Garde-corps non traditionnels en produits verriers encastré en pied
- [70] Cahier CSTB 3448: Dalle de planchers er marches d'escalier en verre
- [71] Fiche Technique No. 47: Règles d'équivalences pour l'utilisation possible du Double Pneu pour les chocs de sécurité à la place du M50
- [72] Proposition de fiche (CSTB et SNFA): Disposition applicables aux facades légères en zones sismique
- [73] US General Services Administration: Security Design Criteria. 2001. General Services Administration (GSA), Interagency Security Committee (ISC) (for official use only).

#### Technical approvals

- [74] Allgemeine bauaufsichtliche Zulassung (abZ) Nr. Z-70.4-43: Pilkington Profilit
- [75] Allgemeine bauaufsichtliche Zulassung (abZ) Nr. Z-70.4-44: Lamberts Linit
- [76] Allgemeine bauaufsichtliche Zulassung (abZ) Nr. Z-70.4-165: SGT extra safe
- [77] Allgemeine bauaufsichtliche Zulassung (abZ) Nr. Z-70.3-170: Verbundsicherheitsglas aus SentryGlas 5000 mit Schubverbund

- [78] Verzeichnis der allgemeinen bauaufsichtlichen Zulassungen. DIBt, Stand: 19. April 2011.
- [79] Allgemeine bauaufsichtliche Zulassung (abZ) Nr. Z-70.2-122: Punktgehaltene Verglasung mit fischer Zykon Punkthaltern (FZP-G-Z)

### Construction Rules

- [80] DIN 18 545: Sealing of glazings with sealant
- [81] Technische Richtlinien des Glaserhandwerks Nr. 1 bis 20. Verlagsanstalt Handwerk GmbH
- [82] EN 13022-1: Glass in building – Structural sealant glazing. Glass products for structural glazing systems for supported and unsupported monolithic and multiple glazing
- [83] EN 13022-2: Glass in building – Structural sealant glazing. Assembly rules.
- [84] EN 15434: Glass in building – Product standard for structural and/or ultra-violet resistant sealant (for use with structural sealant glazing and/or insulating glass units with exposed seals)
- [85] prEn 12488: Glass in building – Glazing recommendations – Assembly principles for vertical and sloping glazing

### Journal papers, Research references and Background documents

- [86] Pilkington: Glass&Thermal Safety, 1982.
- [87] FIV: Evaluation des contraintes thermiques dans les vitrages, 1997.
- [88] Zarnic, R.; Tsionis, G.; Gutierrez, E.; Pinto, M.; Geradin, M.; Dimova, S.: Purpose and justification for new design standards regarding the use of glass products in civil engineering works. JRC Scientific and Technical Report 2007.
- [89] Foraboschi, P.; Interlandi, M.: Architettura di vetro. Progettare con il vetro. GALILEO IXX-177, pp. 24-26, 2006.
- [90] Royer-Carfagni, G.; Silvestri, M.: A proposal for an arch footbridge in Venice made of structural glass masonry. Engineering Structures 29(11), pp. 3015-3025, 2007.
- [91] Sedlacek, G; Blank, G.; Laufs, W.; GÜsgen, J.: Glas im konstruktiven Ingenieurbau. Ernst & Sohn Bauingenieur-Praxis, 1999.
- [92] Haldimann, M.; Luible, A.; Overend, M.: Structural Use of Glass SED 10, 2008.
- [93] EU COST C13 Final Report: Glass & Interactive Building Envelopes. Research in Architectural Engineering Series, Volume 1, 2007.
- [94] Feldmann, M.; Kasper, R.; Langosch, K.: Glas für tragende Bauteile. Werner Verlag 2012.
- [95] Aielli, M.; Gnappi, G.; Montenero, A.; Royer Carfagni, G.; Sglavo, V.: Mechanical properties of P2O5-PbO-ZnO glasses. 7th European Society of Glass Science and Technology (ESG) Conference, April 25-28 2004, Athens (GR).
- [96] Sglavo, V.M.; Montenero, A.; Aielli, M.; Gnappi, G.; Lorenzi, A.; Royer Carfagni, G.: 2005. Mechanical properties of PbO-ZnO-P2O5 glasses. Physics and chemistry of glasses - European Journal of Glass Science and Technology Part B 46(5), pp. 538-554.
- [97] Johnson, N.F.: International Standards for Blast Resistant Glazing, Journal of ASTM International, 3(4):1–16, 2006 April.
- [98] Krauthammer, T. & Altenberg, A. 2000. Negative phase blast effects on glass panels. International Journal of Impact Engineering, 24(1):1–17, January.

- [99] Teich, M. & Gebbeken, N. 2010. The Influence of the Underpressure Phase on the Dynamic Response of Structures Subjected to Blast Loads, *International Journal of Protective Structures*, 1(2):219–233.
- [100] Foraboschi, P.: Glass and bending action. Proceedings of the Glass Performance Days, June 12-15 2009, Tampere (FI).
- [101] Ferretti, D.; Rossi, M.; Royer-Carfagni, G.: The plasticity of glass, Proceedings XXV A.T.I.V. International conference - Glass: when technology meets design, November 18-19 2010, Parma (I).
- [102] Beatini, V., Royer-Carfagni, G., 2011. Glass as material, *Materia*, 69, pp.36-43.
- [103] Ferretti, D.; Rossi, M.; Royer-Carfagni, G.: An ESPI Experimental Study on the Phenomenon of Fracture in Glass. Is it brittle or Plastic? *Journal of the mechanics and physics of solids*, 59, pp. 1338-1354, 2011.
- [104] Blank, K.: Verfahren zur Festigkeitssteigerung. In: Fortbildungskurs „Festigkeit von Glas“ HVG, 1987.
- [105] GÜSGEN, J.: Bemessung tragender Bauteile aus Glas, Schriftenreihe Stahlbau - RWTH Aachen, No. 42, Shaker Verlag, Germany, 1998.
- [106] Gehrke, E.; Ullner, Chr.; Hähnert, M.: Effect of Corrosive media on crack growth of model glasses and commercial silicate glasses. *Glastechnische Berichte* 63 (1990) No. 9, pp. 225-265.
- [107] Wiederhorn, S.M.: Influence of water on crack propagation in soda-lime glass. *J.Am.Ceram.Soc.* 50 /1967), pp. 407-414.
- [108] Mellmann, G.; Maultzsch, M.: Untersuchung zur Ermittlung der Biegefestigkeit von Flachglas für bauliche Anlagen. BAM-Forschungsbericht 161, Berlin, 1989.
- [109] Blank, K.: Thermisch vorgespanntes Glas. Part 1: *Glastech. Ber.* 52 (1979) No. 1, pp. 1-13 and Part 2: *Glastech. Ber.* 52 (1979) No. 2, pp. 51-54.
- [110] Ferry, J.D. 1980. *Viscoelastic properties of polymers*. New York: John Wiley & Sons
- [111] Bordeaux, F.; Kasper, A.: Reliable and shorter Heat Soak Test to avoid spontaneous fracture of heat strengthened and tempered glasses. *Glass Processing Days* 1997.
- [112] Bordeaux, F.; Kasper, A.: Optimised Heat Soak Test to eliminate dangerous Nickel Sulfide Stones in heat strengthened and tempered glasses. ESG annual meeting 1997 Växjö/ Sweden.
- [113] Kasper, A.: Advances in Testing Tempered Glasses in Heat Soak Ovens. *Glass Processing Days* 1999 pp.71-75.
- [114] Kasper, A.: Safety of Heat Soaked Thermally Toughened Glass: How Exactly Must the Standard Conditions of Heat Soak Process be Complied with? *Glass Processing Days* 2003 pp. 670-672.
- [115] Kasper, A.: Fundamentals of Spontaneous Breakage Mechanism Caused by Nickel Sulfide. *Glass Processing Days* 2003 pp. 696-698.
- [116] Schneider J., Hilcken J. (2010) Nickel Sulphide (NiS-) induced failure of glass: fracture mechanics model and verification by fracture data. (engineered transparency), International Conference at glasstec, proceedings, Düsseldorf, Germany, 29. – 30.09.2010, pp. 125-136.
- [117] Laufs, W.: Ein Bemessungskonzept zur Festigkeit thermisch vorgespannter Gläser. Dissertation, Lehrstuhl für Stahlbau, RWTH Aachen, Shaker Verlag, No. 45, 2000.
- [118] Wellershoff, F.; Pohl, M.: Snow load collectives and design shear moduli for laminated safety glass, COST Action TU0905, Mid-Term Conference Proceedings, pp. 367-376, 2013.

- [119] Wellershoff, F.; Lori, G.; Zobec, M.; Osterland, K.: Structural design of blast enhanced cable net facades, COST Action TU0905, Mid-Term Conference Proceedings, pp. 121-132, 2013.
- [120] Wellershoff, F.: Blast enhanced facades, TU Delft Conference: Challenging Glass III, 2012, Proceedings, pp. 981-996.
- [121] Wellershoff, F., Teich, M.; Nehring, G.; Gebbeken, N.: Konstruktion und Berechnung von explosionshemmenden Seilnetzfassaden, Stahlbau 81 (2012), No 1, pp. 13-25
- [122] Wellershoff, F.: Blast enhanced cable facades, Intelligent Glass Solutions 6-2011, pp. 50–54.
- [123] Wellershoff, F.: Blast enhanced facades for the new World Trade Centre Towers NY, Challenging Glass Conference Proceedings, pp. 643–653, 2008.
- [124] Schneider, J.: Festigkeit und Bemessung punktgelagerter Gläser und stoßbeanspruchter Gläser. Dissertation, Institut für Statik, TU Darmstadt, 2001.
- [125] Hagl, A.; Wolf, A.T.; SITTE, S.: Investigation of Stress-Whitening in Transparent Structural Silicon Adhesive. Proceedings of the Challenging Glass 3, Delft 2012.
- [126] Santarsiero, M.; Louter, C.; Lebet, J-P.: Parametric numerical investigation of adhesive laminated point connections. COST Action TU0905, Mid-term Conference on Structural Glass, Porec, Croatia, April 18-19, 2013.
- [127] Cruz, P.J.S.; Carvalho, P.L.L. ; Silva, E. ; Casal, C.: Embedded glass fixing system, Engineered Transparency - International Conference at Glasstec, Düsseldorf, Germany, September 29-30, pp. 213-220, 2010.
- [128] Cruz, P.J.S.; Carvalho, P.L.L. ; Silva, E. ; Casal, C.: Análise experimental de um sistema metálico de fixação de fachadas agrafadas, VIII Congresso de Construção Metálica e Mista, Guimarães, 24 a 25 de Novembro, pp. II-287-293, 2011.
- [129] Bucak, Ö.: Tragverhalten von gebogenen Glasscheiben im Bauwesen. FH<sup>3</sup>, Hochschule München, 2009.
- [130] Bucak, Ö.; Feldmann, M.; Kasper, R.; Bues, M.; Illguth, M.: Das Bauprodukt warm gebogenes Glas – Prüfverfahren, Festigkeiten und Qualitätssicherung. 3/2009 Stahlbau Spezial 2009 – Konstruktiver Glasbau Ernst & Sohn, Berlin pp. 23-28.
- [131] Wörner, J.; Schneider, J.: Abschlussbericht zur experimentellen und rechnerischen Bestimmung der dynamischen Belastung von Verglasungen durch weichen Stoß. Forschungsbericht, Deutsches Institut für Bautechnik (DIBt). Darmstadt 2000.
- [132] Schneider, J.; Bohmann, D.: Glasscheiben unter Stoßbelastung - Experimentelle und theoretische Untersuchungen für absturzsichernde Verglasungen bei weichem Stoß. Bauingenieur 77 (2002), pp. 581-592.
- [133] Schneider, J.; Burmeister, A.; Schula, S.: Zwei Verfahren zum rechnerischen Nachweis der dynamischen Beanspruchung von Verglasungen durch weichen Stoß. Teil 1: Numerische, transiente Simulationsberechnung und vereinfachtes Verfahren mit statischen Ersatzlasten. Stahlbau Spezial 2011 – Glasbau/Glass in Building pp. 81-87. Ernst & Sohn 2011.
- [134] Weller, B.; Reich, S.; Krampe, P.: Zwei Verfahren zum rechnerischen Nachweis der dynamischen Beanspruchung von Verglasungen durch weichen Stoß. Teil 2: Numerische Vergleichsrechnungen und experimentelle Verifikation. Stahlbau Spezial 2011 – Glasbau/Glass in Building pp. 81-87. Ernst & Sohn 2011.
- [135] Belis J.: Kipsterkte van monolitische en gelamineerde glazen liggers. Dissertation. Ghent, Ghent University; 2005.
- [136] Holberndt, T.: Entwicklung eines Bemessungskonzeptes für den Nachweis von stabilitätsgefährdeten Glasträgern unter Biegebeanspruchung. Dissertation, TU Berlin, 2006.

- [137] Cossavella, M.; Panait, A.: Dimensionnement au déversement des raidisseurs et poutres en verre. CSTB 2008.
- [138] DAST-Forschungsbericht Nr. 2/03: Experimentelle und analytische Untersuchungen an neuartigen Stahl-Glas-Verbindungen im Hinblick auf die Normung, AIF-Forschungsvorhaben Nr. 12697/N, 2003.
- [139] Sedlacek, G., Kasper, R.: Bemessungskonzept für punktförmig gelagerte Scheiben, 8. Forschungsvorhaben für den FKG, Lehrstuhl für Stahlbau RWTH Aachen 2004, unveröffentlicht; Bericht FKG.
- [140] Wolf, H.: Experimentelle und numerische Untersuchung von punktförmig gehaltenen Glasscheiben im Hinblick auf ein Bemessungskonzept, Diplomarbeit am Lehrstuhl für Stahlbau, RWTH Aachen 2004.
- [141] Kasper, R.: Berechnungskonzept für die Bemessung von punktförmig gelagerten Glasscheiben. Stahlbau 6 pp. 454-461. Ernst & Sohn 2006.
- [142] Siebert, B.: Beitrag zur Berechnung von punktgehaltenen Gläsern. Dissertation 2004. TU München.
- [143] Albert, N.: Lastabtragungsmechanismus im Lochbereich punktgestützter Glastafeln. Dissertation 2004. TU Karlsruhe.
- [144] Beyer J.: Ein Beitrag zum Bemessungskonzept für punktgestützte Glastafeln. Dissertation 2007. TU Darmstadt.
- [145] Feldmeier, F.: Zur klimatischen Belastung von Isolierglas bei nicht trivialer Geometrie. VDI Berichte Nr. 1527 (2000), pp. 185-201.
- [146] Feldmeier, F.: Klimabelastung und Lastverteilung bei Mehrscheiben-Isolierglas. Stahlbau 75 (2006) No. 6, pp. 467-478.
- [147] Feldmeier, F.: Bemessung von Dreifach-Isolierglas. Stahlbau Spezial 2011 – Glasbau/Glass in Building (2011), pp. 75-80.
- [148] Feldmeier, F.: Insulating Units Exposed to Wind and weather – Load sharing and Internal Loads. Glass processing days 2003.
- [149] Feldmeier, F.: Zur Berücksichtigung der Klimabelastung bei der Bemessung von Isolierglas bei Überkopfverglasungen. Stahlbau 65 (1996), No. 8.
- [150] Wellershoff, F.: Nutzung der Verglasung zur Aussteifung von Gebäuden. Doctoral thesis, RWTH Aachen University, Issue 57, 2006.
- [151] Wellershoff, F.: Aussteifung von Gebäudehüllen durch randverklebte Glasscheiben, Stahlbau 77 (2008), No. 1, pp. 5-16.
- [152] Wellershoff, F.: Aussteifung von Gebäudehüllen durch eckgeklotzte Glasscheiben, Stahlbau 77 (2008), No. 8, pp. 555-565.
- [153] Neumann, L.; Arnold, A.; Hochhauser, W.: Zur Stabilität von geklebten und geklotzten Glasscheiben: Beurteilung der Dunkerley'schen Geraden zur Beulwertbestimmung. Bauingenieur No. 88, Januar 2013.
- [154] Foraboschi, P.: Behaviour and Failure Strength of Laminated Glass Beams. ASCE – Journal of Engineering Mechanics 133(12), pp. 1290-1301, 2007.
- [155] Briccoli Bati, S.; Fagone, M.; Ranocchiali, G.; Romoli, L.: The influence of the interlayer on the behaviour of laminated glass in the serviceability domain. Proceedings of the Glass Performance Days, June 12-15 2009, Tampere (FI).
- [156] Galuppi, L.; Royer-Carfagni, G.: Viscoelastic Characterization of Laminated Glass. Engineered Transparency. International Conference at glasstec, Düsseldorf (Germany), October 25-26 2012.

- [157] Briccoli Bati, S.; Reale, C.; Ranocchiali, G.; Rovero, L.: Time dependent behaviour of laminated glass. *Journal of Materials in Civil Engineering*, ASCE 22(4), pp. 389-396, 2010.
- [158] Androozzi, L.; Briccoli Bati, S.; Fagone, M.; Ranocchiali, G.: Dynamic tests on laminated glass specimens. *Proceedings XXXV A.T.I.V. International conference*, November 18-19 2010, Parma (I).
- [159] Schuler, Ch.: Einfluss des Materialverhaltens von Polyvinylbutyral auf das Tragverhalten von Verbundsicherheitsglas in Abhängigkeit von Temperatur und Belastung. *Berichte aus dem Konstruktiven Ingenieurbau*. Dissertation TU München 3/2003.
- [160] Sackmann, V.: Untersuchung der Dauerhaftigkeit des Schubverbunds in Verbundsicherheitsglas mit unterschiedlichen Folien aus Polyvinylbutyral. Dissertation TU München 2008.
- [161] Ensslen, F.: Zum Tragverhalten von Verbund-Sicherheitsglas unter Berücksichtigung der Alterung der Polyvinylbutyral-Folie. Dissertation 2005, Ruhr-Universität Bochum.
- [162] Van Duser, A.; Jagota, A.; Bennison S.: Analysis of Glass/Polyvinyl Butyral Laminates subjected to uniform pressure. *Journal of Engineering Mechanics*, April 1999.
- [163] Sobek, W.; Kutterer, M.; Messmer, R.: Bauen mit Glas- Rheologisches Verhalten von PVB im Schubverbund. *Forschungsbericht 4/98*, Universität Stuttgart, Institut für leichte Flächentragwerke, April 1998.
- [164] Wellershoff, F.: Bemessungsschubmodulwerte für Verbundglasscheiben, *Stahlbau 76* (2007) No. 3, pp. 177-188.
- [165] Völling, B.: Analytische Berechnung von Sandwichtragwerken mit Hilfe von Eigenspannungslösungen. Doctoral thesis, RWTH Aachen University, 2007.
- [166] Kasper, R.: Tragverhalten von Glasträgern. Doctoral thesis, RWTH Aachen University, Issue 55, 2005.
- [167] Kasper, R.; Sedlacek, G.; Feldmann, M.: Das Biegedrillknicken von Glasträgern aus Verbundglas. *Stahlbau 76* (2007), No. 3, pp. 167-176.
- [168] Kutterer, M. Verbundglasplatten – Näherungslösungen zur Berücksichtigung von Schubverbund und Membranwirkung. Dissertation, Universität Stuttgart, 2003.
- [169] Callewaert D.: *Stiffness of Glass/Ionomer Laminates in Structural Applications*, Dissertation Ghent University, December 2011.
- [170] Sedlacek, G.; Wellershoff, F.: Anwendungsvorschlag zur Bemessung von Verbundsicherheitsglas. Gutachterliche Beurteilung, Bericht G 2003/10-05, Lehrstuhl für Stahlbau, RWTH Aachen, 2003.
- [171] Kruijs, R.: *Designing a Glass Bearing Connection with a Probability to EN 1990 CC2*. Challenging Glass 3, Delft University 2012.
- [172] Hake, E.; Meskouris, K.: *Statik der Flächentragwerke*. 2. korr. Auflage Springer 2007.
- [173] Timoshenko, S; Woinowski-Krieger, S.: *Theory of Plates and Shells*. 2. Auflage, New York, London, Tokyo, McGraw-Hill 1959.
- [174] Marcus, H.: Die vereinfachte Berechnung biegsamer Platten. Teil 1: *Der Bauingenieur* 1924, No. 20, pp. 660-666. Teil 2: *Der Bauingenieur* 1924, No. 21, pp. 702-711.
- [175] Czerny, F.: Tafeln für Rechteckplatten. In *Betonkalender 1996*, Ernst & Sohn, Berlin p. 277.
- [176] Stiglat, K.; Wippel, W.: *Platten*. Ernst & Sohn, Berlin, 3. Auflage 1983.
- [177] [www.sj-mepla.com](http://www.sj-mepla.com)
- [178] Kott, A. and Vogel, T., 2004. Controlling the post-breakage behaviour of laminated safety glass, *Proceedings International Symposium on the Application of Architectural Glass*, Munich.



- [179] Galuppi, L.; Manara, G.; Royer-Carfagni, G.: Practical expressions for the design of laminated glass. *Composites Part B: Engineering* 45, pp. 1677–1688, 2013.
- [180] Galuppi, L.; Royer-Carfagni, G.; Manara, G.: Enhanced effective thickness method for laminated glass. A case study. XXVII A.T.I.V. International Conference - From a grain of sand to the strength of a structure, Parma (Italy), November 15-16 2012.
- [181] Galuppi, L.; Royer-Carfagni, G.: New Expression for the Effective Thickness of Laminated Glass. *Challenging Glass 3 - International Conference on the Architectural and Structural Applications of Glass*, June 28- 29 2012, TU Delft (NL).
- [182] Galuppi, L.; Royer-Carfagni, G.: The effective thickness of laminated glass plates. *Journal of Mechanics of Materials and Structures*. 7(4), pp. 375-400, 2012.
- [183] Foraboschi, P.: Analytical model for laminated-glass plate. *Composites Part B: Engineering* 43, pp. 2094-2106, 2012.
- [184] Foraboschi, P.: Three-layered sandwich plate: Exact mathematical model. *Composites Part B: Engineering* 45, pp. 1601-1612, 2012.
- [185] Foraboschi, P.: Analytical Solution of Two-Layer Beam Taking into Account Non Linear Interlayer Slip. *ASCE – Journal of Engineering Mechanics* 135(10), pp. 1129- 1146, 2009.
- [186] Louter C. *Fragile yet Ductile – Structural aspects of reinforced glass beams*. Dissertation TU Delft, ISBN: 978-90-8570-743-1, April 2011.
- [187] Louter, C.; Belis, J.; Veer, FA.; Lebet, J-P.; Durability of SG-laminated reinforced glass beams: effects of temperature, thermal cycling, humidity and load-duration. *Con. Build. Mat.* 2012; 27(1): pp. 280–292.
- [188] Belis, J.; Mocibob, D.; Luible, A.; Vanderbroek, M.: On the size and shape of initial out-of-plane curvatures in structural glass components, in *Construction and Building Materials*, vol. 25, no. 5, pp. 2700-2712, 2011.
- [189] Ølgaard, AB.; Nielsen, JH.; Olesen, JF.: Design of Mechanically Reinforced Glass Beams – Modelling and Experiments. *Structural Engineering International*, 2/2009, pg. 130-136, 2009.
- [190] Weller, B.; Krampe, P.; Retsch, S.: Further Research About the Short and Long-Term Breakage Behaviour of Hybrid Glass-Steel Elements. in the *Proceedings of Challenging Glass 3*, 2012, pp. 769-782.
- [191] Belis, J.; Callewaert, D.; Delincé, D.; Van Impe, R.: Experimental failure investigation of a hybrid glass/steel beam. *Eng Fail Anal* 2009; pp. 63–73.
- [192] Antolinc, D.; Žarnić, R.; Stepinac, M.; Rajčić, V.; Krstevska, L.; Tashkov, L.: Simulation of earthquake load imposed on timber-glass composite shear wall panel. *COST Action TU0905, Mid-term Conference on Structural Glass – Belis, Louter & Mocibob (Eds)*, 2013 Taylor & Francis Group, London, ISBN 978-1-138-00044-5, pp. 245-252.
- [193] Rajčić, V., Žarnić, R.: Racking Performance of Wood-Framed Glass Panels. Ed. Quenneville, P., *World conference on timber engineering*, Auckland, New Zealand, 15-19 July 2012. *WCTE 2012: The Future of Timber Engineering Final Papers*. Auckland: WCTE, 2012, pp. 57-62.
- [194] Rajčić, V., Žarnić, R.: Seismic response of timber frames with laminated glass infill. *CIB-W18: Meeting forty-five, Växjö, Sweden, August 2012*, (Meeting of the International Council for Research and Innovation in Building and Construction, W18, Timber structures). Karlsruhe: *Ingenieurholzbau und Baukonstruktionen*, 2012, pp. 1-10.
- [195] CROATIAN NATIONAL SCIENTIFIC PROJECT Nr. 082-1491823-1463, „Composite structural systems wood-structural glass and wood-steel”, financed by Ministry of

- Science, Education and Sport of Croatia, 2007. – 2013, coordinator Vlatka Rajčić, University of Zagreb.
- [196] SLOVENIAN NATIONAL RESEARCH PROGRAM P2-0182, Earthquake Engineering (2009-2014) financed by Ministry of Education, Science and Sport of Slovenia, coordinator Peter Fajfar.
- [197] THE YOUNG RESEARCHER GRANT (contract no. 261408-1/2008, Slovenian Research Agency), grantee: Ph.D. candidate David Antolinc, supervisor Roko Žarnić.
- [198] BILATERAL SCIENTIFIC PROJECT CROATIA - MACEDOONIA: (Institute of Earthquake Engineering and Engineering Seismology, IZIS, Skopje and Faculty of Civil Engineering University of Zagreb: Seismic resistance of composite structural systems timber-structural glass with optimal energy dissipation. coordinators: Prof. Lidija Krstevska and prof. Vlatka Rajčić, 2010-2011, financed by Ministry of Science and Education of Croatia and Macedonia.
- [199] Krstevska, L., Tashkov, L., Rajčić, V., Žarnić, R. Shaking Table Test of Innovative Composite Panel Composed of Glued Laminated Wood and Bearing Glass. Proc. of the 15th World Conference on Earthquake Engineering: 24 to 28 Sep. 2012, Lisbon, International Association for Earthquake Engineering, 2012, pp. 1-10.
- [200] Žarnić, R., Rajčić, V., Krstevska, L., Taškov, L., Stepinac, M., Antolinc, D.: Development of seismic resistant wooden frames with laminated glass infill. International Conference Marking 60 Years of Operation of DIMK Research in the Field of Building Materials and Structures, Belgrade, October 19, 2012 Proceedings. Society for Materials and Structures Testing of Serbia, 2012, pp. 215-226.
- [201] Antolinc, D., Rajčić V., Žarnić R.: Analysis of hysteretic response of glass infilled wooden frames. (to be published in Journal of Civil Engineering and Management in 2014) 10 pages.
- [202] Krawinkler, H. (1999). Loading History Issues in Testing for Seismic Performance Assessment. Proceedings of the Invitational Workshop on Seismic Testing, Analysis and Design of Woodframe Construction, CUREE Publication No. W-01.
- [203] ATC - Applied Technology Council. (1994). Tests of Narrow Plywood Shear-Wall Panels. Redwood City, CA: Applied Technology Council.
- [204] Ber, B.; Premrov, M.; Štrukelj, A.; Kuhta M.: Experimental study of timber-glass composite wall elements. COST Action TU0905, Mid-term Conference on Structural Glass – Belis, Louter & Mocibob (Eds), 2013 Taylor & Francis Group, London, ISBN 978-1-138-00044-5, pp. 253-260.
- [205] Palumbo, D.; Palumbo, M.; Mazzuchelli, M.: A new roof for the XIIIth century “Loggia de Vicari” (Arquà Petrarca – PD – Italy) based on structural glass trusses: a case study. In: Conference proceedings. Glass processing days. Tamglass Ltd. (Oy): Tampere; 2005. pp. 434–435.
- [206] Brodin, S.: Experimentelle und numerische Untersuchung zu einem neuen Hinterschnitt-Dübelsystem für punktgehaltene Stahl-Glas-Konstruktionen. Lehrstuhl für Stahlbau, RWTH Aachen 2001.
- [207] Wellershoff, F.; Sedlacek, G.; Kasper, R.: Design of joint, members and hybrid elements for glass structures. ISAAG Conference Proceedings 2004.
- [208] Sedlacek, G.; Wellershoff, F.; Kasper, R.: Basis of design and codes for glass structures. Intelligent Publication Limited, Intelligent Glass Solutions, Issue 1-2004, pp. 47-49.
- [209] Cruz, P.J.; S., Pequeno, J.; Lebet, J.P.; Mocibob, D.: Mechanical modelling of in-plane loaded glass panes, Challenging Glass 2 (2010), Conference on Architectural and Structural Applications of Glass, Faculty of Architecture, TU Delft, May 20-21.

- [210] Foraboschi, P.: Laminated glass column. *The structural Engineer* 87 (18), pp. 20-26, 2009.
- [211] Briccoli Bati, S.; Fagone, M.; Ranocchiali, G.: Analysis of the post-crack behaviour of a laminated glass beam. *Proceedings of the Glass Performance Days, June 12-15 2009, Tampere (FI)*.
- [212] Foraboschi, P.: Compression use of structural glass and glass structures. *Proceedings of the Glass Performance Days, June 12-15 2009, Tampere (FI)*.
- [213] Royer-Carfagni, G.: The recommendations CNR-DT210. *Towards an Italian structural code for glass in buildings, Structural*, 2012.
- [214] Royer-Carfagni, G.; Silvestri, M.: Back to future: a structural glass masonry. *Mechanical performance of glass under compression. Proceedings of the Glass Performance Days, June 12-15 2009, Tampere (FI)*.
- [215] Amadio, C.; Bedon, C.: Buckling of laminated glass elements in out-of-plane bending. *Engineering Structures*, 32(11), pp. 3780-3788, 2010.
- [216] Wellershoff, F., Sendelbach, M.; Schmitt, F.: Glass Columns and Glass Beams – Projects of 2010. *engineered transparency at glastec 2010. Conference Proceedings*, pp. 349- 357.
- [217] Foraboschi, P.: Buckling of glass columns: analytical models and experimental validation. *Proceedings XXXV A.T.I.V. International conference, November 18-19 2010, Parma (I)*.
- [218] Amadio, C.; Bedon, C.: Buckling of laminated glass elements in compression. *Journal of Structural Engineering* 137(8), pp. 803-810, 2011.
- [219] Amadio, C.; Bedon, C.: Buckling verification of laminated glass elements in compression. *Journal of Civil Engineering Science* 1(3), pp. 90-101, 2012.
- [220] Bedon, C., Amadio, C.: Buckling of flat laminated glass panels under in-plane compression or shear. *Engineering Structures* 36, pp. 185-197, 2012.
- [221] Galuppi, L.; Royer-Carfagni, G.: Effective thickness of laminated glass beam. *New expression via variational approach. Engineering Structures* 38 , pp. 53-67, 2012.
- [222] Galuppi, L.; Royer-Carfagni, G.: Laminated beams with viscoelastic interlayer. *International Journal of Solids and Structures* 49 , pp. 2637–2645, 2012.
- [223] Amadio, C.; Bedon, C.: Analytical approaches for buckling verification of in-plane loaded laminated glass columns and panels. *Challenging Glass 3 - International Conference on the Architectural and Structural Applications of Glass, June 28- 29 2012, TU Delft (NL)*.
- [224] Amadio, C.; Bedon, C.: Standardized buckling curves for the verification of glass columns, beams and panels. *XXVII A.T.I.V. International Conference: From a grain of sand...to the strength of a structure. Parma, November 15-16 2012*.
- [225] Luible, A.: *Stabilität von Tragelementen aus Glas. Dissertation Thèse N0 3014, EPFL Lausanne, Switzerland, 2004*.
- [226] Holberndt, T.: *Entwicklung eines Bemessungskonzepts für den Nachweis von stabilitätsgefährdeten Glasträgern unter Biegebeanspruchung. Dissertation, TU Berlin, Germany, 2006*.
- [227] Liess, J.: *Bemessung druckbelasteter Bauteile aus Glas. Dissertation, Universität Kassel, Germany, 2001*.
- [228] Weiler, H.-U.: *Versuchsergebnisse und Stand der Entwicklung eines Bemessungskonzepts für druckbeanspruchte Glasbauteile. VDI Berichte Nr. 1527, Bauen mit Glas, VDI Verlag, Düsseldorf, Germany, 2000*.

- [229] Feldmann, M.; Langosch, K.: Vereinfachte und einheitliche Stabilitätsnachweise für Bauteile aus Einscheiben- und Verbundsicherheitsglas für Druck und Biegung. DAST-Forschungsprojekt Nr. 15060/N, Germany, 2009.
- [230] Maquoi, R., Rondal, J., Analytische Formulierung der neuen Europäischen Knickspannungskurven. Stahlbau 1/1978, Germany, 1978.
- [231] Feldmann, M., Langosch, K.: Knickfestigkeit und einheitliche Knickkurven für scheibenförmige Glasstützen mit Monoglasquerschnitt aus TVG und ESG. In: Stahlbau Spezial 2010: Konstruktiver Glasbau, No. 3, Ernst & Sohn Verlag.
- [232] Feldmann, M., Langosch, K.: Zum Biegeverhalten von VSG-Laminaten unter Quer- oder Längsbelastung. In: Stahlbau Spezial 2011: Glasbau - Glass in Building, Heft März, Ernst & Sohn Verlag.
- [233] Langosch, K.: Das Tragverhalten von Glasstützen mit Mono- und Verbundquerschnitten. Dissertation RWTH Aachen University, Lehrstuhl für Stahlbau und Leichtmetallbau, in process.
- [234] Stamm, S., Witte, H.: Sandwichkonstruktionen. Berechnung, Fertigung, Ausführung. Springer Verlag, Wien / New York 1974.
- [235] Feirabend, S.; Sobek, W.: Bewehrtes Verbundsicherheitsglas. Stahlbau 77 pp. 16–22 (2008).
- [236] Feirabend, S.: Steigerung der Resttragfähigkeit von Verbundsicherheitsglas mittels Bewehrung in der Zwischenschicht. Dissertation, Universität Stuttgart, Germany, 2010.
- [237] Petersen, Ch.: Statik und Stabilität der Baukonstruktion. Vieweg Verlag 1980.
- [238] Langosch, K.; Feldmann, M.: VSG-Glasstützen unter kombinierter Langzeit- und Kurzzeitbeanspruchung. In Glasbau 2012, Hrsg. Weller, B; Tasche, S., Ernst & Sohn.
- [239] Langosch, K.; Feldmann, M.: Wandartige Monoglasstützen unter axialen Drucklasten und Biegung. In Glasbau 2013, Hrsg. Weller, B; Tasche, S., Ernst & Sohn.
- [240] Möhler, K.: Über das Tragverhalten von Biegeträgern und Druckstäben mit zusammengesetzten Querschnitten und nachgiebigen Verbindungsmitteln. Habilitation. Technische Universität Karlsruhe, 1956.
- [241] Cruz, P.J.S.; Pequeno, J.M.: Timber-Glass Composite Beams: Mechanical Behaviour & Architectural Solutions. Challenging Glass 2008: Conference on Architectural and Structural Applications of Glass, Delft, Netherlands, pp. 439-448.
- [242] Cruz, P.J.S.; Pequeno, J.M.: Timber-Glass Composite Panels: Experimental Studies & Architectural Applications. Challenging Glass 2008: Conference on Architectural and Structural Applications of Glass, Delft, Netherlands, pp. 449-458.
- [243] Kreher, K.; Natterer, J.; Natterer, J.: Timber-Glass-Composite Girders for a Hotel in Switzerland. Structural Engineering International 2/2004, pp. 149-151.
- [244] Kreher, K.: Tragverhalten und Bemessung von Holz-Glass-Verbundträgern unter Berücksichtigung der Eigenspannungen im Glas. Dissertation Nr. 2999, IBIOS/EPFL 2004.
- [245] Bucak, Ö.; Bues, M.; Illguth, M.; Geiß, PL.; Kötter, MP.: Bonded steel glass hybrid beams. GPD conference 2009, pp. 318-320.
- [246] Feierabend, S.; Steigerung der Resttragfähigkeit von Verbundsicherheitsglas mittels Bewehrung in der Zwischenschicht. Dissertation, Universität Stuttgart, Germany, 2010.
- [247] Feldmann, M.; Abeln, B.; Baitinger, M.: Analysis of bonded hybrid steel-glass-beams by small scale tests. Challenging Glass 2, pp. 249-258, 2010.
- [248] DAST-Forschungsbericht Nr. 2/07: Untersuchung von Stahl-Glas-Verbindungen im Hinblick auf die Normung. AiF Forschungsvorhaben Nr. 14197/N, 2007.

- [249] Baitinger, M., Feldmann, M.: Ein Bemessungskonzept für SL-belastete Anschlüsse im konstruktiven Glasbau. In: Stahlbau Spezial: Konstruktiver Glasbau, Heft 3 (2010), Ernst & Sohn Verlag für Architektur und technische Wissenschaften GmbH & Co. KG, Berlin.
- [250] Baitinger, M.: Zur Bemessung SL-belasteter Anschlüsse im konstruktiven Glasbau. Dissertation. Schriftenreihe Stahlbau – RWTH Aachen. No. 71, Shaker Verlag, Aachen 2010.
- [251] Techen, H.: Fügetechnik für den konstruktiven Glasbau. Dissertation. Report No. 11. Technische Universität Darmstadt. Institut für Statik. ISSN 1433-7835, 1997.
- [252] Girkmann, K.: Flächentragwerke. Einführung in die Elastostatik der Scheiben, Platten, Schalen und Faltwerke. Springer-Verlag Wien-New York. Unveränderter Nachdruck 1974.
- [253] Bucak, Ö.; Hagl A.; Held B.; Bues M.: Geklebte Verbindungen im konstruktiven Ingenieurbau. Research project of the German Federation of Industrial Research Associations (AiF), No. 17040255, 2007.
- [254] Sedlacek, G.; Feldmann, M.; Naumes, J.; Wellershoff, F.: Development of optimum hybrid steel-glass-beams in respect to structural and architectural criteria. Final report, Aachen, 2005.
- [255] Wellershoff, F.; Sedlacek, G.: Employing the glazing for the stabilisation of building envelopes. Proceedings of Glass in Buildings 2; 7-8.05.2005, Bath, UK, pp. 343.
- [256] Wellershoff, F.; Sedlacek, G.: Stabilisation of building envelopes with the use of the glazing; Proceedings of Glass Processing Days 2005, pp. 281-283
- [257] Geiß, P.L.; Kötter, M.P.; Bucak, Ö.; Bues, M.: Partially Transparent Load Bearing Hybrid Structures (3TVB). Research project of the German Federation of Industrial Research Associations (AiF), No. 15058N, 2010.
- [258] Feldmann, M.; Pilsl, M.; Baitinger, M.; Gesella H.: The steel and glass façade – the new Citroën-Show room in Paris. Stahlbau, Vol. 75, Issue 6, 2006, pp. 409-414.
- [259] Feldmann, M.; Pilsl, M.; Langosch, K.: The new glass courtyard of the Jewish Museum in Berlin – An innovative façade with special technical requirements. Stahlbau, Vol. 77, Issue Supplement 1, 2008, pp. 34–41.
- [260] Feldmann, M.; Geiß, P.-L.; Dilger, K.; Pasternak, H.; Ummenhofer, T.: Neue Konstruktionen durch Einsatz von Klebverbindungen im Stahlbau (KiS). Research project of the German Federation of Industrial Research Associations (AiF-ZUTECH), No. 169 ZBG / 1, 2005-2007.
- [261] Geiß, P.L.; Wagner, A.; Luhn, R.: Influence of Surface Pre-Treatments on the Long-term Durability of Bonded Glass Joints (Proglazing). Research project of the German Federation of Industrial Research Associations (AiF), No. 14.776 BG/1, 2006-2008.
- [262] Feldmann, M.; Ungermann, D.; Abeln, B.; Baitinger, M.; Preckwinkel, E.: Development of innovative steel-glass-structures in respect to structural and architectural design (INNOGLAST). Research Project of the European Research Fund for Coal and Steel, No RFCS-CT-2007-00036, 2007-2010.
- [263] Bucak, Ö.; Feldmann, M.; Geiß, P.-L.; Abeln, B.; Bues, M.; Richter, C.; Scherer, T.: Lastabtragende Klebverbindungen im konstruktiven Ingenieurbau (LAKKI). Research project of the German Federation of Industrial Research Associations (AiF)16530 N, 2010-2012.
- [264] Feldmann, M.; Geiß, P.-L.; Abeln, B.; Richter, C.; Scherer, T.: Vereinfachtes Bemessungsverfahren für elastische Klebfugen mit mehrachsigen Spannungszuständen unter Berücksichtigung nichtlinearen Materialverhaltens

- (KLAX). Research project of the German Federation of Industrial Research Associations (AiF), No. 16842 N, 2011-2013.
- [265] Habenicht, G.: Kleben. Grundlagen, Technologien, Anwendungen. 5. erw. und aktualisierte Aufl., Springer Verlag, Berlin, 2006.
- [266] Guidelines for fabrication and monitoring of bonded connections in structural glazing, Fachverband Konstruktiver Glasbau, Arbeitskreis Kleben (German Professional Association for Structural Glazing, workgroup bonding), draft, 2010.
- [267] Peters, S.; Fuchs, A.; Knippers, J.; Behling, S.: Ganzglastreppe mit transparenten SGP Klebeverbindungen - Konstruktion und statische Berechnung. Stahlbau 3/2007, pp.151–156.
- [268] Wörner, J.-D.; Schneider, J.; Fink, A.: Glasbau. Grundlagen, Berechnung, Konstruktion. Springer Verlag, Berlin, 2001.
- [269] ETAG 002 - Guidelines for European Technical Approval for Structural Sealant Glazing System. European Organization for Technical Approvals, 2001.
- [270] Belis, J.; Callewaert, D.; Delincé, D.; Van Impe, R.: Experimental failure investigation of a hybrid glass/steel beam. Eng Fail Anal 19/2009, pp. 1163–1173.
- [271] DIN 53545:1990-12: Determination of low-temperature behaviour of elastomers; principles and test methods.
- [272] AIF 15818N: Tragende Scheibenelemente aus Stahl-Glas-Verbund. Universität der Bundeswehr München.
- [273] Netusil M.; Eliasova, M.: Behaviour of the glued joint in hybrid steel-glass beam, Polack Periodica: An International Journal for Engineering and Information Sciences. April 2010, vol. 5, No. 1, pp. 97-108. ISSN 1788-1994.
- [274] Wellershoff, F. Sedlacek, G.: Glued joints in glass structures, EU COST C13 Final Report 2007, Glass & Interactive Building Envelopes, pp. 229-239.
- [275] Feldmann, M.; Abeln, B.; Preckwinkel, E.: Characterization of Adhesive Joints for Hybrid Steel-Glass Beams by Means of Simplified Small Scale Tests. Journal of ASTM International, 1 (2012), pp. 15-30.

European Commission

EUR 26439 | " – Joint Research Centre – Institute for the Protection and Security of the Citizen

Title: Guidance for European Structural Design of Glass Components

Authors: M. Feldmann, R. Kasper, B. Abeln, P. Cruz, J. Belis, J. Beyer, J. Colvin, F. Ensslen, M. Eliasova, L. Galuppi, A. Geßler, C. Grenier, A. Haese, H. Hoegner, R. Kruijjs, K. Langosch, Ch. Louter, G. Manara, T. Morgan, J. Neugebauer, V. Rajcic, G. Royer-Carfagni, J. Schneider, S. Schula, G. Siebert, Z. Sulcova, F. Wellershoff, R. Zarnic

Editors: S. Dimova, A. Pinto, M. Feldmann, S. Denton

Luxembourg: Publications Office of the European Union

2014 – 208 pp. – 21.0 x 29.7 cm

EUR – Scientific and Technical Research series – ISBN 978-92-79-35094-8 (print)

ISBN 978-92-79-35094-8 (print)

doi: 10.2788/5523 (online)

## Abstract

This JRC Scientific and Policy Report is a pre-normative document that represents the basis of a new Eurocode on the design of structural glass. It was developed by CEN/TC 250 WG 3 and it presents the available background of both the design of glass components related to up-to-date existing national codes as well as the recent scientific knowledge.

The report includes a material part, describing the behaviour of glass and the used interlayer materials. Subsequently, the typical properties of glass products and their placement in existing product standards are mentioned. The principles and basic rules for the design of glass components as well as the safety approach are clarified with regard to the particular characteristic of glass – the absent of plasticity. Furthermore there are different types of construction made of glass. They can be separated in secondary and primary structural elements. For secondary structural elements the existing design rules are presented, for primary structural elements the report gives an overview of the actual state of research work.

In form of so called "Code reviews" the existing design and product standards are mentioned and they are also explained to some extent, the so-called "Eurocode outlooks" give a perspective on what and how the content of the future Eurocode on Structural Glass should be.

As the Commission's in-house science service, the Joint Research Centre's mission is to provide EU policies with independent, evidence-based scientific and technical support throughout the whole policy cycle. Working in close cooperation with policy Directorates-General, the JRC addresses key societal challenges while stimulating innovation through developing new methods, tools and standards, and sharing its know-how with the Member States, the scientific community and international partners.

