

# Nature of Early Play<sup>®</sup>

By **Play Mart**  
Playgrounds



Outdoor Early Childhood  
Play Products



# Creating environmentally conscious play spaces since 1980.

We keep both child development and environmental impact in balance in design and manufacturing.

Nature of Early Play by Play Mart is a full collection of commercial grade early childhood outdoor play and learning products that reconnect children (infant through age five) with the outdoor world through interactions with dirt, sand, water, animals, music, and plants. All our products are made from heavy-duty recycled materials that will withstand all weather conditions for MANY years! Our products are all designed for use in commercial settings such as Child Development Centers, commercial Day Care, university and corporate child care providers.

## TABLE OF CONTENTS

### ABOUT US

The Nature of Early Play Difference	2
Turn-key Service	3
Eco-Friendly Materials	4
Safe Materials	5
Compliant Design	6
Age-Appropriate Design	6-7
Custom Site Design	8-9
Installation	10
Color Palette	11

### THEMED

Activity Panels	12-13
Inclusive	14-15
Native American	16-17



### PLAYSETS

Preschool	18-24
Transportation	25



### INFANT

Playsets	26-34
Play Elements	35-37



For current designs and information visit [www.natureofearlyplay.com](http://www.natureofearlyplay.com).

## TABLE OF CONTENTS

### MOTION

Balance	38-42
Swings	43



### SENSORY

Gardening	44-47
Sand	48-51
Water	52-54
Nature Tables	55-56
Music	57-61



### OUTDOOR CLASSROOM

Arts & Crafts	62-65
Activity Panels	66
Tables	67-68
Seating	68-70
Storage	70-71
Shelters	72
Play Stages	72-73



### IMAGINATIVE

Mud Kitchen	74-79
Playhouses	80- 82
Trike	83-85



### FINISHING

Shade & Use Zones	86
Surfacing & Borders	87
Maintenance	88
Warranty	89





## What sets us apart from the rest?

### Recycled

All products are made from our exclusive Recycled Structural Plastic (RSP™). We recycle our own manufacturing scraps again to create more material! See page 4.



### Custom Site Design

Each customer's site is designed in-house to lay out each product with appropriate spacing for safety zones and age groups. We even provide full site renderings so you see the equipment as it will look in "real life". See pages 8-9.



### Age Appropriate

Designed for Infants (6 months-23 months) and Preschoolers (2-5 years) - anthropomorphically and developmentally. See pages 6-7.



### Made in USA

We manufacture all of our products in our facility in rural USA. Each item is hand-crafted by skilled men and women. High-tech machinery assists with creating parts. We even source the majority of our materials and components in the USA.



### Stimulating Play

Physically, socially, mentally and sensorially challenging products that encourage whole-person growth, and interaction between children of varying abilities.



### Durable

Heavy-duty, commercial-quality, outdoor materials will withstand extreme weather for many years. Stainless Steel hardware, attachment plates, and welds. UV resistant color additives in all plastic materials. Vandalism can be cleaned or repaired on most components easily. See pages 4-5 for more details on our materials.



We have been doing this for a while - over 40 years actually. So, we know what matters to you, and to your children.

### ✓ Turnkey services for an entire project:

We work with each customer to create a beautiful playground project from start to finish including:

1. Consultation regarding project needs
2. Custom site design (see pages 8-9)
3. Wide range of play equipment for infants up to twelve years, site amenities, shades, and safety surfacing
4. Equipment and surfacing installation
5. Comprehensive customer service backed by long-term product warranty

Once a project is complete, you can rest knowing that we are just a phone call away to assist with maintenance issues or adding more components or amenities to your playground at any time. Our products are modular and can be expanded even years later. We've got your back!

### ✓ In-House Manufacturing:

We create the majority of our components from scratch, including our own recycled plastic lumber. These are the wide range of components we create in-house:



#### Recycled Structural Plastic™

It begins with milk jugs and ends as beautiful, enduring, durable lumber. We manufacture our own lumber (RSP™) for our playground products from post-industrial plastics which prevents millions of pounds of plastics from entering a landfill per year. 50% of our RSP™ formula is comprised of our internal plastic manufacturing scraps and the remainder is recycled post-industrial milk jugs and bottles.



#### Fabric Covers

Using industrial sewing machines we create heavy-duty fabric covers for sandboxes, Infant Corrals and Play Houses that can withstand natural elements.



#### Metal Climbers & Rails

We turn heavy-duty pipe into unique climbing equipment and then poly-coat it with exclusive textured SureGrip™ coating to increase friction for better grip. The coating is stronger than the standard poly-coating and resists scratching and chipping.



#### Wood Site Amenities

Sourcing reclaimed cedar and other native trees, we create beautiful natural tables, benches, stepping stumps and stools. The natural wood is finished with penetrating oil-based Clear Wood Sealer for longer lasting outdoor wood protection.

### ✓ Hand Crafted:

Each product is made with care and precision. High-tech machinery assists with creating parts which are then assembled by hand with a high amount of quality control throughout the entire process.



### ✓ Sustainable Manufacturing:

- Material efficiency - utilizing each sheet of plastic and post length to limit waste and cut-scrap. All scraps are then recycled again into our RSP lumber.
- Internal recycling of manufacturing waste
- Geo-thermal cooling for RSP extrusion process
- Skylights
- LED motion-activated lighting
- Recycling of office waste



## Standing Behind our Products:

We have been manufacturing playgrounds for over 40 years and know from experience that sometimes not everything we build works "just right". But, we always stand behind our products and services until our customers' needs are met and our products meet our high quality standards.





# ECO-FRIENDLY MATERIALS

Focusing on this generation – and the next – we engineer our outdoor playground products to be low-impact environmentally, safe, and enduring with the use of reclaimed plastic and stainless steel.



**Recycled Structural Plastic™ “RSP”**  
We manufacture our own lumber (RSP™) for our playground products from post-consumer and post-industrial plastics which prevents millions of pounds of plastics from entering a landfill per year. RSP™ is 85% recycled plastic by weight. 50% of our RSP™ formula is comprised of our internal plastic manufacturing scraps and the remainder is recycled post-industrial milk jugs and bottles. We prevent all of this plastic waste from entering the landfill.

**RSP™ Posts & Frame Material Colors**  
We use over 100,000 pounds of internal scrap annually to produce beautiful new shades of RSP. We've added Slate and Mist to the RSP color palette in addition to our standard Chocolate and Latte.



## Recycled Structural Plastic™ “RSP” Lasts Longer!



**DOES NOT FADE**  
On many metal playgrounds, beautiful reds turn into pink, and yellows fade to a milky tan color - not the result you want when investing thousands of dollars in a playground. Our RSP™ is highly UV and fade resistant. Our colors remain “factory fresh” for many years! Our playgrounds built with RSP™ are designed to look beautiful after decades of service.



**DOES NOT RUST**  
Rust on metal playgrounds is all too common, even those coated with plastic or PVC. Rust can injure children and shortens the life of the play system. When you buy Nature of Early Play equipment made with RSP™, you don't have to worry! RSP™ is designed to handle the toughest elements that nature can dish out - with no rust! RSP's weather resistant, non-porous properties remain static even when in continuous contact with water, sea air, salt and sand.



**GRAFFITI RESISTANT**  
Any parent or park director will tell you that graffiti is an all too common problem for most playgrounds. Stickers, etching into metal posts, markers and spray paint all detract from the kid-friendly play environment. Nature of Early Play's RSP™ makes graffiti removal very easy! Marker and spray paint will come off with a cloth and light cleaning solution and stickers don't stick to RSP™. Small scratches “self-heal” into the material, and larger ones can be smoothed easily while keeping color integrity.



**DOES NOT ROT OR SPLINTER**  
Although gaining in popularity, wood is not a preferred building material for playground use. Wood is susceptible to insect damage, rot, splintering, and requires a great deal of maintenance. Over the life cycle of a playground, a Nature of Early Play RSP™ playset will far exceed the value of a wood playset. RSP™ is flame, rot and fungus resistant, and is immune to termites, insects and borers. Steel Posts can split when post caps rust, leak, fill with water and freeze. RSP™ is solid and water impermeable.

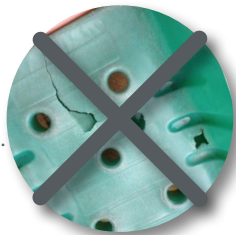

**DOES NOT TEAR**  
Many playgrounds designed for early childhood are made from hollow molded plastic which can be easily punctured or tear over time. Our material is solid, preventing damage and deterioration of this sort.



**NON-TOXIC, DOES NOT PEEL**  
Other playground decks are often coated with PVC, which tends to peel. RSP™ is solid material so it will not de-laminate (when coatings peel apart). RSP™ does not contain PVC; it is non-toxic and will not leach or bleed arsenic, heavy metals or chemicals into water or soil.



**DOES NOT CHIP OR FLAKE**  
Nature of Early Play is committed to building playgrounds that wear well with use. Our RSP™ has a consistent color throughout the entire post or board, which gives it the ability to conceal scuffs and scratches. Painted metal posts quickly accumulate these imperfections, which result in major paint issues that require repair or replacement. RSP™ does not have an outer layer that can flake off or get chipped away and never needs painting or treating.

For current designs and information visit [www.natureofearlyplay.com](http://www.natureofearlyplay.com).

# SAFE MATERIALS

All products are 100% toxin free. NO Arsenate/Arsenic, BPA, Phthalate or “soft” PVC.



**EcoColor™ Plastic:**  
Our two-tone sheet plastic contains a portion of post-industrial recycled content as well, while maintaining structural integrity and color consistency. We create imaginative and graphically pleasing panels and components from this two-tone layered material.

**RSP™ Lumber:**  
All framework, posts and preschool playset decking is made from our exclusively recycled and extruded Recycled Structural Plastic™ lumber. We literally make playgrounds from recycled milk jugs!

**“Cloud” Flooring for Infant Playsets**  
“Cloud” flooring has a rubberized top surface texture that is gentle on infant feet and knees, while it helps to prevent slips. The flooring also flexes under pressure, providing a friendlier feel. So, if little ones do take a tumble, the fall won't be quite so traumatic. We use Cloud Flooring on our Rock Wall Climbers as well, providing tiny climbers with a better grip. Rock handles stay firmly secure without spinning. Caregivers will love the non-porous, washable surface as well. Any messes can be easily hosed off.

**Photo Panels**  
Permanently printed on Alumilite. Choose one of our images or request a custom photo.

**Stainless Steel Hardware**  
Rust-proof Stainless Steel hardware and attachment plates are standard on all equipment – features unmatched in the playground industry. We even offer a complete Stainless Steel upgrade for all metal on the entire structure – the solution for coastal environments where salt-spray disintegrates galvanized steel and corrodes aluminum very quickly.

**SureStep™ Decking for Preschool Playsets**  
This slip-resistant ridged RSP™ deck-board is our proprietary design for increasing friction and reducing falls so children can walk and run confidently on our products. The ridges also make the decks cooler to the feet with less direct sun contact.

**SureGrip™ Coated Pipe**  
Our exclusive textured SureGrip™ powder-coating ensures children get a good grip on metal climbers or framework. The matte finish reduces glare and burns and lasts many times longer. Each joint is welded with stainless steel welding wire and carefully sanded to prevent jagged edges (which could cause chipping and injuries).



- RSP Applications:**
- Structural members (posts)
  - Decking & Platforms
  - Steps
  - Railings

- Benefits:**
- Low maintenance
  - Graffiti resistant
  - Will not rust, splinter, split or de-laminate
  - Color throughout plastic – no fading or chipping
  - Resistant to marine borers, termites, fungus, salt and oils
  - Textured walking surfaces for safety – SureStep™ Decks
  - Additional Stainless Steel reinforcement as needed
  - 10 Year Warranty on Posts and vertical structural members
  - 100% BPA, Phthalate and “soft” PVC free
  - Provides a life lesson to kids about good use of resources!



## Design Compliance:

Play Mart designs all products according to ASTM F1487 standards, ASTM F2373 standards, CAN/CSA Z614 standards, CPSC Guidelines, and ADA Accessibility Guidelines. IPEMA Certification applies to products designed for children ages 2-12 years.



## IPEMA Testing:

In the interest of playground safety, the International Play Equipment Manufacturers Association (IPEMA) provides a Third Party Certification Service whereby a designated independent laboratory, TÜV SÜD America Inc., (TÜV), validates an equipment manufacturer's certification of conformance to the ASTM F1487 Standard Consumer Safety Performance Specification for Playground Equipment for Public Use, except sections 7.1.1, 10, 13.1.1, 13.1.2, 13.2, and 13.3; to CAN/CSA Z614 Children's Playspaces and Equipment, except clauses 10 and 11; or both. A list of our current validated products may be viewed at [www.ipema.org](http://www.ipema.org).

## Appropriate Design

The equipment in this Early Childhood catalog is designed to meet safety guidelines for ASTM (American Society for Testing Materials) F2373, for children ages 6 to 23 months, as well as ASTM F1487, for children 2 to 5 years. Nature of Early Play equipment is designed at the appropriate mental and physical level for each age group. Our fully age-appropriate products allow a caregiver to provide supervised outdoor time in a safe and protected, but challenging, environment for infants and toddlers. We take into consideration each of these areas when developing age and ability appropriate equipment for early childhood:

- **Size:** Anthropomorphic research is used to develop equipment heights and sizing to meet or exceed guidelines for ASTM F2373, for children ages 6 - 23 months, and ASTM F1487, for children 2 - 5 years.
- **Mental Acuity:** What challenges a 6-month-old mentally is very different from that of a 5-year-old. An infant can be mentally stimulated just turning a knob, whereas a 5-year-old would likely be unchallenged and bored. We have taken the time to incorporate a host of elements in our play equipment that encourages the mental acuity of children of all ages.
- **Physical Ability:** An infant may be just learning to roll or stand up with support. Our infant equipment is geared towards tummy time, rolling, pulling up and crawling. A 5-year-old needs climbing, balancing, and more challenging activities.
- **Sensory Stimulation:** Children need to engage more than one of their senses during play to remain interested. Nature of Early Play products are designed to delight all of a child's senses including:
  - **Visual:** bright colors and subtle colors (to avoid overstimulation) and photo panels
  - **Auditory System:** musical equipment such as chimes, bells, drums
  - **Touch:** sand and water products and our Sensory Cube with a variety of shapes and textures
  - **Olfactory System:** digging in our Raised Garden Beds and growing plants or vegetables.
  - **Gustatory System or Taste:** fresh veggie grown in one of our Raised Garden Beds.
- **Social Awareness:** social skills and imaginations flourish as they "purchase" produce from their very own Farmer's Market, then "cook" it in the Mud Kitchen together.
- **Balance:** infants receive vestibular system stimulation as they gently rock in the Belly Swing. Preschoolers benefit from swinging action on our T-Swings.
- **Spatial Orientation:** infants gain proprioceptive awareness during tummy time in our Infant Corral - a padded, outdoor play space for infants to pull-up, sit up, and roll.

## Designed for appropriate ages, abilities and environment.

Years ago, Play Mart created our Nature of Early Play product line to fill a void in the field of outdoor play equipment for young children. An evident lack of appropriate equipment - for infants especially - prompted us to further expand the product line to offer an even wider range of equipment for infants.

When selecting equipment for your sites, please specify an age group for each site and we will appropriately size each piece. We meet age appropriate standards as defined by ASTM F-2373, ASTM F-1487 and CPSC guidelines.

### Nature of Early Play's Age Groups:

- Infants & Pre Toddler: 6 - 23 months
- Toddler & Preschool: 2 - 5 years

See [www.playmart.com](http://www.playmart.com) for products for 5-12 year olds.

### Size



Each product is sized carefully for the appropriate age group, considering height as well as physical coordination.



### Mental Acuity

Appropriate mental challenges for each age group.



### Spatial Orientation

Through movement in safe environments, young children gain awareness of their place in the physical world.



### Physical Ability

We design products appropriate for 6 month to five year olds as well as children with physical limitations. See pages 14-15 for our inclusive product offerings.



### Sensory Stimulation



One of the most important goals of play time is stimulating all the senses at appropriate levels for each age group, without overstimulating. From subtle to bold, quiet to loud, simple to complex, each of our products offers a wide range of sensory experiences.

### Balance



Our age-appropriate equipment is designed to stimulate the vestibular system as they gently rock and swing.



### Social Awareness

Through play, children learn to engage with others in appropriate ways. Products that encourage cooperation stimulate social interactions.



For current designs and information visit [www.natureofearlyplay.com](http://www.natureofearlyplay.com).



## From Concept...

Our professional in-house design team is headed by a Registered Landscape Architect, CPSI, who is an expert in safety codes. For every project, at no extra cost, we create accurate 3D satellite playground designs that are construction ready. We guarantee that the designs created for each location meet ASTM F2373 (6 – 23 months), ASTM 1487F (2 - 5 years) safety standards, CPSC guidelines and ADA Law.

### DESIGN SERVICES:

- Site Analysis - We analyze location, climate and other environmental factors that can indicate proper materials, type of play equipment choice, etc.
- Site Imagery - We use the latest technology to get an accurate image of your site and utilize that to create the most realistic site images possible.
- Accurate Site Layouts - Your layout and design will properly reflect the property space with the selected play equipment placed with appropriate safety spacing.
- Final Drawings & Site Images Include:
  - Quality Renderings - quality rendering and video at any resolution needed for presentations or proposals.
  - Equipment Cutsheets - cutsheets, layout and dimensions for all your designated equipment
  - Equipment Images - images provided in 3D and 2D for your installation

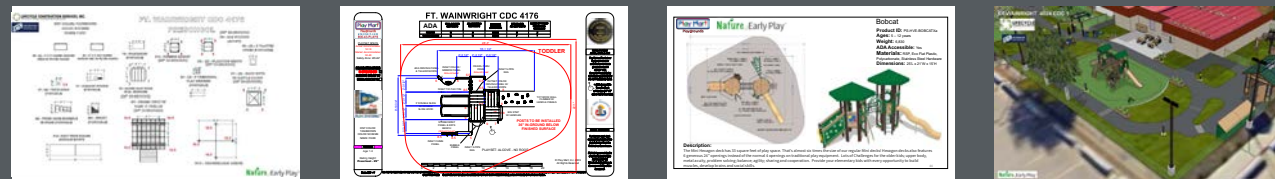

## ...to Completion.

We are able to create custom site design from scratch or revamp an existing site. We work with your architect or engineer in the planning stages to ensure all elements of a site are properly engineered and the design is cohesive.



We are proud to continue our work with the US Army Child and Youth Services to renovate their Child Development Centers. The renderings and images on these pages represent a sample of how we can assist you in creating a custom project plan from start to finish.

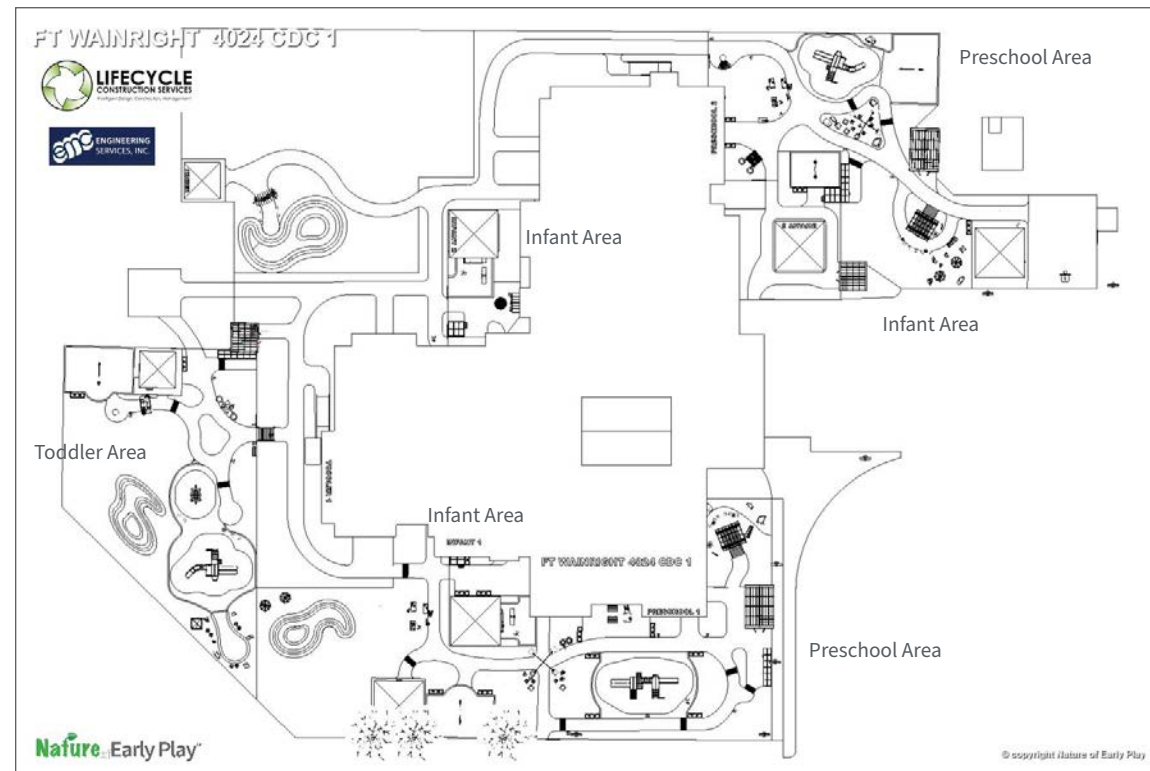

The entire turn-key equipment installation is completed by Certified Installers to our exact specifications.





## Installation Styles:

Some products come fully assembled while others require either some assembly on site or full installation.



### Fully Assembled:

Designated products are fully assembled when they arrive on site and do not require any installation or anchoring.

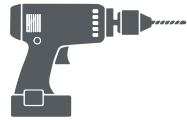

### Assembly Required:

Most products in this catalog are built to be assembled in place using basic power tools like a drill and screws (hardware included). These items are sturdy enough to stand alone without permanent installation. Many "Assembly Required" items can also be anchored to solid surfaces for security. Some "Assembly Required" items are portable and can be moved around your site (or even indoors if small enough).



### Installation Required:

1. **In-ground:** Designated products, such as playsets and products requiring more stability, can be installed in-ground with concreted posts.

2. **Surface-Mount:** Most playsets and products requiring more stability can be surface mounted to solid surfaces (concrete, asphalt or wood) with appropriate brackets unless otherwise stated. Brackets are an additional cost.



### Stainless Steel Bracket Post Brackets:

Intended for play sets with posts and decks. Often only one bracket per post is required for most Infant & Preschool play sets. We will determine how many and what type of brackets are the minimum required and will provide a quote based on your site's subsurface. Stainless Steel & powdercoating on brackets is standard. Price includes hardware.

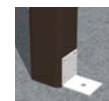

### L Brackets:

For units that are not designed as play surfaces, "L" brackets may suffice. These are simple aluminum brackets at a fraction of the cost of the Stainless Steel post brackets. Price includes hardware.

## Installer Options:

If installation is required there are several options. Ask for a quote from your local Nature of Early Play sales representative.



- Certified Complete Installation by one of our Certified Installers
- Supervised Installation by one of our Certified Installers. You provide the labor - we provide the supervisor.
- Customer Installations are appropriate only when an experienced construction crew uses Nature of Early Play installation instructions and installs the equipment in compliance with prescribed safety standards.



## Choose a color scheme you love!

We offer color schemes in a wide variety of preset combinations. We also customize—all you have to do is ask! Custom colors are available for an additional charge.



Coffee Shoppe

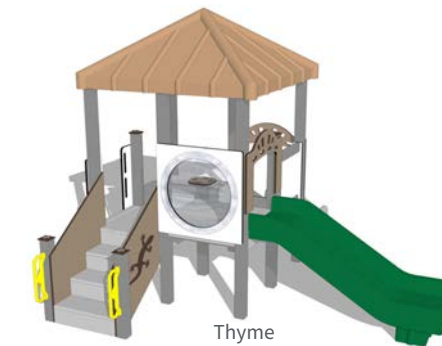

Thyme



Creamsicle



Nature Rocks



Spring



Summer



Cumulus



Winter



Cardinal



Primary

### Molded Plastic Options

Slides, Some Roofs



### RSP™ Options

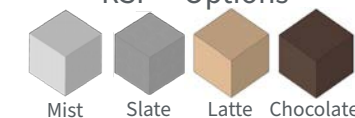

### Metal Options



### Eco-Color™ Options



### Eco-Color™ Two-Tone Options







## Activity Panels

Customize one of our playsets by choosing from the activity panels below or create your own ground level "panel center" by combining your favorite panels. See page 35 for panel centers you can customize.



Add a Photo to the opposite side of these panels!

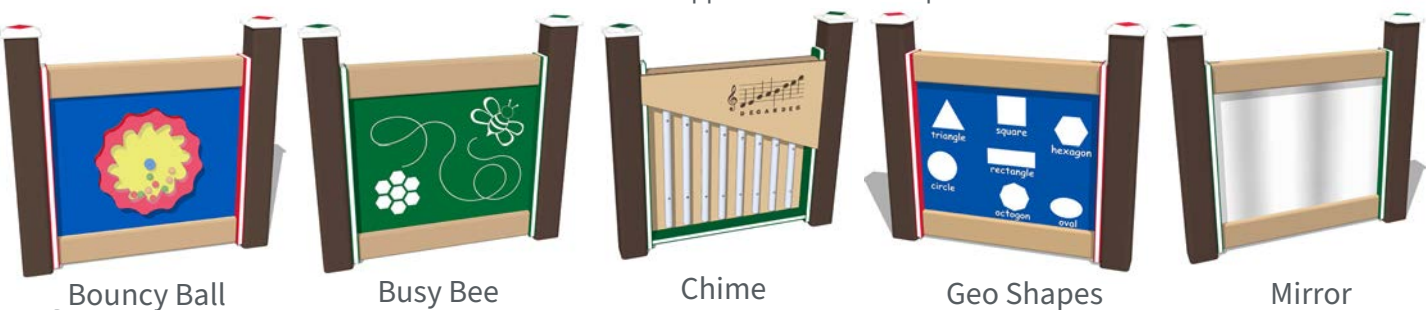

## Photo Panels

Permanent real photos printed on laminated vinyl on heavy-duty outdoor alumalite material. These brilliant images will last many years (just like graphics laminated on vehicles that can withstand extreme wear and tear)! Choose panel for other side: another Photo Panel, Color Panel, Busy Bee, Bouncy Ball, Geo Shapes, Geo-Oval Gear, Mirror and more!

### Animal Photos



### Whimsy Photos



Custom Photo or Logo Panel  
Send us an image or logo and we will create a custom panel for you!





Our in-house design team will create a custom inclusive play site that meets the unique needs of the children you serve. We work with you to take into consideration abilities and limitations of all types - physical, mental, social, and emotional. This site was designed for a deaf and blind school serving children from 2 years to 12 years.



## Inclusive Play

Designed appropriately for children with limitations including deafness, blindness or physical limitations.

Carefully designed play components offer various sensory and physical stimuli appropriate for their abilities.

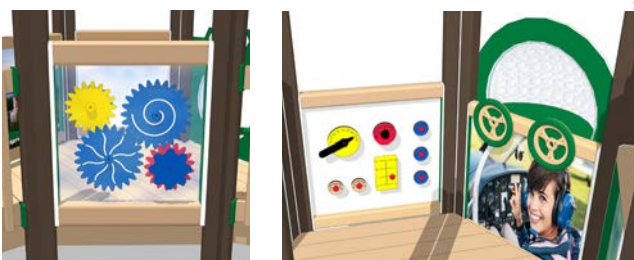

Interactive Panels for children of all abilities - Gears, Gauges, Airplane Cockpit with Steering Wheels.

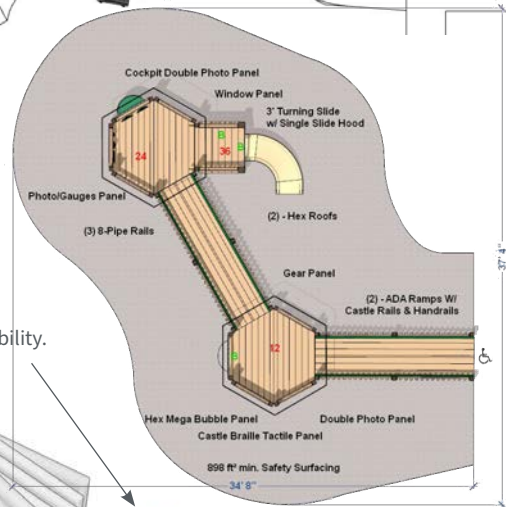
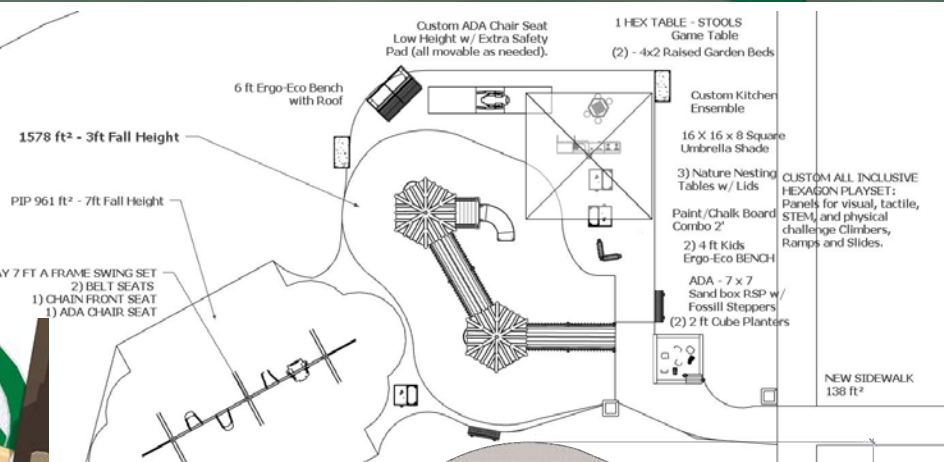

### Stanford Inclusive

- PS-HVP-STNFORDa
- Safety Zone: 35' x 38'
- Installation Required

Ramps for wheelchair accessibility.



Castle Braille Tactile Panel corresponds with printed Photo Panel for blind children to "read" a picture, while someone can describe the image to them as well.

For more information visit [www.natureofearlyplay.com](http://www.natureofearlyplay.com).



Castle Braille Tactile Panel



Castle Photo Panel

### Castle Braille Tactile Panel

A variety of tactile surfaces create an image of a Castle (the one that inspired the Disney Castle!). Braille letters spell out "Castle". The same image is printed on a Photo Panel and placed side-by-side so

a sighted person can describe the scene to the blind child as well.

- Braille Panel: PE-NNPD-CSB-XXa
- 46"L x 6"W x 43"H
- Installation Required



### Sign Language Panel

Add our freestanding Sign Language Panel to your play area to foster communication among children of all abilities. Official alphabet in ASL.

- PE-NNPD-SGN-XXa
- 31"L x 4"W x 40"H
- Installation Required



Look for this symbol throughout our catalog for more accessible play items.

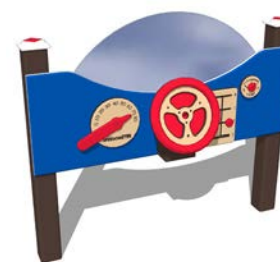

ADA Daytona Panel



No-shelf version for ADA access.



ADA Driving Panel

Both of these panels fit a wheelchair beneath so a child's arms can reach the steering wheel and gauges easily. Sized for the appropriate age group.

### Accessible Craft Table

Sized appropriately for a wheelchair to roll beneath this craft table. See age 67 for the version with the shelf. Includes a raised edge to prevent craft supplies from rolling off the table top.

- PE-XNTT-CFA-20a, 32"L x 32"W x 20"H
- PE-XNPT-CFA-24a, 32"L x 32"W x 24"H
- PE-XNET-CFA-28a, 32"L x 32"W x 28"H
- Fully Assembled

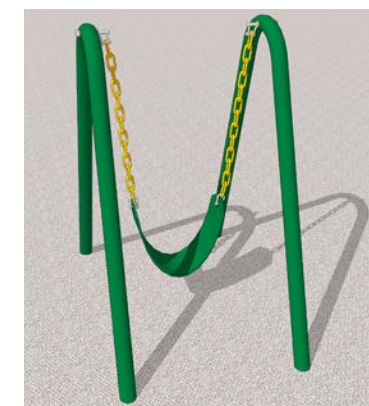

### Inground Belly Swing

Designed for larger children with limited physical and mental abilities. Designed to be used either sitting or lying with their belly on the swing.

- PE-XVPS-BEL-XXa
- 48"L x 30"W x 48"H
- Safety Zone: 9' X 16'
- Installation Required



# Honoring Your Heritage

We have worked closely with Native American communities throughout North America over the years to develop outdoor play products that honor their heritage. These products encourage the next generation to learn about their own ethnic roots from language to dwellings to transportation. We are proud to share this collection with you.

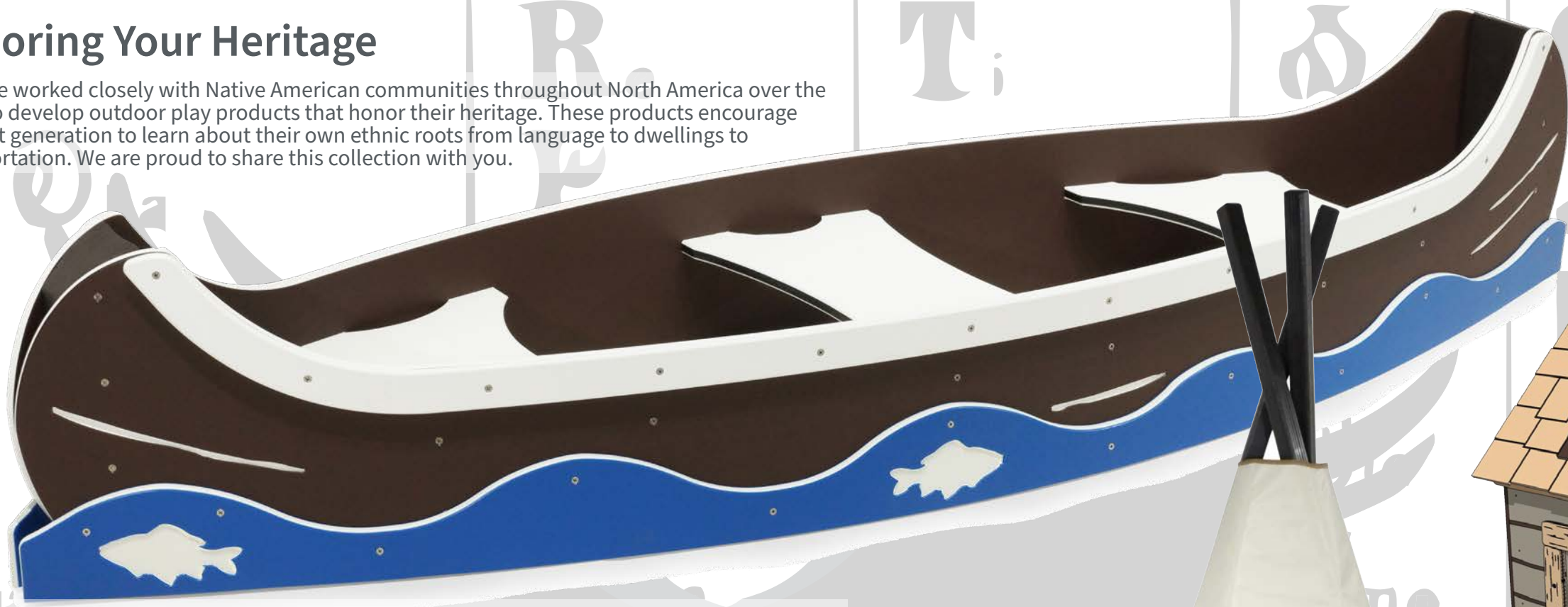

Canoe

Whether youngsters want to brave the rapids or spend the day fishing, our Canoe helps build imaginations. Developed by nations all over the world, the canoe played a key role in history. Encourage interest in other cultures by adding this item to your playground. Pair with our Gone Fishin' Cabin to complete the scene! No safety surfacing required for this ground-level component.

- PE-XVPR-CNO-XXa
- 8'L x 2.5' W x 16" H
- Fully Assembled



Gone Fishin' Cabin

This rustic-styled back-woods cabin features engraved plastic to mimic wooden siding. No termites here - and no splinters either. Add our Canoe to complete the hunter-fisher themed play area.

- PE-NNTP-GFC-XXa
- 48"L x 47"W x 78"H
- Installation Required

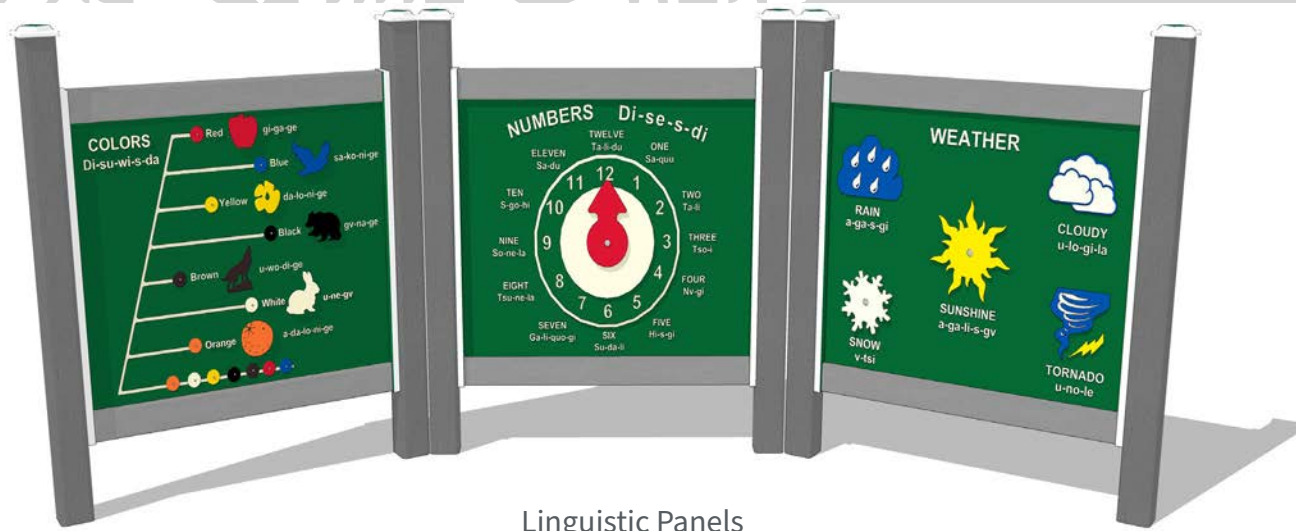

Linguistic Panels

Linguistic Panels are available in English, Spanish (bilingual), Cherokee or language of your choice. The interactive Colors panel has moving color knobs to match to the correct color symbols (animals, fruit, plants). The interactive Clock Number panel has a spinning hour-hand arrow to teach children to tell time as well as learn numbers. The Weather Panel's rain, clouds, sunshine, snow and tornado symbols teach weather patterns in different languages. Each panel is available individually or combined in 42" widths. The Linguistic Panel Sets (all three 42" wide panels in a semi-curve) creates a classroom setting, especially when combined with Stepping Stools for seating (not included). Installation Required.

- 124"L x 20"W x 43-58"H.
- Set of 3 in Cherokee: PE-NNPD-LIC-XXa
- Set of 3 in English: PE-NNPD-LIE-XXa
- Set of 3 in Spanish: PE-NNPD-LIS-XXa
- Set of 3 in Custom Language: PE-NNPD-LIX-XXa



Tipi

Our Tipi resembles authentic Native American dwellings of the Great Plains. The originals were covered with animal hides. Our child-sized version sports durable, marine-grade fabric instead. The EcoColor plastic bottom and RSP (Recycled Structural Plastic) supports will never rot or tempt termites. Scalloped openings decorate the bottom of the cover. High sides also allow caregivers to maintain visual contact with the children.

- PE-XNPP-TPS-XXa
- 48"W x 48"L x 84"H
- Assembly Required



# We all know that one size does not fit all.

That is why we design our playgrounds to fit each age group appropriately. Preschoolers benefit from just the right amount of challenge to encourage their physical, spatial and social development.

 All Playsets are designed to be accessible via "ADA Transfer Stations" - appropriate width and height steps or decks with grab handles for transfer onto the play deck.

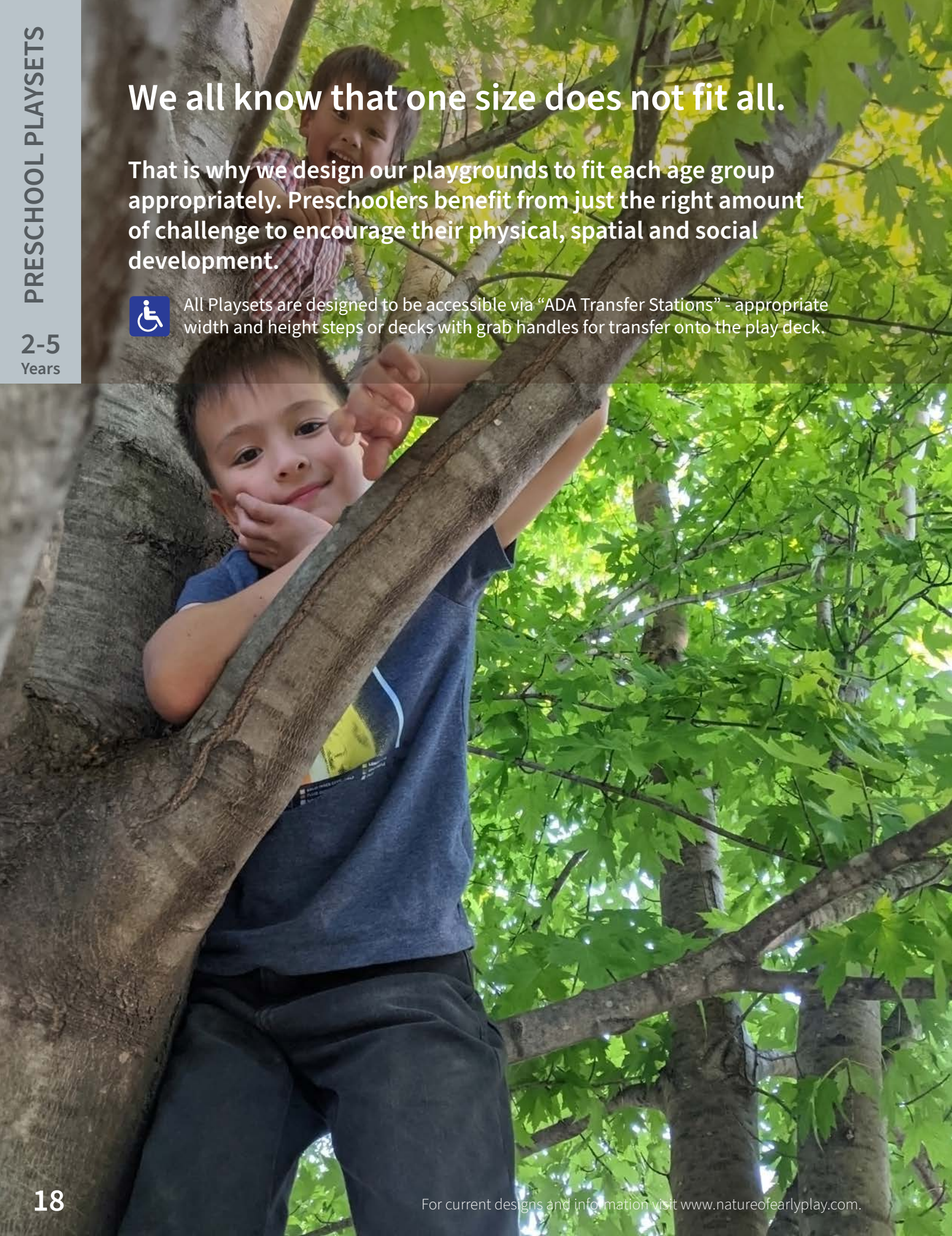

# Preschool Playsets

Each playground is made from heavy-duty Recycled Structural Plastic (RSP™) assembled with Stainless Steel hardware and Stainless Steel welds on metal components. SureGrip™ poly coating on metal prevents slips and scratches. SureStep™ decking increases friction to reduce slips and falls. The models on the following pages are ideal for Preschools, Daycares and Parks serving toddlers and kindergarteners from age 2 to 5 years old.



**Timberwolf**  
 • PS-NVP-TMBRWLFa  
 • Safety Zone: 38' x 29'  
 • Installation Required

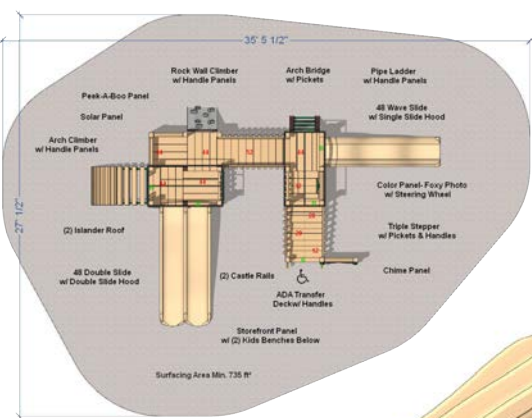
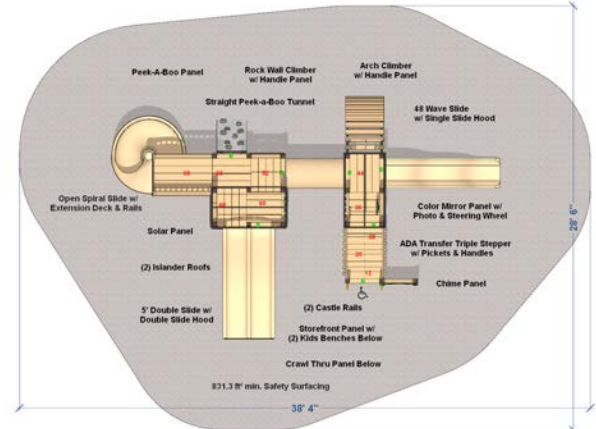

**Foxy**  
 • PS-NVP-FOXYXXXa  
 • Safety Zone: 36' x 28'  
 • Installation Required

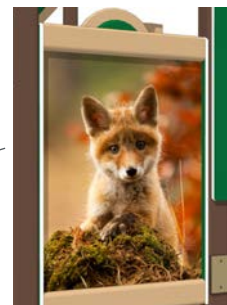

Unique Photo Panels on many playsets.



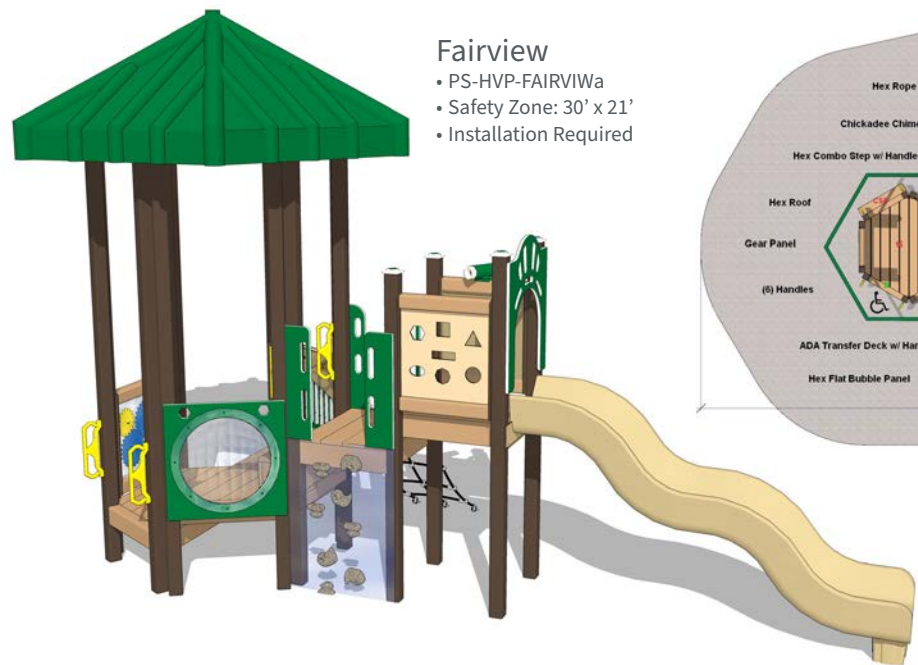

**Fairview**  
 • PS-HVP-FAIRVIWa  
 • Safety Zone: 30' x 21'  
 • Installation Required

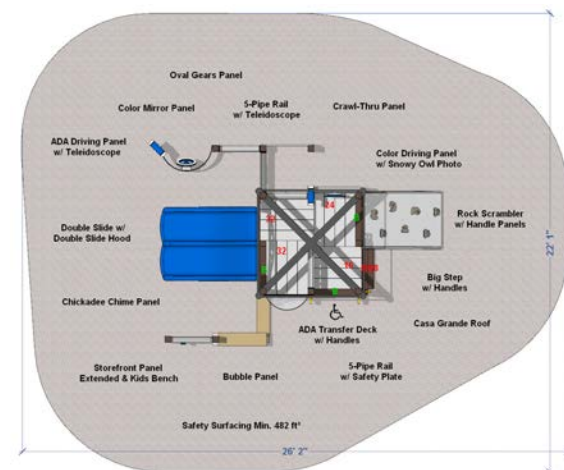
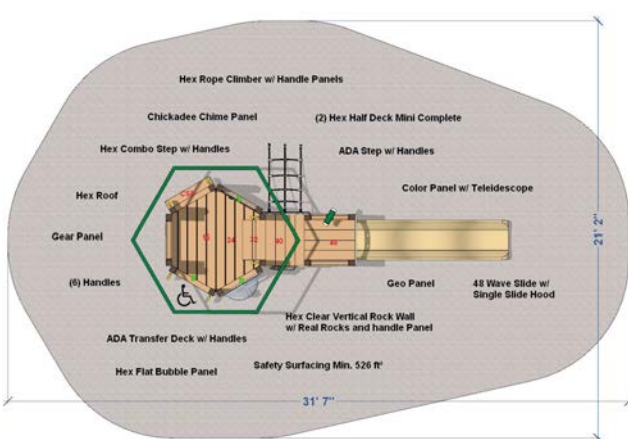

**Snowy Owl**  
 • PS-NVP-SNOWYOWLa  
 • Safety Zone: 26' x 22'  
 • Installation Required

**Kid's Kabin**  
 • PS-NVP-KIDKABNa  
 • Safety Zone: 25' x 24'  
 • Installation Required

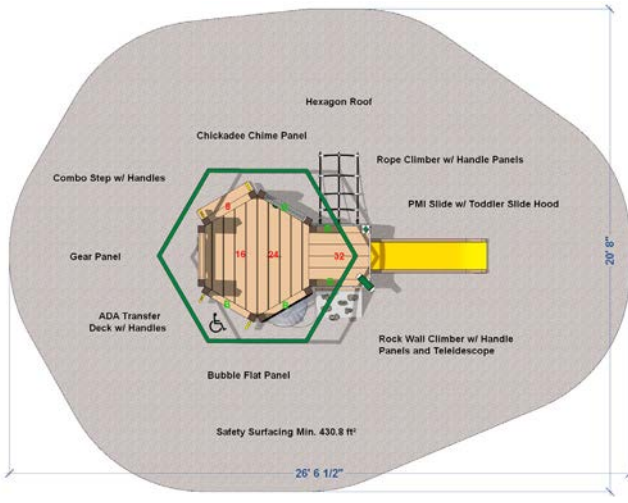
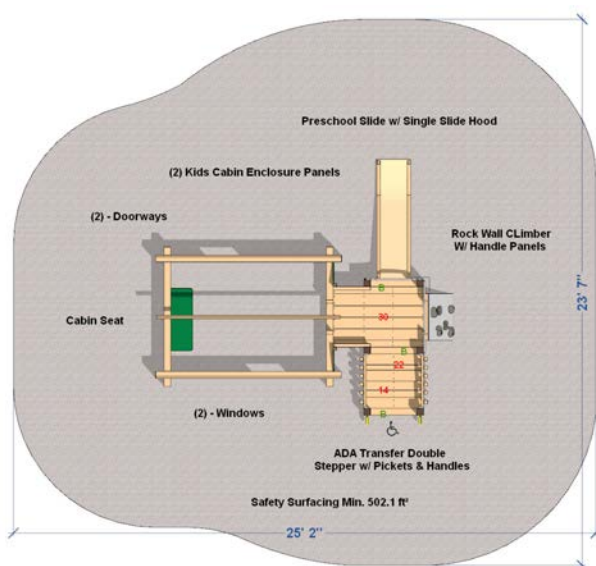

**Lil Hut**  
 • PS-HVP-LILHUTXa  
 • Safety Zone: 25' x 20'  
 • Installation Required

**Gecko**  
 • PS-NVP-GECKOXXa  
 • Safety Zone: 35' x 23'  
 • Installation Required

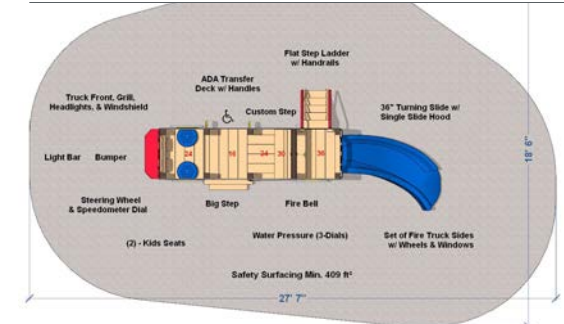
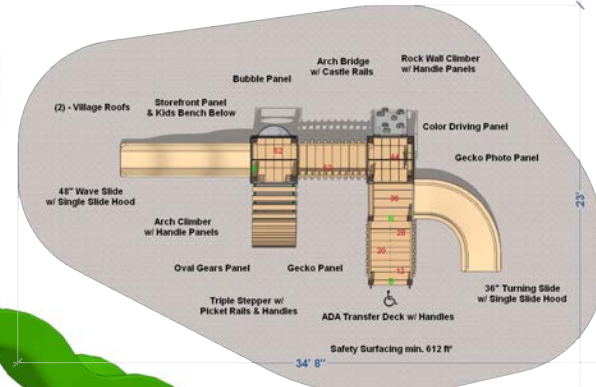

**Fire Truck**  
 • PS-NVP-FIRETRKa  
 • Safety Zone: 28' x 19'  
 • Installation Required



**Beach Boat**  
• PS-NVP-BEACHBOa  
• Safety Zone: 32' x 18'  
• Installation Required



**Ladybug**  
• PS-NVP-LADYBUGa  
• Safety Zone: 25' x 19'  
• Installation Required

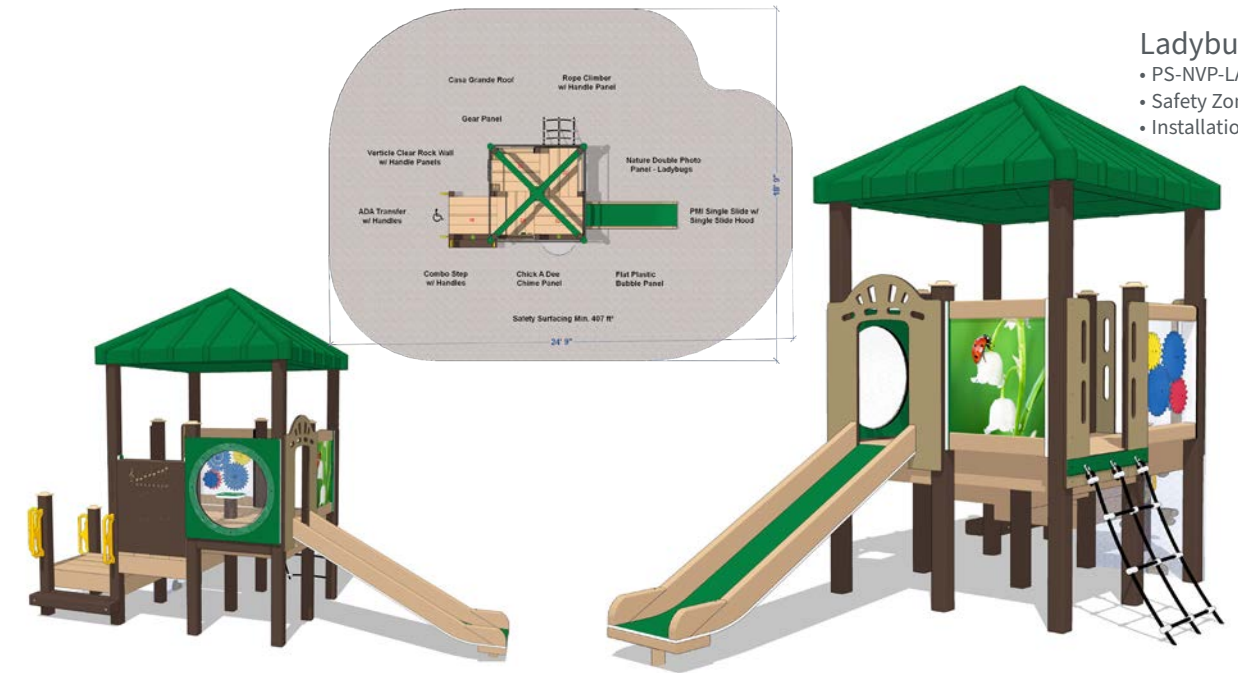

**Noah's Ark**  
• PS-NVP-NOAHSARa  
• Safety Zone: 32' x 18'  
• Installation Required

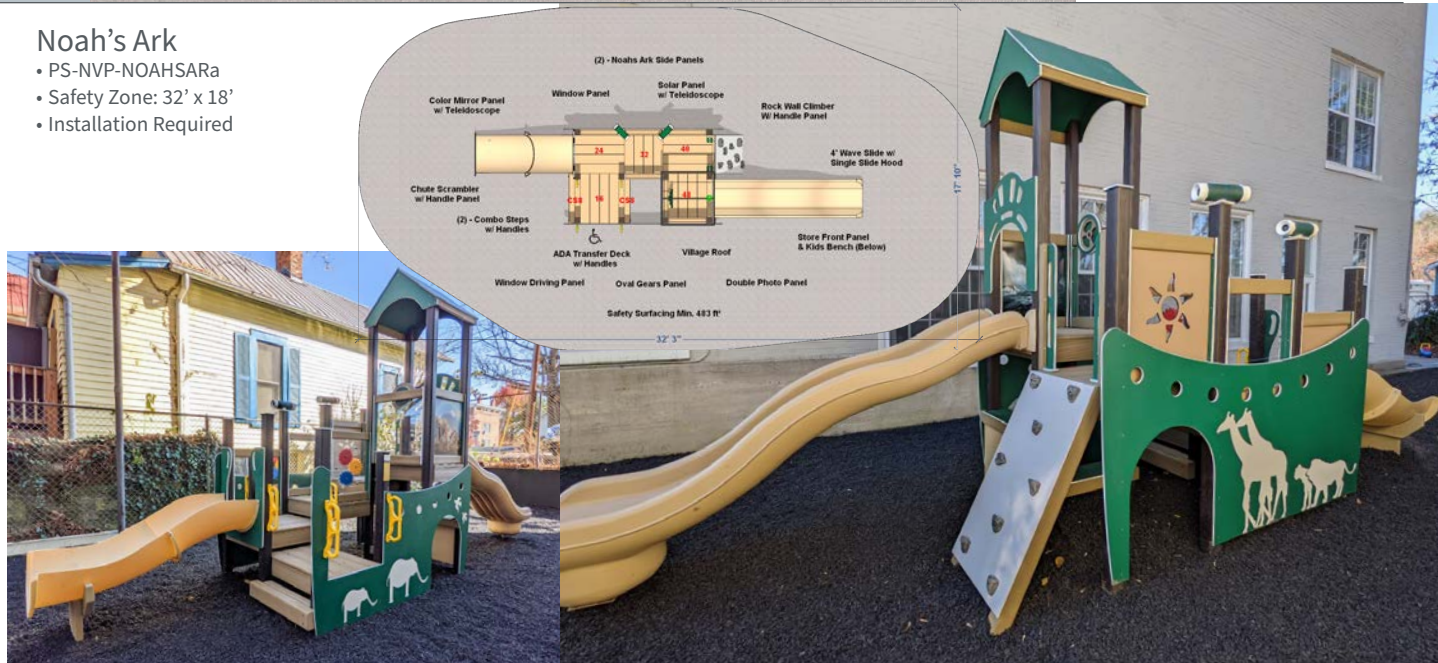

**Kiwi**  
• PS-NVP-KIWIXXXa  
• Safety Zone: 28' x 22'  
• Installation Required

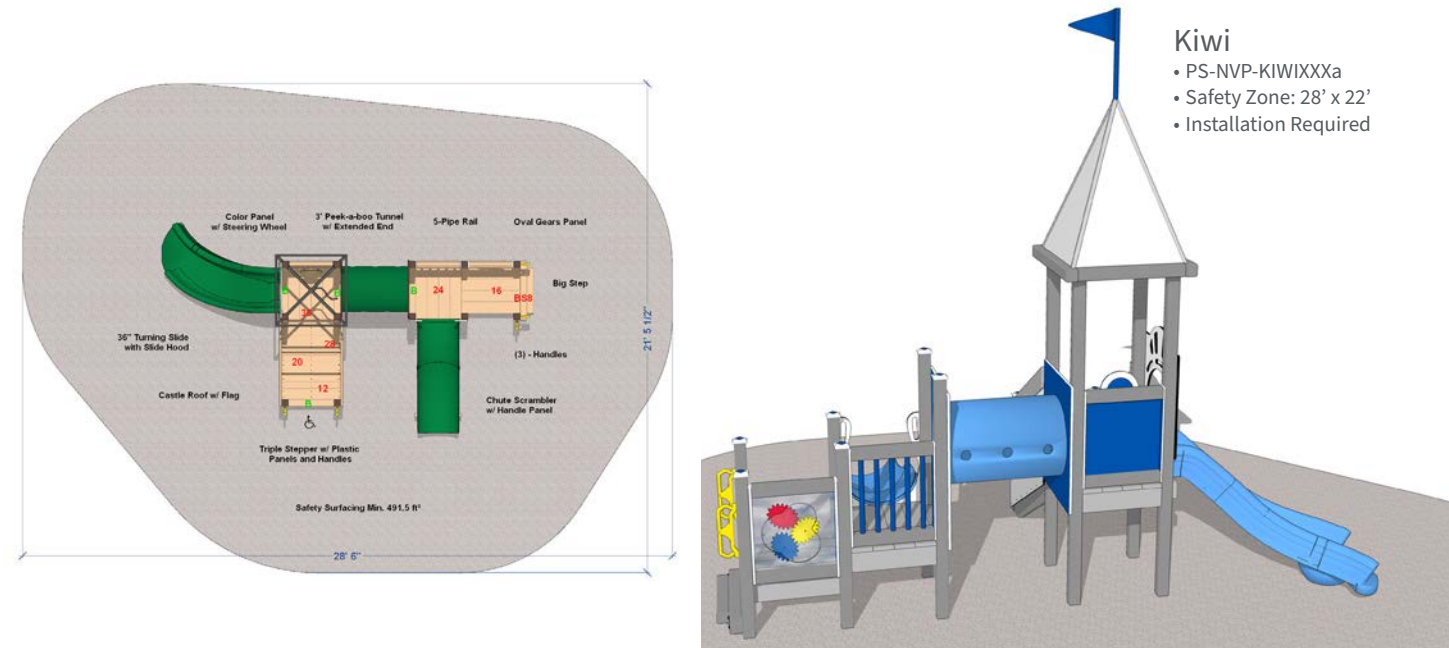

**Sea Turtle**  
• PS-NVP-SEATURTa  
• Safety Zone: 30' x 21'  
• Installation Required

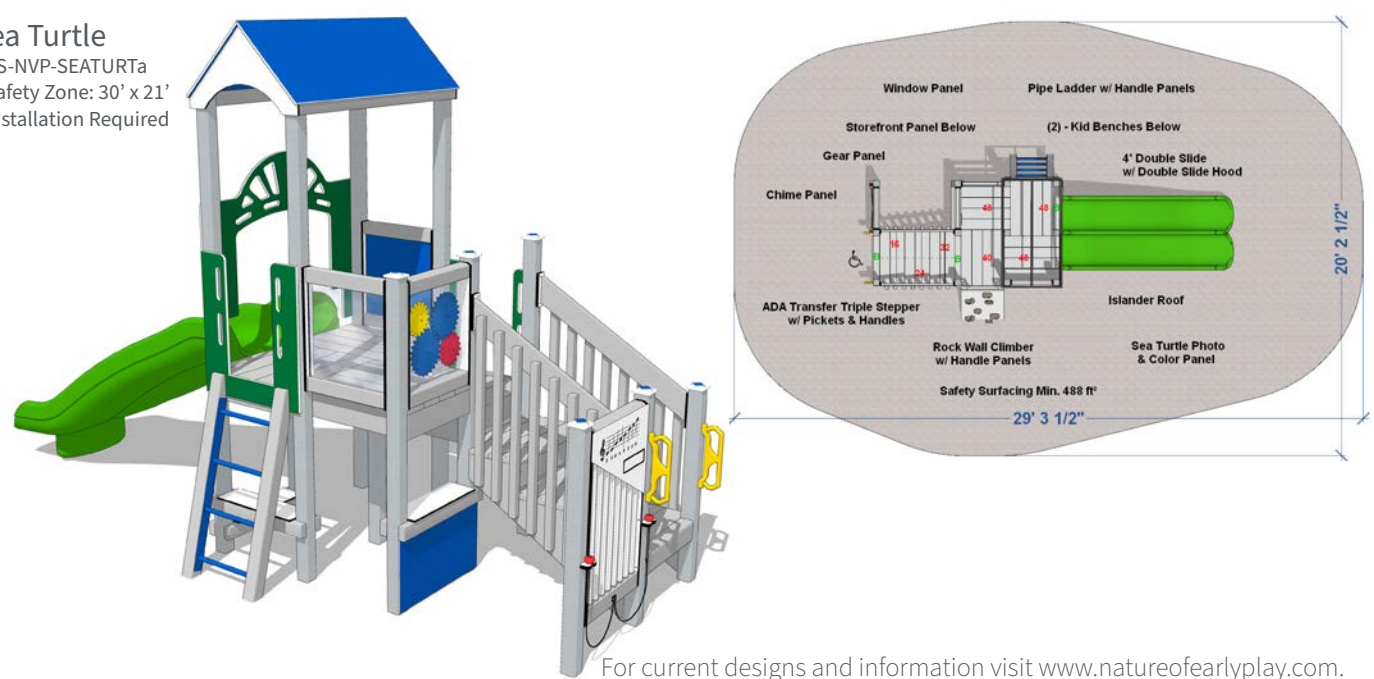

**Grasshopper**  
• PS-NVP-GRASHOPa  
• Safety Zone: 25' x 19'  
• Installation Required





**Zion**  
 • PS-NVP-ZIONXXXa  
 • Safety Zone: 23' x 23'  
 • Installation Required

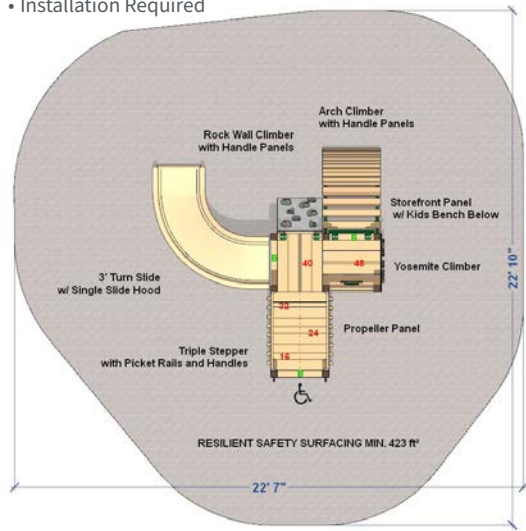

## Transportation



**Canoe**

Whether youngsters want to brave the rapids or spend the day fishing, our Canoe helps build imaginations. Developed by nations all over the world, the canoe played a key role in history. Encourage interest in other cultures by adding this item to your playground. Pair with our Gone Fishin' Cabin to complete the scene! No safety surfacing required for this ground-level component.

- PE-XVPR-CNO-XXa
- 8' L x 2.5' W x 16" H
- Fully Assembled

**Tree Frog**  
 • PS-NVP-TREEFRGa  
 • Safety Zone: 22' x 18'  
 • Installation Required

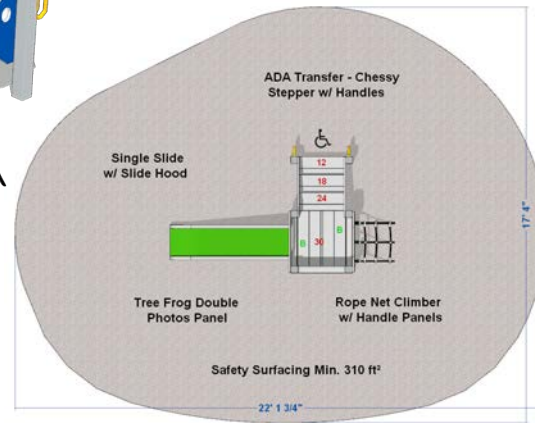

**Mini Car**

Make believe you're driving a car, with a friend! 2 seats, 2 steering wheels, entry step with grab handles and a clear windshield.

- PS-NVT-MINICARa
- Safety Zone: 9' x 11'

- Minimum Safety Surfacing: 99 SF
- 50" L X 33.5" W X 30" H
- Fully Assembled

**Panda**  
 • PS-NVP-PANDAXXa  
 • Safety Zone: 21' x 16'  
 • Installation Required

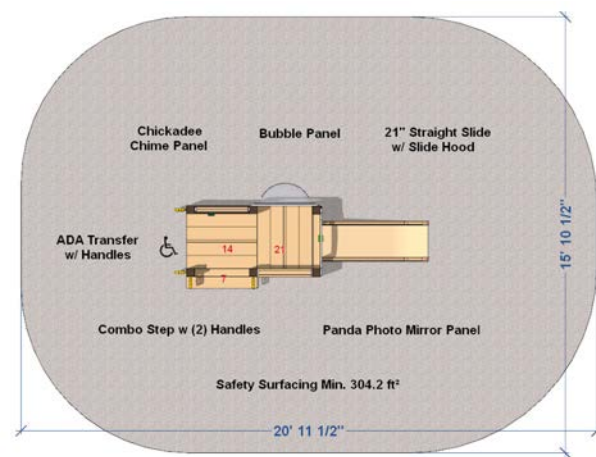

## School Bus

Includes a pod stool for the bus driver, dashboard gauges, steering wheel and windshield.

- PS-NVT-SCHOOLBa
- Safety Zone: 22' x 16'
- Installation Required

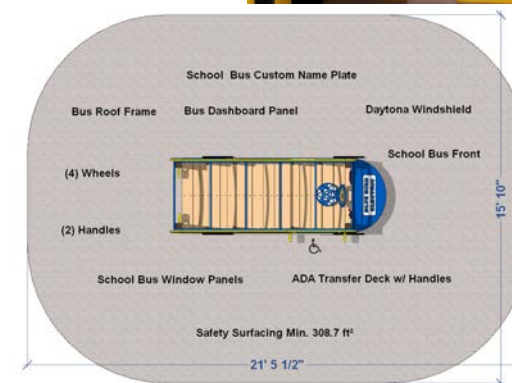



She deserves outside time too.

The youngest ones are often not provided age appropriate, safe outdoor spaces to play. We saw this glaring need and developed a full line of Infant Play Elements that provide safe spaces for children ages 6 months to 23 months to play outside, just like the “big guys”.

Our Infant products are designed for crawling, rolling and toddling babies. A high percentage of other “infant outdoor equipment” is not age appropriate and often does not meet the code written for children age 6- to 23-months (ASTM F2373).

6-23 Months



6-23 Months

Ivy Garden Learning Center  
Michigan Ave. Chicago, IL

Swiss Chalet  
• PS-NVI-SWISSCha  
• Safety Zone: 22' x 18'  
• Installation Required

## Infant Playsets

Our design team focuses on baby skill development, stimulation (but not overstimulating) and the need for safe spaces to crawl, roll and begin walking. We want to challenge babies but not create hazards. You can feel confident letting them explore baby size equipment while soaking up the all-important Vitamin D from sunshine.



Our infant flooring is a new rubberized and slightly padded outdoor high density polyethylene, state-of-the-art material. All of our Infant Playsets have this material for decking / flooring. So, little ones' knees are protected while crawling up, down and around the fun baby spaces.





6-23 Months

6-23 Months



Lacewing

- PS-NVI-LACEWNGa
- Safety Zone: 18' x 18'
- Installation Required

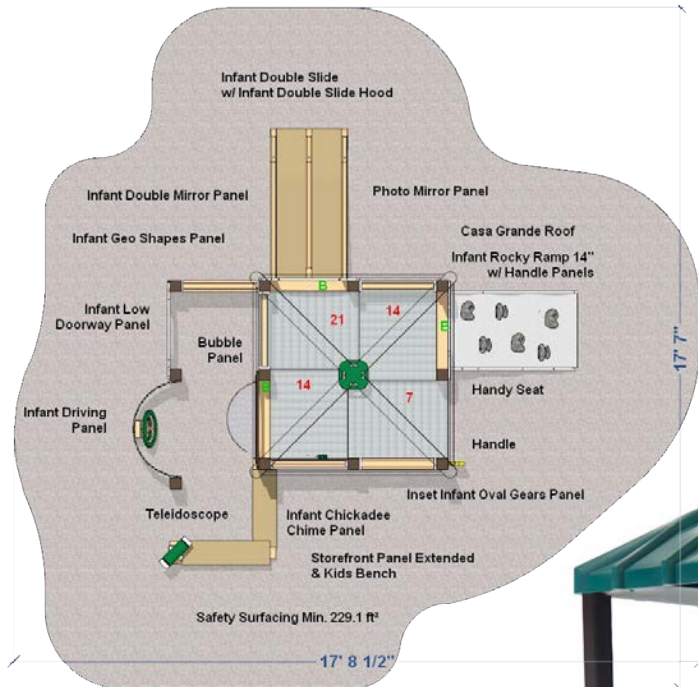

Ducky

- PS-NVI-DUCKYXXa
- Safety Zone: 30' x 21'
- Installation Required

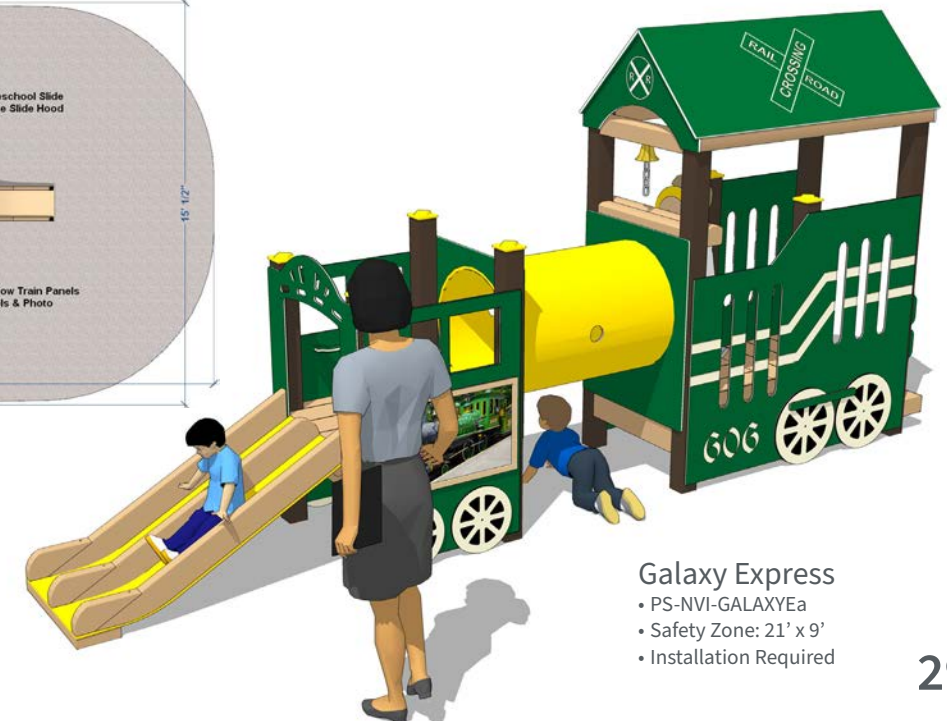
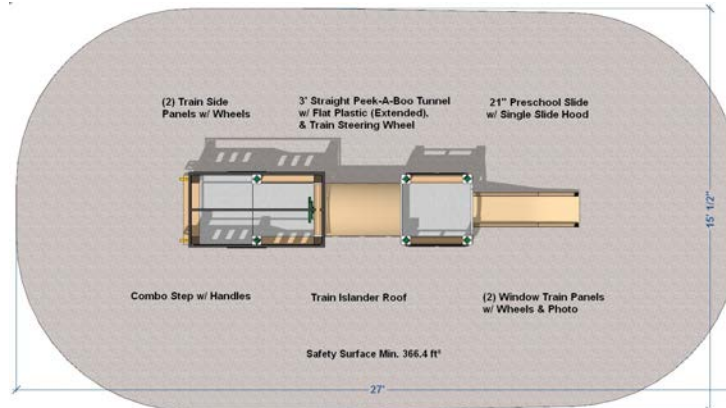
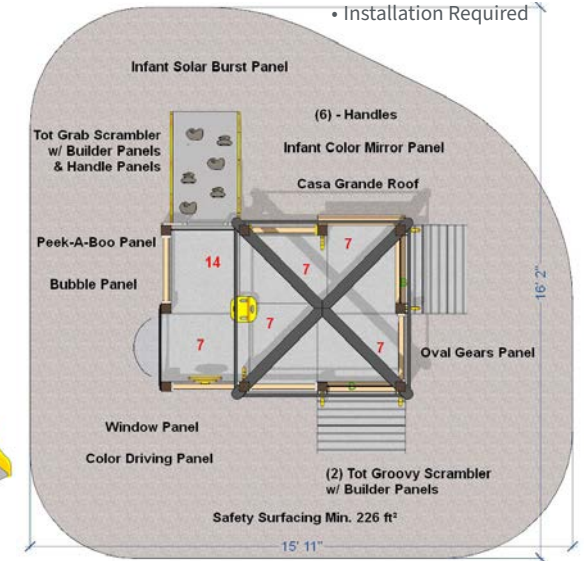

Galaxy Express

- PS-NVI-GALAXYEa
- Safety Zone: 21' x 9'
- Installation Required



6-23 Months

6-23 Months

**Infant Kids Kabin**

- PE-NVI-KIDKABNa
- Safety Zone: 16' 11" - 15' 9"
- Installation Required

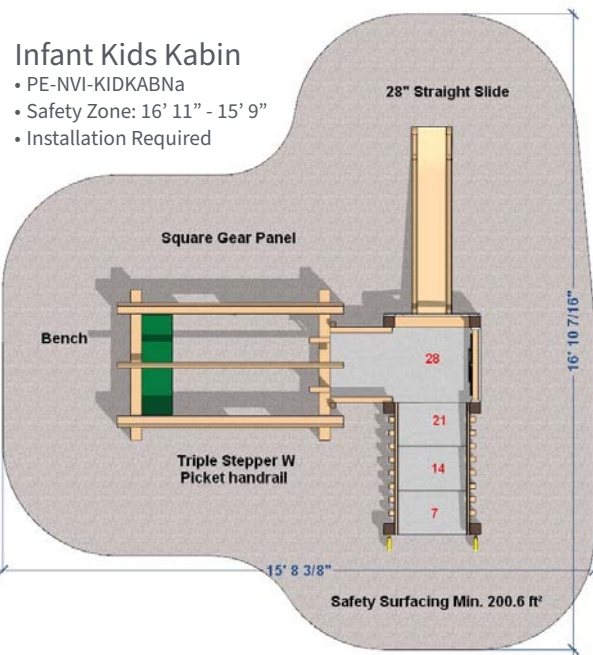

**Fantasia**

- PS-NVI-FANTASIAa
- Safety Zone: 17' x 15'
- Installation Required

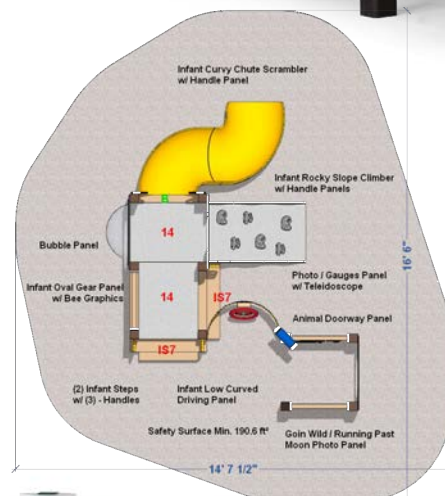

**Tractor**

- PS-NVI-TRACTORa
- Safety Zone: 18' 2" x 9' 1"
- Installation Required

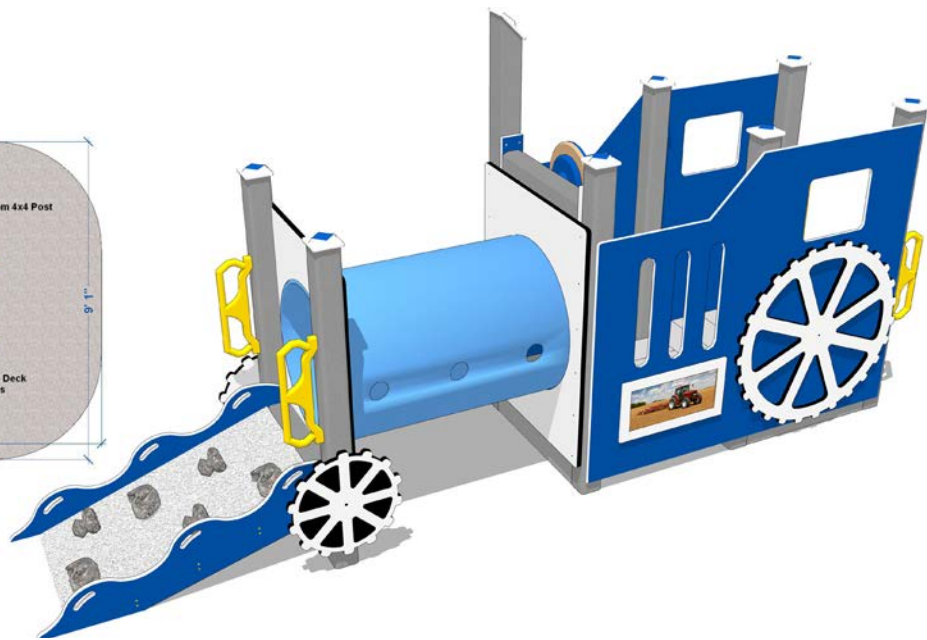
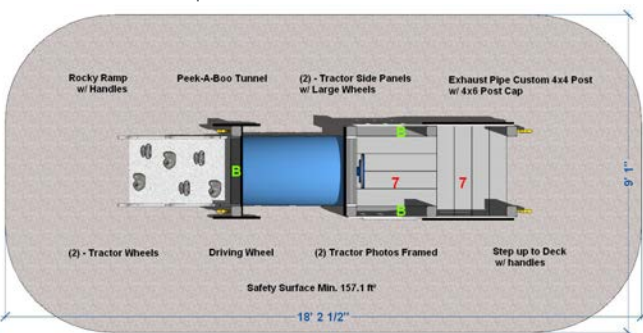

**Tunnel Maze**

- PS-NVI-TUNMAZEa
- Safety Zone: 25' 10" x 11' 5"
- Installation Required

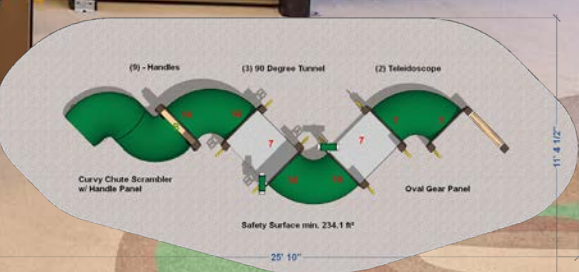

**Choo Choo**

- PS-NVI-CHOOCHOa
- Safety Zone: 9' x 18'
- Installation Required

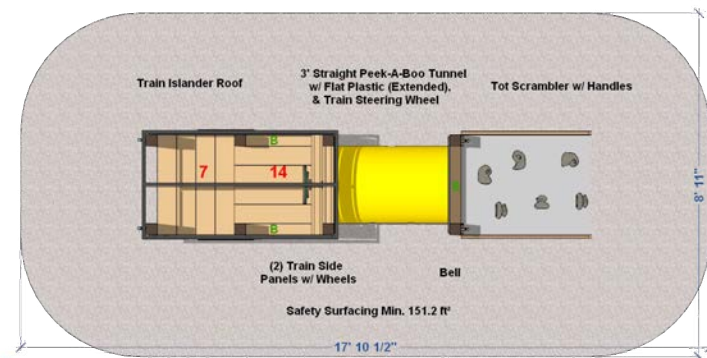
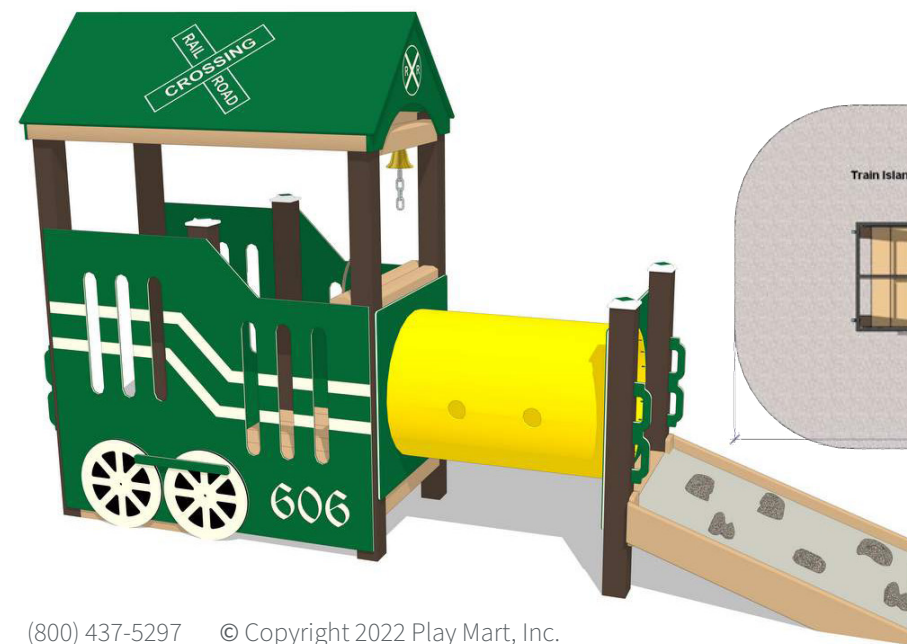



6-23 Months

Noah's Ark with Tunnel

- PS-NNI-NOAHTUNA
- Safety Zone: 17' x 10' 11"
- Installation Required

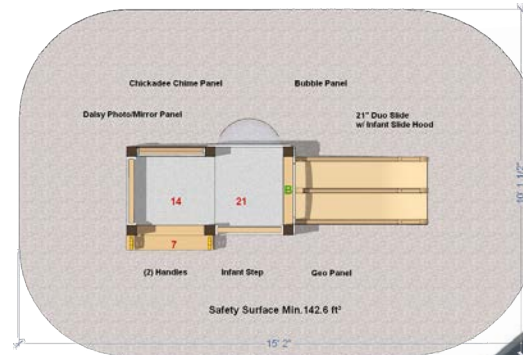
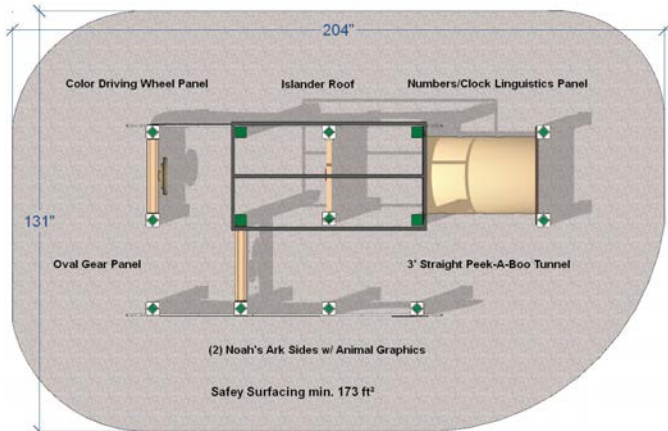

Daisy

- PS-NVI-DAISYXXa
- Safety Zone: 16' x 11'
- Installation Required



6-23 Months

Tiger Swallowtail

- PS-NVI-TSWALLOa
- Safety Zone: 15' x 13'
- Installation Required

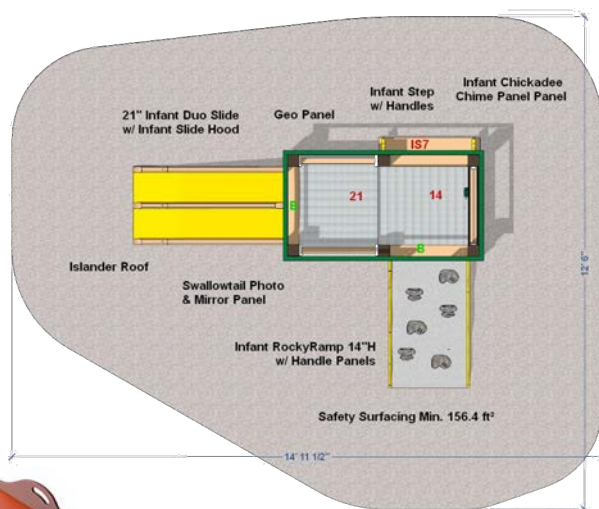

Dragonfly

- PS-NVI-DRGNFLYa
- Safety Zone: 13' x 12'
- Installation Required

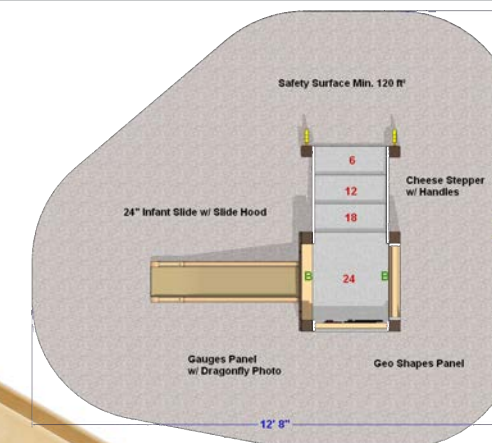

Monarch

- PS-NVI-MONARCHa
- Safety Zone: 15' x 13'
- Installation Required

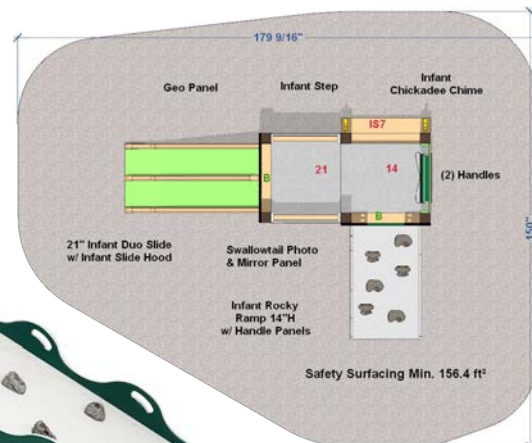

Ney Ney

- PS-NVI-NEYNEYXa
- Safety Zone: 25' x 19'
- Installation Required

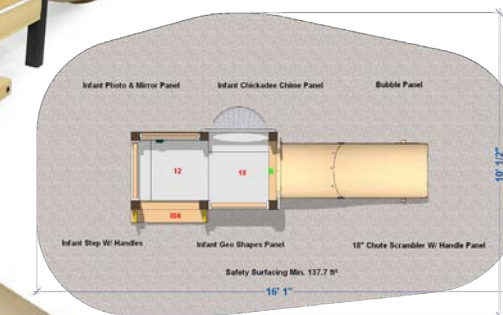



**Snails**  
 • PS-NVI-SNAILSXa  
 • Safety Zone: 15' x 12'  
 • Installation Required



6-23 Months

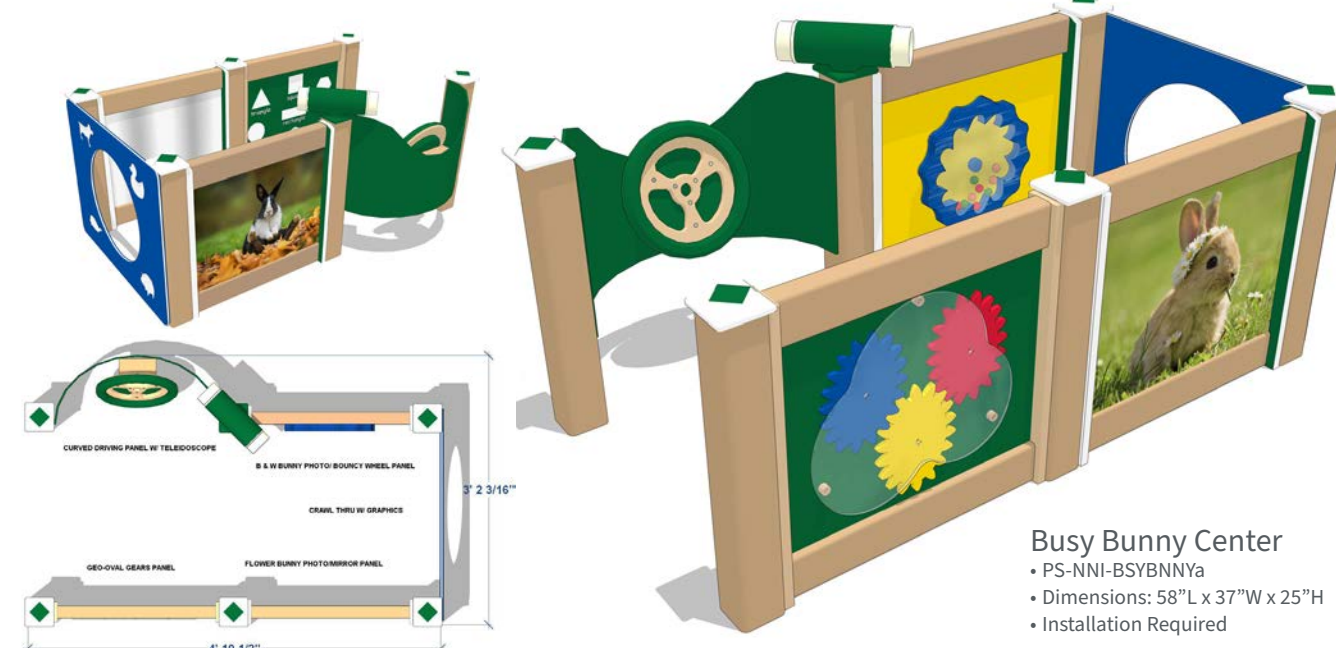

**Busy Bunny Center**  
 • PS-NNI-BSYBNNYA  
 • Dimensions: 58" L x 37" W x 25" H  
 • Installation Required

6-23 Months

**Tiny Hiker**  
 • PS-NVI-TNYHIKRa  
 • Safety Zone: 12' 3" x 9' 5"  
 • Fully Assembled



**Infant Play Elements**

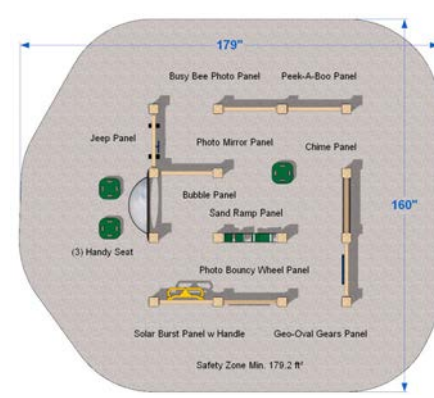

**Cubs and Kittens**  
 • PS-NNI-CUBNKITA  
 • Dimensions: 108" L x 86" W x 32" H  
 • Installation Required

Create your own "Panel Center" design. Choose your favorite Activity Panels on pages 12-13.

**Butterfly Hill**  
 • PS-NVI-BUTTERFa  
 • Safety Zone: 12' 3" x 9' 5"  
 • Fully Assembled



**Pull-Up Bars**

Infants and pre-toddlers can pull themselves up on our redesigned Pull Up Bars. Sure-Grip texture on the steel bars provides a secure hold. Sturdy handles on the posts also help your little ones to practice standing. May be installed in-ground, or surface mounted with brackets, for a modest additional charge.  
 • PE-NNII-PUL-XXa-In  
 • 87" L x 9" W x 24" H  
 • Installation Required  
 (800) 437-5297 © Copyright 2022 Play Mart, Inc.



**Nature Bowl**

Sized for infants. Choose 33" or 40" Diameter Bowl. See page 55 for more sizes and heights.  
 • 40" Diameter Inground: PE-NNTE-NBO-40a-In  
 • 40" Diameter Portable: PE-NNTE-NBO-40a-Port  
 • 33" Diameter Inground: PE-NNTE-NBO-33a-In  
 • 33" Diameter Portable: PE-NNTE-NBO-33a-Port  
 • 33" W or 40" W x 20" H  
 • Inground - Installation Required.  
 • Portable - Assembly Required.



**Nesting Nature Table**

Sized for infants. Sturdy, outdoor tot table for multi-nature themed play that stacks for easy storage. See page 56 for more sizes and heights.  
 • PE-NNBT-NNT-02a  
 • 32" L x 24" W x 17" H  
 • Fully Assembled



**Infant Corrals**

Our Infant Corral is ideal for very young children in the recently-mobile stage to play safely **outside**. Low walls provide support as they learn to stand. Babies gain strength crawling over the Rolling Hills. Curious little fingers can explore the engraved shapes and accessories on the ledges. Includes a 2" thick pad protect to young ones from bumps and bruises. Its marine-quality outdoor fabric is durable, while its long zipper allows easy removal for cleaning. This versatile product assembles easily allowing you to move it indoors in extreme weather months and back outdoors in more pleasant times.

**Infant Corral - 4' x 9' with Ramp**

Low-rise ramp allows babies to safely crawl or toddle in and out of the Corral. Bouncy Ball Spinner is standard - can be swapped for Steering Wheel.

- PE-NNII-PRM-09a
- 113" L x 50" W x 18" H
- Assembly Required

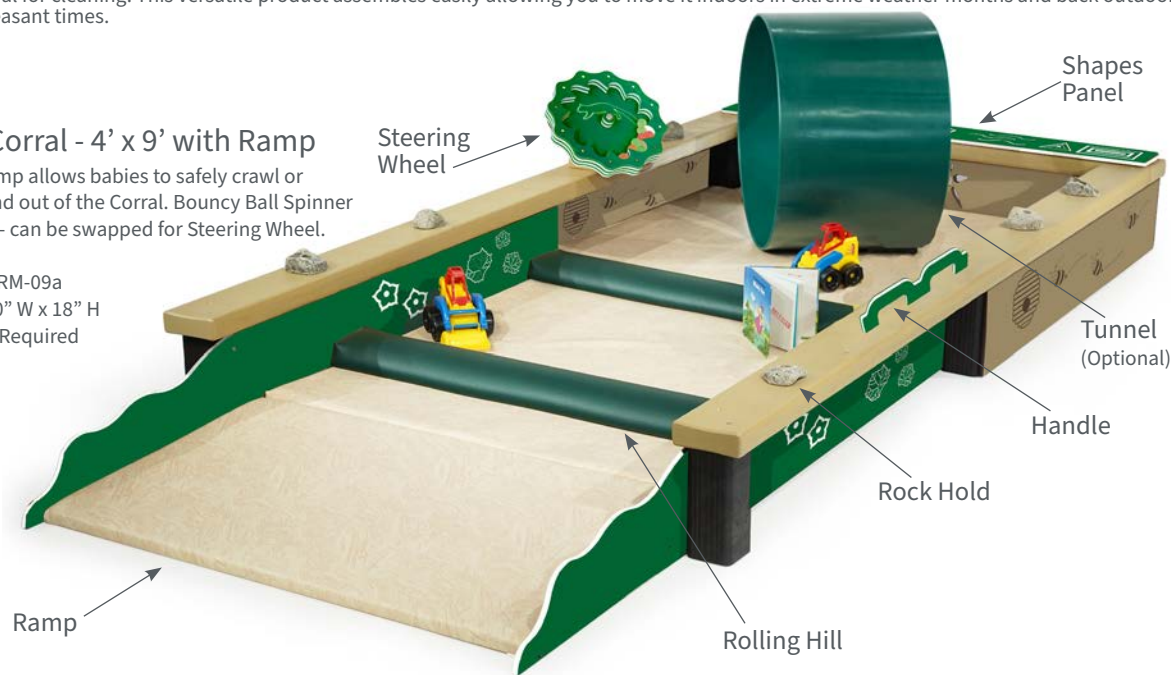

**Infant Corral Included Accessories:**

The Shapes Panel, Bouncy Ball Spinner, Steering Wheel, Rock Holds, Handles, and Rolling Hills create rich tactile, auditory and visual experiences for young ones to develop growing minds and bodies. Tunnels also available. See above.

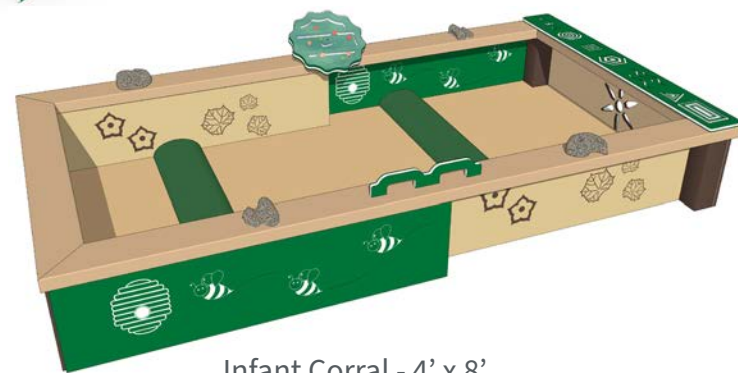
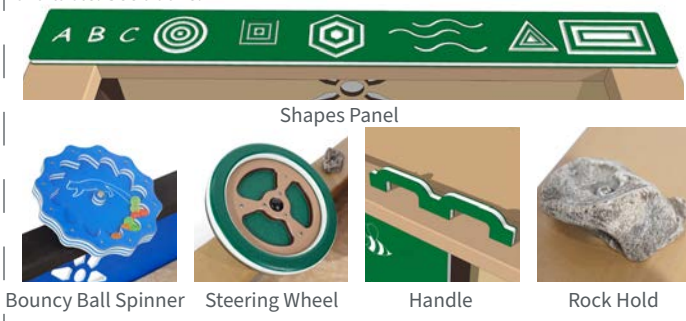

**Infant Corral - 4' x 8'**

This enclosed space keeps young ones from wandering off and protects them in mixed-age group environments. Bouncy Ball Spinner is standard - can be swapped for Steering Wheel.

- PE-NNII-PRM-32a
- 96" L x 50" W x 18" H
- Assembly Required



**Infant Corral - 8' x 9' with Ramp**

Similar to our 4' x 9' Infant Corral above but with twice the padded play space - twice as wide. The ramp allows safe infant access and exit. Includes both the Bouncy Ball

Spinner and Steering Wheel, 8 Rock Holds and 2 Handles.

- PE-XNII-WMS-XXa
- 113" L x 96" W x 18" H
- Assembly Required

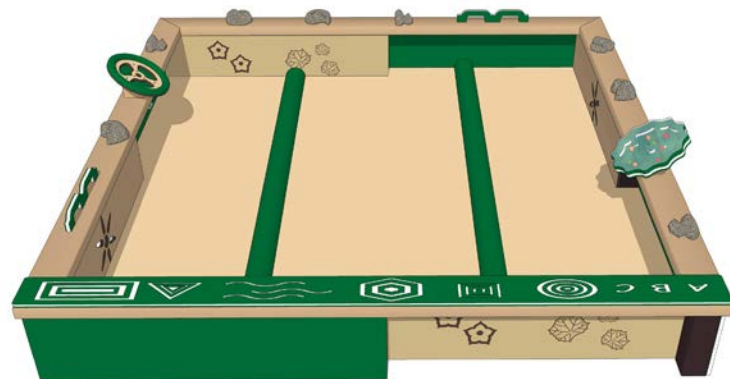

**Infant Corral - 8' x 8'**

This fully enclosed large play corral includes both the Bouncy Ball Spinner and Steering Wheel, 8 Rock Holds and 2 Handles.

- PE-NNII-PRM-64a
- 96" L x 96" W x 18" H
- Assembly Required

**Sensory Cube**

Our Sensory Cube offers tactile and visual stimulation with a variety of shapes and textures. It has one each of the following panels: mirror, rock handles, engraved geometric shapes and a cute bunny photo! The "Infant Abacus" with sliding disc stimulate the sorting, counting and symmetry brain pathways. The bunny's tray can hold various objects for sensory stimulation—shells, leaves, balls, etc. The Sensory Cube also doubles as a Storage Box. The bottom is open, allowing the cube to be flipped over and used for storage. Handy cut-out openings on the top and bottom permit carrying. Sensory Cube is sized for a standing Toddler's chest height. Pre-toddlers can pull themselves up by the rim as it is stable with no sharp edges.

- PE-XNAE-CUB-16b
- 16" L x 16" W x 18" H
- Fully Assembled



**T-Swings and Barrier Walls**

5FT & 6FT high T-Swings available for Infants in addition to the 7'H T-Swings for Preschoolers. Lower swing bar height reduces overall safety zone square footage. Barrier Walls also available for infant age group separation.

- Wall for 5' H: PE-NVIS-WHF-05a, 14' x 13'
- Wall for 6' H: PE-NVIS-WHF-06a, 14' x 17'
- Wall for 7' H: PE-NVIS-WHF-07a, 14' x 21'
- Installation Required



Chain Front Bucket Seat



Full Bucket Seat (Infant)

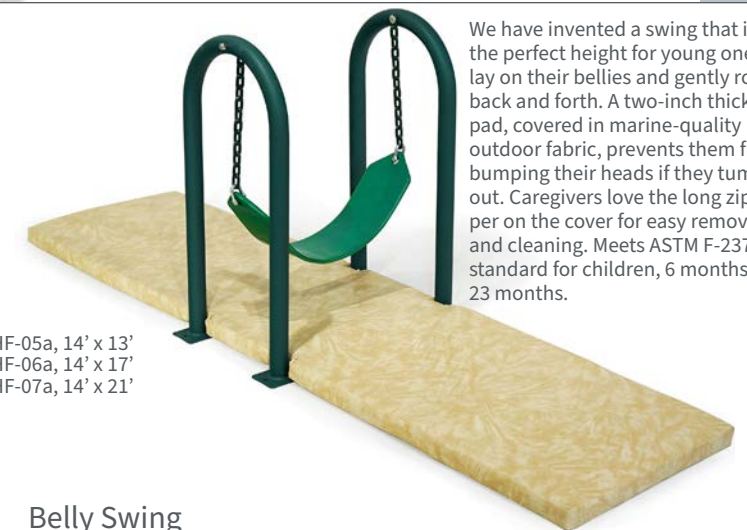

**Belly Swing**

Steel swing frame is powder-coated with Sure-Grip texture. Stainless Steel welds and bottom support plate. Portable or anchored. The chains are coated for safety of small hands.

- PE-XVCS-BEL-XXa
- Included pad beneath the swing measures 78" L x 20" W, and the swing measures 29" H x 24" W.
- Fully Assembled

We have invented a swing that is the perfect height for young ones to lay on their bellies and gently rock back and forth. A two-inch thick pad, covered in marine-quality outdoor fabric, prevents them from bumping their heads if they tumble out. Caregivers love the long zipper on the cover for easy removal and cleaning. Meets ASTM F-2373 standard for children, 6 months to 23 months.

See the rest of our musical playground products on page 57-61.

**Square Chime**

There are no "bad notes" since each chime is tuned to a note on the Pentatonic Scale. So even very small children can make musical sounds without hitting a sour note. Makes experimenting with music fun for all ages and abilities.

- PE-XNAM-SQC-XXa
- 8.5"D x 24"H
- Fully Assembled

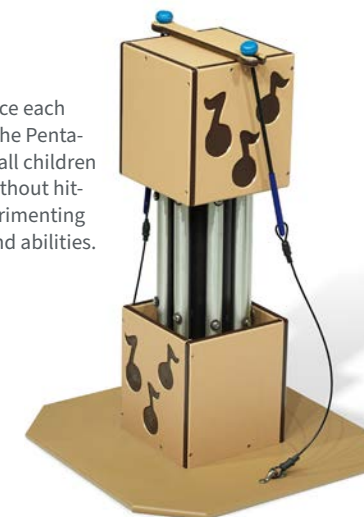

**Single Drum Table**

Professional, heavy-duty, replaceable, REMO drumheads provide excellent sound and performance. They produce deep, sharp tones, and can withstand vigorous hand drumming and even drum sticks!

- PE-XNAM-DT1-XXa
- 22" Diameter. Optional Drum Table heights are adjusted for each age group: 17", 20", 24" or 28"H. See page 59.
- Fully Assembled



## Will he land on both feet?

He has to practice. Encouraging him to start at a young age - balancing and moving in safer environments - will give him the confidence to handle the bigger challenges life throws at him later.



### Fossil Steppers

Create a whimsical playground path with our Fossil Steppers! Each stone-like slab (concrete blend) has fun shapes molded into it. Children can hop from step to step, or your little future archeologists can try to guess what animal or object could be "fossilized" in each design. Sold in sets of 5. Safety Surfacing and Use Zone not required, but recommended for outdoor playgrounds only.

- PE-XVPL-FSL-XXa
- 9" x 11" x 2" each
- Fully Assembled

## Balance

Challenging play for young ones to develop equilibrium and agility on play surfaces above the ground.



### Stepping Log Slices (Set of 10)

Create a whimsical path with our Stepping Log Slices! Each recycled plastic shape has a two-tone, realistic, tree trunk-slice appearance. Each log measures 8 to 12 inches in diameter and is 1/2 inch thick. Safety Surfacing and Use Zone not required, but recommended for outdoor applications only.

- PE-XVAL-LGS-XXa
- 8-12"D X .5"H (each)
- Fully Assembled



### Wood Stepping Stumps (Set of 5)

- PE-XVAL-SS5-XXa
- Approximately 8 inches to 15 inches in diameter and 5-15" in height.
- Safety Use Zone Required.
- Fully Assembled

Our Cedar products are treated with "penetrating wood finish" (Clear Wood Sealer) to help prevent mold and promote product longevity. Wood stumps come with bark on and each piece is unique in its natural condition. No warranties apply to wood products. Natural aging, cracking, splintering and weathering is common to all wood products within one year. To help promote longevity products can be brought indoors seasonally.



### Stepping Stools (Set of 5)

Add these Stepping Stools to your playground, either with a playset or as a stand-alone product. Kids can hop from one to another, then use them as seats. Choose Log, Leaf or Octagon tops. These are engraved Eco-Color Plastic so no worries about splinters or rot! Sold in sets of 5.

- Log: PE-GVPL-LOG-05a, Leaf: PE-GVPL-LEF-05a, Octagon: PE-GVPL-OCT-05a
- Staggered Heights Sized for the appropriate age group
- Safety Use Zone Required.
- Installation Required



### Wood Stepping Slices (Set of 5)

- PE-XVAL-SL5-XXa
- Approximately 8 to 15 inches in diameter and 3-4" in height.
- Fully Assembled



# Balance

Safety surfacing and Use Zones required for all products on these pages when access is not level with walking surface. Less than 18" height acceptable on grass. Above 18" height, safety surfacing required (see pages 86-87).

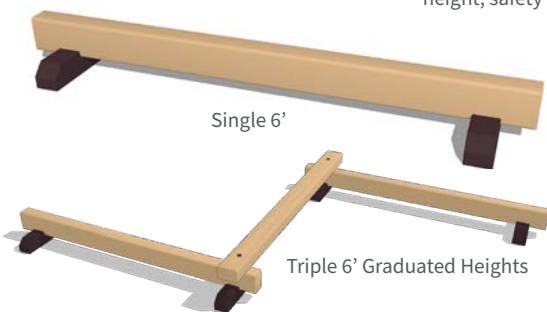

Single 6'

Triple 6' Graduated Heights

## Portable Single or Triple Balance Beam

Walk the gangplank and watch out for alligators! Gain balance while having a blast. Portable bases can also be anchored for additional stability.

- Single 6': PE-NVAL-1BM-06a-Port, Safety Zone 19' x 14'
- Triple 6': PE-NVAL-3BM-06a-Port, Safety Zone 24' x 19'
- Each Beam is 6' L x 4" W x 7" H
- Assembly Required

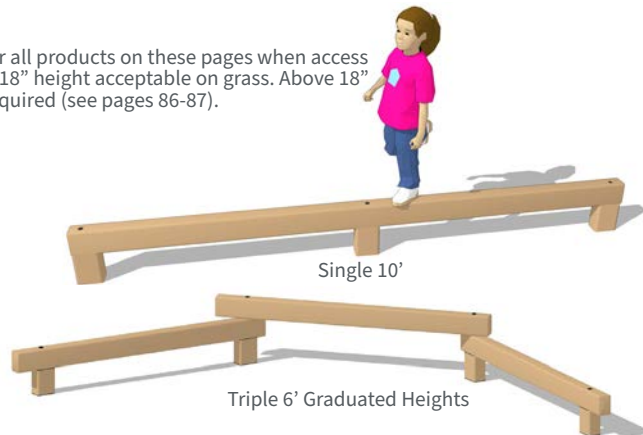

Single 10'

Triple 6' Graduated Heights

## Inground Single or Triple Balance Beam

3 connected balance beams available in graduated or uniform heights. Also available attached to the playset.

- Single 10': PE-XVAL-1BM-10a, Safety Zone: 22' x 13'
- Triple 6': PE-XVAL-3BM-06a, Safety Zone: 22' x 22'
- Triple 10' Graduated Heights: PE-XVAL-3BM-10a
- Triple 10' Uniform Heights: PE-XVAL-3BU-10a
- Each beam is 6' L x 4" w OR 10' L x 4" W
- Installation Required



## Tot Trekker

Mt. Everest climbers start small. Infants and Pre-Toddlers can rhumba their way around the different heights while having something to hold on to. Older children can walk the heights and gain balance skills.

- PE-GVPL-TRK-XXa
- Will be sized appropriately for your specific age groups. 12 inch maximum height for Preschool. 58"L x 74"W
- Installation Required



Comes in any standard color scheme and can have your school, city or park logo added to the horizontal piece for no extra cost.

## Rockcastle

Designed for adventurous preschoolers, this set teaches preliminary rock climbing skills, balance and agility. Challenges abound for all major muscle groups! Arms, legs and neck all get a workout. Real feel rock hand-holds provide tactile stimulation.

- PE-GVPL-ROK-XXa
- 11'L x 2'W x 6'H
- Safety Zone: 23' x 15'
- Installation Required

## Galapagos

The giant Galapagos tortoise is the original namesake of the Galapagos Islands. Our tortoise-shaped playset is a climbing haven of multiple stepping, socializing and imaginative play options for up to 10 children! Small enough for little daycare playgrounds, but large on fun!



### Preschool (3-5 Years): Elevated

- Elevated on frame for an additional climbing challenge for older children.
- PE-GVPR-GLP-XXa
- 98"L x 54"W x 35"H
- Safety Zone: 21' x 17'
- Assembly Required



### Toddler (18-36 months): Ground-level

- PE-GNTR-GLP-XXa
- 98"L x 54"W x 31"H
- Safety Zone: 15' x 11'
- Assembly Required

For current designs and information visit [www.natureofearlyplay.com](http://www.natureofearlyplay.com).



Half Rectangle Rocks

Full Rectangle Rock

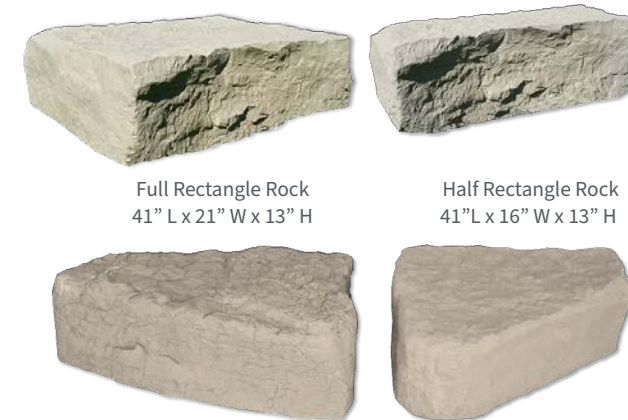

Full Rectangle Rock  
41" L x 21" W x 13" H

Half Rectangle Rock  
41" L x 16" W x 13" H

Right and Left Triangle Rocks, 35" L x 26.5" W x 14" H

## Landscape Rocks

Large real-feel rocks create a natural environment, made from rotomolded HDPE (plastic)

- Full: PE-XVPL-FUL-XXa, Safety Zone: 16' x 15'
- Half: PE-XVPL-HLF-XXa, Safety Zone: 16' x 14'

- Left Triangle: PE-XVPL-LFT-XXa, Safety Zone: 15' x 15'
- Right Triangle: PE-XVPL-RTT-XXa, Safety Zone: 15' x 15'
- Fully Assembled



3' Wide Arch Bridge



4' Wide Arch Bridge

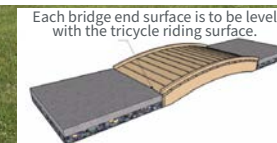

## Arch Bridge

Put our bridge over a shallow creek or on a play path for endless imagination play (troll under the bridge!). Great for Trike Paths. Side edges are raised 2" to prevent trikes from falling into a troll's lair (and to meet ADA accessibility and safety codes). Also available with Flower Face Peek-hole Sides or Picket Rails. Add planters and annuals for a natural look.

4x4 Posts.

- 3' Wide with Flower Face Rails: PE-NVAB-RCF-03a
- 4' Wide: PE-XVAB-TRK-04a
- 4' Wide with Flower Face Rails: PE-NVAB-RCF-04a
- 4' Wide with Picket Rails: PE-NVAB-RCP-04a
- 5' Wide with Flower Face Rails: PE-NVAB-RCF-05a
- 87"L X 3', 4' or 5'W x 51"H
- Installation Required



Picket Rails



5' Wide Arch Bridge  
Compatible with ADA Access Routes.



## Triple Stepper Bridge

Toddlers love to practice their moves up and down steps. The triple stepper gives them lots of balance activities. Very heavy duty, but can be moveable. Available with Flower Face peek-holes. Also available with Picket Rails (right). 4 X 4 Posts with handles.

- Picket Rails: PE-NVAB-TRP-84a
- Flower Faces Rails: PE-NVAB-TRF-84a
- 84"L x 42.75"W x 55"H
- Installation Required



## Balance



Motorcycle

- Roto-molded plastic.
- PE-XVPR-MTR-XXa
  - 23"L x 16"W x 35"H
  - Safety Zone: 14' x 15'
  - Installation Required



Airplane

- Roto-molded plastic.
- PE-XVPR-PLN-XXa
  - 23"L x 21"W x 38"H
  - Safety Zone: 15' x 15'
  - Installation Required



Shark

- Roto-molded plastic.
- PE-XVPR-SHR-XXa
  - 32"L x 19.75"W x 16"H
  - Safety Zone: 14' x 15'
  - Installation Required

## Bouncy Animals and Vehicles

Available with "Super Easy Foundation". Age appropriate for preschoolers (2-5) and up only. The seat height should be installed 14-28" high for preschooler. Safety Surfacing and Safety Use Zone required - may overlap other bouncy Safety Zones. Our Design Department will provide accurate drawings with appropriate spacing.



Whale

- Roto-molded plastic. Available in blue only.
- PE-XVPR-WHL-XXa
  - 32"L x 19.75"W x 16"H
  - Safety Zone: 14' x 15'
  - Installation Required



Frog

- Roto-molded plastic. Available in Green only.
- PE-XVPR-FRG-XXa
  - 34"L x 17"W x 37"H
  - Safety Zone: 14' x 15'
  - Installation Required



Bronco

- Cast Aluminum
- Bronco: PE-XVPR-BRN-XXa
  - Mustang: PE-XVPR-MST-XXa
  - Pony: PE-XVPR-PNY-XXa
  - Zebra: PE-XVPR-ZEB-XXa
  - 32"L x 19.75"W x 16"H, Safety Zone: 13' x 15'
  - Installation Required



Bouncy School Bus

- PE-XVPR-BUS-XXa
- 4"W x 6"L
- Safety Zone: 16' x 18'
- Installation Required



Bouncy Fire Truck

- PE-XVPR-TRK-XXa
- 4"W x 6"L
- Safety Zone: 16' x 18'
- Installation Required

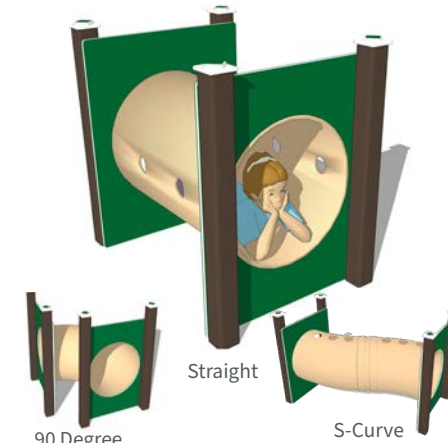

Tunnels

- Tunnels with Peek-A-Boo holes are available in Straight, S-Curve or 90-Degree turn. Safety Surfacing required.
- Straight (above): PE-NVPR-TNL-XXa, 43"L x 31.5"W x 41.5"H
  - 90 Degree (above left): PE-NVPR-TTL-XXa, 42"L x 42"W x 41.5"H
  - S-Curve: PE-NVPR-SCT-XXa, 65"L x 45"W x 46" H
  - Installation Required



See page 37 for T-Swing Infant Barrier Walls

## Swings

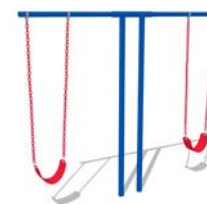

- Single (2 seats)
- PE-XVAS-TFS-07a
  - Safety Zone: 22.5' x 28'
  - Installation Required



- Double (4 seats)
- PE-XVAS-TFD-07a
  - Safety Zone: 28' x 33.5'
  - Installation Required

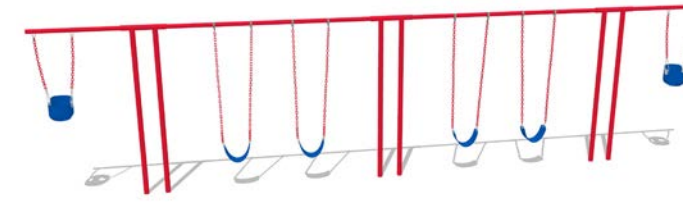

- Triple (6 seats)
- PE-XVAS-TFT-07a
  - Safety Zone: 28' x 45'
  - Installation Required

## T-Swings

T-Swings are space saving and economical but they are made from heavy-duty steel pipe with stainless steel welds and SureGrip poly-coating. 7' Bar Height. Available as Single (2 seats), Double (4 seats), or Triple (6 seats). Choose age appropriate seats below.



- Single (2 seats)
- PE-XVIS-EC1-XXa
  - Safety Zone: 22.5' x 28'
  - Installation Required

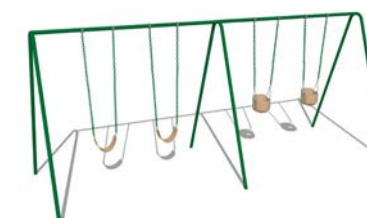

- Double (4 seats)
- PE-XVIS-EC2-XXa
  - Safety Zone: 28' x 32.5'
  - Installation Required



- Triple (6 seats)
- PE-XVIS-EC3-XXa
  - Safety Zone: 28' x 43'
  - Installation Required

## Eco Swings

Economical design for small spaces and a small budget. The smaller use zone always keeps the surfacing minimal with a 7' bar height. Zinc coated steel with 2 3/8" diameter pipes; powder coated with our proprietary wrinkle coat with stainless steel welds. Paint and seats come in a variety of colors. Available as Single (2 seats), Double (4 seats), or Triple (6 seats). Choose age appropriate seats below.



- Tire Swing
- Tire, Chains & Hardware: PE-XVAS-TTC-XXa



- Adaptive Swing Seat (ADA)
- Seat only: PE-XVAS-ADA-XXa
  - Seat, Chains & Hardware: PE-XVAS-ADC-XXa



- Full Bucket Seat (Infant)
- Seat Only: PE-XVIS-BKT-XXa
  - Seat, Chains & Hardware: PE-XVIS-FBC-XXa



- Chain Front Bucket Seat
- Seat Only: PE-XVTS-HLF-XXa
  - Seat, Chains & Hardware: PE-XVTS-CFC-XXa



- Belt Seat
- Stainless steel inserts for longevity.
- Seat only: PE-XVES-BLT-XXa
  - Seat, Chains & Hardware: PE-XVES-BSC-XXa



This is what they really want - fistfuls of mud.

Make it possible with mini gardens right in the play area. Thankfully we also offer clean-up stations to help make the mess go away when they're done.

See our "Water Works" on page 52 - a clean up sink that doesn't need plumbing.



**Raised Garden Bed**

Open-bottom garden beds provide instant garden space. Add a Collapsible Grid to make plant spacing easier.

- Available in two sizes:
- PE-XNAG-BED-04a, 4'L x 2'W x 1'H
- PE-XNAG-BAO-04a, 4'L x 2'W x 19"H (ADA Height)
- Assembly Required



**Gardening**

Bring gardening into play time and let children learn about how plants grow with our no-fuss planters and garden beds – all made from heavy-duty recycled plastic which will not deteriorate with time. Water-impermeable, and unattractive to insects!



20-Pack of Seeds

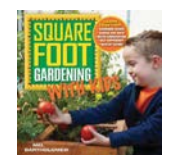

Square Foot Gardening With Kids Book



Moisture Meter



Collapsible Grid

Raised Garden Bed

**Square Foot Gardening Kit**

Includes Raised Garden Bed, Moisture Meter, 20-Pack Seeds, Square Foot Gardening Book and Collapsible Grid. Add potting soil and fertilizer and you have everything you need to start a garden! Reusable planting grid helps separate plants for correct spacing. The grid then collapses for easy storage and reuse.

- Kit: PE-XNAG-SFK-XXa
- Collapsible Grid Only: PE-XNAG-CGG-XXa
- 4'L x 2'W x 1'H
- Assembly Required



**Round Planter**

Full circular planter. No bottom. Standard molded plastic colors available.

- PE-XNAG-RND-XXa
- 30"D x 16"H
- Fully Assembled



**Half Moon Planter**

- PE-XNAG-HLF-XXa
- 24"D x 12"H
- Fully Assembled





**Portable Base**

- For Bird House and Feeder
- House with Post & Portable Base, PE-NNAG-BHS-XXa-Port, 6.5”L x 6.5”W x 48”H
- Feeder with Post & Portable Base, PE-NNAG-BFD-XXa-Port, 7.5”L x 8”W x 48”H
- Assembly Required

**Bird House**

- With or without post. Optional portable base.
- House Only: PE-XNAG-BHS-XXa, 6.5”L x 6.5”W x 12”H, Fully Assembled
- House with Inground Post: PE-NNAG-BHS-XXa-In, 6.5”L x 6.5”W x 72”H, Installation Required

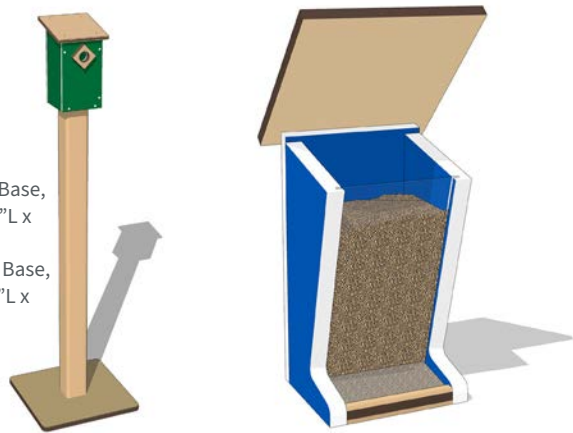

**Bird Feeder**

- With or without post. Optional portable base.
- Feeder Only: PE-NNAG-BFD-XXa, 7.5”L x 8”W x 12”H, Fully Assembled
- Feeder with Inground Post: PE-NNAG-BFD-XXa-In, 7.5”L x 8”W x 72”H, Installation Required

**Gardening**



**Planters**

Our versatile planter boxes are made from recycled, heavy-duty durable plastic and stainless steel hardware. Both materials are perfect for outdoor applications, although great indoors too!

All Planters have a bottom to contain dirt. Planter tops double as lifting edges for easy moving.



**Planter - 2' Cube**

- PE-XNAG-CUB-02a
- 24” x 24” x 24”
- Fully Assembled

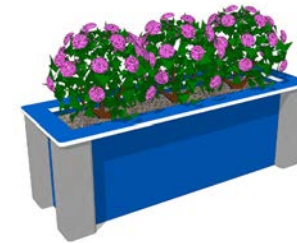

- PE-XNAG-PLN-03a
- 36” x 12” x 12”
- Fully Assembled

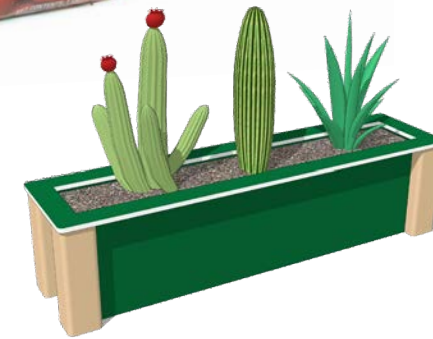

- PE-XNAG-PLN-04a
- 48 x 12” x 12”
- Fully Assembled

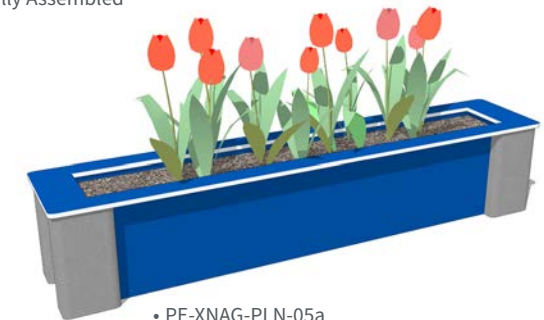

- PE-XNAG-PLN-05a
- 60 x 12” x 12”
- Fully Assembled



**Crossroads Arbor**

- Shown with 2' Cube Planters. Creates a visual focal point.
- PE-XNAG-XRA-XXa
- 102”L x 102”W x 90”H
- Installation Required

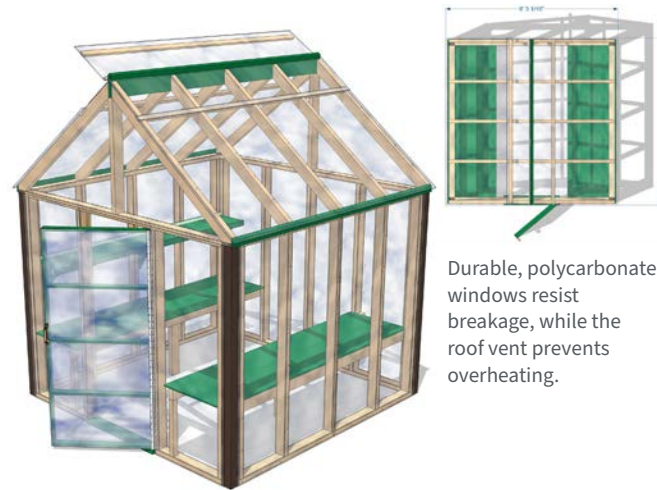

Durable, polycarbonate windows resist breakage, while the roof vent prevents overheating.

**Greenhouse**

- Encourage an appreciation for gardening and plants with this child-sized version of a functional greenhouse. Adults must duck to enter the doorway, but can easily stand inside. Built-in shelf space with plenty of growing room inside.
- PE-XNAG-GRH-XXa
- 8”W x 8”L x 9’4”H
- Installation Required



**Garden Arbor - 6' Child Size**

- English cottage garden arbor. Roof provides partial shade or plant vines in the Modbox Planters (optional, sold separately) to make a shady, secluded space for story time, hiding, resting and dramatic play. Optional Benches on both interior side trellises.
- Arbor only: PE-NNAG-ARO-06a, 5’L x 8”W x 6’H - Child Access Height
- Arbor with Benches: PE-NNAG-ARB-06a, 60”L x 96”W x 72”H
- Arbor with 2 Benches & 2 Planters: PE-NNAG-GAB-06a, 60”L x 120”W x 72”H
- Installation Required



Arbor with ModBox Planters



**Garden Arbor - 8' Adult Size**

- Arbor only: PE-NNAG-ARO-08a, 5’L x 8”W x 8’H - Adult Access Height
- Arbor with Benches: PE-NNAG-ARB-08a, 60”L x 96”W x 96”H
- Arbor with 2 Benches & 2 Planters: PE-NNAG-GAB-08a, 60”L x 120”W x 96”H
- Installation Required



Bring agricultural education into your play space. Various sized planters allow for versatile, portable gardening.



6 FT Long

4 FT Long

**RSP Planters**

- Made from our exclusive RSP (Recycled Structural Plastic) lumber, manufactured in-house. These planters will provide a beautiful sturdy site for your plants to grow.
- PE-XNAG-RSP-48a, 48”L X 24”W X 11”H
- PE-XNAG-RSP-72a, 72”L x 24”W x 11”H
- Assembly Required



Only a child can create a city from sand.

They learn cooperation, ingenuity, pre-engineering concepts, and experience sensory satisfaction - all of this while creating their masterpiece in the sand. We provide a variety of structures that give them easy access to this granular "building material" in your play area.



RSP Sandbox

Sand Play

We make it all – from small Sand Cubes which can be moved inside or outside to large Sand Houses with shade roofs and every size in between. Our elevated Sand Tables offer ADA accessible sand play for young ones as well!

Sand Deck Kitchen

More than a sandbox, our Sand / Deck Kitchen will encourage imaginative play and cooperation. The modular "kitchen appliances" may be interchanged if desired. The Hex Roof is 9 FT across providing nearly 50 sq. ft. of shaded comfort.

- PS-HVP-SNDKKITa
- 10' L x 10'W x 9'H
- Installation Required



ADA Sand Deck Kitchen

Our ADA platform provides a secure transfer area. Kids of all abilities can create pretend meals in this outdoor kitchen! Appliances are fastened securely to the dual Hex posts and may face either inside or outside.

The modular "kitchen appliances" may be interchanged if desired.

- PS-HVP-SANDKITa
- 10' L x 10'W x 9'H
- Installation Required

ADA Sand Deck

A great spot for quiet outdoor play. Whether your children want to create a sandy construction site, or share a picnic lunch on the deck, our Hex Roof is 9 FT across providing nearly 50 sq. ft. of shaded comfort for all. See the Sand Deck Kitchen for ideas on how to customize your Hex set with modular pieces!

- PS-HVP-SANDDEKa
- 10' L x 10'W x 9'H
- Installation Required





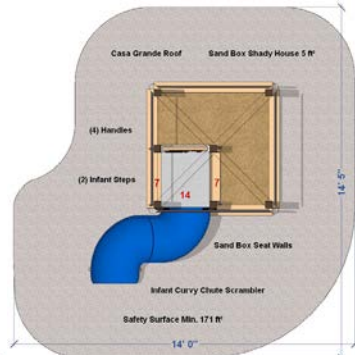
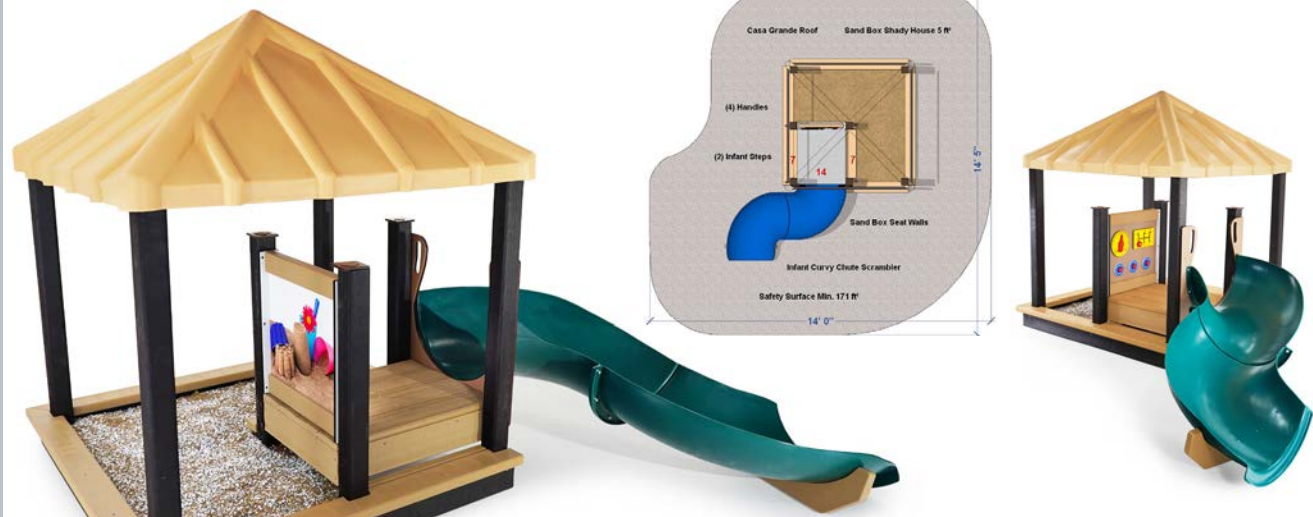

**Shady Sand House**

- Active sliding and climbing combined with sand castle-making equals happy children!
- PS-NVI-SHADYSHA
  - 99" L x 94" W x 85" H
  - Infant Safety Zone: 14' 5" X 14' 1"
  - Preschool Safety Zone: 23' x 23'
  - Installation Required

**Sand Play**

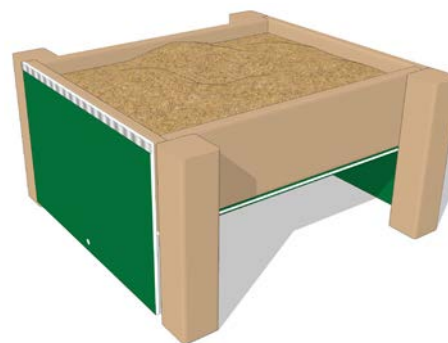

**Sand Table**

- Elevates sand-play to waist height for standing children. Great for ADA Accessible Sand Play. Lids (with finger hole to open) and non-pinching hinges protect sand from critters.
- 24"H: PE-GNPS-TBL-24a, 46" L x 46" W x 24"
  - 28"H: PE-GNES-TBL-28a, 46" L x 46" W x 28" H
  - Assembly Required



Casa Grande Roof

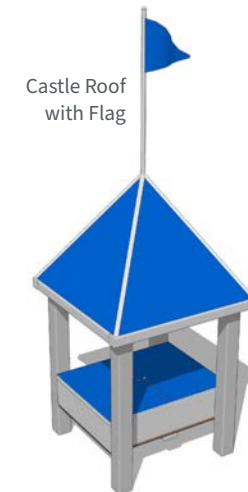

Castle Roof with Flag

**Sand Hut**

- Sandbox with lids that fold on non-pinching hinges to protect sand from the elements and critters. Lid opens with small finger-hole. Choose roof style.
- Casa Grande Roof 24"H: HPE-GNPS-HCG-24a, 64" L x 64" W x 82" H
  - Casa Grande Roof 28"H: PE-GNES-HCG-28a, 64" L x 64" W x 82" H
  - Castle Roof 24"H: PE-GNPS-HTC-24a, 54" L x 54" W x 144" H
  - Castle Roof 28"H: PE-GNES-HTC-28a
  - Assembly Required



**Sand House**

- A whimsical curvy roof covers the 12" high sandbox. Four gently curved corner seats provide seating. Add an optional Fabric Cover (sold separately) for debris-free fun. Durable construction from 2x12 RSP™.
- PE-GNAS-SHS-08a
  - Fabric Cover: PE-XNXS-CVH-08a
  - 91.5" L x 90" W x 88" H
  - Installation Required



**Fabric Cover**

- The reversible marine-grade fabric allows water to pass through to prevent rain puddling. Easy-to-attach hardware it makes covering and uncovering a cinch. The cover also prevents critters from getting in.
- 4' Square: PE-XNXS-CVR-04a
  - 6' Square: PE-XNXS-CVR-06a
  - 8' Square: PE-XNXS-CVR-08a
  - 10' Square: PE-XNXS-CVR-10a
  - 12' Square: PE-XNXS-CVR-12a
  - Fits all 4', 6', 8', 10', 12' Square Sandboxes
  - Assembly Required

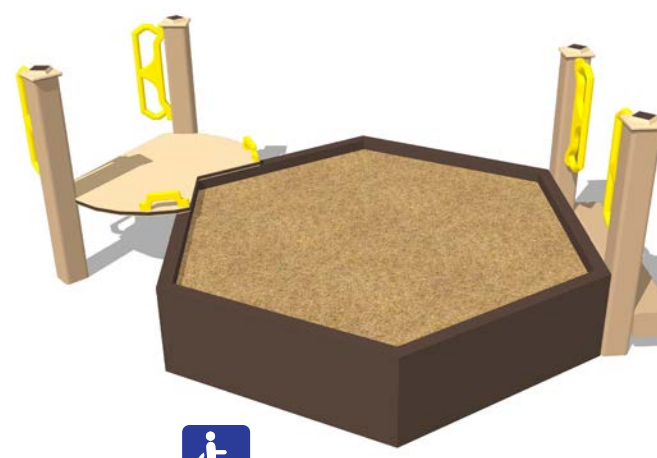

**ADA Sandbox**

- Our ADA platform provides a secure transfer area. Kids of all abilities can enjoy this roomy sandbox!
- PS-HVP-ADASANDA
  - 7' L x 4.5' W
  - Installation Required



**Scalloped Sandbox Cube**

- This versatile sand box allows young children to dig. Getting their hands dirty in sand, dirt, gravel, etc. allows their minds to develop with tactile stimulation and creative play. Scalloped inside edge on top ledge. Fabric Cover Available.
- Sandbox: PE-XNAS-CUB-02a
  - Cover: PE-XNXS-CVR-02a
  - 24" L x 24" W x 24" H
  - Fully Assembled



**Sandbox**

- Low maintenance RSP sandbox is vandal and graffiti-resistant. 6" wide x 12" high seating ledge and gently curved corners.
- 4', 6', 8', 10', 12' Square x 12" H
  - 4 FT: PE-XNAS-BL6-04a
  - 6 FT: PE-XNAS-BL6-06a
  - 8 FT: PE-XNAS-BL6-08a
  - 10 FT: PE-XNAS-BL6-10a
  - 12 FT: PE-XNAS-BL6-12a
  - Assembly Required



**Sandbox with ADA Transfer Deck**

- An ADA Transfer Station with Handles converts our popular square Sandbox into an ADA accessible sandbox. 6" wide x 12" high seating ledge and gently curved corners.
- 4 FT: PE-XVAS-BLD-04a, 7' x 4' x 3'
  - 6 FT: PE-XVAS-BLD-06a, 9' x 6' x 3'
  - 8 FT: PE-XVAS-BLD-08a, 11' x 8' x 3'
  - 10 FT: PE-XVAS-BLD-10a, 13' x 10' x 3'
  - 12 FT: PE-XVAS-BLD-12a, 15' x 12' x 3'
  - Installation Required

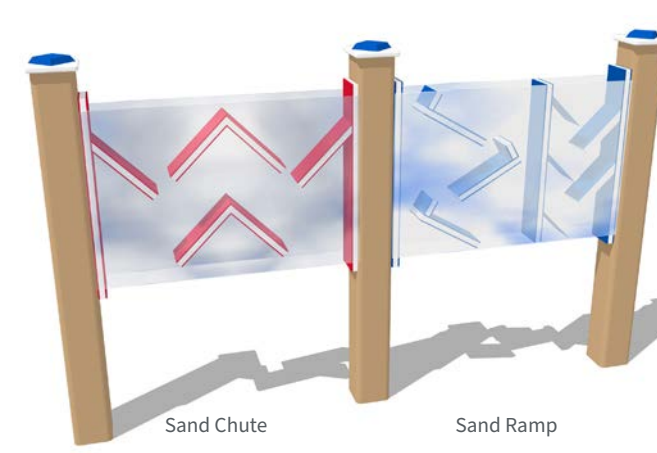

Sand Chute

Sand Ramp

**Sand Chute and Sand Ramp Walls**

- Children can pour sand, water, gravel, small balls, pebbles, etc. through the ramp and chute mazes and watch through clear plastic as the materials dance their way downward. Combine with a sandbox. Each panel available individually or attached.
- Chute Wall: PE-NNAS-CHT-XXa
  - Ramp Wall: PE-NNAS-RMP-XXa
  - Panels: 24" W x 16" H (not including posts) Height adjustable from 24"-36"
  - Installation Required
- (800) 437-5297 © Copyright 2022 Play Mart, Inc.



ADA accessible version

**Sand Digger**

- Digger with rounded handles and bucket loader for construction minded tots. Also available in ADA accessible model with no seat to allow a wheelchair to pull up to the digger handles.
- Digger: PE-XNES-DIG-XXa
  - ADA Digger: PE-XNES-DGA-XXa
  - 7' L x 4.5' W
  - Installation Required



When you can't take them to the beach, we bring it to them.

Playing with natural elements is the truest form of creative play for a child. They are able to physically manipulate the form and flow of sand or water, unlike any other manmade play item.



## Water Play

Since children are fascinated by water we designed products that make it easy to incorporate water play without costly plumbing or time-consuming cleanup! Hand-pumps, water wheels and water bowls all made with heavy-duty easy clean-up recycled materials.



Watermill without Roof

Casa Grande Roof shown on Pumphouse below is standard.



Watermill with Roof

### Watermill

A completely recirculating water wheel play system. The kid-powered wheel and pump fosters cooperation on the playground. The wheel turns in opposite directions to drain into two different water bowls. No need to hook up to any electronics or plumbing! Our Watermill is a completely self-contained system. Filters on hoses and drain-plugs in water bowls provide for easy clean-out. The reservoir beneath is on wheels to easily move and clean it. Includes three

Water Bowls, Roof, Pump & Reservoir. Available with or without roof.

- Compact No Roof: PE-NNPW-MNC-XXa, 108"L x 108"W x 40"H
- Compact with Roof: PE-NNPW-MRC-XXa, 108"L x 108"W x 84"H
- Linear No Roof: PE-NNPW-MNL-XXa, 144"L x 108"W x 40"H
- Linear with Roof: PE-NNPW-MRL-XXa, 144"L x 108"W x 84"H
- Installation Required

**Recirculating filtered water system!**  
NO PLUMBING REQUIRED



Pumphouse with Roof



Pumphouse without Roof

### Pumphouse

Two child-activated pumps fill two troughs leading to two water bowls. Kids can build rock dams in the troughs or sail little boats all while getting wet and staying cool in hot summers. Water returns to a reservoir through tubing, there collecting to be pumped again

through a filtered hose. Available with or without roof.

- Without Roof: PE-NNPW-PHN-XXa, 146"L x 66"W x 40"H
- With Roof: PE-NNPW-PHC-XXa, 146"L x 66"W x 95"H
- Installation Required



### Water Works

Have you wanted to incorporate messy or natural projects into your program, but found clean-up inhibiting? We designed the missing link. Our Water Works clean-up station does not require plumbing!

Our exclusive pump is hand-powered, self-priming, and toddler-proof. It pulls water from the container up into the Stainless Steel sink, then drains back down. The reservoir easily slides out from under the station for emptying or refilling. Or, insert a garden hose into the system to make refilling super easy.

The filter on the pickup hose is easily changeable, inexpensive and locally available. Stainless Steel wash basins are commercial quality and include a stopper.

- PE-NNPW-WRK-XXa
- 42"L x 22"W x 24"H (36"H with pump)
- Assembly Required



# Water Play



Triple - Zig-Zag Configuration  
Shown with Butterfly Pod, sold separately.  
• Inground: PE-NNPW-TZR-48b-In  
• Portable: PE-NNPW-TZR-48b-Port  
• 114”L x 59”W x 42”H

**Recirculating filtered water system!**

NO PLUMBING REQUIRED

## Recirculating Water Trough

Our exclusive recirculating water table is eco-friendly, recycling water instead of using a hose source. Water is hand-pumped from the reservoir into the top trough and pours over low dams from one trough to another. Drain stopper at the low end. Water returns to reservoir from lowest trough via tubing. Reservoir easily drains with drain valve. Add

a Butterfly Pod to give younger children a boost. The Triple Water Trough is available in 3 configurations – Straight, Zigzag or U-Shape.

- Inground versions: Installation Required
- Portable versions: Assembly Required



Triple - “U” Configuration  
• Inground: PE-NNPW-TUR-48b-In  
• Portable: PE-NNPW-TUR-48b-Port  
• 80”L x 59”W x 42”H



Two removable dams in each trough.



Triple - Straight Configuration  
• Inground: PE-NNPW-TSR-48b-In  
• Portable: PE-NNPW-TSR-48b-Port  
• 157”L x 21”W x 42”H

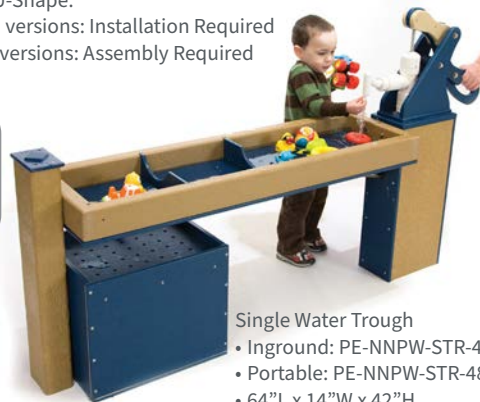

Single Water Trough  
• Inground: PE-NNPW-STR-48b-In  
• Portable: PE-NNPW-STR-48b-Port  
• 64”L x 14”W x 42”H

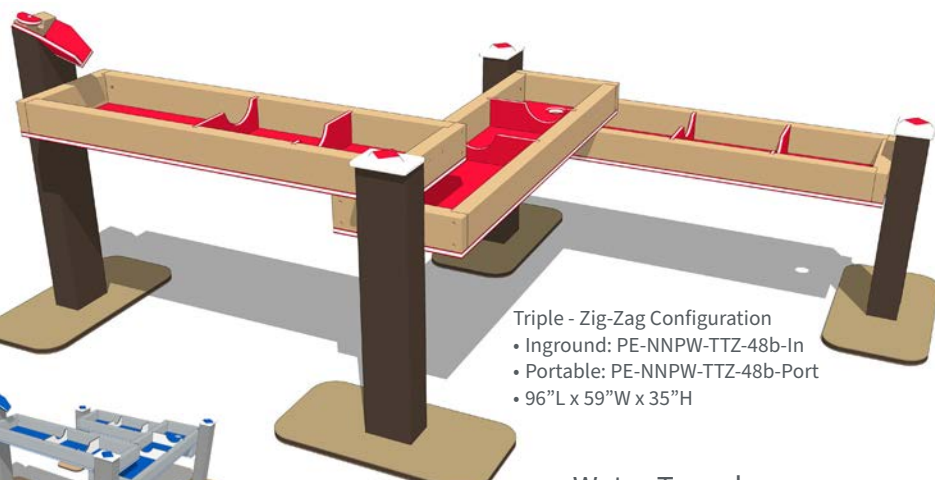

Triple - Zig-Zag Configuration  
• Inground: PE-NNPW-TTZ-48b-In  
• Portable: PE-NNPW-TTZ-48b-Port  
• 96”L x 59”W x 35”H

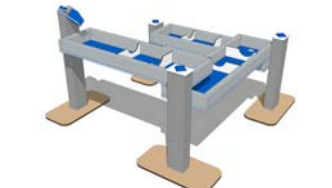

Triple “U” Configuration  
• Inground: PE-NNPW-TTU-48b-In  
• Portable: PE-NNPW-TTU-48b-Port  
• 80”L x 59”W x 35”H

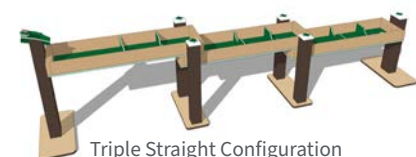

Triple Straight Configuration  
• Inground: PE-NNPW-TTS-48b-In  
• Portable: PE-NNPW-TTS-48b-Port  
• 157”L x 21”W x 35”H



Drain Stopper Included

## Water Trough

Water pours from one trough to another in our Triple Water Trough. Two adjustable “dams” in each trough teach children about gravity and water flow. Drain stopper at low end. The Triple Water Trough is available in 3 configurations - Straight, Zig-Zag or U-Shape. Brings water into the

play space, safely and without extra mess or fuss! All Triple Water Troughs are 35”H without Water Pump or 42” with Pump

- Inground versions: Installation Required
- Portable versions: Assembly Required



Single Water Trough  
• Inground: PE-NNPW-SWT-48b-In  
• Portable: PE-NNPW-SWT-48b-Port  
• 56”L x 14”W x 35”H

**Just attach a hose!**



NO PLUMBING REQUIRED

# Nature Bowls

Our Nature Bowls create a perfect space for children to gather their nature collections and have rich tactile experiences! Create a terrarium with turtles, a pond with tadpoles, fill with bath toys, or make a tidal pool with seashells, water, sand. No worries about cleaning up or starting over. There is a drain plug in the bottom of the bowl. Two optional lid styles (with handles) protect fragile creatures or treasure and keep the elements out of the bowl. All Nature Bowls are available inground (installation required) or portable (assembly required). The height will be sized for the appropriate age group.



Flat Lid with Handles



Bubble Lid with Handles

## Nature Bowl

Choose 33” or 40” diameter bowl for Single Nature Bowl.  
• 33”W or 40”W x 20-24”H (rim height sized for each age group)



## Double Nature Bowl

Bowls measure 24” in diameter (33” • 64” L x 33” W x 20-24” H diameter to outside of rim).

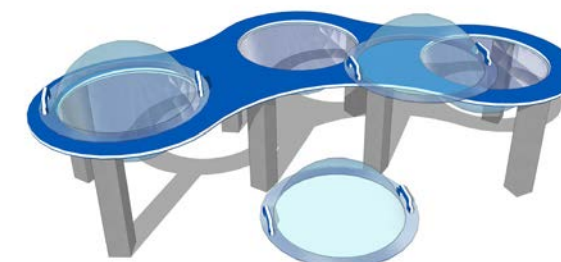

## Triple Nature Bowl

Bowls measure 24” in diameter (33” • 96”L x 48”W x 20”-24”H diameter to outside of rim).

## Spout and Splash

Water is hand-pumped from the reservoir into a Nature Bowl. Water returns to the reservoir by removing a rubber plug in the bottom of the bowl. Available inground (installation required) or portable (assembly required).

- 33 inch Bowl (24 inches inside diameter). 52”L x 33”W x 37”H
- Choose either 20” or 24”H



## Double Spout and Splash

- Optional additional pump (1 for each bowl)
- 64”L x 33”W x 37”H
- Choose either 20” or 24”H

**Recirculating filtered water system!**

NO PLUMBING REQUIRED

## Triple Spout and Splash

- Optional additional pumps (1 for each bowl)
- 96”L x 48”W x 37”H
- Choose either 20” or 24”H



## Spout and Splash with Wheeled Portable Base

Wheeled base allows the Nature Bowl to be easily moved to allow use inside on bad weather days.

- PE-NNTW-SAS-XXa-Wheel
- 52”L x 33”W x 37”H (rim 24”H)
- Assembly Required







## Nature Tables

### Nesting Nature Table

Sturdy, outdoor tot table for multi-nature themed play. Can be used for sand, water, nature collections, loose parts and much more. Table legs nest inside the table below when tables are stacked on each other – at 38 lbs can be lifted by two people. Two will nest in Large Nature Table side-by-side. The reversible lid not only keeps critters out, but has a smooth side with an edge that keeps loose parts from rolling off. The reverse side of the lid has handles that make lifting easy. They also act as a funnel when pouring loose materials into the table compartments to store.



- 17”H: PE-NNBT-NNT-02a
- 20”H: PE-NNTT-NNT-02
- 24”H: PE-NNPT-NNT-02a
- 28”H: PE-NNET-NNT-02a

- Height sized for appropriate age group. 32” L x 24” W x 17” or 20” or 24” or 28” high
- 38 lbs
- Fully Assembled



### Large Nature Table

Double the size of the Nesting Nature Table. Four dividing sections help develop sorting and organization skills. Two reversible lids, both with strategically placed rims and handles to prevent sliding. Wheels on two back table legs roll when lifted by an adult. Water-tight compartments for nature-play of all types.

Wheels on two back table legs roll when lifted.



- 20”H: PE-NNTT-LNT-04a
- 24”H: PE-NNPT-LNT-04a
- 28”H: PE-NNET-LNT-04a
- Height sized for appropriate age group. 48” L x 32” W x 17” or 20” or 24” or 28” H
- 88 lbs
- Fully Assembled



Two reversible lids.



## Music

Bring music into the play space with high quality, true-pitch (tuned) instruments designed by a Grammy Award winning musician, Richard Cooke! Ease of play and the interactive nature of our instruments are at the heart of their versatility. Musical knowledge or skill isn't necessary in order to create beautiful sounds; the instruments are orchestrated to be forever pleasing to the ear; for both the players and those listening nearby.



### Bongo House

Bring the arts to your playground with this innovative playhouse! Our Double Drum Table and Chime Panel provide the music, and our interactive Gear Panel introduces engineering. The Hex roof adds nearly 50 square feet of shade. Includes 2 benches and an ADA Transfer Deck.

- PS-HVP-BONGOHSa
- Safety Zone: 25' 3" x 21'
- Installation Required

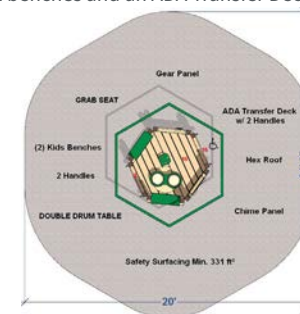

### Melody Cabin

This musical play set showcases outdoor instruments for improvised concerts. Tuned Drums on Angled Stand, the Piper with an Earthy / Percussive tonal quality in C Major Pentatonic scale and a Chime Panel also in Pentatonic Scale. The Hex Roof provides nearly 50 square feet of shade on the large Hex deck musical stage. Outdoor instruments ensure that the show will go on, no matter what the weather! Instruments are made from fiberglass bars, aluminum pipes and heavy duty HDPE plastic with recycled portable bases so

- instruments can be moved.
- PS-HVP-MELODYCa
- 109” L x 94” W x 100” H
- Safety Zone: 25' 3" x 21'

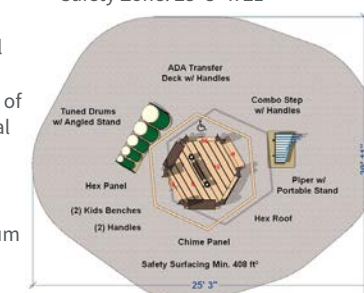



### Wee Jammin' Gazebo

The Hexagon Gazebo roof shelters jam sessions. Includes three attached benches, Mini Chime Panel, Tuned Drums on Stand, and Merry Weenote instrument. The Hex Roof is 9 FT across providing nearly 50 sq. ft. of shaded comfort.

- SA-GNAP-ZBC-XXa
- Gazebo only: 10' L x 10'W x 9'H
- Installation Required



### Harmony Hut

Child sized space with a deck for an outdoor concert includes Tuned Drums on a stand, The Swirl with soothing tones, two Flower instruments with a soft sweet gong sound, and our exclusive Chime Panel tuned to the Pentatonic Scale. Nearly 50 square feet of shade under the roof.

- PS-HVA-HARMONYa
- Safety Zone: 24' x 25'
- Installation Required

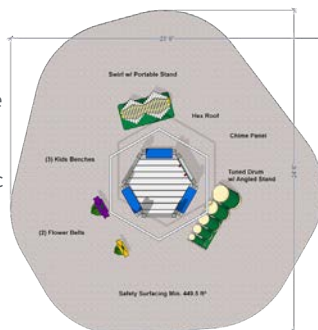

### Tuned Drums

These five tuned hand drums feature replaceable molded heads, ranging from six inches to fifteen inches in diameter. Our Angled Stand holds the drums toward the young percussionist. Available in Elementary/Adult, Toddler/Preschool or Infant/Pre-Toddler sizes. Standard Colors: Green drum tubes with molded caps in Moss Green or Taupe.

These instruments promote physical and mental health. Music play stimulates brain development and function, enhances memory and promotes a sense of well being. It also develops coordination, dexterity, and improves social interactions.

- Infant / Pre-Toddler: PE-XNIM-DRM-STa, 61"L x 27"W x 31"H
- Toddler / Preschool: PE-XNTM-DRM-STa, 61"L x 30"W x 37"H
- Drum Stand: PE-XNAM-STN-XXa
- Assembly Required

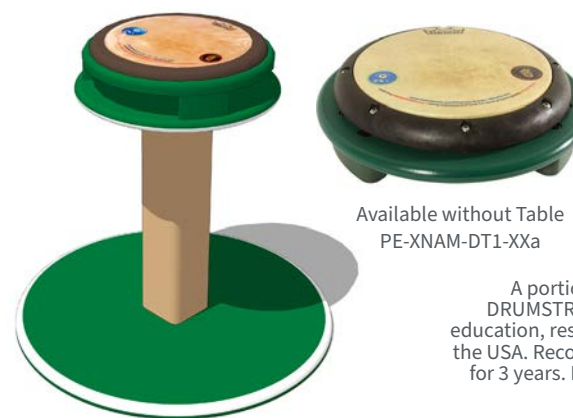

Available without Table  
PE-XNAM-DT1-XXa

A portion of the proceeds supports DRUMSTRONG.ORG, which funds cancer education, research, and survivorship. Crafted in the USA. Recommended for all ages. Warrantied for 3 years. Each Drum head is 10" Diameter.

### Single Drum Table

Professional, heavy-duty, replaceable, REMO drumheads provide excellent sound and performance. They produce deep, sharp tones, and can withstand vigorous hand drumming and even drum sticks!

- 17"H: PE-NNAM-DT1-17a

- 20"H: PE-NNTM-DT1-20a
- 24"H: PE-NNPM-DT1-24a
- 28"H: PE-NNEM-DT1-28a
- 22"Diameter. Height adjusted for each age group: 17", 20", 24" or 28"H
- Assembly Required

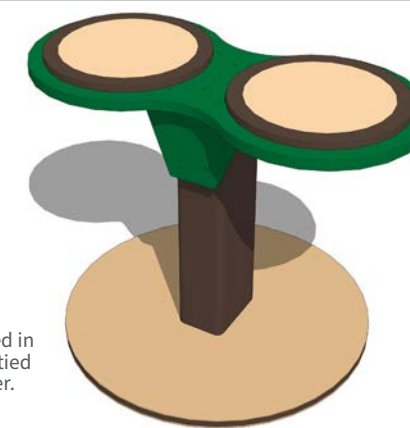

### Double Drum Table

- 17"H: PE-NNCM-DT2-17a
- 20"H: PE-NNTM-DT2-20a
- 24"H: PE-NNPM-DT2-24a
- 28"H: PE-NNEM-DT2-28a

- 27"L x 22"W. Height adjusted for each age group: 17", 20", 24" or 28"H
- Assembly Required



### Square Chime

No bad notes with the pentatonic scale. So even very small children can make musical sounds without hitting a sour note. Makes experimenting with music fun for all ages and abilities.

- PE-XNAM-SQC-XXa
- 8.5"D (not including base) x 24"H
- Fully Assembled



### Chickadee Chime Panel

This smaller version of our Chime Panel is angled back making it easier for young children to strike the chimes. The chimes are tuned to a pentatonic scale – all notes are pleasing together. The mallet (connected securely by a cable to the frame) is light weight and easy for young children to use.

- Inground (Installation Required): PE-NNAM-CHK-XXa-In
- Portable (Assembly Required): PE-NNAM-CHK-XXa-Port
- 24"L x 24"W x 36"H



### Chime Panel

Only high-quality tubing used for smooth, accurate tones for each chime. Eight Chimes play a G Major Pentatonic Scale (many songs can be played on just these 8 notes!). Two mallets attached by cables with bracket keep mallets secured.

- Inground (Installation Required): PE-NNAM-CHM-XXa-In
- Portable (Assembly Required): PE-NNAM-CHM-XXa-Port
- 32"L x 4"W x 44"H



### Triple Drum Table

- 17"H: PE-NNCM-DT3-17a
- 20"H: PE-NNTM-DT3-20a
- 24"H: PE-NNPM-DT3-24a
- 28"H: PE-NNEM-DT3-28a

- 27"L x 27"W. Height adjusted for each age group: 17", 20", 24" or 28"H
- Assembly Required



### Quad Drum Table

- 17"H: PE-NNCM-DT4-17a
- 20"H: PE-NNTM-DT4-20a
- 24"H: PE-NNPM-DT4-24a
- 28"H: PE-NNEM-DT4-28a

- 25"L x 25"W. Height adjusted for each age group: 17", 20", 24" or 28"H
- Assembly Required





**Tenor Tree**

Ringing the aluminum leaves creates bright, sustaining tones in a range of 12 notes divided into three harmonically pleasing chords. Anodized finish on leaves. Three mallets encourage up to three users to create music together.

- PE-NNPM-TRE-XXa
- 25" Diameter x 62"H



**Serenade**

Serenade an audience with the ability to play songs using the color-coded chimes and songbook. Learn to play in 2 different ways: by color or by the annotated notes on the instrument and in the book. The 15 chimes are diatonic and sound so sweet. Every note is pleasant. 6 song book included.

- PE-NNAM-SER-XXa
- 44.5"L x 24"W x 30-44"H

**Music**



**Piper**

The fiberglass bars provide a contrast in tone, to the other instruments. It is a great instrument to play improvised rhythms with. Brown color.

- PE-NNAM-PPR-XXa
- 24.25"L x 26.5"W x 22"-36"H



**Mushrooms**

These charming Mushrooms produce a resounding gong when struck. Anodized caps.

- Large: 28" D x 30"H, PE-XNAM-MSH-LGa, 46lb
- Medium: 24.5" D x 28.5"H, PE-XNAM-MSH-MDa, 42lb
- Small: 20" D x 26.5"H, PE-XNAM-MSH-SMa, 37lb



**Pagoda Bells**

A vertical array of bells that provide lush tones of long duration. Durable and completely maintenance-free, are a calming addition to any outdoor setting. As a park ornament, or as an engaging piece of interactive urban art, this instrument rings with blended tones, focusing attention on any outdoor setting.

- PE-NNAM-BEL-XXa
- 12.25" Diameter x 52-66"H Heights (66" Adult, 62" Ages 7-11, 57" Ages 5-7, 52" Ages 3-5)



**Griffin**

Producing rich full tones, this resonated metallophone has anodized aluminum chimes. The warm tones linger for 3-5 seconds making it similar to finger painting with sound.

- PE-NNAM-GRF-XXa
- 4"L x 26.25"W x 39-60"H



**Melody**

The Melody has a beautiful twinkly sound, with 9 bright, sustaining notes in a small but spicy design. 2 black mallets included. Lime Green.

- PE-NNAM-MEL-XXa
- 16"L x 23.75"W x 22"-36"H



**Rhythm**

Wood-like sounding bars providing the rhythmic sounds of Africa without the maintenance of wood. Also a space saving design with movement inspiring sounds. Color is Cherry Wood.

- PE-NNAM-RYM-XXa
- 15"L x 20"W x 22"-36"H



**Lilypad Cymbals**

These 10 anodized aluminum discs have a very sweet bell tone. The layered placement of the discs will make you want to try dozens of combinations of play. With 3 mallets this can be played by 1-3 players. Each instrument is supplied with durable mallets attached with coated steel cables.

- PE-NNAM-LLY-XXa
- 26"L x 28"W x 24-38"H



**Merry**

This bright sounding instrument, makes a melody with its lyrical voice. It is a smaller version of the Pegasus, one of Harmony Parks best selling original instruments. Green color.

- PE-NNAM-MRY-XXa
- 24.25"L x 26.5"W x 22"-36"H



**Butterfly**

Each butterfly is a different size, height, color, and has 4 different notes of very long, bright sustain. Tuned to C Major Diatonic. They sound like soft sweet gongs. Includes 1 mallet per Butterfly. Colors available: Turquoise, Orange, Indigo, or Yellow. Purchase individually or as a collection.

- Single - PE-XNPM-BTR-XXa
- Collection - PE-XNPM-BTC-XXa
- Range from 16-21"W x 11-13"L x 33-34"H



**Flowers**

Each flower is a different size, height, color, and has 4 different notes of very long sustain on each flower. They sound like soft sweet gongs. Colors available: Turquoise, Orange, Indigo or Yellow.

- Single - PE-XNAM-FLO-XXa
- Collection - PE-XNAM-FLC-XXa
- 19-26"L x 11-15"W x 39-48"H



It's always more fun to color on a rock.

But if you don't have a pile of rocks on hand, we've got chalkboards and paint panels to provide a pretty good second choice.



## Magnetic Chalkboards

Introducing a chalkboard that actually stands up to outdoor use! Our SureGrip™ coated steel chalkboard surface attracts magnets, in addition to being an easy-to-chalk-on surface. Double the product! The SureGrip™ coating resists vandals and cleans very easily with just water. Chalk Trays on each side of the panel provide plenty of storage space for your little artist. Available In-ground (no base plates - installation required) or Portable (with base plates - assembly required). Portable recommended for indoor or wind-protected outdoor use.



Portable Bases  
• 25”L x 8”W x 3/4”H

### 2 Foot Magnetic Chalkboards

Each panel is 24”L x 8”W x 49”H



Single

- Inground: PE-NNPA-MC1-24a-In, 31”L x 8”W x 49”H,
- Portable: PE-NNPA-MC1-24a-Port, 36”L x 33”W x 49”H



Double

- Inground: PE-NNPA-MC2-24a-In, 31”L x 31”W x 49”H
- Portable: PE-NNPA-MC2-24a-Port, 34”L x 34”W x 50”H



Triple

- Inground: PE-NNPA-MC3-24a-In, 59”L x 33”W x 49”H
- Portable: PE-NNPA-MC3-24a-Port, 61”L x 34”W x 50”H



Quadra

- Inground: PE-NNPA-MC4-24a-In, 58”L x 58”W x 49”H
- Portable: PE-NNPA-MC4-24a-Port, 61”L x 61”W x 50”H

### 4 Foot Magnetic Chalkboards

Each panel is 56”L x 8”W x 59”H



Single

- Inground: PE-NNPA-MC1-48a-In, 56”L x 8”W x 49”H
- PE-NNPA-MC1-48a-Port, 58”L x 36”W x 50”H



Double

- Inground: PE-NNPA-MC2-48a-In, 56”L x 8”W x 49”H
- Portable: PE-NNPA-MC2-48a-Port, 73”L x 73”W x 49”H



Triple

- Inground: PE-NNPA-MC3-48a-In, 108”L x 58”W x 49”H
- Portable: PE-NNPA-MC3-48a-Port, 110”L x 73”W x 50”H



Quadra

- Inground: PE-NNPA-MC4-48a-In, 108”L x 108”W x 49”H
- Portable: PE-NNPA-MC4-48a-Port, 110”L x 110”W x 50”H





**4 Foot Paint-Chalkboard Combo**

The perfect combination of some of our most popular items - our 4FT Paint Panel and 4FT Magnetic Chalkboard.

- Inground: PE-NNPA-PCC-48a-IN, 57”L x 57”W x 53”H, Installation Required
- Portable: PE-NNPA-PCC-48a-Port, 72”L x 72”W x 54”H, Assembly Required



**2 Foot Paint-Chalkboard Combo**

Works great to provide multiple types of art canvases in a limited space. Includes a 2FT Magnetic Chalkboard and a 2FT Paint Panel connected.

- Inground: PE-NNPA-PCC-24a-IN, 31”L x 31”W x 49”H, Installation Required
- Portable: PE-NNPA-PCC-24a-Port, 33”L x 33”W x 50”H, Assembly Required

**Paint Panels**

These panels are perfect for indoor or outdoor use! The tough polycarbonate painting surface is easily washable. Standard colors for paint trays are red, yellow, blue, green, and tan. Paint trays with cup holders on each side of the panel hold cups for brushes, paints and water. Available in-ground (no base plates - installation required) or portable (with base plates - assembly required). Portable recommended for indoor or wind-protected outdoor use. Mild cleaners and soft cloth cleaning recommended to preserve each panel’s transparency.



**Portable Bases**  
• 25”L x 8”W x 3/4”H

**2 Foot Paint Panels**

Each panel has 8 built-in cup holders (4 on each side) and is 24”L x 8”W x 49”H.



**Single**

- Inground: PE-NNPA-PP2-24a-IN, 31”L x 8”W x 49”H
- Portable: PE-NNPA-PP2-24a-Port, 33”L x 36”W x 50”H



**Double**

- Inground: PE-NNPA-PP4-24a-IN, 31”L x 31”W x 49”H
- Portable: PE-NNPA-PP4-24a-Port, 34”L x 34”W x 50”H

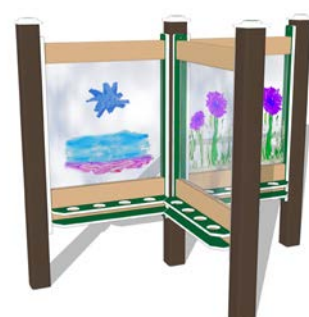

**Triple**

- Inground: PE-NNPA-PP6-24a-IN, 59”L x 33”W x 49”H
- Portable: PE-NNPA-PP6-24a-Port, 61”L x 35”W x 50”H



**Quadra**

- Inground: PE-NNPA-PP8-24a-IN, 59”L x 59”W x 49”H
- Portable: PE-NNPA-PP8-24a-Port, 61”L x 61”W x 50”H

**4 Foot Paint Panels**

Our most popular Paint Panel. Each panel has 14 built-in cup holders and is 56”L x 8”W x 59”H



**Single**

- Inground: PE-NNPA-PP2-48a-IN, 55”L x 8”W x 53”H
- Portable: PE-NNPA-PP2-48a-Port, 57”L x 36”W x 54”H



**Double**

- Inground: PE-NNPA-PP4-48a-IN, 55”L x 55”W x 53”H
- Portable: PE-NNPA-PP4-48a-Port, 73”L x 73”W x 54”H



**Triple**

- Inground: PE-NNPA-PP6-48a-IN, 107”L x 57”W x 53”H
- Portable: PE-NNPA-PP6-48a-Port, 109”L x 73”W x 53”H



**Quadra**

- Inground: PE-NNPA-PP8-48a-IN, 107”L x 107”W x 53”H
- Portable: PE-NNPA-PP8-48a-Port, 109”L x 109”W x 54”H

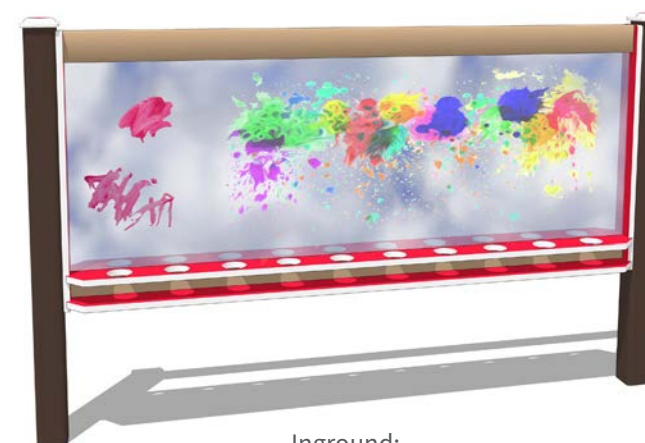

**Inground:**

- PE-NNPA-PP2-72a-IN
- 72”L x 8”W x 49”H
- Installation Required

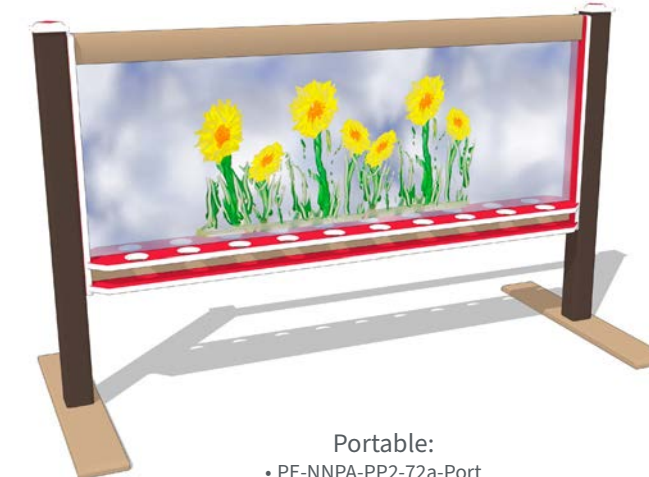

**Portable:**

- PE-NNPA-PP2-72a-Port
- 72”L x 30”W x 50”H
- Assembly Required

**6 Foot Paint Panels**

Extra painting space for more children to collaborate on masterpieces together. One of our most popular Paint Panels! Space for up to 10 young artists! Twenty built-in cup holders (10 on each side) to hold paint brushes, rinse water, etc. Indoor or outdoor, tough Polycarbonate is easily washable. Available In-ground (no base plates) or Portable (with base plates). Sold in single panel configurations only.





Linguistic Panels

Linguistic Panels are available in English, Spanish (bilingual), Cherokee or language of your choice. The interactive Colors panel has moving color knobs to match to the correct color symbols (animals, fruit, plants). The interactive Clock Number panel has a spinning hour-hand arrow to teach children to tell time as well as learn numbers. The Weather Panel's rain, clouds, sunshine, snow and tornado symbols teach weather patterns in different languages. Each panel is available individually or combined in 42" widths. The Linguistic Panel Sets (all three 42" wide panels in a semi-curve) creates a classroom setting, especially when combined with Stepping Stools for seating (see pg. 39, not included). Installation Required.

- 124"L x 20"W x 43-58"H.
- Set of 3 in Cherokee: PE-NNPD-LIC-XXa
- Set of 3 in English: PE-NNPD-LIE-XXa
- Set of 3 in Spanish: PE-NNPD-LIS-XXa
- Set of 3 in Custom Language: PE-NNPD-LIX-XXa



Colors Panel

Slide colored buttons to the matching shape.

- Cherokee: PE-GNPD-COC-XXa
- English: PE-GNPD-COE-XXa
- Spanish: PE-GNPD-COS-XXa
- 42"L x 6"W x 43-56"H
- Inground (Installation Required) or Portable (Assembly Required)

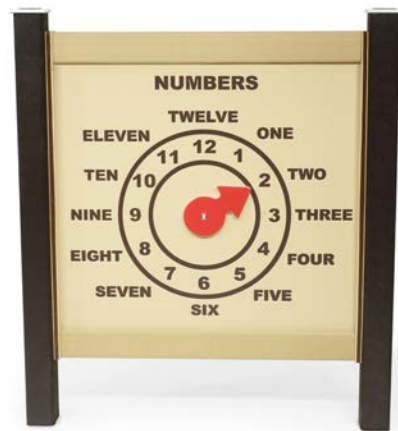

Numbers/Clock Panel

Turn the hour hand to the matching number.

- Cherokee: PE-GNPD-NCC-XXa
- English: PE-GNPD-NCE-XXa
- Spanish: PE-GNPD-NCS-XXa
- Dimensions: 42"L x 6"W x 43-56"H
- Inground (Installation Required) or Portable (Assembly Required)

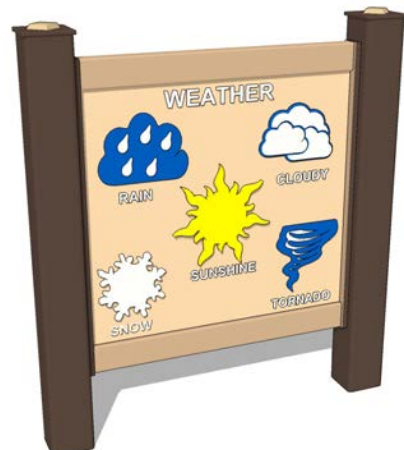

Weather Panel

Learn weather names with their graphics.

- Cherokee: PE-GNPD-WEC-04a
- English: PE-GNPD-WEE-04a
- Spanish: PE-GNPD-WES-04a
- 42"L x 6"W x 43-56"H
- Inground (Installation Required) or Portable (Assembly Required)

Activity Panels

See more of our Activity Panels on pages 12-13.



Gauges Panel

Navigate Safely by monitoring moving gauges.

- Inground: PE-NNPD-GAU-XXa-In, Installation Required
- Portable: PE-NNPD-GAU-XXa-Port, Assembly Required
- 31"L x 4"W x 43"H



Gear Panel

Explore kinetic energy, color and cooperation.

- Inground: PE-NNPD-GER-XXa-In, Installation Required
- Portable: PE-NNPD-GER-XXa-Port, Assembly Required
- 31"L x 4"W x 43"H



Sign Language Panel

Add our freestanding Sign Language Panel to your play area to foster communication among children of all abilities. Official alphabet in ASL.

- Inground: PE-NNPD-SGN-XXa-In, Installation Required
- Portable: PE-NNPD-SGN-XXa-Port, Assembly Required
- 31"L x 4"W x 43"H

Tables



Wheeled for mobility.

Workbench

Sturdy, no-nonsense outdoor workbench is the perfect "project" table for arts & crafts, gardening, etc. Contains a full length shelf below to hold storage bins. Works well with the Water Works (page 52).

- 32"L x 24"W x 20", 24" or 28"H.
- Fully Assembled



No-shelf version for ADA access. See page 15 for details.

Craft Table

The perfect table for children to explore creative projects, while containing the mess. Table top has a raised "lip" to contain crafts with enough room for four or more toddlers or preschoolers. A shelf beneath the table top is the full width of the table for storing supplies.

- 32"L x 32"W x 20", 24" or 28"H. Designed for standing use.
- Fully Assembled

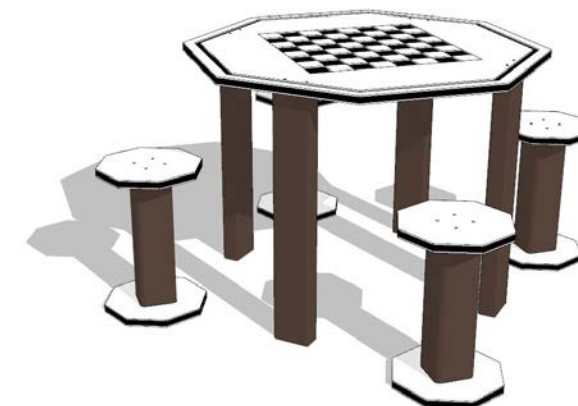

Octagon Game Table

Permanently engraved chess or checkerboard design on tabletop allows for spontaneous game play anytime! Add optional Octagon Stools (Not included. See page 68).

- 40"L x 40"W x 16", 20" or 24"H
- Fully Assembled



Stacking Table

Very stable, with three 2" x 4" triangulated legs that will not rock. Tabletops are made from UV protected heavy-duty 3/4" HDPE.

- 24", 30" or 48" Diameter x 16", 20" or 24"H
- Fully Assembled



Classroom Table

Perfect for indoor or outdoor projects. Extremely sturdy & durable! Get creative, get messy, and clean up with no worries. Color throughout the EcoColor plastic material will not fade with strong cleaners!

- 32"L x 36"W x 14", 16", 20", or 24"H
- Fully Assembled



Wood Table and Benches

Reclaimed cedar treated and sealed with a wood protector to enhance longevity. Natural aging, cracking, splintering and weathering is common to all wood products within one year. Available with or without 2 Slab Leg Benches.

- Approximately 32"L x 18"W x 16", 20", or 24"H
- Fully Assembled



## Tables

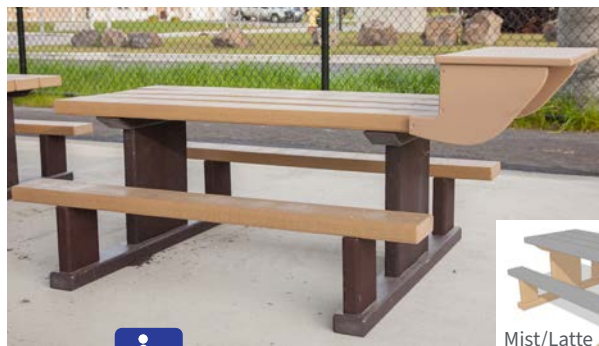

### ADA Picnic Table

Accessible extension on our bestselling Picnic Table allows a wheelchair to fit beneath. Made from heavy duty recycled plastic lumber extruded in-house! Choose Mist/Latte or

Latte/Chocolate colors.

- 48" or 60"L x 34"W x 16", 20" or 26"H
- 26"H is Fully Assembled
- 16", 20"H - Assembly Required



Latte/Chocolate

### Picnic Table

No worries about splinters or rot with this heavy-duty picnic table! Solidly constructed of 100% recycled plastic lumber and stainless steel hardware, this table will last a LONG time. Available in two color

schemes: Mist tops with Latte supports or Latte tops with Chocolate supports.

- 48"L x 34"W x 16", 20", or 24"H
- Fully Assembled

## Seating

Seat and Table Standard Heights by Age Group

AGE GROUP	MONTHS - YEARS	SEAT HEIGHT	TABLE HEIGHT SITTING on GROUND	TABLE HEIGHT SITTING	TABLE HEIGHT STANDING
INFANT & PRE- TODDLER	6 - 23 MONTHS	7"	8"	14"	17"
TODDLER	2 - 5 YEARS	8.75"	12"	16"	20"
	ADA	WHEELCHAIR		22"	
PRESCHOOL	2 - 5 YEARS	10.5"	16"	20"	24"
	ADA	WHEELCHAIR		26"	
ELEMENTARY	5 - 12 YEARS	16"		24"	28"
	ADA	WHEELCHAIR		26"	



### ergo-Eco Bench with Roof

Our popular ergo-Eco Bench, modeled after ergonomic office furniture, with a roof to shade caregivers and parents as they watch their children play in all weather.

- SA-GNDT-BBR-04a - 48"L x 45"D x 76"H
- SA-GNDT-BBR-06a - 72"L x 45"D x 76"H
- Installation Required

## Seating



4 FT ergo-Eco Kid's Bench

### ergo-Eco Kid's Bench

Ergonomically designed for preschoolers, it is light enough for adults to move, and heavy enough to stay put. Made from eco-friendly Recycled Structural Plastic™. Choose Mist/Latte or Latte/Chocolate colors.

- 4FT: SA-XNPT-ERG-04a - 48"L x 14"D x 22.5"H
- 6FT: SA-XNPT-ERG-06A - 72"L x 14"D x 22.5"H
- Seat is 10.5"H
- Fully Assembled



6 FT ergo-Eco Kid's Bench



4 FT ergo-Eco Adult Bench

### ergo-Eco Adult Bench

Our exclusive, luxurious outdoor bench is modeled after ergonomically-minded office furniture, providing superb lumbar support. According to many "testers", this is the bench that "fits all rears!" Parents and care-givers will enjoy relaxing in the shade during recess time on the ergo-EcoBench™ with Roof (above). Side-arms with cup holders only complete the luxury of this oh-so-comfortable bench. Some folks have told us that after they spent



6 FT ergo-Eco Adult Bench

a few moments relaxing on our ergo-EcoBench™ their painful backs actually felt better! We're sure you'll say the same. Sidearms with cup holders sold separately.

- 4FT: SA-XNDT-BNC-04a - 48"L x 30"D x 34"H
- 6FT: SA-XNDT-BNC-06a - 72"L x 30"D x 34"H
- Fully Assembled



### Preschool Flat Bench

Constructed of proprietary RSP™ (Recycled Structural Plastic), this sturdy outdoor bench will provide years of service without warping or fading. May be secured with a

- surface mount kit, sold separately. Mist/Latte or Latte/Chocolate.
- SA-XNPT-BNC-04a
- 48"L x 13"W x 8 3/4"H.
- Fully Assembled



Octagon Pod

Mushroom Pod



Butterfly Pod

### Pod

Sturdy double ended pod can be used as a seat, table, stage, or platform for building blocks, crafts, etc. Available in Butterfly, Mushroom or Octagon shape.

- Butterfly: PE-GNPT-POD-XXa
- Mushroom: PE-GNPT-MUS-XXa
- Octagon: PE-GNPT-OCT-XXa
- 10L"x 10"W x 11"H
- Fully Assembled

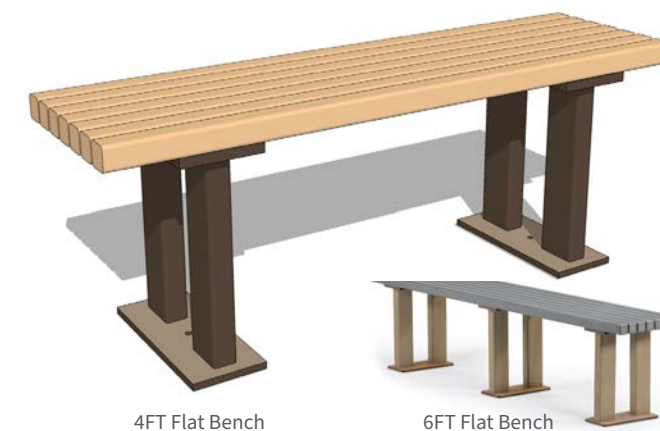

4FT Flat Bench

6FT Flat Bench

### Adult Flat Bench

Available in 4 ft or 6 ft Lengths. Top boards 2"x2". Installation options: In-ground or Surface-mount/Portable. Supports in Latte or Chocolate. Tops in Latte or Mist.

- 4FT: 48"L x 13"D x 18"H
- 6FT: 72"L x 13"D x 18"H
- Fully Assembled



### Octagon Bench

Creates shaded seating around a tree. Various sizes to accommodate different size trees.

- 48" diameter for 18" tree diameter. PE-XNAT-OCT-04a

- 60" diameter for 24" tree diameter. PE-XNAT-OCT-05a
- 72" diameter for 36" tree diameter. PE-XNAT-OCT-06a
- Installation Required



## Seating

No warranties apply to Nature of Early Play's wood products. Wood is subject to natural deterioration over time. Natural aging, cracking, splintering and weathering is common to all wood products within one year. We treat and seal with a wood protector to enhance longevity of our wood products.



### Log Leg Wood Bench

Add our real wood bench to your playground or schoolyard for a touch of nature, letting children appreciate its natural beauty and sensory stimulation. Wood Slab top with Wood Log Legs.

- 2-3 years: 32"L x 10"W x 8.75H, PE-XNTT-WBL-XXa
- 2-5 years: 32"L x 10"W x 10.5H, PE-XNPT-WBL-XXa
- 5-12 years: 32"L x 10"W x 16H, PE-XNET-WBL-XXa
- Fully Assembled



### Slab Leg Wood Bench

Natural wood playground bench for children. Sturdy angled legs keep this bench stable. Each unique Slab Leg Table is approximately 32"L x 10"W.

- 2-3 years: 32"L x 10"W x 8.75H, PE-XNTT-WBS-XXa
- 2-5 years: 32"L x 10"W x 10.5H, PE-XNPT-WBS-XXa
- 5-12 years: 32"L x 10"W x 16H, PE-XNET-WBS-XXa
- Fully Assembled



### Wood Bench with RSP™ Legs

This Wood Bench is assembled with Recycled Structural Plastic bench legs that will last longer than wood – water & insect impermeable. The bench top is wood slab.

- 2-3 years: 32"L x 10"W x 8.75H, PE-XNTT-WBR-XXa
- 2-5 years: 32"L x 10"W x 10.5H, PE-XNPT-WBR-XXa
- 5-12 years: 32"L x 10"W x 16H, PE-XNET-WBR-XXa
- Fully Assembled

## Storage

### Tot Trash Receptacle

This trash receptacle actually fits young children! Teach them to clean up after themselves, and provide a place for them to throw away garbage or recycle. Available with optional recycle-sign on lid.

- PE-XNPC-TRH-XXa
- 24"D x 27"H
- Fully Assembled



### ModBox

Whether they are used as shelves, stepping stools, or planters, these versatile boxes will be in high demand in your play area.

- PE-XNAG-BOX-48a
- 48"L x 12"W x 12"H
- Fully Assembled



Heavy-duty!

### Treasure Trays

Now there's a durable place to store children's treasure collections. Our Sorter has 3 trays that pull out from either side of the frame, removing completely to set on a table. Each tray has 3-6 compartments (Just

move a clear plastic center divider to go from 3 to 6). Clear plastic tray ends allow easy visibility.

- PE-XNAR-TRS-XXa
- 24"L x 16"W x 12"H
- Fully Assembled



10' x 10' Storage Shed



10' x 16' Storage Shed

### Storage Shed

Made with RSP™ (Recycled Structural Plastic) framing and roof purlins, recycled EcoColor™ plastic (HDPE) sheathing for truss and siding, 2 front non-opening windows, optional side windows, shelving and a double primed door (to be painted after installed). Framing Options: RSP™ or Wood frame inside / RSP™ outside. (Wood only available in the USA). Sheds are to be mounted on concrete or asphalt pad only.

- RSP Frame: 10' x 10', 10' x 12' and 10' x 16' Sizes. All sheds 115"H.
- Wood Frame: 10' x 8', 10' x 10', 10' x 12' and 10' x 16' Sizes. All sheds 115"H.
- Installation Required



### Upright Storage Cabinet

Perfect storage solution for Outdoor Classrooms. Storage Cabinet made for the outdoors from heavy-duty recycled plastic and stainless steel hinges and hardware. Locking

- handle. Four (4) adjustable shelves.
- PE-XNAR-USC-XXa
- 28"D x 48"W x 72.5"H.
- Fully Assembled



### Storage Cabinet

Storage Cabinet made for the outdoors from heavy-duty recycled plastic and stainless steel hardware. Perfect storage solution for Outdoor Classrooms.

- PE-XNAR-SCB-XXa
- 24"L x 72"W x 36"H
- Fully Assembled



### Storage Bench

Waterproof storage and seating solution. Protects stored toys or craft projects from the weather. The bench lid has hydraulic hinges to make lifting and closing the lid easy,

as well as protect small hands and fingers from getting smashed.

- PE-XNAR-SBN-04a
- 48"L x 16"W x 14"H
- Fully Assembled



### Storage Cart

Hold art & craft supplies inside or outside. Four cup holders hold paintbrushes or markers. Double-sliding doors can be locked with an additional inexpensive lock. Two spacious shelves. Heavy-duty caster wheels.

- 24"H: 42"L x 27"W, PE-XNAR-CRT-02a
- 36"H: 42"L x 27"W, PE-XNAR-CRT-03a
- Fully Assembled



# Shelters

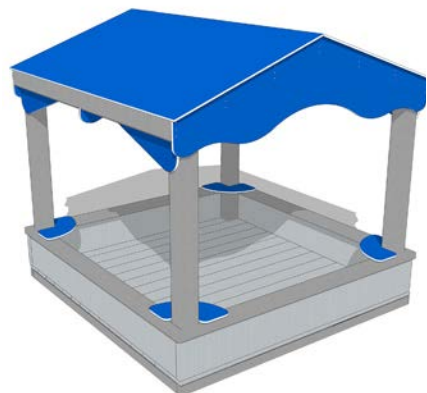

**Tot House**

Solid deck with low walls that double as seating. Rounded corner accent seats.

- PE-NNTP-TPH-XXa
- 91”L x 90”W x 82”H
- Installation Required

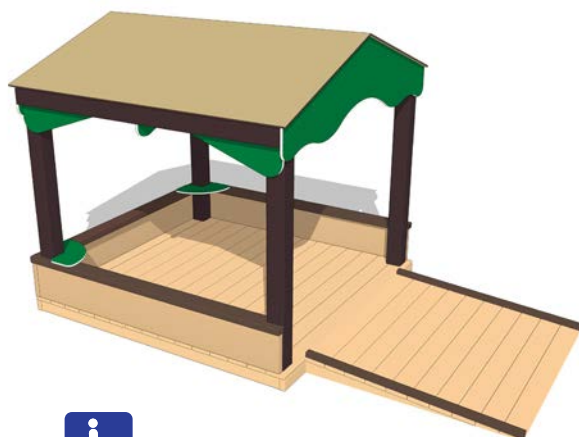

**Tot House with Ramp**

Solid deck with low walls that double as seating. Rounded corner accent seats. The ramp provides additional accessibility.

- PE-NNTP-THR-XXa
- 151”L x 90”W x 82”H
- Installation Required

## Picnic House

Standalone Roof for shaded picnicing. Tables sold separately.

- PE-GNAP-PCH-XXa
- 91.5”L x 90”W x 99”H
- Installation Required



**Drama Deck with Ramp & Trellis**

# Play Stages

Children exercise their creativity by putting on shows, dancing, acting, singing, or telling stories. Our Play Stages are also an excellent option for outdoor instruction or demonstration areas. ADA compliant with an ADA curb to prevent wheelchairs from rolling off. Make it even more ADA friendly by butting the ramp up to an accessible sidewalk. Made of Recycled Structural Plastic™ lumber, so it won't weather or splinter like wood.

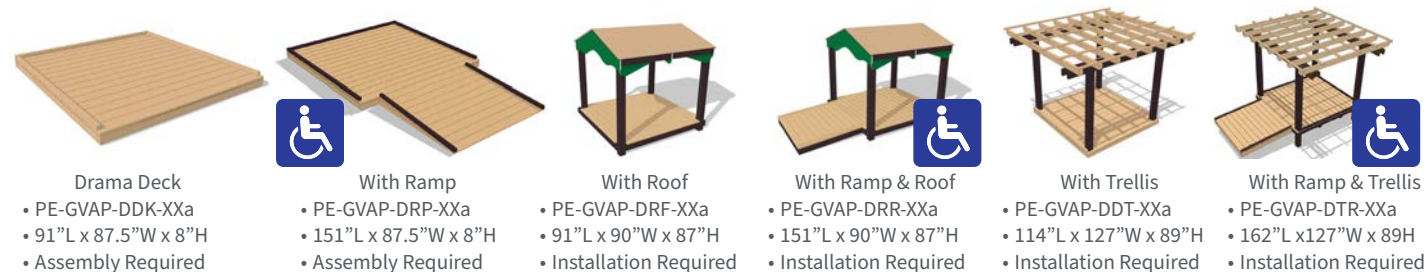

- Drama Deck**  
• PE-GVAP-DDK-XXa  
• 91”L x 87.5”W x 8”H  
• Assembly Required
- With Ramp** (ADA icon)  
• PE-GVAP-DRP-XXa  
• 151”L x 87.5”W x 8”H  
• Assembly Required
- With Roof**  
• PE-GVAP-DRF-XXa  
• 91”L x 90”W x 87”H  
• Installation Required
- With Ramp & Roof** (ADA icon)  
• PE-GVAP-DRR-XXa  
• 151”L x 90”W x 87”H  
• Installation Required
- With Trellis**  
• PE-GVAP-DDT-XXa  
• 114”L x 127”W x 89”H  
• Installation Required
- With Ramp & Trellis** (ADA icon)  
• PE-GVAP-DTR-XXa  
• 162”L x 127”W x 89”H  
• Installation Required

## Drama Deck

Our Complete Drama Deck with Trellis & Ramp is the perfect complement to an early childhood outdoor classroom. The Drama Deck ramp makes it an accessible children's outdoor theater for actors of all ages and abilities. The Drama Deck is an impressive piece of equipment with massive 6” x 6” posts; the trellis is 2” x 6” reinforced with stainless steel for rigidity and structural integrity for a lifetime of use. For a more natural look, we can also include planter boxes to plant hardy vines for a continual green look. Installation is required for all Drama Deck configurations.

# Play Stages



## Amphitheater Package

Add the Amphitheater Package to any Drama Deck to create a child-sized Amphitheater. Includes Tuned Drum (set of 5 on Stand), Chickadee Chime Panel, and 3 Flat Benches (4'L). Drama Deck not included.

- PE-XNPP-AMP-XXa
- Assembly Required



## Story House Package

Add a Story House Package to any Drama Deck to create an intimate reading nook for a small classroom. Includes 2 Story House Benches, Reading Easel and Teacher's Stool. Drama Deck not included. Story House

curve benches sold individually as well.

- PE-XNPP-SHP-XXa
- Assembly Required





**Master Kitchen**

This set is available with a Faucet Sink (shown above - attach a hose for water source) or a Recirculating Pump Sink (pump pulls water from included reservoir).

- Faucet Sink: PS-XNA-MKMSFAUa
- 89" L x 80" W x 48" H
- Assembly Required

**Mud Kitchen Sets**

Culinary-inclined children can enjoy our Mud Kitchen Collection! Future chefs will appreciate the numerous features, including a pretend stove, microwave, and refrigerator; pot racks; plenty of shelf storage, and counter space. There is even a working sink!

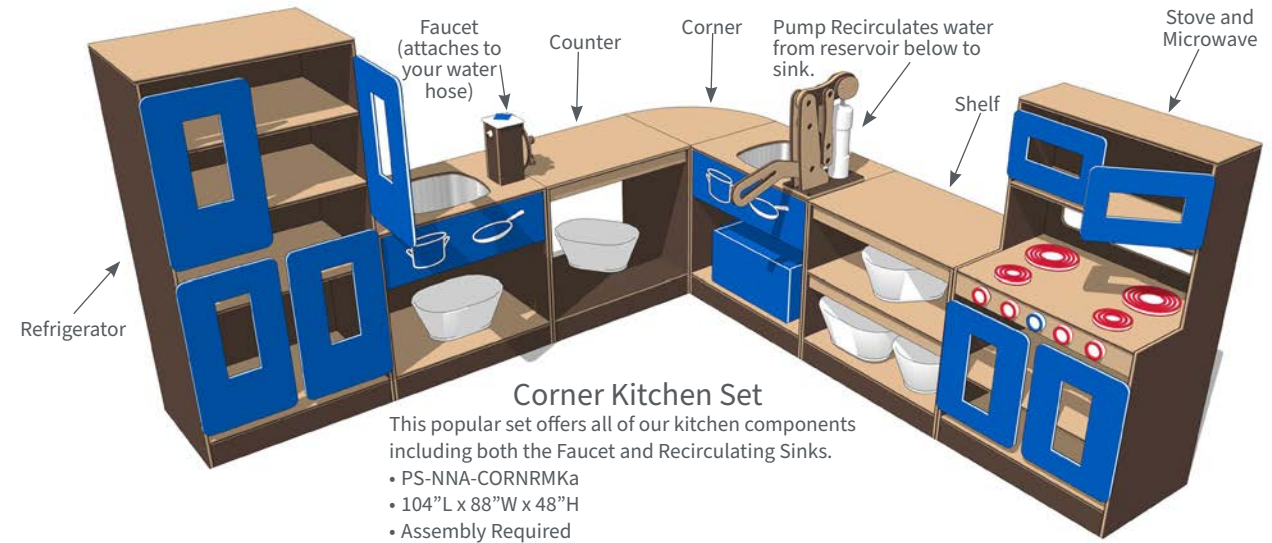

**Corner Kitchen Set**

This popular set offers all of our kitchen components including both the Faucet and Recirculating Sinks.

- PS-NNA-CORNRMKa
- 104" L x 88" W x 48" H
- Assembly Required

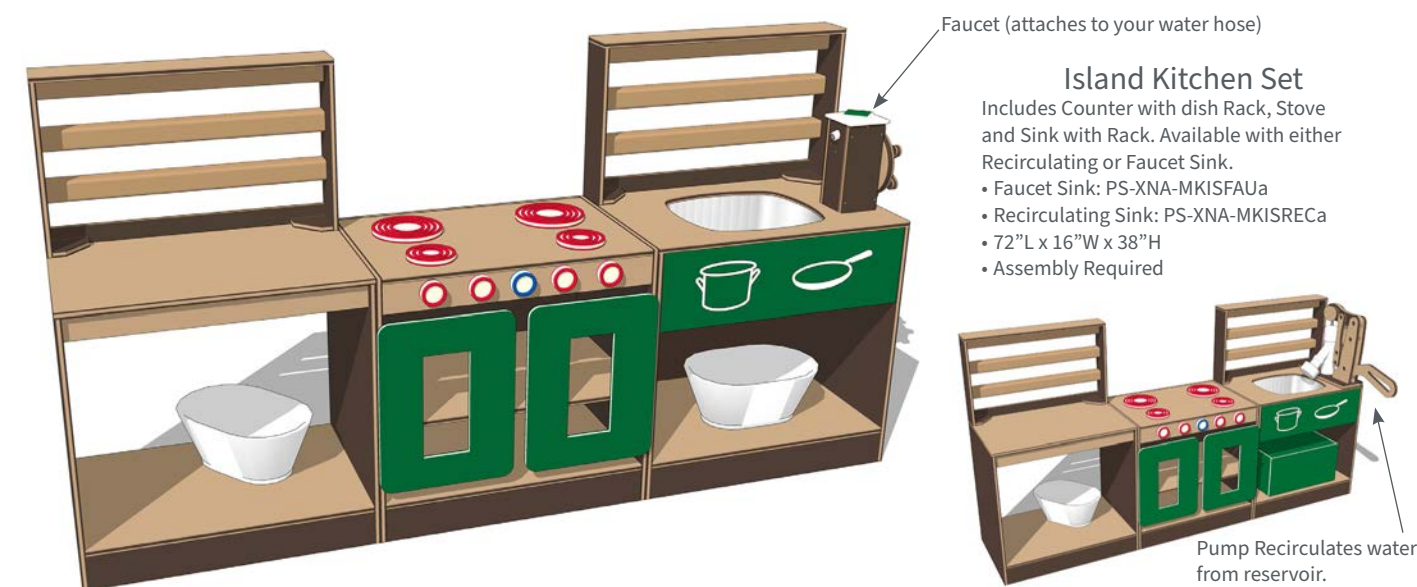

**Island Kitchen Set**

Includes Counter with dish Rack, Stove and Sink with Rack. Available with either Recirculating or Faucet Sink.

- Faucet Sink: PS-XNA-MKISFAUa
- Recirculating Sink: PS-XNA-MKISRECa
- 72" L x 16" W x 38" H
- Assembly Required





## Mud Kitchen Sets

Widely spaced doors reduce the likelihood of pinched fingers, while the heavy-duty plastic material ensures easy clean-up. Create a color-coordinated kitchen design using our Color Palette. All Kitchen Components are available in Chocolate, Mocha, Latte, Blue, Green, Red, Yellow, and White. Any color combination for frame and doors.



### Sink Kitchen Set (Recirculating Pump)

Fill the reservoir with water and easily moved for cleaning with a stand back! Kids pump the water garden hose. Recirculating Sink: into the sink and the water drains • PS-XNA-MKKTRECa back into the Reservoir. Wheels • 48”L x 16”W x 38”H on the Reservoir allow it to be • Assembly Required



### Sink Kitchen Set (Faucet)

Simply connect your garden hose • Faucet Sink: PS-XNA-MDKTFAUa up and turn the handle! Capture • 48”L x 16”W x 38”H drain water in basin (not included) • Assembly Required beneath sink to use again for perfect mud pie recipes.



### Trio Kitchen Set

Combines the three most popular elements of our Mud Kitchen line! This set includes a Stove and Microwave, Refrigerator, and Faucet with Stainless Steel Sink. Attach a garden hose to the faucet for a real working sink! Control water flow with the wheel. Water drains into a tub (not included) beneath the sink via a second hose.

- PS-XNA-MDKTRIOa
- Stove & Microwave: 24”L x 16”W x 42”H
- Refrigerator: 24”L x 16”W x 48”H
- Sink with Faucet: 24”L x 16”W x 32”H
- Fully Assembled

## Mud Kitchen Components

All kitchen components are made with heavy-duty HDPE plastic meant to endure the elements year-round. Stainless steel hardware, hinges, and hooks will guarantee no rust for years. No wood means they won't rot, splinter or warp ever! Meant to be used with sand, water, and mud in the great outdoors. Little chefs will have a blast cooking up luscious mud pies. A dream to clean up with just soap and water as needed. All kitchen components are fully assembled.



Add a Rack to many Kitchen Components. Attached hooks included.

### Recirculating Pump Sink

- Pump water from included reservoir. Includes Stainless Steel Sink.
- Sink: PE-XNAD-KSP-XXa, 24”L x 16”W x 38”H
- Sink with Rack: PE-XNAD-SRR-XXa, 24”L x 16”W x 39”H

### Faucet Sink

- Attach a hose to the faucet that is controlled by a turning handle.
- Sink: PE-XNAD-KFH-XXa, 24”L x 16”W x 32”H
- Sink with Rack: PE-XNAD-UFR-XXa, 24”L x 16”W x 39”H



### Stainless Steel Sink

- Sink: PE-XNAD-SNK-XXa, 24”L x 16”W x 24”H
- Sink with Rack: PE-XNAD-SNR-XXa, 24” x 16” x 38”

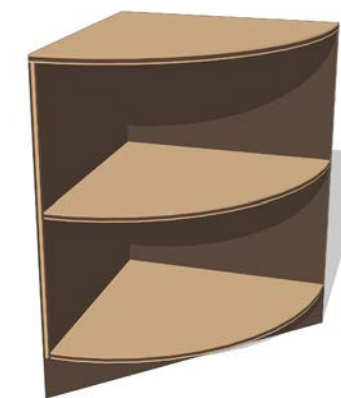

### Corner

- PE-XNAD-UCO-XXa
- 16”L x 16”W x 24”H



### Shelf

- Shelf: PE-XNAD-SHF-XXa, 24”L x 16”W x 24”H
- Shelf with Rack: PE-XNAD-USR-XXa, 24” x 16” x 38”



### Counter

- Counter: PE-XNAD-KCT-XXa, 24”L x 16”W x 24”H
- Counter with Rack: PE-XNAD-UCR-XXa, 24” x 16” x 38”







## Mud Kitchen Components

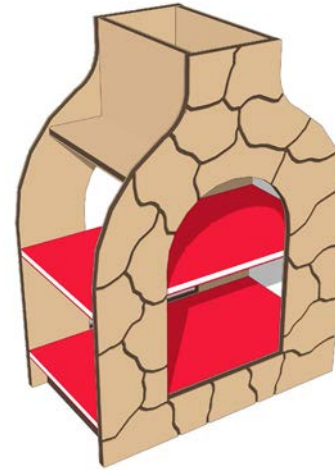

**Pizza Oven**  
 Designed to resemble a real outdoor wood-fired pizza oven.  
 • PE-XNAD-UPO-XXa  
 • 24”L x 14”W x 32”H



**Refrigerator**  
 Open four doors to access “food” inside.  
 • PE-XNAD-URE-XXa  
 • 24”L x 16”W x 48”H

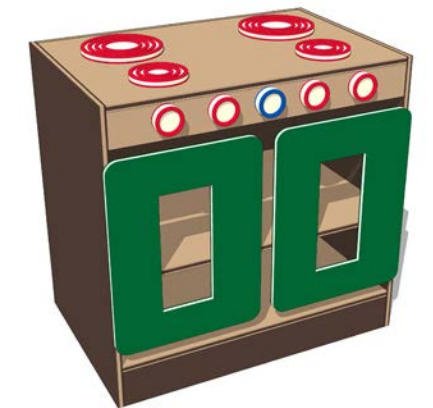

**Stove**  
 Turn the stove knobs and open doors to access the Oven below.  
 • PE-XNAD-UST-XXa  
 • 24”L x 16”W x 24”H



**Stove and Microwave**  
 Turn the stove knobs and open doors above to access the Microwave and Oven below.  
 • PE-XNAD-USM-XXa  
 • 24”L x 16”W x 42”H



Kids supply the imagination. We supply the playhouse.

You can't always take your kids to the woods to build a playhouse with sticks. So, we provide structures that are simply a framework for the child's imagination to build on.



Gone Fishin' Cabin

- PE-NNTP-GFC-XXa
- 48" L x 47" W x 78" H
- Installation Required

Canoe

- PE-XVPR-CNO-XXa
- 7'10" x 2'3" x 11-1/2"
- Fully Assembled

## Playhouses

Looking for imaginative, eco-friendly outdoor play spaces for your children? We have designed a full line of creative playhouses – our best-selling Vine House with an arched arbor for vines to cover children playing beneath, and our exclusive Native American Tipi, sized for little ones, and a Garden Roof House which teaches children about environmental responsibility while providing a quiet shady place to play or rest outdoors!



Vine House

The perfect hideout for young children to read, make-believe, enjoy quiet time beneath vines or watch birds come and go. Arched RSP™ (Recycled Structural Plastic™) Structure is best when combined with our Planters. Plant bright flowers or child-safe vines for more shade coverage. Or, you could plant edible crops, such as peas or climbing beans. Set a ModBox (pg. 70) inside for a reading bench.

Planters and ModBoxes sold separately. Plants not included. Shown in Coffee Shoppe color scheme.

- Vine House: PE-XNPP-VIN-04a, 4'L x 4'W x 4' H
- Vine House with Planters: PE-XNPP-VNB-04a, 4'L x 6'W x 4'H
- Assembly Required



Vinehouse with optional pad



Garden Roof House

Fill the roof of this playhouse with plants of all sorts! They detoxify and oxygenate the air, attract beneficial insects and butterflies, and reduce rain runoff. Children will enjoy playing in the shade below the Garden Roof House. Add optional ModBoxes for seats, play stage, or planters.

Stack ModBoxes two-high for counters and shelving.

- House: PE-NNPP-GAR-XXa
- House with Planters: PE-NNPP-GTM-XXa
- 50" L x 50" W x 61" H
- Installation Required



Tipi

Our Tipi resembles authentic Native American dwellings of the Great Plains. The originals were covered with animal hides. Our child-sized version sports durable, marine-grade fabric instead. The EcoColor plastic bottom and RSP (Recycled Structural Plastic) supports will

never rot or tempt termites. Scallop openings decorate the bottom of the cover. High sides also allow caregivers to maintain visual contact with the children.

- PE-XNPP-TPS-XXa
- 48" W x 48" L x 84" H
- Assembly Required



# Playhouses



**Gazebo with Hex Roof**

The Hex Roof is 9 feet across, point to point, providing approximately 50 square feet of shade over 3 attached bench seats.

- SA-GNAP-Z3B-XXa
- 108”L x 94”W x 109”H
- Installation Required



**Little People’s Playhouse**

Flower boxes, chimney and an artistic shaped “window pane” above the door provides an authentic look. Lots of interior room and two benches for imaginative play. The large side windows ensure visibility

- and security for adults to see inside and keep watch from nearby.
- PE-XNPP-LPP-05a
- 66”L x 53”W x 80”H
- Installation Required



**Wee Tot’s Clubhouse**

Includes two benches along inside walls, doorway, Kids Only sign, three windows with planter boxes.

- PE-NNTP-WTC-XXa
- 62”L x 58”W x 76”H
- Installation Required



**Beach Hut**

Includes Thatch Village Roof (Mega), 6x6 posts with Beach Hut graphics, Wave hut walls, (2) benches along inside walls, and Picnic Table.

- PE-GNPD-BHM-XXa
- 48”L x 48”W x 90”H
- Installation Required



# Trike Play

Fill your trike play area with our imaginative trike path amenities – Electric Vehicle Charging Stations, Village Houses, Tunnels, and Traffic Signs. Store trikes in our Trike Garages at the end of the day. All made from heavy-duty recycled materials!

**EV SuperCharger**

Charge up those trikes for a super “clean” ride! Plug attached to moveable “cable” so children can pretend to plug in before speeding off again.

- PE-NNPK-SPR-XXa
- 27”L x 7”W x 50”H
- Installation Required

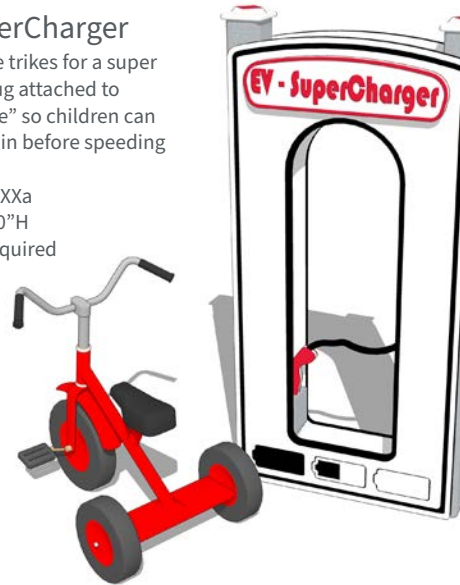

**Fire and Police Station Combo**

This unit combines the best features of our first responders bases. The Fire Station side includes a color panel with engraved Dalmatian pup; interactive gauges panel; and engraved roof. The Police Station

side includes storefront panel with engraved police officer; a built-in bench; and engraved roof.

- PE-NNAD-FPC-XXa
- 89”L x 35”W x 80”H
- Installation Required



**Police Station**

A friendly officer greets children with a wave and whistle. Clear Polycarbonate window. Built-in bench. Customize by adding your local department’s name.

- 2-Post: PE-NNAD-PS2-XXa, 21”L X 32”W X 80”H. Inground or attached to wall.
- 4-Post: PE-NNAD-PS4-XXa, 34”L X 37”W X 80”H
- 6-Post: PE-NNPD-PS6-XXa, 66”L x 38”W x 80”H
- Installation Required



4-Post



**Fire Station**

A vigilant Dalmatian pup stands ready to ride with young firefighters to the rescue. Fill-up hose panel. Customize by adding your local department’s name.

- 2-Post: PE-NNAD-FS2-XXa, 21”L X 32”W X 80”H. Inground or attached to wall.
- 4-Post: PE-NNAD-FS4-XXa, 34”L X 37”W X 80”H
- 6-Post: PE-NNPD-FS6-XXa, 66”L x 38”W x 80”H
- Installation Required

6-Post

Back View



4-Post



## Trike Play



### Village Houses

Includes two houses with windows and planter boxes connected by a Palm Panel with ball toss opening, and two Kids Benches.

- PE-NNPD-VHS-XXa
- 91”L x 38”W x 73”H
- Installation Required



### Café

Playground Café adds a retail experience to your child’s play. Tots can pretend to “sell” treats at this whimsical cafe. Includes Half-Village Roof with graphics and Storefront Panel with graphics. May be installed inground or attached to other components or a wall. Not available as Surface Mount.

- PE-NNPD-CF2-XXa
- 34”L x 21”W x 80”H
- Installation Required



### EV Charging Garage

Inspire the next generation to use clean energy, charging up rather than filling up. Includes Electric Vehicle SuperCharger graphics and a permanently attached photo of an expansive real-life charging station.

Park trikes inside the garage to protect them from inclement weather, secured with sliding bolt lock.

- PE-NNPK-EVG-XXa
- 42”W x 96”L x 60”H
- Installation Required

## Trike Play

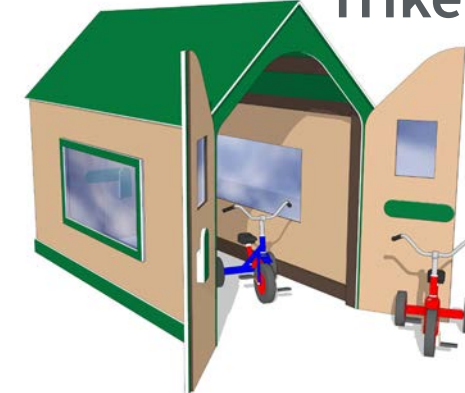

### Trike Storage Shed

Protects trikes and other valuable play items from the elements. Latching doors on both ends – slide latch for simple, safe door closure. Large windows made from heavy-

duty clear Polycarbonate on sides maximize visibility and light inside and out.

- PE-NNAK-TSS-48a
- 96”L x 50.5”W x 76”H
- Installation Required



### Farmer's Market

Popular Item! Little farmers can display their produce at the Farmer's Market. Includes 2 Fruit & Veggie Storefront Panels, Farmer's Market Roof and Kid's Bench. Works great with the Raised Garden Bed!

- PE-NNAD-MKT-XXa
- 35”L x 35”W x 80”H
- Installation Required



### Fruit Stand

Children learn to cooperate with this imaginative market stand. Combine with real or pretend produce to introduce basic money skills. 2 Post, Includes Half-Village Roof with graphics and Storefront Panel with graphics. May be installed inground or attached to other components or a wall. Not available as Surface Mount.

- PE-NNPD-FRT-XXa
- 34”L x 21”W x 80”H
- Installation Required



### Trike Garage

Store trikes in a covered “garage” to protect from the elements and allow children to practice the adult skill of parking their vehicle.

- 3-Bay: PE-NNAK-GAR-03a, 96”L x 42”W x 60H
- 4-Bay: PE-NNAK-GAR-04a, 128L”x 42”W x 60”H
- 6-Bay: PE-NNAK-GAR-06a, 192”L x 42”W x 60H
- Installation Required

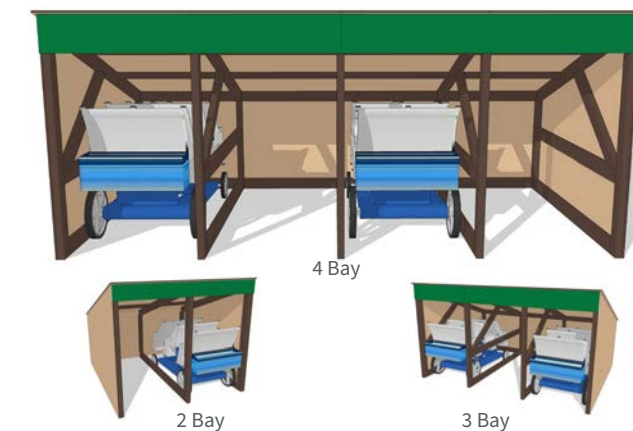

### Pram Storage

Parking for “Prams” (Bye Bye Buggies, multi-child strollers).

- 2 Bay: PE-NNAK-PRM-02a, 72”L x 78”W x 60”H
- 3 Bay: PE-NNAK-PRM-03a, 108”L x 78”W x 60”H
- 4 Bay: PE-NNAK-PRM-04a, 144”L x 78”W x 60”H
- Installation Required

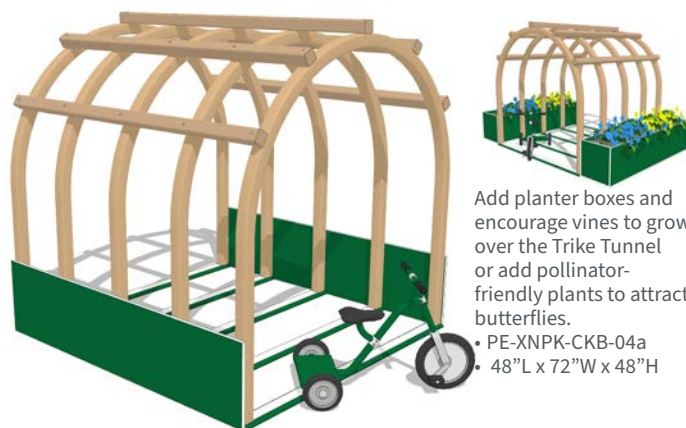

### Click Clack Trike Tunnel

Place this tunnel over a trike path to create an extra audio experience. Little trike tires provide a satisfying “click-clack” sound while riding over the “tracks”. Struts are beveled so they do not create a barrier. The 4’

x 4’ x 4’ size has been time-tested to withstand extensive use in harsh outdoor environments.

- PE-XNPK-CLK-04
- 48”L x 48”W x 48”H
- Assembly Required



### Trike Track Drive Thru

Skylights and large windows provide a clear line of sight for caregivers while creating structural excitement for children riding along a trike path.

- PE-NNPK-DTH-XXa
- 64”L x 52”W x 77.5”H
- Installation Required



### Trike Traffic Signs

Traffic signs keep trikers on the right path, teaches pre-driving sign recognition and associated reading skills. Mix and match from these choices: Speed Limit 5, Handicap Parking, Stop, Yield, Trike Crossing or Recycled Here signs. Each sign includes an RSP post and can be installed either in-ground or portable (base included in portable price).

- 10-15”L x 10”W x 48”H
- Inground - Installation Required
- Portable - Assembly Required







## Shade Structures

The National Program for Playground Safety recommends: "Include shade covering in the design of playground equipment and recreational areas." Some states require a percentage of the playground be shaded. Check for your State's requirements. Nature of Early Play offers a wide selection of Shade coverings. Visit [www.natureofearlyplay.com](http://www.natureofearlyplay.com) or ask your Nature of Early Play Distributor for options.

## Use Zones & Safety Surfacing Requirements:

Abrasive surfaces, such as concrete or asphalt, are not considered suitable surfaces underneath play items. Swing use zones are specifically listed by height and type of swing (see our Swing product page). Slides have use zones specific to the slide and may not overlap other use zones.

**Ages 0 - 23 mos:** Ground-level items that have no designated play surface require a non-encroachment zone of 36" around the item. This may overlap the zone of other items with no moving parts to 36". Play Items may be placed directly against a wall.

- Elevated Play products in a supervised setting: All play items require at least a 36" use zone, which may overlap to 36" for items with no moving parts. For items with a play surface above 18", safety surfacing is required in the use zone around all access components and slides.
- Elevated Play products in a setting with unlimited access: Portable play equipment should not be used. All play items require a 72" use zone around them. For items with no moving parts, this use zone may overlap down to 72". All elevated play items require safety surfacing in this use zone adequate for their fall height.

**Ages 2 to 12 years:** Ground-level items that have no designated play surface do not require a use zone, but should have "sufficient space for play and circulation". All elevated items require a use zone of at least 72" with impact attenuating surfacing adequate for the fall height of the equipment. For items with a play surface below 30", these use zones may overlap to 72" if there are no moving parts or slides. For items with a play surface above 30", the use zones may overlap to 108".

## Shipping

Some play elements can ship UPS or Fed Ex, depending on size. Playsets and all large orders will ship by full or partial truck load. Your local sales representative will include shipping with your product quote.

## CPSC Public Playground Safety Handbook 2.4 Surfacing Recommendations:

The surfacing under and around playground equipment is one of the most important factors in reducing the likelihood of life-threatening head injuries. A fall onto a shock absorbing surface is less likely to cause a serious head injury than a fall onto a hard surface. However, some injuries from falls, including broken limbs, may occur no matter what playground surfacing material is used.

Minimum Compressed Loose-Fill Surfacing Depths		
Loose-Fill Surfacing Material Depth (inches)	Surfacing Type	Fall Height (feet)
6"	Shredded/recycled rubber	10
9	Sand	4
9	Pea Gravel	5
9	Wood mulch (non-CCA)	7
9	Wood chips	10

\* Shredded/recycled rubber loose-fill surfacing does not compress in the same manner as other loose-fill materials. However, care should be taken to maintain a constant depth as displacement may still occur.

Actual surfacing depths and fall heights must be confirmed with supplier.

## Surfacing - Loose Fill



Loose-fill surfacing materials require special maintenance and refilling to maintain appropriate, even fall-height depth requirements.

**Engineered Wood Fiber:** Organic (compostable) material. Most economical choice. Requires containment border and weed-control fabric.



**Loose Fill Rubber:** Recycled rubber. Will not rot, fade, or float away. Needs containment border. Many color options available. Versatile product that can be used for play use zones and mulch for planter boxes or garden beds.

## Surfacing - Unitary



**Unitary Rubber (Poured-In-Place):** Recycled EDPM rubber mixed and poured on site into optional custom designs and colors. Durable, porous, many color choices. Sub-surface must be concrete, asphalt or compacted stone. Good choice for accessible pathways.



**Play tiles:** Factory molded interlocking tiles. Durable with several color choices. Sub-surface must be concrete, asphalt or compacted stone. No borders required. Low maintenance.



**Turf:** Polyethylene turf fibers and optional rubber in-fill. Sub-surface must be concrete, asphalt, compacted stone or excavated earth. Invitingly green, soft texture resembling real grass.

## Borders



**RSP™:** Recycled Structural Plastic™ borders are made from the same heavy-duty lumber with which we manufacture our playground equipment - 100% recycled post-consumer HDPE plastic. Smooth, rounded corners. Never rots or decays, cleans easily, low-maintenance. Secures easily with metal spike. Available in Tan or Brown.



**Molded Plastic Timber:** Made from polyethylene and are durable, yet lightweight. Will not rot, decay, or splinter. Rounded corners and no sharp edges. Secures with metal spike. Available in Black only.



**Rubber Curb:** Made from recycled rubber tires. Flexible with rounded edges: smooth and seamless, no splintering, warping or discoloration, low maintenance. Simple installation - secures with metal spike. Available in Brown only.



It is up to you and your community to maintain a safe, friendly playground environment in order to reduce playground injuries.



Check for vandalism or debris especially after heavy-use events or inclement weather.

Detailed inspections should give special attention to moving parts and loose fill surfacing which can be displaced during play.

**Inadequate maintenance of equipment is a common cause of injuries on playgrounds.**

The safety of playground equipment depends on good inspections and systematic, routine maintenance. It is advisable for personnel who will implement the inspections to be trained through a program like the National Recreation and Park Association's "Certification Course for Playground Safety Inspectors".

The quality of playground supervision depends on the supervisor's knowledge of safe play behavior. Nature of Early Play's staff of Certified Playground Inspectors have developed check lists and recommended inspection schedules to help our customers develop thorough and effective maintenance programs. These guidelines include a High Frequency Checklist for potential problems to be performed daily or weekly and a Low Frequency Maintenance Schedule for monthly or quarterly inspections. Records of all maintenance inspections and repairs should be retained, signed, dated and filed. Maintenance documentation will be required for warranty claims, and Nature of Early Play may refuse a claim if it is clear that the playset has not been maintained according to our recommended maintenance instructions and/or schedule.

**Nature of Early Play Warranty**

**Standing Behind our Equipment Since 1981!**

LIMITED 10 YEAR WARRANTY on RSP COMPONENTS and EcoColor™ PLASTIC PRODUCTS under normal use and proper maintenance against structural failure due to deterioration or weathering.

LIMITED 10 YEAR WARRANTY on STEEL COMPONENTS and STAINLESS STEEL HARDWARE against structural failure due to corrosion, deterioration or weathering.

LIMITED 3 YEAR WARRANTY on all POLYETHYLENE ROTO MOLDED PRODUCTS against structural failure due to deterioration or weathering .

LIMITED FIRST YEAR WARRANTY on all FABRIC ROOFS, FABRIC SAND BOX COVERS, FABRIC TIPI COVERS and all other fabric products against structural failure or manufacturing defects.

LIMITED FIRST YEAR WARRANTY on MOVING PARTS and all other MATERIALS not mentioned above against structural failure or manufacturing defects.

- The above warranties are valid only if the structures are erected in conformity with the layout plan and/or installation instructions provided by Nature of Early Play have been maintained and inspected in accordance with Nature of Early Play, Inc.'s maintenance instructions; have not been subjected to addition or substitution of parts; and have not been modified or altered by persons other than a Nature of Early Play certified installer.
- The above mentioned warranties do not include any cosmetic issues such as scratches, dents, marring, fading or discoloration.
- Damage resulting from vandalism, misuse, negligence, accidents or acts of God are not covered by this warranty.
- Warranties apply from the Date of Purchase.
- Installation labor is not included in replacement of warranty parts. Shipping is not included after the first year on warranty parts.
- Restocking: Nature of Early Play will restock play equipment in re-usable condition for a 20% restocking fee + return shipping.

Maintenance: Nature of Early Play's staff of Certified Playground Inspectors have developed check lists and recommended inspection schedules to help our customers develop thorough and effective maintenance programs. These guidelines include a High Frequency Checklist for potential problems to be performed daily or weekly and a Low Frequency Maintenance Schedule for monthly or quarterly inspections. Records of all maintenance inspections and repairs should be retained, signed, dated and filed. Maintenance documentation will be required for warranty claims, and Nature of Early Play may refuse a claim if it is clear that the playset has not been maintained according to our recommended maintenance instructions and/or schedule.

Effective May 1, 2016

**Wood Products:** All of Nature of Early Play's wood products are 100% natural wood and no warranties apply to wood products. Wood is subject to natural deterioration over time. Natural aging, cracking, splintering and weathering is common to all wood products within one year.

Play Mart, Inc. reserves the right to improve and upgrade our equipment, designs, specifications & materials without notice.

For warranty related concerns, contact Customer Service at (800) 437-5297 or [customerservice@playmart.com](mailto:customerservice@playmart.com).





Printed in the USA, using recycled paper and paper sourced from well-managed forests. Please recycle or pass along this catalog. © Copyright 2022, Play Mart, Inc.



# Nature of Early Play™

By  Play Mart Playgrounds



Recycled and natural products that connect young children with the natural world.

Play Mart, Inc.  
170 Allens Way  
Somerset, KY 42501  
(800) 437-5297  
info@playmart.com

Visit [www.natureofearlyplay.com](http://www.natureofearlyplay.com) to find your local distributor.

Visit [www.playmart.com](http://www.playmart.com) to view elementary age products.

In order to offer the most up-to-date products regarding safety code and design innovation, we reserve the right to change product designs. Our newest models can be found on our website at [www.natureofearlyplay.com](http://www.natureofearlyplay.com).

 Contract GS-07F-0206L  
www.gsaAdvantage.gov