



The Chief Pleas of Sark
Committee Offices
Chasse Murette
Sark
GY10 1SF

Document No: 10739 HV Assessment Report Issue No: 3.0 - October 2021

EIS Ltd. 30 Royal Scot Road, Derby DE24 8AJ Telephone:01332 947050

Website: www.ei-services.co.uk

Contents

Introduction.....	4
Company and author background.....	5
Executive Summary.....	7
General comments.....	9
Common issues.....	9
Asset list and locations, the numbers refer to numbered locations on the attached map.	13
Island map.....	14
.....	14
Individual site comments.....	15
1A Power Station.....	15
1 Opposite Yellow Brick Road, on rear access road to power station.....	16
2 Behind Avenue Bakery.....	17
3 The Avenue, opposite the Post Office.....	18
4 Field, opposite Mermaid Pub.....	19
5 La Vallette.....	20
6 Carrefour crossroads.....	21
7 Baytree transformer switch, corner of Rue Lucas & Rue du Fort.....	22
8 Baytree transformer.....	23
9 Island hall.....	24
10 Opposite La Seigneurie.....	25
11 Infield, North Rd to S bend, opposite airplane field.....	27
12 Methodist Chapel corner.....	28
13 Vauroque crossroads.....	29
14 Plaisance (folk festival field).....	30
15 Le Pre du Moulin.....	31
16 Stocks hotel corner.....	32
La Coupee Little Sark feed cable.....	33
17 Little Sark Old barracks.....	34
18 Little Sark T junction, Bar garden.....	35
19 Little Sark main road, South of la Coupee.....	36
20 Field, Opposite Peignury Farm.....	37
21 Les Laches, (up from new slaughterhouse).....	39
22 Harbour.....	40
23 Telecoms building.....	41

24 HV cable box near new dairy	42
25	43
26	44
27 Dixcart Hotel.....	45
28 La Moinerie	46
Acknowledgements.....	47
APPENDICES.....	48
APPENDIX A.....	
Health and Safety at Work etc Act 1974.....	
APPENDIX B.....	
The Electricity at Work Regulations 1989	
APPENDIX C	
HSE Guidance HSG230 Keeping Switchgear Safe	
APPENDIX D.....	
HSE Guidance HSG85 Electricity at Work.....	
APPENDIX E	
HSE Publication Do you know how to Work Safely with PCBs?.....	
APPENDIX F	
ENA NEDeRS Ref. SOP 2013/0383/06	
APPENDIX G.....	
Electricity Northwest Operational Instruction 206 Issue 6.....	

Introduction

Electrical Infrastructure Services Ltd. were contracted by the Chief Pleas of Sark to carry out a non-invasive assessment of the electrical network on Sark, to ascertain its suitability, fitness for purpose and safety aspects.

The following report primarily addresses those elements applicable to the High Voltage assets only, due to time constraints.

The report is also written with a viewpoint pertaining to UK law, Health & Safety requirements and guidelines and industry adopted best practices.

The techniques employed were non-invasive visual inspection, asset photography and detail recording, thermal imaging, ultrasonic and TEV detection.

Abbreviations used

A	Amps
AC	Alternating current
COSHH	Control of Substances Hazardous to Health 2002 Regulations
DC	Direct Current
DGA	Dissolved Gas Analysis
Duty Holder	Person on whom the EAWR places duty and responsibility
	Directors and Managers
	Designers of systems and components
	Designers of Systems of Work, Tools, Safety Procedures
	Designers of Organisation of Work
	Planners.
	Constructors
	Operators, Maintainers and Supervisors
EA	The Environment Agency
EAWR	The Electricity at Work Regulations 1989
ENA	The Electrical Networks Association
HASW	The Health and Safety at Work etc. Act 1974
HSE	The Health and Safety Executive
G	Giga
K	kilo
LV	Low voltage (below 1,000V AC or 1,500V DC)
HV	High voltage (above 1,000V AC or 1,500V DC)
PCB	Polychlorinated Biphenyls
TEV	Transient Earth Voltage
V	Volts
VLF	Very Low Frequency
W	Watt

Company and author background

Electrical Infrastructure Services Ltd, was established in April 2009 and undertakes work for some of the largest and best-known names in the UK.

Customers include

Engie

Bombardier Transportation

Network rail

BAE Systems

Government of Jersey

Western Power, SSE, SPEN and UKPN approved contractor

Actemium

Abelio East Midlands Trains

Virgin Trains

Hitachi

Amco Giffen

Arora Hotels

Briggs & Forrester

Brose

Crowcon

FCC Environmental

Lightsource BP

Grupotec

Lucozade Ribena Suntory

NMCN

Octopus Investments

PSH Operations

Zenobe

Rolls Royce

We provide a range of specialist services, including:

Supply and installation of Transformers and switchgear to 33kV

Supply and installation of package substations to 33kV

Insulation tests up to 5kV

AC/DC pressure tests up to 33kV

VLF cable testing

HV and LV winding insulation tests

Oil sampling and testing (electrical breakdown, acidity, water & PCB content, DGA analysis)

Ductor testing

Primary and secondary current injection

Soil resistivity measurements

Earth electrode & system resistance including no disconnect testing

Earth matrix installations (exothermically welded)

G99 injection testing

Gas detector installation

Maintenance packages

Fault finding and call out

Cable location & cable spiking

Grading and protection studies

HV Network design
HV Senior Authorised Person services
HV / LV cable jointing
Cable installation

Our experienced team works to provide a design solution to meet the project brief with absolute satisfaction. Each step of the project is handled by experienced managers, who will ensure it is delivered to specification, on budget and on time.

We endeavour to ensure that disruption to daily business processes and operations are minimised, by either working outside of regular business hours or by a mutually agreed plan to work around routine operations.

After project completion, we continue to offer full support and provide a variety of maintenance packages, call-out and 'fault finding' services and training courses to suit specific needs.

EIS have extensive experience in designing and installing electrical systems for a variety of private networks and renewable energy sources including solar, wind, gasification and biomass generation plants.

With the in-house skills and resources to provide electrical systems to suit installations up to 33kV, from small rooftop solar systems to generation systems in excess of 50MW, working in close liaison with the DNO. We have supplied and installed electrical infrastructure systems for almost 1GW of renewable energy throughout the UK, operating from the Northern tip of Scotland to the Southern reaches of Kent, Cornwall and the Isles of Wight and Jersey. EIS is widely regarded as being one of the country's leading teams in the field of renewable energy installations, working with many of the largest EPC companies to date.

We install and maintain a number of large private HV networks on behalf of some of our prestigious clients, including 24/7 call out response.

We are Compex accredited and have engineers experienced at surveying sites and install gas detection equipment.

We are a NICEIC registered company and also registered under the Safe Contractor scheme.

We are approved contractors for G99 Testing with WPD, SSE, SPEN and UKPN.

The author has some 40 years of experience in the high voltage sector, working on behalf of many large and varied clients, providing design, consultancy and expertise in this field. He also has a strong background in predictive asset maintenance, having been the Operations Director for a leading company in this area, providing thermography, vibration and oil analysis services to major companies such as Mars, McVities, Jarvis Rail, Glaxo Smith Kline and Nestlé. He has a B.Sc. In Electrical and Electronic Engineering, is a European Engineer (EUR ING), a Chartered Electrical Engineer, a Chartered Scientist and a Member of the Institute of Engineering and Technology.

Executive Summary

The majority of the HV network as surveyed consists of equipment that is old, not of a modern design and past the design life, with little evidence of a progressive replacement or upgrade program. The majority of the HV equipment should be treated as being at the end of its life and be considered for immediate replacement. All the switchgear is of a type that is prohibited from live operation of the fuse units and should have a 7m exclusion zone around them.

A cost to replace the switchgear and transformers, if situated on the UK mainland would be approximately £1.1- £1.2M, this figure does not cover the cost of the possibly contaminated asset disposal costs or any uplifted costs for Sark. The estimated cost of a GRP housing and concrete base has been included at each site.

It is assumed the current cables can be reused and re-terminated and their replacement has not been included, however a budget cost would be in the order of £150 p.m. including excavation (although some valleys may prove more expensive) with around £1,500 termination costs per cable. A very rough scale measurement from the map and indicated cable routes, calculates there to be a possible 10,500m of HV cable; with terminations and joints, the replacement cost would be approximately £1.7M

None of the cables were surveyed in detail and their condition, depth or suitability cannot be commented upon, other than a few notable exceptions that appear in this report.

Most of the transformers are from an era where PCBs (polychlorinated biphenyls) were used in the oil, although this can only be verified by oil sample analysis, it would be safe to assume at least some will contain PCBs. This represents a serious health hazard and has been banned in the UK since 1987, the cost of disposal and incineration is considerable, aside from the logistics of removal from Sark. Estimated costs for disposal on the UK mainland would be around £15,000, excluding the transport from Sark to the UK. This is classified as hazardous waste and a Waste Carriers Licence and Waste Transfer Notice are required. The equipment would be sent to a registered waste company, the contaminated oil removed, incinerated and the equipment scrapped in accordance with UK Legislation.

PCBs were used as dielectric filler liquids in some types of electrical equipment such as transformers, switchgear, capacitors and in the starter units of fluorescent lights and fractional horsepower motors. Some equipment is labelled as containing PCBs but if you come across old equipment with no identifying label you should check with:

- the owner; or the manufacturer or owner of the equipment.

It should be assumed that any capacitor or transformer manufactured before 1976 may contain PCBs unless there is information to the contrary. It is also possible that there may be PCBs present in capacitors and transformers manufactured between 1976-1986. Even if the PCBs have been replaced by another liquid, significant amounts of PCBs may still be present. PCBs may occur as contaminants in the oil used in oil-filled electrical equipment.

PCBs can enter your body in three ways:

- by direct contact with the skin. PCBs pass easily through intact skin, so this is likely to be the main way they get into the body;
- by breathing in fumes, spray or droplets if PCB-containing equipment is being cut or heated;
- by swallowing PCBs eating, drinking or smoking in the workplace.

Repeated exposure to PCBs causes a gradual build up in the body. PCBs can cause a skin condition called chloracne, which produces pustules, blackheads and cysts.

In animals PCBs can cause damage to the liver, reduce the ability to fight infection, as well as other effects. Apart from chloracne, none of the range of effects seen in animals has yet been seen in people working with PCBs, although it is possible that they could occur if high exposures were to occur.

All PCB-containing equipment needs to be checked regularly for signs of PCB leakage. If substantial leakage occurs, the assistance of a specialist contractor should be sought immediately.

Do not do any work where there is a possibility of contact with PCBs, including dealing with spilt PCBs, unless properly trained.

The transformers are all pre low loss types and their cost of operation even when not supplying any load (no load loss) is much more than modern units. Taking an average of transformer sizes as 50kVA, a modern Tier 2/3 transformer will use roughly 70W less of no-load power equating to approximately 611kWh per year. Load losses will be similarly reduced by around 238W giving an annual saving of around 1,022 kWh. This is a total of over 1,800kWh saved annually, so allowing for Sark's lightly loaded network, this should probably be reduced to say, 1,000kWh annually, for easy calculation. This therefore could realise a saving, @£0.60 per kWh, of £600 per transformer in operating costs, if this is multiplied by the 25 or so transformers on the island, then a total estimated saving of around £15,000 could be expected in reduced losses alone.

Very few of the network equipment is fenced or within a building preventing access to unauthorised, non-trained persons, with virtually none of the switchgear having locks on the operating mechanisms to prevent unauthorised operation.

There appears to be little evidence of proper, scheduled maintenance being done other than exterior painting, although the author cannot be certain of this without access to documentation or records, the overgrown vegetation and over painted cover bolts and oil drain taps, give some weight to this claim.

There are no danger or warning labels on the equipment and very few circuit designation labels.

When considering adopting the HV network, serious consideration must be given to suitably trained and authorised personnel to operate and maintain the network, along with a robust scheduled maintenance program and appropriate safety rules.

Offloading the network to a 3rd party, might prove to be the best, safest and most cost-effective option for Sark

It is the *opinion* of the author, that the present network is currently not fit for purpose, in need of many immediate upgrades and replacements and inherently contains serious safety concerns and liabilities as detailed in this report. The report does not cover the main generators, which were not inspected, but are believed to also be at, or past their design life.

General comments

The majority of the high voltage assets are of the same or similar types/models and many of the points raised are common to all locations, so rather than repeat the same issues each time, for the purposes of clarity of reading, the following lists relates to *most of* the asset locations. Where there are separate, specific issues, these are detailed against the particular assets. Similarly, each location identified on the map, was surveyed with a Flir thermal imaging camera to detect hot spots and an UltraTev2 Ultrasonic and TEV detector to identify electrical discharge from the assets. Where no issues were found using the detection devices, no recordings or images were taken, exception reporting being employed.

Due to the size of the network, the HV cables were not surveyed for suitability, size, condition or load, with the exception of the HV feed cable to Little Sark at La Coupee, detailed later.

It was also not possible to ascertain how the network earthing system was organised and connected, so consequently earth matrix resistance readings were not carried out as they would not have provided any meaningful results.

As previously highlighted, the following comments are made as though the network was UK operated and the laws and requirements accordingly. The primary sources of reference are:- The Health and Safety at Work etc. Act 1974, The Electricity at Work Regulations 1989, The Electrical Networks Association NEDeRS database (National Equipment Defect Reporting Scheme), COSHH 2002 Regulations, HSE guidance booklets HSG85 and HSG230, BS 7671 Requirements for Electrical Installations, also known as the IET Wiring Regulations

Common issues

1. The HV assets are neither fenced nor enclosed to prevent access to untrained and unauthorised persons.

Under the HASW Act there is an overriding duty on Employers to ensure so far as reasonably practicable, the health, safety and welfare of all their Employees, additionally the provision and maintenance of Plant and Systems of Work that are safe and without risk to health, including members of the public.

Regulation 16 of the EAWR also states No person shall be engaged in any work activity where technical knowledge or experience is necessary to prevent danger or, where appropriate, injury, unless he possesses such knowledge or experience, or is under such degree of supervision as may be appropriate having regard to the nature of the work.

The scope of 'technical knowledge or experience' should include:

- (a) adequate knowledge of electricity;
- (b) adequate experience of the electrical work being carried out;
- (c) adequate understanding of the system to be worked on and practical experience of that class of system;
- (d) understanding of the hazards which may arise during the work and the precautions which need to be taken;
- (e) the ability to recognise at all times whether it is safe for work to continue.

A simple locked, GRP housing would fulfil the requirements.

2. The HV equipment does not have locks on the switchgear operating handles or the transformer tap changers, preventing unauthorised operation by untrained personnel.
3. The HV equipment does not have warning labels fitted, alerting persons to the dangers with possible live conductors, such as Danger High Voltage, Authorised Persons Only, Live Conductors Isolate Elsewhere and in the most cases, duty/designation labels
4. All the switchgear surveyed was of the Long & Crawford (or their subsequent owner) GF3 variants, which include TEGF3 and T4GF3 units. These have been subject to several defect reports over the years and currently have a Suspension of Operation (SoP) imposed on them by the ENA NEDeRS scheme, preventing any live operation and imposing a 7m exclusion zone around any live equipment. This restriction **may** be able to be lifted, following successful internal examination of the fuse chamber and modifications to the same. The individual units cannot be operated and will need to be isolated 'upstream' on the network, however since all the switchgear is the same or similar type, including the power station, a total shutdown would be required.
5. The orientation and placement of the HV switchgear with regard to walls or enclosures, does not in most cases, allow for the safe operation of the handles, most being too close to walls or enclosures. It is usual to have the switchgear operating handles facing outwards towards doors or openings, so should any explosion or discharge occur when being operated, the engineer is thrown backwards into free space, rather than trapped against fixed structures.
6. Most of the transformers, where a manufactured date can be ascertained, are of an age where PCBs were commonly used to fill the tanks. These substances have been banned since 1987 in the UK because of health reasons and the law requires that steps are taken to identify if units contain PCBs and the level of contamination, register the assets and then comply with the disposal of the PCBs. The actual level of contamination can only be determined by analysis of an oil sample, however, most of the transformers have the drain taps in inaccessible positions, making sampling impossible, or in such a badly maintained condition, operation of the tap could result in it becoming stuck or shearing off and causing a large oil spill and once the transformer is empty of oil, a possible electrical explosion and subsequent failure of the unit.
7. Oil sampling of the transformers, is a very good method of determining the condition of the transformer internal core, any oil borne contamination, such as water, the electrical strength of the oil and advanced warning of electrical arcing (sparking) inside the transformer before failure occurs.
8. The environmental legislation requires that any oil storage over 205 litres is stored so as to prevent spillage or leakage, but also requires that volumes under that amount are risk assessed to determine if a bund is required. None of the transformers or switches surveyed are banded, with all being under 205 litres, however considering that all buildings draw drinking water from boreholes and many could contain PCBs, it is vital that adequate leakage and spillage measures are utilised.
9. None of the assets surveyed showed evidence of regular maintenance, other than external painting.
The EAWR regulation 4 states All electrical systems must be constructed and maintained at all times to prevent danger, so far as is reasonably practicable. This would typically include annual visual inspection, oil sampling and analysis of transformers and switchgear, earth matrix resistance readings and internal

inspection of assets, including cable boxes, with a documented scheme being in place and evidence that scheduled, periodic maintenance is being carried, normally in the form of inspection/test documents.

10. Should a fault occur in a cable or piece of equipment, where the current flows to earth (the general mass of the ground) it does so by means of dedicated earth cabling, the steel armouring surrounding cables, or via a dedicated star point earth matrix for the LV side of transformers.

All these provisions should be capable of carrying the full earth current in the event of a fault. The HV assets are bonded together using c. 16mm² green/yellow (6491X) cables, mostly connected to a single connection point. It is unlikely that this cable would be capable of carrying an HV earth fault current, usual practice is to utilise 95mm² cable and take each individual earth bonding cable separately to a dedicated earth bar, to prevent loss of continuity to all the extraneous metal parts, should the single connection point become corroded or fail.

It was not possible to determine if the LV side of each transformer had a dedicated star point earth matrix, usually comprising of several copper rods driven into the ground, connected to 70mm² bare copper cable or tape and then connected to a copper earth bar. No easily visible evidence could be observed.

The EAWR Regulation 4 applies here again, all electrical systems must be constructed and maintained at all times to prevent danger, so far as is reasonably practicable.

Every work activity, including operation, use and maintenance of a system and work near a system, shall be carried out in such a manner as not to give rise, so far as is practicable, to danger.

The EAWR Regulation 5 also applies here, Strength and capability of electrical equipment This regulation does not allow any electrical equipment to be put to use where its strength and capability may be exceeded and must not give rise to danger.

The term 'strength and capability' of electrical equipment refers to the ability of the equipment to withstand the thermal, electromagnetic, electrochemical or other effects of the electrical currents which might be expected to flow when the equipment is part of a system. These currents include, for example, load currents, transient overloads, fault currents, pulses of current and, for alternating current circuits, currents at various power factors and frequencies. Insulation must be effective to enable the equipment to withstand the applied voltage and any likely transient over-voltages.

The EAWR Regulation 8 also applies, Precautions shall be taken, either by earthing or by other suitable means, to prevent danger arising when any conductor (other than a circuit conductor) which may reasonably foreseeably become charged as a result of either the use of a system, or a fault in a system, becomes so charged; and, for the purposes of ensuring compliance with this regulation, a conductor shall be regarded as earthed when it is connected to the general mass of earth by conductors of sufficient strength and current-carrying capability to discharge electrical energy to earth.

11. No evidence was provided with regard to the selection, size or suitability of the network cables, nor to any selection and sizing of protective devices utilised, primarily fuses on the HV network.

The EAWR Regulation 5 also applies here again, Strength and capability of electrical Equipment and also Regulation 11 Means for protecting from excess current Efficient means, suitably located, shall be provided for protecting from excess of current in every part of a system as may be necessary to prevent danger There is a need to anticipate excess current, a fault or overload.

This would usually be in the form of a protection and grading study and load flow study, showing evidence that excess or fault currents have been considered, that the cables and protective devices employed are correctly sized and suitable so as to prevent danger arising. The grading study should also demonstrate that only parts of the network affected by the overload or fault are disconnected, rather than a wider unaffected network. A simple example of this is a domestic property, where if a fault occurs on a lighting circuit, only the lighting fuse or protective device operates, leaving the rest of the house unaffected and with power.

12. Little evidence could be seen with regard to ongoing network upgrading, with more modern equipment being used to gradually replace ageing assets. The only evidence seemed to be when customer driven demand dictated an upgrade, such as the new dairy or telecoms building.
13. The loading of the transformers was light, with the majority, being cool or just 'aired' however, it is accepted that the weather was very warm, sunny and the island 'population' was minimal.
14. Most of the transformers are of significant vintage, being manufactured before the introduction of energy efficient cores to B.S.171 1978 and so will be more expensive to run.
A transformer has 2 main power losses, variable copper losses, which are directly proportional to the load being taken and iron losses which are the losses in the transformer core and are present even if the transformer is supplying no load. These losses can only be reduced by replacing the transformers with more modern, energy efficient ones. The present standard is for Tier 2 units.
15. General vegetation maintenance and cleaning are required around all the assets.

Asset list and locations, the numbers refer to numbered locations on the attached map.

Island map

- 1A Power Station
- 1 Opposite Yellow Brick Road, on rear access road to power stn.
- 2 Behind Avenue Bakery
- 3 The Avenue, opposite the Post Office
- 4 Field, opposite Mermaid Pub
- 5 La Vallette
- 6 Carrefour crossroads
- 7 Baytree transformer switch, corner of Rue Lucas & Rue du Fort
- 8 Baytree transformer
- 9 Island Hall
- 10 Opposite Seigneurie
- 11 Infield, North Rd to S bend, opposite airplane field
- 12 Methodist Chapel corner
- 13 Vauroque crossroads
- 14 Plaisance
- 15 Le Pre du Moulin guest house (just past the mill)
- 16 Stocks Hotel corner
- 17 Little Sark Old Barracks
- 18 Little Sark Bar, just South of La Coupee
- 19 Little Sark Road
- 20 Field, opposite Peignury Farm
- 21 Les Laches (just above new slaughterhouse)
- 22 Harbour stone substation
- 23 Telecoms building
- 24 HV cable joint near new dairy
- 25 Xx
- 26 Xx
- 27 Dixcart Hotel
- 28 La Moinerie

Island map

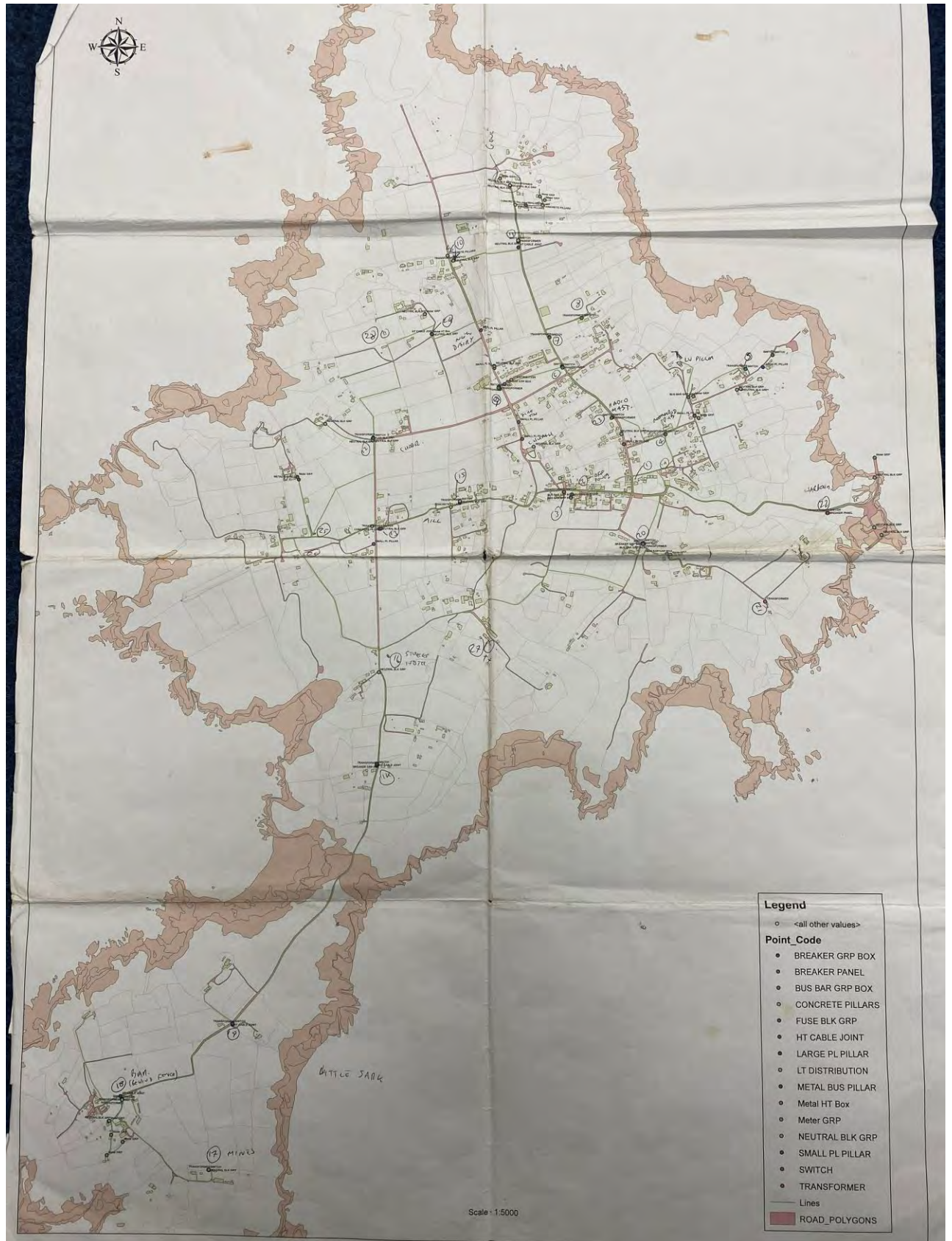

Individual site comments

1A Power Station

No access was granted to access the power station, however, from the publicly accessible areas, it appears that the switchgear looks to be Long and Crawford GF3 variants, so the general comments apply. The condition of the generators could not be assessed.



1 Opposite Yellow Brick Road, on rear access road to power station

The transformer HV cable is not supported and the weight is taken by the termination glands, although it is not certain because of the covering, the cable termination at the transformer appears to be of an LV type. The transformer HV cable box is a cast iron type, which are usually pitch filled, this box is unfilled (dry) and if a serious fault were to occur, shards of cast iron could be blown out, if pitch filled, the pitch has the effect of holding the metal in place.



3 The Avenue, opposite the Post Office

The transformer HV cable box is a cast iron type, which are usually pitch filled, this box is unfilled (dry) and if a serious fault were to occur, shards of cast iron could be blown out, if pitch filled, the pitch has the effect of holding the metal in place. The HV cable termination is partially rotted and dangerous.



4 Field, opposite Mermaid Pub



12 Oct 2021 at 12:17:34
Sark
Guernsey
GY10
United Kingdom



12 Oct 2021 at 12:13:38
Sark
Guernsey
GY10
United Kingdom



12 Oct 2021 at 12:13:44
Sark
Guernsey
GY10
United Kingdom



12 Oct 2021 at 12:14:22
Sark
Guernsey
GY10
United Kingdom



12 Oct 2021 at 12:14:48
Sark
Guernsey
GY10
United Kingdom

5 La Vallette



7 Baytree transformer switch, corner of Rue Lucas & Rue du Fort



8 Baytree transformer

Transformer only, no local isolation point (assumed to be location No. 7)

The EAWR Regulation 12, requires a Suitable means of isolation and be located so the accessibility and ease with which it may be employed is appropriate for the application. The time and effort that must be expended to effect isolation should be reasonable, depending on the nature of the equipment and the circumstances under which isolation may be required. For example, a very remote means of isolation may be acceptable if isolation is only needed infrequently and any additional time taken to effect isolation does not result in danger;

(d) be clearly marked to show which equipment it relates to, unless there could be no doubt that this would be obvious to any person who may need to operate it;



9 Island hall



12 Oct 2021 at 13:39:04
Sark
Guernsey
GY10
United Kingdom



12 Oct 2021 at 13:39:10
Sark
Guernsey
GY10
United Kingdom



12 Oct 2021 at 13:39:14
Sark
Guernsey
GY10
United Kingdom

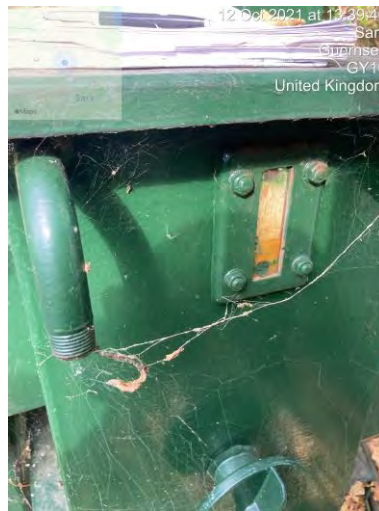

12 Oct 2021 at 13:39:16
Sark
Guernsey
GY10
United Kingdom



12 Oct 2021 at 13:39:32
Sark
Guernsey
GY10
United Kingdom

10 Opposite La Seigneurie

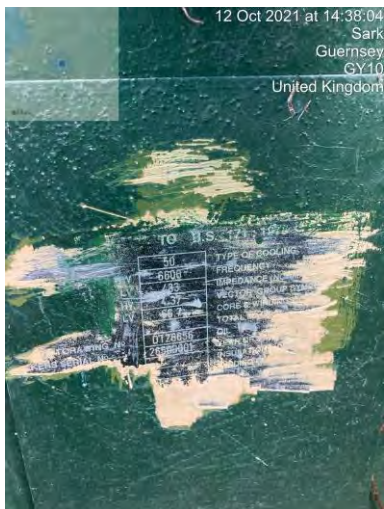
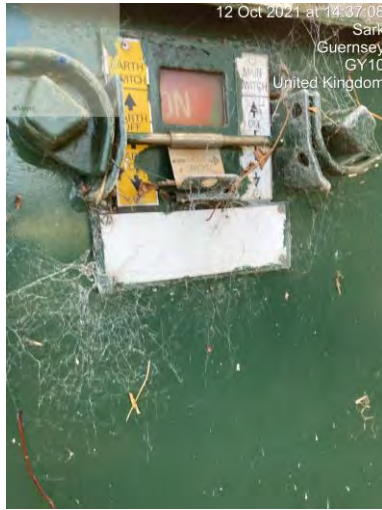

The LV distribution box shows a hot spot near the top of the box RHS

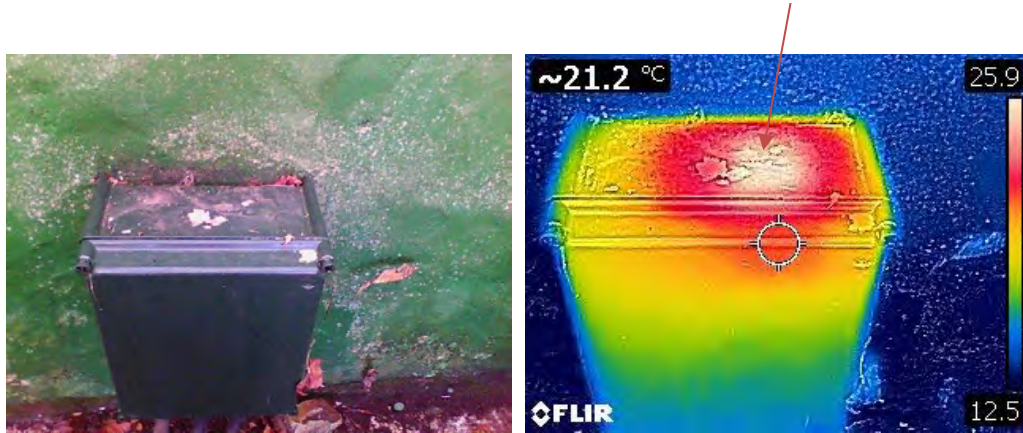

11 Infield, North Rd to S bend, opposite airplane field

The LHS HV switch has a cable gland plate that has rotted and in very bad condition, however it was not possible to determine if this cable was still energised. The RHS switch has 2 HV cables coming from the outgoing cable box, which is bad practice, a protective device should feed only 1 circuit.



12 Oct 2021 at 15:11:39
Sark
Guernsey
GY10
United Kingdom

YEAR OF MANUFACTURE		
WASS	350	kg
INSULANT OIL	87	kg
RATED VOLTAGE (U)	7.2 & 12	
RATED FREQUENCY	50/60 Hz	
PULSE WITHSTAND(Uw)	95 kVp	
RATED VOLTAGE (U)		
	7.2 kV	12 kV
FUSE SWITCH (In : 200A)		
MAXIMUM PROSPECTIVE SHORT-CIRCUIT RATINGS, WHEN APPROPRIATE FUSES TO BS 2892 & IEC 282 ARE FITTED:		
I _{ma}	kA	46.9
BREAKING CURRENT	kA	18.4
TRANSFORMER EARTH-SWITCH		
I _{ma}	kA	5.4
I _{th} (3sec)	kA	2.1
INCOMING CIRCUIT EARTH-SWITCH		
I _{ma}	kA	46.9
I _{th} (3 sec)	kA	18.4
TESTING STANDARDS: ASIA 22, BS 5429 & IEC 129		
CFC ALSTHOM T&D Long & Crawford Limited Wp 5DA England		

TRAN
FUSI



12 Methodist Chapel corner

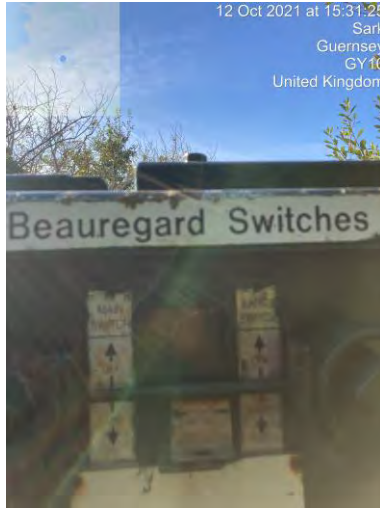

13 Vauroque crossroads

Several nuts missing from HV cable box lids, compromising the integrity and safety.



15 Le Pre du Moulin



16 Stocks hotel corner



La Coupee Little Sark feed cable

The HV feed cable to Little Sark on the west side of La Coupee, is unsupported due to cliff erosion and the outer steel armours, which provide its mechanical strength, have largely rotted away, seriously compromising the integrity of the cable, electrical supply to Little Sark and safety. The steel armours also provide an earth return path in the event of an electrical fault, allowing any earth currents to flow safely to the mass of the ground.



18 Little Sark T junction, Bar garden

Switch and transformer are fenced, making access difficult.



19 Little Sark main road, South of la Coupee

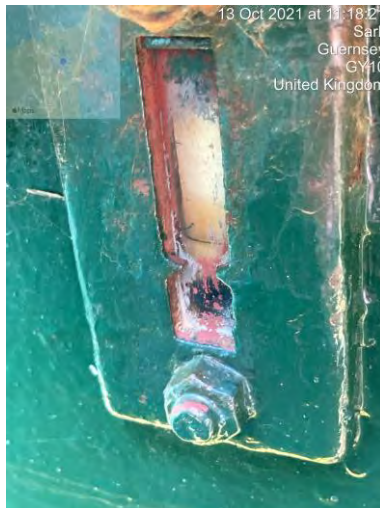

20 Field, Opposite Peignury Farm

RHS HV switch has a plastic rear HV cable box with only T key locks. This also feeds 2 circuits, which is not good practice.



Hot spot in LV distribution box



21 Les Laches, (up from new slaughterhouse)

Transformer only, no local isolation point (assumed to be location No. 7)

The EAWR Regulation 12, requires a Suitable means of isolation and be located so the accessibility and ease with which it may be employed is appropriate for the application. The time and effort that must be expended to effect isolation should be reasonable, depending on the nature of the equipment and the circumstances under which isolation may be required. For example, a very remote means of isolation may be acceptable if isolation is only needed infrequently and any additional time taken to effect isolation does not result in danger;

(d) be clearly marked to show which equipment it relates to, unless there could be no doubt that this would be obvious to any person who may need to operate it;

The transformer HV cable box is a cast iron type, which are usually pitch filled, this box is unfilled (dry) and if a serious fault were to occur, shards of cast iron could be blown out, if pitch filled, the pitch has the effect of holding the metal in place.

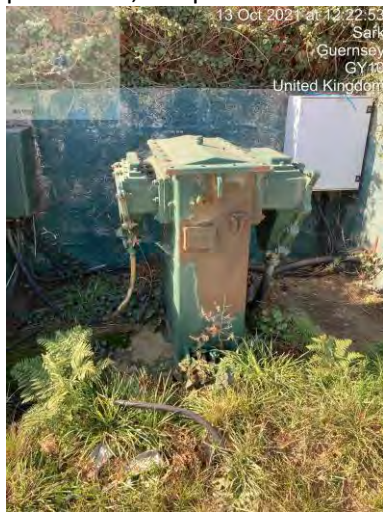

22 Harbour

Construction of building makes access and operation of switchgear difficult.
Slight oil leak from top of transformer, also evident on substation floor.

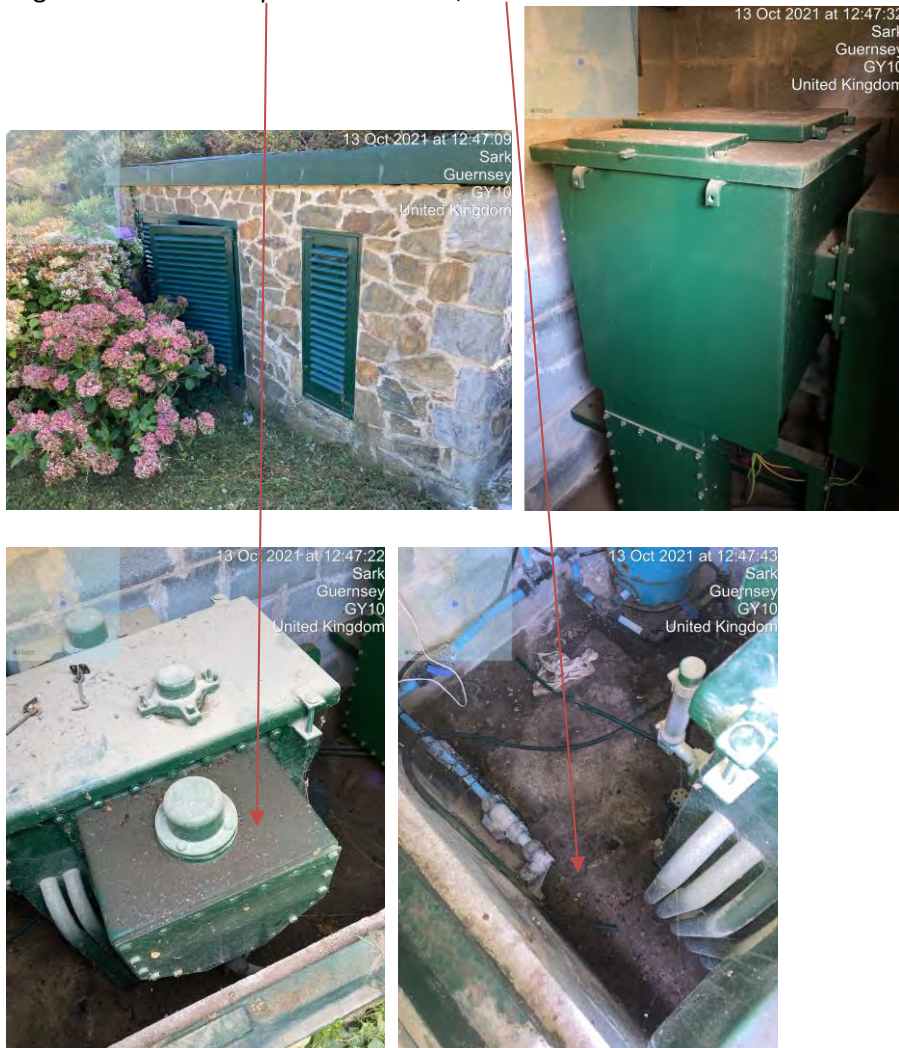

23 Telecoms building

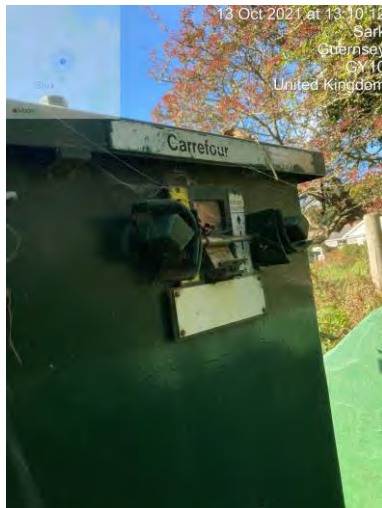

24 HV cable box near new dairy

The HV cable box appears to be a transformer cable box joining 2 HV cables. This should be a resin filled straight joint.



The transformer circuit breaker is switched off, although the ring switches are on.



26

Access to the switchgear and transformer are severely restricted, due to the wooden building. Operation of the switchgear would be impossible without removal of the LHS panel.



27 Dixcart Hotel

Not surveyed, due to no access to locked building

28 La Moinerie

Fairly recent installation, serious rat issue.



Acknowledgements

The author is grateful for the kindness and help shown during this survey by the residents of Sark, whose welcoming attitude was greatly appreciated.

Special thanks to the Chief Pleas, John, Zannette, Kathleen and Tony for their help and support with logistics and planning.

Thanks also to my guides and 'chauffeurs', Simon, Kevin and Vaughan for their valuable time, local knowledge and endless patience with my route demands and revisits, to the workers of Sark, who's normal routines were sometimes impeded by my travels and not least, to Linda my landlady during my stay on Sark.

APPENDICES

Appendix A	Health and Safety at Work etc. Act 1974
Appendix B	The Electricity at Work Regulations 1989
Appendix C	HSE Guidance HSG230 Keeping Switchgear Safe
Appendix D	HSE Guidance HSG85 Electricity at Work
Appendix E	HSE Publication Do you know how to Work Safely with PCBs?
Appendix F	ENA NEDeRS Ref. SOP 2013/0383/06
Appendix G	Electricity Northwest Operational Instruction 206 Issue 6

APPENDIX A

Health and Safety at Work etc Act 1974



Health and Safety at Work etc. Act 1974

1974 CHAPTER 37

An Act to make further provision for securing the health, safety and welfare of persons at work, for protecting others against risks to health or safety in connection with the activities of persons at work, for controlling the keeping and use and preventing the unlawful acquisition, possession and use of dangerous substances, and for controlling certain emissions into the atmosphere; to make further provision with respect to the employment medical advisory service; to amend the law relating to building regulations, and the Building (Scotland) Act 1959; and for connected purposes. [31st July 1974]

Extent Information

- E1** For the application of this Act to Northern Ireland see s. 84(1); Pt. III of this Act (except s. 75 and Sch. 7) does not extend to Scotland see s. 84(2).

Modifications etc. (not altering text)

- C1** Act applied (15.12.1999) by 1996 c. 18, **Pt. VIII**, s. 72(4) (as substituted (15.12.1999) by 1999 c. 26, ss. 7, 8, 9, **Sch. 4 Pt. I**; S.I. 1999/2830, **art. 2(2)**)
Act extended (11.10.1999) by S.I. 1999/2550, **reg. 3**
- C2** Act applied by S.I. 1988/778, **reg. 11(1)**
- C3** Act applied by S.I. 1990/13, **reg. 11(5)**
Act applied in part (1.9.1993) by S.I. 1993/1746, **reg. 18(1)(a)**.
Act extended (1.1.1994) by S.I. 1993/2379, **reg. 9(a)**.
Act extended (1.12.1993) by S.I. 1993/2714, **reg. 9(4)(a)**.
Act applied (31.1.1994) by S.I. 1993/3050, **art. 21(1)(a)** (with art. 3).
Act applied (with modifications) (29.7.1994) by S.I. 1994/1806, **regs. 3(1), 12**
Act applied in part (15.3.1995) by S.I. 1995/263, **arts. 3-8, 10**
Act applied (with modifications) (18.7.1995) by S.I. 1995/1629, **art. 30(3)(b)(5)**
- C4** Act: specified provisions applied (with modifications) (29.11.1992) by S.I. 1992/2415, **reg. 4(1)**
- C5** Act: specified provisions applied (1.1.1993) by S.I. 1992/2997, **reg. 6**
- C6** Act: specified provisions applied (with modifications) (E.W.S.) (1.1.1993) by S.I. 1992/3060, **reg. 15(1)**
- C7** Act: specified provisions applied (E.W.S.) (1.2.1993) by S.I. 1992/3217, **reg. 21(1)**

Changes to legislation: *Health and Safety at Work etc. Act 1974 is up to date with all changes known to be in force on or before 28 April 2021. There are changes that may be brought into force at a future date. Changes that have been made appear in the content and are referenced with annotations. (See end of Document for details) View outstanding changes*

- C8** Act excluded (E.W.) (1.10.2006) by [The Regulatory Reform \(Fire Safety\) Order 2005 \(S.I. 2005/1541\)](#), arts. 1(3), **47** (with art. 49) (as amended by [The Regulatory Reform \(Fire Safety\) Subordinate Provisions Order 2006 \(S.I. 2006/484\)](#), arts. 1(1), **2**)
- C9** Act modified (30.5.2007) by [The National Assembly for Wales Commission \(Crown Status\) \(No. 2\) Order 2007 \(S.I. 2007/1353\)](#), **art. 2**
- C10** Act modified (E.W.S.) (26.3.2015) by [The Ship Recycling Facilities Regulations 2015 \(S.I. 2015/430\)](#), regs. 1(1), **5** (as amended (31.12.2020) by [The Ship Recycling \(Facilities and Requirements for Hazardous Materials on Ships\) \(Amendment\) \(EU Exit\) Regulations 2019 \(S.I. 2019/277\)](#), regs. 1, **3(4)**; 2020 c. 1, Sch. 5 para. 1(1))
- C11** Act applied (E.W.S.) (19.7.2015) by [The Offshore Installations \(Offshore Safety Directive\) \(Safety Case etc.\) Regulations 2015 \(S.I. 2015/398\)](#), **reg. 36(8)** (with reg. 4(2), Sch. 14)

PART I

HEALTH, SAFETY AND WELFARE IN CONNECTION WITH WORK, AND CONTROL OF DANGEROUS SUBSTANCES AND CERTAIN EMISSIONS INTO THE ATMOSPHERE

Extent Information

- E2** For the application of Pt. I to Northern Ireland see s. 84(1).

Modifications etc. (not altering text)

- C12** Pt. 1 (ss. 1–54) extended by [S.I. 1981/1011](#), **reg. 9**, 1983/1919, reg. 3
 Pt. 1 (ss. 1-54) modified (E.W.S.) (1.2.1996) by [1995 c. 25, s. 5\(5\)\(b\)](#) (with ss. 115, 117); [S.I. 1996/186](#), **art. 2**
 Pt. 1 (ss. 1-54) modified (E.W.S.) (1.4.1996) by [1995 c. 25, s. 33\(5\)\(e\)](#) (with s. 7(6), 115, 117); [S.I. 1996/186](#), **art. 3**
 Pt. 1 (ss. 1-54) amended (E.W.S.) (1.4.1996) by [1995 c. 25, s. 120\(1\)](#), **Sch. 22 para. 30(2)** (with ss. 7(6), 115, 117); [S.I. 1996/186](#), **art. 3**
 Pt. 1 (ss. 1-54) amended (E.W.S.) (1.3.1996) by [1995 c. 45, s. 16\(1\)](#), **Sch. 4 para. 10(1)(a)(3)**; [S.I. 1996/218](#), **art. 2**
- C13** Pt. 1 (ss. 1–54) extended by [Gas Act 1986 \(c. 44, SIF 44:2\)](#), **ss. 18, 48(3)(4)**
- C14** Pt. 1 (ss. 1–54) applied by [Gas Act 1986 \(c. 44, SIF 44:2\)](#), s. 67(3), **Sch. 8 para. 6(2)**
- C15** Pt. 1 (ss. 1–54) amended by [Consumer Protection Act 1987 \(c. 43, SIF 109:1\)](#), **s. 36**
- C16** Pt. 1 (ss. 1–54) amended by [S.I. 1988/1222](#), **regs. 3, 4**
- C17** Pt. 1 (ss. 1–54) extended by [S.I. 1989/1671](#), **reg. 4**
- C18** Pt. 1 (ss. 1–54) amended by [S.I. 1989/1810](#), **reg. 3** (which S.I. was revoked (1.2.1993) by [S.I. 1992/3217](#), **reg. 25**).
- C19** Pt. 1 (ss. 1–54) amended by [S.I. 1990/1380](#), **reg. 3**
 Pt. 1 (ss. 1-54) saved by [Highland Regional Council \(Harbours\) Order Confirmation Act \(c. xii\)](#), s. 1, Sch. s. 61(1)(f)
 Pt. 1 (ss. 1-54) definition applied (E.W.) (1.12.1991) by [Water Industry Act 1991 \(c. 56, SIF 130\)](#), **ss. 206(3)(g), 223(2)**
 Pt. 1 (ss. 1-54) saved by [London Underground \(Safety Measures\) Act 1991 \(c. xviii\)](#), **s. 11(2)**
 Pt. 1 (ss. 1-54) saved by [City of Edinburgh District Council Order Confirmation Act 1991 \(c. xix\)](#), s. 1, **Sch. 1 Pt. XII para. 67(2)**
- C20** Pt. 1 extended by [S.I. 1978/752](#), **reg. 3**
 Pt. 1 (ss. 1-54): transfer of functions (E.W.) (1.4.1996) by [1995 c. 25, s. 2\(1\)\(g\)\(2\)\(c\)](#) (with ss. 115, 117); [S.I. 1996/186](#), **art. 3**
 Pt. 1 (ss. 1-54): transfer of functions (S.) (12.10.1995) by [1995 c. 25, s. 21\(1\)\(g\)](#) (with ss. 7(6), 115, 117); [S.I. 1995/2649](#), **art. 2**

Changes to legislation: *Health and Safety at Work etc. Act 1974 is up to date with all changes known to be in force on or before 28 April 2021. There are changes that may be brought into force at a future date. Changes that have been made appear in the content and are referenced with annotations. (See end of Document for details) View outstanding changes*

- Pt. 1 (ss. 1-54): transfer of functions (E.W.S.) (12.10.1995) by 1995 c. 25, **s. 21(2)(a)** (with ss. 7(6), 115, 117); S.I. 1995/2649, **art. 2**
- C21** Pt. 1 (ss. 1-54) extended (E.W.S.) (6.3.1992) by **Offshore Safety Act 1992 (c. 15), S. 1(1)**
- C22** Pt. 1 (ss. 1-54) amended (E.W.S.) (6.3.1992) by **Offshore Safety Act 1992 (c. 15), s. 1(1)**
Pt. 1 (ss. 1-54) amended (E.W.S.) (2.2.1994) by 1993 c. 43, **s. 117(1)(6)**, 150(1)(e); S.I. 1994/202, **art. 2**
- C23** Pt. 1 (ss. 1-54) extended (E.W.S.) (1.2.1993) by S.I. 1992/3217, **reg. 4**
- C24** Pt. 1 (ss. 1-54) modified (E.W.S.) (1.1.1993) by S.I. 1992/2051, **reg. 16(2)**
- C25** Pt. 1 (ss. 1-54) extended (E.W.S.) (6.3.1992) by **Offshore Safety Act 1992 (c. 15), s. 2(1)**
Pt. 1 (ss. 1-54) extended (E.W.S.) (2.2.1994) by 1993 c. 43, **ss. 117(2)(6)**, 150(1)(e); S.I. 1994/202, **art. 2**
- C26** Pt. 1 (ss. 1-54) applied (with modifications) (14.4.1999) by S.I. 1999/860, **reg. 2**
- C27** Pt. 1 (ss. 1-54) applied (1.7.1999) by S.I. 1999/1517, **reg. 12(3), Sch. 4 para. 12(3)(c)**
Pt. 1: functions of local authority not to be responsibility of an executive of the authority (E.) (16.11.2000) by virtue of S.I. 2000/2853, **reg. 2(1), Sch. 1 Table C**
- C28** Pt. 1 restricted (S.) (1.10.2006) by 2005 asp 5, **ss. 70, 90**; S.I. 2006/458, **art. 2** (subject to art. 3)
- C29** Pt. 1 modified (prosp.) by **Energy Act 2008 (c. 32), ss. 99(1), 110**
- C30** Pt. 1: power to repeal or modify conferred (prosp.) by **Energy Act 2008 (c. 32), ss. 99(1)(2), 110**
- C31** Pt. 1 modified (1.1.2018) by **The Ionising Radiations Regulations 2017 (S.I. 2017/1075), regs. 1(2), 2(3)** (with **regs. 2(5), 3, Sch. 8**)
- C32** Pt. 1 applied (E.W.S.) (6.2.2018) by **The Ionising Radiation (Medical Exposure) Regulations 2017 (S.I. 2017/1322), regs. 1, 18**

Preliminary

1 Preliminary.

- (1) The provisions of this Part shall have effect with a view to—
- securing the health, safety and welfare of persons at work;
 - protecting persons other than persons at work against risks to health or safety arising out of or in connection with the activities of persons at work;
 - controlling the keeping and use of explosive or highly flammable or otherwise dangerous substances, and generally preventing the unlawful acquisition, possession and use of such substances; ^{F1}[^{F2}and]]
- ^{F1}[^{F2}(d) controlling the emission into the atmosphere of noxious or offensive substances from premises of any class prescribed for the purposes of this paragraph.]]
- (2) The provisions of this Part relating to the making of health and safety regulations ^{F3}. . . and the preparation and approval of codes of practice shall in particular have effect with a view to enabling the enactments specified in the third column of Schedule 1 and the regulations, orders and other instruments in force under those enactments to be progressively replaced by a system of regulations and approved codes of practice operating in combination with the other provisions of this Part and designed to maintain or improve the standards of health, safety and welfare established by or under those enactments.
- (3) For the purposes of this Part risks arising out of or in connection with the activities of persons at work shall be treated as including risks attributable to the manner of conducting an undertaking, the plant or substances used for the purposes of an undertaking and the condition of premises so used or any part of them.

Changes to legislation: *Health and Safety at Work etc. Act 1974 is up to date with all changes known to be in force on or before 28 April 2021. There are changes that may be brought into force at a future date. Changes that have been made appear in the content and are referenced with annotations. (See end of Document for details) View outstanding changes*

- (4) References in this Part to the general purposes of this Part are references to the purposes mentioned in subsection (1) above.

Textual Amendments

- F1** S. 1(1)(d) and preceding word repealed (16.12.1996 for E.W and otherwise prosp.) by 1990 c. 43, s. 162(2), 164(3), **Sch. 16 Pt. I**; S.I. 1996/3056, **art. 2**
- F2** S. 1(1)(d) and preceding word repealed (S.) (26.2.2015) by **The Regulatory Reform (Scotland) Act 2014 (Consequential Modifications) Order 2015** (S.I. 2015/374), arts. 1(1), **2(2)**
- F3** Words repealed by **Employment Protection Act 1975 (c. 71)**, **Sch. 18**

Modifications etc. (not altering text)

- C33** Ss. 1–25, 26, 27, 28, 30, 33, 34–59, 80, 81 and 82 applied by S.I. 1989/840, **arts. 2–10**
- C34** Ss. 1–59, 80–82 applied (11.7.2001) by S.I. 2001/2127, **arts. 4(1)**, 5(1)(2), 6(1), 7(1), 8(1), 10 (with art. 11) (as amended by S.I. 2009/1750, **art. 2(2)(4)**)
- C35** Ss. 1–59, 80–82 applied (temp.) (5.8.2009) by **The Health and Safety at Work etc. Act 1974 (Application outside Great Britain) Order 2001** (S.I. 2001/2127), arts. 8A, 8B (as inserted by S.I. 2009/1750, **art. 2(3)**)
- C36** Ss. 1–59 applied by S.I. 2001/2127 art. 8A 8B (as inserted (E.W.S.) (6.4.2011) by **The Health and Safety at Work etc. Act 1974 (Application outside Great Britain) (Variation) Order 2011** (S.I. 2011/745), arts. 1(1), **3(2)**)
- C37** S. 1(1)(c) extended (E.W.S.) (8.8.1996) by S.I. 1996/2075, **reg. 2(1)** (which amending provision was revoked (11.3.2002) by S.I. 2002/282, **art. 4**)
 S. 1(1)(c) modified (E.W.S.) (11.3.2002) by S.I. 2002/282, **art. 3**
- C38** S. 1(2) modified by **Gas Act 1986 (c. 44, SIF 44:2)**, s. 67(3), **Sch. 8 Pt. I para. 6(3)**
- C39** S. 1(3) applied by **Companies Act 1985 (c. 6, SIF 27)**, s. 235(5), **Sch. 7 Pt. IV para. 10(4)**
- C40** S. 1(3) applied (1.4.2014) by **Energy Act 2013 (c. 32)**, **ss. 69(3)**, 156(1) (with ss. 107, 111); S.I. 2014/251, **art. 4**

General duties

2 **General duties of employers to their employees.**

- (1) It shall be the duty of every employer to ensure, so far as is reasonably practicable, the health, safety and welfare at work of all his employees.
- (2) Without prejudice to the generality of an employer's duty under the preceding subsection, the matters to which that duty extends include in particular—
- (a) the provision and maintenance of plant and systems of work that are, so far as is reasonably practicable, safe and without risks to health;
 - (b) arrangements for ensuring, so far as is reasonably practicable, safety and absence of risks to health in connection with the use, handling, storage and transport of articles and substances;
 - (c) the provision of such information, instruction, training and supervision as is necessary to ensure, so far as is reasonably practicable, the health and safety at work of his employees;
 - (d) so far as is reasonably practicable as regards any place of work under the employer's control, the maintenance of it in a condition that is safe and without risks to health and the provision and maintenance of means of access to and egress from it that are safe and without such risks;

Changes to legislation: *Health and Safety at Work etc. Act 1974 is up to date with all changes known to be in force on or before 28 April 2021. There are changes that may be brought into force at a future date. Changes that have been made appear in the content and are referenced with annotations. (See end of Document for details) View outstanding changes*

- (e) the provision and maintenance of a working environment for his employees that is, so far as is reasonably practicable, safe, without risks to health, and adequate as regards facilities and arrangements for their welfare at work.
- (3) Except in such cases as may be prescribed, it shall be the duty of every employer to prepare and as often as may be appropriate revise a written statement of his general policy with respect to the health and safety at work of his employees and the organisation and arrangements for the time being in force for carrying out that policy, and to bring the statement and any revision of it to the notice of all of his employees.
- (4) Regulations made by the Secretary of State may provide for the appointment in prescribed cases by recognised trade unions (within the meaning of the regulations) of safety representatives from amongst the employees, and those representatives shall represent the employees in consultations with the employers under subsection (6) below and shall have such other functions as may be prescribed.
- ^{F4}(5)
- (6) It shall be the duty of every employer to consult any such representatives with a view to the making and maintenance of arrangements which will enable him and his employees to co-operate effectively in promoting and developing measures to ensure the health and safety at work of the employees, and in checking the effectiveness of such measures.
- (7) In such cases as may be prescribed it shall be the duty of every employer, if requested to do so by the safety representatives mentioned in [^{F5}subsection (4)] above, to establish, in accordance with regulations made by the Secretary of State, a safety committee having the function of keeping under review the measures taken to ensure the health and safety at work of his employees and such other functions as may be prescribed.

Textual Amendments

- F4** Ss. 2(5), 29, 31, 32, 50(4)(5), 53(2)–(6) repealed by [Employment Protection Act 1975 \(c. 71\)](#), **Sch. 18**
- F5** Words substituted by [Employment Protection Act 1975 \(c. 71\)](#), **Sch. 15 para. 2**

Modifications etc. (not altering text)

- C36** Ss. 1-59 applied by S.I. 2001/2127 art. 8A 8B (as inserted (E.W.S.) (6.4.2011) by [The Health and Safety at Work etc. Act 1974 \(Application outside Great Britain\) \(Variation\) Order 2011 \(S.I. 2011/745\)](#), arts. 1(1), **3(2)**)
- C41** Ss. 1–25, 26, 27, 28, 30, 33, 34–59, 80, 81 and 82 applied by S.I. 1989/840, **arts. 2–10**
- C42** Ss. 1-59, 80-82 applied (11.7.2001) by S.I. 2001/2127, **arts. 4(1)**, 5(1)(2), 6(1), 7(1), 8(1), 10 (with art. 11) (as amended by S.I. 2009/1750, **art. 2(2)(4)**)
- C43** Ss. 1-59, 80-82 applied (temp.) (5.8.2009) by [The Health and Safety at Work etc. Act 1974 \(Application outside Great Britain\) Order 2001 \(S.I. 2001/2127\)](#), arts. 8A, 8B (as inserted by S.I. 2009/1750, **art. 2(3)**)
- C44** S. 2(1)(2)(3) modified (15.11.2000) by S.I. 2000/2831, **reg. 5(1)**
- C45** S. 2(1) modified (E.W.S.) (1.10.2014) by [The Genetically Modified Organisms \(Contained Use\) Regulations 2014 \(S.I. 2014/1663\)](#), regs. 1, **4(2)** (with reg. 3(1)(2))
- C46** S. 2(2) modified (E.W.S.) (1.10.2014) by [The Genetically Modified Organisms \(Contained Use\) Regulations 2014 \(S.I. 2014/1663\)](#), regs. 1, **4(2)** (with reg. 3(1)(2))
- C47** S. 2(3) modified (1.10.1993) by S.I. 1993/1897, **art. 4(4)**.
- C48** S. 2(3) modified (E.W.S.) (1.10.2014) by [The Genetically Modified Organisms \(Contained Use\) Regulations 2014 \(S.I. 2014/1663\)](#), regs. 1, **4(2)** (with reg. 3(1)(2))

Changes to legislation: Health and Safety at Work etc. Act 1974 is up to date with all changes known to be in force on or before 28 April 2021. There are changes that may be brought into force at a future date. Changes that have been made appear in the content and are referenced with annotations. (See end of Document for details) View outstanding changes

C49 S. 2(4) modified by [S.I. 1977/500, reg. 8\(1\)](#)

3 General duties of employers and self-employed to persons other than their employees.

- (1) It shall be the duty of every employer to conduct his undertaking in such a way as to ensure, so far as is reasonably practicable, that persons not in his employment who may be affected thereby are not thereby exposed to risks to their health or safety.
- (2) It shall be the duty of every self-employed person [^{F7}who conducts an undertaking of a prescribed description] to conduct [^{F8}the undertaking] in such a way as to ensure, so far as is reasonably practicable, that he and other persons (not being his employees) who may be affected thereby are not thereby exposed to risks to their health or safety.
- [^{F9}(2A) A description of undertaking included in regulations under subsection (2) may be framed by reference to—
- (a) the type of activities carried out by the undertaking, where those activities are carried out or any other feature of the undertaking;
 - (b) whether persons who may be affected by the conduct of the undertaking, other than the self-employed person (or his employees), may thereby be exposed to risks to their health or safety.]
- (3) In such cases as may be prescribed, it shall be the duty of every employer and every self-employed person, in the prescribed circumstances and in the prescribed manner, to give to persons (not being his employees) who may be affected by the way in which he conducts his undertaking the prescribed information about such aspects of the way in which he conducts his undertaking as might affect their health or safety.

Textual Amendments

- F6** S. 3(2) amendment to earlier affecting provision [S.I. 2002/2677, reg. 20 \(1.10.2015\)](#) by [The Deregulation Act 2015 \(Health and Safety at Work\) \(General Duties of Self-Employed Persons\) \(Consequential Amendments\) Order 2015 \(S.I. 2015/1637\), art. 1, Sch. para. 7\(3\)](#)
- F7** Words in s. 3(2) inserted (26.3.2015 for specified purposes, 1.10.2015 in so far as not already in force) by [Deregulation Act 2015 \(c. 20\), ss. 1\(2\)\(a\), 115\(2\)\(a\) \(with s. 1\(6\)\); S.I. 2015/1732, art. 2\(a\)](#)
- F8** Words in s. 3(2) substituted (26.3.2015 for specified purposes, 1.10.2015 in so far as not already in force) by [Deregulation Act 2015 \(c. 20\), ss. 1\(2\)\(b\), 115\(2\)\(a\) \(with s. 1\(6\)\); S.I. 2015/1732, art. 2\(a\)](#)
- F9** S. 3(2A) inserted (26.3.2015 for specified purposes, 1.10.2015 in so far as not already in force) by [Deregulation Act 2015 \(c. 20\), ss. 1\(3\), 115\(2\)\(a\) \(with s. 1\(6\)\); S.I. 2015/1732, art. 2\(a\)](#)

Modifications etc. (not altering text)

- C36** Ss. 1-59 applied by [S.I. 2001/2127 art. 8A 8B \(as inserted \(E.W.S.\) \(6.4.2011\)\)](#) by [The Health and Safety at Work etc. Act 1974 \(Application outside Great Britain\) \(Variation\) Order 2011 \(S.I. 2011/745\), arts. 1\(1\), 3\(2\)](#)
- C50** Ss. 1-25, 26, 27, 28, 30, 33, 34-59, 80, 81 and 82 applied by [S.I. 1989/840, arts. 2-10](#)
- C51** Ss. 1-59, 80-82 applied (11.7.2001) by [S.I. 2001/2127, arts. 4\(1\), 5\(1\)\(2\), 6\(1\), 7\(1\), 8\(1\), 10 \(with art. 11\) \(as amended by S.I. 2009/1750, art. 2\(2\)\(4\)\)](#)
- C52** Ss. 1-59, 80-82 applied (temp.) (5.8.2009) by [The Health and Safety at Work etc. Act 1974 \(Application outside Great Britain\) Order 2001 \(S.I. 2001/2127\), arts. 8A, 8B \(as inserted by S.I. 2009/1750, art. 2\(3\)\)](#)
- C53** S. 3(2) modified by [S.I. 1978/752, reg. 4](#)
 S. 3(2) modified (16.1.1995) by [S.I. 1994/3246, reg. 20](#)

Changes to legislation: *Health and Safety at Work etc. Act 1974 is up to date with all changes known to be in force on or before 28 April 2021. There are changes that may be brought into force at a future date. Changes that have been made appear in the content and are referenced with annotations. (See end of Document for details) View outstanding changes*

- C54** S. 3(2) modified by [S.I. 1981/1011](#), [reg. 10](#)
- C55** S. 3(2) modified by [S.I. 1989/1810](#), [reg. 4](#) (which S.I. was revoked (1.2.1993) by [S.I. 1992/3217](#), [reg. 25](#)).
- C56** S. 3(2) modified (E.W.S.) (1.2.1993) by [S.I. 1992/3217](#), [reg. 5](#)
 S. 3(2) modified (25.3.1999) by [S.I. 1999/437](#), [reg. 20](#)
 S. 3(2) modified (15.11.2000) by [S.I. 2000/2831](#), [reg. 5\(2\)](#)
 S. 3(2) modified (21.11.2002) by [S.I. 2002/2677](#), [reg. 20](#)
- C57** S. 3(2) modified (E.W.S.) (1.10.2014) by [The Genetically Modified Organisms \(Contained Use\) Regulations 2014 \(S.I. 2014/1663\)](#), [regs. 1, 4\(3\)](#) (with [reg. 3\(1\)\(2\)](#))

4 **General duties of persons concerned with premises to persons other than their employees.**

- (1) This section has effect for imposing on persons duties in relation to those who—
- (a) are not their employees; but
 - (b) use non-domestic premises made available to them as a place of work or as a place where they may use plant or substances provided for their use there,
- and applies to premises so made available and other non-domestic premises used in connection with them.
- (2) It shall be the duty of each person who has, to any extent, control of premises to which this section applies or of the means of access thereto or egress therefrom or of any plant or substance in such premises to take such measures as it is reasonable for a person in his position to take to ensure, so far as is reasonably practicable, that the premises, all means of access thereto or egress therefrom available for use by persons using the premises, and any plant or substance in the premises or, as the case may be, provided for use there, is or are safe and without risks to health.
- (3) Where a person has, by virtue of any contract or tenancy, an obligation of any extent in relation to—
- (a) the maintenance or repair of any premises to which this section applies or any means of access thereto or egress therefrom; or
 - (b) the safety of or the absence of risks to health arising from plant or substances in any such premises;
- that person shall be treated, for the purposes of subsection (2) above, as being a person who has control of the matters to which his obligation extends.
- (4) Any reference in this section to a person having control of any premises or matter is a reference to a person having control of the premises or matter in connection with the carrying on by him of a trade, business or other undertaking (whether for profit or not).

Modifications etc. (not altering text)

- C36** Ss. 1-59 applied by [S.I. 2001/2127](#) art. 8A 8B (as inserted (E.W.S.) (6.4.2011) by [The Health and Safety at Work etc. Act 1974 \(Application outside Great Britain\) \(Variation\) Order 2011 \(S.I. 2011/745\)](#), [arts. 1\(1\), 3\(2\)](#))
- C58** Ss. 1-25, 26, 27, 28, 30, 33, 34-59, 80, 81 and 82 applied by [S.I. 1989/840](#), [arts. 2-10](#)
- C59** Ss. 1-59, 80-82 applied (11.7.2001) by [S.I. 2001/2127](#), [arts. 4\(1\), 5\(1\)\(2\), 6\(1\), 7\(1\), 8\(1\), 10](#) (with [art. 11](#)) (as amended by [S.I. 2009/1750](#), [art. 2\(2\)\(4\)](#))

Changes to legislation: *Health and Safety at Work etc. Act 1974 is up to date with all changes known to be in force on or before 28 April 2021. There are changes that may be brought into force at a future date. Changes that have been made appear in the content and are referenced with annotations. (See end of Document for details) View outstanding changes*

C60 Ss. 1-59, 80-82 applied (temp.) (5.8.2009) by The Health and Safety at [Work etc. Act 1974](#) (Application outside Great Britain) Order 2001 (S.I. 2001/2127), arts. 8A, 8B (as inserted by S.I. 2009/1750, [art. 2\(3\)](#))

[^{F10}5 General duty of persons in control of certain premises in relation to harmful emissions into atmosphere.

[^{F11}(1) [^{F12}Subject to subsection (5) below,]] It shall be the duty of the person having control of any premises of a class prescribed for the purposes of section 1(1)(d) to use the best practicable means for preventing the emission into the atmosphere from the premises of noxious or offensive substances and for rendering harmless and inoffensive such substances as may be so emitted.

(2) The reference in subsection (1) above to the means to be used for the purposes there mentioned includes a reference to the manner in which the plant provided for those purposes is used and to the supervision of any operation involving the emission of the substances to which that subsection applies.

(3) Any substance or a substance of any description prescribed for the purposes of subsection (1) above as noxious or offensive shall be a noxious or, as the case may be, an offensive substance for those purposes whether or not it would be so apart from this subsection.

(4) Any reference in this section to a person having control of any premises is a reference to a person having control of the premises in connection with the carrying on by him of a trade, business or other undertaking (whether for profit or not) and any duty imposed on any such person by this section shall extend only to matters within his control.

[^{F13}(5) The foregoing provisions of this section shall not apply in relation to any process which is a prescribed process as from the date which is the determination date for that process.

(6) For the purposes of subsection (5) above, the “determination date” for a prescribed process is—

(a) in the case of a process for which an authorisation is granted, the date on which the enforcing authority grants it, whether in pursuance of the application or, on an appeal, of a direction to grant it;

(b) in the case of a process for which an authorisation is refused, the date of the refusal or, on an appeal, of the affirmation of the refusal.

(7) In subsections (5) and (6) above “authorisation”, “enforcing authority” and “prescribed process” have the meaning given in section 1 of the Environmental Protection Act 1990 and the reference to an appeal is a reference to an appeal under section 15 of that Act.]]

Textual Amendments

F10 S. 5 repealed (16.12.1996 for E.W. and otherwise prosp.) by [Environmental Protection Act 1990 \(c. 43, SIF 46:4\)](#), ss. 162(2), 164(3), [Sch. 16 Pt. I](#); S.I. 1996/3056, [art. 2](#)

F11 S. 5 repealed (S.) (26.2.2015) by [The Regulatory Reform \(Scotland\) Act 2014 \(Consequential Modifications\) Order 2015 \(S.I. 2015/374\)](#), arts. 1(1), [2\(3\)](#)

F12 Words in s. 5 inserted (1.4.1991) by [Environmental Protection Act 1990 \(c. 43, SIF 46:4\)](#), s. 162(1), [Sch. 15 para. 14\(a\)](#); S.I. 1991/1042, [art.2](#)

Changes to legislation: *Health and Safety at Work etc. Act 1974 is up to date with all changes known to be in force on or before 28 April 2021. There are changes that may be brought into force at a future date. Changes that have been made appear in the content and are referenced with annotations. (See end of Document for details) View outstanding changes*

F13 S. 5(5)–(7) inserted (1.4.1991) by [Environmental Protection Act 1990 \(c. 43, SIF 46:4\)](#), s. 162(1), [Sch. 15 para. 14\(b\)](#); [S.I. 1991/1042](#), [art.2](#)

Modifications etc. (not altering text)

C36 Ss. 1–59 applied by [S.I. 2001/2127 art. 8A 8B](#) (as inserted (E.W.S.) (6.4.2011) by [The Health and Safety at Work etc. Act 1974 \(Application outside Great Britain\) \(Variation\) Order 2011 \(S.I. 2011/745\)](#), arts. 1(1), [3\(2\)](#))

C61 Ss. 1–25, 26, 27, 28, 30, 33, 34–59, 80, 81 and 82 applied by [S.I. 1989/840](#), [arts. 2–10](#)

C62 Ss. 1–59, 80–82 applied (11.7.2001) by [S.I. 2001/2127](#), [arts. 4\(1\)](#), [5\(1\)\(2\)](#), [6\(1\)](#), [7\(1\)](#), [8\(1\)](#), [10](#) (with [art. 11](#)) (as amended by [S.I. 2009/1750](#), [art. 2\(2\)\(4\)](#))

C63 Ss. 1–59, 80–82 applied (temp.) (5.8.2009) by [The Health and Safety at Work etc. Act 1974 \(Application outside Great Britain\) Order 2001 \(S.I. 2001/2127\)](#), arts. 8A, 8B (as inserted by [S.I. 2009/1750](#), [art. 2\(3\)](#))

6 General duties of manufacturers etc. as regards articles and substances for use at work.

[^{F14}(1) It shall be the duty of any person who designs, manufactures, imports or supplies any article for use at work or any article of fairground equipment—

- (a) to ensure, so far as is reasonably practicable, that the article is so designed and constructed that it will be safe and without risks to health at all times when it is being set, used, cleaned or maintained by a person at work;
- (b) to carry out or arrange for the carrying out of such testing and examination as may be necessary for the performance of the duty imposed on him by the preceding paragraph;
- (c) to take such steps as are necessary to secure that persons supplied by that person with the article are provided with adequate information about the use for which the article is designed or has been tested and about any conditions necessary to ensure that it will be safe and without risks to health at all such times as are mentioned in paragraph (a) above and when it is being dismantled or disposed of; and
- (d) to take such steps as are necessary to secure, so far as is reasonably practicable, that persons so supplied are provided with all such revisions of information provided to them by virtue of the preceding paragraph as are necessary by reason of its becoming known that anything gives rise to a serious risk to health or safety.

(1A) It shall be the duty of any person who designs, manufactures, imports or supplies any article of fairground equipment—

- (a) to ensure, so far as is reasonably practicable, that the article is so designed and constructed that it will be safe and without risks to health at all times when it is being used for or in connection with the entertainment of members of the public;
- (b) to carry out or arrange for the carrying out of such testing and examination as may be necessary for the performance of the duty imposed on him by the preceding paragraph;
- (c) to take such steps as are necessary to secure that persons supplied by that person with the article are provided with adequate information about the use for which the article is designed or has been tested and about any conditions necessary to ensure that it will be safe and without risks to health at all times

Changes to legislation: *Health and Safety at Work etc. Act 1974 is up to date with all changes known to be in force on or before 28 April 2021. There are changes that may be brought into force at a future date. Changes that have been made appear in the content and are referenced with annotations. (See end of Document for details) View outstanding changes*

- when it is being used for or in connection with the entertainment of members of the public; and
- (d) to take such steps as are necessary to secure, so far as is reasonably practicable, that persons so supplied are provided with all such revisions of information provided to them by virtue of the preceding paragraph as are necessary by reason of its becoming known that anything gives rise to a serious risk to health or safety.]
- (2) It shall be the duty of any person who undertakes the design or manufacture of any article for use at work [^{F15}or of any article of fairground equipment] to carry out or arrange for the carrying out of any necessary research with a view to the discovery and, so far as is reasonably practicable, the elimination or minimisation of any risks to health or safety to which the design or article may give rise.
- (3) It shall be the duty of any person who erects or installs any article for use at work in any premises where that article is to be used by persons at work [^{F16}or who erects or installs any article of fairground equipment] to ensure, so far as is reasonably practicable, that nothing about the way in which [^{F17}the article is erected or installed makes it unsafe or a risk to health at any such time as is mentioned in paragraph (a) of subsection (1) or, as the case may be, in paragraph (a) of subsection (1) or (1A) above.]
- [^{F18}(4) It shall be the duty of any person who manufactures, imports or supplies any substance—
- (a) to ensure, so far as is reasonably practicable, that the substance will be safe and without risks to health at all times when it is being used, handled, processed, stored or transported by a person at work or in premises to which section 4 above applies;
- (b) to carry out or arrange for the carrying out of such testing and examination as may be necessary for the performance of the duty imposed on him by the preceding paragraph
- (c) to take such steps as are necessary to secure that persons supplied by that person with the substance are provided with adequate information about any risks to health or safety to which the inherent properties of the substance may give rise, about the results of any relevant tests which have been carried out on or in connection with the substance and about any conditions necessary to ensure that the substance will be safe and without risks to health at all such times as are mentioned in paragraph (a) above and when the substance is being disposed of; and
- (d) to take such steps as are necessary to secure, so far as is reasonably practicable, that persons so supplied are provided with all such revisions of information provided to them by virtue of the preceding paragraph as are necessary by reason of its becoming known that anything gives rise to a serious risk to health or safety.]
- (5) It shall be the duty of any person who undertakes the manufacture of any [^{F19}substance] to carry out or arrange for the carrying out of any necessary research with a view to the discovery and, so far as is reasonable practicable, the elimination or minimisation of any risks to health or safety to which the substance may give rise [^{F19}at all such times as are mentioned in paragraph (a) of subsection (4) above].
- (6) Nothing in the preceding provisions of this section shall be taken to require a person to repeat any testing, examination or research which has been carried out otherwise than by him or at his instance, in so far as it is reasonable for him to rely on the results thereof for the purposes of those provisions.

Changes to legislation: *Health and Safety at Work etc. Act 1974 is up to date with all changes known to be in force on or before 28 April 2021. There are changes that may be brought into force at a future date. Changes that have been made appear in the content and are referenced with annotations. (See end of Document for details) View outstanding changes*

- (7) Any duty imposed on any person by any of the preceding provisions of this section shall extend only to things done in the course of a trade, business or other undertaking carried on by him (whether for profit or not) and to matters within his control.
- (8) Where a person designs, manufactures, imports or supplies an article [^{F20}for use at work or an article of fairground equipment and does so for or to another] on the basis of a written undertaking by that other to take specified steps sufficient to ensure, so far as is reasonably practicable, that the article will be safe and without risks to health [^{F21}at all such times as are mentioned in paragraph (a) of subsection (1) or, as the case may be, in paragraph (a) of subsection (1) or (1A) above], the undertaking shall have the effect of relieving the first-mentioned person from the duty imposed [^{F22}by virtue of that paragraph] to such extent as is reasonable having regard to the terms of the undertaking.
- [^{F23}(8A) Nothing in subsection (7) or (8) above shall relieve any person who imports any article or substance from any duty in respect of anything which—
- (a) in the case of an article designed outside the United Kingdom, was done by and in the course of any trade, profession or other undertaking carried on by, or was within the control of, the person who designed the article; or
 - (b) in the case of an article or substance manufactured outside the United Kingdom, was done by and in the course of any trade, profession or other undertaking carried on by, or was within the control of, the person who manufactured the article or substance.]
- (9) Where a person (“the ostensible supplier”) supplies any [^{F24}article or substance] to another (“the customer”) under a hire-purchase agreement, conditional sale agreement or credit-sale agreement, and the ostensible supplier—
- (a) carries on the business of financing the acquisition of goods by others by means of such agreements; and
 - (b) in the course of that business acquired his interest in the article or substance supplied to the customer as a means of financing its acquisition by the customer from a third person (“the effective supplier”),
- the effective supplier and not the ostensible supplier shall be treated for the purposes of this section as supplying the article or substance to the customer, and any duty imposed by the preceding provisions of this section on suppliers shall accordingly fall on the effective supplier and not on the ostensible supplier.
- [^{F25}(10) For the purposes of this section an absence of safety or a risk to health shall be disregarded in so far as the case in or in relation to which it would arise is shown to be one the occurrence of which could not reasonably be foreseen; and in determining whether any duty imposed by virtue of paragraph (a) of subsection (1), (1A) or (4) above has been performed regard shall be had to any relevant information or advice which has been provided to any person by the person by whom the article has been designed, manufactured, imported or supplied or, as the case may be, by the person by whom the substance has been manufactured, imported or supplied.]

Textual Amendments

F14 S. 6(1)(1A) substituted for s. 6(1) by [Consumer Protection Act 1987 \(c. 43, SIF 109:1\)](#), s. 36, [Sch. 3 para. 1\(2\)](#)

F15 Words inserted by [Consumer Protection Act 1987 \(c. 43, SIF 109:1\)](#), s. 36, [Sch. 3 para. 1\(4\)](#)

F16 Words inserted by [Consumer Protection Act 1987 \(c. 43, SIF 109:1\)](#), s. 36, [Sch. 3 para. 1\(4\)\(a\)](#)

Changes to legislation: *Health and Safety at Work etc. Act 1974 is up to date with all changes known to be in force on or before 28 April 2021. There are changes that may be brought into force at a future date. Changes that have been made appear in the content and are referenced with annotations. (See end of Document for details) View outstanding changes*

- F17** Words substituted by Consumer Protection Act 1987 (c. 43, SIF 109:1), s. 36, **Sch. 3 para. 1(4)(b)**
F18 S. 6(4) substituted by Consumer Protection Act 1987 (c. 43, SIF 109:1), s. 36, **Sch. 3 para. 1(5)**
F19 Word substituted and words beginning “at all such times...” inserted by Consumer Protection Act 1987 (c. 43, SIF 109:1), s. 36, **Sch. 3 para. 1(6)(a)(b)**
F20 Words substituted by Consumer Protection Act 1987 (c. 43, SIF 109:1), s. 36, **Sch. 3 para. 1(7)(a)**
F21 Words substituted by Consumer Protection Act 1987 (c. 43, SIF 109:1), s. 36, **Sch. 3 para. 1(7)(b)**
F22 Words substituted by Consumer Protection Act 1987 (c. 43, SIF 109:1), s. 36, **Sch. 3 para. 1(7)(c)**
F23 S. 6(8A) inserted by Consumer Protection Act 1987 (c. 43, SIF 109:1), s. 36, **Sch. 3 para. 1(8)**
F24 Words substituted by Consumer Protection Act 1987 (c. 43, SIF 109:1), s. 36, **Sch. 3 para. 1(9)**
F25 S. 6(10) substituted by Consumer Protection Act 1987 (c. 43, SIF 109:1), s. 36, **Sch. 3 para. 1(10)**

Modifications etc. (not altering text)

- C36** Ss. 1-59 applied by S.I. 2001/2127 art. 8A 8B (as inserted (E.W.S.) (6.4.2011) by The Health and Safety at Work etc. Act 1974 (Application outside Great Britain) (Variation) Order 2011 (S.I. 2011/745), arts. 1(1), 3(2))
C64 S. 6 modified by S.I. 1980/907, **reg. 3**
C65 Ss. 1–25, 26, 27, 28, 30, 33, 34–59, 80, 81 and 82 applied by S.I. 1989/840, **arts. 2–10**
C66 S. 6 modified by S.I. 1989/1790, **reg. 12**
C67 S. 6 modified (3.8.1992) by S.I. 1992/1524, **reg. 3**
C68 Ss. 1-59, 80-82 applied (11.7.2001) by S.I. 2001/2127, **arts. 4(1), 5(1)(2), 6(1), 7(1), 8(1), 10** (with art. 11) (as amended by S.I. 2009/1750, **art. 2(2)(4)**)
C69 Ss. 1-59, 80-82 applied (temp.) (5.8.2009) by The Health and Safety at Work etc. Act 1974 (Application outside Great Britain) Order 2001 (S.I. 2001/2127), arts. 8A, 8B (as inserted by S.I. 2009/1750, **art. 2(3)**)
C70 S. 6(1) modified *ibid.*, **reg. 4**
C71 S. 6(1)(1A) modified (3.8.1992) by S.I. 1992/1524, **reg. 4**
C72 S. 6(1) modified (1.1.2000) by S.I. 1999/3232, **reg. 31(1)**
C73 S. 6(1) modified (1.1.2018) by The Ionising Radiations Regulations 2017 (S.I. 2017/1075), regs. 1(2), **32(1)** (with regs. 2(5), 3, **Sch. 8**)
C74 S. 6(9) applied by S.I. 1989/2169, **reg. 3(4), Sch. 3 para. 3**
 S. 6(9) applied (21.2.2000) by S.I. 2000/128, **reg. 3, Sch. 2**

7 General duties of employees at work.

It shall be the duty of every employee while at work—

- (a) to take reasonable care for the health and safety of himself and of other persons who may be affected by his acts or omissions at work; and
- (b) as regards any duty or requirement imposed on his employer or any other person by or under any of the relevant statutory provisions, to co-operate with him so far as is necessary to enable that duty or requirement to be performed or complied with.

Modifications etc. (not altering text)

- C36** Ss. 1-59 applied by S.I. 2001/2127 art. 8A 8B (as inserted (E.W.S.) (6.4.2011) by The Health and Safety at Work etc. Act 1974 (Application outside Great Britain) (Variation) Order 2011 (S.I. 2011/745), arts. 1(1), 3(2))
C75 Ss. 1–25, 26, 27, 28, 30, 33, 34–59, 80, 81 and 82 applied by S.I. 1989/840, **arts. 2–10**
C76 S. 7 modified (15.11.2000) by S.I. 2000/2831, **reg. 5(1)**
 Ss. 1-59, 80-82 applied (11.7.2001) by S.I. 2001/2127, **arts. 4(1), 5(1)(2), 6(1), 7(1), 8(1), 10** (with art. 11) (as amended by S.I. 2009/1750, **art. 2(2)(4)**)

Changes to legislation: *Health and Safety at Work etc. Act 1974 is up to date with all changes known to be in force on or before 28 April 2021. There are changes that may be brought into force at a future date. Changes that have been made appear in the content and are referenced with annotations. (See end of Document for details) View outstanding changes*

- C77** Ss. 1-59, 80-82 applied (temp.) (5.8.2009) by The Health and Safety at Work etc. Act 1974 (Application outside Great Britain) Order 2001 (S.I. 2001/2127), arts. 8A, 8B (as inserted by S.I. 2009/1750, **art. 2(3)**)
- C78** S. 7 modified (E.W.S.) (1.10.2014) by The Genetically Modified Organisms (Contained Use) Regulations 2014 (S.I. 2014/1663), regs. 1, **4(2)** (with reg. 3(1)(2))

8 Duty not to interfere with or misuse things provided pursuant to certain provisions.

No person shall intentionally or recklessly interfere with or misuse anything provided in the interests of health, safety or welfare in pursuance of any of the relevant statutory provisions.

Modifications etc. (not altering text)

- C36** Ss. 1-59 applied by S.I. 2001/2127 art. 8A 8B (as inserted (E.W.S.) (6.4.2011) by The Health and Safety at Work etc. Act 1974 (Application outside Great Britain) (Variation) Order 2011 (S.I. 2011/745), arts. 1(1), **3(2)**)
- C79** Ss. 1–25, 26, 27, 28, 30, 33, 34–59, 80, 81 and 82 applied by S.I. 1989/840, **arts. 2–10**
- C80** Ss. 1-59, 80-82 applied (11.7.2001) by S.I. 2001/2127, **arts. 4(1), 5(1)(2), 6(1), 7(1), 8(1), 10** (with art. 11) (as amended by S.I. 2009/1750, **art. 2(2)(4)**)
- C81** Ss. 1-59, 80-82 applied (temp.) (5.8.2009) by The Health and Safety at Work etc. Act 1974 (Application outside Great Britain) Order 2001 (S.I. 2001/2127), arts. 8A, 8B (as inserted by S.I. 2009/1750, **art. 2(3)**)

9 Duty not to charge employees for things done or provided pursuant to certain specific requirements.

No employer shall levy or permit to be levied on any employee of his any charge in respect of anything done or provided in pursuance of any specific requirement of the relevant statutory provisions.

Modifications etc. (not altering text)

- C36** Ss. 1-59 applied by S.I. 2001/2127 art. 8A 8B (as inserted (E.W.S.) (6.4.2011) by The Health and Safety at Work etc. Act 1974 (Application outside Great Britain) (Variation) Order 2011 (S.I. 2011/745), arts. 1(1), **3(2)**)
- C82** Ss. 1–25, 26, 27, 28, 30, 33, 34–59, 80, 81 and 82 applied by S.I. 1989/840, **arts. 2–10**
- C83** Ss. 1-59, 80-82 applied (11.7.2001) by S.I. 2001/2127, **arts. 4(1), 5(1)(2), 6(1), 7(1), 8(1), 10** (with art. 11) (as amended by S.I. 2009/1750, **art. 2(2)(4)**)
- C84** Ss. 1-59, 80-82 applied (temp.) (5.8.2009) by The Health and Safety at Work etc. Act 1974 (Application outside Great Britain) Order 2001 (S.I. 2001/2127), arts. 8A, 8B (as inserted by S.I. 2009/1750, **art. 2(3)**)

The Health and Safety Commission and the Health and Safety Executive

[^{F26} 10 Establishment of the Executive.

- (1) There shall be a body corporate to be known as the Health and Safety Executive (in this Act referred to as “ the Executive ”).

Changes to legislation: *Health and Safety at Work etc. Act 1974 is up to date with all changes known to be in force on or before 28 April 2021. There are changes that may be brought into force at a future date. Changes that have been made appear in the content and are referenced with annotations. (See end of Document for details) View outstanding changes*

- (2) The provisions of Schedule 2 shall have effect with respect to the Executive.
- (3) The functions of the Executive and of its officers and servants shall be performed on behalf of the Crown.
- (4) For the purpose of any civil proceedings arising out of those functions—
 - (a) in England and Wales and Northern Ireland, the Crown Proceedings Act 1947 shall apply to the Executive as if it were a government department within the meaning of that Act, and
 - (b) in Scotland, the Crown Suits (Scotland) Act 1857 shall apply to the Executive as if it were a public department within the meaning of that Act.]

Textual Amendments

F26 S. 10 substituted (1.4.2008) by [The Legislative Reform \(Health and Safety Executive\) Order 2008 \(S.I. 2008/960\)](#), [art. 4](#) (with [art. 21](#), [Sch. 2](#))

Modifications etc. (not altering text)

C36 Ss. 1-59 applied by S.I. 2001/2127 art. 8A 8B (as inserted (E.W.S.) (6.4.2011) by [The Health and Safety at Work etc. Act 1974 \(Application outside Great Britain\) \(Variation\) Order 2011 \(S.I. 2011/745\)](#), [arts. 1\(1\)](#), [3\(2\)](#))

C85 Ss. 1–25, 26, 27, 28, 30, 33, 34–59, 80, 81 and 82 applied by S.I. 1989/840, [arts. 2–10](#)

C86 Ss. 1-59, 80-82 applied (11.7.2001) by S.I. 2001/2127, [arts. 4\(1\)](#), [5\(1\)\(2\)](#), [6\(1\)](#), [7\(1\)](#), [8\(1\)](#), [10](#) (with [art. 11](#)) (as amended by S.I. 2009/1750, [art. 2\(2\)\(4\)](#))

C87 Ss. 1-59, 80-82 applied (temp.) (5.8.2009) by [The Health and Safety at Work etc. Act 1974 \(Application outside Great Britain\) Order 2001 \(S.I. 2001/2127\)](#), [arts. 8A](#), [8B](#) (as inserted by S.I. 2009/1750, [art. 2\(3\)](#))

C88 S. 10(1) applied (with modifications) (17.8.2015) by [The Pyrotechnic Articles \(Safety\) Regulations 2015 \(S.I. 2015/1553\)](#), [reg. 1](#), [Sch. 8 paras. 1\(a\)](#), [2](#)

C89 S. 10(1) applied (with modifications) (8.12.2016) by [The Lifts Regulations 2016 \(S.I. 2016/1093\)](#), [reg. 1](#), [Sch. 8 paras. 1\(a\)](#), [2](#) (with [regs. 3-5](#))

[^{F27} 11 Functions of the Executive.

- (1) It shall be the general duty of the Executive to do such things and make such arrangements as it considers appropriate for the general purposes of this Part.
- (2) In connection with the general purposes of this Part, the Executive shall—
 - (a) assist and encourage persons concerned with matters relevant to those purposes to further those purposes;
 - (b) make such arrangements as it considers appropriate for the carrying out of research and the publication of the results of research and the provision of training and information, and encourage research and the provision of training and information by others;
 - (c) make such arrangements as it considers appropriate to secure that the following persons are provided with an information and advisory service on matters relevant to those purposes and are kept informed of and are adequately advised on such matters—
 - (i) government departments,
 - (ii) local authorities,
 - (iii) employers,

Changes to legislation: *Health and Safety at Work etc. Act 1974 is up to date with all changes known to be in force on or before 28 April 2021. There are changes that may be brought into force at a future date. Changes that have been made appear in the content and are referenced with annotations. (See end of Document for details) View outstanding changes*

- (iv) employees,
 - (v) organisations representing employers or employees, and
 - (vi) other persons concerned with matters relevant to the general purposes of this Part.
- (3) The Executive shall submit from time to time to the Secretary of State such proposals as the Executive considers appropriate for the making of regulations under any of the relevant statutory provisions.
- (4) In subsections (1) to (3)—
- (a) references to the general purposes of this Part do not include references to ^{F28}any of the transferred purposes]; and
 - (b) the reference to the making of regulations under the relevant statutory provisions does not include a reference so far as the regulations are made ^{F29}—
 - (i) for any of the transferred purposes, or
 - (ii) under section 43 and concern fees relating to nuclear site regulation.]
- [In subsection (4)—
- ^{F30}(4A) (a) “ the transferred purposes ” means—
- (i) the railway safety purposes;
 - (ii) the nuclear safety purposes;
 - (iii) the nuclear security purposes;
 - (iv) the nuclear safeguards purposes;
 - (v) the radioactive material transport purposes;
- (b) “ fees relating to nuclear site regulation ” means fees payable for or in connection with the performance of a function by or on behalf of—
- (i) the Office for Nuclear Regulation, or
 - (ii) any inspector appointed by the Office for Nuclear Regulation.
- [Subsection (4)(b)(i) does not apply in relation to the making of regulations under ^{F31}(4AA) section 3(2) for the railway safety purposes (and, accordingly, the Executive shall submit under subsection (3) such proposals as the Executive considers appropriate for the making of regulations under section 3(2) for those purposes).]
- (4B) The Executive may submit to the Secretary of State any proposal submitted to it by the Office for Nuclear Regulation under section 81 of the Energy Act 2013 (proposals about orders and regulations).]
- (5) It shall be the duty of the Executive—
- (a) to submit to the Secretary of State from time to time particulars of what it proposes to do for the purpose of performing of its functions;
 - (b) to ensure that its activities are in accordance with proposals approved by the Secretary of State; and
 - (c) to give effect to any directions given to it by the Secretary of State.
- (6) The Executive shall provide a Minister of the Crown on request—
- (a) with information about its activities in connection with any matter with which the Minister is concerned; and
 - (b) with advice on any matter with which he is concerned, where relevant expert advice is obtainable from any of the officers or servants of the Executive, but which is not relevant to the general purposes of this Part.]

Changes to legislation: *Health and Safety at Work etc. Act 1974 is up to date with all changes known to be in force on or before 28 April 2021. There are changes that may be brought into force at a future date. Changes that have been made appear in the content and are referenced with annotations. (See end of Document for details) View outstanding changes*

Textual Amendments

- F27** Ss. 11-13 substituted (1.4.2008) by [The Legislative Reform \(Health and Safety Executive\) Order 2008 \(S.I. 2008/960\)](#), [art. 5](#) (with [art. 21](#), [Sch. 2](#))
- F28** Words in s. 11(4)(a) substituted (1.4.2014) by [Energy Act 2013 \(c. 32\)](#), s. 156(1), [Sch. 12 para. 2\(2\)\(a\)](#); [S.I. 2014/251](#), [art. 4](#)
- F29** Words in s. 11(4)(b) substituted (1.4.2014) by [Energy Act 2013 \(c. 32\)](#), s. 156(1), [Sch. 12 para. 2\(2\)\(b\)](#); [S.I. 2014/251](#), [art. 4](#)
- F30** S. 11(4A)(4B) inserted (1.4.2014) by [Energy Act 2013 \(c. 32\)](#), s. 156(1), [Sch. 12 para. 2\(3\)](#); [S.I. 2014/251](#), [art. 4](#)
- F31** S. 11(4AA) inserted (26.3.2015 for specified purposes, 1.10.2015 in so far as not already in force) by [Deregulation Act 2015 \(c. 20\)](#), [ss. 1\(4\)](#), [115\(2\)\(a\)](#) (with s. 1(6)); [S.I. 2015/1732](#), [art. 2\(a\)](#)

Modifications etc. (not altering text)

- C36** Ss. 1-59 applied by [S.I. 2001/2127 art. 8A 8B](#) (as inserted (E.W.S.) (6.4.2011) by [The Health and Safety at Work etc. Act 1974 \(Application outside Great Britain\) \(Variation\) Order 2011 \(S.I. 2011/745\)](#), [arts. 1\(1\)](#), [3\(2\)](#))
- C90** Ss. 1-25, 26, 27, 28, 30, 33, 34-59, 80, 81 and 82 applied by [S.I. 1989/840](#), [arts. 2-10](#)
- C91** Ss. 1-59, 80-82 applied (11.7.2001) by [S.I. 2001/2127](#), [arts. 4\(1\)](#), [5\(1\)\(2\)](#), [6\(1\)](#), [7\(1\)](#), [8\(1\)](#), [10](#) (with [art. 11](#)) (as amended by [S.I. 2009/1750](#), [art. 2\(2\)\(4\)](#))
- C92** Ss. 1-59, 80-82 applied (temp.) (5.8.2009) by [The Health and Safety at Work etc. Act 1974 \(Application outside Great Britain\) Order 2001 \(S.I. 2001/2127\)](#), [arts. 8A](#), [8B](#) (as inserted by [S.I. 2009/1750](#), [art. 2\(3\)](#))

[^{F32} 12 Control of the Executive by the Secretary of State.

- (1) The Secretary of State may approve any proposals submitted to him under section 11(5)(a) with or without modifications.
- (2) The Secretary of State may at any time give to the Executive—
 - (a) such directions as he thinks fit with respect to its functions, or
 - (b) such directions as appear to him requisite or expedient to give in the interests of the safety of the State.
- (3) The Secretary of State may not under subsection (2) give any directions with regard to the enforcement of the relevant statutory provisions in any particular case.
- (4) The reference to directions in subsection (2)(a)—
 - (a) includes directions modifying the Executive's functions, but
 - (b) does not include directions conferring functions on the Executive other than any functions of which it was deprived by previous directions given under subsection (2)(a).]

Textual Amendments

- F32** Ss. 11-13 substituted (1.4.2008) by [The Legislative Reform \(Health and Safety Executive\) Order 2008 \(S.I. 2008/960\)](#), [art. 5](#) (with [art. 21](#), [Sch. 2](#))

Changes to legislation: *Health and Safety at Work etc. Act 1974 is up to date with all changes known to be in force on or before 28 April 2021. There are changes that may be brought into force at a future date. Changes that have been made appear in the content and are referenced with annotations. (See end of Document for details) View outstanding changes*

Modifications etc. (not altering text)

- C36** Ss. 1-59 applied by S.I. 2001/2127 art. 8A 8B (as inserted (E.W.S.) (6.4.2011) by [The Health and Safety at Work etc. Act 1974 \(Application outside Great Britain\) \(Variation\) Order 2011 \(S.I. 2011/745\)](#), arts. 1(1), 3(2))
- C93** Ss. 1–25, 26, 27, 28, 30, 33, 34–59, 80, 81 and 82 applied by S.I. 1989/840, arts. 2–10
- C94** Ss. 1-59, 80-82 applied (11.7.2001) by S.I. 2001/2127, arts. 4(1), 5(1)(2), 6(1), 7(1), 8(1), 10 (with art. 11) (as amended by S.I. 2009/1750, art. 2(2)(4))
- C95** Ss. 1-59, 80-82 applied (temp.) (5.8.2009) by [The Health and Safety at Work etc. Act 1974 \(Application outside Great Britain\) Order 2001 \(S.I. 2001/2127\)](#), arts. 8A, 8B (as inserted by S.I. 2009/1750, art. 2(3))

[^{F33} 13 Powers of the Executive.

- (1) Subject to subsection (2), the Executive shall have power to do anything which is calculated to facilitate, or is conducive or incidental to, the performance of its functions, including a function conferred on it under this subsection.
- (2) The power in subsection (1) shall not include the power to borrow money.
- (3) The Executive may make agreements with a government department or other person for that department or person to perform any of its functions, with or without payment.
- (4) Subject to subsections (5) and (6), the Executive may make agreements with a Minister of the Crown, with a government department or with a public authority to perform functions exercisable by that Minister, department or authority, with or without payment.
- (5) The functions referred to in subsection (4)—
 - (a) in the case of a Minister of the Crown, include functions not conferred by an enactment;
 - (b) shall be functions which the Secretary of State considers can be appropriately performed by the Executive; and
 - (c) do not include any power to make regulations or other instruments of a legislative character.
- (6) The Executive may provide services or facilities, with or without payment, otherwise than for the general purposes of this Part, to a government department or public authority in connection with the exercise of that department's or authority's functions.

[The reference in subsection (6) to the general purposes of this Part does not include ^{F34}(6A) a reference to any of the following—

- (a) the nuclear safety purposes;
- (b) the nuclear security purposes;
- (c) the nuclear safeguards purposes;
- (d) the radioactive material transport purposes.]
- (7) The Executive may appoint persons or committees of persons to provide it with advice in connection with any of its functions and, without prejudice to subsection (8), it may remunerate these persons.
- (8) The Executive may, in connection with the performance of its functions, pay to any person—
 - (a) travelling and subsistence allowances, and

Changes to legislation: *Health and Safety at Work etc. Act 1974 is up to date with all changes known to be in force on or before 28 April 2021. There are changes that may be brought into force at a future date. Changes that have been made appear in the content and are referenced with annotations. (See end of Document for details) View outstanding changes*

- (b) compensation for loss of remunerative time.
- (9) Any amounts paid under subsections (7) and (8) shall be such as may be determined by the Secretary of State, with the approval of the Minister for the Civil Service.
- (10) The Executive may—
 - (a) carry out, arrange for, or make payments for the carrying out of, research into any matter connected with its functions, and
 - (b) disseminate or arrange for or make payments for the dissemination of information derived from this research.
- (11) The Executive may include, in any arrangements made for the provision of services or facilities under subsection (6), provision for the making of payments to the Executive, or any person acting on its behalf, by other parties to the arrangements and by persons using those services or facilities.]

Textual Amendments

- F33** Ss. 11-13 substituted (1.4.2008) by [The Legislative Reform \(Health and Safety Executive\) Order 2008 \(S.I. 2008/960\)](#), [art. 5](#) (with [art. 21](#), [Sch. 2](#))
- F34** S. 13(6A) inserted (1.4.2014) by [Energy Act 2013 \(c. 32\)](#), s. 156(1), [Sch. 12 para. 3](#); S.I. 2014/251, [art. 4](#)

Modifications etc. (not altering text)

- C36** Ss. 1-59 applied by S.I. 2001/2127 art. 8A 8B (as inserted (E.W.S.) (6.4.2011) by [The Health and Safety at Work etc. Act 1974 \(Application outside Great Britain\) \(Variation\) Order 2011 \(S.I. 2011/745\)](#), [arts. 1\(1\)](#), [3\(2\)](#))
- C96** Ss. 1–25, 26, 27, 28, 30, 33, 34–59, 80, 81 and 82 applied by S.I. 1989/840, [arts. 2–10](#)
- C97** Ss. 1-59, 80-82 applied (11.7.2001) by S.I. 2001/2127, [arts. 4\(1\)](#), [5\(1\)\(2\)](#), [6\(1\)](#), [7\(1\)](#), [8\(1\)](#), [10](#) (with [art. 11](#)) (as amended by S.I. 2009/1750, [art. 2\(2\)\(4\)](#))
- C98** S. 13(2) restricted (E.W.S.) (8.11.2006) by [2006 c. 49](#), [s. 51\(2\)](#) (with [s. 61\(9\)\(a\)](#))
- C99** Ss. 1-59, 80-82 applied (temp.) (5.8.2009) by [The Health and Safety at Work etc. Act 1974 \(Application outside Great Britain\) Order 2001 \(S.I. 2001/2127\)](#), [arts. 8A](#), [8B](#) (as inserted by S.I. 2009/1750, [art. 2\(3\)](#))

14 Power of the Commission to direct investigations and inquiries. E+W+S

- (1) This section applies to the following matters, that is to say any accident, occurrence, situation or other matter whatsoever which [^{F35}the Executive] thinks it necessary or expedient to investigate for any of the general purposes of this Part or with a view to the making of regulations for those purposes; and for the purposes of this subsection [^{F36}(a) those general purposes shall be treated as not including the railway safety purposes [^{F37}or the ONR's purposes]; but
- (b) it is otherwise] immaterial whether the Executive is or is not responsible for securing the enforcement of such (if any) of the relevant statutory provisions as relate to the matter in question.
- [^{F38}(2) The Executive may at any time—
- (a) investigate and make a special report on any matter to which this section applies; or
 - (b) authorise another person to investigate and make a special report into any such matter.

Changes to legislation: *Health and Safety at Work etc. Act 1974 is up to date with all changes known to be in force on or before 28 April 2021. There are changes that may be brought into force at a future date. Changes that have been made appear in the content and are referenced with annotations. (See end of Document for details) View outstanding changes*

(2A) The Executive may at any time, with the consent of the Secretary of State, direct an inquiry to be held into any matter to which this section applies.]

(3) Any inquiry held by virtue of [F39 subsection (2A)] above shall be held in accordance with regulations made for the purposes of this subsection by the Secretary of State, and shall be held in public except where or to the extent that the regulations provide otherwise.

(4) Regulations made for the purposes of subsection (3) above may in particular include provision—

- (a) conferring on the person holding any such inquiry, and any person assisting him in the inquiry, powers of entry and inspection;
- (b) conferring on any such person powers of summoning witnesses to give evidence or produce documents and power to take evidence on oath and administer oaths or require the making of declarations;
- (c) requiring any such inquiry to be held otherwise than in public where or to the extent that a Minister of the Crown so directs.

[F40(4A) Provision that may be made by virtue of subsection (4)(a) includes, in particular, provision conferring functions on the Office for Nuclear Regulation in relation to powers of entry and inspection in relation to any premises for which it is an enforcing authority.]

[F41(5) In the case of a special report made by virtue of subsection (2), or a report made by the person holding an inquiry by virtue of subsection (2A), the Executive may cause the report, or so much of it as the Executive thinks fit, to be made public at such time and in such manner as it thinks fit.]

(6) [F42The Executive]—

- (a) in the case of an investigation and special report made by virtue of [F43 subsection (2)] above (otherwise than by an officer or servant of the Executive), may pay to the person making it such remuneration and expenses as the Secretary of State may, with the approval of the Minister for the Civil Service, determine;
- (b) in the case of an inquiry held by virtue of [F44 subsection (2A)] above, may pay to the person holding it and to any assessor appointed to assist him such remuneration and expenses, and to persons attending the inquiry as witnesses such expenses, as the Secretary of State may, with the like approval, determine; and
- (c) may, to such extent as the Secretary of State may determine, defray the other costs, if any, of any such investigation and special report or inquiry.

F45F46(7)

Extent Information

E3 This version of this provision extends to England and Wales and Scotland only; a separate version has been created for Northern Ireland only

Textual Amendments

F35 Words in s. 14(1) substituted (1.4.2008) by [The Legislative Reform \(Health and Safety Executive\) Order 2008 \(S.I. 2008/960\)](#), [art. 6\(2\)](#) (with [art. 21](#), [Sch. 2](#))

Changes to legislation: *Health and Safety at Work etc. Act 1974 is up to date with all changes known to be in force on or before 28 April 2021. There are changes that may be brought into force at a future date. Changes that have been made appear in the content and are referenced with annotations. (See end of Document for details) View outstanding changes*

- F36** Words in s. 14(1) substituted (E.W.S.) (1.4.2006) by Railways Act 2005 (c. 14), ss. 2, 60, **Sch. 3 para. 4(5)** (with paras. 5, 6); S.I. 2006/266, **art. 2**
- F37** Words in s. 14(1)(a) inserted (1.4.2014) by Energy Act 2013 (c. 32), s. 156(1), **Sch. 12 para. 4(2)**; S.I. 2014/251, art. 4
- F38** S. 14(2)(2A) substituted (1.4.2008) for s. 14(2) by The Legislative Reform (Health and Safety Executive) Order 2008 (S.I. 2008/960), **art. 6(3)** (with art. 21, Sch. 2)
- F39** Words in s. 14(3) substituted (1.4.2008) by The Legislative Reform (Health and Safety Executive) Order 2008 (S.I. 2008/960), **art. 6(4)** (with art. 21, Sch. 2)
- F40** S. 14(4A) inserted (1.4.2014) by Energy Act 2013 (c. 32), s. 156(1), **Sch. 12 para. 4(3)**; S.I. 2014/251, art. 4
- F41** S. 14(5) substituted (1.4.2008) by The Legislative Reform (Health and Safety Executive) Order 2008 (S.I. 2008/960), **art. 6(5)** (with art. 21, Sch. 2)
- F42** Words in s. 14(6) substituted (1.4.2008) by The Legislative Reform (Health and Safety Executive) Order 2008 (S.I. 2008/960), **art. 6(6)(a)** (with art. 21, Sch. 2)
- F43** Words in s. 14(6)(a) substituted (1.4.2008) by The Legislative Reform (Health and Safety Executive) Order 2008 (S.I. 2008/960), **art. 6(6)(b)** (with art. 21, Sch. 2)
- F44** Words in s. 14(6)(b) substituted (1.4.2008) by The Legislative Reform (Health and Safety Executive) Order 2008 (S.I. 2008/960), **art. 6(6)(c)** (with art. 21, Sch. 2)
- F45** S. 14(7) repealed (S.) (15.6.2017) by Inquiries into Fatal Accidents and Sudden Deaths etc. (Scotland) Act 2016 (asp 2), s. 42(2), **sch. 2 para. 2(2)**; S.S.I. 2017/155, reg. 2 (with regs. 4(2), 5)
- F46** S. 14(7) repealed (E.W.N.I.) (15.6.2017) by The Inquiries into Fatal Accidents and Sudden Deaths etc. (Scotland) Act 2016 (Consequential Provisions and Modifications) Order 2016 (S.I. 2016/1142), art. 1(2), **Sch. para. 3(2)** (with art. 7(2)); S.S.I. 2017/155, reg. 2

Modifications etc. (not altering text)

- C36** Ss. 1-59 applied by S.I. 2001/2127 art. 8A 8B (as inserted (E.W.S.) (6.4.2011) by The Health and Safety at Work etc. Act 1974 (Application outside Great Britain) (Variation) Order 2011 (S.I. 2011/745), arts. 1(1), **3(2)**)
- C100** Ss. 1-25, 26, 27, 28, 30, 33, 34-59, 80, 81 and 82 applied by S.I. 1989/840, **arts. 2-10**
- C101** Ss. 1-59, 80-82 applied (11.7.2001) by S.I. 2001/2127, **arts. 4(1), 5(1)(2), 6(1), 7(1), 8(1), 10** (with art. 11) (as amended by S.I. 2009/1750, **art. 2(2)(4)**)
- C102** S. 14 continued (1.4.2008) by The Legislative Reform (Health and Safety Executive) Order 2008 (S.I. 2008/960), art. 21, **Sch. 2 para. 6(2)**
- C103** Ss. 1-59, 80-82 applied (temp.) (5.8.2009) by The Health and Safety at Work etc. Act 1974 (Application outside Great Britain) Order 2001 (S.I. 2001/2127), arts. 8A, 8B (as inserted by S.I. 2009/1750, **art. 2(3)**)

14 Power of the Commission to direct investigations and inquiries. **N.I.**

(1) This section applies to the following matters, that is to say any accident, occurrence, situation or other matter whatsoever which [^{F35}the Executive] thinks it necessary or expedient to investigate for any of the general purposes of this Part or with a view to the making of regulations for those purposes; and for the purposes of this subsection it is immaterial whether the Executive is or is not responsible for securing the enforcement of such (if any) of the relevant statutory provisions as relate to the matter in question.

[^{F38}(2) The Executive may at any time—

- (a) investigate and make a special report on any matter to which this section applies; or
- (b) authorise another person to investigate and make a special report into any such matter.

Changes to legislation: *Health and Safety at Work etc. Act 1974 is up to date with all changes known to be in force on or before 28 April 2021. There are changes that may be brought into force at a future date. Changes that have been made appear in the content and are referenced with annotations. (See end of Document for details) View outstanding changes*

(2A) The Executive may at any time, with the consent of the Secretary of State, direct an inquiry to be held into any matter to which this section applies.]

(3) Any inquiry held by virtue of [F39 subsection (2A)] above shall be held in accordance with regulations made for the purposes of this subsection by the Secretary of State, and shall be held in public except where or to the extent that the regulations provide otherwise.

(4) Regulations made for the purposes of subsection (3) above may in particular include provision—

- (a) conferring on the person holding any such inquiry, and any person assisting him in the inquiry, powers of entry and inspection;
- (b) conferring on any such person powers of summoning witnesses to give evidence or produce documents and power to take evidence on oath and administer oaths or require the making of declarations;
- (c) requiring any such inquiry to be held otherwise than in public where or to the extent that a Minister of the Crown so directs.

[F40(4A) Provision that may be made by virtue of subsection (4)(a) includes, in particular, provision conferring functions on the Office for Nuclear Regulation in relation to powers of entry and inspection in relation to any premises for which it is an enforcing authority.]

[F41(5) In the case of a special report made by virtue of subsection (2), or a report made by the person holding an inquiry by virtue of subsection (2A), the Executive may cause the report, or so much of it as the Executive thinks fit, to be made public at such time and in such manner as it thinks fit.]

(6) [F42The Executive]—

- (a) in the case of an investigation and special report made by virtue of [F43 subsection (2)] above (otherwise than by an officer or servant of the Executive), may pay to the person making it such remuneration and expenses as the Secretary of State may, with the approval of the Minister for the Civil Service, determine;
- (b) in the case of an inquiry held by virtue of [F44 subsection (2A)] above, may pay to the person holding it and to any assessor appointed to assist him such remuneration and expenses, and to persons attending the inquiry as witnesses such expenses, as the Secretary of State may, with the like approval, determine; and
- (c) may, to such extent as the Secretary of State may determine, defray the other costs, if any, of any such investigation and special report or inquiry.

F46(7)

Extent Information

E10 This version of this provision extends to Northern Ireland only; a separate version has been created for England and Wales and Scotland only

Textual Amendments

F35 Words in s. 14(1) substituted (1.4.2008) by [The Legislative Reform \(Health and Safety Executive\) Order 2008 \(S.I. 2008/960\)](#), [art. 6\(2\)](#) (with [art. 21](#), [Sch. 2](#))

Changes to legislation: *Health and Safety at Work etc. Act 1974 is up to date with all changes known to be in force on or before 28 April 2021. There are changes that may be brought into force at a future date. Changes that have been made appear in the content and are referenced with annotations. (See end of Document for details) View outstanding changes*

- F38** S. 14(2)(2A) substituted (1.4.2008) for s. 14(2) by [The Legislative Reform \(Health and Safety Executive\) Order 2008 \(S.I. 2008/960\)](#), [art. 6\(3\)](#) (with art. 21, Sch. 2)
- F39** Words in s. 14(3) substituted (1.4.2008) by [The Legislative Reform \(Health and Safety Executive\) Order 2008 \(S.I. 2008/960\)](#), [art. 6\(4\)](#) (with art. 21, Sch. 2)
- F40** S. 14(4A) inserted (1.4.2014) by [Energy Act 2013 \(c. 32\)](#), s. 156(1), [Sch. 12 para. 4\(3\)](#); S.I. 2014/251, art. 4
- F41** S. 14(5) substituted (1.4.2008) by [The Legislative Reform \(Health and Safety Executive\) Order 2008 \(S.I. 2008/960\)](#), [art. 6\(5\)](#) (with art. 21, Sch. 2)
- F42** Words in s. 14(6) substituted (1.4.2008) by [The Legislative Reform \(Health and Safety Executive\) Order 2008 \(S.I. 2008/960\)](#), [art. 6\(6\)\(a\)](#) (with art. 21, Sch. 2)
- F43** Words in s. 14(6)(a) substituted (1.4.2008) by [The Legislative Reform \(Health and Safety Executive\) Order 2008 \(S.I. 2008/960\)](#), [art. 6\(6\)\(b\)](#) (with art. 21, Sch. 2)
- F44** Words in s. 14(6)(b) substituted (1.4.2008) by [The Legislative Reform \(Health and Safety Executive\) Order 2008 \(S.I. 2008/960\)](#), [art. 6\(6\)\(c\)](#) (with art. 21, Sch. 2)
- F46** S. 14(7) repealed (E.W.N.I.) (15.6.2017) by [The Inquiries into Fatal Accidents and Sudden Deaths etc. \(Scotland\) Act 2016 \(Consequential Provisions and Modifications\) Order 2016 \(S.I. 2016/1142\)](#), art. 1(2), [Sch. para. 3\(2\)](#) (with art. 7(2)); S.S.I. 2017/155, reg. 2

Modifications etc. (not altering text)

- C100** Ss. 1–25, 26, 27, 28, 30, 33, 34–59, 80, 81 and 82 applied by [S.I. 1989/840](#), [arts. 2–10](#)
- C101** Ss. 1–59, 80–82 applied (11.7.2001) by [S.I. 2001/2127](#), [arts. 4\(1\)](#), 5(1)(2), 6(1), 7(1), 8(1), 10 (with art. 11) (as amended by [S.I. 2009/1750](#), [art. 2\(2\)\(4\)](#))
- C102** S. 14 continued (1.4.2008) by [The Legislative Reform \(Health and Safety Executive\) Order 2008 \(S.I. 2008/960\)](#), art. 21, [Sch. 2 para. 6\(2\)](#)
- C103** Ss. 1–59, 80–82 applied (temp.) (5.8.2009) by [The Health and Safety at Work etc. Act 1974 \(Application outside Great Britain\) Order 2001 \(S.I. 2001/2127\)](#), arts. 8A, 8B (as inserted by [S.I. 2009/1750](#), [art. 2\(3\)](#))

Health and safety regulations and approved codes of practice

15 Health and safety regulations.

[^{F47}(1) Subject to the provisions of section 50, the Secretary of State ^{F48} . . . shall have power to make regulations under this section for any of the general purposes of this Part (and regulations so made are in this Part referred to as “ health and safety regulations ”).]

[^{F49}(1A) In subsection (1), the reference to the general purposes of this Part does not include a reference to any of the following—

- (a) the nuclear safety purposes;
- (b) the nuclear security purposes;
- (c) the nuclear safeguards purposes;
- (d) the radioactive material transport purposes.

(1B) Subsection (1A) does not preclude health and safety regulations from including provision merely because the provision could be made for any of the purposes mentioned in paragraphs (a) to (d) of that subsection.]

(2) Without prejudice to the generality of [^{F50}subsection (1)], health and safety regulations may for any of the general purposes of this Part make provision for any of the purposes mentioned in Schedule 3.

(3) Health and safety regulations—

Changes to legislation: *Health and Safety at Work etc. Act 1974 is up to date with all changes known to be in force on or before 28 April 2021. There are changes that may be brought into force at a future date. Changes that have been made appear in the content and are referenced with annotations. (See end of Document for details) View outstanding changes*

- (a) may repeal or modify any of the existing statutory provisions;
- (b) may exclude or modify in relation to any specified class of case any of the provisions of sections 2 to 9 or any of the existing statutory provisions;
- (c) may ^{F51}, subject to subsection (3A),]make a specified authority or class of authorities responsible, to such extent as may be specified, for the enforcement of any of the relevant statutory provisions.

^{F52}(3A) Nothing in this section is to be taken to permit health and safety regulations to make provision about responsibility for the enforcement of any of the relevant statutory provisions as they apply in relation to any GB nuclear site.

(3B) Subsection (3A) does not prevent health and safety regulations providing for the ^{F53}Office of Rail and Road] to be responsible for the enforcement, in relation to GB nuclear sites, of any of the relevant statutory provisions that are made for the railway safety purposes.

(3C) In subsections (3A) and (3B), “ GB nuclear site ” has the same meaning as in section 68 of the Energy Act 2013 (nuclear safety purposes).]

(4) Health and safety regulations—

- (a) may impose requirements by reference to the approval of ^{F54}the Executive] or any other specified body or person;
- (b) may provide for references in the regulations to any specified document to operate as reference to that document as revised or re-issued from time to time.

(5) Health and safety regulations—

- (a) may provide (either unconditionally or subject to conditions, and with or without limit of time) for exemptions from any requirement or prohibition imposed by or under any of the relevant statutory provisions;
- (b) may enable exemptions from any requirement or prohibition imposed by or under any of the relevant statutory provisions to be granted (either unconditionally or subject to conditions, and with or without limit of time) by any specified person or by any person authorised in that behalf by a specified authority.

(6) Health and safety regulations—

- (a) may specify the persons or classes of persons who, in the event of a contravention of a requirement or prohibition imposed by or under the regulations, are to be guilty of an offence, whether in addition to or to the exclusion of other persons or classes of persons;
- (b) may provide for any specified defence to be available in proceedings for any offence under the relevant statutory provisions either generally or in specified circumstances;
- (c) may exclude proceedings on indictment in relation to offences consisting of a contravention of a requirement or prohibition imposed by or under any of the existing statutory provisions, sections 2 to 9 or health and safety regulations;
- (d) may restrict the punishments ^{F55}(other than the maximum fine on conviction on indictment)] which can be imposed in respect of any such offence as is mentioned in paragraph (c) above.

^{F56}(e) ^{F57}]

(7) Without prejudice to section 35, health and safety regulations may make provision for enabling offences under any of the relevant statutory provisions to be treated as having

Changes to legislation: *Health and Safety at Work etc. Act 1974 is up to date with all changes known to be in force on or before 28 April 2021. There are changes that may be brought into force at a future date. Changes that have been made appear in the content and are referenced with annotations. (See end of Document for details) View outstanding changes*

been committed at any specified place for the purpose of bringing any such offence within the field of responsibility of any enforcing authority or conferring jurisdiction on any court to entertain proceedings for any such offence.

- (8) Health and safety regulations may take the form of regulations applying to particular circumstances only or to a particular case only (for example, regulations applying to particular premises only).
- (9) If an Order in Council is made under section 84(3) providing that this section shall apply to or in relation to persons, premises or work outside Great Britain then, notwithstanding the Order, health and safety regulations shall not apply to or in relation to aircraft in flight, vessels, hovercraft or offshore installations outside Great Britain or persons at work outside Great Britain in connection with submarine cables or submarine pipelines except in so far as the regulations expressly so provide.
- (10) In this section “specified” means specified in health and safety regulations.

Textual Amendments

- F47** S. 15(1) substituted by [Employment Protection Act 1975 \(c. 71\)](#), **Sch. 15 para. 6**
- F48** Words in S. 15(1) repealed (27.3.2002) by [S.I. 2002/794](#), art. 5(2), **Sch. 2**(with art. 6)
- F49** S. 15(1A)(1B) inserted (1.4.2014) by [Energy Act 2013 \(c. 32\)](#), s. 156(1), **Sch. 12 para. 5(2)**; [S.I. 2014/251](#), art. 4
- F50** Words in s. 15(2) substituted (1.4.2014) by [Energy Act 2013 \(c. 32\)](#), s. 156(1), **Sch. 12 para. 5(3)**; [S.I. 2014/251](#), art. 4
- F51** Words in s. 15(3)(c) inserted (1.4.2014) by [Energy Act 2013 \(c. 32\)](#), s. 156(1), **Sch. 12 para. 5(4)**; [S.I. 2014/251](#), art. 4
- F52** S. 15(3A)-(3C) inserted (1.4.2014) by [Energy Act 2013 \(c. 32\)](#), s. 156(1), **Sch. 12 para. 5(5)**; [S.I. 2014/251](#), art. 4
- F53** Words in s. 15(3B) substituted (E.W.S.) (16.10.2015) by [The Office of Rail Regulation \(Change of Name\) Regulations 2015 \(S.I. 2015/1682\)](#), reg. 1(2), **Sch. para. 4(c)(i)**
- F54** Words in s. 15(4)(a) substituted (1.4.2008) by [The Legislative Reform \(Health and Safety Executive\) Order 2008 \(S.I. 2008/960\)](#), **art. 7** (with art. 21, Sch. 2)
- F55** Words inserted by [Criminal Law Act 1977 \(c. 45\)](#), **Sch. 12**
- F56** S. 15(6)(e) inserted (E.W.S.) (6.3.1992) by [Offshore Safety Act 1992 \(c. 15\)](#), **s. 4(1)(6)**.
- F57** S. 15(6)(e) repealed (16.1.2009) by [Health and Safety \(Offences\) Act 2008 \(c. 20\)](#), ss. 2, 3(2), **Sch. 3 para. 2(1)**, **Sch. 4** (with s. 3(3))

Modifications etc. (not altering text)

- C36** Ss. 1-59 applied by [S.I. 2001/2127](#) art. 8A 8B (as inserted (E.W.S.) (6.4.2011) by [The Health and Safety at Work etc. Act 1974 \(Application outside Great Britain\) \(Variation\) Order 2011 \(S.I. 2011/745\)](#), arts. 1(1), **3(2)**)
- C104** Ss. 1–25, 26, 27, 28, 30, 33, 34–59, 80, 81 and 82 applied by [S.I. 1989/840](#), **arts. 2–10**
- C105** S. 15 extended (E.W.S.) (6.3.1992) by [Offshore Safety Act 1992 \(c. 15\)](#), **ss. 1(2)**, 2(2).
 S. 15 extended (31.10.1994) by [1994 c. 21](#), **s. 55(1)(3)** (with s. 40(7)); [S.I. 1994/2553](#), **art. 2**
 S. 15 applied (19.10.1994) by [S.I. 1994/2479](#), **reg. 3**
 S. 15 applied (31.1.1995) by [S.I. 1994/3247](#), **reg. 16(1)(a)**
- C106** Ss. 1-59, 80-82 applied (11.7.2001) by [S.I. 2001/2127](#), **arts. 4(1)**, 5(1)(2), 6(1), 7(1), 8(1), 10 (with art. 11) (as amended by [S.I. 2009/1750](#), **art. 2(2)(4)**)
- C107** S. 15 modified (20.9.2001) by [S.I. 2001/2975](#), **reg. 19**
- C108** Ss. 1-59, 80-82 applied (temp.) (5.8.2009) by [The Health and Safety at Work etc. Act 1974 \(Application outside Great Britain\) Order 2001 \(S.I. 2001/2127\)](#), arts. 8A, 8B (as inserted by [S.I. 2009/1750](#), **art. 2(3)**)

Changes to legislation: Health and Safety at Work etc. Act 1974 is up to date with all changes known to be in force on or before 28 April 2021. There are changes that may be brought into force at a future date. Changes that have been made appear in the content and are referenced with annotations. (See end of Document for details) View outstanding changes

C109 S. 15(1) extended (E.W.S) (2.2.1994) by 1993 c. 43, ss. 117(3)(6), 150(1)(e); S.I. 1994/202, art. 2

C110 S. 15(7): power to apply conferred (E.W.S.) (28.8.1995) by 1995 c. 15, ss. 2(4)(a), 5 (with s. 3(5))

16 Approval of codes of practice by [^{F58}the Executive]. **E+W+S**

- (1) For the purpose of providing practical guidance with respect to the requirements of any provision of [^{F59}any of the enactments or instruments mentioned in subsection (1A) below], [^{F58}the Executive] may, subject to the following subsection ^{F60} . . .
- (a) approve and issue such codes of practice (whether prepared by it or not) as in its opinion are suitable for that purpose;
 - (b) approve such codes of practice issued or proposed to be issued otherwise than by [^{F58}the Executive] as in its opinion are suitable for that purpose.

[^{F61}(1A) Those enactments and instruments are—

- (a) sections 2 to 7 above;
 - (b) health and safety regulations, except so far as they make provision exclusively in relation to transport systems falling within paragraph 1(3) of Schedule 3 to the Railways Act 2005; and
 - (c) the existing statutory provisions that are not such provisions by virtue of section 117(4) of the Railways Act 1993.]
- (2) [^{F58}The Executive] shall not approve a code of practice under subsection (1) above without the consent of the Secretary of State, and shall, before seeking his consent, consult—
- (a) any government department or other body that appears to [^{F58}the Executive] to be appropriate^{F62} . . . ^{F62} . . . ^{F62} . . .; and
 - (b) such government departments and other bodies, if any, as in relation to any matter dealt with in the code, [^{F58}the Executive] is required to consult under this section by virtue of directions given to it by the Secretary of State.
- (3) Where a code of practice is approved by [^{F58}the Executive] under subsection (1) above, [^{F58}the Executive] shall issue a notice in writing—
- (a) identifying the code in question and stating the date on which its approval by [^{F58}the Executive] is to take effect; and
 - (b) specifying for which of the provisions mentioned in subsection (1) above the code is approved.
- (4) [^{F58}The Executive] may—
- (a) from time to time revise the whole or any part of any code of practice prepared by it in pursuance of this section;
 - (b) approve any revision or proposed revision of the whole or any part of any code of practice for the time being approved under this section;
- and the provisions of subsections (2) and (3) above shall, with the necessary modifications, apply in relation to the approval of any revision under this subsection as they apply in relation to the approval of a code of practice under subsection (1) above.
- (5) [^{F58}The Executive] may at any time with the consent of the Secretary of State withdraw its approval from any code of practice approved under this section, but before seeking his consent shall consult the same government departments and other bodies as it would be required to consult under subsection (2) above if it were proposing to approve the code.

Changes to legislation: *Health and Safety at Work etc. Act 1974 is up to date with all changes known to be in force on or before 28 April 2021. There are changes that may be brought into force at a future date. Changes that have been made appear in the content and are referenced with annotations. (See end of Document for details) View outstanding changes*

- (6) Where under the preceding subsection [^{F58}the Executive] withdraws its approval from a code of practice approved under this section, [^{F58}the Executive] shall issue a notice in writing identifying the code in question and stating the date on which its approval of it is to cease to have effect.
- (7) References in this Part to an approved code of practice are references to that code as it has effect for the time being by virtue of any revision of the whole or any part of it approved under this section.
- (8) The power of [^{F58}the Executive] under subsection (1)(b) above to approve a code of practice issued or proposed to be issued otherwise than by [^{F58}the Executive] shall include power to approve a part of such a code of practice; and accordingly in this Part “code of practice” may be read as including a part of such a code of practice.

Extent Information

- E4** This version of this provision extends to England and Wales and Scotland only; a separate version has been created for Northern Ireland only

Textual Amendments

- F58** Words in s. 16 substituted (1.4.2008) by [The Legislative Reform \(Health and Safety Executive\) Order 2008 \(S.I. 2008/960\)](#), [art. 8](#) (with [art. 21](#), [Sch. 2](#))
- F59** Words in s. 16(1) substituted (E.W.S.) (1.4.2006) by [Railways Act 2005 \(c. 14\)](#), ss. 2, 60, [Sch. 3 para. 9\(1\)](#); [S.I. 2006/266](#), [art. 2](#), [Sch.](#)
- F60** Words repealed by [Employment Protection Act 1975 \(c. 71\)](#), [Sch. 18](#)
- F61** S. 16(1A) inserted (E.W.S.) (1.4.2006) by [Railways Act 2005 \(c. 14\)](#), ss. 2, 60, [Sch. 3 para. 9\(2\)](#); [S.I. 2006/266](#), [art. 2](#), [Sch.](#)
- F62** Words in s. 16(2)(a) omitted (1.4.2013) by virtue of [Health and Social Care Act 2012 \(c. 7\)](#), s. 306(4), [Sch. 7 para. 5](#); [S.I. 2013/160](#), [art. 2\(2\)](#) (with [arts. 7-9](#))

Modifications etc. (not altering text)

- C36** Ss. 1-59 applied by [S.I. 2001/2127 art. 8A 8B](#) (as inserted (E.W.S.) (6.4.2011) by [The Health and Safety at Work etc. Act 1974 \(Application outside Great Britain\) \(Variation\) Order 2011 \(S.I. 2011/745\)](#), [arts. 1\(1\)](#), [3\(2\)](#))
- C111** Ss. 1-25, 26, 27, 28, 30, 33, 34-59, 80, 81 and 82 applied by [S.I. 1989/840](#), [arts. 2-10](#)
 Ss. 16-21, 23, 24, 26, 28, 33, 34, 36-39, 42(1)-(3), 46 extended (E.W.S.) (1.10.1996) by [S.I. 1996/1513](#), [reg. 10](#)
 Ss. 16-24, 26, 28, 33-40, 42, 46, 47 excluded (with saving) (E.W.S.) (1.12.1997) by [S.I. 1997/1840](#), [regs. 7, 9](#)
 Ss. 16-26, 33-42, 47 applied (15.11.2000) by [S.I. 2000/2831](#), [reg. 26\(1\)\(a\)](#)
- C112** Ss. 16-21 extended (with modifications) (1.4.1999) by [S.I. 1999/743](#), [reg. 20\(1\)](#), (2), (3)
 Ss. 16-21 applied (E.W.S.) (20.9.2001) by [S.I. 2001/2975](#), [reg. 19\(a\)](#)
 Ss. 16-26 applied (E.W.S.) (24.7.2002) by [S.I. 2002/1689](#), [reg. 14\(1\)\(a\)](#)
- C113** Ss. 1-59, 80-82 applied (11.7.2001) by [S.I. 2001/2127](#), [arts. 4\(1\)](#), 5(1)(2), 6(1), 7(1), 8(1), 10 (with [art. 11](#)) (as amended by [S.I. 2009/1750](#), [art. 2\(2\)\(4\)](#))
- C114** Ss. 1-59, 80-82 applied (temp.) (5.8.2009) by [The Health and Safety at Work etc. Act 1974 \(Application outside Great Britain\) Order 2001 \(S.I. 2001/2127\)](#), [arts. 8A, 8B](#) (as inserted by [S.I. 2009/1750](#), [art. 2\(3\)](#))
- C115** Ss. 16-26 applied (E.W.S.) (1.10.2014) by [The Genetically Modified Organisms \(Contained Use\) Regulations 2014 \(S.I. 2014/1663\)](#), [regs. 1, 30\(2\)\(a\)](#) (with [reg. 3\(1\)\(2\)](#))
- C116** Ss. 16-21 applied (with modifications) (E.W.S.) (1.6.2015) by [The Control of Major Accident Hazards Regulations 2015 \(S.I. 2015/483\)](#), [regs. 1\(1\)](#), [27\(1\)\(a\)](#) (with [reg. 3\(2\)](#))

Changes to legislation: *Health and Safety at Work etc. Act 1974 is up to date with all changes known to be in force on or before 28 April 2021. There are changes that may be brought into force at a future date. Changes that have been made appear in the content and are referenced with annotations. (See end of Document for details) View outstanding changes*

C117 Ss. 16-22 applied (E.W.S.) (19.7.2015) by [The Offshore Installations \(Offshore Safety Directive\) \(Safety Case etc.\) Regulations 2015 \(S.I. 2015/398\)](#), regs. 1, **36(1)(a)** (with reg. 4(2), Sch. 14)

16 Approval of codes of practice by [^{F58}the Executive]. **N.I.**

- (1) For the purpose of providing practical guidance with respect to the requirements of any provision of sections 2 to 7 or of health and safety regulations or of any of the existing statutory provisions, [^{F58}the Executive] may, subject to the following subsection ^{F60} . . .
 - (a) approve and issue such codes of practice (whether prepared by it or not) as in its opinion are suitable for that purpose;
 - (b) approve such codes of practice issued or proposed to be issued otherwise than by [^{F58}the Executive] as in its opinion are suitable for that purpose.
- (2) [^{F58}The Executive] shall not approve a code of practice under subsection (1) above without the consent of the Secretary of State, and shall, before seeking his consent, consult—
 - (a) any government department or other body that appears to [^{F58}the Executive] to be appropriate^{F62} . . .; and
 - (b) such government departments and other bodies, if any, as in relation to any matter dealt with in the code, [^{F58}the Executive] is required to consult under this section by virtue of directions given to it by the Secretary of State.
- (3) Where a code of practice is approved by [^{F58}the Executive] under subsection (1) above, [^{F58}the Executive] shall issue a notice in writing—
 - (a) identifying the code in question and stating the date on which its approval by [^{F58}the Executive] is to take effect; and
 - (b) specifying for which of the provisions mentioned in subsection (1) above the code is approved.
- (4) [^{F58}The Executive] may—
 - (a) from time to time revise the whole or any part of any code of practice prepared by it in pursuance of this section;
 - (b) approve any revision or proposed revision of the whole or any part of any code of practice for the time being approved under this section;

and the provisions of subsections (2) and (3) above shall, with the necessary modifications, apply in relation to the approval of any revision under this subsection as they apply in relation to the approval of a code of practice under subsection (1) above.
- (5) [^{F58}The Executive] may at any time with the consent of the Secretary of State withdraw its approval from any code of practice approved under this section, but before seeking his consent shall consult the same government departments and other bodies as it would be required to consult under subsection (2) above if it were proposing to approve the code.
- (6) Where under the preceding subsection [^{F58}the Executive] withdraws its approval from a code of practice approved under this section, [^{F58}the Executive] shall issue a notice in writing identifying the code in question and stating the date on which its approval of it is to cease to have effect.
- (7) References in this Part to an approved code of practice are references to that code as it has effect for the time being by virtue of any revision of the whole or any part of it approved under this section.

Changes to legislation: *Health and Safety at Work etc. Act 1974 is up to date with all changes known to be in force on or before 28 April 2021. There are changes that may be brought into force at a future date. Changes that have been made appear in the content and are referenced with annotations. (See end of Document for details) View outstanding changes*

- (8) The power of [^{F58}the Executive] under subsection (1)(b) above to approve a code of practice issued or proposed to be issued otherwise than by [^{F58}the Executive] shall include power to approve a part of such a code of practice; and accordingly in this Part “code of practice” may be read as including a part of such a code of practice.

Extent Information

- E11** This version of this provision extends to Northern Ireland only; a separate version has been created for England and Wales and Scotland only

Textual Amendments

- F58** Words in s. 16 substituted (1.4.2008) by [The Legislative Reform \(Health and Safety Executive\) Order 2008 \(S.I. 2008/960\)](#), [art. 8](#) (with [art. 21](#), [Sch. 2](#))
- F60** Words repealed by [Employment Protection Act 1975 \(c. 71\)](#), [Sch. 18](#)
- F62** Words in s. 16(2)(a) omitted (1.4.2013) by virtue of [Health and Social Care Act 2012 \(c. 7\)](#), s. 306(4), [Sch. 7 para. 5](#); S.I. 2013/160, [art. 2\(2\)](#) (with [arts. 7-9](#))

Modifications etc. (not altering text)

- C111** Ss. 1–25, 26, 27, 28, 30, 33, 34–59, 80, 81 and 82 applied by [S.I. 1989/840](#), [arts. 2–10](#)
 Ss. 16–21, 23, 24, 26, 28, 33, 34, 36–39, 42(1)–(3), 46 extended (E.W.S.) (1.10.1996) by [S.I. 1996/1513](#), [reg. 10](#)
 Ss. 16–24, 26, 28, 33–40, 42, 46, 47 excluded (with saving) (E.W.S.) (1.12.1997) by [S.I. 1997/1840](#), [regs. 7, 9](#)
 Ss. 16–26, 33–42, 47 applied (15.11.2000) by [S.I. 2000/2831](#), [reg. 26\(1\)\(a\)](#)
- C112** Ss. 16–21 extended (with modifications) (1.4.1999) by [S.I. 1999/743](#), [reg. 20\(1\)](#), (2), (3)
 Ss. 16–21 applied (E.W.S.) (20.9.2001) by [S.I. 2001/2975](#), [reg. 19\(a\)](#)
 Ss. 16–26 applied (E.W.S.) (24.7.2002) by [S.I. 2002/1689](#), [reg. 14\(1\)\(a\)](#)
- C113** Ss. 1–59, 80–82 applied (11.7.2001) by [S.I. 2001/2127](#), [arts. 4\(1\)](#), 5(1)(2), 6(1), 7(1), 8(1), 10 (with [art. 11](#)) (as amended by [S.I. 2009/1750](#), [art. 2\(2\)\(4\)](#))
- C114** Ss. 1–59, 80–82 applied (temp.) (5.8.2009) by [The Health and Safety at Work etc. Act 1974 \(Application outside Great Britain\) Order 2001 \(S.I. 2001/2127\)](#), [arts. 8A, 8B](#) (as inserted by [S.I. 2009/1750](#), [art. 2\(3\)](#))
- C116** Ss. 16–21 applied (with modifications) (E.W.S.) (1.6.2015) by [The Control of Major Accident Hazards Regulations 2015 \(S.I. 2015/483\)](#), [regs. 1\(1\)](#), [27\(1\)\(a\)](#) (with [reg. 3\(2\)](#))
- C117** Ss. 16–22 applied (E.W.S.) (19.7.2015) by [The Offshore Installations \(Offshore Safety Directive\) \(Safety Case etc.\) Regulations 2015 \(S.I. 2015/398\)](#), [regs. 1](#), [36\(1\)\(a\)](#) (with [reg. 4\(2\)](#), [Sch. 14](#))

17 Use of approved codes of practice in criminal proceedings.

- (1) A failure on the part of any person to observe any provision of an approved code of practice shall not of itself render him liable to any civil or criminal proceedings; but where in any criminal proceedings a party is alleged to have committed an offence by reason of a contravention of any requirement or prohibition imposed by or under any such provision as is mentioned in section 16(1) being a provision for which there was an approved code of practice at the time of the alleged contravention, the following subsection shall have effect with respect to that code in relation to those proceedings.
- (2) Any provision of the code of practice which appears to the court to be relevant to the requirement or prohibition alleged to have been contravened shall be admissible in evidence in the proceedings; and if it is proved that there was at any material time a failure to observe any provision of the code which appears to the court to be relevant

Changes to legislation: *Health and Safety at Work etc. Act 1974 is up to date with all changes known to be in force on or before 28 April 2021. There are changes that may be brought into force at a future date. Changes that have been made appear in the content and are referenced with annotations. (See end of Document for details) View outstanding changes*

to any matter which it is necessary for the prosecution to prove in order to establish a contravention of that requirement or prohibition, that matter shall be taken as proved unless the court is satisfied that the requirement or prohibition was in respect of that matter complied with otherwise than by way of observance of that provision of the code.

- (3) In any criminal proceedings—
- (a) a document purporting to be a notice issued by [^{F63}the Executive] under section 16 shall be taken to be such a notice unless the contrary is proved; and
 - (b) a code of practice which appears to the court to be the subject of such a notice shall be taken to be the subject of that notice unless the contrary is proved.

Textual Amendments

F63 Words in s. 17(3)(a) substituted (1.4.2008) by [The Legislative Reform \(Health and Safety Executive\) Order 2008 \(S.I. 2008/960\)](#), [art. 9](#) (with [art. 21](#), [Sch. 2](#))

Modifications etc. (not altering text)

- C36** Ss. 1-59 applied by S.I. 2001/2127 art. 8A 8B (as inserted (E.W.S.) (6.4.2011) by [The Health and Safety at Work etc. Act 1974 \(Application outside Great Britain\) \(Variation\) Order 2011 \(S.I. 2011/745\)](#), [arts. 1\(1\)](#), [3\(2\)](#))
- C115** Ss. 16-26 applied (E.W.S.) (1.10.2014) by [The Genetically Modified Organisms \(Contained Use\) Regulations 2014 \(S.I. 2014/1663\)](#), [regs. 1](#), [30\(2\)\(a\)](#) (with [reg. 3\(1\)\(2\)](#))
- C116** Ss. 16-21 applied (with modifications) (E.W.S.) (1.6.2015) by [The Control of Major Accident Hazards Regulations 2015 \(S.I. 2015/483\)](#), [regs. 1\(1\)](#), [27\(1\)\(a\)](#) (with [reg. 3\(2\)](#))
- C117** Ss. 16-22 applied (E.W.S.) (19.7.2015) by [The Offshore Installations \(Offshore Safety Directive\) \(Safety Case etc.\) Regulations 2015 \(S.I. 2015/398\)](#), [regs. 1](#), [36\(1\)\(a\)](#) (with [reg. 4\(2\)](#), [Sch. 14](#))
- C118** Ss. 1-25, 26, 27, 28, 30, 33, 34-59, 80, 81 and 82 applied by S.I. 1989/840, [arts. 2-10](#)
Ss. 16-21, 23, 24, 26, 28, 33, 34, 36-39, 42(1)-(3), 46 extended (E.W.S.) (1.10.1996) by S.I. 1996/1513, [reg. 10](#)
Ss. 16-24, 26, 28, 33-40, 42, 46, 47 excluded (with saving) (E.W.S.) (1.12.1997) by S.I. 1997/1840, [regs. 7](#), [9](#)
Ss. 16-26, 33-42, 47 applied (15.11.2000) by S.I. 2000/2831, [reg. 26\(1\)\(a\)](#)
Ss. 16-26 applied (E.W.S.) (24.7.2002) by S.I. 2002/1689, [reg. 14\(1\)\(a\)](#)
- C119** Ss. 16-21 extended (with modifications) (1.4.1999) by S.I. 1999/743, [reg. 20\(1\)\(a\)](#), (2)(3)
Ss. 16-21 applied (E.W.S.) (20.9.2001) by S.I. 2001/2975, [reg. 19\(a\)](#)
- C120** Ss. 1-59, 80-82 applied (11.7.2001) by S.I. 2001/2127, [arts. 4\(1\)](#), 5(1)(2), 6(1), 7(1), 8(1), 10 (with [art. 11](#)) (as amended by S.I. 2009/1750, [art. 2\(2\)\(4\)](#))
- C121** Ss. 1-59, 80-82 applied (temp.) (5.8.2009) by [The Health and Safety at Work etc. Act 1974 \(Application outside Great Britain\) Order 2001 \(S.I. 2001/2127\)](#), [arts. 8A](#), [8B](#) (as inserted by S.I. 2009/1750, [art. 2\(3\)](#))

Enforcement

18 Authorities responsible for enforcement of the relevant statutory provisions.

- (1) It shall be the duty of the Executive to make adequate arrangements for the enforcement of the relevant statutory provisions except to the extent that some other authority or class of authorities is by any of those provisions or by regulations under subsection (2) below made responsible for their enforcement.

Changes to legislation: Health and Safety at Work etc. Act 1974 is up to date with all changes known to be in force on or before 28 April 2021. There are changes that may be brought into force at a future date. Changes that have been made appear in the content and are referenced with annotations. (See end of Document for details) View outstanding changes

[^{F64}(1A) The Office for Nuclear Regulation is responsible for the enforcement of the relevant statutory provisions as they apply in relation to GB nuclear sites (within the meaning given in section 68 of the Energy Act 2013 (nuclear safety purposes)).

(1B) Subsection (1A) is subject to any provision of health and safety regulations making the [^{F65}Office of Rail and Road] responsible for the enforcement of any of the relevant statutory provisions to any extent in relation to such sites.]

(2) The Secretary of State may by regulations—

[^{F66}(za) make the Office for Nuclear Regulation responsible for the enforcement of the relevant statutory provisions to such extent as may be prescribed (and may in particular provide for any site or matter in relation to which the Office for Nuclear Regulation is made so responsible to be determined by the Secretary of State or the Office for Nuclear Regulation under the regulations);]

(a) make local authorities responsible for the enforcement of the relevant statutory provisions to such extent as may be prescribed;

(b) make provision for enabling responsibility for enforcing any of the relevant statutory provisions to be, to such extent as may be determined under the regulations—

[^{F67}(zi) transferred from the Executive or local authorities to the Office for Nuclear Regulation, or from the Office for Nuclear Regulation to the Executive or local authorities;]

(i) transferred from the Executive to local authorities or from local authorities to the Executive; or

(ii) assigned to the Executive [^{F68}, to the Office for Nuclear Regulation] or to local authorities for the purpose of removing any uncertainty as to what are by virtue of [^{F69}subsection (1A) or] this subsection their respective responsibilities for the enforcement of those provisions;

[^{F70}(iii) assigned to the [^{F65}Office of Rail and Road] or the Office for Nuclear Regulation for the purpose of removing any uncertainty as to what are by virtue of any of the relevant statutory provisions their respective responsibilities for the enforcement of any of those provisions;]

and any regulations made in pursuance of paragraph (b) above shall include provision for securing that any transfer or assignment effected under the regulations is brought to the notice of persons affected by it.

(3) Any provision made by regulations under the preceding subsection shall have effect subject to any provision made by health and safety regulations ^{F71}. . . in pursuance of section 15(3)(c).

[^{F72}(3A) Regulations under subsection (2)(a) may not make local authorities enforcing authorities in relation to any site in relation to which the Office for Nuclear Regulation is an enforcing authority.]

[^{F72}(3B) Where the Office for Nuclear Regulation is, by or under subsection (1A) or (2), made responsible for the enforcement of any of the relevant statutory provisions to any extent, it must make adequate arrangements for the enforcement of those provisions to that extent.]

(4) It shall be the duty of every local authority—

(a) to make adequate arrangements for the enforcement within their area of the relevant statutory provisions to the extent that they are by any of those

Changes to legislation: *Health and Safety at Work etc. Act 1974 is up to date with all changes known to be in force on or before 28 April 2021. There are changes that may be brought into force at a future date. Changes that have been made appear in the content and are referenced with annotations. (See end of Document for details) View outstanding changes*

provisions or by regulations under subsection (2) above made responsible for their enforcement; and

- (b) to perform the duty imposed on them by the preceding paragraph and any other functions conferred on them by any of the relevant statutory provisions in accordance with such guidance as [^{F73}the Executive] may give them.

[^{F74}(4A) Before the Executive gives guidance under subsection (4)(b) it shall consult the local authorities.

(4B) It shall be the duty of the Executive and the local authorities—

- (a) to work together to establish best practice and consistency in the enforcement of the relevant statutory provisions;
- (b) to enter into arrangements with each other for securing cooperation and the exchange of information in connection with the carrying out of their functions with regard to the relevant statutory provisions; and
- (c) from time to time to review those arrangements and to revise them when they consider it appropriate to do so.]

(5) Where any authority other than [^{F71} . . . , the Executive [^{F75} the Office for Nuclear Regulation] or a local authority is by any of the relevant statutory provisions [^{F76} . . . made responsible for the enforcement of any of those provisions to any extent, it shall be the duty of that authority—

- (a) to make adequate arrangements for the enforcement of those provisions to that extent; and
- (b) [^{F77}except where that authority is the [^{F65}Office of Rail and Road],]to perform the duty imposed on the authority by the preceding paragraph and any other functions conferred on the authority by any of the relevant statutory provisions in accordance with such guidance as [^{F78}the Executive] may give to the authority.

(6) Nothing in the provisions of this Act or of any regulations made thereunder charging any person in Scotland with the enforcement of any of the relevant statutory provisions shall be construed as authorising that person to institute proceedings for any offence.

(7) In this Part—

- (a) “enforcing authority” means the Executive or any other authority which is by any of the relevant statutory provisions or by regulations under subsection (2) above made responsible for the enforcement of any of those provisions to any extent; and
- (b) any reference to an enforcing authority’s field of responsibility is a reference to the field over which that authority’s responsibility for the enforcement of those provisions extends for the time being;

but where by virtue of [^{F79}subsection (3) of section 13][^{F80} of this Act or section 95 of the Energy Act 2013 (power for Office for Nuclear Regulation to arrange for exercise of functions by others)]the performance of any function of [^{F81} . . . the Executive [^{F82} or the Office for Nuclear Regulation] is delegated to a government department or person, references to [^{F81} . . . the Executive [^{F83} or the Office for Nuclear Regulation (as the case may be)] (or to an enforcing authority where that authority is the Executive) in any provision of this Part which relates to that function shall, so far as may be necessary to give effect to any agreement [^{F84} or arrangements under the provision in question] , be construed as references to that department or person; and accordingly any reference to the field of responsibility of an enforcing authority shall be construed as a reference

Changes to legislation: Health and Safety at Work etc. Act 1974 is up to date with all changes known to be in force on or before 28 April 2021. There are changes that may be brought into force at a future date. Changes that have been made appear in the content and are referenced with annotations. (See end of Document for details) View outstanding changes

to the field over which that department or person for the time being performs such a function.

Textual Amendments

- F64** S. 18(1A)(1B) inserted (1.4.2014) by [Energy Act 2013 \(c. 32\)](#), s. 156(1), **Sch. 12 para. 6(2)**; S.I. 2014/251, art. 4
- F65** Words in s. 18 substituted (E.W.S.) (16.10.2015) by [The Office of Rail Regulation \(Change of Name\) Regulations 2015 \(S.I. 2015/1682\)](#), reg. 1(2), **Sch. para. 4(c)(ii)**
- F66** S. 18(2)(za) inserted (1.4.2014) by [Energy Act 2013 \(c. 32\)](#), s. 156(1), **Sch. 12 para. 6(3)(a)**; S.I. 2014/251, art. 4
- F67** S. 18(2)(b)(zi) inserted (1.4.2014) by [Energy Act 2013 \(c. 32\)](#), s. 156(1), **Sch. 12 para. 6(3)(b)**; S.I. 2014/251, art. 4
- F68** Words in s. 18(2)(b)(ii) inserted (1.4.2014) by [Energy Act 2013 \(c. 32\)](#), s. 156(1), **Sch. 12 para. 6(3)(c)(i)**; S.I. 2014/251, art. 4
- F69** Words in s. 18(2)(b)(ii) inserted (1.4.2014) by [Energy Act 2013 \(c. 32\)](#), s. 156(1), **Sch. 12 para. 6(3)(c)(ii)**; S.I. 2014/251, art. 4
- F70** S. 18(2)(b)(iii) inserted (1.4.2014) by [Energy Act 2013 \(c. 32\)](#), s. 156(1), **Sch. 12 para. 6(3)(d)**; S.I. 2014/251, art. 4
- F71** Words repealed by [Employment Protection Act 1975 \(c. 71\)](#), **Sch. 18**
- F72** s. 18(3A)(3B) inserted (1.4.2014) by [Energy Act 2013 \(c. 32\)](#), s. 156(1), **Sch. 12 para. 6(4)**; S.I. 2014/251, art. 4
- F73** Words in s. 18(4)(b) substituted (1.4.2008) by [The Legislative Reform \(Health and Safety Executive\) Order 2008 \(S.I. 2008/960\)](#), **art. 10(2)** (with art. 21, Sch. 2)
- F74** S. 18(4A)(4B) inserted (1.4.2008) by [The Legislative Reform \(Health and Safety Executive\) Order 2008 \(S.I. 2008/960\)](#), **art. 10(3)** (with art. 21, Sch. 2)
- F75** Words in s. 18(5) inserted (1.4.2014) by [Energy Act 2013 \(c. 32\)](#), s. 156(1), **Sch. 12 para. 6(5)**; S.I. 2014/251, art. 4
- F76** Words in s. 18(5) repealed (8.6.2005) by [Railways Act 2005 \(c. 14\)](#), ss. 59, 60, **Sch. 13 Pt. 1** (with s. 14(4)(5), Sch. 11 para. 11(2)); S.I. 2005/1444, **art. 2**, Sch. 1
- F77** Words in s. 18(5)(b) inserted (1.4.2006) by [Railways Act 2005 \(c. 14\)](#), ss. 2, 60, **Sch. 3 para. 10(3)**; S.I. 2006/266, **art. 2(2)**, Sch.
- F78** Words in s. 18(5)(b) substituted (1.4.2008) by [The Legislative Reform \(Health and Safety Executive\) Order 2008 \(S.I. 2008/960\)](#), **art. 10(4)** (with art. 21, Sch. 2)
- F79** Words in s. 18(7) substituted (1.4.2008) by [The Legislative Reform \(Health and Safety Executive\) Order 2008 \(S.I. 2008/960\)](#), **art. 10(5)(a)** (with art. 21, Sch. 2)
- F80** Words in s. 18(7) inserted (1.4.2014) by [Energy Act 2013 \(c. 32\)](#), s. 156(1), **Sch. 12 para. 6(6)(a)**; S.I. 2014/251, art. 4
- F81** Words in s. 18(7) omitted (1.4.2008) by virtue of [The Legislative Reform \(Health and Safety Executive\) Order 2008 \(S.I. 2008/960\)](#), **art. 10(5)(c)** (with art. 21, Sch. 2)
- F82** Words in s. 18(7) inserted (1.4.2014) by [Energy Act 2013 \(c. 32\)](#), s. 156(1), **Sch. 12 para. 6(6)(b)**; S.I. 2014/251, art. 4
- F83** Words in s. 18(7) inserted (1.4.2014) by [Energy Act 2013 \(c. 32\)](#), s. 156(1), **Sch. 12 para. 6(6)(c)**; S.I. 2014/251, art. 4
- F84** Words in s. 18(7) substituted (1.4.2014) by [Energy Act 2013 \(c. 32\)](#), s. 156(1), **Sch. 12 para. 6(6)(d)**; S.I. 2014/251, art. 4

Modifications etc. (not altering text)

- C36** Ss. 1-59 applied by S.I. 2001/2127 art. 8A 8B (as inserted (E.W.S.) (6.4.2011) by [The Health and Safety at Work etc. Act 1974 \(Application outside Great Britain\) \(Variation\) Order 2011 \(S.I. 2011/745\)](#), arts. 1(1), **3(2)**)

Changes to legislation: *Health and Safety at Work etc. Act 1974 is up to date with all changes known to be in force on or before 28 April 2021. There are changes that may be brought into force at a future date. Changes that have been made appear in the content and are referenced with annotations. (See end of Document for details) View outstanding changes*

- C115** Ss. 16-26 applied (E.W.S.) (1.10.2014) by [The Genetically Modified Organisms \(Contained Use\) Regulations 2014 \(S.I. 2014/1663\)](#), regs. 1, **30(2)(a)** (with reg. 3(1)(2))
- C116** Ss. 16-21 applied (with modifications) (E.W.S.) (1.6.2015) by [The Control of Major Accident Hazards Regulations 2015 \(S.I. 2015/483\)](#), regs. 1(1), **27(1)(a)** (with reg. 3(2))
- C117** Ss. 16-22 applied (E.W.S.) (19.7.2015) by [The Offshore Installations \(Offshore Safety Directive\) \(Safety Case etc.\) Regulations 2015 \(S.I. 2015/398\)](#), regs. 1, **36(1)(a)** (with reg. 4(2), Sch. 14)
- C122** Ss. 1–25, 26, 27, 28, 30, 33, 34–59, 80, 81 and 82 applied by S.I. 1989/840, **arts. 2–10**
Ss. 16-21, 23, 24, 26, 28, 33, 34, 36-39, 42(1)-(3), 46 extended (E.W.S.) (1.10.1996) by S.I. 1996/1513, **reg. 10**
Ss. 16-24, 26, 28, 33-40, 42, 46, 47 excluded (with saving) (E.W.S.) (1.12.1997) by S.I. 1997/1840, **regs. 7, 9**
Ss. 18-20: power to apply conferred (E.W.S.) (28.8.1995) by 1995 c. 15, **ss. 2(4)(b)**, 5 (with s. 3(5))
Ss. 18-27, 33(1)(e)-(i)(n)(o)(2)-(4), 34(2)-(6), 36(1), 37-42, 46 applied (with modifications) (E.W.S.) (16.4.1996) by S.I. 1996/772, **reg. 17**
Ss. 16-26, 33-42, 47 applied (15.11.2000) by S.I. 2000/2831, **reg. 26(1)(a)**
- C123** S. 18 extended (with modifications) (1.4.1999) by S.I. 1999/743, **reg. 20(1)-(3)**
S. 18 applied (E.W.S.) (20.9.2001) by S.I. 2001/2975, **reg. 19(a)**
S. 18 applied (E.W.S.) (24.7.2002) by S.I. 2002/1689, **reg. 14(1)(a)**
S. 18 applied (31.3.2002) by S.I. 2002/528, **reg. 10**
- C124** Ss. 18-26 applied (with modifications) (19.11.1999) by S.I. 1999/2892, **reg. 16(1)**
- C125** Ss. 1-59, 80-82 applied (11.7.2001) by S.I. 2001/2127, **arts. 4(1)**, 5(1)(2), 6(1), 7(1), 8(1), 10 (with art. 11) (as amended by S.I. 2009/1750, **art. 2(2)(4)**)
- C126** S. 18 applied (with modifications) (E.W.S.) (9.6.2004) by S.I. 2004/1309, **reg. 17**
- C127** Ss. 1-59, 80-82 applied (temp.) (5.8.2009) by [The Health and Safety at Work etc. Act 1974 \(Application outside Great Britain\) Order 2001 \(S.I. 2001/2127\)](#), arts. 8A, 8B (as inserted by S.I. 2009/1750, **art. 2(3)**)
- C128** Ss. 18-26 applied (with modifications) (E.W.S.) (1.9.2013) by [The Biocidal Products and Chemicals \(Appointment of Authorities and Enforcement\) Regulations 2013 \(S.I. 2013/1506\)](#), regs. 2(1), **8(1)** (with reg. 3(4), (5), 8(2)-(7), 31)
- C129** Ss. 18-28 applied (with modifications) (E.W.S.) (1.6.2015) by [The Biocidal Products and Chemicals \(Appointment of Authorities and Enforcement\) Regulations 2013 \(S.I. 2013/1506\)](#), regs. 2(2), **17(1)** (with reg. 3(4)(5)(31))
- C130** Ss. 18-21 applied (E.W.S.) (19.7.2015) by [The Offshore Installations \(Offshore Safety Directive\) \(Safety Case etc.\) Regulations 2015 \(S.I. 2015/398\)](#), regs. 1, **36(8)(a)** (with reg. 4(2), Sch. 14)
- C131** S. 18(1) applied (with modifications) (1.4.1999) (with savings) by S.I. 1999/743, **reg. 20(3)(4)**
- C132** S. 18(1) applied (with modifications) (E.W.S.) (1.6.2015) by [The Control of Major Accident Hazards Regulations 2015 \(S.I. 2015/483\)](#), regs. 1(1), **27(2)(b)** (with regs. 3(2), 27(3))
- C133** S. 18(1) applied (19.7.2015) by [The Offshore Installations \(Offshore Safety Directive\) \(Safety Case etc.\) Regulations 2015 \(S.I. 2015/398\)](#), regs. 1, **36(9)** (with reg. 4(2), Sch. 14)
- C134** S. 18(1) applied (E.W.S.) (19.7.2015) by [The Offshore Installations \(Offshore Safety Directive\) \(Safety Case etc.\) Regulations 2015 \(S.I. 2015/398\)](#), regs. 1, **36(3)** (with reg. 4(2), Sch. 14)
- C135** S. 18(3B) applied (with modifications) (E.W.S.) (1.6.2015) by [The Control of Major Accident Hazards Regulations 2015 \(S.I. 2015/483\)](#), regs. 1(1), **27(2)(a)** (with regs. 3(2), 27(3))
- C136** S. 18(6) modified (6.4.1992) by S.I. 1992/711, **regs. 1(2)**, 28(3)(b)(5)(a)
- C137** Ss. 18(6)(7)(b), 19-22, 23(1)(2)(5), 24-26, 33(1)(e)-(h)(o)(2)(2A)(3)(4)(e), 34(3)-(5), 35, 36(1)(2), 37-39, 42 applied (with modifications) (9.1.1995) by S.I. 1994/3260, **reg. 17(3)(5)**
- C138** S. 18(7) applied by [Fire Precautions Act 1971 \(c. 40, SIF 50\)](#), **s. 21(3)** as inserted by [Fire Safety and Safety of Places of Sport Act 1987 \(c. 27, SIF 50\)](#), **s. 11**
- C139** S. 18(7)(b) modified (6.4.1992) by S.I. 1992/711, **regs. 1(2)**, 28(3)(b)(5)(a)

Changes to legislation: Health and Safety at Work etc. Act 1974 is up to date with all changes known to be in force on or before 28 April 2021. There are changes that may be brought into force at a future date. Changes that have been made appear in the content and are referenced with annotations. (See end of Document for details) View outstanding changes

19 Appointment of inspectors.

- (1) Every enforcing authority may appoint as inspectors (under whatever title it may from time to time determine) such persons having suitable qualifications as it thinks necessary for carrying into effect the relevant statutory provisions within its field of responsibility, and may terminate any appointment made under this section.
- (2) Every appointment of a person as an inspector under this section shall be made by an instrument in writing specifying which of the powers conferred on inspectors by the relevant statutory provisions are to be exercisable by the person appointed; and an inspector shall in right of his appointment under this section—
 - (a) be entitled to exercise only such of those powers as are so specified; and
 - (b) be entitled to exercise the powers so specified only within the field of responsibility of the authority which appointed him.
- (3) So much of an inspector's instrument of appointment as specifies the powers which he is entitled to exercise may be varied by the enforcing authority which appointed him.
- (4) An inspector shall, if so required when exercising or seeking to exercise any power conferred on him by any of the relevant statutory provisions, produce his instrument of appointment or a duly authenticated copy thereof.

Modifications etc. (not altering text)

- C36** Ss. 1-59 applied by S.I. 2001/2127 art. 8A 8B (as inserted (E.W.S.) (6.4.2011) by [The Health and Safety at Work etc. Act 1974 \(Application outside Great Britain\) \(Variation\) Order 2011 \(S.I. 2011/745\)](#), arts. 1(1), **3(2)**)
- C115** Ss. 16-26 applied (E.W.S.) (1.10.2014) by [The Genetically Modified Organisms \(Contained Use\) Regulations 2014 \(S.I. 2014/1663\)](#), regs. 1, **30(2)(a)** (with reg. 3(1)(2))
- C116** Ss. 16-21 applied (with modifications) (E.W.S.) (1.6.2015) by [The Control of Major Accident Hazards Regulations 2015 \(S.I. 2015/483\)](#), regs. 1(1), **27(1)(a)** (with reg. 3(2))
- C117** Ss. 16-22 applied (E.W.S.) (19.7.2015) by [The Offshore Installations \(Offshore Safety Directive\) \(Safety Case etc.\) Regulations 2015 \(S.I. 2015/398\)](#), regs. 1, **36(1)(a)** (with reg. 4(2), Sch. 14)
- C128** Ss. 18-26 applied (with modifications) (E.W.S.) (1.9.2013) by [The Biocidal Products and Chemicals \(Appointment of Authorities and Enforcement\) Regulations 2013 \(S.I. 2013/1506\)](#), regs. 2(1), **8(1)** (with reg. 3(4), (5), 8(2)-(7), 31)
- C129** Ss. 18-28 applied (with modifications) (E.W.S.) (1.6.2015) by [The Biocidal Products and Chemicals \(Appointment of Authorities and Enforcement\) Regulations 2013 \(S.I. 2013/1506\)](#), regs. 2(2), **17(1)** (with reg. 3(4)(5)31)
- C130** Ss. 18-21 applied (E.W.S.) (19.7.2015) by [The Offshore Installations \(Offshore Safety Directive\) \(Safety Case etc.\) Regulations 2015 \(S.I. 2015/398\)](#), regs. 1, **36(8)(a)** (with reg. 4(2), Sch. 14)
- C140** S. 19 applied by S.I. 1989/840, arts. 2-10
- C141** S. 19 applied (with modifications) (1.1.1993) by S.I. 1992/3073, reg. 28, **Sch. 6 para. 1(b)**
 S. 19 extended (E.W.S.) (1.10.1996) by S.I. 1996/1513, **reg. 10**
 S. 19 excluded (with saving) (E.W.S.) (1.12.1997) by S.I. 1997/1840, **regs. 7, 9**
 S. 19 applied (with modifications) (9.1.1995) by S.I. 1994/3260, **reg. 17(3)(5)**
 S. 19: power to apply conferred (E.W.S.) (28.8.1995) by 1995 c. 15, **ss. 2(4)(b)**, 5 (with s. 3(5))
 S. 19 applied (with modifications) (E.W.S.) (16.4.1996) by S.I. 1996/772, **reg. 17**
 S. 19 applied (with modifications) (E.W.S.) (1.3.1996) by S.I. 1996/192, reg. 15, **Sch. 14 para. 1(b)**;
 S. 19 applied (with modifications) (E.W.S.) (1.7.1997) by S.I. 1997/831, reg. 19(1)-(4), **Sch. 15 para. 1(a)(b)**
- C142** S. 19 modified (6.4.1992) by S.I. 1992/711, **regs. 1(2)**, 28(3)(b)(5)(a)
 S. 19 restricted (E.W.S.) (1.4.1996) by 1995 c. 25, s. 120(1), **Sch. 22 para. 30(3)** (with ss. 7(6), 115, 117); S.I. 1996/186, **art. 3**

Changes to legislation: *Health and Safety at Work etc. Act 1974 is up to date with all changes known to be in force on or before 28 April 2021. There are changes that may be brought into force at a future date. Changes that have been made appear in the content and are referenced with annotations. (See end of Document for details) View outstanding changes*

- S. 19 applied (15.11.2000) by S.I. 2000/2831, **reg. 26(1)(a)**
- C143** S. 19 extended (with modifications) (1.4.1999) by S.I. 1999/743, **reg. 20(1)(2)(3)**
- S. 19 applied (E.W.S.) (20.9.2001) by S.I. 2001/2975, **reg. 19(a)**
- S. 19 applied (E.W.S.) (24.7.2002) by S.I. 2002/1689, **reg. 14(1)(a)** S. 19 applied (31.3.2002) by S.I. 2002/528, **reg. 10**
- S. 19 applied (16.5.2002) by S.I. 2002/1166, **reg. 31** (with art. 37)
- C144** S. 19 applied (12.4.1999) by S.I. 1999/743, **reg. 22(7)**
- C145** S. 19 applied (with modifications) (19.11.1999) by S.I. 1999/2892, **reg. 16(1)**
- C146** S. 19 applied (with modifications) (29.11.1999) by S.I. 1999/2001, **reg. 24(1), Sch. 8 para. 1(b)**
- C147** S. 19 applied (11.7.2001) by S.I. 2001/2127, **arts. 4(1), 5(1)(2), 6(1), 7(1), 8(1), 10** (with art. 11) (as amended by S.I. 2009/1750, **art. 2(2)(4)**)
- C148** S. 19 applied (with modifications) (E.W.S.) (22.3.2003 for certain purposes and 22.9.2003 otherwise) by S.I. 2003/403, **regs. 1(2), 23(2)(a)(3)**; ss. 19-22 applied (with modifications) (E.W.S.) (3.5.2004) by S.I. 2004/129, **reg. 23(3)(a)**; s. 19 applied (with modifications) (E.W.S.) (9.6.2004) by S.I. 2004/1309, **reg. 17**; s. 19 applied (E.W.S.) (22.4.2005) by S.I. 2005/928, **reg. 4(2)(3)(5)(6)**; ss. 19-22 applied (2.4.2006) by S.I. 2006/397, **reg. 34**
- C149** S. 19 applied (with modifications) (E.W.S.) (the amendment coming into force in accordance with art. 1(1) of the amending S.I.) by The Channel Tunnel (Safety) Order 2007 (S.I. 2007/3531), **art. 4(2)(3)(a)** (subject to (4)-(6)) (with art. 7)
- C150** Ss. 1-59, 80-82 applied (temp.) (5.8.2009) by The Health and Safety at Work etc. Act 1974 (Application outside Great Britain) Order 2001 (S.I. 2001/2127), **arts. 8A, 8B** (as inserted by S.I. 2009/1750, **art. 2(3)**)
- C151** S. 19 applied (with modifications) (E.W.S.) (6.4.2010) by The Rail Vehicle Accessibility (Non-Interoperable Rail System) Regulations 2010 (S.I. 2010/432), **reg. 6(2)(3)(a)**
- C152** S. 19 applied (with modifications) (E.W.S.) (6.4.2010) by The Train Driving Licences and Certificates Regulations 2010 (S.I. 2010/724), **regs. 1(2), 38(2)(3)(a)**
- C153** Ss. 19-28 applied (with modifications) (E.W.S.) (4.7.2010 for certain purposes and otherwise 4.7.2013) by The Pyrotechnic Articles (Safety) Regulations 2010 (S.I. 2010/1554), **regs. 1, 18, 37(1)**, {Sch. 4 paras. 1, 2}
- C154** S. 19 applied (with modifications) (16.1.2012) by The Railways (Interoperability) Regulations 2011 (S.I. 2011/3066), **regs. 1(2), 39(2)(3)(a)** (with reg. 3)
- C155** Ss. 19, 20 applied (1.3.2014) by The Biocidal Products and Chemicals (Appointment of Authorities and Enforcement) Regulations 2013 (S.I. 2013/1506), **regs. 2(4), 19** (with reg. 3(4)(5)(31))
- C156** Ss. 19-28 applied (with modifications) (E.W.S.) (1.10.2014) by The Explosives Regulations 2014 (S.I. 2014/1638), **reg. 1(1), Sch. 12 paras. 2, 3**
- C157** S. 19 applied (with modifications) (17.8.2015) by The Pyrotechnic Articles (Safety) Regulations 2015 (S.I. 2015/1553), **reg. 1, Sch. 8 paras. 1(b), 2**
- C158** Ss. 19-28 applied (with modifications) by S.I. 2014/1638, Sch. 12 paras. 5-7 (as substituted (E.W.S.) (20.4.2016) by The Explosives Regulations 2014 (Amendment) Regulations 2016 (S.I. 2016/315), **reg. 1, Sch. 1** (with **regs. 2(1), 15**))
- C159** S. 19 applied (with modifications) (8.12.2016) by The Electrical Equipment (Safety) Regulations 2016 (S.I. 2016/1101), **reg. 1, Sch. 4 paras. 1, 2** (with reg. 3)
- C160** S. 19 applied (with modifications) (8.12.2016) by The Simple Pressure Vessels (Safety) Regulations 2016 (S.I. 2016/1092), **reg. 1, Sch. 6 paras. 1(a), 2** (with reg. 3)
- C161** S. 19 applied (with modifications) (8.12.2016) by The Lifts Regulations 2016 (S.I. 2016/1093), **reg. 1, Sch. 8 paras. 1(b), 2** (with **regs. 3-5**)
- C162** S. 19 applied (with modifications) (8.12.2016) by The Pressure Equipment (Safety) Regulations 2016 (S.I. 2016/1105), **reg. 1, Sch. 8 paras. 1(a), 2** (with reg. 88)
- C163** S. 19 applied (with modifications) (E.W.S.) (8.12.2016) by The Equipment and Protective Systems Intended for Use in Potentially Explosive Atmospheres Regulations 2016 (S.I. 2016/1107), **reg. 1(1), Sch. 4 para. 1(a)**
- C164** S. 19 applied (with modifications) (21.4.2018) by The Personal Protective Equipment (Enforcement) Regulations 2018 (S.I. 2018/390), **reg. 1(1), Sch. 2** (with **reg. 2(1)-(3)**)

Changes to legislation: *Health and Safety at Work etc. Act 1974 is up to date with all changes known to be in force on or before 28 April 2021. There are changes that may be brought into force at a future date. Changes that have been made appear in the content and are referenced with annotations. (See end of Document for details) View outstanding changes*

- C165** S. 19 applied (with modifications) (21.4.2018) by [The Gas Appliances \(Enforcement\) and Miscellaneous Amendments Regulations 2018 \(S.I. 2018/389\)](#), reg. 1(1), **Sch. 2** (with reg. 2)
- C166** Ss. 19-22 applied (with modifications) (30.7.2018) by [The Cableway Installations Regulations 2018 \(S.I. 2018/816\)](#), regs. 1, **21(1)-(3)** (with reg. 4)
- C167** S. 19(2)(3) excluded (E.W.S.) (15.2.1999) by [1998 c. 17, s. 8\(2\)\(c\)](#), (with s. 9(1)(2), Sch. 3 para. 5); [S.I. 1999/161](#), **art. 2(1)(2)**

20 Powers of inspectors.

- (1) Subject to the provisions of section 19 and this section, an inspector may, for the purpose of carrying into effect any of the relevant statutory provisions within the field of responsibility of the enforcing authority which appointed him, exercise the powers set out in subsection (2) below.
- (2) The powers of an inspector referred to in the preceding subsection are the following, namely—
 - (a) at any reasonable time (or, in a situation which in his opinion is or may be dangerous, at any time) to enter any premises which he has reason to believe it is necessary for him to enter for the purpose mentioned in subsection (1) above;
 - (b) to take with him a constable if he has reasonable cause to apprehend any serious obstruction in the execution of his duty;
 - (c) without prejudice to the preceding paragraph, on entering any premises by virtue of paragraph (a) above to take with him—
 - (i) any other person duly authorised by his (the inspector's) enforcing authority; and
 - (ii) any equipment or materials required for any purpose for which the power of entry is being exercised;
 - (d) to make such examination and investigation as may in any circumstances be necessary for the purpose mentioned in subsection (1) above;
 - (e) as regards any premises which he has power to enter, to direct that those premises or any part of them, or anything therein, shall be left undisturbed (whether generally or in particular respects) for so long as is reasonably necessary for the purpose of any examination or investigation under paragraph (d) above;
 - (f) to take such measurements and photographs and make such recordings as he considers necessary for the purpose of any examination or investigation under paragraph (d) above;
 - (g) to take samples of any articles or substances found in any premises which he has power to enter, and of the atmosphere in or in the vicinity of any such premises;
 - (h) in the case of any article or substance found in any premises which he has power to enter, being an article or substance which appears to him to have caused or to be likely to cause danger to health or safety, to cause it to be dismantled or subjected to any process or test (but not so as to damage or destroy it unless this is in the circumstances necessary for the purpose mentioned in subsection (1) above);
 - (i) in the case of any such article or substance as is mentioned in the preceding paragraph, to take possession of it and detain it for so long as is necessary for all or any of the following purposes, namely—

Changes to legislation: *Health and Safety at Work etc. Act 1974 is up to date with all changes known to be in force on or before 28 April 2021. There are changes that may be brought into force at a future date. Changes that have been made appear in the content and are referenced with annotations. (See end of Document for details) View outstanding changes*

- (i) to examine it and do to it anything which he has power to do under that paragraph;
 - (ii) to ensure that it is not tampered with before his examination of it is completed;
 - (iii) to ensure that it is available for use as evidence in any proceedings for an offence under any of the relevant statutory provisions or any proceedings relating to a notice under section 21 or 22;
 - (j) to require any person whom he has reasonable cause to believe to be able to give any information relevant to any examination or investigation under paragraph (d) above to answer (in the absence of persons other than a person nominated by him to be present and any persons whom the inspector may allow to be present) such questions as the inspector thinks fit to ask and to sign a declaration of the truth of his answers;
 - (k) to require the production of, inspect, and take copies of or of any entry in—
 - (i) any books or documents which by virtue of any of the relevant statutory provisions are required to be kept; and
 - (ii) any other books or documents which it is necessary for him to see for the purposes of any examination or investigation under paragraph (d) above;
 - (l) to require any person to afford him such facilities and assistance with respect to any matters or things within that person's control or in relation to which that person has responsibilities as are necessary to enable the inspector to exercise any of the powers conferred on him by this section;
 - (m) any other power which is necessary for the purpose mentioned in subsection (1) above.
- (3) The Secretary of State may by regulations make provision as to the procedure to be followed in connection with the taking of samples under subsection (2)(g) above (including provision as to the way in which samples that have been so taken are to be dealt with).
- (4) Where an inspector proposes to exercise the power conferred by subsection (2)(h) above in the case of an article or substance found in any premises, he shall, if so requested by a person who at the time is present in and has responsibilities in relation to those premises, cause anything which is to be done by virtue of that power to be done in the presence of that person unless the inspector considers that its being done in that person's presence would be prejudicial to the safety of the State.
- (5) Before exercising the power conferred by subsection (2)(h) above in the case of any article or substance, an inspector shall consult such persons as appear to him appropriate for the purpose of ascertaining what dangers, if any, there may be in doing anything which he proposes to do under that power.
- (6) Where under the power conferred by subsection (2)(i) above an inspector takes possession of any article or substance found in any premises, he shall leave there, either with a responsible person or, if that is impracticable, fixed in a conspicuous position, a notice giving particulars of that article or substance sufficient to identify it and stating that he has taken possession of it under that power; and before taking possession of any such substance under that power an inspector shall, if it is practicable for him to do so, take a sample thereof and give to a responsible person at the premises a portion of the sample marked in a manner sufficient to identify it.

Changes to legislation: Health and Safety at Work etc. Act 1974 is up to date with all changes known to be in force on or before 28 April 2021. There are changes that may be brought into force at a future date. Changes that have been made appear in the content and are referenced with annotations. (See end of Document for details) View outstanding changes

- (7) No answer given by a person in pursuance of a requirement imposed under subsection (2)(j) above shall be admissible in evidence against that person or the [^{F85}spouse or civil partner] of that person in any proceedings.
- (8) Nothing in this section shall be taken to compel the production by any person of a document of which he would on grounds of legal professional privilege be entitled to withhold production on an order for discovery in an action in the High Court or, as the case may be, on an order for the production of documents in an action in the Court of Session.
- [^{F86}(9) Nothing in this section is to be read as enabling an inspector to secure the disclosure by a telecommunications operator or postal operator of communications data without the consent of the operator.
- (10) In subsection (9) “communications data”, “postal operator” and “telecommunications operator” have the same meanings as in the Investigatory Powers Act 2016 (see sections 261 and 262 of that Act).]

Textual Amendments

- F85** Words in s. 20(7) substituted (5.12.2005) by [Civil Partnership Act 2004 \(c. 33\)](#), ss. 261(1), 263, [Sch. 27 para. 49](#); S.I. 2005/3175, [art. 2\(2\)](#)
- F86** S. 20(9)(10) inserted (22.7.2020) by [Investigatory Powers Act 2016 \(c. 25\)](#), s. 272(1), [Sch. 2 para. 1](#) (with [Sch. 9 paras. 7, 8, 10](#)); S.I. 2020/766, [reg. 2\(d\)](#)

Modifications etc. (not altering text)

- C36** Ss. 1-59 applied by S.I. 2001/2127 art. 8A 8B (as inserted (E.W.S.) (6.4.2011) by [The Health and Safety at Work etc. Act 1974 \(Application outside Great Britain\) \(Variation\) Order 2011 \(S.I. 2011/745\)](#), arts. 1(1), [3\(2\)](#))
- C115** Ss. 16-26 applied (E.W.S.) (1.10.2014) by [The Genetically Modified Organisms \(Contained Use\) Regulations 2014 \(S.I. 2014/1663\)](#), regs. 1, [30\(2\)\(a\)](#) (with [reg. 3\(1\)\(2\)](#))
- C116** Ss. 16-21 applied (with modifications) (E.W.S.) (1.6.2015) by [The Control of Major Accident Hazards Regulations 2015 \(S.I. 2015/483\)](#), regs. 1(1), [27\(1\)\(a\)](#) (with [reg. 3\(2\)](#))
- C117** Ss. 16-22 applied (E.W.S.) (19.7.2015) by [The Offshore Installations \(Offshore Safety Directive\) \(Safety Case etc.\) Regulations 2015 \(S.I. 2015/398\)](#), regs. 1, [36\(1\)\(a\)](#) (with [reg. 4\(2\)](#), [Sch. 14](#))
- C128** Ss. 18-26 applied (with modifications) (E.W.S.) (1.9.2013) by [The Biocidal Products and Chemicals \(Appointment of Authorities and Enforcement\) Regulations 2013 \(S.I. 2013/1506\)](#), regs. 2(1), [8\(1\)](#) (with [reg. 3\(4\)](#), (5), [8\(2\)-\(7\)](#), 31)
- C129** Ss. 18-28 applied (with modifications) (E.W.S.) (1.6.2015) by [The Biocidal Products and Chemicals \(Appointment of Authorities and Enforcement\) Regulations 2013 \(S.I. 2013/1506\)](#), regs. 2(2), [17\(1\)](#) (with [reg. 3\(4\)\(5\)31](#))
- C130** Ss. 18-21 applied (E.W.S.) (19.7.2015) by [The Offshore Installations \(Offshore Safety Directive\) \(Safety Case etc.\) Regulations 2015 \(S.I. 2015/398\)](#), regs. 1, [36\(8\)\(a\)](#) (with [reg. 4\(2\)](#), [Sch. 14](#))
- C155** Ss. 19, 20 applied (1.3.2014) by [The Biocidal Products and Chemicals \(Appointment of Authorities and Enforcement\) Regulations 2013 \(S.I. 2013/1506\)](#), regs. 2(4), [19](#) (with [reg. 3\(4\)\(5\)31](#))
- C156** Ss. 19-28 applied (with modifications) (E.W.S.) (1.10.2014) by [The Explosives Regulations 2014 \(S.I. 2014/1638\)](#), [reg. 1\(1\)](#), [Sch. 12 paras. 2, 3](#)
- C158** Ss. 19-28 applied (with modifications) by S.I. 2014/1638, [Sch. 12 paras. 5-7](#) (as substituted (E.W.S.) (20.4.2016) by [The Explosives Regulations 2014 \(Amendment\) Regulations 2016 \(S.I. 2016/315\)](#), [reg. 1](#), [Sch. 1](#) (with [regs. 2\(1\)](#), 15))
- C166** Ss. 19-22 applied (with modifications) (30.7.2018) by [The Cableway Installations Regulations 2018 \(S.I. 2018/816\)](#), regs. 1, [21\(1\)-\(3\)](#) (with [reg. 4](#))
- C168** S. 20 applied by S.I. 1989/840, [arts. 2-10](#)

Changes to legislation: *Health and Safety at Work etc. Act 1974 is up to date with all changes known to be in force on or before 28 April 2021. There are changes that may be brought into force at a future date. Changes that have been made appear in the content and are referenced with annotations. (See end of Document for details) View outstanding changes*

- S. 20 extended (E.W.S.) (1.10.1996) by S.I. 1996/1513, **reg. 10**
- S. 20 excluded (with saving) (E.W.S.) (1.12.1997) by S.I. 1997/1840, **regs. 7, 9**
- S. 20 applied (with modifications) (9.1.1995) by S.I. 1994/3260, **reg. 17(3)(5)**
- S. 20: power to apply conferred (E.W.S.) (28.8.1995) by 1995 c. 15, **ss. 2(4)(b), 5** (with s. 3(5))
- S. 20 applied (with modifications) (E.W.S.) (16.4.1996) by S.I. 1996/772, **reg. 17**
- S. 20 applied (with modifications) (E.W.S.) (1.3.1996) by S.I. 1996/192, **reg. 15, Sch. 14 para. 1(b)**
- S. 20 applied (with modifications) (E.W.S.) (1.7.1997) by S.I. 1997/831, **reg. 19(1)-(4), Sch. 15 para. 1(a)(b)**
- S. 20 applied (15.11.2000) by S.I. 2000/2831, **reg. 26(1)(a)**
- C169** S. 20 modified by **Gas Act 1986** (c. 44, SIF 44:2), s. 67(3), **Sch. 8 para. 6(4)**
- S. 20 applied (E.W.S.) (15.12.1999) by 1998 c. 17, **s. 8(1)**, (with s. 9(1)(2), Sch. 3 para. 5(1)); S.I. 1999/161, **art. 2(1)(2)**
- C170** S. 20 applied (with modifications) (1.1.1993) by S.I. 1992/3073, **reg. 28, Sch. 6 para. 1(b)**
- C171** S. 20 modified (6.4.1992) by S.I. 1992/711, **regs. 1(2), 28(3)(b)(5)(a)**
- C172** S. 20 extended (with modifications) (1.4.1999) by S.I. 1999/743, **reg. 20(1), (2)(3)**
- S. 20 applied (E.W.S.) (20.9.2001) by S.I. 2001/2975, **reg. 19(a)**
- S. 20 applied (E.W.S.) (24.7.2002) by S.I. 2002/1689, **reg. 14(1)(a)**
- S. 20 applied (31.3.2002) by S.I. 2002/528, **reg. 10**
- S. 20 applied (16.5.2002) by S.I. 2002/1166, **reg. 31** (with art. 37)
- C173** Ss. 18-26 applied (with modifications) (19.11.1999) by S.I. 1999/2892, **reg. 16(1)**
- C174** S. 20 applied (with modifications) (29.11.1999) by S.I. 1999/2001, **reg. 24(1), Sch. 8 para. 1(b)**
- C175** S. 20 applied (11.7.2001) by S.I. 2001/2127, **arts. 4(1), 5(1)(2), 6(1), 7(1), 8(1), 10** (with art. 11) (as amended by S.I. 2009/1750, **art. 2(2)(4)**)
- C176** S. 20 applied (with modifications) (E.W.S.) (22.3.2003 for certain purposes and 22.9.2003 otherwise) by S.I. 2003/403, **regs. 1(2), 23(2)(a)(3)**; s. 19-22 applied (with modifications) (E.W.S.) (3.5.2004) by S.I. 2004/129, **reg. 23(3)(a)**; s. 20 applied (with modifications) (E.W.S.) (9.6.2004) by S.I. 2004/1309, **reg. 17**; s. 20 applied (E.W.S.) (22.4.2005) by S.I. 2005/928, **reg. 4(2)(3)(5)(6)**; ss. 19-22 applied (2.4.2006) by S.I. 2006/397, **reg. 34**
- C177** S. 20 applied (with modifications) (E.W.S.) (the amendment coming into force in accordance with art. 1(1) of the amending S.I.) by **The Channel Tunnel (Safety) Order 2007** (S.I. 2007/3531), **art. 4(2)(3)(a)** (subject to (4)-(6)) (with art. 7)
- C178** Ss. 1-59, 80-82 applied (temp.) (5.8.2009) by **The Health and Safety at Work etc. Act 1974 (Application outside Great Britain) Order 2001** (S.I. 2001/2127), **arts. 8A, 8B** (as inserted by S.I. 2009/1750, **art. 2(3)**)
- C179** S. 20 applied in part (with modifications) (E.W.S.) (6.4.2010) by **The Rail Vehicle Accessibility (Non-Interoperable Rail System) Regulations 2010** (S.I. 2010/432), **reg. 6(2)(3)(a)**
- C180** S. 20 applied in part (with modifications) (E.W.S.) (6.4.2010) by **The Train Driving Licences and Certificates Regulations 2010** (S.I. 2010/724), **regs. 1(2), 38(2)(3)(a)**
- C181** Ss. 19-28 applied (with modifications) (E.W.S.) (4.7.2010 for certain purposes and otherwise 4.7.2013) by **The Pyrotechnic Articles (Safety) Regulations 2010** (S.I. 2010/1554), **regs. 1, 18, 37(1)**, {Sch. 4 paras. 1, 2}
- C182** S. 20 applied (with modifications) (16.1.2012) by **The Railways (Interoperability) Regulations 2011** (S.I. 2011/3066), **regs. 1(2), 39(2)(3)(a)** (with reg. 3)
- C183** S. 20 applied (with modifications) (17.8.2015) by **The Pyrotechnic Articles (Safety) Regulations 2015** (S.I. 2015/1553), **reg. 1, Sch. 8 paras. 1(c), 2**
- C184** S. 20 applied (with modifications) (E.W.S.) (8.12.2016) by **The Equipment and Protective Systems Intended for Use in Potentially Explosive Atmospheres Regulations 2016** (S.I. 2016/1107), **reg. 1(1), Sch. 4 para. 1(b)**
- C185** S. 20 applied (with modifications) (8.12.2016) by **The Pressure Equipment (Safety) Regulations 2016** (S.I. 2016/1105), **reg. 1, Sch. 8 paras. 1(b), 2** (with reg. 88)
- C186** S. 20 applied (with modifications) (8.12.2016) by **The Simple Pressure Vessels (Safety) Regulations 2016** (S.I. 2016/1092), **reg. 1, Sch. 6 paras. 1(b), 2** (with reg. 3)

Changes to legislation: *Health and Safety at Work etc. Act 1974 is up to date with all changes known to be in force on or before 28 April 2021. There are changes that may be brought into force at a future date. Changes that have been made appear in the content and are referenced with annotations. (See end of Document for details) View outstanding changes*

- C187** S. 20 applied (with modifications) (8.12.2016) by [The Lifts Regulations 2016 \(S.I. 2016/1093\)](#), reg. 1, Sch. 8 paras. 1(c), 2 (with regs. 3-5)
- C188** S. 20 applied (with modifications) (8.12.2016) by [The Electrical Equipment \(Safety\) Regulations 2016 \(S.I. 2016/1101\)](#), reg. 1, Sch. 4 paras. 1, 2 (with reg. 3)
- C189** S. 20 applied (with modifications) (21.4.2018) by [The Gas Appliances \(Enforcement\) and Miscellaneous Amendments Regulations 2018 \(S.I. 2018/389\)](#), reg. 1(1), **Sch. 2** (with reg. 2)
- C190** S. 20 applied (with modifications) (21.4.2018) by [The Personal Protective Equipment \(Enforcement\) Regulations 2018 \(S.I. 2018/390\)](#), reg. 1(1), **Sch. 2** (with reg. 2(1)-(3))

21 Improvement notices.

If an inspector is of the opinion that a person—

- (a) is contravening one or more of the relevant statutory provisions; or
- (b) has contravened one or more of those provisions in circumstances that make it likely that the contravention will continue or be repeated,

he may serve on him a notice (in this Part referred to as “an improvement notice”) stating that he is of that opinion, specifying the provision or provisions as to which he is of that opinion, giving particulars of the reasons why he is of that opinion, and requiring that person to remedy the contravention or, as the case may be, the matters occasioning it within such period (ending not earlier than the period within which an appeal against the notice can be brought under section 24) as may be specified in the notice.

Modifications etc. (not altering text)

- C36** Ss. 1-59 applied by S.I. 2001/2127 art. 8A 8B (as inserted (E.W.S.)) (6.4.2011) by [The Health and Safety at Work etc. Act 1974 \(Application outside Great Britain\) \(Variation\) Order 2011 \(S.I. 2011/745\)](#), arts. 1(1), **3(2)**
- C115** Ss. 16-26 applied (E.W.S.) (1.10.2014) by [The Genetically Modified Organisms \(Contained Use\) Regulations 2014 \(S.I. 2014/1663\)](#), regs. 1, **30(2)(a)** (with reg. 3(1)(2))
- C116** Ss. 16-21 applied (with modifications) (E.W.S.) (1.6.2015) by [The Control of Major Accident Hazards Regulations 2015 \(S.I. 2015/483\)](#), regs. 1(1), **27(1)(a)** (with reg. 3(2))
- C117** Ss. 16-22 applied (E.W.S.) (19.7.2015) by [The Offshore Installations \(Offshore Safety Directive\) \(Safety Case etc.\) Regulations 2015 \(S.I. 2015/398\)](#), regs. 1, **36(1)(a)** (with reg. 4(2), Sch. 14)
- C128** Ss. 18-26 applied (with modifications) (E.W.S.) (1.9.2013) by [The Biocidal Products and Chemicals \(Appointment of Authorities and Enforcement\) Regulations 2013 \(S.I. 2013/1506\)](#), regs. 2(1), **8(1)** (with reg. 3(4), (5), 8(2)-(7), 31)
- C129** Ss. 18-28 applied (with modifications) (E.W.S.) (1.6.2015) by [The Biocidal Products and Chemicals \(Appointment of Authorities and Enforcement\) Regulations 2013 \(S.I. 2013/1506\)](#), regs. 2(2), **17(1)** (with reg. 3(4)(5)31)
- C130** Ss. 18-21 applied (E.W.S.) (19.7.2015) by [The Offshore Installations \(Offshore Safety Directive\) \(Safety Case etc.\) Regulations 2015 \(S.I. 2015/398\)](#), regs. 1, **36(8)(a)** (with reg. 4(2), Sch. 14)
- C156** Ss. 19-28 applied (with modifications) (E.W.S.) (1.10.2014) by [The Explosives Regulations 2014 \(S.I. 2014/1638\)](#), reg. 1(1), Sch. 12 paras. 2, 3
- C158** Ss. 19-28 applied (with modifications) by S.I. 2014/1638, Sch. 12 paras. 5-7 (as substituted (E.W.S.)) (20.4.2016) by [The Explosives Regulations 2014 \(Amendment\) Regulations 2016 \(S.I. 2016/315\)](#), reg. 1, **Sch. 1** (with regs. 2(1), 15))
- C166** Ss. 19-22 applied (with modifications) (30.7.2018) by [The Cableway Installations Regulations 2018 \(S.I. 2018/816\)](#), regs. 1, **21(1)-(3)** (with reg. 4)
- C191** S. 21 applied by S.I. 1989/840, arts. 2-10
 S. 21 extended (E.W.S.) (1.10.1996) by S.I. 1996/1513, **reg. 10**

Changes to legislation: *Health and Safety at Work etc. Act 1974 is up to date with all changes known to be in force on or before 28 April 2021. There are changes that may be brought into force at a future date. Changes that have been made appear in the content and are referenced with annotations. (See end of Document for details) View outstanding changes*

- S. 21 excluded (with saving) (E.W.S.) (1.12.1997) by S.I. 1997/1840, **regs. 7, 9**
- S. 21 applied (with modifications) (9.1.1995) by S.I. 1994/3260, **reg. 17(3)(5)**
- S. 21: power to apply conferred (E.W.S.) (28.8.1995) by 1995 c. 15, **ss. 2(4)(c), 5** (with s. 3(5))
- S. 21 applied (with modifications) (E.W.S.) (16.4.1996) by S.I. 1996/772, **reg. 17**
- S. 21 applied (with modifications) (E.W.S.) (1.3.1996) by S.I. 1996/192, **reg. 15, Sch. 14 para. 1(b)**
- S. 21** applied (with modifications) (E.W.S.) (1.7.1997) by S.I. 1997/831, **reg. 19(1)-(4), Sch. 15 para. 1(a)(b)**
- S. 21 applied (15.11.2000) by S.I. 2000/2831, **reg. 26(1)(a)**
- C192** S. 21 applied (with modifications) (1.1.1993) by S.I. 1992/3073, **reg. 28, Sch. 6, para. 1(b)**
- S. 21 applied (with modifications) (9.1.1995) by S.I. 1994/3260, **reg. 13(1)**
- C193** S. 21 modified (6.4.1992) by S.I. 1992/711, **reg. 28(3)(b)(5)(a)**
- S. 21 modified (E.W.S.) (1.4.1996) by 1995 c. 25, s. 120(1), **Sch. 22 para. 30(4)** (with ss. 7(6), 115, 117); S.I. 1996/186, **art. 3**
- C194** S. 21 extended (with modifications) (1.4.1999) by S.I. 1999/743, **reg. 20(1)-(3)**
- S. 21 applied (E.W.S.) (20.9.2001) by S.I. 2001/2975, **reg. 19(a)**
- S. 21 applied (E.W.S.) (24.7.2002) by S.I. 2002/1689, **reg. 14(1)(a)**
- S. 21 applied (31.3.2002) by S.I. 2002/528, **reg. 10**
- S. 21 applied (16.5.2002) by S.I. 2002/1166, **reg. 31** (with art. 37)
- C195** S. 21 applied (1.4.1999) by S.I. 1999/743, **reg. 20(5)**
- C196** S. 21 applied (with modifications) (19.11.1999) by S.I. 1999/2892, **reg. 16(1)**
- C197** S. 21 applied (with modifications) (29.11.1999) by S.I. 1999/2001, **reg. 24(1), Sch. 8 para. 1(b)**
- C198** S. 21 applied (11.7.2001) by S.I. 2001/2127, **arts. 4(1), 5(1)(2), 6(1), 7(1), 8(1), 10** (with art. 11) (as amended by S.I. 2009/1750, **art. 2(2)(4)**)
- C199** S. 19-22 applied (with modifications) (E.W.S.) (3.5.2004) by S.I. 2004/129, **reg. 23(3)(a)** ; s. 21 applied (with modifications) (E.W.S.) (9.6.2004) by S.I. 2004/1309, **reg. 17**; ss. 19-22 applied (2.4.2006) by S.I. 2006/397, **reg. 34**
- C200** S. 21 applied (with modifications) (E.W.S.) (the amendment coming into force in accordance with art. 1(1) of the amending S.I.) by The Channel Tunnel (Safety) Order 2007 (S.I. 2007/3531), **art. 4(2)(3)(b)** (subject to (4)-(6)) (with art. 7)
- C201** Ss. 1-59, 80-82 applied (temp.) (5.8.2009) by The Health and Safety at Work etc. Act 1974 (Application outside Great Britain) Order 2001 (S.I. 2001/2127), **arts. 8A, 8B** (as inserted by S.I. 2009/1750, **art. 2(3)**)
- C202** S. 21 applied (with modifications) (E.W.S.) (6.4.2010) by The Rail Vehicle Accessibility (Non-Interoperable Rail System) Regulations 2010 (S.I. 2010/432), **reg. 6(2)(3)(b)**
- C203** S. 21 applied (with modifications) (E.W.S.) (6.4.2010) by The Train Driving Licences and Certificates Regulations 2010 (S.I. 2010/724), **regs. 1(2), 38(2)(3)(b)**
- C204** Ss. 19-28 applied (with modifications) (E.W.S.) (4.7.2010 for certain purposes and otherwise 4.7.2013) by The Pyrotechnic Articles (Safety) Regulations 2010 (S.I. 2010/1554), **regs. 1, 18, 37(1)**, {Sch. 4 paras. 1, 2}
- C205** S. 21 applied (with modifications) (16.1.2012) by The Railways (Interoperability) Regulations 2011 (S.I. 2011/3066), **regs. 1(2), 39(2)(3)(b)** (with reg. 3)
- C206** S. 21 applied (1.3.2014) by The Biocidal Products and Chemicals (Appointment of Authorities and Enforcement) Regulations 2013 (S.I. 2013/1506), **regs. 2(4), 19** (with reg. 3(4)(5)31)
- C207** S. 21 applied (with modifications) (17.8.2015) by The Pyrotechnic Articles (Safety) Regulations 2015 (S.I. 2015/1553), **reg. 1, Sch. 8 paras. 1(d), 2**
- C208** S. 21 applied (with modifications) (E.W.S.) (8.12.2016) by The Equipment and Protective Systems Intended for Use in Potentially Explosive Atmospheres Regulations 2016 (S.I. 2016/1107), **reg. 1(1), Sch. 4 para. 1(c)**
- C209** S. 21 applied (with modifications) (8.12.2016) by The Pressure Equipment (Safety) Regulations 2016 (S.I. 2016/1105), **reg. 1, Sch. 8 paras. 1(c), 2** (with reg. 88)
- C210** S. 21 applied (with modifications) (8.12.2016) by The Electrical Equipment (Safety) Regulations 2016 (S.I. 2016/1101), **reg. 1, Sch. 4 paras. 1, 2** (with reg. 3)

Changes to legislation: *Health and Safety at Work etc. Act 1974 is up to date with all changes known to be in force on or before 28 April 2021. There are changes that may be brought into force at a future date. Changes that have been made appear in the content and are referenced with annotations. (See end of Document for details) View outstanding changes*

- C211** S. 21 applied (with modifications) (8.12.2016) by [The Lifts Regulations 2016 \(S.I. 2016/1093\)](#), reg. 1, Sch. 8 paras. 1(d), 2 (with regs. 3-5)
- C212** S. 21 applied (with modifications) (8.12.2016) by [The Simple Pressure Vessels \(Safety\) Regulations 2016 \(S.I. 2016/1092\)](#), reg. 1, Sch. 6 paras. 1(c), 2 (with reg. 3)
- C213** S. 21 applied (with modifications) (21.4.2018) by [The Gas Appliances \(Enforcement\) and Miscellaneous Amendments Regulations 2018 \(S.I. 2018/389\)](#), reg. 1(1), **Sch. 2** (with reg. 2)
- C214** S. 21 applied (with modifications) (21.4.2018) by [The Personal Protective Equipment \(Enforcement\) Regulations 2018 \(S.I. 2018/390\)](#), reg. 1(1), **Sch. 2** (with reg. 2(1)-(3))

22 Prohibition notices.

- (1) This section applies to any activities which are being or are [^{F87}likely] to be carried on by or under the control of any person, being activities to or in relation to which any of the relevant statutory provisions apply or will, if the activities are so carried on, apply.
- (2) If as regards any activities to which this section applies an inspector is of the opinion that, as carried on or [^{F87}likely] to be carried on by or under the control of the person in question, the activities involve or, as the case may be, will involve a risk of serious personal injury, the inspector may serve on that person a notice (in this Part referred to as “a prohibition notice”).
- (3) A prohibition notice shall—
- (a) state that the inspector is of the said opinion;
 - (b) specify the matters which in his opinion give or, as the case may be, will give rise to the said risk;
 - (c) where in his opinion any of those matters involves or, as the case may be, will involve a contravention of any of the relevant statutory provisions, state that he is of that opinion, specify the provision or provisions as to which he is of that opinion, and give particulars of the reasons why he is of that opinion; and
 - (d) direct that the activities to which the notice relates shall not be carried on by or under the control of the person on whom the notice is served unless the matters specified in the notice in pursuance of paragraph (b) above and any associated contraventions of provisions so specified in pursuance of paragraph (c) above have been remedied.
- [^{F88}(4) A direction contained in a prohibition notice in pursuance of subsection (3)(d) above shall take effect—
- (a) at the end of the period specified in the notice; or
 - (b) if the notice so declares, immediately.]

Textual Amendments

- F87** Word substituted by [Consumer Protection Act 1987 \(c. 43, SIF 109:1\)](#), s. 36, **Sch. 3 para. 2(a)**
- F88** S. 22(4) substituted by [Consumer Protection Act 1987 \(c. 43, SIF 109:1\)](#), s. 36, **Sch. 3 para. 2(b)**

Modifications etc. (not altering text)

- C36** Ss. 1-59 applied by S.I. 2001/2127 art. 8A 8B (as inserted (E.W.S.) (6.4.2011) by [The Health and Safety at Work etc. Act 1974 \(Application outside Great Britain\) \(Variation\) Order 2011 \(S.I. 2011/745\)](#), arts. 1(1), **3(2)**)
- C115** Ss. 16-26 applied (E.W.S.) (1.10.2014) by [The Genetically Modified Organisms \(Contained Use\) Regulations 2014 \(S.I. 2014/1663\)](#), regs. 1, **30(2)(a)** (with reg. 3(1)(2))

Changes to legislation: *Health and Safety at Work etc. Act 1974 is up to date with all changes known to be in force on or before 28 April 2021. There are changes that may be brought into force at a future date. Changes that have been made appear in the content and are referenced with annotations. (See end of Document for details) View outstanding changes*

- C117** Ss. 16-22 applied (E.W.S.) (19.7.2015) by [The Offshore Installations \(Offshore Safety Directive\) \(Safety Case etc.\) Regulations 2015 \(S.I. 2015/398\)](#), regs. 1, **36(1)(a)** (with reg. 4(2), Sch. 14)
- C128** Ss. 18-26 applied (with modifications) (E.W.S.) (1.9.2013) by [The Biocidal Products and Chemicals \(Appointment of Authorities and Enforcement\) Regulations 2013 \(S.I. 2013/1506\)](#), regs. 2(1), **8(1)** (with reg. 3(4), (5), 8(2)-(7), 31)
- C129** Ss. 18-28 applied (with modifications) (E.W.S.) (1.6.2015) by [The Biocidal Products and Chemicals \(Appointment of Authorities and Enforcement\) Regulations 2013 \(S.I. 2013/1506\)](#), regs. 2(2), **17(1)** (with reg. 3(4)(5)31)
- C156** Ss. 19-28 applied (with modifications) (E.W.S.) (1.10.2014) by [The Explosives Regulations 2014 \(S.I. 2014/1638\)](#), reg. 1(1), Sch. 12 paras. 2, 3
- C158** Ss. 19-28 applied (with modifications) by S.I. 2014/1638, Sch. 12 paras. 5-7 (as substituted (E.W.S.) (20.4.2016) by [The Explosives Regulations 2014 \(Amendment\) Regulations 2016 \(S.I. 2016/315\)](#), reg. 1, **Sch. 1** (with regs. 2(1), 15))
- C166** Ss. 19-22 applied (with modifications) (30.7.2018) by [The Cableway Installations Regulations 2018 \(S.I. 2018/816\)](#), regs. 1, **21(1)-(3)** (with reg. 4)
- C215** S. 22 applied by S.I. 1989/840, **arts. 2-10**
 S. 22 excluded (with saving) (E.W.S.) (1.12.1997) by S.I. 1997/1840, **regs. 7, 9**
 S. 22 applied (with modifications) (9.1.1995) by S.I. 1994/3260, **reg. 17(3)(5)**
 S. 22: power to apply conferred (E.W.S.) (28.8.1995) by 1995 c. 15, **ss. 2(4)(c)**, 5 (with s. 3(5))
 S. 22 applied (with modifications) (E.W.S.) (16.4.1996) by S.I. 1996/772, **reg. 17**
 S. 22 applied (with modifications) (E.W.S.) (1.3.1996) by S.I. 1996/192, reg. 15, **Sch. 14 para. 1(b)**
S. 22 applied (with modifications) (E.W.S.) (1.7.1997) by S.I. 1997/831, reg. 19(1)-(4), **Sch. 15 para. 1(a)(b)**
 S. 22 applied (15.11.2000) by S.I. 2000/2831, **reg. 26(1)(a)**
- C216** S. 22 applied (with modifications) (1.1.1993) by S.I. 1992/3073, reg. 28, **Sch. 6 para. 1(b)**
 S. 21 applied (with modifications) (9.1.1995) by S.I. 1994/3260, **reg. 13(1)**
- C217** S. 22 modified (6.4.1992) by S.I. 1992/711, **regs. 1(2)**, 28(3)(b)(5)(a)
 S. 22 modified (E.W.S.) (1.4.1996) by 1995 c. 25, s. 120(1), **Sch. 22 para. 30(4)** (with ss. 7(6), 115, 117); S.I. 1996/186, **art. 3**
 S. 22 applied (E.W.S.) (24.7.2002) by S.I. 2002/1689, **reg. 14(1)(a)**
 S. 22 applied (31.3.2002) by S.I. 2002/528, **reg. 10**
 S. 22 applied (16.5.2002) by S.I. 2002/1166, **reg. 31** (with art. 37)
- C218** S. 22 applied (with modifications) (19.11.1999) by S.I. 1999/2892, **reg. 16(1)**
- C219** S. 22 applied (with modifications) (29.11.1999) by S.I. 1999/2001, reg. 24(1), **Sch. 8 para. 1(b)**
- C220** S. 22 applied (11.7.2001) by S.I. 2001/2127, **arts. 4(1)**, 5(1)(2), 6(1), 7(1), 8(1), 10 (with art. 11) (as amended by S.I. 2009/1750, **art. 2(2)(4)**)
- C221** S. 19-22 applied (with modifications) (E.W.S.) (3.5.2004) by S.I. 2004/129, **reg. 23(3)(a)**; s. 22 applied (with modifications) (E.W.S.) (9.6.2004) by S.I. 2004/1309, **reg. 17**; ss. 19-22 applied (2.4.2006) by S.I. 2006/397, **reg. 34**
- C222** S. 22 applied (with modifications) (E.W.S.) (the amendment coming into force in accordance with art. 1(1) of the amending S.I.) by [The Channel Tunnel \(Safety\) Order 2007 \(S.I. 2007/3531\)](#), **art. 4(2)(3)(b)** (subject to (4)-(6)) (with art. 7)
- C223** Ss. 1-59, 80-82 applied (temp.) (5.8.2009) by [The Health and Safety at Work etc. Act 1974 \(Application outside Great Britain\) Order 2001 \(S.I. 2001/2127\)](#), arts. 8A, 8B (as inserted by S.I. 2009/1750, **art. 2(3)**)
- C224** S. 22 applied (with modifications) (E.W.S.) (6.4.2010) by [The Rail Vehicle Accessibility \(Non-Interoperable Rail System\) Regulations 2010 \(S.I. 2010/432\)](#), **reg. 6(2)(3)(b)**
- C225** S. 22 applied (with modifications) (E.W.S.) (6.4.2010) by [The Train Driving Licences and Certificates Regulations 2010 \(S.I. 2010/724\)](#), regs. 1(2), **38(2)(3)(b)**
- C226** Ss. 19-28 applied (with modifications) (E.W.S.) (4.7.2010 for certain purposes and otherwise 4.7.2013) by [The Pyrotechnic Articles \(Safety\) Regulations 2010 \(S.I. 2010/1554\)](#), **regs. 1, 18, 37(1)**, {Sch. 4 paras. 1, 2}

Changes to legislation: *Health and Safety at Work etc. Act 1974 is up to date with all changes known to be in force on or before 28 April 2021. There are changes that may be brought into force at a future date. Changes that have been made appear in the content and are referenced with annotations. (See end of Document for details) View outstanding changes*

- C227** S. 22 applied (with modifications) (16.1.2012) by [The Railways \(Interoperability\) Regulations 2011 \(S.I. 2011/3066\)](#), regs. 1(2), **39(2)(3)(b)** (with reg. 3)
- C228** S. 22 applied (E.W.S.) (19.7.2015) by [The Offshore Installations \(Offshore Safety Directive\) \(Safety Case etc.\) Regulations 2015 \(S.I. 2015/398\)](#), regs. 1, **36(7)** (with reg. 4(2), Sch. 14)
- C229** S. 22 applied (with modifications) (17.8.2015) by [The Pyrotechnic Articles \(Safety\) Regulations 2015 \(S.I. 2015/1553\)](#), reg. 1, Sch. 8 paras. 1(e), **2**
- C230** S. 22 applied (with modifications) (8.12.2016) by [The Simple Pressure Vessels \(Safety\) Regulations 2016 \(S.I. 2016/1092\)](#), reg. 1, Sch. 6 paras. 1(d), **2** (with reg. 3)
- C231** S. 22 applied (with modifications) (8.12.2016) by [The Electrical Equipment \(Safety\) Regulations 2016 \(S.I. 2016/1101\)](#), reg. 1, Sch. 4 paras. 1, **2** (with reg. 3)
- C232** S. 22 applied (with modifications) (8.12.2016) by [The Pressure Equipment \(Safety\) Regulations 2016 \(S.I. 2016/1105\)](#), reg. 1, Sch. 8 paras. 1(d), **2** (with reg. 88)
- C233** S. 22 applied (with modifications) (E.W.S.) (8.12.2016) by [The Equipment and Protective Systems Intended for Use in Potentially Explosive Atmospheres Regulations 2016 \(S.I. 2016/1107\)](#), reg. 1(1), **Sch. 4 para. 1(d)**
- C234** S. 22 applied (with modifications) (8.12.2016) by [The Lifts Regulations 2016 \(S.I. 2016/1093\)](#), reg. 1, Sch. 8 paras. 1(e), **2** (with regs. 3-5)
- C235** S. 22 applied (with modifications) (21.4.2018) by [The Personal Protective Equipment \(Enforcement\) Regulations 2018 \(S.I. 2018/390\)](#), reg. 1(1), **Sch. 2** (with reg. 2(1)-(3))
- C236** S. 22 applied (with modifications) (21.4.2018) by [The Gas Appliances \(Enforcement\) and Miscellaneous Amendments Regulations 2018 \(S.I. 2018/389\)](#), reg. 1(1), **Sch. 2** (with reg. 2)

23 Provisions supplementary to ss. 21 and 22. E+W

- (1) In this section “a notice” means an improvement notice or a prohibition notice.
- (2) A notice may (but need not) include directions as to the measures to be taken to remedy any contravention or matter to which the notice relates; and any such directions—
 - (a) may be framed to any extent by reference to any approved code of practice; and
 - (b) may be framed so as to afford the person on whom the notice is served a choice between different ways of remedying the contravention or matter.
- (3) Where any of the relevant statutory provisions applies to a building or any matter connected with a building and an inspector proposes to serve an improvement notice relating to a contravention of that provision in connection with that building or matter, the notice shall not direct any measures to be taken to remedy the contravention of that provision which are more onerous than those necessary to secure conformity with the requirements of any building regulations for the time being in force to which that building or matter would be required to conform if the relevant building were being newly erected unless the provision in question imposes specific requirements more onerous than the requirements of any such building regulations to which the building or matter would be required to conform as aforesaid.

In this subsection “the relevant building”, in the case of a building, means that building, and, in the case of a matter connected with a building, means the building with which the matter is connected.

- (4) Before an inspector serves in connection with any premises used or about to be used as a place of work a notice requiring or likely to lead to the taking of measures affecting the means of escape in case of fire with which the premises are or ought to be provided, he shall consult the [^{F89}fire and rescue authority] .

Changes to legislation: *Health and Safety at Work etc. Act 1974 is up to date with all changes known to be in force on or before 28 April 2021. There are changes that may be brought into force at a future date. Changes that have been made appear in the content and are referenced with annotations. (See end of Document for details) View outstanding changes*

In this subsection [F89fire and rescue authority][F90], in relation to premises, means—

- (a) where the Regulatory Reform (Fire Safety) Order 2005 applies to the premises, the enforcing authority within the meaning given by article 25 of that Order;
 - (b) in any other case, the fire and rescue authority under the Fire and Rescue Services Act 2004 for the area where the premises are (or are to be) situated.]
- (5) Where an improvement notice or a prohibition notice which is not to take immediate effect has been served—
- (a) the notice may be withdrawn by an inspector at any time before the end of the period specified therein in pursuance of section 21 or section 22(4) as the case may be; and
 - (b) the period so specified may be extended or further extended by an inspector at any time when an appeal against the notice is not pending.
- (6) In the application of this section to Scotland—
- (a) in subsection (3) for the words from “with the requirements” to “aforesaid” there shall be substituted the words—
 - “(a) to any provisions of the building standards regulations to which that building or matter would be required to conform if the relevant building were being newly erected; or
 - (b) where the sheriff, on an appeal to him under section 16 of the Building (Scotland) Act 1959—
 - (i) against an order under section 10 of that Act requiring the execution of operations necessary to make the building or matter conform to the building standards regulations, or
 - (ii) against an order under section 11 of that Act requiring the building or matter to conform to a provision of such regulations,
 has varied the order, to any provisions of the building standards regulations referred to in paragraph (a) above as affected by the order as so varied,
- unless the relevant statutory provision imposes specific requirements more onerous than the requirements of any provisions of building standards regulations as aforesaid or, as the case may be, than the requirements of the order as varied by the sheriff.”;
- (b) after subsection (5) there shall be inserted the following subsection—
 - “(5A) In subsection (3) above ”building standards regulations’ has the same meaning as in section 3 of the Building (Scotland) Act 1959.”.

Extent Information

- E5** This version of this provision extends to England Wales only; separate versions have been created for Northern Ireland only and Scotland only

Changes to legislation: *Health and Safety at Work etc. Act 1974 is up to date with all changes known to be in force on or before 28 April 2021. There are changes that may be brought into force at a future date. Changes that have been made appear in the content and are referenced with annotations. (See end of Document for details) View outstanding changes*

Textual Amendments

- F89** Words in s. 23(4) substituted (E.W.) (1.10.2004 for E. and 10.11.2004 for W.) by [Fire and Rescue Services Act 2004 \(c. 21\), s. 53, Sch. 1 para. 44](#); S.I. 2004/2304, [art. 2](#), (with art. 3); S.I. 2004/2917, [art. 2](#)
- F90** S. 23(4)(a)(b) and preceding words substituted (E.W.) (1.10.2006) for words by [The Regulatory Reform \(Fire Safety\) Order 2005 \(S.I. 2005/1541\), art. 53\(1\), Sch. 2 para. 9](#) (with art. 49) (as amended by [The Regulatory Reform \(Fire Safety\) Subordinate Provisions Order 2006 \(S.I. 2006/484\), arts. 1\(1\), 2](#))

Modifications etc. (not altering text)

- C36** Ss. 1-59 applied by S.I. 2001/2127 art. 8A 8B (as inserted (E.W.S.) (6.4.2011) by [The Health and Safety at Work etc. Act 1974 \(Application outside Great Britain\) \(Variation\) Order 2011 \(S.I. 2011/745\), arts. 1\(1\), 3\(2\)](#))
- C115** Ss. 16-26 applied (E.W.S.) (1.10.2014) by [The Genetically Modified Organisms \(Contained Use\) Regulations 2014 \(S.I. 2014/1663\), regs. 1, 30\(2\)\(a\)](#) (with reg. 3(1)(2))
- C128** Ss. 18-26 applied (with modifications) (E.W.S.) (1.9.2013) by [The Biocidal Products and Chemicals \(Appointment of Authorities and Enforcement\) Regulations 2013 \(S.I. 2013/1506\), regs. 2\(1\), 8\(1\)](#) (with reg. 3(4), (5), 8(2)-(7), 31)
- C129** Ss. 18-28 applied (with modifications) (E.W.S.) (1.6.2015) by [The Biocidal Products and Chemicals \(Appointment of Authorities and Enforcement\) Regulations 2013 \(S.I. 2013/1506\), regs. 2\(2\), 17\(1\)](#) (with reg. 3(4)(5)31)
- C156** Ss. 19-28 applied (with modifications) (E.W.S.) (1.10.2014) by [The Explosives Regulations 2014 \(S.I. 2014/1638\), reg. 1\(1\), Sch. 12 paras. 2, 3](#)
- C158** Ss. 19-28 applied (with modifications) by S.I. 2014/1638, Sch. 12 paras. 5-7 (as substituted (E.W.S.) (20.4.2016) by [The Explosives Regulations 2014 \(Amendment\) Regulations 2016 \(S.I. 2016/315\), reg. 1, Sch. 1](#) (with regs. 2(1), 15))
- C237** S. 23 applied by [S.I. 1989/840, arts. 2-10](#)
 S. 23 excluded (with saving) (E.W.S.) (1.12.1997) by [S.I. 1997/1840, regs. 7, 9](#) S. 23 extended (E.W.S.) (1.10.1996) by [S.I. 1996/1513, reg. 10](#)
 S. 23: power to apply conferred (E.W.S.) (28.8.1995) by [1995 c. 15, ss. 2\(4\)\(c\), 5](#) (with s. 3(5))
 S. 23 applied (with modifications) (E.W.S.) (16.4.1996) by [S.I. 1996/772, reg. 17](#)
 S. 23 applied (with modifications) (E.W.S.) (1.3.1996) by [S.I. 1996/192, reg. 15, Sch. 14 para. 1\(b\)](#)
 S. 23 applied (with modifications) (E.W.S.) (1.7.1997) by [S.I. 1997/831, reg. 19\(1\)-\(4\), Sch. 15 para. 1\(a\)\(b\)](#) [Ss. 23](#) applied (15.11.2000) by [S.I. 2000/2831, reg. 26\(1\)\(a\)](#)
 Ss. 23 applied (E.W.S.) (24.7.2002) by [S.I. 2002/1689, reg. 14\(1\)\(a\)](#)
 S. 23 applied (31.3.2002) by [S.I. 2002/528, reg. 10](#)
 S. 23 applied (16.5.2002) by [S.I. 2002/1166, reg. 31](#) (with art. 37)
- C238** S. 23 applied (with modifications) (1.1.1993) by [S.I. 1992/3073, reg. 28, Sch. 6 para. 1\(b\)](#)
- C239** Ss. 19-28 modified (6.4.1992) by [S.I. 1992/711, regs. 1\(2\), 28\(3\)\(b\)\(5\)\(a\)](#)
 S. 23 modified (E.W.S.) (1.4.1996) by [1995 c. 25, s. 120\(1\), Sch. 22 para. 30\(4\)](#) (with ss. 7(6), 115, 117); [S.I. 1996/186, art. 3](#)
- C240** S. 23 extended (with modifications) (1.4.1999) by [S.I. 1999/743, reg. 20\(1\)\(b\), \(2\)\(3\)](#)
- C241** Ss. 23 extended (19.11.1999) by [S.I. 1999/2892, reg. 16\(1\)](#)
- C242** S. 23 applied (with modifications) (29.11.1999) by [S.I. 1999/2001, reg. 24\(1\), Sch. 8 para. 1\(b\)](#)
- C243** S. 23 applied (11.7.2001) by [S.I. 2001/2127, arts. 4\(1\), 5\(1\)\(2\), 6\(1\), 7\(1\), 8\(1\), 10](#) (with art. 11) (as amended by [S.I. 2009/1750, art. 2\(2\)\(4\)](#))
- C244** S. 23 applied (E.W.S.) (20.9.2001) by [S.I. 2001/2975, reg. 19\(b\)](#)
- C245** S. 23 applied (with modifications) (3.5.2004) by [The Cableway Installations Regulations 2004 \(S.I. 2004/129\), reg. 23\(3\)\(b\)](#)
- C246** S. 23 applied (with modifications) (9.6.2004) by [S.I. 2004/1309, reg. 17](#); s. 23 applied (E.W.S.) (2.4.2006) by [S.I. 2006/397, reg. 34](#)

Changes to legislation: *Health and Safety at Work etc. Act 1974 is up to date with all changes known to be in force on or before 28 April 2021. There are changes that may be brought into force at a future date. Changes that have been made appear in the content and are referenced with annotations. (See end of Document for details) View outstanding changes*

- C247** S. 23 applied (with modifications) (E.W.S.) (the amendment coming into force in accordance with art. 1(1) of the amending S.I.) by **The Channel Tunnel (Safety) Order 2007 (S.I. 2007/3531), art. 4(2)(3)(c)** (subject to (4)-(6)) (with art. 7)
- C248** Ss. 1-59, 80-82 applied (temp.) (5.8.2009) by **The Health and Safety at Work etc. Act 1974 (Application outside Great Britain) Order 2001 (S.I. 2001/2127), arts. 8A, 8B** (as inserted by S.I. 2009/1750, **art. 2(3)**)
- C249** S. 23 applied in part (with modifications) (E.W.S.) (6.4.2010) by **The Rail Vehicle Accessibility (Non-Interoperable Rail System) Regulations 2010 (S.I. 2010/432), reg. 6(2)(3)(c)**
- C250** S. 23 applied in part (with modifications) (E.W.S.) (6.4.2010) by **The Train Driving Licences and Certificates Regulations 2010 (S.I. 2010/724), regs. 1(2), 38(2)(3)(c)**
- C251** Ss. 19-28 applied (with modifications) (E.W.S.) (4.7.2010 for certain purposes and otherwise 4.7.2013) by **The Pyrotechnic Articles (Safety) Regulations 2010 (S.I. 2010/1554), regs. 1, 18, 37(1), {Sch. 4 paras. 1, 2}**
- C252** S. 23 applied (with modifications) (16.1.2012) by **The Railways (Interoperability) Regulations 2011 (S.I. 2011/3066), regs. 1(2), 39(2)(3)(c)** (with reg. 3)
- C253** Ss. 23, 24 applied (1.3.2014) by **The Biocidal Products and Chemicals (Appointment of Authorities and Enforcement) Regulations 2013 (S.I. 2013/1506), regs. 2(4), 19** (with reg. 3(4)(5)(31))
- C254** S. 23 applied (with modifications) (E.W.S.) (1.6.2015) by **The Control of Major Accident Hazards Regulations 2015 (S.I. 2015/483), regs. 1(1), 27(1)(b)** (with regs. 3(2), 27(3))
- C255** S. 23 applied (19.7.2015) by **The Offshore Installations (Offshore Safety Directive) (Safety Case etc.) Regulations 2015 (S.I. 2015/398), regs. 1, 36(8)(b)** (with reg. 4(2), Sch. 14)
- C256** S. 23 applied (19.7.2015) by **The Offshore Installations (Offshore Safety Directive) (Safety Case etc.) Regulations 2015 (S.I. 2015/398), regs. 1, 36(1)(b)** (with reg. 4(2), Sch. 14)
- C257** S. 23 applied (with modifications) (17.8.2015) by **The Pyrotechnic Articles (Safety) Regulations 2015 (S.I. 2015/1553), reg. 1, Sch. 8 paras. 1(f), 2**
- C258** S. 23 applied (with modifications) (8.12.2016) by **The Simple Pressure Vessels (Safety) Regulations 2016 (S.I. 2016/1092), reg. 1, Sch. 6 paras. 1(e), 2** (with reg. 3)
- C259** S. 23 applied (with modifications) (E.W.S.) (8.12.2016) by **The Equipment and Protective Systems Intended for Use in Potentially Explosive Atmospheres Regulations 2016 (S.I. 2016/1107), reg. 1(1), Sch. 4 para. 1(e)**
- C260** S. 23 applied (with modifications) (8.12.2016) by **The Lifts Regulations 2016 (S.I. 2016/1093), reg. 1, Sch. 8 paras. 1(f), 2** (with regs. 3-5)
- C261** S. 23 applied (with modifications) (8.12.2016) by **The Electrical Equipment (Safety) Regulations 2016 (S.I. 2016/1101), reg. 1, Sch. 4 paras. 1, 2** (with reg. 3)
- C262** S. 23 applied (with modifications) (8.12.2016) by **The Pressure Equipment (Safety) Regulations 2016 (S.I. 2016/1105), reg. 1, Sch. 8 paras. 1(e), 2** (with reg. 88)
- C263** S. 23 applied (with modifications) (21.4.2018) by **The Personal Protective Equipment (Enforcement) Regulations 2018 (S.I. 2018/390), reg. 1(1), Sch. 2** (with reg. 2(1)-(3))
- C264** S. 23 applied (with modifications) (21.4.2018) by **The Gas Appliances (Enforcement) and Miscellaneous Amendments Regulations 2018 (S.I. 2018/389), reg. 1(1), Sch. 2** (with reg. 2)
- C265** S. 23 applied (with modifications) (30.7.2018) by **The Cableway Installations Regulations 2018 (S.I. 2018/816), regs. 1, 21(1)-(3)** (with reg. 4)
- C266** S. 23(1) applied (with modifications) (9.1.1995) by S.I. 1994/3260, **reg. 17(3)(5)**
- C267** S. 23(2) applied (with modifications) (9.1.1995) by S.I. 1994/3260, **reg. 17(3)(5)**
- C268** S. 23(4) applied (with modifications) (1.4.1999) by S.I. 1999/743, **reg. 20(5)**
- C269** S. 23(5) applied (with modifications) (9.1.1995) by S.I. 1994/3260, **reg. 17(3)(5)**

23 Provisions supplementary to ss. 21 and 22. **N.I.**

(1) In this section “a notice” means an improvement notice or a prohibition notice.

Changes to legislation: *Health and Safety at Work etc. Act 1974 is up to date with all changes known to be in force on or before 28 April 2021. There are changes that may be brought into force at a future date. Changes that have been made appear in the content and are referenced with annotations. (See end of Document for details) View outstanding changes*

- (2) A notice may (but need not) include directions as to the measures to be taken to remedy any contravention or matter to which the notice relates; and any such directions—
- (a) may be framed to any extent by reference to any approved code of practice; and
 - (b) may be framed so as to afford the person on whom the notice is served a choice between different ways of remedying the contravention or matter.
- (3) Where any of the relevant statutory provisions applies to a building or any matter connected with a building and an inspector proposes to serve an improvement notice relating to a contravention of that provision in connection with that building or matter, the notice shall not direct any measures to be taken to remedy the contravention of that provision which are more onerous than those necessary to secure conformity with the requirements of any building regulations for the time being in force to which that building or matter would be required to conform if the relevant building were being newly erected unless the provision in question imposes specific requirements more onerous than the requirements of any such building regulations to which the building or matter would be required to conform as aforesaid.

In this subsection “the relevant building”, in the case of a building, means that building, and, in the case of a matter connected with a building, means the building with which the matter is connected.

- (4) Before an inspector serves in connection with any premises used or about to be used as a place of work a notice requiring or likely to lead to the taking of measures affecting the means of escape in case of fire with which the premises are or ought to be provided, he shall consult the fire authority.

In this subsection “fire authority” has the meaning assigned by section 43(1) of the ^{M31}Fire Precautions Act 1971.

- (5) Where an improvement notice or a prohibition notice which is not to take immediate effect has been served—
- (a) the notice may be withdrawn by an inspector at any time before the end of the period specified therein in pursuance of section 21 or section 22(4) as the case may be; and
 - (b) the period so specified may be extended or further extended by an inspector at any time when an appeal against the notice is not pending.
- (6) In the application of this section to Scotland—
- (a) in subsection (3) for the words from “with the requirements” to “aforesaid” there shall be substituted the words—
 - “(a) to any provisions of the building standards regulations to which that building or matter would be required to conform if the relevant building were being newly erected; or
 - (b) where the sheriff, on an appeal to him under section 16 of the Building (Scotland) Act 1959—
 - (i) against an order under section 10 of that Act requiring the execution of operations necessary to make the building or matter conform to the building standards regulations, or
 - (ii) against an order under section 11 of that Act requiring the building or matter to conform to a provision of such regulations,

Changes to legislation: *Health and Safety at Work etc. Act 1974 is up to date with all changes known to be in force on or before 28 April 2021. There are changes that may be brought into force at a future date. Changes that have been made appear in the content and are referenced with annotations. (See end of Document for details) View outstanding changes*

has varied the order, to any provisions of the building standards regulations referred to in paragraph (a) above as affected by the order as so varied,

unless the relevant statutory provision imposes specific requirements more onerous than the requirements of any provisions of building standards regulations as aforesaid or, as the case may be, than the requirements of the order as varied by the sheriff. ”;

(b) after subsection (5) there shall be inserted the following subsection—

“(5A) In subsection (3) above ”building standards regulations’ has the same meaning as in section 3 of the Building (Scotland) Act 1959.”.

Extent Information

E12 This version of this provision extends to Northern Ireland only; separate versions have been created for England and Wales and Scotland only

Modifications etc. (not altering text)

- C36** Ss. 1-59 applied by S.I. 2001/2127 art. 8A 8B (as inserted (E.W.S.) (6.4.2011) by [The Health and Safety at Work etc. Act 1974 \(Application outside Great Britain\) \(Variation\) Order 2011 \(S.I. 2011/745\)](#), arts. 1(1), **3(2)**)
- C129** Ss. 18-28 applied (with modifications) (E.W.S.) (1.6.2015) by [The Biocidal Products and Chemicals \(Appointment of Authorities and Enforcement\) Regulations 2013 \(S.I. 2013/1506\)](#), regs. 2(2), **17(1)** (with reg. 3(4)(5)31)
- C158** Ss. 19-28 applied (with modifications) by S.I. 2014/1638, Sch. 12 paras. 5-7 (as substituted (E.W.S.) (20.4.2016) by [The Explosives Regulations 2014 \(Amendment\) Regulations 2016 \(S.I. 2016/315\)](#), reg. 1, **Sch. 1** (with regs. 2(1), 15))
- C240** S. 23 extended (with modifications) (1.4.1999) by S.I. 1999/743, **reg. 20(1)(b)**, (2)(3)
- C245** S. 23 applied (with modifications) (3.5.2004) by [The Cableway Installations Regulations 2004 \(S.I. 2004/129\)](#), **reg. 23(3)(b)**
- C246** S. 23 applied (with modifications) (9.6.2004) by S.I. 2004/1309, **reg. 17**; s. 23 applied (E.W.S) (2.4.2006) by S.I. 2006/397, **reg. 34**
- C248** Ss. 1-59, 80-82 applied (temp.) (5.8.2009) by [The Health and Safety at Work etc. Act 1974 \(Application outside Great Britain\) Order 2001 \(S.I. 2001/2127\)](#), arts. 8A, 8B (as inserted by S.I. 2009/1750, **art. 2(3)**)
- C252** S. 23 applied (with modifications) (16.1.2012) by [The Railways \(Interoperability\) Regulations 2011 \(S.I. 2011/3066\)](#), regs. 1(2), **39(2)(3)(c)** (with reg. 3)
- C253** Ss. 23, 24 applied (1.3.2014) by [The Biocidal Products and Chemicals \(Appointment of Authorities and Enforcement\) Regulations 2013 \(S.I. 2013/1506\)](#), regs. 2(4), **19** (with reg. 3(4)(5)31)
- C254** S. 23 applied (with modifications) (E.W.S.) (1.6.2015) by [The Control of Major Accident Hazards Regulations 2015 \(S.I. 2015/483\)](#), regs. 1(1), **27(1)(b)** (with regs. 3(2), 27(3))
- C255** S. 23 applied (19.7.2015) by [The Offshore Installations \(Offshore Safety Directive\) \(Safety Case etc.\) Regulations 2015 \(S.I. 2015/398\)](#), regs. 1, **36(8)(b)** (with reg. 4(2), Sch. 14)
- C256** S. 23 applied (19.7.2015) by [The Offshore Installations \(Offshore Safety Directive\) \(Safety Case etc.\) Regulations 2015 \(S.I. 2015/398\)](#), regs. 1, **36(1)(b)** (with reg. 4(2), Sch. 14)
- C257** S. 23 applied (with modifications) (17.8.2015) by [The Pyrotechnic Articles \(Safety\) Regulations 2015 \(S.I. 2015/1553\)](#), reg. 1, Sch. 8 paras. 1(f), **2**
- C258** S. 23 applied (with modifications) (8.12.2016) by [The Simple Pressure Vessels \(Safety\) Regulations 2016 \(S.I. 2016/1092\)](#), reg. 1, Sch. 6 paras. 1(e), **2** (with reg. 3)
- C260** S. 23 applied (with modifications) (8.12.2016) by [The Lifts Regulations 2016 \(S.I. 2016/1093\)](#), reg. 1, Sch. 8 paras. 1(f), **2** (with regs. 3-5)

Changes to legislation: *Health and Safety at Work etc. Act 1974 is up to date with all changes known to be in force on or before 28 April 2021. There are changes that may be brought into force at a future date. Changes that have been made appear in the content and are referenced with annotations. (See end of Document for details) View outstanding changes*

- C261** S. 23 applied (with modifications) (8.12.2016) by [The Electrical Equipment \(Safety\) Regulations 2016 \(S.I. 2016/1101\)](#), [reg. 1, Sch. 4 paras. 1, 2](#) (with [reg. 3](#))
- C262** S. 23 applied (with modifications) (8.12.2016) by [The Pressure Equipment \(Safety\) Regulations 2016 \(S.I. 2016/1105\)](#), [reg. 1, Sch. 8 paras. 1\(e\), 2](#) (with [reg. 88](#))
- C263** S. 23 applied (with modifications) (21.4.2018) by [The Personal Protective Equipment \(Enforcement\) Regulations 2018 \(S.I. 2018/390\)](#), [reg. 1\(1\), Sch. 2](#) (with [reg. 2\(1\)-\(3\)](#))
- C264** S. 23 applied (with modifications) (21.4.2018) by [The Gas Appliances \(Enforcement\) and Miscellaneous Amendments Regulations 2018 \(S.I. 2018/389\)](#), [reg. 1\(1\), Sch. 2](#) (with [reg. 2](#))
- C265** S. 23 applied (with modifications) (30.7.2018) by [The Cableway Installations Regulations 2018 \(S.I. 2018/816\)](#), [regs. 1, 21\(1\)-\(3\)](#) (with [reg. 4](#))
- C268** S. 23(4) applied (with modifications) (1.4.1999) by [S.I. 1999/743](#), [reg. 20\(5\)](#)
- C830** S. 23 applied by [S.I. 1989/840](#), [arts. 2-10](#)
- S. 23 excluded (with saving) (E.W.S.) (1.12.1997) by [S.I. 1997/1840](#), [regs. 7, 9](#)
- S. 23 extended (E.W.S.) (1.10.1996) by [S.I. 1996/1513](#), [reg. 10](#)
- S. 23: power to apply conferred (E.W.S.) (28.8.1995) by [1995 c. 15, ss. 2\(4\)\(c\), 5](#) (with [s. 3\(5\)](#))
- S. 23 applied (with modifications) (E.W.S.) (16.4.1996) by [S.I. 1996/772](#), [reg. 17](#)
- S. 23 applied (with modifications) (E.W.S.) (1.3.1996) by [S.I. 1996/192](#), [reg. 15, Sch. 14 para. 1\(b\)](#)
- S. 23 applied (with modifications) (E.W.S.) (1.7.1997) by [S.I. 1997/831](#), [reg. 19\(1\)-\(4\), Sch. 15 para. 1\(a\)\(b\)](#)
- S. 23 applied (15.11.2000) by [S.I. 2000/2831](#), [reg. 26\(1\)\(a\)](#)
- S. 23 applied (E.W.S.) (24.7.2002) by [S.I. 2002/1689](#), [reg. 14\(1\)\(a\)](#)
- S. 23 applied (31.3.2002) by [S.I. 2002/528](#), [reg. 10](#)
- S. 23 applied (16.5.2002) by [S.I. 2002/1166](#), [reg. 31](#) (with [art. 37](#))
- C831** S. 23 applied (with modifications) (1.1.1993) by [S.I.1992/3073](#), [reg. 28, Sch. 6 para. 1\(b\)](#)
- C832** Ss. 19-28 modified (6.4.1992) by [S.I. 1992/711](#), [regs. 1\(2\), 28\(3\)\(b\)\(5\)\(a\)](#)
- S. 23 modified (E.W.S.) (1.4.1996) by [1995 c. 25, s. 120\(1\), Sch. 22 para. 30\(4\)](#) (with [ss. 7\(6\), 115, 117](#)); [S.I. 1996/186](#), [art. 3](#)
- C833** S. 23 extended (19.11.1999) by [S.I. 1999/2892](#), [reg. 16\(1\)](#)
- C834** S. 23 applied (with modifications) (29.11.1999) by [S.I. 1999/2001](#), [reg. 24\(1\), Sch. 8 para. 1\(b\)](#)
- C835** S. 23 applied (11.7.2001) by [S.I. 2001/2127](#), [arts. 4\(1\), 5\(1\)\(2\), 6\(1\), 7\(1\), 8\(1\), 10](#) (with [art. 11](#)) (as amended by [S.I. 2009/1750](#), [art. 2\(2\)\(4\)](#))
- C836** S. 23 applied (E.W.S.) (20.9.2001) by [S.I. 2001/2975](#), [reg. 19\(b\)](#)
- C837** S. 23(1) applied (with modifications) (9.1.1995) by [S.I. 1994/3260](#), [reg. 17\(3\)\(5\)](#)
- C838** S. 23(2) applied (with modifications) (9.1.1995) by [S.I. 1994/3260](#), [reg. 17\(3\)\(5\)](#)
- C839** S. 23(5) applied (with modifications) (9.1.1995) by [S.I. 1994/3260](#), [reg. 17\(3\)\(5\)](#)

Marginal Citations

M31 [1971 c. 40](#).

23 Provisions supplementary to ss. 21 and 22. **S**

- (1) In this section “a notice” means an improvement notice or a prohibition notice.
- (2) A notice may (but need not) include directions as to the measures to be taken to remedy any contravention or matter to which the notice relates; and any such directions—
 - (a) may be framed to any extent by reference to any approved code of practice; and
 - (b) may be framed so as to afford the person on whom the notice is served a choice between different ways of remedying the contravention or matter.
- (3) Where any of the relevant statutory provisions applies to a building or any matter connected with a building and an inspector proposes to serve an improvement notice

Changes to legislation: *Health and Safety at Work etc. Act 1974 is up to date with all changes known to be in force on or before 28 April 2021. There are changes that may be brought into force at a future date. Changes that have been made appear in the content and are referenced with annotations. (See end of Document for details) View outstanding changes*

relating to a contravention of that provision in connection with that building or matter, the notice shall not direct any measures to be taken to remedy the contravention of that provision which are more onerous than those necessary to secure conformity with the requirements of any building regulations for the time being in force to which that building or matter would be required to conform if the relevant building were being newly erected unless the provision in question imposes specific requirements more onerous than the requirements of any such building regulations to which the building or matter would be required to conform as aforesaid.

In this subsection “the relevant building”, in the case of a building, means that building, and, in the case of a matter connected with a building, means the building with which the matter is connected.

- (4) Before an inspector serves in connection with any premises used or about to be used as a place of work a notice requiring or likely to lead to the taking of measures affecting the means of escape in case of fire with which the premises are or ought to be provided, he shall consult

[^{F326}(a)]

where Part 3 of the Fire (Scotland) Act 2005 (asp 5) applies in relation to the premises, the enforcing authority (as defined in section 61(9) of that Act);

(b) in any other case, the [^{F327}Scottish Fire and Rescue Service].]

- (5) Where an improvement notice or a prohibition notice which is not to take immediate effect has been served—

(a) the notice may be withdrawn by an inspector at any time before the end of the period specified therein in pursuance of section 21 or section 22(4) as the case may be; and

(b) the period so specified may be extended or further extended by an inspector at any time when an appeal against the notice is not pending.

- (6) In the application of this section to Scotland—

(a) in subsection (3) for the words from “with the requirements” to “aforesaid” there shall be substituted the words—

“(a) to any provisions of the building standards regulations to which that building or matter would be required to conform if the relevant building were being newly erected; or

(b) where the sheriff, on an appeal to him under section 16 of the Building (Scotland) Act 1959—

(i) against an order under section 10 of that Act requiring the execution of operations necessary to make the building or matter conform to the building standards regulations, or

(ii) against an order under section 11 of that Act requiring the building or matter to conform to a provision of such regulations,

has varied the order, to any provisions of the building standards regulations referred to in paragraph (a) above as affected by the order as so varied,

unless the relevant statutory provision imposes specific requirements more onerous than the requirements of any provisions of building standards

Changes to legislation: *Health and Safety at Work etc. Act 1974 is up to date with all changes known to be in force on or before 28 April 2021. There are changes that may be brought into force at a future date. Changes that have been made appear in the content and are referenced with annotations. (See end of Document for details) View outstanding changes*

- regulations as aforesaid or, as the case may be, than the requirements of the order as varied by the sheriff. ”;
- (b) after subsection (5) there shall be inserted the following subsection—
- “(5A) In subsection (3) above ”building standards regulations’ has the same meaning as in section 3 of the Building (Scotland) Act 1959.”.

Extent Information

- E13** This version of this provision extends to Scotland only; separate versions have been created for England and Wales only and Northern Ireland only

Textual Amendments

- F326** By [The Fire \(Scotland\) Act 2005 \(Consequential Modifications and Savings\) Order 2006 \(S.I. 2006/475\)](#), [art. 2\(1\)](#), [Sch. 1 para. 6](#) it is provided (1.10.2006) that in s. 23(4) for the words from "the authority" to the end there is substituted (S.) s. 23(4)(a)(b)
- F327** Words in s. 23(4)(b) substituted (S.) (1.4.2013) by [Police and Fire Reform \(Scotland\) Act 2012 \(asp 8\)](#), s. 129(2), [Sch. 7 para. 49](#); S.S.I. 2013/51, [art. 2](#) (with transitional provisions and savings in S.S.I. 2013/121)

Modifications etc. (not altering text)

- C36** Ss. 1-59 applied by S.I. 2001/2127 art. 8A 8B (as inserted (E.W.S.) (6.4.2011) by [The Health and Safety at Work etc. Act 1974 \(Application outside Great Britain\) \(Variation\) Order 2011 \(S.I. 2011/745\)](#), [arts. 1\(1\)](#), [3\(2\)](#))
- C115** Ss. 16-26 applied (E.W.S.) (1.10.2014) by [The Genetically Modified Organisms \(Contained Use\) Regulations 2014 \(S.I. 2014/1663\)](#), [regs. 1](#), [30\(2\)\(a\)](#) (with [reg. 3\(1\)\(2\)](#))
- C128** Ss. 18-26 applied (with modifications) (E.W.S.) (1.9.2013) by [The Biocidal Products and Chemicals \(Appointment of Authorities and Enforcement\) Regulations 2013 \(S.I. 2013/1506\)](#), [regs. 2\(1\)](#), [8\(1\)](#) (with [reg. 3\(4\)](#), [\(5\)](#), [8\(2\)-\(7\)](#), [31](#))
- C129** Ss. 18-28 applied (with modifications) (E.W.S.) (1.6.2015) by [The Biocidal Products and Chemicals \(Appointment of Authorities and Enforcement\) Regulations 2013 \(S.I. 2013/1506\)](#), [regs. 2\(2\)](#), [17\(1\)](#) (with [reg. 3\(4\)\(5\)31](#))
- C156** Ss. 19-28 applied (with modifications) (E.W.S.) (1.10.2014) by [The Explosives Regulations 2014 \(S.I. 2014/1638\)](#), [reg. 1\(1\)](#), [Sch. 12 paras. 2](#), [3](#)
- C158** Ss. 19-28 applied (with modifications) by S.I. 2014/1638, [Sch. 12 paras. 5-7](#) (as substituted (E.W.S.) (20.4.2016) by [The Explosives Regulations 2014 \(Amendment\) Regulations 2016 \(S.I. 2016/315\)](#), [reg. 1](#), [Sch. 1](#) (with [regs. 2\(1\)](#), [15](#)))
- C237** S. 23 applied by [S.I. 1989/840](#), [arts. 2-10](#)
- S. 23 excluded (with saving) (E.W.S.) (1.12.1997) by [S.I. 1997/1840](#), [regs. 7](#), [9](#) S. 23 extended (E.W.S.) (1.10.1996) by [S.I. 1996/1513](#), [reg. 10](#)
- S. 23: power to apply conferred (E.W.S.) (28.8.1995) by [1995 c. 15](#), [ss. 2\(4\)\(c\)](#), [5](#) (with [s. 3\(5\)](#))
- S. 23 applied (with modifications) (E.W.S.) (16.4.1996) by [S.I. 1996/772](#), [reg. 17](#)
- S. 23 applied (with modifications) (E.W.S.) (1.3.1996) by [S.I. 1996/192](#), [reg. 15](#), [Sch. 14 para. 1\(b\)](#)
- S. 23 applied (with modifications) (E.W.S.) (1.7.1997) by [S.I. 1997/831](#), [reg. 19\(1\)-\(4\)](#), [Sch. 15 para. 1\(a\)\(b\)](#) Ss. 23 applied (15.11.2000) by [S.I. 2000/2831](#), [reg. 26\(1\)\(a\)](#)
- Ss. 23 applied (E.W.S.) (24.7.2002) by [S.I. 2002/1689](#), [reg. 14\(1\)\(a\)](#)
- S. 23 applied (31.3.2002) by [S.I. 2002/528](#), [reg. 10](#)
- S. 23 applied (16.5.2002) by [S.I. 2002/1166](#), [reg. 31](#) (with [art. 37](#))
- C240** S. 23 extended (with modifications) (1.4.1999) by [S.I. 1999/743](#), [reg. 20\(1\)\(b\)](#), (2)(3)
- C241** Ss. 23 extended (19.11.1999) by [S.I. 1999/2892](#), [reg. 16\(1\)](#)
- C243** S. 23 applied (11.7.2001) by [S.I. 2001/2127](#), [arts. 4\(1\)](#), [5\(1\)\(2\)](#), [6\(1\)](#), [7\(1\)](#), [8\(1\)](#), [10](#) (with [art. 11](#)) (as amended by [S.I. 2009/1750](#), [art. 2\(2\)\(4\)](#))
- C244** S. 23 applied (E.W.S.) (20.9.2001) by [S.I. 2001/2975](#), [reg. 19\(b\)](#)

Changes to legislation: *Health and Safety at Work etc. Act 1974 is up to date with all changes known to be in force on or before 28 April 2021. There are changes that may be brought into force at a future date. Changes that have been made appear in the content and are referenced with annotations. (See end of Document for details) View outstanding changes*

- C245** S. 23 applied (with modifications) (3.5.2004) by The Cableway Installations Regulations 2004 (S.I. 2004/129), **reg. 23(3)(b)**
- C246** S. 23 applied (with modifications) (9.6.2004) by S.I. 2004/1309, **reg. 17**; s. 23 applied (E.W.S) (2.4.2006) by S.I. 2006/397, **reg. 34**
- C248** Ss. 1-59, 80-82 applied (temp.) (5.8.2009) by The Health and Safety at Work etc. Act 1974 (Application outside Great Britain) Order 2001 (S.I. 2001/2127), arts. 8A, 8B (as inserted by S.I. 2009/1750, **art. 2(3)**)
- C249** S. 23 applied in part (with modifications) (E.W.S.) (6.4.2010) by The Rail Vehicle Accessibility (Non-Interoperable Rail System) Regulations 2010 (S.I. 2010/432), **reg. 6(2)(3)(c)**
- C252** S. 23 applied (with modifications) (16.1.2012) by The Railways (Interoperability) Regulations 2011 (S.I. 2011/3066), regs. 1(2), **39(2)(3)(c)** (with reg. 3)
- C253** Ss. 23, 24 applied (1.3.2014) by The Biocidal Products and Chemicals (Appointment of Authorities and Enforcement) Regulations 2013 (S.I. 2013/1506), regs. 2(4), **19** (with reg. 3(4)(5)31)
- C254** S. 23 applied (with modifications) (E.W.S.) (1.6.2015) by The Control of Major Accident Hazards Regulations 2015 (S.I. 2015/483), regs. 1(1), **27(1)(b)** (with regs. 3(2), 27(3))
- C255** S. 23 applied (19.7.2015) by The Offshore Installations (Offshore Safety Directive) (Safety Case etc.) Regulations 2015 (S.I. 2015/398), regs. 1, **36(8)(b)** (with reg. 4(2), Sch. 14)
- C256** S. 23 applied (19.7.2015) by The Offshore Installations (Offshore Safety Directive) (Safety Case etc.) Regulations 2015 (S.I. 2015/398), regs. 1, **36(1)(b)** (with reg. 4(2), Sch. 14)
- C257** S. 23 applied (with modifications) (17.8.2015) by The Pyrotechnic Articles (Safety) Regulations 2015 (S.I. 2015/1553), reg. 1, Sch. 8 paras. 1(f), **2**
- C258** S. 23 applied (with modifications) (8.12.2016) by The Simple Pressure Vessels (Safety) Regulations 2016 (S.I. 2016/1092), reg. 1, Sch. 6 paras. 1(e), **2** (with reg. 3)
- C259** S. 23 applied (with modifications) (E.W.S.) (8.12.2016) by The Equipment and Protective Systems Intended for Use in Potentially Explosive Atmospheres Regulations 2016 (S.I. 2016/1107), reg. 1(1), **Sch. 4 para. 1(e)**
- C260** S. 23 applied (with modifications) (8.12.2016) by The Lifts Regulations 2016 (S.I. 2016/1093), reg. 1, Sch. 8 paras. 1(f), **2** (with regs. 3-5)
- C261** S. 23 applied (with modifications) (8.12.2016) by The Electrical Equipment (Safety) Regulations 2016 (S.I. 2016/1101), reg. 1, Sch. 4 paras. 1, **2** (with reg. 3)
- C262** S. 23 applied (with modifications) (8.12.2016) by The Pressure Equipment (Safety) Regulations 2016 (S.I. 2016/1105), reg. 1, Sch. 8 paras. 1(e), **2** (with reg. 88)
- C263** S. 23 applied (with modifications) (21.4.2018) by The Personal Protective Equipment (Enforcement) Regulations 2018 (S.I. 2018/390), reg. 1(1), **Sch. 2** (with reg. 2(1)-(3))
- C264** S. 23 applied (with modifications) (21.4.2018) by The Gas Appliances (Enforcement) and Miscellaneous Amendments Regulations 2018 (S.I. 2018/389), reg. 1(1), **Sch. 2** (with reg. 2)
- C265** S. 23 applied (with modifications) (30.7.2018) by The Cableway Installations Regulations 2018 (S.I. 2018/816), regs. 1, **21(1)-(3)** (with reg. 4)
- C268** S. 23(4) applied (with modifications) (1.4.1999) by S.I. 1999/743, **reg. 20(5)**
- C840** S. 23 applied by S.I. 1989/840, **arts. 2-10**
- S. 23 excluded (with saving) (E.W.S.) (1.12.1997) by S.I. 1997/1840, **regs. 7, 9**
- S. 23 extended (E.W.S.) (1.10.1996) by S.I. 1996/1513, **reg. 10**
- S. 23: power to apply conferred (E.W.S.) (28.8.1995) by 1995 c. 15, **ss. 2(4)(c), 5** (with s. 3(5))
- S. 23 applied (with modifications) (E.W.S.) (16.4.1996) by S.I. 1996/772, **reg. 17**
- S. 23 applied (with modifications) (E.W.S.) (1.3.1996) by S.I. 1996/192, reg. 15, **Sch. 14 para. 1(b)**
- S. 23 applied (with modifications) (E.W.S.) (1.7.1997) by S.I. 1997/831, reg. 19(1)-(4), **Sch. 15 para. 1(a)(b)**
- S. 23 applied (15.11.2000) by S.I. 2000/2831, **reg. 26(1)(a)**
- S. 23 applied (E.W.S.) (24.7.2002) by S.I. 2002/1689, **reg. 14(1)(a)**
- S. 23 applied (31.3.2002) by S.I. 2002/528, **reg. 10**
- S. 23 applied (16.5.2002) by S.I. 2002/1166, **reg. 31** (with art. 37)
- C841** Ss. 19-28 applied (with modifications) (1.1.1993) by S.I. 1992/3073, reg. 28, **Sch. 6 para. 1(b)**
- C842** Ss. 19-28 modified (6.4.1992) by S.I. 1992/711, **regs. 1(2), 28(3)(b)(5)(a)**

Changes to legislation: *Health and Safety at Work etc. Act 1974 is up to date with all changes known to be in force on or before 28 April 2021. There are changes that may be brought into force at a future date. Changes that have been made appear in the content and are referenced with annotations. (See end of Document for details) View outstanding changes*

- Ss. 21-23 modified (E.W.S.) (1.4.1996) by 1995 c. 25, s. 120(1), **Sch. 22 para. 30(4)** (with ss. 7(6), 115, 117); S.I. 1996/186, **art. 3**
- C843** Ss. 19-28 applied (with modifications) (29.11.1999) by S.I. 1999/2001, reg. 24(1), **Sch. 8 para. 1(b)**
- C844** S. 23 applied (with modifications) (E.W.S.) (the amendment coming into force in accordance with art. 1(1) of the amending S.I.) by **The Channel Tunnel (Safety) Order 2007 (S.I. 2007/3531), art. 4(2)(3)(c)** (subject to (4)-(6)) (with art. 7)
- C845** S. 23 applied in part (with modifications) (E.W.S.) (6.4.2010) by **The Train Driving Licences and Certificates Regulations 2010 (S.I. 2010/724), regs. 1(2), 38(2)(3)(c)**
- C846** Ss. 19-28 applied (with modifications) (E.W.S.) (4.7.2010 for certain purposes and otherwise 4.7.2013) by **The Pyrotechnic Articles (Safety) Regulations 2010 (S.I. 2010/1554), regs. 1, 18, 37(1), {Sch. 4 paras. 1, 2}**
- C847** S. 23(1) applied (with modifications) (9.1.1995) by S.I. 1994/3260, **reg. 17(3)(5)**
- C848** S. 23(2) applied (with modifications) (9.1.1995) by S.I. 1994/3260, **reg. 17(3)(5)**
- C849** S. 23(5) applied (with modifications) (9.1.1995) by S.I. 1994/3260, **reg. 17(3)(5)**

24 Appeal against improvement or prohibition notice.

- (1) In this section “a notice” means an improvement notice or a prohibition notice.
- (2) A person on whom a notice is served may within such period from the date of its service as may be prescribed appeal to an [^{F91}employment tribunal]; and on such an appeal the tribunal may either cancel or affirm the notice and, if it affirms it, may do so either in its original form or with such modifications as the tribunal may in the circumstances think fit.
- (3) Where an appeal under this section is brought against a notice within the period allowed under the preceding subsection, then—
 - (a) in the case of an improvement notice, the bringing of the appeal shall have the effect of suspending the operation of the notice until the appeal is finally disposed of or, if the appeal is withdrawn, until the withdrawal of the appeal;
 - (b) in the case of a prohibition notice, the bringing of the appeal shall have the like effect if, but only if, on the application of the appellant the tribunal so directs (and then only from the giving of the direction).
- (4) One or more assessors may be appointed for the purposes of any proceedings brought before an [^{F91}employment tribunal] under this section.

Textual Amendments

- F91** Words in s. 24(2)(4) substituted (1.8.1998) by 1998 c. 8, s. 1(2)(a) (with s. 16(2)); S.I. 1998/1658, art. 2(1), **Sch. 1**

Modifications etc. (not altering text)

- C36** Ss. 1-59 applied by S.I. 2001/2127 art. 8A 8B (as inserted (E.W.S.) (6.4.2011) by **The Health and Safety at Work etc. Act 1974 (Application outside Great Britain) (Variation) Order 2011 (S.I. 2011/745), arts. 1(1), 3(2)**)
- C115** Ss. 16-26 applied (E.W.S.) (1.10.2014) by **The Genetically Modified Organisms (Contained Use) Regulations 2014 (S.I. 2014/1663), regs. 1, 30(2)(a)** (with reg. 3(1)(2))
- C128** Ss. 18-26 applied (with modifications) (E.W.S.) (1.9.2013) by **The Biocidal Products and Chemicals (Appointment of Authorities and Enforcement) Regulations 2013 (S.I. 2013/1506), regs. 2(1), 8(1)** (with reg. 3(4), (5), 8(2)-(7), 31)

Changes to legislation: *Health and Safety at Work etc. Act 1974 is up to date with all changes known to be in force on or before 28 April 2021. There are changes that may be brought into force at a future date. Changes that have been made appear in the content and are referenced with annotations. (See end of Document for details) View outstanding changes*

- C129** Ss. 18-28 applied (with modifications) (E.W.S.) (1.6.2015) by [The Biocidal Products and Chemicals \(Appointment of Authorities and Enforcement\) Regulations 2013 \(S.I. 2013/1506\)](#), regs. 2(2), **17(1)** (with reg. 3(4)(5)31)
- C156** Ss. 19-28 applied (with modifications) (E.W.S.) (1.10.2014) by [The Explosives Regulations 2014 \(S.I. 2014/1638\)](#), reg. 1(1), Sch. 12 paras. 2, 3
- C158** Ss. 19-28 applied (with modifications) by S.I. 2014/1638, Sch. 12 paras. 5-7 (as substituted (E.W.S.) (20.4.2016) by [The Explosives Regulations 2014 \(Amendment\) Regulations 2016 \(S.I. 2016/315\)](#), reg. 1, **Sch. 1** (with regs. 2(1), 15))
- C253** Ss. 23, 24 applied (1.3.2014) by [The Biocidal Products and Chemicals \(Appointment of Authorities and Enforcement\) Regulations 2013 \(S.I. 2013/1506\)](#), regs. 2(4), **19** (with reg. 3(4)(5)31)
- C270** S. 24 applied by [S.I. 1989/840](#), **arts. 2-10**
 S. 24 excluded (with saving) (E.W.S.) (1.12.1997) by [S.I. 1997/1840](#), **regs. 7, 9**
 S. 24 extended (E.W.S.) (1.10.1996) by [S.I. 1996/1513](#), **reg. 10**
 S. 24 applied (with modifications) (9.1.1995) by [S.I. 1994/3260](#), **reg. 17(3)(5)**
 S. 24: power to apply conferred (E.W.S.) (28.8.1995) by 1995 c. 15, **ss. 2(4)(c)**, 5 (with s. 3(5))
 S. 24 applied (with modifications) (E.W.S.) (16.4.1996) by [S.I. 1996/772](#), **reg. 17**
 S. 24 applied (with modifications) (E.W.S.) (1.3.1996) by [S.I. 1996/192](#), reg. 15, **Sch. 14 para. 1(b)**
 S. 24 applied (with modifications) (E.W.S.) (1.7.1997) by [S.I. 1997/831](#), reg. 19(1)-(4), **Sch. 15 para. 1(a)(b)** S. 24 applied (15.11.2000) by [S.I. 2000/2831](#), **reg. 26(1)(a)**
 S. 24 applied (E.W.S.) (24.7.2002) by [S.I. 2002/1689](#), **reg. 14(1)(a)**
 S. 24 applied (31.3.2002) by [S.I. 2002/528](#), **reg. 10**
 S. 24 applied (16.5.2002) by [S.I. 2002/1166](#), **reg. 31** (with art. 37)
- C271** S. 24 applied (with modifications) (1.1.1993) by [S.I.1992/3073](#), reg. 28, **Sch. 6 para. 1(b)**
- C272** S. 24 modified (6.4.1992) by [S.I. 1992/711](#), **regs. 1(2)**, 28(3)(b)(5)(a)
- C273** S. 24 applied (1.4.1999) by [S.I. 1999/743](#), **reg. 18(6)**
- C274** S. 24 excluded (1.4.1999) by [S.I. 1999/743](#), **reg. 22(6)(c)**
- C275** S. 24 applied (with modifications) (19.11.1999) by [S.I. 1999/2892](#), **reg. 16(1)**
- C276** S. 24 applied (with modifications) (29.11.1999) by [S.I. 1999/2001](#), reg. 24(1), **Sch. 8 para. 1(b)**
- C277** S. 24 applied (11.7.2001) by [S.I. 2001/2127](#), **arts. 4(1)**, 5(1)(2), 6(1), 7(1), 8(1), 10 (with art. 11) (as amended by [S.I. 2009/1750](#), **art. 2(2)(4)**)
- C278** S. 24 applied (E.W.S.) (20.9.2001) by [S.I. 2001/2975](#), **reg. 19(b)**
- C279** S. 24 applied (with modifications) (E.W.S.) (3.5.2004) by [S.I. 2004/129](#), **reg. 23(3)(b)**; s. 24 applied (with modifications) (E.W.S.) (9.6.2004) by [S.I. 2004/1309](#), **reg. 17**; s. 24 applied (2.4.2006) by [S.I. 2006/397](#), **reg. 34**
- C280** S. 24 applied (with modifications) (E.W.S.) (the amendment coming into force in accordance with art. 1(1) of the amending S.I.) by [The Channel Tunnel \(Safety\) Order 2007 \(S.I. 2007/3531\)](#), **art. 4(2)(3)(d)** (subject to (4)-(6)) (with art. 7)
- C281** Ss. 1-59, 80-82 applied (temp.) (5.8.2009) by [The Health and Safety at Work etc. Act 1974 \(Application outside Great Britain\) Order 2001 \(S.I. 2001/2127\)](#), arts. 8A, 8B (as inserted by [S.I. 2009/1750](#), **art. 2(3)**)
- C282** S. 24 applied (with modifications) (E.W.S.) (6.4.2010) by [The Rail Vehicle Accessibility \(Non-Interoperable Rail System\) Regulations 2010 \(S.I. 2010/432\)](#), **reg. 6(2)(3)(d)**
- C283** S. 24 applied (with modifications) (E.W.S.) (6.4.2010) by [The Train Driving Licences and Certificates Regulations 2010 \(S.I. 2010/724\)](#), regs. 1(2), **38(2)(3)(d)**
- C284** Ss. 19-28 applied (with modifications) (E.W.S.) (4.7.2010 for certain purposes and otherwise 4.7.2013) by [The Pyrotechnic Articles \(Safety\) Regulations 2010 \(S.I. 2010/1554\)](#), **regs. 1**, 18, 37(1), {Sch. 4 paras. 1, 2}
- C285** S. 24 applied (with modifications) (16.1.2012) by [The Railways \(Interoperability\) Regulations 2011 \(S.I. 2011/3066\)](#), regs. 1(2), **39(2)(3)(d)** (with reg. 3)
- C286** S. 24 applied (E.W.S.) (1.6.2015) by [The Control of Major Accident Hazards Regulations 2015 \(S.I. 2015/483\)](#), regs. 1(1), **23(6)** (with reg. 3(2))
- C287** S. 24 applied (19.7.2015) by [The Offshore Installations \(Offshore Safety Directive\) \(Safety Case etc.\) Regulations 2015 \(S.I. 2015/398\)](#), regs. 1, **36(1)(b)** (with reg. 4(2), Sch. 14)

Changes to legislation: Health and Safety at Work etc. Act 1974 is up to date with all changes known to be in force on or before 28 April 2021. There are changes that may be brought into force at a future date. Changes that have been made appear in the content and are referenced with annotations. (See end of Document for details) View outstanding changes

- C288** S. 24 applied (with modifications) (17.8.2015) by [The Pyrotechnic Articles \(Safety\) Regulations 2015 \(S.I. 2015/1553\)](#), reg. 1, Sch. 8 paras. 1(g), 2
- C289** S. 24 applied (with modifications) (8.12.2016) by [The Lifts Regulations 2016 \(S.I. 2016/1093\)](#), reg. 1, Sch. 8 paras. 1(g), 2 (with regs. 3-5)
- C290** S. 24 applied (with modifications) (8.12.2016) by [The Electrical Equipment \(Safety\) Regulations 2016 \(S.I. 2016/1101\)](#), reg. 1, Sch. 4 paras. 1, 2 (with reg. 3)
- C291** S. 24 applied (with modifications) (8.12.2016) by [The Simple Pressure Vessels \(Safety\) Regulations 2016 \(S.I. 2016/1092\)](#), reg. 1, Sch. 6 paras. 1(f), 2 (with reg. 3)
- C292** S. 24 applied (with modifications) (E.W.S.) (8.12.2016) by [The Equipment and Protective Systems Intended for Use in Potentially Explosive Atmospheres Regulations 2016 \(S.I. 2016/1107\)](#), reg. 1(1), **Sch. 4 para. 1(f)**
- C293** S. 24 applied (with modifications) (8.12.2016) by [The Pressure Equipment \(Safety\) Regulations 2016 \(S.I. 2016/1105\)](#), reg. 1, Sch. 8 paras. 1(f), 2 (with reg. 88)
- C294** S. 24 applied (with modifications) (21.4.2018) by [The Gas Appliances \(Enforcement\) and Miscellaneous Amendments Regulations 2018 \(S.I. 2018/389\)](#), reg. 1(1), **Sch. 2** (with reg. 2)
- C295** S. 24 applied (with modifications) (21.4.2018) by [The Personal Protective Equipment \(Enforcement\) Regulations 2018 \(S.I. 2018/390\)](#), reg. 1(1), **Sch. 2** (with reg. 2(1)-(3))
- C296** S. 24 applied (with modifications) (30.7.2018) by [The Cableway Installations Regulations 2018 \(S.I. 2018/816\)](#), regs. 1, **21(1)-(3)** (with reg. 4)

25 Power to deal with cause of imminent danger.

- (1) Where, in the case of any article or substance found by him in any premises which he has power to enter, an inspector has reasonable cause to believe that, in the circumstances in which he finds it, the article or substance is a cause of imminent danger of serious personal injury, he may seize it and cause it to be rendered harmless (whether by destruction or otherwise).
- (2) Before there is rendered harmless under this section—
 - (a) any article that forms part of a batch of similar articles; or
 - (b) any substance,
 the inspector shall, if it is practicable for him to do so, take a sample thereof and give to a responsible person at the premises where the article or substance was found by him a portion of the sample marked in a manner sufficient to identify it.
- (3) As soon as may be after any article or substance has been seized and rendered harmless under this section, the inspector shall prepare and sign a written report giving particulars of the circumstances in which the article or substance was seized and so dealt with by him, and shall—
 - (a) give a signed copy of the report to a responsible person at the premises where the article or substance was found by him; and
 - (b) unless that person is the owner of the article or substance, also serve a signed copy of the report on the owner;
 and if, where paragraph (b) above applies, the inspector cannot after reasonable enquiry ascertain the name or address of the owner, the copy may be served on him by giving it to the person to whom a copy was given under the preceding paragraph.

Changes to legislation: *Health and Safety at Work etc. Act 1974 is up to date with all changes known to be in force on or before 28 April 2021. There are changes that may be brought into force at a future date. Changes that have been made appear in the content and are referenced with annotations. (See end of Document for details) View outstanding changes*

Modifications etc. (not altering text)

- C36** Ss. 1-59 applied by S.I. 2001/2127 art. 8A 8B (as inserted (E.W.S.) (6.4.2011) by [The Health and Safety at Work etc. Act 1974 \(Application outside Great Britain\) \(Variation\) Order 2011 \(S.I. 2011/745\)](#), arts. 1(1), **3(2)**)
- C115** Ss. 16-26 applied (E.W.S.) (1.10.2014) by [The Genetically Modified Organisms \(Contained Use\) Regulations 2014 \(S.I. 2014/1663\)](#), regs. 1, **30(2)(a)** (with reg. 3(1)(2))
- C128** Ss. 18-26 applied (with modifications) (E.W.S.) (1.9.2013) by [The Biocidal Products and Chemicals \(Appointment of Authorities and Enforcement\) Regulations 2013 \(S.I. 2013/1506\)](#), regs. 2(1), **8(1)** (with reg. 3(4), (5), 8(2)-(7), 31)
- C129** Ss. 18-28 applied (with modifications) (E.W.S.) (1.6.2015) by [The Biocidal Products and Chemicals \(Appointment of Authorities and Enforcement\) Regulations 2013 \(S.I. 2013/1506\)](#), regs. 2(2), **17(1)** (with reg. 3(4)(5)31)
- C156** Ss. 19-28 applied (with modifications) (E.W.S.) (1.10.2014) by [The Explosives Regulations 2014 \(S.I. 2014/1638\)](#), reg. 1(1), Sch. 12 paras. 2, **3**
- C158** Ss. 19-28 applied (with modifications) by S.I. 2014/1638, Sch. 12 paras. 5-7 (as substituted (E.W.S.) (20.4.2016) by [The Explosives Regulations 2014 \(Amendment\) Regulations 2016 \(S.I. 2016/315\)](#), reg. 1, **Sch. 1** (with regs. 2(1), 15))
- C297** S. 25 applied by [S.I. 1989/840](#), **arts. 2-10**
- S. 25 applied (with modifications) (9.1.1995) by [S.I. 1994/3260](#), **reg. 17(3)(5)**
- S. 25: power to apply conferred (E.W.S.) (28.8.1995) by [1995 c. 15](#), **ss. 2(4)(d)**, 5 (with s. 3(5))
- S. 25 applied (with modifications) (E.W.S.) (16.4.1996) by [S.I. 1996/772](#), **reg. 17**
- S. 25 applied (with modifications) (E.W.S.) (1.3.1996) by [S.I. 1996/192](#), **reg. 15**, **Sch. 14 para. 1(b)**
- S. 25 applied (with modifications) (E.W.S.) (1.7.1997) by [S.I. 1997/831](#), reg. 19(1)-(4), **Sch. 15 para. 1(a)(b)**
- S. 25 applied (15.11.2000) by [S.I. 2000/2831](#), **reg. 26(1)(a)**
- S. 25 applied (E.W.S.) (24.7.2002) by [S.I. 2002/1689](#), **reg. 14(1)(a)**
- S. 25 applied (31.3.2002) by [S.I. 2002/528](#), **reg. 10**
- C298** Ss. 19-28 applied (with modifications) (1.1.1993) by [S.I. 1992/3073](#), reg. 28, **Sch. 6 para. 1(b)**
- C299** S. 25 modified (6.4.1992) by [S.I. 1992/711](#), **regs. 1(2)**, 28(3)(b)(5)(a)
- C300** S. 25 applied (with modifications) (19.11.1999) by [S.I. 1999/2892](#), **reg. 16(1)**
- C301** S. 25 applied (with modifications) (29.11.1999) by [S.I. 1999/2001](#), reg. 24(1), **Sch. 8 para. 1(b)**
- C302** S. 25 applied (11.7.2001) by [S.I. 2001/2127](#), **arts. 4(1)**, 5(1)(2), 6(1), 7(1), 8(1), 10 (with art. 11) (as amended by [S.I. 2009/1750](#), **art. 2(2)(4)**)
- C303** S. 25 applied (with modifications) (E.W.S.) (9.6.2004) by [S.I. 2004/1309](#), **reg. 17**
- C304** S. 25 applied (with modifications) (E.W.S.) (the amendment coming into force in accordance with art. 1(1) of the amending S.I.) by [The Channel Tunnel \(Safety\) Order 2007 \(S.I. 2007/3531\)](#), **art. 4(2)(3)(e)** (subject to (4)-(6)) (with art. 7)
- C305** Ss. 1-59, 80-82 applied (temp.) (5.8.2009) by [The Health and Safety at Work etc. Act 1974 \(Application outside Great Britain\) Order 2001 \(S.I. 2001/2127\)](#), arts. 8A, 8B (as inserted by [S.I. 2009/1750](#), **art. 2(3)**)
- C306** Ss. 19-28 applied (with modifications) (E.W.S.) (4.7.2010 for certain purposes and otherwise 4.7.2013) by [The Pyrotechnic Articles \(Safety\) Regulations 2010 \(S.I. 2010/1554\)](#), **regs. 1**, 18, 37(1), {Sch. 4 paras. 1, 2}
- C307** S. 25 applied (with modifications) (17.8.2015) by [The Pyrotechnic Articles \(Safety\) Regulations 2015 \(S.I. 2015/1553\)](#), **reg. 1**, Sch. 8 paras. 1(h), **2**
- C308** S. 25 applied (with modifications) (8.12.2016) by [The Electrical Equipment \(Safety\) Regulations 2016 \(S.I. 2016/1101\)](#), **reg. 1**, Sch. 4 paras. 1, **2** (with reg. 3)
- C309** S. 25 applied (with modifications) (8.12.2016) by [The Pressure Equipment \(Safety\) Regulations 2016 \(S.I. 2016/1105\)](#), **reg. 1**, Sch. 8 paras. 1(g), **2** (with reg. 88)
- C310** S. 25 applied (with modifications) (8.12.2016) by [The Simple Pressure Vessels \(Safety\) Regulations 2016 \(S.I. 2016/1092\)](#), **reg. 1**, Sch. 6 paras. 1(g), **2** (with reg. 3)

Changes to legislation: *Health and Safety at Work etc. Act 1974 is up to date with all changes known to be in force on or before 28 April 2021. There are changes that may be brought into force at a future date. Changes that have been made appear in the content and are referenced with annotations. (See end of Document for details) View outstanding changes*

- C311** S. 25 applied (with modifications) (E.W.S.) (8.12.2016) by [The Equipment and Protective Systems Intended for Use in Potentially Explosive Atmospheres Regulations 2016 \(S.I. 2016/1107\)](#), reg. 1(1), **Sch. 4 para. 1(g)**
- C312** S. 25 applied (with modifications) (8.12.2016) by [The Lifts Regulations 2016 \(S.I. 2016/1093\)](#), reg. 1, Sch. 8 paras. 1(h), 2 (with regs. 3-5)
- C313** S. 25 applied (with modifications) (21.4.2018) by [The Personal Protective Equipment \(Enforcement\) Regulations 2018 \(S.I. 2018/390\)](#), reg. 1(1), **Sch. 2** (with reg. 2(1)-(3))
- C314** S. 25 applied (with modifications) (21.4.2018) by [The Gas Appliances \(Enforcement\) and Miscellaneous Amendments Regulations 2018 \(S.I. 2018/389\)](#), reg. 1(1), **Sch. 2** (with reg. 2)

[^{F92} 25A Power of customs officer to detain articles and substances.

- (1) A customs officer may, for the purpose of facilitating the exercise or performance by any enforcing authority or inspector of any of the powers or duties of the authority or inspector under any of the relevant statutory provisions, seize any imported article or imported substance and detain it for not more than two working days.
- (2) Anything seized and detained under this section shall be dealt with during the period of its detention in such manner as the Commissioners of Customs and Excise may direct.
- (3) In subsection (1) above the reference to two working days is a reference to a period of forty-eight hours calculated from the time when the goods in question are seized but disregarding so much of any period as falls on a Saturday or Sunday or on Christmas Day, Good Friday or a day which is a bank holiday under the Banking and Financial Dealings Act ^{MI} 1971 in the part of Great Britain where the goods are seized.]

Textual Amendments

F92 S. 25A inserted by [Consumer Protection Act 1987 \(c. 43, SIF 109:1\)](#), s. 36, **Sch. 3 para. 3**

Modifications etc. (not altering text)

- C36** Ss. 1-59 applied by S.I. 2001/2127 art. 8A 8B (as inserted (E.W.S.) (6.4.2011) by [The Health and Safety at Work etc. Act 1974 \(Application outside Great Britain\) \(Variation\) Order 2011 \(S.I. 2011/745\)](#), arts. 1(1), **3(2)**)
- C115** Ss. 16-26 applied (E.W.S.) (1.10.2014) by [The Genetically Modified Organisms \(Contained Use\) Regulations 2014 \(S.I. 2014/1663\)](#), regs. 1, **30(2)(a)** (with reg. 3(1)(2))
- C128** Ss. 18-26 applied (with modifications) (E.W.S.) (1.9.2013) by [The Biocidal Products and Chemicals \(Appointment of Authorities and Enforcement\) Regulations 2013 \(S.I. 2013/1506\)](#), regs. 2(1), **8(1)** (with reg. 3(4), (5), 8(2)-(7), 31)
- C129** Ss. 18-28 applied (with modifications) (E.W.S.) (1.6.2015) by [The Biocidal Products and Chemicals \(Appointment of Authorities and Enforcement\) Regulations 2013 \(S.I. 2013/1506\)](#), regs. 2(2), **17(1)** (with reg. 3(4)(5)31)
- C156** Ss. 19-28 applied (with modifications) (E.W.S.) (1.10.2014) by [The Explosives Regulations 2014 \(S.I. 2014/1638\)](#), reg. 1(1), Sch. 12 paras. 2, 3
- C158** Ss. 19-28 applied (with modifications) by S.I. 2014/1638, Sch. 12 paras. 5-7 (as substituted (E.W.S.) (20.4.2016) by [The Explosives Regulations 2014 \(Amendment\) Regulations 2016 \(S.I. 2016/315\)](#), reg. 1, **Sch. 1** (with regs. 2(1), 15))
- C315** Ss. 19-28 applied (with modifications) (1.1.1993) by S.I. 1992/3073, reg. 28, **Sch. 6 para. 1(b)**
 Ss. 18(6)(7)(b), 19-22, 23(1)(2)(5), 24-26, 33(1)(e)-(h)(o)(2)(2A)(3)(4)(e), 34(3)-(5), 35, 36(1)(2), 37-39, 42 applied (with modifications) (9.1.1995) by S.I. 1994/3260, **reg. 17(3)(5)**
 Ss. 18-27, 33(1)(e)-(i)(n)(o)(2)-(4), 34(2)-(6), 36(1), 37-42, 46 applied (with modifications) (E.W.S.) (16.4.1996) by S.I. 1996/772, **reg. 17**

Changes to legislation: *Health and Safety at Work etc. Act 1974 is up to date with all changes known to be in force on or before 28 April 2021. There are changes that may be brought into force at a future date. Changes that have been made appear in the content and are referenced with annotations. (See end of Document for details) View outstanding changes*

- Ss. 19-28, 33-35, 38, 39, 41, 42 applied (with modifications) (E.W.S.) (1.3.1996) by S.I. 1996/192, reg. 15, **Sch. 14 para. 1(b)**
- Ss. 19-28, 33-35, 38, 39, 41, 42 applied (with modifications) (E.W.S.) (1.7.1997) by S.I. 1997/831, reg. 19(1)-(4), **Sch. 15 para. 1(a)(b)**
- Ss. 16-26, 33-42, 47 applied (15.11.2000) by S.I. 2000/2831, **reg. 26(1)(a)**
- Ss. 16-26 applied (E.W.S.) (24.7.2002) by S.I. 2002/1689, **reg. 14(1)(a)**
- Ss. 18-26 applied (31.3.2002) by S.I. 2002/528, **reg. 10**
- C316** Ss. 19-28 modified (6.4.1992) by S.I. 1992/711, **regs. 1(2), 28(3)(b)(5)(a)**
- C317** Ss. 18-26 applied (with modifications) (19.11.1999) by S.I. 1999/2892, **reg. 16(1)**
- C318** Ss. 19-28 applied (with modifications) (29.11.1999) by S.I. 1999/2001, reg. 24(1), **Sch. 8 para. 1(b)**
- C319** Ss. 1-59, 80-82 applied (11.7.2001) by S.I. 2001/2127, **arts. 4(1), 5(1)(2), 6(1), 7(1), 8(1), 10** (with art. 11) (as amended by S.I. 2009/1750, **art. 2(2)(4)**)
- C320** S. 25A applied (with modifications) (E.W.S.) (3.5.2004) by S.I. 2004/129, **reg. 23(3)(c)**; s. 25A applied (with modifications) (E.W.S.) (22.4.2005) by S.I. 2005/928, {reg. 4(2)-(6)}
- C321** Ss. 1-59, 80-82 applied (temp.) (5.8.2009) by The Health and Safety at Work etc. Act 1974 (Application outside Great Britain) Order 2001 (S.I. 2001/2127), arts. 8A, 8B (as inserted by S.I. 2009/1750, **art. 2(3)**)
- C322** Ss. 19-28 applied (with modifications) (E.W.S.) (4.7.2010 for certain purposes and otherwise 4.7.2013) by The Pyrotechnic Articles (Safety) Regulations 2010 (S.I. 2010/1554), **regs. 1, 18, 37(1)**, {Sch. 4 paras. 1, 2}
- C323** Ss. 25A-28 applied (with modifications) (1.3.2014) by The Biocidal Products and Chemicals (Appointment of Authorities and Enforcement) Regulations 2013 (S.I. 2013/1506), **regs. 2(4), 19** (with reg. 3(4)(5)31)
- C324** S. 25A applied (with modifications) (17.8.2015) by The Pyrotechnic Articles (Safety) Regulations 2015 (S.I. 2015/1553), **reg. 1, Sch. 8 paras. 1(i), 2**
- C325** S. 25A applied (with modifications) (8.12.2016) by The Simple Pressure Vessels (Safety) Regulations 2016 (S.I. 2016/1092), **reg. 1, Sch. 6 paras. 1(h), 2** (with reg. 3)
- C326** S. 25A applied (with modifications) (8.12.2016) by The Pressure Equipment (Safety) Regulations 2016 (S.I. 2016/1105), **reg. 1, Sch. 8 paras. 1(h), 2** (with reg. 88)
- C327** S. 25A applied (with modifications) (8.12.2016) by The Lifts Regulations 2016 (S.I. 2016/1093), **reg. 1, Sch. 8 paras. 1(i), 2** (with regs. 3-5)
- C328** S. 25A applied (with modifications) (E.W.S.) (8.12.2016) by The Equipment and Protective Systems Intended for Use in Potentially Explosive Atmospheres Regulations 2016 (S.I. 2016/1107), **reg. 1(1), Sch. 4 para. 1(h)**
- C329** S. 25A applied (with modifications) (8.12.2016) by The Electrical Equipment (Safety) Regulations 2016 (S.I. 2016/1101), **reg. 1, Sch. 4 paras. 1, 2** (with reg. 3)
- C330** S. 25A applied (with modifications) (21.4.2018) by The Personal Protective Equipment (Enforcement) Regulations 2018 (S.I. 2018/390), **reg. 1(1), Sch. 2** (with reg. 2(1)-(3))
- C331** S. 25A applied (with modifications) (21.4.2018) by The Gas Appliances (Enforcement) and Miscellaneous Amendments Regulations 2018 (S.I. 2018/389), **reg. 1(1), Sch. 2** (with reg. 2)
- C332** S. 25A applied (with modifications) (30.7.2018) by The Cableway Installations Regulations 2018 (S.I. 2018/816), **regs. 1, 21(1)-(3)** (with reg. 4)

Marginal Citations

M1 1971 c.80

26 Power of enforcing authorities to indemnify their inspectors.

Where an action has been brought against an inspector in respect of an act done in the execution or purported execution of any of the relevant statutory provisions and the circumstances are such that he is not legally entitled to require the enforcing authority which appointed him to indemnify him, that authority may, nevertheless, indemnify

Changes to legislation: Health and Safety at Work etc. Act 1974 is up to date with all changes known to be in force on or before 28 April 2021. There are changes that may be brought into force at a future date. Changes that have been made appear in the content and are referenced with annotations. (See end of Document for details) View outstanding changes

him against the whole or part of any damages and costs or expenses which he may have been ordered to pay or may have incurred, if the authority is satisfied that he honestly believed that the act complained of was within his powers and that his duty as an inspector required or entitled him to do it.

Modifications etc. (not altering text)

- C36** Ss. 1-59 applied by S.I. 2001/2127 art. 8A 8B (as inserted (E.W.S.) (6.4.2011) by [The Health and Safety at Work etc. Act 1974 \(Application outside Great Britain\) \(Variation\) Order 2011 \(S.I. 2011/745\)](#), arts. 1(1), **3(2)**)
- C115** Ss. 16-26 applied (E.W.S.) (1.10.2014) by [The Genetically Modified Organisms \(Contained Use\) Regulations 2014 \(S.I. 2014/1663\)](#), regs. 1, **30(2)(a)** (with reg. 3(1)(2))
- C128** Ss. 18-26 applied (with modifications) (E.W.S.) (1.9.2013) by [The Biocidal Products and Chemicals \(Appointment of Authorities and Enforcement\) Regulations 2013 \(S.I. 2013/1506\)](#), regs. 2(1), **8(1)** (with reg. 3(4), (5), 8(2)-(7), 31)
- C129** Ss. 18-28 applied (with modifications) (E.W.S.) (1.6.2015) by [The Biocidal Products and Chemicals \(Appointment of Authorities and Enforcement\) Regulations 2013 \(S.I. 2013/1506\)](#), regs. 2(2), **17(1)** (with reg. 3(4)(5)31)
- C156** Ss. 19-28 applied (with modifications) (E.W.S.) (1.10.2014) by [The Explosives Regulations 2014 \(S.I. 2014/1638\)](#), reg. 1(1), Sch. 12 paras. 2, 3
- C158** Ss. 19-28 applied (with modifications) by S.I. 2014/1638, Sch. 12 paras. 5-7 (as substituted (E.W.S.) (20.4.2016) by [The Explosives Regulations 2014 \(Amendment\) Regulations 2016 \(S.I. 2016/315\)](#), reg. 1, **Sch. 1** (with regs. 2(1), 15))
- C323** Ss. 25A-28 applied (with modifications) (1.3.2014) by [The Biocidal Products and Chemicals \(Appointment of Authorities and Enforcement\) Regulations 2013 \(S.I. 2013/1506\)](#), regs. 2(4), **19** (with reg. 3(4)(5)31)
- C333** S. 26 applied by [S.I. 1989/840](#), arts. 2-10
- S. 26 excluded (with saving) (E.W.S.) (1.12.1997) by [S.I. 1997/1840](#), regs. 7, 9
- S. 26 extended (E.W.S.) (1.10.1996) by [S.I. 1996/1513](#), reg. 10
- S. 26 applied (E.W.S.) (24.7.2002) by [S.I. 2002/1689](#), reg. 14(1)(a)
- S. 26 applied (31.3.2002) by [S.I. 2002/528](#), reg. 10
- S. 26 applied (16.5.2002) by [S.I. 2002/1166](#), reg. 31 (with art. 37)
- S. 26 applied (with modifications) (9.1.1995) by [S.I. 1994/3260](#), reg. 17(3)(5)
- S. 26: power to apply conferred (E.W.S.) (28.8.1995) by 1995 c. 15, ss. 2(4)(b), 5 (with s. 3(5)) S. 26 applied (with modifications) (E.W.S.) (16.4.1996) by [S.I. 1996/772](#), reg. 17
- S. 26 applied (with modifications) (E.W.S.) (1.3.1996) by [S.I. 1996/192](#), reg. 15, **Sch. 14 para. 1(b)**
- S. 26 applied (with modifications) (E.W.S.) (1.7.1997) by [S.I. 1997/831](#), reg. 19(1)-(4), **Sch. 15 para. 1(a)(b)**
- S. 26 applied (15.11.2000) by [S.I. 2000/2831](#), reg. 26(1)(a)
- C334** S. 26 applied (with modifications) (1.1.1993) by [S.I. 1992/3073](#), reg. 28, **Sch. 6 para. 1(b)**
- C335** S. 26 modified (6.4.1992) by [S.I. 1992/711](#), regs. 1(2), 28(3)(b)(5)(a)
- C336** S. 26 extended (with modifications) (1.4.1999) by [S.I. 1999/743](#), reg. 20(1)(c), (2)(3)
- C337** S. 26 applied (with modifications) (19.11.1999) by [S.I. 1999/2892](#), reg. 16(1)
- C338** S. 26 applied (with modifications) (29.11.1999) by [S.I. 1999/2001](#), reg. 24(1), **Sch. 8 para. 1(b)**
- C339** S. 26 applied (11.7.2001) by [S.I. 2001/2127](#), arts. 4(1), 5(1)(2), 6(1), 7(1), 8(1), 10 (with art. 11) (as amended by [S.I. 2009/1750](#), art. 2(2)(4))
- C340** S. 26 applied (E.W.S.) (20.9.2001) by [S.I. 2001/2975](#), reg. 19(c)
- C341** S. 26 applied (with modifications) (E.W.S.) (22.3.2003 for certain purposes and 22.9.2003 otherwise) by [S.I. 2003/403](#), regs. 1(2), 23(2)(a)(3); s. 26 applied (with modifications) (E.W.S.) (3.5.2004) by [S.I. 2004/129](#), reg. 23(3)(c); s. 26 applied (with modifications) (E.W.S.) (9.6.2004) by [S.I. 2004/1309](#), reg. 17; s. 26 applied (E.W.S.) (22.4.2005) by [S.I. 2005/928](#), reg. 4(2)(3)(5)(6); s. 26 applied (2.4.2006) by [S.I. 2006/397](#), reg. 34

Changes to legislation: *Health and Safety at Work etc. Act 1974 is up to date with all changes known to be in force on or before 28 April 2021. There are changes that may be brought into force at a future date. Changes that have been made appear in the content and are referenced with annotations. (See end of Document for details) View outstanding changes*

- C342** S. 26 applied (with modifications) (E.W.S.) (the amendment coming into force in accordance with art. 1(1) of the amending S.I.) by **The Channel Tunnel (Safety) Order 2007 (S.I. 2007/3531)**, **art. 4(2)(3)(f)** (subject to (4)-(6)) (with art. 7)
- C343** Ss. 1-59, 80-82 applied (temp.) (5.8.2009) by **The Health and Safety at Work etc. Act 1974 (Application outside Great Britain) Order 2001 (S.I. 2001/2127)**, arts. 8A, 8B (as inserted by S.I. 2009/1750, **art. 2(3)**)
- C344** S. 26 applied (with modifications) (E.W.S.) (6.4.2010) by **The Rail Vehicle Accessibility (Non-Interoperable Rail System) Regulations 2010 (S.I. 2010/432)**, **reg. 6(2)(3)(e)**
- C345** S. 26 applied (with modifications) (E.W.S.) (6.4.2010) by **The Train Driving Licences and Certificates Regulations 2010 (S.I. 2010/724)**, regs. 1(2), **38(2)(3)(e)**
- C346** Ss. 19-28 applied (with modifications) (E.W.S.) (4.7.2010 for certain purposes and otherwise 4.7.2013) by **The Pyrotechnic Articles (Safety) Regulations 2010 (S.I. 2010/1554)**, **regs. 1, 18, 37(1)**, {Sch. 4 paras. 1, 2}
- C347** S. 26 applied (with modifications) (16.1.2012) by **The Railways (Interoperability) Regulations 2011 (S.I. 2011/3066)**, regs. 1(2), **39(2)(3)(e)** (with reg. 3)
- C348** S. 26 applied (with modifications) (E.W.S.) (1.6.2015) by **The Control of Major Accident Hazards Regulations 2015 (S.I. 2015/483)**, regs. 1(1), **27(1)(c)** (with regs. 3(2), 27(3))
- C349** S. 26 applied (19.7.2015) by **The Offshore Installations (Offshore Safety Directive) (Safety Case etc.) Regulations 2015 (S.I. 2015/398)**, regs. 1, **36(1)(c)** (with reg. 4(2), Sch. 14)
- C350** S. 26 applied (19.7.2015) by **The Offshore Installations (Offshore Safety Directive) (Safety Case etc.) Regulations 2015 (S.I. 2015/398)**, regs. 1, **36(8)(c)** (with reg. 4(2), Sch. 14)
- C351** S. 26 applied (with modifications) (17.8.2015) by **The Pyrotechnic Articles (Safety) Regulations 2015 (S.I. 2015/1553)**, reg. 1, **Sch. 8 paras. 1(j), 2**
- C352** S. 26 applied (with modifications) (8.12.2016) by **The Pressure Equipment (Safety) Regulations 2016 (S.I. 2016/1105)**, reg. 1, **Sch. 8 paras. 1(i), 2** (with reg. 88)
- C353** S. 26 applied (with modifications) (8.12.2016) by **The Electrical Equipment (Safety) Regulations 2016 (S.I. 2016/1101)**, reg. 1, **Sch. 4 paras. 1, 2** (with reg. 3)
- C354** S. 26 applied (with modifications) (8.12.2016) by **The Lifts Regulations 2016 (S.I. 2016/1093)**, reg. 1, **Sch. 8 paras. 1(j), 2** (with regs. 3-5)
- C355** S. 26 applied (with modifications) (E.W.S.) (8.12.2016) by **The Equipment and Protective Systems Intended for Use in Potentially Explosive Atmospheres Regulations 2016 (S.I. 2016/1107)**, reg. 1(1), **Sch. 4 para. 1(i)**
- C356** S. 26 applied (with modifications) (8.12.2016) by **The Simple Pressure Vessels (Safety) Regulations 2016 (S.I. 2016/1092)**, reg. 1, **Sch. 6 paras. 1(i), 2** (with reg. 3)
- C357** S. 26 applied (with modifications) (21.4.2018) by **The Personal Protective Equipment (Enforcement) Regulations 2018 (S.I. 2018/390)**, reg. 1(1), **Sch. 2** (with reg. 2(1)-(3))
- C358** S. 26 applied (with modifications) (21.4.2018) by **The Gas Appliances (Enforcement) and Miscellaneous Amendments Regulations 2018 (S.I. 2018/389)**, reg. 1(1), **Sch. 2** (with reg. 2)
- C359** S. 26 applied (with modifications) (30.7.2018) by **The Cableway Installations Regulations 2018 (S.I. 2018/816)**, regs. 1, **21(1)-(3)** (with reg. 4)

Obtaining and disclosure of information

27 Obtaining of information by the Commission, the Executive, enforcing authorities etc.

(1) For the purpose of obtaining—

- (a) any information which [^{F93}the Executive] needs for the discharge of its functions; or
- (b) any information which an enforcing authority [^{F94}other than the Office for Nuclear Regulation] needs for the discharge of the authority's functions,

Changes to legislation: *Health and Safety at Work etc. Act 1974 is up to date with all changes known to be in force on or before 28 April 2021. There are changes that may be brought into force at a future date. Changes that have been made appear in the content and are referenced with annotations. (See end of Document for details) View outstanding changes*

[^{F93}the Executive] may, with the consent of the Secretary of State, serve on any person a notice requiring that person to furnish to [^{F93}the Executive] or, as the case may be, to the enforcing authority in question such information about such matters as may be specified in the notice, and to do so in such form and manner and within such time as may be so specified.

In this subsection “consent” includes a general consent extending to cases of any stated description.

(2) Nothing in section 9 of the ^{M2}Statistics of Trade Act 1947 (which restricts the disclosure of information obtained under that Act) shall prevent or penalise—

(a) the disclosure by a Minister of the Crown to ^{F95}. . . the Executive of information obtained under that Act about any undertaking within the meaning of that Act, being information consisting of the names and address of the persons carrying on the undertaking, the nature of the undertaking’s activities, the numbers of persons of different descriptions who work in the undertaking, the addresses or places where activities of the undertaking are or were carried on, the nature of the activities carried on there, or the numbers of person of different descriptions who work or worked in the undertaking there; ^{F96}. . .

^{F96}(b)

[^{F97}(3) In the preceding subsection, any reference to a Minister of the Crown or the Executive includes respectively a reference to an officer of that person or of that body and also, in the case of a reference to the Executive, includes a reference to—

(a) a person performing any functions of the Executive on its behalf by virtue of section 13(3);
 (b) an officer of a body which is so performing any such functions; and
 (c) an adviser appointed under section 13(7).]

(4) A person to whom information is disclosed in pursuance of subsection (2) above shall not use the information for a purpose other than a purpose ^{F98}. . . of the Executive.

Textual Amendments

- F93** Words in s. 27(1) substituted (1.4.2008) by [The Legislative Reform \(Health and Safety Executive\) Order 2008 \(S.I. 2008/960\)](#), [art. 11\(2\)](#) (with [art. 21](#), [Sch. 2](#))
- F94** Words in s. 27(1)(b) inserted (1.4.2014) by [Energy Act 2013 \(c. 32\)](#), s. 156(1), [Sch. 12 para. 7](#); [S.I. 2014/251](#), [art. 4](#)
- F95** Words in s. 27(2) omitted (1.4.2008) by virtue of [The Legislative Reform \(Health and Safety Executive\) Order 2008 \(S.I. 2008/960\)](#), [art. 11\(3\)](#) (with [art. 21](#), [Sch. 2](#))
- F96** S. 27(2)(b) and the word “or” immediately preceding it repealed by [Employment Act 1989 \(c. 38\)](#), [SIF 43:1](#), s. 29(3)(4), [Sch. 6 para. 10\(2\)](#), [Sch. 7 pt. 1](#)
- F97** S. 27(3) substituted (1.4.2008) by [The Legislative Reform \(Health and Safety Executive\) Order 2008 \(S.I. 2008/960\)](#), [art. 11\(4\)](#) (with [art. 21](#), [Sch. 2](#))
- F98** Words in s. 27(4) omitted (1.4.2008) by virtue [The Legislative Reform \(Health and Safety Executive\) Order 2008 \(S.I. 2008/960\)](#), [art. 11\(5\)](#) (with [art. 21](#), [Sch. 2](#))

Modifications etc. (not altering text)

- C36** Ss. 1-59 applied by [S.I. 2001/2127 art. 8A 8B](#) (as inserted (E.W.S.) (6.4.2011) by [The Health and Safety at Work etc. Act 1974 \(Application outside Great Britain\) \(Variation\) Order 2011 \(S.I. 2011/745\)](#), [arts. 1\(1\)](#), [3\(2\)](#))

Changes to legislation: *Health and Safety at Work etc. Act 1974 is up to date with all changes known to be in force on or before 28 April 2021. There are changes that may be brought into force at a future date. Changes that have been made appear in the content and are referenced with annotations. (See end of Document for details) View outstanding changes*

- C129** Ss. 18-28 applied (with modifications) (E.W.S.) (1.6.2015) by [The Biocidal Products and Chemicals \(Appointment of Authorities and Enforcement\) Regulations 2013 \(S.I. 2013/1506\)](#), regs. 2(2), **17(1)** (with reg. 3(4)(5)31)
- C156** Ss. 19-28 applied (with modifications) (E.W.S.) (1.10.2014) by [The Explosives Regulations 2014 \(S.I. 2014/1638\)](#), reg. 1(1), **Sch. 12 paras. 2, 3**
- C158** Ss. 19-28 applied (with modifications) by S.I. 2014/1638, **Sch. 12 paras. 5-7** (as substituted (E.W.S.) (20.4.2016) by [The Explosives Regulations 2014 \(Amendment\) Regulations 2016 \(S.I. 2016/315\)](#), reg. 1, **Sch. 1** (with regs. 2(1), 15))
- C323** Ss. 25A-28 applied (with modifications) (1.3.2014) by [The Biocidal Products and Chemicals \(Appointment of Authorities and Enforcement\) Regulations 2013 \(S.I. 2013/1506\)](#), regs. 2(4), **19** (with reg. 3(4)(5)31)
- C360** S. 27 applied by S.I. 1989/840, **arts. 2-10**
 S. 27: power to apply conferred (E.W.S.) (28.8.1995) by 1995 c. 15, **ss. 2(4)(e), 5** (with s. 3(5))
 S. 27 applied (with modifications) (E.W.S.) (16.4.1996) by S.I. 1996/772, **reg. 17**
 S. 27 applied (with modifications) (E.W.S.) (1.3.1996) by S.I. 1996/192, reg. 15, **Sch. 14 para. 1(b)**
 S. 27 applied (with modifications) (E.W.S.) (1.7.1997) by S.I. 1997/831, reg. 19(1)-(4), **Sch. 15 para. 1(a)(b)**
- C361** Ss. 19-28 modified (6.4.1992) by S.I. 1992/711, **regs. 1(2), 28(3)(b)(5)(a)**
 S. 27 extended (with modifications) (E.W.S.) (1.4.1996) by 1995 c. 25, s. 120(1), **Sch. 22 para. 30(5)** (with **ss. 7(6), 115, 117**); S.I. 1996/186, **art. 3**
- C362** S. 27 applied (with modifications) (1.1.1993) by S.I. 1992/3073, reg. 28, **Sch. 6 para. 1(b)**
- C363** S. 27 applied (with modifications) (29.11.1999) by S.I. 1999/2001, reg. 24(1), **Sch. 8 para. 1(b)**
- C364** S. 27 applied (11.7.2001) by S.I. 2001/2127, **arts. 4(1), 5(1)(2), 6(1), 7(1), 8(1), 10** (with art. 11) (as amended by S.I. 2009/1750, **art. 2(2)(4)**)
- C365** S. 27 applied (with modifications) (E.W.S.) (3.5.2004) by S.I. 2004/129, **reg. 23(3)(d)**; s. 27 applied (with modifications) (E.W.S.) (9.6.2004) by S.I. 2004/1309, **reg. 17**; s. 27 applied (E.W.S.) (22.4.2005) by S.I. 2005/928, **reg. 4(2)(3)(5)(6)**
- C366** Ss. 1-59, 80-82 applied (temp.) (5.8.2009) by [The Health and Safety at Work etc. Act 1974 \(Application outside Great Britain\) Order 2001 \(S.I. 2001/2127\)](#), arts. 8A, 8B (as inserted by S.I. 2009/1750, **art. 2(3)**)
- C367** Ss. 19-28 applied (with modifications) (E.W.S.) (4.7.2010 for certain purposes and otherwise 4.7.2013) by [The Pyrotechnic Articles \(Safety\) Regulations 2010 \(S.I. 2010/1554\)](#), **regs. 1, 18, 37(1)**, {**Sch. 4 paras. 1, 2**}
- C368** S. 27 applied (with modifications) (17.8.2015) by [The Pyrotechnic Articles \(Safety\) Regulations 2015 \(S.I. 2015/1553\)](#), reg. 1, **Sch. 8 paras. 1(k), 2**
- C369** S. 27 applied (with modifications) (8.12.2016) by [The Simple Pressure Vessels \(Safety\) Regulations 2016 \(S.I. 2016/1092\)](#), reg. 1, **Sch. 6 paras. 1(j), 2** (with reg. 3)
- C370** S. 27 applied (with modifications) (8.12.2016) by [The Electrical Equipment \(Safety\) Regulations 2016 \(S.I. 2016/1101\)](#), reg. 1, **Sch. 4 paras. 1, 2** (with reg. 3)
- C371** S. 27 applied (with modifications) (8.12.2016) by [The Lifts Regulations 2016 \(S.I. 2016/1093\)](#), reg. 1, **Sch. 8 paras. 1(k), 2** (with regs. 3-5)
- C372** S. 27 applied (with modifications) (E.W.S.) (8.12.2016) by [The Equipment and Protective Systems Intended for Use in Potentially Explosive Atmospheres Regulations 2016 \(S.I. 2016/1107\)](#), reg. 1(1), **Sch. 4 para. 1(j)**
- C373** S. 27 applied (with modifications) (8.12.2016) by [The Pressure Equipment \(Safety\) Regulations 2016 \(S.I. 2016/1105\)](#), reg. 1, **Sch. 8 paras. 1(j), 2** (with reg. 88)
- C374** S. 27 applied (with modifications) (21.4.2018) by [The Gas Appliances \(Enforcement\) and Miscellaneous Amendments Regulations 2018 \(S.I. 2018/389\)](#), reg. 1(1), **Sch. 2** (with reg. 2)
- C375** S. 27 applied (with modifications) (21.4.2018) by [The Personal Protective Equipment \(Enforcement\) Regulations 2018 \(S.I. 2018/390\)](#), reg. 1(1), **Sch. 2** (with reg. 2(1)-(3))
- C376** S. 27 applied (with modifications) (30.7.2018) by [The Cableway Installations Regulations 2018 \(S.I. 2018/816\)](#), regs. 1, **21(1)-(3)** (with reg. 4)

Changes to legislation: *Health and Safety at Work etc. Act 1974 is up to date with all changes known to be in force on or before 28 April 2021. There are changes that may be brought into force at a future date. Changes that have been made appear in the content and are referenced with annotations. (See end of Document for details) View outstanding changes*

C377 S. 27(1) applied (with modifications) (E.W.S.) (22.9.2003) by [S.I. 2003/403, reg. 23\(2\)\(d\)\(3\)\(5\)](#) (as amended (25.11.2006) by [S.I. 2006/2815, reg. 8](#))

Marginal Citations

M2 1947 c. 39.

^{F100} **27A** [^{F99}**Information communicated by Commissioners for Revenue and Customs**].

- (1) If they think it appropriate to do so for the purpose of facilitating the exercise or performance by any person to whom sub-section (2) below applies of any of that person's powers or duties under any of the relevant statutory provisions, [^{F101}the Commissioners for Her Majesty's Revenue and Customs] may authorise the disclosure to that person of any information obtained [^{F102}or held] for the purposes of the exercise [^{F103}by Her Majesty's Revenue and Customs] of their functions in relation to imports.
- (2) This subsection applies to an enforcing authority and to an inspector [^{F104}, other than the Office for Nuclear Regulation or an inspector appointed by the Office for Nuclear Regulation].
- (3) A disclosure of information made to any person under subsection (1) above shall be made in such manner as may be directed by [^{F105}the Commissioners for Her Majesty's Revenue and Customs] and may be made through such persons acting on behalf of that person as may be so directed.
- (4) Information may be disclosed to a person under subsection (1) above whether or not the disclosure of the information has been requested by or on behalf of that person.]

Textual Amendments

F99 S. 27A heading substituted (18.4.2005) by virtue of [Commissioners for Revenue and Customs Act 2005 \(c. 11\), ss. 50, 53\(1\), Sch. 4 para. 18\(4\)](#); [S.I. 2005/1126, art. 2\(2\)\(h\)](#)

F100 S. 27A inserted by [Consumer Protection Act 1987 \(c. 43, SIF 109:1\), s. 36, Sch. 3 para. 4](#)

F101 Words in s. 27A(1) substituted (18.4.2005) by [Commissioners for Revenue and Customs Act 2005 \(c. 11\), ss. 50, 53\(1\), Sch. 4 para. 18\(2\)\(a\)](#); [S.I. 2005/1126, art. 2\(2\)\(h\)](#)

F102 Words in s. 27A(1) inserted (18.4.2005) by [Commissioners for Revenue and Customs Act 2005 \(c. 11\), ss. 50, 53\(1\), Sch. 4 para. 18\(2\)\(b\)](#); [S.I. 2005/1126, art. 2\(2\)\(h\)](#)

F103 Words in s. 27A(1) substituted (18.4.2005) by [Commissioners for Revenue and Customs Act 2005 \(c. 11\), ss. 50, 53\(1\), Sch. 4 para. 18\(2\)\(c\)](#); [S.I. 2005/1126, art. 2\(2\)\(h\)](#)

F104 Words in s. 27A(2) inserted (1.4.2014) by [Energy Act 2013 \(c. 32\), s. 156\(1\), Sch. 12 para. 8](#); [S.I. 2014/251, art. 4](#)

F105 Words in s. 27A(3) substituted (18.4.2005) by [Commissioners for Revenue and Customs Act 2005 \(c. 11\), ss. 50, 53\(1\), Sch. 4 para. 18\(3\)](#); [S.I. 2005/1126, art. 2\(2\)\(h\)](#)

Modifications etc. (not altering text)

C36 Ss. 1-59 applied by [S.I. 2001/2127 art. 8A 8B \(as inserted \(E.W.S.\) \(6.4.2011\) by The Health and Safety at Work etc. Act 1974 \(Application outside Great Britain\) \(Variation\) Order 2011 \(S.I. 2011/745\), arts. 1\(1\), 3\(2\)](#)

C129 Ss. 18-28 applied (with modifications) (E.W.S.) (1.6.2015) by [The Biocidal Products and Chemicals \(Appointment of Authorities and Enforcement\) Regulations 2013 \(S.I. 2013/1506\), regs. 2\(2\), 17\(1\) \(with reg. 3\(4\)\(5\)31\)](#)

C156 Ss. 19-28 applied (with modifications) (E.W.S.) (1.10.2014) by [The Explosives Regulations 2014 \(S.I. 2014/1638\), reg. 1\(1\), Sch. 12 paras. 2, 3](#)

Changes to legislation: *Health and Safety at Work etc. Act 1974 is up to date with all changes known to be in force on or before 28 April 2021. There are changes that may be brought into force at a future date. Changes that have been made appear in the content and are referenced with annotations. (See end of Document for details) View outstanding changes*

- C158** Ss. 19-28 applied (with modifications) by S.I. 2014/1638, Sch. 12 paras. 5-7 (as substituted (E.W.S.) (20.4.2016) by [The Explosives Regulations 2014 \(Amendment\) Regulations 2016](#) (S.I. 2016/315), reg. 1, **Sch. 1** (with regs. 2(1), 15))
- C323** Ss. 25A-28 applied (with modifications) (1.3.2014) by [The Biocidal Products and Chemicals \(Appointment of Authorities and Enforcement\) Regulations 2013](#) (S.I. 2013/1506), regs. 2(4), **19** (with reg. 3(4)(5)31)
- C378** Ss. 19-28 applied (with modifications) (1.1.1993) by S.I. 1992/3073, reg. 28, **Sch. 6 para. 1(b)**
Ss. 19-28, 33-35, 38, 39, 41, 42 applied (with modifications) (E.W.S.) (1.3.1996) by S.I. 1996/192, reg. 15, **Sch. 14 para. 1(b)**
Ss. 19-28, 33-35, 38, 39, 41, 42 applied (with modifications) (E.W.S.) (1.7.1997) by S.I. 1997/831, reg. 19(1)-(4), **Sch. 15 para. 1(a)(b)**
- C379** Ss. 19-28 modified (6.4.1992) by S.I. 1992/711, **regs. 1(2)**, 28(3)(b)(5)(a)
- C380** Ss. 19-28 applied (with modifications) (29.11.1999) by S.I. 1999/2001, reg. 24(1), **Sch. 8 para. 1(b)**
- C381** Ss. 1-59, 80-82 applied (11.7.2001) by S.I. 2001/2127, **arts. 4(1)**, 5(1)(2), 6(1), 7(1), 8(1), 10 (with art. 11) (as amended by S.I. 2009/1750, **art. 2(2)(4)**)
- C382** S. 27A applied (with modifications) (E.W.S.) (3.5.2004) by S.I. 2004/129, **reg. 23(3)(d)**; s. 27A applied (with modifications) (E.W.S.) (22.4.2005) by S.I. 2005/928, **reg. 4(2)-(6)**
- C383** Ss. 1-59, 80-82 applied (temp.) (5.8.2009) by [The Health and Safety at Work etc. Act 1974 \(Application outside Great Britain\) Order 2001](#) (S.I. 2001/2127), arts. 8A, 8B (as inserted by S.I. 2009/1750, **art. 2(3)**)
- C384** Ss. 19-28 applied (with modifications) (E.W.S.) (4.7.2010 for certain purposes and otherwise 4.7.2013) by [The Pyrotechnic Articles \(Safety\) Regulations 2010](#) (S.I. 2010/1554), **regs. 1**, 18, 37(1), {Sch. 4 paras. 1, 2}
- C385** S. 27A applied (with modifications) (17.8.2015) by [The Pyrotechnic Articles \(Safety\) Regulations 2015](#) (S.I. 2015/1553), reg. 1, **Sch. 8** paras. 1(l), 2
- C386** S. 27A applied (with modifications) (8.12.2016) by [The Simple Pressure Vessels \(Safety\) Regulations 2016](#) (S.I. 2016/1092), reg. 1, **Sch. 6** paras. 1(k), 2 (with reg. 3)
- C387** S. 27A applied (with modifications) (E.W.S.) (8.12.2016) by [The Equipment and Protective Systems Intended for Use in Potentially Explosive Atmospheres Regulations 2016](#) (S.I. 2016/1107), reg. 1(1), **Sch. 4 para. 1(k)**
- C388** S. 27A applied (with modifications) (8.12.2016) by [The Electrical Equipment \(Safety\) Regulations 2016](#) (S.I. 2016/1101), reg. 1, **Sch. 4** paras. 1, 2 (with reg. 3)
- C389** S. 27A applied (with modifications) (8.12.2016) by [The Lifts Regulations 2016](#) (S.I. 2016/1093), reg. 1, **Sch. 8** paras. 1(l), 2 (with regs. 3-5)
- C390** S. 27A applied (with modifications) (8.12.2016) by [The Pressure Equipment \(Safety\) Regulations 2016](#) (S.I. 2016/1105), reg. 1, **Sch. 8** paras. 1(k), 2 (with reg. 88)
- C391** S. 27A applied (with modifications) (21.4.2018) by [The Gas Appliances \(Enforcement\) and Miscellaneous Amendments Regulations 2018](#) (S.I. 2018/389), reg. 1(1), **Sch. 2** (with reg. 2)
- C392** S. 27A applied (with modifications) (21.4.2018) by [The Personal Protective Equipment \(Enforcement\) Regulations 2018](#) (S.I. 2018/390), reg. 1(1), **Sch. 2** (with reg. 2(1)-(3))
- C393** S. 27A applied (with modifications) (30.7.2018) by [The Cableway Installations Regulations 2018](#) (S.I. 2018/816), regs. 1, **21(1)-(3)** (with reg. 4)

28 Restrictions on disclosure of information. **E+W**

(1) In this and the two following subsections—

- (a) “relevant information” means information obtained by a person under section 27(1) or furnished to any person [F106], other than the Office for Nuclear Regulation (or an inspector appointed by it), [F107] under section 27A above [F108], by virtue of section 43A(6) below [or] in pursuance of a requirement imposed by any of the relevant statutory provisions; and

Changes to legislation: *Health and Safety at Work etc. Act 1974 is up to date with all changes known to be in force on or before 28 April 2021. There are changes that may be brought into force at a future date. Changes that have been made appear in the content and are referenced with annotations. (See end of Document for details) View outstanding changes*

- (b) “the recipient”, in relation to any relevant information, means the person by whom that information was so obtained or to whom that information was so furnished, as the case may be.
- (2) Subject to the following subsection, no relevant information shall be disclosed without the consent of the person by whom it was furnished.
- (3) The preceding subsection shall not apply to—
- (a) disclosure of information to ^{F109} . . . the Executive [^{F110}, the Office for Nuclear Regulation,], [^{F111} the Environment Agency, [^{F112}the Natural Resources Body for Wales,]the Scottish Environment Protection Agency,] a government department or any enforcing authority;
 - (b) without prejudice to paragraph (a) above, disclosure by the recipient of information to any person for the purpose of any function conferred on the recipient by or under any of the relevant statutory provisions;
 - (c) without prejudice to paragraph (a) above, disclosure by the recipient of information to—
 - (i) an officer of a local authority who is authorised by that authority to receive it,
 - ^{F113}(ii) an officer ^{F114} . . . of a water undertaker, sewerage undertaker, water authority or water development board who is authorised by that ^{F115} . . . undertaker, authority or board to receive it,]
 - ^{F116}(iii)
 - (iv) a constable authorised by a chief officer of police to receive it;
 - (d) disclosure by the recipient of information in a form calculated to prevent it from being identified as relating to a particular person or case;
 - (e) disclosure of information for the purposes of any legal proceedings or any investigation or inquiry held by virtue of [^{F117}section 14(2) or (2A)] , or for the purposes of a report of any such proceedings or inquiry or of a special report made by virtue of [^{F117}section 14(2) or (2A)].
 - ^{F118}(f) any other disclosure of information by the recipient, if—
 - (i) the recipient is, or is acting on behalf of a person who is, a public authority for the purposes of the Freedom of Information Act 2000, and
 - (ii) the information is not held by the authority on behalf of another person.]
- ^{F119}(4) In the preceding subsection, any reference to the Executive [^{F120}, the Office for Nuclear Regulation,], the Environment Agency, [^{F121}the Natural Resources Body for Wales,] the Scottish Environment Protection Agency, a government department or an enforcing authority includes respectively a reference to an officer of that body or authority (including, in the case of an enforcing authority, any inspector appointed by it), and also, in the case of a reference to the Executive [^{F122}or the Office for Nuclear Regulation], includes a reference to—
- (a) a person performing any functions of the Executive [^{F123}or Office for Nuclear Regulation] on its behalf by virtue of section 13(3) [^{F123}of this Act or, as the case may be, section 95 of the Energy Act 2013];
 - (b) an officer of a body which is so performing any such functions; and
 - (c) an adviser appointed under section 13(7) [^{F124}or, in the case of the Office for Nuclear Regulation, a person providing advice to that body.].]

Changes to legislation: *Health and Safety at Work etc. Act 1974 is up to date with all changes known to be in force on or before 28 April 2021. There are changes that may be brought into force at a future date. Changes that have been made appear in the content and are referenced with annotations. (See end of Document for details) View outstanding changes*

- (5) A person to whom information is disclosed in pursuance of ^{F125}any of paragraphs (a) to (e) of] subsection (3) above shall not use the information for a purpose other than—
- (a) in a case falling within paragraph (a) of that subsection, a purpose ^{F126} . . . of the Executive ^{F127}, of the Office for Nuclear Regulation] or ^{F128}of the Environment Agency ^{F129}or of the Natural Resources Body for Wales]or of the Scottish Environment Protection Agency or]of the government department in question, or the purposes of the enforcing authority in question in connection with the relevant statutory provisions, as the case may be;
 - (b) in the case of information given to an officer of a ^{F130}body which is a local authority, ^{F131} . . . a water undertaker, a sewerage undertaker, a water authority, a river purification board or a water development board, the purposes of the body] in connection with the relevant statutory provisions or any enactment whatsoever relating to public health, public safety or the protection of the environment;
 - (c) in the case of information given to a constable, the purposes of the police in connection with the relevant statutory provisions or any enactment whatsoever relating to public health, public safety or the safety of the State.

^{F132}(6) References in subsections (3) and (5) above to a local authority include ^{F133} . . . a joint authority established by Part IV of the Local Government Act 1985, ^{F134} an economic prosperity board established under section 88 of the Local Democracy, Economic Development and Construction Act 2009, a combined authority established under section 103 of that Act^{F135}, a fire and rescue authority created by an order under section 4A of the Fire and Rescue Services Act 2004]^{F136} . . .]^{F137}and the London Fire Commissioner] .]

- (7) A person shall not disclose any information obtained by him as a result of the exercise of any power conferred by section 14(4)(a) or 20 (including, in particular, any information with respect to any trade secret obtained by him in any premises entered by him by virtue of any such power) except—
- (a) for the purposes of his functions; or
 - (b) for the purposes of any legal proceedings or any investigation or inquiry held by virtue of ^{F138}section 14(2) or (2A)] or for the purposes of a report of any such proceedings or inquiry or of a special report made by virtue of ^{F138}section 14(2) or (2A)]; or
 - (c) with the relevant consent.

In this subsection “the relevant consent” means, in the case of information furnished in pursuance of a requirement imposed under section 20, the consent of the person who furnished it, and, in any other case, the consent of a person having responsibilities in relation to the premises where the information was obtained.

- (8) Notwithstanding anything in the preceding subsection an inspector shall, in circumstances in which it is necessary to do so for the purpose of assisting in keeping persons (or the representatives of persons) employed at any premises adequately informed about matters affecting their health, safety and welfare, give to such persons or their representatives the following descriptions of information, that is to say—
- (a) factual information obtained by him as mentioned in that subsection which relates to those premises or anything which was or is therein or was or is being done therein; and
 - (b) information with respect to any action which he has taken or proposes to take in or in connection with those premises in the performance of his functions;

Changes to legislation: Health and Safety at Work etc. Act 1974 is up to date with all changes known to be in force on or before 28 April 2021. There are changes that may be brought into force at a future date. Changes that have been made appear in the content and are referenced with annotations. (See end of Document for details) View outstanding changes

and, where an inspector does as aforesaid, he shall give the like information to the employer of the first-mentioned persons.

[^{F139}(9) Notwithstanding anything in subsection (7) above, a person who has obtained such information as is referred to in that subsection may furnish to a person who appears to him to be likely to be a party to any civil proceedings arising out of any accident, occurrence, situation or other matter, a written statement of relevant facts observed by him in the course of exercising any of the powers referred to in that subsection].

[^{F140}(9A) Subsection (7) above does not apply if–

- (a) the person who has obtained any such information as is referred to in that subsection is, or is acting on behalf of a person who is, a public authority for the purposes of the Freedom of Information Act 2000, and
- (b) the information is not held by the authority on behalf of another person.]

[^{F141}(9B) Nothing in subsection (7) or (9) applies to a person appointed as an inspector by the Office for Nuclear Regulation in relation to functions which the person has by virtue of that appointment.]

[^{F142}(10) The Broads Authority and every National Park authority shall be deemed to be local authorities for the purposes of this section.]

Extent Information

E6 This version of this provision extends to England and Wales only; separate versions have been created for Scotland only and for Northern Ireland (in so far as this provision extends there, see s. 84(1)).

Textual Amendments

F106 Words in s. 28(1)(a) inserted (1.4.2014) by [Energy Act 2013 \(c. 32\)](#), s. 156(1), **Sch. 12 para. 9(2)**; S.I. 2014/251, art. 4

F107 Words inserted by [Consumer Protection Act 1987 \(c. 43, SIF 109:1\)](#), s. 36, **Sch. 3 para. 5**

F108 Words in s. 28(1)(a) inserted (10.9.2003) by [Railways and Transport Safety Act 2003 \(c. 20\)](#), **ss. 105(2), 120**

F109 Words in s. 28(3)(a) omitted (1.4.2008) by virtue of [The Legislative Reform \(Health and Safety Executive\) Order 2008 \(S.I. 2008/960\)](#), **art. 12(2)(a)** (with art. 21, Sch. 2)

F110 Words in s. 28(3)(a) inserted (1.4.2014) by [Energy Act 2013 \(c. 32\)](#), s. 156(1), **Sch. 12 para. 9(3)**; S.I. 2014/251, art. 4

F111 Words in s. 28(3)(a) inserted (E.W.S.) (1.4.1996) by [1995 c. 25](#), s. 120(1), **Sch. 22 para. 30(6)(a)** (with ss. 7(6), 115, 117); S.I. 1996/186, **art. 2**

F112 Words in s. 28(3)(a) inserted (1.4.2013) by [The Natural Resources Body for Wales \(Functions\) Order 2013 \(No. 755\)](#), art. 1(2), **Sch. 2 para. 112(2)** (with Sch. 7)

F113 S. 28(3)(c)(ii) substituted by [Water Act 1989 \(c. 15, SIF 130\)](#), s. 190, **Sch. 25 para. 46(a)** (with ss. 58(7), 101(1), 141(6), 160(1)(2)(4), 163, 189(4)–(10), 190, 193(1), Sch. 26 paras. 3(1)(2), 17, 40(4), 57(6), 58)

F114 Words in s. 28(3)(c)(ii) repealed (E.W.) (1.4.1996) by [1995 c. 25](#), s. 120(1), Sch. 22 para. 30(6)(b)(i), **Sch. 24** (with ss. 7(6), 115, 117); S.I. 1996/186, **art. 2**

F115 Word in s. 28(3)(c)(ii) repealed (E.W.) (1.4.1996) by [1995 c. 25](#), s. 120(1), Sch. 22 para. 30(6)(b)(ii), **Sch. 24** (with ss. 7(6), 115, 117); S.I. 1996/186, **art. 2**

F116 S. 28(3)(c)(iii) repealed (E.W.S.) (1.4.1996) by [1995 c. 25](#), s. 120(1), Sch. 22 para. 30(6)(d), **Sch. 24** (with ss. 7(6), 115, 117); S.I. 1996/186, **art. 2**

F117 Words in s. 28(3)(e) substituted (1.4.2008) by [The Legislative Reform \(Health and Safety Executive\) Order 2008 \(S.I. 2008/960\)](#), **art. 12(2)(b)** (with art. 21, Sch. 2)

Changes to legislation: *Health and Safety at Work etc. Act 1974 is up to date with all changes known to be in force on or before 28 April 2021. There are changes that may be brought into force at a future date. Changes that have been made appear in the content and are referenced with annotations. (See end of Document for details) View outstanding changes*

- F118** S. 28(3)(f) inserted (1.1.2005) by The Freedom of Information (Removal and Relaxation of Statutory Prohibitions on Disclosure of Information) Order 2004 (S.I. 2004/3363), **art. 5(2)**
- F119** S. 28(4) substituted (1.4.2008) by The Legislative Reform (Health and Safety Executive) Order 2008 (S.I. 2008/960), **art. 12(3)** (with art. 21, Sch. 2)
- F120** Words in s. 28(4) inserted (1.4.2014) by Energy Act 2013 (c. 32), s. 156(1), **Sch. 12 para. 9(4)(a)(i)**; S.I. 2014/251, art. 4
- F121** Words in s. 28(4) inserted (1.4.2013) by The Natural Resources Body for Wales (Functions) Order 2013 (No. 755), art. 1(2), **Sch. 2 para. 112(3)** (with Sch. 7)
- F122** Words in s. 28(4) inserted (1.4.2014) by Energy Act 2013 (c. 32), s. 156(1), **Sch. 12 para. 9(4)(a)(ii)**; S.I. 2014/251, art. 4
- F123** Words in s. 28(4)(a) inserted (1.4.2014) by Energy Act 2013 (c. 32), s. 156(1), **Sch. 12 para. 9(4)(b)**; S.I. 2014/251, art. 4
- F124** Words in s. 28(4)(c) inserted (1.4.2014) by Energy Act 2013 (c. 32), s. 156(1), **Sch. 12 para. 9(4)(c)**; S.I. 2014/251, art. 4
- F125** Words in s. 28(5) inserted (1.1.2005) by The Freedom of Information (Removal and Relaxation of Statutory Prohibitions on Disclosure of Information) Order 2004 (S.I. 2004/3363), **art. 5(3)**
- F126** Words in s. 28(5)(a) omitted (1.4.2008) by virtue of The Legislative Reform (Health and Safety Executive) Order 2008 (S.I. 2008/960), **art. 12(4)** (with art. 21, Sch. 2)
- F127** Words in s. 28(5)(a) inserted (1.4.2014) by Energy Act 2013 (c. 32), s. 156(1), **Sch. 12 para. 9(5)**; S.I. 2014/251, art. 4
- F128** Words in s. 28(5)(a) inserted (E.W.S.) (1.4.1996) by 1995 c. 25, s. 120(1), **Sch. 22 para. 30(6)(f)(i)** (with ss. 7(6), 115, 117); S.I. 1996/186, **art. 2**
- F129** Words in s. 28(5)(a) inserted (1.4.2013) by The Natural Resources Body for Wales (Functions) Order 2013 (No. 755), art. 1(2), **Sch. 2 para. 112(4)** (with Sch. 7)
- F130** Words substituted by Water Act 1989 (c. 15, SIF 130), s. 190, **Sch. 25 para. 46(b)** (with ss. 58(7), 101(1), 141(6), 160(1)(2)(4), 163, 189(4)–(10), 190, 193(1), Sch. 26 paras. 3(1)(2), 17, 40(4), 57(6), 58)
- F131** Words in s. 28(5)(b) repealed (E.W.) (1.4.1996) by 1995 c. 25, s. 120(1), Sch. 22 para. 30(6)(f)(ii), **Sch. 24** (with ss. 7(6), 115, 117); S.I. 1996/186, **art. 2**
- F132** S. 28(6) substituted by Local Government Act 1985 (c. 51, SIF 81:1), s. 84, **Sch. 14 para. 52**
- F133** Words repealed by Education Reform Act 1988 (c. 40, SIF 41:1), ss. 231(7), 235(6), 237(2), **Sch. 13 Pt. I**
- F134** Words in s. 28(6) inserted (17.12.2009) by Local Democracy, Economic Development and Construction Act 2009 (c. 20), ss. 119, 148(6), **Sch. 6 para. 42**; S.I. 2009/3318, **art. 2**
- F135** Words in s. 28(6) inserted (31.1.2017 for specified purposes, 3.4.2017 in so far as not already in force) by Policing and Crime Act 2017 (c. 3), s. 183(1)(5)(e), **Sch. 1 para. 35**; S.I. 2017/399, reg. 2, Sch. para. 38
- F136** Words in s. 28(6) omitted (26.5.2015) by virtue of Deregulation Act 2015 (c. 20), s. 115(7), **Sch. 13 para. 6(10)**; S.I. 2015/994, art. 6(g)
- F137** Words in s. 28(6) substituted (E.W.S.) (31.1.2017 for specified purposes) by Policing and Crime Act 2017 (c. 3), s. 183(1)(5)(e), **Sch. 2 para. 50**
- F138** Words in s. 28(7) substituted (1.4.2008) by The Legislative Reform (Health and Safety Executive) Order 2008 (S.I. 2008/960), **art. 12(5)** (with art. 21, Sch. 2)
- F139** S. 28(9) inserted by Employment Protection Act 1975 (c. 71), **Sch. 15 para. 9**
- F140** S. 28(9A) inserted (1.1.2005) by The Freedom of Information (Removal and Relaxation of Statutory Prohibitions on Disclosure of Information) Order 2004 (S.I. 2004/3363), **art. 5(4)**
- F141** S. 28(9B) inserted (1.4.2014) by Energy Act 2013 (c. 32), s. 156(1), **Sch. 12 para. 9(6)**; S.I. 2014/251, art. 4
- F142** S. 28(10) substituted (E.W.) (23.11.1995) by 1995 c. 25, s. 78, **Sch. 10 para. 12** (with ss. 7(6), 115, 117); S.I. 1995/2950, **art. 2**

Changes to legislation: *Health and Safety at Work etc. Act 1974 is up to date with all changes known to be in force on or before 28 April 2021. There are changes that may be brought into force at a future date. Changes that have been made appear in the content and are referenced with annotations. (See end of Document for details) View outstanding changes*

Modifications etc. (not altering text)

- C36** Ss. 1-59 applied by S.I. 2001/2127 art. 8A 8B (as inserted (E.W.S.) (6.4.2011) by [The Health and Safety at Work etc. Act 1974 \(Application outside Great Britain\) \(Variation\) Order 2011 \(S.I. 2011/745\)](#), arts. 1(1), **3(2)**)
- C129** Ss. 18-28 applied (with modifications) (E.W.S.) (1.6.2015) by [The Biocidal Products and Chemicals \(Appointment of Authorities and Enforcement\) Regulations 2013 \(S.I. 2013/1506\)](#), regs. 2(2), **17(1)** (with reg. 3(4)(5)31)
- C156** Ss. 19-28 applied (with modifications) (E.W.S.) (1.10.2014) by [The Explosives Regulations 2014 \(S.I. 2014/1638\)](#), reg. 1(1), Sch. 12 paras. 2, **3**
- C158** Ss. 19-28 applied (with modifications) by S.I. 2014/1638, Sch. 12 paras. 5-7 (as substituted (E.W.S.) (20.4.2016) by [The Explosives Regulations 2014 \(Amendment\) Regulations 2016 \(S.I. 2016/315\)](#), reg. 1, **Sch. 1** (with regs. 2(1), 15))
- C323** Ss. 25A-28 applied (with modifications) (1.3.2014) by [The Biocidal Products and Chemicals \(Appointment of Authorities and Enforcement\) Regulations 2013 \(S.I. 2013/1506\)](#), regs. 2(4), **19** (with reg. 3(4)(5)31)
- C394** S. 28 applied by S.I. 1989/840, **arts. 2-10**
 S. 28 excluded (with saving) (E.W.S.) (1.12.1997) by S.I. 1997/1840, **regs. 7, 9**
 S. 28 extended (E.W.S.) (1.10.1996) by S.I. 1996/1513, **reg. 10**
 S. 28: power to apply conferred (E.W.S.) (28.8.1995) by 1995 c. 15, **ss. 2(4)(e)**, 5 (with s. 3(5))
 S. 28 applied (with modifications) (E.W.S.) (1.3.1996) by S.I. 1996/192, reg. 15, **Sch. 14 para. 1(b)**
 S. 28 applied (with modifications) (E.W.S.) (1.7.1997) by S.I. 1997/831, reg. 19(1)-(4), **Sch. 15 para. 1(a)(b)**
 S. 28 restricted (15.11.2000) by S.I. 2000/2831, **reg. 23(1)**
- C395** S. 28 amended by S.I. 1982/1496, **reg. 10(1)**
 S. 28 extended (5.7.1994) by 1994 c. 19, ss. 39, 66(2)(b), **Sch. 13 para. 20(e)** (with ss. 54(5)(7), 55(5), Sch. 17 paras. 22(1), 23(2))
- C396** S. 28 amended by [Local Government Act 1985 \(c. 51, SIF 81:1\)](#), s. 57(7), **Sch. 13 para. 13(f)**
- C397** S. 28 restricted (E.W.S.) (1.2.1993) by S.I. 1992/3217, **reg. 15**
 S. 28 excluded (E.W.S.) (1.4.1999) by S.I. 1999/743, **reg. 21(5)**.
- C398** S. 28 applied (with modifications) (1.1.1993) by S.I. 1992/3073, reg. 28, **Sch. 6 para. 1(b)**
- C399** S. 28 modified (6.4.1992) by S.I. 1992/711, **regs. 1(2)**, 28(3)(b)(5)(a)
- C400** Ss. 1-59, 80-82 applied (11.7.2001) by S.I. 2001/2127, **arts. 4(1)**, 5(1)(2), 6(1), 7(1), 8(1), 10 (with art. 11) (as amended by S.I. 2009/1750, **art. 2(2)(4)**)
- C401** S. 28 applied (with modifications) (E.W.S.) (22.3.2003 for certain purposes and 22.9.2003 otherwise) by S.I. 2003/403, **regs. 1(2)**, **23(2)(e)(3)**
- C402** S. 28 applied (E.W.S.) by S.I. 2005/928, **art. 4(3)(b)**
- C403** S. 28 applied (with modifications) (E.W.S.) (the amendment coming into force in accordance with art. 1(1) of the amending S.I.) by [The Channel Tunnel \(Safety\) Order 2007 \(S.I. 2007/3531\)](#), **art. 4(2)(3)(g)** (subject to (4)-(6)) (with art. 7)
- C404** Ss. 1-59, 80-82 applied (temp.) (5.8.2009) by [The Health and Safety at Work etc. Act 1974 \(Application outside Great Britain\) Order 2001 \(S.I. 2001/2127\)](#), arts. 8A, 8B (as inserted by S.I. 2009/1750, **art. 2(3)**)
- C405** S. 28 applied (with modifications) (E.W.S.) (6.4.2010) by [The Rail Vehicle Accessibility \(Non-Interoperable Rail System\) Regulations 2010 \(S.I. 2010/432\)](#), **reg. 6(2)(3)(f)**
- C406** S. 28 applied (with modifications) (E.W.S.) (6.4.2010) by [The Train Driving Licences and Certificates Regulations 2010 \(S.I. 2010/724\)](#), regs. 1(2), **38(2)(3)(f)**
- C407** Ss. 19-28 applied (with modifications) (E.W.S.) (4.7.2010 for certain purposes and otherwise 4.7.2013) by [The Pyrotechnic Articles \(Safety\) Regulations 2010 \(S.I. 2010/1554\)](#), **regs. 1, 18, 37(1)**, {Sch. 4 paras. 1, 2}
- C408** S. 28 applied (with modifications) (16.1.2012) by [The Railways \(Interoperability\) Regulations 2011 \(S.I. 2011/3066\)](#), regs. 1(2), **39(2)(3)(f)** (with reg. 3)

Changes to legislation: *Health and Safety at Work etc. Act 1974 is up to date with all changes known to be in force on or before 28 April 2021. There are changes that may be brought into force at a future date. Changes that have been made appear in the content and are referenced with annotations. (See end of Document for details) View outstanding changes*

- C409** S. 28 applied (with modifications) (17.8.2015) by [The Pyrotechnic Articles \(Safety\) Regulations 2015 \(S.I. 2015/1553\)](#), reg. 1, Sch. 8 paras. 1(m), 2
- C410** S. 28 applied (with modifications) (8.12.2016) by [The Electrical Equipment \(Safety\) Regulations 2016 \(S.I. 2016/1101\)](#), reg. 1, Sch. 4 paras. 1, 2 (with reg. 3)
- C411** S. 28 applied (with modifications) (E.W.S.) (8.12.2016) by [The Equipment and Protective Systems Intended for Use in Potentially Explosive Atmospheres Regulations 2016 \(S.I. 2016/1107\)](#), reg. 1(1), Sch. 4 para. 1(1)
- C412** S. 28 applied (with modifications) (8.12.2016) by [The Simple Pressure Vessels \(Safety\) Regulations 2016 \(S.I. 2016/1092\)](#), reg. 1, Sch. 6 paras. 1(1), 2 (with reg. 3)
- C413** S. 28 applied (with modifications) (8.12.2016) by [The Lifts Regulations 2016 \(S.I. 2016/1093\)](#), reg. 1, Sch. 8 paras. 1(m), 2 (with regs. 3-5)
- C414** S. 28 applied (with modifications) (8.12.2016) by [The Pressure Equipment \(Safety\) Regulations 2016 \(S.I. 2016/1105\)](#), reg. 1, Sch. 8 paras. 1(1), 2 (with reg. 88)
- C415** S. 28 applied (with modifications) (21.4.2018) by [The Personal Protective Equipment \(Enforcement\) Regulations 2018 \(S.I. 2018/390\)](#), reg. 1(1), Sch. 2 (with reg. 2(1)-(3))
- C416** S. 28 applied (with modifications) (21.4.2018) by [The Gas Appliances \(Enforcement\) and Miscellaneous Amendments Regulations 2018 \(S.I. 2018/389\)](#), reg. 1(1), Sch. 2 (with reg. 2)
- C417** S. 28(6) extended by [S.I. 1985/1884](#), art. 10, Sch. 3 para. 4
s. 28 extended (31.1.1994) by [S.I. 1993/3050](#), art. 18(1) (with art. 3).
- C418** S. 28(7): Disclosure powers extended (14.12.2001) by [2001 c. 24](#), s. 17, Sch. 4 Pt. 1 para. 12

28 Restrictions on disclosure of information. **S**

- (1) In this and the two following subsections—
- (a) “relevant information” means information obtained by a person under section 27(1) or furnished to any person ^[^{F106}], other than the Office for Nuclear Regulation (or an inspector appointed by it), ^[^{F328}]under section 27A above ^[^{F108}], by virtue of section 43A(6) below] or] in pursuance of a requirement imposed by any of the relevant statutory provisions; and
 - (b) “the recipient”, in relation to any relevant information, means the person by whom that information was so obtained or to whom that information was so furnished, as the case may be.
- (2) Subject to the following subsection, no relevant information shall be disclosed without the consent of the person by whom it was furnished.
- (3) The preceding subsection shall not apply to—
- (a) disclosure of information to ^[^{F109}] . . . the Executive ^[^{F110}], the Office for Nuclear Regulation,], ^[^{F329}]the Environment Agency, ^[^{F112}]the Natural Resources Body for Wales,]the Scottish Environment Protection Agency,] a government department or any enforcing authority;
 - (b) without prejudice to paragraph (a) above, disclosure by the recipient of information to any person for the purpose of any function conferred on the recipient by or under any of the relevant statutory provisions;
 - (c) without prejudice to paragraph (a) above, disclosure by the recipient of information to—
 - (i) an officer of a local authority who is authorised by that authority to receive it,
 - ^[^{F330}](ii) an officer of a water undertaker, sewerage undertaker, ^[^{F331}]or Scottish Water] who is authorised by ^[^{F332}]that undertaker or, as the case may be, Scottish Water] to receive it;]

Changes to legislation: *Health and Safety at Work etc. Act 1974 is up to date with all changes known to be in force on or before 28 April 2021. There are changes that may be brought into force at a future date. Changes that have been made appear in the content and are referenced with annotations. (See end of Document for details) View outstanding changes*

^{F333}(iii)

- (iv) a constable authorised by a chief officer of police to receive it;
- (d) disclosure by the recipient of information in a form calculated to prevent it from being identified as relating to a particular person or case;
- (e) disclosure of information for the purposes of any legal proceedings or any investigation or inquiry held by virtue of [^{F117}section 14(2) or (2A)], or for the purposes of a report of any such proceedings or inquiry or of a special report made by virtue of [^{F117}section 14(2) or (2A)].

- [^{F334}(f) any other disclosure of information by the recipient, if–
 - (i) the recipient is, or is acting on behalf of a person who is, a public authority for the purposes of the Freedom of Information Act 2000 [^{F335} or a Scottish public authority for the purposes of the Freedom of Information (Scotland) Act 2002] , and
 - (ii) the information is not held by the authority on behalf of another person.]

[^{F119}(4) In the preceding subsection, any reference to the Executive [^{F120}, the Office for Nuclear Regulation,], the Environment Agency, [^{F121}the Natural Resources Body for Wales,] the Scottish Environment Protection Agency, a government department or an enforcing authority includes respectively a reference to an officer of that body or authority (including, in the case of an enforcing authority, any inspector appointed by it), and also, in the case of a reference to the Executive [^{F122} or the Office for Nuclear Regulation], includes a reference to—

- (a) a person performing any functions of the Executive [^{F123} or Office for Nuclear Regulation] on its behalf by virtue of section 13(3) [^{F123} of this Act or, as the case may be, section 95 of the Energy Act 2013];
- (b) an officer of a body which is so performing any such functions; and
- (c) an adviser appointed under section 13(7) [^{F124} or, in the case of the Office for Nuclear Regulation, a person providing advice to that body.]

(5) A person to whom information is disclosed in pursuance of [^{F336}any of paragraphs (a) to (e) of] subsection (3) above shall not use the information for a purpose other than—

- (a) in a case falling within paragraph (a) of that subsection, a purpose ^{F126} . . . of the Executive [^{F127}, of the Office for Nuclear Regulation] or [^{F337} of the Environment Agency [^{F129} or of the Natural Resources Body for Wales] or of the Scottish Environment Protection Agency or] of the government department in question, or the purposes of the enforcing authority in question in connection with the relevant statutory provisions, as the case may be;
- (b) [^{F338}in the case of information given to an officer of a body which is a local authority, a water undertaker, [^{F339} or a sewerage undertaker or to an officer of Scottish Water,] the purposes of the body [^{F340} authority, undertaker or, as the case may be, Scottish Water] in connection] with the relevant statutory provisions or any enactment whatsoever relating to public health, public safety or the protection of the environment;
- (c) in the case of information given to a constable, the purposes of the police in connection with the relevant statutory provisions or any enactment whatsoever relating to public health, public safety or the safety of the State.

[^{F341}(6) References in subsections (3) and (5) above to a local authority include ^{F133} . . . a joint authority established by Part IV of the Local Government Act 1985, [^{F134} an economic prosperity board established under section 88 of the Local Democracy, Economic Development and Construction Act 2009, a combined authority established under

Changes to legislation: *Health and Safety at Work etc. Act 1974 is up to date with all changes known to be in force on or before 28 April 2021. There are changes that may be brought into force at a future date. Changes that have been made appear in the content and are referenced with annotations. (See end of Document for details) View outstanding changes*

section 103 of that Act [^{F135}, a fire and rescue authority created by an order under section 4A of the Fire and Rescue Services Act 2004]^{F136}...]^{F137} and the London Fire Commissioner] .]

- (7) A person shall not disclose any information obtained by him as a result of the exercise of any power conferred by section 14(4)(a) or 20 (including, in particular, any information with respect to any trade secret obtained by him in any premises entered by him by virtue of any such power) except—
- (a) for the purposes of his functions; or
 - (b) for the purposes of any legal proceedings or any investigation or inquiry held by virtue of [^{F138}section 14(2) or (2A)] or for the purposes of a report of any such proceedings or inquiry or of a special report made by virtue of [^{F138}section 14(2) or (2A)]; or
 - (c) with the relevant consent.

In this subsection “the relevant consent” means, in the case of information furnished in pursuance of a requirement imposed under section 20, the consent of the person who furnished it, and, in any other case, the consent of a person having responsibilities in relation to the premises where the information was obtained.

- (8) Notwithstanding anything in the preceding subsection an inspector shall, in circumstances in which it is necessary to do so for the purpose of assisting in keeping persons (or the representatives of persons) employed at any premises adequately informed about matters affecting their health, safety and welfare, give to such persons or their representatives the following descriptions of information, that is to say—
- (a) factual information obtained by him as mentioned in that subsection which relates to those premises or anything which was or is therein or was or is being done therein; and
 - (b) information with respect to any action which he has taken or proposes to take in or in connection with those premises in the performance of his functions;
- and, where an inspector does as aforesaid, he shall give the like information to the employer of the first-mentioned persons.

[^{F342}(9) Notwithstanding anything in subsection (7) above, a person who has obtained such information as is referred to in that subsection may furnish to a person who appears to him to be likely to be a party to any civil proceedings arising out of any accident, occurrence, situation or other matter, a written statement of relevant facts observed by him in the course of exercising any of the powers referred to in that subsection].

[^{F343}(9A) Subsection (7) above does not apply if—

- (a) the person who has obtained any such information as is referred to in that subsection is, or is acting on behalf of a person who is, a public authority for the purposes of the Freedom of Information Act 2000 [^{F344}or a Scottish public authority for the purposes of the Freedom of Information (Scotland) Act 2002] , and
- (b) the information is not held by the authority on behalf of another person.]

[^{F141}(9B) Nothing in subsection (7) or (9) applies to a person appointed as an inspector by the Office for Nuclear Regulation in relation to functions which the person has by virtue of that appointment.]

[^{F345}(10) For the purposes of this section the Broads Authority shall be treated as a local authority.]

Changes to legislation: *Health and Safety at Work etc. Act 1974 is up to date with all changes known to be in force on or before 28 April 2021. There are changes that may be brought into force at a future date. Changes that have been made appear in the content and are referenced with annotations. (See end of Document for details) View outstanding changes*

Extent Information

- E14** This version of this provision extends to Scotland only; separate versions of this provision have been created for England and Wales only and for Northern Ireland (in so far as this provision extends there, see s. 84(1))

Textual Amendments

- F106** Words in s. 28(1)(a) inserted (1.4.2014) by [Energy Act 2013 \(c. 32\)](#), s. 156(1), [Sch. 12 para. 9\(2\)](#); S.I. 2014/251, art. 4
- F108** Words in s. 28(1)(a) inserted (10.9.2003) by [Railways and Transport Safety Act 2003 \(c. 20\)](#), [ss. 105\(2\)](#), 120
- F109** Words in s. 28(3)(a) omitted (1.4.2008) by virtue of [The Legislative Reform \(Health and Safety Executive\) Order 2008 \(S.I. 2008/960\)](#), [art. 12\(2\)\(a\)](#) (with art. 21, Sch. 2)
- F110** Words in s. 28(3)(a) inserted (1.4.2014) by [Energy Act 2013 \(c. 32\)](#), s. 156(1), [Sch. 12 para. 9\(3\)](#); S.I. 2014/251, art. 4
- F112** Words in s. 28(3)(a) inserted (1.4.2013) by [The Natural Resources Body for Wales \(Functions\) Order 2013 \(No. 755\)](#), art. 1(2), [Sch. 2 para. 112\(2\)](#) (with Sch. 7)
- F117** Words in s. 28(3)(e) substituted (1.4.2008) by [The Legislative Reform \(Health and Safety Executive\) Order 2008 \(S.I. 2008/960\)](#), [art. 12\(2\)\(b\)](#) (with art. 21, Sch. 2)
- F119** S. 28(4) substituted (1.4.2008) by [The Legislative Reform \(Health and Safety Executive\) Order 2008 \(S.I. 2008/960\)](#), [art. 12\(3\)](#) (with art. 21, Sch. 2)
- F120** Words in s. 28(4) inserted (1.4.2014) by [Energy Act 2013 \(c. 32\)](#), s. 156(1), [Sch. 12 para. 9\(4\)\(a\)\(i\)](#); S.I. 2014/251, art. 4
- F121** Words in s. 28(4) inserted (1.4.2013) by [The Natural Resources Body for Wales \(Functions\) Order 2013 \(No. 755\)](#), art. 1(2), [Sch. 2 para. 112\(3\)](#) (with Sch. 7)
- F122** Words in s. 28(4) inserted (1.4.2014) by [Energy Act 2013 \(c. 32\)](#), s. 156(1), [Sch. 12 para. 9\(4\)\(a\)\(ii\)](#); S.I. 2014/251, art. 4
- F123** Words in s. 28(4)(a) inserted (1.4.2014) by [Energy Act 2013 \(c. 32\)](#), s. 156(1), [Sch. 12 para. 9\(4\)\(b\)](#); S.I. 2014/251, art. 4
- F124** Words in s. 28(4)(c) inserted (1.4.2014) by [Energy Act 2013 \(c. 32\)](#), s. 156(1), [Sch. 12 para. 9\(4\)\(c\)](#); S.I. 2014/251, art. 4
- F126** Words in s. 28(5)(a) omitted (1.4.2008) by virtue of [The Legislative Reform \(Health and Safety Executive\) Order 2008 \(S.I. 2008/960\)](#), [art. 12\(4\)](#) (with art. 21, Sch. 2)
- F127** Words in s. 28(5)(a) inserted (1.4.2014) by [Energy Act 2013 \(c. 32\)](#), s. 156(1), [Sch. 12 para. 9\(5\)](#); S.I. 2014/251, art. 4
- F129** Words in s. 28(5)(a) inserted (1.4.2013) by [The Natural Resources Body for Wales \(Functions\) Order 2013 \(No. 755\)](#), art. 1(2), [Sch. 2 para. 112\(4\)](#) (with Sch. 7)
- F133** Words repealed by [Education Reform Act 1988 \(c. 40\)](#), SIF 41:1, ss. 231(7), 235(6), 237(2), [Sch. 13 Pt. 1](#)
- F134** Words in s. 28(6) inserted (17.12.2009) by [Local Democracy, Economic Development and Construction Act 2009 \(c. 20\)](#), ss. 119, 148(6), [Sch. 6 para. 42](#); S.I. 2009/3318, [art. 2](#)
- F135** Words in s. 28(6) inserted (31.1.2017 for specified purposes, 3.4.2017 in so far as not already in force) by [Policing and Crime Act 2017 \(c. 3\)](#), s. 183(1)(5)(e), [Sch. 1 para. 35](#); S.I. 2017/399, reg. 2, Sch. para. 38
- F136** Words in s. 28(6) omitted (26.5.2015) by virtue of [Deregulation Act 2015 \(c. 20\)](#), s. 115(7), [Sch. 13 para. 6\(10\)](#); S.I. 2015/994, art. 6(g)
- F137** Words in s. 28(6) substituted (E.W.S.) (31.1.2017 for specified purposes) by [Policing and Crime Act 2017 \(c. 3\)](#), s. 183(1)(5)(e), [Sch. 2 para. 50](#)
- F138** Words in s. 28(7) substituted (1.4.2008) by [The Legislative Reform \(Health and Safety Executive\) Order 2008 \(S.I. 2008/960\)](#), [art. 12\(5\)](#) (with art. 21, Sch. 2)
- F141** S. 28(9B) inserted (1.4.2014) by [Energy Act 2013 \(c. 32\)](#), s. 156(1), [Sch. 12 para. 9\(6\)](#); S.I. 2014/251, art. 4

Changes to legislation: *Health and Safety at Work etc. Act 1974 is up to date with all changes known to be in force on or before 28 April 2021. There are changes that may be brought into force at a future date. Changes that have been made appear in the content and are referenced with annotations. (See end of Document for details) View outstanding changes*

- F328** Words inserted by [Consumer Protection Act 1987](#) (c. 43, SIF 109:1), s. 36, **Sch. 3 para. 5**
- F329** Words in s. 28(3)(a) inserted (E.W.S.) (1.4.1996) by 1995 c. 25, s. 120(1), **Sch. 22 para. 30(6)(a)** (with ss. 7(6), 115, 117); S.I. 1996/186, **art. 2**
- F330** S. 28(3)(c)(ii) substituted (S.) (1.4.1996) by 1995 c. 25, s. 120(1), **Sch. 22 para. 30(6)(c)** (with ss. 7(6), 115, 117); S.I. 1996/186, **art. 2**
- F331** Words in s. 28(3)(c)(ii) substituted (S.) (14.7.2004) by [The Water Industry \(Scotland\) Act 2002 \(Consequential Modifications\) Order 2004](#) (S.I. 2004/1822) art. 2, {Sch. Pt. 1 para. 8(a)(i)}
- F332** Words in s. 28(3)(c)(ii) substituted (S.) (14.7.2004) by [The Water Industry \(Scotland\) Act 2002 \(Consequential Modifications\) Order 2004](#) (S.I. 2004/1822), art. 2, **Sch. para. 8(a)(ii)**
- F333** S. 28(3)(c)(iii) repealed (E.W.S.) (1.4.1996) by 1995 c. 25, s. 120(1), Sch. 22 para. 30(6)(d), **Sch. 24** (with ss. 7(6), 115, 117); S.I. 1996/186, **art. 2**
- F334** S. 28(3)(f) inserted (1.1.2005) by [The Freedom of Information \(Removal and Relaxation of Statutory Prohibitions on Disclosure of Information\) Order 2004](#) (S.I. 2004/3363), **art. 5(2)**
- F335** Words in s. 28(3)(f)(i) inserted (S.) (13.10.2008) by [The Freedom of Information \(Relaxation of Statutory Prohibitions on Disclosure of Information\) \(Scotland\) Order 2008](#) (S.S.I. 2008/339), **art 5(2)**
- F336** Words in s. 28(5) inserted (1.1.2005) by [The Freedom of Information \(Removal and Relaxation of Statutory Prohibitions on Disclosure of Information\) Order 2004](#) (S.I. 2004/3363), **art. 5(3)**
- F337** Words in s. 28(5)(a) inserted (E.W.S.) (1.4.1996) by 1995 c. 25, s. 120(1), **Sch. 22 para. 30(6)(f)(i)** (with ss. 7(6), 115, 117); S.I. 1996/186, **art. 2**
- F338** Words in s. 28(5)(b) substituted (S.) (1.4.1996) by 1995 c. 25, s. 120(1), **Sch. 22 para. 30(6)(f)(iii)** (with ss. 7(6), 115, 117); S.I. 1996/186, **art. 2**
- F339** Words in s. 28(5)(b) substituted (14.7.2004) by [The Water Industry \(Scotland\) Act 2002 \(Consequential Modifications\) Order 2004](#) (S.I. 2004/ 1822) art. 2, {Sch. Pt. 1 para. 8(b)(i)}
- F340** Words in s. 28(5)(b) inserted (14.7.2004) by [The Water Industry \(Scotland\) Act 2002 \(Consequential Modifications\) Order 2004](#) (S.I. 2004/1822) art. 2, {Sch. Pt. 1 para. 8(b)(ii)}
- F341** S. 28(6) substituted by [Local Government Act 1985](#) (c. 51, SIF 81:1), s. 84, **Sch. 14 para. 52**
- F342** S. 28(9) inserted by [Employment Protection Act 1975](#) (c. 71), **Sch. 15 para. 9**
- F343** S. 28(9A) inserted (1.1.2005) by [The Freedom of Information \(Removal and Relaxation of Statutory Prohibitions on Disclosure of Information\) Order 2004](#) (S.I. 2004/3363), **art. 5(4)**
- F344** Words in s. 28(9A)(a) inserted (S.) (13.10.2008) by [The Freedom of Information \(Relaxation of Statutory Prohibitions on Disclosure of Information\) \(Scotland\) Order 2008](#) (S.S.I. 2008/339), **art 5(3)**
- F345** S. 28(10) added by [Norfolk and Suffolk Broads Act 1988](#) (c. 4, SIF 81:1), s. 21, **Sch. 6 para. 13**

Modifications etc. (not altering text)

- C36** Ss. 1-59 applied by S.I. 2001/2127 art. 8A 8B (as inserted (E.W.S.) (6.4.2011) by [The Health and Safety at Work etc. Act 1974 \(Application outside Great Britain\) \(Variation\) Order 2011](#) (S.I. 2011/745), arts. 1(1), **3(2)**)
- C129** Ss. 18-28 applied (with modifications) (E.W.S.) (1.6.2015) by [The Biocidal Products and Chemicals \(Appointment of Authorities and Enforcement\) Regulations 2013](#) (S.I. 2013/1506), regs. 2(2), **17(1)** (with reg. 3(4)(5)31)
- C158** Ss. 19-28 applied (with modifications) by S.I. 2014/1638, Sch. 12 paras. 5-7 (as substituted (E.W.S.) (20.4.2016) by [The Explosives Regulations 2014 \(Amendment\) Regulations 2016](#) (S.I. 2016/315), reg. 1, **Sch. 1** (with regs. 2(1), 15))
- C323** Ss. 25A-28 applied (with modifications) (1.3.2014) by [The Biocidal Products and Chemicals \(Appointment of Authorities and Enforcement\) Regulations 2013](#) (S.I. 2013/1506), regs. 2(4), **19** (with reg. 3(4)(5)31)
- C404** Ss. 1-59, 80-82 applied (temp.) (5.8.2009) by [The Health and Safety at Work etc. Act 1974 \(Application outside Great Britain\) Order 2001](#) (S.I. 2001/2127), arts. 8A, 8B (as inserted by S.I. 2009/1750, **art. 2(3)**)
- C405** S. 28 applied (with modifications) (E.W.S.) (6.4.2010) by [The Rail Vehicle Accessibility \(Non-Interoperable Rail System\) Regulations 2010](#) (S.I. 2010/432), **reg. 6(2)(3)(f)**
- C408** S. 28 applied (with modifications) (16.1.2012) by [The Railways \(Interoperability\) Regulations 2011](#) (S.I. 2011/3066), regs. 1(2), **39(2)(3)(f)** (with reg. 3)

Changes to legislation: *Health and Safety at Work etc. Act 1974 is up to date with all changes known to be in force on or before 28 April 2021. There are changes that may be brought into force at a future date. Changes that have been made appear in the content and are referenced with annotations. (See end of Document for details) View outstanding changes*

- C409** S. 28 applied (with modifications) (17.8.2015) by **The Pyrotechnic Articles (Safety) Regulations 2015** (S.I. 2015/1553), **reg. 1, Sch. 8 paras. 1(m), 2**
- C410** S. 28 applied (with modifications) (8.12.2016) by **The Electrical Equipment (Safety) Regulations 2016** (S.I. 2016/1101), **reg. 1, Sch. 4 paras. 1, 2** (with reg. 3)
- C411** S. 28 applied (with modifications) (E.W.S.) (8.12.2016) by **The Equipment and Protective Systems Intended for Use in Potentially Explosive Atmospheres Regulations 2016** (S.I. 2016/1107), **reg. 1(1), Sch. 4 para. 1(1)**
- C412** S. 28 applied (with modifications) (8.12.2016) by **The Simple Pressure Vessels (Safety) Regulations 2016** (S.I. 2016/1092), **reg. 1, Sch. 6 paras. 1(1), 2** (with reg. 3)
- C413** S. 28 applied (with modifications) (8.12.2016) by **The Lifts Regulations 2016** (S.I. 2016/1093), **reg. 1, Sch. 8 paras. 1(m), 2** (with regs. 3-5)
- C414** S. 28 applied (with modifications) (8.12.2016) by **The Pressure Equipment (Safety) Regulations 2016** (S.I. 2016/1105), **reg. 1, Sch. 8 paras. 1(1), 2** (with reg. 88)
- C415** S. 28 applied (with modifications) (21.4.2018) by **The Personal Protective Equipment (Enforcement) Regulations 2018** (S.I. 2018/390), **reg. 1(1), Sch. 2** (with reg. 2(1)-(3))
- C416** S. 28 applied (with modifications) (21.4.2018) by **The Gas Appliances (Enforcement) and Miscellaneous Amendments Regulations 2018** (S.I. 2018/389), **reg. 1(1), Sch. 2** (with reg. 2)
- C417** S. 28(6) extended by S.I. 1985/1884, **art. 10, Sch. 3 para. 4**
s. 28 extended (31.1.1994) by S.I. 1993/3050, **art. 18(1)** (with art. 3).
- C850** S. 28 applied by S.I. 1989/840, **arts. 2-10**
S. 28 excluded (with saving) (E.W.S.) (1.12.1997) by S.I. 1997/1840, **regs. 7, 9**
S. 28 extended (E.W.S.) (1.10.1996) by S.I. 1996/1513, **reg. 10**
S. 28: power to apply conferred (E.W.S.) (28.8.1995) by 1995 c. 15, **ss. 2(4)(e), 5** (with s. 3(5))
S. 28 applied (with modifications) (E.W.S.) (1.3.1996) by S.I. 1996/192, **reg. 15, Sch. 14 para. 1(b)**
S. 28 applied (with modifications) (E.W.S.) (1.7.1997) by S.I. 1997/831, **reg. 19(1)-(4), Sch. 15 para. 1(a)(b)**
S. 28 restricted (15.11.2000) by S.I. 2000/2831, **reg. 23(1)**
- C851** S. 28 amended by S.I. 1982/1496, **reg. 10(1)**
S. 28 extended (5.7.1994) by 1994 c. 19, **ss. 39, 66(2)(b), Sch. 13 para. 20(e)** (with **ss. 54(5)(7), 55(5), Sch. 17 paras. 22(1), 23(2)**)
- C852** S. 28 restricted (E.W.S.) (1.2.1993) by S.I. 1992/3217, **reg. 15**
S. 28 excluded (E.W.S.) (1.4.1999) by S.I. 1999/743, **reg. 21(5)**.
- C853** Ss. 19-28 applied (with modifications) (1.1.1993) by S.I. 1992/3073, **reg. 28, Sch. 6 para. 1(b)**
- C854** Ss. 19-28 modified (6.4.1992) by S.I. 1992/711, **regs. 1(2), 28(3)(b)(5)(a)**
- C855** Ss. 1-59, 80-82 applied (11.7.2001) by S.I. 2001/2127, **arts. 4(1), 5(1)(2), 6(1), 7(1), 8(1), 10** (with art. 11) (as amended by S.I. 2009/1750, **art. 2(2)(4)**)
- C856** S. 28 applied (with modifications) (E.W.S.) (22.3.2003 for certain purposes and 22.9.2003 otherwise) by S.I. 2003/403, **regs. 1(2), 23(2)(e)(3)**
- C857** S. 28 applied (E.W.S.) by S.I. 2005/928, **art. 4(3)(b)**
- C858** S. 28 applied (with modifications) (E.W.S.) (the amendment coming into force in accordance with art. 1(1) of the amending S.I.) by **The Channel Tunnel (Safety) Order 2007** (S.I. 2007/3531), **art. 4(2)(3)(g)** (subject to (4)-(6)) (with art. 7)
- C859** S. 28 applied (with modifications) (E.W.S.) (6.4.2010) by **The Train Driving Licences and Certificates Regulations 2010** (S.I. 2010/724), **regs. 1(2), 38(2)(3)(f)**
- C860** Ss. 19-28 applied (with modifications) (E.W.S.) (4.7.2010 for certain purposes and otherwise 4.7.2013) by **The Pyrotechnic Articles (Safety) Regulations 2010** (S.I. 2010/1554), **regs. 1, 18, 37(1), {Sch. 4 paras. 1, 2}**
- C861** S. 28(7): Disclosure powers extended (14.12.2001) by 2001 c. 24, **s. 17, Sch. 4 Pt. 1 para. 12**

28 Restrictions on disclosure of information. **N.I.**

(1) In this and the two following subsections—

Changes to legislation: *Health and Safety at Work etc. Act 1974 is up to date with all changes known to be in force on or before 28 April 2021. There are changes that may be brought into force at a future date. Changes that have been made appear in the content and are referenced with annotations. (See end of Document for details) View outstanding changes*

- (a) “relevant information” means information obtained by a person under section 27(1) or furnished to any person ^{F106}, other than the Office for Nuclear Regulation (or an inspector appointed by it), ^{F346} under section 27A above ^{F108}, by virtue of section 43A(6) below]or] in pursuance of a requirement imposed by any of the relevant statutory provisions; and
- (b) “the recipient”, in relation to any relevant information, means the person by whom that information was so obtained or to whom that information was so furnished, as the case may be.
- (2) Subject to the following subsection, no relevant information shall be disclosed without the consent of the person by whom it was furnished.
- (3) The preceding subsection shall not apply to—
- (a) disclosure of information to ^{F109} . . . the Executive^{F110}, the Office for Nuclear Regulation,], a government department or any enforcing authority;
- (b) without prejudice to paragraph (a) above, disclosure by the recipient of information to any person for the purpose of any function conferred on the recipient by or under any of the relevant statutory provisions;
- (c) without prejudice to paragraph (a) above, disclosure by the recipient of information to—
- (i) an officer of a local authority who is authorised by that authority to receive it,
- ^{F347}(ii) an officer of the National Rivers Authority or of a water undertaker, sewerage undertaker, water authority or water development board who is authorised by that Authority, undertaker, authority or board to receive it,]
- (iii) an officer of a river purification board who is authorised by that board to receive it, or
- (iv) a constable authorised by a chief officer of police to receive it;
- (d) disclosure by the recipient of information in a form calculated to prevent it from being identified as relating to a particular person or case;
- (e) disclosure of information for the purposes of any legal proceedings or any investigation or inquiry held by virtue of ^{F117}section 14(2) or (2A)], or for the purposes of a report of any such proceedings or inquiry or of a special report made by virtue of ^{F117}section 14(2) or (2A)].
- ^{F348}(f) any other disclosure of information by the recipient, if—
- (i) the recipient is, or is acting on behalf of a person who is, a public authority for the purposes of the Freedom of Information Act 2000, and
- (ii) the information is not held by the authority on behalf of another person.]
- ^{F119}(4) In the preceding subsection, any reference to the Executive ^{F120}, the Office for Nuclear Regulation,], the Environment Agency,^{F121}the Natural Resources Body for Wales,] the Scottish Environment Protection Agency, a government department or an enforcing authority includes respectively a reference to an officer of that body or authority (including, in the case of an enforcing authority, any inspector appointed by it), and also, in the case of a reference to the Executive ^{F122}or the Office for Nuclear Regulation], includes a reference to—

Changes to legislation: *Health and Safety at Work etc. Act 1974 is up to date with all changes known to be in force on or before 28 April 2021. There are changes that may be brought into force at a future date. Changes that have been made appear in the content and are referenced with annotations. (See end of Document for details) View outstanding changes*

- (a) a person performing any functions of the Executive [^{F123}or Office for Nuclear Regulation] on its behalf by virtue of section 13(3) [^{F123} of this Act or, as the case may be, section 95 of the Energy Act 2013];
 - (b) an officer of a body which is so performing any such functions; and
 - (c) an adviser appointed under section 13(7) [^{F124}or, in the case of the Office for Nuclear Regulation, a person providing advice to that body.]
- (5) A person to whom information is disclosed in pursuance of [^{F349}any of paragraphs (a) to (e) of] subsection (3) above shall not use the information for a purpose other than—
- (a) in a case falling within paragraph (a) of that subsection, a purpose ^{F126} . . . of the Executive [^{F127}, of the Office for Nuclear Regulation] or of the government department in question, or the purposes of the enforcing authority in question in connection with the relevant statutory provisions, as the case may be;
 - (b) in the case of information given to an officer of a [^{F350}body which is a local authority, the National Rivers Authority, a water undertaker, a sewerage undertaker, a water authority, a river purification board or a water development board, the purposes of the body] in connection with the relevant statutory provisions or any enactment whatsoever relating to public health, public safety or the protection of the environment;
 - (c) in the case of information given to a constable, the purposes of the police in connection with the relevant statutory provisions or any enactment whatsoever relating to public health, public safety or the safety of the State.
- [^{F351}(6) References in subsections (3) and (5) above to a local authority include ^{F133} . . . a joint authority established by Part IV of the Local Government Act 1985, [^{F134} an economic prosperity board established under section 88 of the Local Democracy, Economic Development and Construction Act 2009, a combined authority established under section 103 of that Act^{F136} . . .]^{F136} . . . [^{F352} and the London Fire and Emergency Planning Authority] .]
- (7) A person shall not disclose any information obtained by him as a result of the exercise of any power conferred by section 14(4)(a) or 20 (including, in particular, any information with respect to any trade secret obtained by him in any premises entered by him by virtue of any such power) except—
- (a) for the purposes of his functions; or
 - (b) for the purposes of any legal proceedings or any investigation or inquiry held by virtue of [^{F138}section 14(2) or (2A)] or for the purposes of a report of any such proceedings or inquiry or of a special report made by virtue of [^{F138}section 14(2) or (2A)]; or
 - (c) with the relevant consent.

In this subsection “the relevant consent” means, in the case of information furnished in pursuance of a requirement imposed under section 20, the consent of the person who furnished it, and, in any other case, the consent of a person having responsibilities in relation to the premises where the information was obtained.

- (8) Notwithstanding anything in the preceding subsection an inspector shall, in circumstances in which it is necessary to do so for the purpose of assisting in keeping persons (or the representatives of persons) employed at any premises adequately informed about matters affecting their health, safety and welfare, give to such persons or their representatives the following descriptions of information, that is to say—

Changes to legislation: *Health and Safety at Work etc. Act 1974 is up to date with all changes known to be in force on or before 28 April 2021. There are changes that may be brought into force at a future date. Changes that have been made appear in the content and are referenced with annotations. (See end of Document for details) View outstanding changes*

- (a) factual information obtained by him as mentioned in that subsection which relates to those premises or anything which was or is therein or was or is being done therein; and
 - (b) information with respect to any action which he has taken or proposes to take in or in connection with those premises in the performance of his functions;
- and, where an inspector does as aforesaid, he shall give the like information to the employer of the first-mentioned persons.

[^{F353}(9) Notwithstanding anything in subsection (7) above, a person who has obtained such information as is referred to in that subsection may furnish to a person who appears to him to be likely to be a party to any civil proceedings arising out of any accident, occurrence, situation or other matter, a written statement of relevant facts observed by him in the course of exercising any of the powers referred to in that subsection].

[^{F354}(9A) Subsection (7) above does not apply if–

- (a) the person who has obtained any such information as is referred to in that subsection is, or is acting on behalf of a person who is, a public authority for the purposes of the Freedom of Information Act 2000, and
- (b) the information is not held by the authority on behalf of another person.]

[^{F141}(9B) Nothing in subsection (7) or (9) applies to a person appointed as an inspector by the Office for Nuclear Regulation in relation to functions which the person has by virtue of that appointment.]

[^{F355}(10) For the purposes of this section the Broads Authority shall be treated as a local authority.]

Extent Information

E15 This version of this provision applies to Northern Ireland (in so far as this provision extends there, see s. 84(1)(a)); separate versions of this provision have been created for England and Wales only and Scotland only

Textual Amendments

F106 Words in s. 28(1)(a) inserted (1.4.2014) by [Energy Act 2013 \(c. 32\)](#), s. 156(1), [Sch. 12 para. 9\(2\)](#); S.I. 2014/251, art. 4

F108 Words in s. 28(1)(a) inserted (10.9.2003) by [Railways and Transport Safety Act 2003 \(c. 20\)](#), [ss. 105\(2\), 120](#)

F109 Words in s. 28(3)(a) omitted (1.4.2008) by virtue of [The Legislative Reform \(Health and Safety Executive\) Order 2008 \(S.I. 2008/960\)](#), [art. 12\(2\)\(a\)](#) (with art. 21, Sch. 2)

F110 Words in s. 28(3)(a) inserted (1.4.2014) by [Energy Act 2013 \(c. 32\)](#), s. 156(1), [Sch. 12 para. 9\(3\)](#); S.I. 2014/251, art. 4

F117 Words in s. 28(3)(e) substituted (1.4.2008) by [The Legislative Reform \(Health and Safety Executive\) Order 2008 \(S.I. 2008/960\)](#), [art. 12\(2\)\(b\)](#) (with art. 21, Sch. 2)

F119 S. 28(4) substituted (1.4.2008) by [The Legislative Reform \(Health and Safety Executive\) Order 2008 \(S.I. 2008/960\)](#), [art. 12\(3\)](#) (with art. 21, Sch. 2)

F120 Words in s. 28(4) inserted (1.4.2014) by [Energy Act 2013 \(c. 32\)](#), s. 156(1), [Sch. 12 para. 9\(4\)\(a\)\(i\)](#); S.I. 2014/251, art. 4

F121 Words in s. 28(4) inserted (1.4.2013) by [The Natural Resources Body for Wales \(Functions\) Order 2013 \(No. 755\)](#), art. 1(2), [Sch. 2 para. 112\(3\)](#) (with Sch. 7)

F122 Words in s. 28(4) inserted (1.4.2014) by [Energy Act 2013 \(c. 32\)](#), s. 156(1), [Sch. 12 para. 9\(4\)\(a\)\(ii\)](#); S.I. 2014/251, art. 4

Changes to legislation: *Health and Safety at Work etc. Act 1974 is up to date with all changes known to be in force on or before 28 April 2021. There are changes that may be brought into force at a future date. Changes that have been made appear in the content and are referenced with annotations. (See end of Document for details) View outstanding changes*

- F123** Words in s. 28(4)(a) inserted (1.4.2014) by Energy Act 2013 (c. 32), s. 156(1), **Sch. 12 para. 9(4)(b)**; S.I. 2014/251, art. 4
- F124** Words in s. 28(4)(c) inserted (1.4.2014) by Energy Act 2013 (c. 32), s. 156(1), **Sch. 12 para. 9(4)(c)**; S.I. 2014/251, art. 4
- F126** Words in s. 28(5)(a) omitted (1.4.2008) by virtue of The Legislative Reform (Health and Safety Executive) Order 2008 (S.I. 2008/960), **art. 12(4)** (with art. 21, Sch. 2)
- F127** Words in s. 28(5)(a) inserted (1.4.2014) by Energy Act 2013 (c. 32), s. 156(1), **Sch. 12 para. 9(5)**; S.I. 2014/251, art. 4
- F133** Words repealed by Education Reform Act 1988 (c. 40, SIF 41:1), ss. 231(7), 235(6), 237(2), **Sch. 13 Pt. 1**
- F134** Words in s. 28(6) inserted (17.12.2009) by Local Democracy, Economic Development and Construction Act 2009 (c. 20), ss. 119, 148(6), **Sch. 6 para. 42**; S.I. 2009/3318, **art. 2**
- F136** Words in s. 28(6) omitted (26.5.2015) by virtue of Deregulation Act 2015 (c. 20), s. 115(7), **Sch. 13 para. 6(10)**; S.I. 2015/994, art. 6(g)
- F138** Words in s. 28(7) substituted (1.4.2008) by The Legislative Reform (Health and Safety Executive) Order 2008 (S.I. 2008/960), **art. 12(5)** (with art. 21, Sch. 2)
- F141** S. 28(9B) inserted (1.4.2014) by Energy Act 2013 (c. 32), s. 156(1), **Sch. 12 para. 9(6)**; S.I. 2014/251, art. 4
- F346** Words inserted by Consumer Protection Act 1987 (c. 43, SIF 109:1), s. 36, **Sch. 3 para. 5**
- F347** S. 28(3)(c)(ii) substituted by Water Act 1989 (c. 15, SIF 130), s. 190, **Sch. 25 para. 46(a)** (with ss. 58(7), 101(1), 141(6), 160(1)(2)(4), 163, 189(4)–(10), 190, 193(1), Sch. 26 paras. 3(1)(2), 17, 40(4), 57(6), 58)
- F348** S. 28(3)(f) inserted (1.1.2005) by The Freedom of Information (Removal and Relaxation of Statutory Prohibitions on Disclosure of Information) Order 2004 (S.I. 2004/3363), **art. 5(2)**
- F349** Words in s. 28(5) inserted (1.1.2005) by The Freedom of Information (Removal and Relaxation of Statutory Prohibitions on Disclosure of Information) Order 2004 (S.I. 2004/3363), **art. 5(3)**
- F350** Words substituted by Water Act 1989 (c. 15, SIF 130), s. 190, **Sch. 25 para. 46(b)** (with ss. 58(7), 101(1), 141(6), 160(1)(2)(4), 163, 189(4), (10), 190, 193(1), Sch. 26 paras. 3(1)(2), 17, 40(4), 57(6), 58)
- F351** S. 28(6) substituted by Local Government Act 1985 (c. 51, SIF 81:1), s. 84, **Sch. 14 para. 52**
- F352** Words in s. 28(6) added (3.7.2000) by 1999 c. 29, s. 328(8), **Sch. 29 para. 23** (with Sch. 12 para. 9(1)); S.I. 2000/1094, **art. 4**
- F353** S. 28(9) inserted by Employment Protection Act 1975 (c. 71), **Sch. 15 para. 9**
- F354** S. 28(9A) inserted (1.1.2005) by The Freedom of Information (Removal and Relaxation of Statutory Prohibitions on Disclosure of Information) Order 2004 (S.I. 2004/3363), **art. 5(4)**
- F355** S. 28(10) added by Norfolk and Suffolk Broads Act 1988 (c. 4, SIF 81:1), s. 21, **Sch. 6 para. 13**

Modifications etc. (not altering text)

- C36** Ss. 1-59 applied by S.I. 2001/2127 art. 8A 8B (as inserted (E.W.S.) (6.4.2011) by The Health and Safety at Work etc. Act 1974 (Application outside Great Britain) (Variation) Order 2011 (S.I. 2011/745), arts. 1(1), **3(2)**)
- C129** Ss. 18-28 applied (with modifications) (E.W.S.) (1.6.2015) by The Biocidal Products and Chemicals (Appointment of Authorities and Enforcement) Regulations 2013 (S.I. 2013/1506), regs. 2(2), **17(1)** (with reg. 3(4)(5)31)
- C158** Ss. 19-28 applied (with modifications) by S.I. 2014/1638, Sch. 12 paras. 5-7 (as substituted (E.W.S.) (20.4.2016) by The Explosives Regulations 2014 (Amendment) Regulations 2016 (S.I. 2016/315), reg. 1, **Sch. 1** (with regs. 2(1), 15))
- C323** Ss. 25A-28 applied (with modifications) (1.3.2014) by The Biocidal Products and Chemicals (Appointment of Authorities and Enforcement) Regulations 2013 (S.I. 2013/1506), regs. 2(4), **19** (with reg. 3(4)(5)31)
- C400** Ss. 1-59, 80-82 applied (11.7.2001) by S.I. 2001/2127, **arts. 4(1), 5(1)(2), 6(1), 7(1), 8(1), 10** (with art. 11) (as amended by S.I. 2009/1750, **art. 2(2)(4)**)

Changes to legislation: *Health and Safety at Work etc. Act 1974 is up to date with all changes known to be in force on or before 28 April 2021. There are changes that may be brought into force at a future date. Changes that have been made appear in the content and are referenced with annotations. (See end of Document for details) View outstanding changes*

- C404** Ss. 1-59, 80-82 applied (temp.) (5.8.2009) by The Health and Safety at Work etc. Act 1974 (Application outside Great Britain) Order 2001 (S.I. 2001/2127), arts. 8A, 8B (as inserted by S.I. 2009/1750, **art. 2(3)**)
- C408** S. 28 applied (with modifications) (16.1.2012) by The Railways (Interoperability) Regulations 2011 (S.I. 2011/3066), regs. 1(2), **39(2)(3)(f)** (with reg. 3)
- C409** S. 28 applied (with modifications) (17.8.2015) by The Pyrotechnic Articles (Safety) Regulations 2015 (S.I. 2015/1553), reg. 1, Sch. 8 paras. 1(m), **2**
- C410** S. 28 applied (with modifications) (8.12.2016) by The Electrical Equipment (Safety) Regulations 2016 (S.I. 2016/1101), reg. 1, Sch. 4 paras. 1, **2** (with reg. 3)
- C411** S. 28 applied (with modifications) (E.W.S.) (8.12.2016) by The Equipment and Protective Systems Intended for Use in Potentially Explosive Atmospheres Regulations 2016 (S.I. 2016/1107), reg. 1(1), **Sch. 4 para. 1(l)**
- C412** S. 28 applied (with modifications) (8.12.2016) by The Simple Pressure Vessels (Safety) Regulations 2016 (S.I. 2016/1092), reg. 1, Sch. 6 paras. 1(l), **2** (with reg. 3)
- C413** S. 28 applied (with modifications) (8.12.2016) by The Lifts Regulations 2016 (S.I. 2016/1093), reg. 1, Sch. 8 paras. 1(m), **2** (with regs. 3-5)
- C414** S. 28 applied (with modifications) (8.12.2016) by The Pressure Equipment (Safety) Regulations 2016 (S.I. 2016/1105), reg. 1, Sch. 8 paras. 1(l), **2** (with reg. 88)
- C415** S. 28 applied (with modifications) (21.4.2018) by The Personal Protective Equipment (Enforcement) Regulations 2018 (S.I. 2018/390), reg. 1(1), **Sch. 2** (with reg. 2(1)-(3))
- C416** S. 28 applied (with modifications) (21.4.2018) by The Gas Appliances (Enforcement) and Miscellaneous Amendments Regulations 2018 (S.I. 2018/389), reg. 1(1), **Sch. 2** (with reg. 2)
- C417** S. 28(6) extended by S.I. 1985/1884, art. 10, **Sch. 3 para. 4**
s. 28 extended (31.1.1994) by S.I. 1993/3050, **art. 18(1)** (with art. 3).
- C862** Ss. 1, 25, 26, 27, 28, 30, 33, 34, 59, 80, 81 and 82 applied by S.I. 1989/840, **arts. 2, 10**
- C863** S. 28 amended by S.I. 1982/1496, **reg. 10(1)**
S. 28 extended (5.7.1994) by 1994 c. 19, ss. 39, 66(2)(b), **Sch. 13 para. 20(e)** (with ss. 54(5)(7), 55(5), Sch. 17 paras. 22(1), 23(2))
S. 28 restricted (15.11.2000) by S.I. 2000/2831, **reg. 23(1)**
- C864** S. 28 amended by Local Government Act 1985 (c. 51, SIF 81:1), s. 57(7), **Sch. 13 para. 13(f)**
- C865** Ss. 19-28 applied (with modifications) (1.1.1993) by S.I. 1992/3073, reg. 28, **Sch. 6 para. 1(b)**
- C866** Ss. 19-28 modified (6.4.1992) by S.I. 1992/711, **regs. 1(2), 28(3)(b)(5)(a)**
- C867** s. 28 applied (with modifications) (E.W.S.) (22.4.2005) by S.I. 2005/928, **reg. 4(2)-(4)**
- C868** S. 28(7): Disclosure powers extended (14.12.2001) by 2001 c. 24, s. 17, **Sch. 4 Pt. 1 para. 12**

Special provisions relating to agriculture

F143²⁹

Textual Amendments

F143 Ss. 2(5), 29, 31, 32, 50(4)(5), 53(2)–(6) repealed by Employment Protection Act 1975 (c. 71), **Sch. 18**

Modifications etc. (not altering text)

C36 Ss. 1-59 applied by S.I. 2001/2127 art. 8A 8B (as inserted (E.W.S.) (6.4.2011) by The Health and Safety at Work etc. Act 1974 (Application outside Great Britain) (Variation) Order 2011 (S.I. 2011/745), arts. 1(1), **3(2)**)

Changes to legislation: Health and Safety at Work etc. Act 1974 is up to date with all changes known to be in force on or before 28 April 2021. There are changes that may be brought into force at a future date. Changes that have been made appear in the content and are referenced with annotations. (See end of Document for details) View outstanding changes

[^{F144} 30 Agricultural health and safety regulations.

- (1) Regulations under this section (in this Part referred to as “ agricultural health and safety regulations ”) may be made for any of the relevant agricultural purposes.
- (2) Agricultural health and safety regulations may be either regulations applying to Great Britain and made by the Minister of Agriculture, Fisheries and Food and the Secretary of State acting jointly, or regulations applying to England and Wales only and made by the said Minister, or regulations applying to Scotland only and made by the Secretary of State.
- (3) Where health and safety regulations make provision for any purpose with respect to a matter that relates to (but not exclusively to) agricultural operations—
 - (a) provision for that purpose shall not be made with respect to that matter by agricultural health and safety regulations so as to have effect while the first-mentioned provision is in force except for the purpose of imposing requirements additional to those imposed by health and safety regulations, being additional requirements which in the opinion of the authority making the agricultural health and safety regulations are necessary or expedient in the special circumstances of agricultural operations; and
 - (b) in the event of any inconsistency between the first-mentioned provision and any provision made with respect to that matter by agricultural health and safety regulations, the first-mentioned provision shall prevail.
- (4) The provisions of section 15(2) to (10) and Schedule 3 shall have effect in relation to agricultural health and safety regulations as they have effect in relation to health and safety regulations subject to the following modifications, that is to say—
 - (a) references to the relevant statutory provisions or the existing statutory provisions shall be read as references to such of those provisions as relate to agriculture;
 - (b) in section 15(4) the references to the Commission shall be read as references to the appropriate Agriculture Minister;
 - (c) in section 15(6) and (10) and paragraph 23 of Schedule 3, the reference to health and safety regulations shall be read as a reference to agricultural health and safety regulations.
- (5) Without prejudice to the generality of subsection (1) above, agricultural health and safety regulations may, as regards agricultural licences under any of the relevant statutory provisions, make provision for requiring the authority having power to issue, renew, vary, transfer or revoke such licences to notify—
 - (a) any applicant for the issue, renewal, variation or transfer of such a licence of any proposed decision of the authority to refuse the application; or
 - (b) the holder of such a licence of any proposed decision of the authority to revoke the licence or to vary any term, condition or restriction on or subject to which the licence is held;

and for enabling persons aggrieved by any such proposed decision to make representations to, or to a person appointed by, the relevant authority within the period and in the manner prescribed by the regulations.
- (6) In relation to any agricultural health and safety regulations made in pursuance of paragraph 2 of Schedule 3 as applied by this section, subsection (2) above shall have effect as if after the words “Great Britain” there were inserted the words “or the United Kingdom”.]

Changes to legislation: *Health and Safety at Work etc. Act 1974 is up to date with all changes known to be in force on or before 28 April 2021. There are changes that may be brought into force at a future date. Changes that have been made appear in the content and are referenced with annotations. (See end of Document for details) View outstanding changes*

Textual Amendments

F144 S. 30 repealed (E.W.) (S.) by [Employment Protection Act 1975 \(c. 71\)](#), [Sch. 18](#)

Modifications etc. (not altering text)

C36 Ss. 1-59 applied by S.I. 2001/2127 art. 8A 8B (as inserted (E.W.S.) (6.4.2011) by [The Health and Safety at Work etc. Act 1974 \(Application outside Great Britain\) \(Variation\) Order 2011 \(S.I. 2011/745\)](#), arts. 1(1), [3\(2\)](#))

C419 Ss. 1-25, 26, 27, 28, 30, 33, 34-59, 80, 81 and 82 applied by S.I. 1989/840, [arts. 2-10](#)

C420 Ss. 1-59, 80-82 applied (11.7.2001) by S.I. 2001/2127, [arts. 4\(1\)](#), 5(1)(2), 6(1), 7(1), 8(1), 10 (with art. 11) (as amended by S.I. 2009/1750, [art. 2\(2\)\(4\)](#))

C421 Ss. 1-59, 80-82 applied (temp.) (5.8.2009) by [The Health and Safety at Work etc. Act 1974 \(Application outside Great Britain\) Order 2001 \(S.I. 2001/2127\)](#), arts. 8A, 8B (as inserted by S.I. 2009/1750, [art. 2\(3\)](#))

F145 **31**,

32.

Textual Amendments

F145 Ss. 2(5), 29, 31, 32, 50(4)(5), 53(2)-(6) repealed by [Employment Protection Act 1975 \(c. 71\)](#), [Sch. 18](#)

Modifications etc. (not altering text)

C36 Ss. 1-59 applied by S.I. 2001/2127 art. 8A 8B (as inserted (E.W.S.) (6.4.2011) by [The Health and Safety at Work etc. Act 1974 \(Application outside Great Britain\) \(Variation\) Order 2011 \(S.I. 2011/745\)](#), arts. 1(1), [3\(2\)](#))

Provisions as to offences

33 Offences

- (1) It is an offence for a person—
- (a) to fail to discharge a duty to which he is subject by virtue of sections 2 to 7;
 - (b) to contravene section 8 or 9;
 - (c) to contravene any health and safety regulations ^{F146} . . . or any requirement or prohibition imposed under any such regulations (including any requirement or prohibition to which he is subject by virtue of the terms of or any condition or restriction attached to any licence, approval, exemption or other authority issued, given or granted under the regulations);
 - (d) to contravene any requirement imposed by or under regulations under section 14 or intentionally to obstruct any person in the exercise of his powers under that section;
 - (e) to contravene any requirement imposed by an inspector under section 20 or 25;
 - (f) to prevent or attempt to prevent any other person from appearing before an inspector or from answering any question to which an inspector may by virtue of section 20(2) require an answer;

Changes to legislation: *Health and Safety at Work etc. Act 1974 is up to date with all changes known to be in force on or before 28 April 2021. There are changes that may be brought into force at a future date. Changes that have been made appear in the content and are referenced with annotations. (See end of Document for details) View outstanding changes*

- (g) to contravene any requirement or prohibition imposed by an improvement notice or a prohibition notice (including any such notice as modified on appeal);
- (h) intentionally to obstruct an inspector in the exercise or performance of his powers or duties [^{F147} or to obstruct a customs officer in the exercise of his powers under section 25A];
- (i) to contravene any requirement imposed by a notice under section 27(1);
- (j) to use or disclose any information in contravention of section 27(4) or 28;
- (k) to make a statement which he knows to be false or recklessly to make a statement which is false where the statement is made—
 - (i) in purported compliance with a requirement to furnish any information imposed by or under any of the relevant statutory provisions; or
 - (ii) for the purpose of obtaining the issue of a document under any of the relevant statutory provisions to himself or another person;
- (l) intentionally to make a false entry in any register, book, notice or other document required by or under any of the relevant statutory provisions to be kept, served or given or, with intent to deceive, to make use of any such entry which he knows to be false;
- (m) with intent to deceive, to [^{F148} forge or] use a document issued or authorised to be issued under any of the relevant statutory provisions or required for any purpose thereunder or to make or have in his possession a document so closely resembling any such document as to be calculated to deceive;
- (n) falsely to pretend to be an inspector;
- (o) to fail to comply with an order made by a court under section 42.

[^{F149}(2) Schedule 3A (which specifies the mode of trial and maximum penalty applicable to offences under this section and the existing statutory provisions) has effect.

(3) Schedule 3A is subject to any provision made by virtue of section 15(6)(c) or (d).]

^{F150}(5)

^{F151}(6)

Textual Amendments

F146 Words repealed by [Employment Protection Act 1975 \(c. 71\)](#), **Sch. 18**

F147 Words inserted by [Consumer Protection Act 1987 \(c. 43, SIF 109:1\)](#), s. 36, **Sch. 3 para. 6**

F148 Words repealed (E.W.N.I.) by [Forgery and Counterfeiting Act 1981 \(c. 45, SIF 39:7\)](#), s. 30, **Sch. Pt. I**

F149 S. 33(2)(3) substituted (16.1.2009) for s. 33(1A)-(4) by [Health and Safety \(Offences\) Act 2008 \(c. 20\)](#), **ss. 1(1), 3(2)** (with s. 3(3))

F150 S. 33(5) repealed (E.W.S.) (6.3.1992) by [Offshore Safety Act 1992 \(c. 15\)](#), ss. 4(5)(6), 7(2), **Sch.2**

F151 S. 33(6) repealed by [Forgery and Counterfeiting Act 1981 \(c. 45, SIF 39:7\)](#), s. 30, **Sch. Pt. I**

Modifications etc. (not altering text)

C36 Ss. 1-59 applied by S.I. 2001/2127 art. 8A 8B (as inserted (E.W.S.) (6.4.2011) by [The Health and Safety at Work etc. Act 1974 \(Application outside Great Britain\) \(Variation\) Order 2011 \(S.I. 2011/745\)](#), arts. 1(1), **3(2)**)

C422 S. 33 applied by S.I. 1989/840, **arts. 2, 10**

S. 33 extended (E.W.S.) (1.10.1996) by S.I. 1996/1513, **reg. 10 S. 33** excluded (with saving) (E.W.S.) (1.12.1997) by S.I. 1997/1840, **regs. 7, 9**

Changes to legislation: *Health and Safety at Work etc. Act 1974 is up to date with all changes known to be in force on or before 28 April 2021. There are changes that may be brought into force at a future date. Changes that have been made appear in the content and are referenced with annotations. (See end of Document for details) View outstanding changes*

- S. 33 applied (with modifications) (E.W.S.) (1.3.1996) by S.I. 1996/192, reg. 15, **Sch. 14 para. 1(b)**
- S. 33 applied (with modifications) (1.7.1997) by S.I. 1997/831, reg. 19(1)-(4), **Sch. 15 para. 1(a)(b)**
- S. 33 applied (15.11.2000) by S.I. 2000/2831, **reg. 26(1)(a)**
- C423** S. 33 extended (with modifications) (12.4.1999) by S.I. 1999/743, **reg. 20(1)(d)(2)(3)** S. 33 applied (20.9.2001) by S.I. 2001/2975, **reg. 19(d)**
- S. 33 applied (E.W.S.) (24.7.2002) by S.I. 2002/1689, **reg. 14(1)(b)**
- S. 33 applied (16.5.2002) by S.I. 2002/1166, **reg. 31** (with art. 37)
- C424** S. 33 applied (with modifications) (19.11.1999) by S.I. 1999/2892, **reg. 16(1)**
- C425** S. 33 applied (with modifications) (29.11.1999) by S.I. 1999/2001, reg. 24(1), **Sch. 8 para. 1(b)**
- C426** S. 33 applied (11.7.2001) by S.I. 2001/2127, **arts. 4(1), 5(1)(2), 6(1), 7(1), 8(1), 10** (with art. 11) (as amended by S.I. 2009/1750, **art. 2(2)(4)**)
- C427** S. 33 applied (with modifications) (E.W.S.) (3.5.2004) by S.I. 2004/129, **reg. 23(3)(e)**; s. 33 applied (E.W.S.) (22.4.2005) by S.I. 2005/928, **reg. 4(2)(3)(5)(6)**; s. 33 applied (2.4.2006) by S.I. 2006/397, **reg. 34(2)(d)**
- C428** Ss. 1-59, 80-82 applied (temp.) (5.8.2009) by The Health and Safety at Work etc. Act 1974 (Application outside Great Britain) Order 2001 (S.I. 2001/2127), arts. 8A, 8B (as inserted by S.I. 2009/1750, **art. 2(3)**)
- C429** Ss. 33-42 applied (with modifications) (E.W.) (12.8.2009 with application in accordance with reg. 3 of the amending S.I.) by The Major Accident Off-Site Emergency Plan (Management of Waste from Extractive Industries)(England and Wales) Regulations 2009 (S.I. 2009/1927), {reg. 9(1)}
- C430** Ss. 33-35 applied (with modifications) (E.W.S.) (4.7.2010 for certain purposes and otherwise 4.7.2013) by The Pyrotechnic Articles (Safety) Regulations 2010 (S.I. 2010/1554), **regs. 1, 18, 37(1)**, {Sch. 4 paras. 1, 2}
- C431** Ss. 33-42 applied (with modifications) (E.W.S.) (1.9.2013) by The Biocidal Products and Chemicals (Appointment of Authorities and Enforcement) Regulations 2013 (S.I. 2013/1506), regs. 2(1), **8(1)** (with reg. 3(4), (5), 8(2)-(7), 31, 32, 33(1))
- C432** Ss. 33-42 applied (1.3.2014) by The Biocidal Products and Chemicals (Appointment of Authorities and Enforcement) Regulations 2013 (S.I. 2013/1506), regs. 2(4), **19** (with reg. 3(4)(5)313233(1))
- C433** Ss. 33-35 applied (with modifications) (E.W.S.) (1.10.2014) by The Explosives Regulations 2014 (S.I. 2014/1638), reg. 1(1), **Sch. 12 paras. 2, 3**
- C434** Ss. 33-42 applied (1.10.2014) by The Genetically Modified Organisms (Contained Use) Regulations 2014 (S.I. 2014/1663), regs. 1, **30(2)(a)** (with reg. 3(1)(2))
- C435** Ss. 33-42 applied (with modifications) (E.W.S.) (1.6.2015) by The Biocidal Products and Chemicals (Appointment of Authorities and Enforcement) Regulations 2013 (S.I. 2013/1506), regs. 2(2), **17(1)** (with reg. 3(4)(5)313233(1))
- C436** Ss. 33-42 applied (with modifications) (E.W.S.) (1.6.2015) by The Control of Major Accident Hazards Regulations 2015 (S.I. 2015/483), regs. 1(1), **27(1)(d)** (with regs. 3(2), 27(3))
- C437** Ss. 33-42 applied (19.7.2015) by The Offshore Installations (Offshore Safety Directive) (Safety Case etc.) Regulations 2015 (S.I. 2015/398), regs. 1, **36(8)(d)** (with reg. 4(2), Sch. 14)
- C438** Ss. 33-42 applied (19.7.2015) by The Offshore Installations (Offshore Safety Directive) (Safety Case etc.) Regulations 2015 (S.I. 2015/398), regs. 1, **36(1)(d)** (with reg. 4(2), Sch. 14)
- C439** S. 33 applied (with modifications) (17.8.2015) by The Pyrotechnic Articles (Safety) Regulations 2015 (S.I. 2015/1553), reg. 1, **Sch. 8 paras. 1(n), 2**
- C440** Ss. 33-35 applied (with modifications) by S.I. 2014/1638, Sch. 12 paras. 5-7 (as substituted (E.W.S.) (20.4.2016) by The Explosives Regulations 2014 (Amendment) Regulations 2016 (S.I. 2016/315), reg. 1, **Sch. 1** (with regs. 2(1), 15))
- C441** S. 33 applied (with modifications) (E.W.S.) (8.12.2016) by The Equipment and Protective Systems Intended for Use in Potentially Explosive Atmospheres Regulations 2016 (S.I. 2016/1107), reg. 1(1), **Sch. 4 para. 1(m)**
- C442** S. 33 applied (with modifications) (8.12.2016) by The Pressure Equipment (Safety) Regulations 2016 (S.I. 2016/1105), reg. 1, **Sch. 8 paras. 1(m), 2** (with reg. 88)
- C443** S. 33 applied (with modifications) (8.12.2016) by The Electrical Equipment (Safety) Regulations 2016 (S.I. 2016/1101), reg. 1, **Sch. 4 paras. 1, 2** (with reg. 3)

Changes to legislation: Health and Safety at Work etc. Act 1974 is up to date with all changes known to be in force on or before 28 April 2021. There are changes that may be brought into force at a future date. Changes that have been made appear in the content and are referenced with annotations. (See end of Document for details) View outstanding changes

- C444** S. 33 applied (with modifications) (8.12.2016) by [The Lifts Regulations 2016 \(S.I. 2016/1093\)](#), reg. 1, Sch. 8 paras. 1(n), **2** (with regs. 3-5)
- C445** S. 33 applied (with modifications) (8.12.2016) by [The Simple Pressure Vessels \(Safety\) Regulations 2016 \(S.I. 2016/1092\)](#), reg. 1, Sch. 6 paras. 1(m), **2** (with reg. 3)
- C446** S. 33 applied (with modifications) (21.4.2018) by [The Personal Protective Equipment \(Enforcement\) Regulations 2018 \(S.I. 2018/390\)](#), reg. 1(1), **Sch. 2** (with reg. 2(1)-(3))
- C447** S. 33 applied (with modifications) (21.4.2018) by [The Gas Appliances \(Enforcement\) and Miscellaneous Amendments Regulations 2018 \(S.I. 2018/389\)](#), reg. 1(1), **Sch. 2** (with reg. 2)
- C448** S. 33(2) applied (with modifications) (30.7.2018) by [The Cableway Installations Regulations 2018 \(S.I. 2018/816\)](#), regs. 1, **21(1)-(3)** (with reg. 4)
- C449** S. 33(1)(e)-(o) applied (with modifications) (30.7.2018) by [The Cableway Installations Regulations 2018 \(S.I. 2018/816\)](#), regs. 1, **21(1)-(3)** (with reg. 4)
- C450** S. 33(1)(c) applied (with modifications) (30.7.2018) by [The Cableway Installations Regulations 2018 \(S.I. 2018/816\)](#), regs. 1, **21** (with reg. 4)
- C451** S. 33(1)(c) restricted (12.4.1999) by S.I. 1999/743, **reg. 20(2)**
 S. 33(1)(c) excluded (16.5.2002) by S.I. 2002/1166, reg. 31(4) (with art. 37) S. 33(1)(c) modified (E.W.S.) (3.5.2004) by S.I. 2004/129, **reg. 23(4)**
- C452** S. 33(1)(c) (e)-(h) (k)-(o) (2) (2A) (3) applied (with modifications) (E.W.S.) (the amendment coming into force in accordance with art. 1(1) of the amending S.I.) by [The Channel Tunnel \(Safety\) Order 2007 \(S.I. 2007/3531\)](#), **art. 4(2)(3)(h)** (subject to (4)-(6)) (with art. 7)
- C453** S. 33(1)(c) applied (with modifications) (E.W.S.) (6.4.2010) by [The Rail Vehicle Accessibility \(Non-Interoperable Rail System\) Regulations 2010 \(S.I. 2010/432\)](#), **reg. 6(2)(3)(g)** (with reg. 6(4)(5))
- C454** S. 33(1)(c) applied (with modifications) (E.W.S.) (6.4.2010) by [The Train Driving Licences and Certificates Regulations 2010 \(S.I. 2010/724\)](#), regs. 1(2), **38(2)(3)(g)** (with reg. 38(4)(5))
- C455** S. 33(1)(c)(e)-(h)(j)-(o) applied (with modifications) (16.1.2012) by [The Railways \(Interoperability\) Regulations 2011 \(S.I. 2011/3066\)](#), regs. 1(2), **39(2)(3)(g)** (with reg. 3)
- C456** S. 33(1)(c) excluded (1.3.2014) by [The Biocidal Products and Chemicals \(Appointment of Authorities and Enforcement\) Regulations 2013 \(S.I. 2013/1506\)](#), regs. 2(4), **21** (with reg. 3(4)(5)31)
- C457** S. 33(1)(c) excluded (1.10.2014) by [The Genetically Modified Organisms \(Contained Use\) Regulations 2014 \(S.I. 2014/1663\)](#), regs. 1, **30(4)** (with reg. 3(1)(2))
- C458** S. 33(1)(c) applied (E.W.S.) (1.6.2015) by [The Control of Major Accident Hazards Regulations 2015 \(S.I. 2015/483\)](#), regs. 1(1), **27(4)** (with regs. 3(2), 27(3))
- C459** S. 33(1)(e) applied (with modifications) (E.W.S.) (22.3.2003 for certain purposes and 22.9.2003 otherwise) by S.I. 2003/403, regs. 1(2), **23(2)(a)(3)**
- C460** S. 33(1)(e) applied (with modifications) (E.W.S.) (16.4.1996) by S.I. 1996/772, reg. 17; s. 33(1)(e) applied (with modifications) (9.6.2004) by S.I. 2004/1309, **reg. 17**
- C461** S. 33(1)(e)-(h) applied (with modifications) (E.W.S.) (6.4.2010) by [The Rail Vehicle Accessibility \(Non-Interoperable Rail System\) Regulations 2010 \(S.I. 2010/432\)](#), **reg. 6(2)(3)(g)** (with reg. 6(4)(5))
- C462** S. 33(1)(e)-(h) applied (with modifications) (E.W.S.) (6.4.2010) by [The Train Driving Licences and Certificates Regulations 2010 \(S.I. 2010/724\)](#), regs. 1(2), **38(2)(3)(g)** (with reg. 38(4)(5))
- C463** S. 33(1)(f) applied (with modifications) (E.W.S.) (22.3.2003 for certain purposes and 22.9.2003 otherwise) by S.I. 2003/403, regs. 1(2), **23(2)(a)(3)**
- C464** S. 33(1)(f) modified (6.4.1992) by S.I. 1992/711, **regs. 1(2)**, 28(3)(b)(5)(a)
- C465** Ss. 33(1)(f) applied (9.1.1995) by S.I. 1994/3260, **reg. 17(3)(5)**
- C466** S. 33(1)(f): power to apply conferred (E.W.S.) (28.8.1995) by 1995 c. 15, **ss. 2(4)(f)**, 5 (with s. 3(5))
- C467** S. 33(1)(f) applied (with modifications) (E.W.S.) (16.4.1996) by S.I. 1996/772, reg. 17; s. 33(1)(f) applied (with modifications) (9.6.2004) by S.I. 2004/1309, **reg. 17**
- C468** S. 33(1)(c) (e)-(h) (k)-(o) (2) (2A) (3) applied (with modifications) (E.W.S.) (the amendment coming into force in accordance with art. 1(1) of the amending S.I.) by [The Channel Tunnel \(Safety\) Order 2007 \(S.I. 2007/3531\)](#), **art. 4(2)(3)(h)** (subject to (4)-(6)) (with art. 7)
- C469** S. 33(1)(g) modified (6.4.1992) by S.I. 1992/711, **regs. 1(2)**, 28(3)(b)(5)(a)
- C470** S. 33(1)(g) applied (9.1.1995) by S.I. 1994/3260, **reg. 17(3)(5)**
- C471** S. 33(1)(g): power to apply conferred (E.W.S.) (28.8.1995) by 1995 c. 15, **ss. 2(4)(f)**, 5 (with s. 3(5))

Changes to legislation: *Health and Safety at Work etc. Act 1974 is up to date with all changes known to be in force on or before 28 April 2021. There are changes that may be brought into force at a future date. Changes that have been made appear in the content and are referenced with annotations. (See end of Document for details) View outstanding changes*

- C472** S. 33(1)(g) applied (with modifications) (E.W.S.) (16.4.1996) by S.I. 1996/772, reg. 17; s. 33(1)(g) applied (with modifications) (9.6.2004) by S.I. 2004/1309, reg. 17
- C473** S. 33(1)(g): power to apply conferred (E.W.S.) (28.8.1995) by 1995 c. 15, ss. 2(4)(f), 5 (with s. 3(5))
- C474** S. 33(1)(c) (e)-(h) (k)-(o) (2) (2A) (3) applied (with modifications) (E.W.S.) (the amendment coming into force in accordance with art. 1(1) of the amending S.I.) by The Channel Tunnel (Safety) Order 2007 (S.I. 2007/3531), art. 4(2)(3)(h) (subject to (4)-(6)) (with art. 7)
- C475** S. 33(1)(h) applied (with modifications) (E.W.S.) (22.3.2003 for certain purposes and 22.9.2003 otherwise) by S.I. 2003/403, regs. 1(2), 23(2)(a)(3)
- C476** S. 33(1)(h) modified (6.4.1992) by S.I. 1992/711, regs. 1(2), 28(3)(b)(5)(a)
- C477** Ss. 33(1)(h) applied (9.1.1995) by S.I. 1994/3260, reg. 17(3)(5)
- C478** S. 33(1)(h): power to apply conferred (E.W.S.) (28.8.1995) by 1995 c. 15, ss. 2(4)(f), 5 (with s. 3(5))
- C479** Ss. 33(1)(h) applied (with modifications) (E.W.S.) (16.4.1996) by S.I. 1996/772, reg. 17; s. 33(1)(h) applied (with modifications) (9.6.2004) by S.I. 2004/1309, reg. 17
- C480** S. 33(1)(c) (e)-(h) (k)-(o) (2) (2A) (3) applied (with modifications) (E.W.S.) (the amendment coming into force in accordance with art. 1(1) of the amending S.I.) by The Channel Tunnel (Safety) Order 2007 (S.I. 2007/3531), art. 4(2)(3)(h) (subject to (4)-(6)) (with art. 7)
- C481** S. 33(1)(i) applied (with modifications) (E.W.S.) (22.3.2003 for certain purposes and 22.9.2003 otherwise) by S.I. 2003/403, regs. 1(2), 23(2)(a)(3)
- C482** S. 33(1)(i) modified (6.4.1992) by S.I. 1992/711, regs. 1(2), 28(3)(b)(5)(a)
- C483** S. 33(1)(i): power to apply conferred (E.W.S.) (28.8.1995) by 1995 c. 15, ss. 2(4)(f), 5 (with s. 3(5))
- C484** S. 33(1)(i) applied (with modifications) (E.W.S.) (16.4.1996) by S.I. 1996/772, reg. 17; s. 33(1)(i) applied (with modifications) (9.6.2004) by S.I. 2004/1309, reg. 17
- C485** S. 33(1)(j) applied (with modifications) (E.W.S.) (22.3.2003 for certain purposes and 22.9.2003 otherwise) by S.I. 2003/403, regs. 1(2), 23(2)(a)(3)
- C486** S. 33(1)(j) modified (6.4.1992) by S.I. 1992/711, regs. 1(2), 28(3)(b)(5)(a)
- C487** S. 33(1)(j): power to apply conferred (E.W.S.) (28.8.1995) by 1995 c. 15, ss. 2(4)(f), 5 (with s. 3(5))
- C488** S. 33(1)(j)-(o) applied (with modifications) (E.W.S.) (6.4.2010) by The Rail Vehicle Accessibility (Non-Interoperable Rail System) Regulations 2010 (S.I. 2010/432), reg. 6(2)(3)(g) (with reg. 6(4)(5))
- C489** S. 33(1)(j)-(o) applied (with modifications) (E.W.S.) (6.4.2010) by The Train Driving Licences and Certificates Regulations 2010 (S.I. 2010/724), regs. 1(2), 38(2)(3)(g) (with reg. 38(4)(5))
- C490** S. 33(1)(k) applied (with modifications) (E.W.S.) (22.3.2003 for certain purposes and 22.9.2003 otherwise) by S.I. 2003/403, regs. 1(2), 23(2)(a)(3)
- C491** S. 33(1)(k) modified (6.4.1992) by S.I. 1992/711, regs. 1(2), 28(3)(b)(5)(a)
- C492** S. 33(1)(l) applied (with modifications) (E.W.S.) (22.3.2003 for certain purposes and 22.9.2003 otherwise) by S.I. 2003/403, regs. 1(2), 23(2)(a)(3)
- C493** S. 33(1)(l) modified (6.4.1992) by S.I. 1992/711, regs. 1(2), 28(3)(b)(5)(a)
- C494** S. 33(1)(c) (e)-(h) (k)-(o) (2) (2A) (3) applied (with modifications) (E.W.S.) (the amendment coming into force in accordance with art. 1(1) of the amending S.I.) by The Channel Tunnel (Safety) Order 2007 (S.I. 2007/3531), art. 4(2)(3)(h) (subject to (4)-(6)) (with art. 7)
- C495** S. 33(1)(m) applied (with modifications) (E.W.S.) (22.3.2003 for certain purposes and 22.9.2003 otherwise) by S.I. 2003/403, regs. 1(2), 23(2)(a)(3)
- C496** S. 33(1)(m) modified (6.4.1992) by S.I. 1992/711, regs. 1(2), 28(3)(b)(5)(a)
- C497** S. 33(1)(c) (e)-(h) (k)-(o) (2) (2A) (3) applied (with modifications) (E.W.S.) (the amendment coming into force in accordance with art. 1(1) of the amending S.I.) by The Channel Tunnel (Safety) Order 2007 (S.I. 2007/3531), art. 4(2)(3)(h) (subject to (4)-(6)) (with art. 7)
- C498** S. 33(1)(n) applied (with modifications) (E.W.S.) (22.3.2003 for certain purposes and 22.9.2003 otherwise) by S.I. 2003/403, regs. 1(2), 23(2)(a)(3)
- C499** S. 33(1)(n): power to apply conferred (E.W.S.) (28.8.1995) by 1995 c. 15, ss. 2(4)(f), 5 (with s. 3(5))
- C500** S. 33(1)(n) applied (with modifications) (E.W.S.) (16.4.1996) by S.I. 1996/772, reg. 17; s. 33(1)(n) applied (with modifications) (9.6.2004) by S.I. 2004/1309, reg. 17
- C501** S. 33(1)(c) (e)-(h) (k)-(o) (2) (2A) (3) applied (with modifications) (E.W.S.) (the amendment coming into force in accordance with art. 1(1) of the amending S.I.) by The Channel Tunnel (Safety) Order 2007 (S.I. 2007/3531), art. 4(2)(3)(h) (subject to (4)-(6)) (with art. 7)

Changes to legislation: *Health and Safety at Work etc. Act 1974 is up to date with all changes known to be in force on or before 28 April 2021. There are changes that may be brought into force at a future date. Changes that have been made appear in the content and are referenced with annotations. (See end of Document for details) View outstanding changes*

- C502** S. 33(1)(o) applied (with modifications) (E.W.S.) (22.3.2003 for certain purposes and 22.9.2003 otherwise) by [S.I. 2003/403, regs. 1\(2\), 23\(2\)\(a\)\(3\)](#)
- C503** Ss. 33(1)(o) applied (9.1.1995) by [S.I. 1994/3260, reg. 17\(3\)\(5\)](#)
- C504** S. 33(1)(o): power to apply conferred (E.W.S.) (28.8.1995) by [1995 c. 15, ss. 2\(4\)\(f\), 5](#) (with [s. 3\(5\)](#))
- C505** S. 33(1)(o) applied (with modifications) (E.W.S.) (16.4.1996) by [S.I. 1996/772, reg. 17](#); [s. 33\(1\)\(o\)](#) applied (with modifications) (9.6.2004) by [S.I. 2004/1309, reg. 17](#)
- C506** S. 33(1)(c) (e)-(h) (k)-(o) (2) (2A) (3) applied (with modifications) (E.W.S.) (the amendment coming into force in accordance with art. 1(1) of the amending S.I.) by [The Channel Tunnel \(Safety\) Order 2007 \(S.I. 2007/3531\), art. 4\(2\)\(3\)\(h\)](#) (subject to (4)-(6)) (with [art. 7](#))

34 Extension of time for bringing summary proceedings.

(1) Where—

- (a) a special report on any matter to which section 14 of this Act applies is made by virtue of subsection ^{F152}[^{F152}(2)] of that section; or
- (b) a report is made by the person holding an inquiry into any such matter by virtue of subsection ^{F153}[^{F153}(2A)] of that section; or
- (c) ^{F154}[^{F154}an investigation under Part 1 of the Coroners and Justice Act 2009 is conducted into] the death of any person whose death may have been caused by an accident which happened while he was at work or by a disease which he contracted or probably contracted at work or by any accident, act or omission which occurred in connection with the work of any person whatsoever; or
- ^{F155}^{F156}[^{F156}(d) an inquiry into any death that may have been so caused is held under the Inquiries into Fatal Accidents and Sudden Deaths etc. (Scotland) Act 2016,] and it appears ^{F157}[^{F157}from the report or investigation or, in a case falling within paragraph (d) above, from the proceedings at the] inquiry, that any of the relevant statutory provisions was contravened at a time which is material in relation to the subject-matter of the ^{F158}[^{F158}report, investigation or inquiry], summary proceedings against any person liable to be proceeded against in respect of the contravention may be commenced at any time within three months of the making of the report or, in a case falling within paragraph (c) or (d) above, within three months of the ^{F159}[^{F159}conclusion of the investigation] or inquiry.

(2) Where an offence under any of the relevant statutory provisions is committed by reason of a failure to do something at or within a time fixed by or under any of those provisions, the offence shall be deemed to continue until that thing is done.

(3) Summary proceedings for an offence to which this subsection applies may be commenced at any time within six months from the date on which there comes to the knowledge of a responsible enforcing authority evidence sufficient in the opinion of that authority to justify a prosecution for that offence; and for the purposes of this subsection—

- (a) a certificate of an enforcing authority stating that such evidence came to its knowledge on a specified date shall be conclusive evidence of that fact; and
- (b) a document purporting to be such a certificate and to be signed by or on behalf of the enforcing authority in question shall be presumed to be such a certificate unless the contrary is proved.

(4) The preceding subsection applies to any offence under any of the relevant statutory provisions which a person commits by virtue of any provision or requirement to which he is subject as the designer, manufacturer, importer or supplier of any thing; and in that subsection “responsible enforcing authority” means an enforcing authority

Changes to legislation: *Health and Safety at Work etc. Act 1974 is up to date with all changes known to be in force on or before 28 April 2021. There are changes that may be brought into force at a future date. Changes that have been made appear in the content and are referenced with annotations. (See end of Document for details) View outstanding changes*

within whose field of responsibility the offence in question lies, whether by virtue of section 35 or otherwise.

(5) In the application of subsection (3) above to Scotland—

- (a) for the words from “there comes” to “that offence” there shall be substituted the words “evidence, sufficient in the opinion of the enforcing authority to justify a report to the Lord Advocate with a view to consideration of the question of prosecution, comes to the knowledge of the authority”;
- (b) at the end of paragraph (b) there shall be added the words “and
- (c) section [F160]331(3) of the M3 Criminal Procedure (Scotland) Act 1975] (date of commencement of proceedings) shall have effect as it has effect for the purposes of that section.”

[F161] (6) In the application of subsection (4) above to Scotland, after the words “applies to” there shall be inserted the words “any offence under section 33(1)(c) above where the health and safety regulations concerned were made for the general purpose mentioned in section 18(1) of the Gas Act 1986 and”.]

Textual Amendments

- F152** Words in s. 34(1)(a) substituted (1.4.2008) by [The Legislative Reform \(Health and Safety Executive\) Order 2008 \(S.I. 2008/960\)](#), [art. 13\(a\)](#) (with art. 21, Sch. 2)
- F153** Words in s. 34(1)(b) substituted (1.4.2008) by [The Legislative Reform \(Health and Safety Executive\) Order 2008 \(S.I. 2008/960\)](#), [art. 13\(b\)](#) (with art. 21, Sch. 2)
- F154** Words in s. 34(1)(c) substituted (25.7.2013) by [Coroners and Justice Act 2009 \(c. 25\)](#), s. 182(4)(e), [Sch. 21 para. 25\(2\)](#) (with s. 180); S.I. 2013/1869, art. 2(o)(xi)
- F155** S. 34(1)(d) substituted (S.) (15.6.2017) by [Inquiries into Fatal Accidents and Sudden Deaths etc. \(Scotland\) Act 2016 \(asp 2\)](#), s. 42(2), [sch. 2 para. 2\(3\)](#); S.S.I. 2017/155, reg. 2 (with regs. 4(2)5)
- F156** S. 34(1)(d) substituted (E.W.N.I.) (15.6.2017) by [The Inquiries into Fatal Accidents and Sudden Deaths etc. \(Scotland\) Act 2016 \(Consequential Provisions and Modifications\) Order 2016 \(S.I. 2016/1142\)](#), art. 1(2), [Sch. para. 3\(3\)](#) (with art. 7(2)); S.S.I. 2017/155, reg. 2
- F157** Words in s. 34(1) substituted (25.7.2013) by [Coroners and Justice Act 2009 \(c. 25\)](#), s. 182(4)(e), [Sch. 21 para. 25\(3\)](#) (with s. 180); S.I. 2013/1869, art. 2(o)(xi)
- F158** Words in s. 34(1) substituted (25.7.2013) by [Coroners and Justice Act 2009 \(c. 25\)](#), s. 182(4)(e), [Sch. 21 para. 25\(4\)](#) (with s. 180); S.I. 2013/1869, art. 2(o)(xi)
- F159** Words in s. 34(1) substituted (25.7.2013) by [Coroners and Justice Act 2009 \(c. 25\)](#), s. 182(4)(e), [Sch. 21 para. 25\(5\)](#) (with s. 180); S.I. 2013/1869, art. 2(o)(xi)
- F160** Words substituted by [Criminal Procedure \(Scotland\) Act 1975 \(c. 21\)](#), [Sch. 9 para. 51](#)
- F161** S. 34(6) inserted by [Gas Act 1986 \(c. 44, SIF 44:2\)](#), s. 67(1), [Sch. 7 para. 18](#)

Modifications etc. (not altering text)

- C36** Ss. 1-59 applied by S.I. 2001/2127 art. 8A 8B (as inserted (E.W.S.) (6.4.2011) by [The Health and Safety at Work etc. Act 1974 \(Application outside Great Britain\) \(Variation\) Order 2011 \(S.I. 2011/745\)](#), arts. 1(1), [3\(2\)](#))
- C431** Ss. 33-42 applied (with modifications) (E.W.S.) (1.9.2013) by [The Biocidal Products and Chemicals \(Appointment of Authorities and Enforcement\) Regulations 2013 \(S.I. 2013/1506\)](#), regs. 2(1), [8\(1\)](#) (with reg. 3(4), (5), 8(2)-(7), 31, 32, 33(1))
- C432** Ss. 33-42 applied (1.3.2014) by [The Biocidal Products and Chemicals \(Appointment of Authorities and Enforcement\) Regulations 2013 \(S.I. 2013/1506\)](#), regs. 2(4), [19](#) (with reg. 3(4)(5)313233(1))
- C433** Ss. 33-35 applied (with modifications) (E.W.S.) (1.10.2014) by [The Explosives Regulations 2014 \(S.I. 2014/1638\)](#), reg. 1(1), [Sch. 12 paras. 2, 3](#)
- C434** Ss. 33-42 applied (1.10.2014) by [The Genetically Modified Organisms \(Contained Use\) Regulations 2014 \(S.I. 2014/1663\)](#), regs. 1, [30\(2\)\(a\)](#) (with reg. 3(1)(2))

Changes to legislation: Health and Safety at Work etc. Act 1974 is up to date with all changes known to be in force on or before 28 April 2021. There are changes that may be brought into force at a future date. Changes that have been made appear in the content and are referenced with annotations. (See end of Document for details) View outstanding changes

- C435** Ss. 33-42 applied (with modifications) (E.W.S.) (1.6.2015) by **The Biocidal Products and Chemicals (Appointment of Authorities and Enforcement) Regulations 2013** (S.I. 2013/1506), regs. 2(2), **17(1)** (with reg. 3(4)(5)313233(1))
- C436** Ss. 33-42 applied (with modifications) (E.W.S.) (1.6.2015) by **The Control of Major Accident Hazards Regulations 2015** (S.I. 2015/483), regs. 1(1), **27(1)(d)** (with regs. 3(2), 27(3))
- C437** Ss. 33-42 applied (19.7.2015) by **The Offshore Installations (Offshore Safety Directive) (Safety Case etc.) Regulations 2015** (S.I. 2015/398), regs. 1, **36(8)(d)** (with reg. 4(2), Sch. 14)
- C438** Ss. 33-42 applied (19.7.2015) by **The Offshore Installations (Offshore Safety Directive) (Safety Case etc.) Regulations 2015** (S.I. 2015/398), regs. 1, **36(1)(d)** (with reg. 4(2), Sch. 14)
- C440** Ss. 33-35 applied (with modifications) by S.I. 2014/1638, Sch. 12 paras. 5-7 (as substituted (E.W.S.) (20.4.2016) by **The Explosives Regulations 2014 (Amendment) Regulations 2016** (S.I. 2016/315), reg. 1, **Sch. 1** (with regs. 2(1), 15))
- C507** Ss. 33-42 applied (with modifications) (E.W.) (12.8.2009 with application in accordance with reg. 3 of the amending S.I.) by **The Major Accident Off-Site Emergency Plan (Management of Waste from Extractive Industries)(England and Wales) Regulations 2009** (S.I. 2009/1927), {reg. 9(1)}
- C508** Ss. 1-59, 80-82 applied (temp.) (5.8.2009) by **The Health and Safety at Work etc. Act 1974 (Application outside Great Britain) Order 2001** (S.I. 2001/2127), arts. 8A, 8B (as inserted by S.I. 2009/1750, **art. 2(3)**)
- C509** S. 34 applied by S.I. 1989/840, **arts. 2-10**
 S. 34 excluded (with saving) (E.W.S.) (1.12.1997) by S.I. 1997/1840, **regs. 7, 9**
 S. 34 extended (E.W.S.) (1.10.1996) by S.I. 1996/1513, **reg. 10**
 S. 34 applied (with modifications) (E.W.S.) (1.3.1996) by S.I. 1996/192, reg. 15, **Sch. 14 para. 1(b)**
 S. 34 applied (with modifications) (1.7.1997) by S.I. 1997/831, reg. 19(1)-(4), **Sch. 15 para. 1(a)(b)**
 S. 34 applied (15.11.2000) by S.I. 2000/2831, **reg. 26(1)(a)**
- C510** Ss. 33-35 applied (with modifications) (1.1.1993) by S.I. 1992/3073, reg. 28, **Sch. 6 para. 1(b)**
- C511** S. 34 applied (with modifications) (1.1.1993) by S.I. 1992/3073, reg. 28, **Sch. 6 para. 3(e)(i)**
- C512** Ss. 33-42 applied (with modifications) (1.4.1999) by S.I. 1999/743, **reg. 20(1)(d)**, (2)(3)
- C513** Ss. 33-42 applied (with modifications) (19.11.1999) by S.I. 1999/2892, **reg. 16(1)**
 Ss. 33-42 applied (20.9.2001) by S.I. 2001/2975, **reg. 19(d)**
- C514** Ss. 34 applied (with modifications) (29.11.1999) by S.I. 1999/2001, reg. 24(1), **Sch. 8 para. 1(b)**
 S. 34 applied (E.W.S.) (24.7.2002) by S.I. 2002/1689, **reg. 14(1)(b)**
 S. 34 applied (16.5.2002) by S.I. 2002/1166, **reg. 31** (with art. 37)
- C515** S. 34 applied (11.7.2001) by S.I. 2001/2127, **arts. 4(1)**, 5(1)(2), 6(1), 7(1), 8(1), 10 (with art. 11) (as amended by S.I. 2009/1750, **art. 2(2)(4)**)
- C516** S. 34 applied (with modifications) (E.W.S) (3.5.2004) by S.I. 2004/129, **reg. 23(3)(e)**
 S. 34 applied (E.W.S.) (22.4.2005) by S.I. 2005/928, **reg. 4(2)(3)(5)(6)**
 S. 34 applied (2.4.2006) by S.I. 2006/397, **reg. 34(3)(d)**
- C517** Ss. 33-35 applied (with modifications) (E.W.S.) (4.7.2010 for certain purposes and otherwise 4.7.2013) by **The Pyrotechnic Articles (Safety) Regulations 2010** (S.I. 2010/1554), **regs. 1, 18, 37(1)**, {Sch. 4 paras. 1, 2}
- C518** S. 34 applied (with modifications) (17.8.2015) by **The Pyrotechnic Articles (Safety) Regulations 2015** (S.I. 2015/1553), reg. 1, **Sch. 8 paras. 1(o), 2**
- C519** S. 34 applied (with modifications) (E.W.S.) (8.12.2016) by **The Equipment and Protective Systems Intended for Use in Potentially Explosive Atmospheres Regulations 2016** (S.I. 2016/1107), reg. 1(1), **Sch. 4 para. 1(n)**
- C520** S. 34 applied (with modifications) (8.12.2016) by **The Pressure Equipment (Safety) Regulations 2016** (S.I. 2016/1105), reg. 1, **Sch. 8 paras. 1(n), 2** (with reg. 88)
- C521** S. 34 applied (with modifications) (8.12.2016) by **The Electrical Equipment (Safety) Regulations 2016** (S.I. 2016/1101), reg. 1, **Sch. 4 paras. 1, 2** (with reg. 3)
- C522** S. 34 applied (with modifications) (8.12.2016) by **The Lifts Regulations 2016** (S.I. 2016/1093), reg. 1, **Sch. 8 paras. 1(o), 2** (with regs. 3-5)
- C523** S. 34 applied (with modifications) (8.12.2016) by **The Simple Pressure Vessels (Safety) Regulations 2016** (S.I. 2016/1092), reg. 1, **Sch. 6 paras. 1(n), 2** (with reg. 3)

Changes to legislation: *Health and Safety at Work etc. Act 1974 is up to date with all changes known to be in force on or before 28 April 2021. There are changes that may be brought into force at a future date. Changes that have been made appear in the content and are referenced with annotations. (See end of Document for details) View outstanding changes*

- C524** S. 34 applied (with modifications) (21.4.2018) by **The Gas Appliances (Enforcement) and Miscellaneous Amendments Regulations 2018** (S.I. 2018/389), reg. 1(1), **Sch. 2** (with reg. 2)
- C525** S. 34 applied (with modifications) (21.4.2018) by **The Personal Protective Equipment (Enforcement) Regulations 2018** (S.I. 2018/390), reg. 1(1), **Sch. 2** (with reg. 2(1)-(3))
- C526** Ss. 34-42 applied (with modifications) (30.7.2018) by **The Cableway Installations Regulations 2018** (S.I. 2018/816), regs. 1, **21(1)-(3)** (with reg. 4)
- C527** S. 34(1)(c) applied (with modifications) (E.W.S.) (the amendment coming into force in accordance with art. 1(1) of the amending S.I.) by **The Channel Tunnel (Safety) Order 2007** (S.I. 2007/3531), **art. 4(2)(3)(h)** (subject to (4)-(6)) (with art. 7)
- C528** S. 34(1)(d) applied (with modifications) (E.W.S.) (the amendment coming into force in accordance with art. 1(1) of the amending S.I.) by **The Channel Tunnel (Safety) Order 2007** (S.I. 2007/3531), **art. 4(2)(3)(h)** (subject to (4)-(6)) (with art. 7)
- C529** S. 34(2) applied (with modifications) (E.W.S) (9.6.2004) by **S.I. 2004/1309**, **reg. 17**
- C530** S. 34(2)-(6): power to apply conferred (E.W.S.) (28.8.1995) by **1995 c. 15**, **ss. 2(4)(g)**, 5 (with s. 3(5))
- C531** S. 34 applied (with modifications) (E.W.S.) (16.4.1996) by **S.I. 1996/772**, **reg. 17**
- C532** S. 34(2)-(5) applied (with modifications) (E.W.S.) (the amendment coming into force in accordance with art. 1(1) of the amending S.I.) by **The Channel Tunnel (Safety) Order 2007** (S.I. 2007/3531), **art. 4(2)(3)(h)** (subject to (4)-(6)) (with art. 7)
- C533** S. 34(2) applied (with modifications) (E.W.S.) (6.4.2010) by **The Rail Vehicle Accessibility (Non-Interoperable Rail System) Regulations 2010** (S.I. 2010/432), **reg. 6(2)(3)(g)**
- C534** S. 34(2) applied (with modifications) (E.W.S.) (6.4.2010) by **The Train Driving Licences and Certificates Regulations 2010** (S.I. 2010/724), regs. 1(2), **38(2)(3)(g)**
- C535** S. 34(2)-(5) applied (with modifications) (16.1.2012) by **The Railways (Interoperability) Regulations 2011** (S.I. 2011/3066), regs. 1(2), **39(2)(3)(g)** (with reg. 3)
- C536** S. 34(3) applied (with modifications) (E.W.S) (9.6.2004) by **S.I. 2004/1309**, **reg. 17**
- C537** S. 34(3)(4)(5) modified (6.4.1992) by **S.I. 1992/711**, **regs. 1(2)**, 28(3)(b)(5)(a)
S. 34(3)(4)(5) applied (with modifications) (18.7.1995) by **S.I. 1995/1629**, **reg. 30(3)(b)(5)**
- C538** S. 34(3) applied (with modifications) (E.W.S.) (16.4.1996) by **S.I. 1996/772**, **reg. 17**
- C539** S. 34(3) applied (with modifications) (E.W.S.) (9.1.1995) by **S.I. 1994/3260**, **reg. 17(3)**
- C540** S. 34(2)-(5) applied (with modifications) (E.W.S.) (the amendment coming into force in accordance with art. 1(1) of the amending S.I.) by **The Channel Tunnel (Safety) Order 2007** (S.I. 2007/3531), **art. 4(2)(3)(h)** (subject to (4)-(6)) (with art. 7)
- C541** S. 34(4) applied (with modifications) (E.W.S) (9.6.2004) by **S.I. 2004/1309**, **reg. 17**
- C542** S. 34(4) applied (with modifications) (9.1.1995) by **S.I. 1994/3260**, **reg. 17(3)(5)**
- C543** S. 34(4) modified (6.4.1992) by **S.I. 1992/711**, **regs. 1(2)**, 28(3)(b)(5)(a)
S. 34(4) applied (with modifications) (18.7.1995) by **S.I. 1995/1629**, **reg. 30(3)(b)(5)**
- C544** S. 34(4) applied (with modifications) (9.1.1995) by **S.I. 1994/3260**, **reg. 17(3)(5)**
- C545** S. 34(4) applied (with modifications) (E.W.S.) (16.4.1996) by **S.I. 1996/772**, **reg. 17**
- C546** S. 34(2)-(5) applied (with modifications) (E.W.S.) (the amendment coming into force in accordance with art. 1(1) of the amending S.I.) by **The Channel Tunnel (Safety) Order 2007** (S.I. 2007/3531), **art. 4(2)(3)(h)** (subject to (4)-(6)) (with art. 7)
- C547** S. 34(5) applied (with modifications) (E.W.S) (9.6.2004) by **S.I. 2004/1309**, **reg. 17**
- C548** S. 34(5) modified (6.4.1992) by **S.I. 1992/711**, **regs. 1(2)**, 28(3)(b)(5)(a)
S. 34(5) applied (with modifications) (18.7.1995) by **S.I. 1995/1629**, **reg. 30(3)(b)(5)**
- C549** S. 34(5) applied (with modifications) (9.1.1995) by **S.I. 1994/3260**, **reg. 17(3)(5)**
- C550** S. 34(5) applied (with modifications) (E.W.S.) (16.4.1996) by **S.I. 1996/772**, **reg. 17**
- C551** S. 34(2)-(5) applied (with modifications) (E.W.S.) (the amendment coming into force in accordance with art. 1(1) of the amending S.I.) by **The Channel Tunnel (Safety) Order 2007** (S.I. 2007/3531), **art. 4(2)(3)(h)** (subject to (4)-(6)) (with art. 7)
- C552** S. 34(6) applied (with modifications) (E.W.S) (9.6.2004) by **S.I. 2004/1309**, **reg. 17**
- C553** S. 34(6) applied (with modifications) (E.W.S.) (16.4.1996) by **S.I. 1996/772**, **reg. 17**

Changes to legislation: *Health and Safety at Work etc. Act 1974 is up to date with all changes known to be in force on or before 28 April 2021. There are changes that may be brought into force at a future date. Changes that have been made appear in the content and are referenced with annotations. (See end of Document for details) View outstanding changes*

Marginal Citations

M3 1975 c. 21.

35 Venue.

An offence under any of the relevant statutory provisions committed in connection with any plant or substance may, if necessary for the purpose of bringing the offence within the field of responsibility of any enforcing authority or conferring jurisdiction on any court to entertain proceedings for the offence, be treated as having been committed at the place where that plant or substance is for the time being.

Modifications etc. (not altering text)

- C36** Ss. 1-59 applied by S.I. 2001/2127 art. 8A 8B (as inserted (E.W.S.) (6.4.2011) by [The Health and Safety at Work etc. Act 1974 \(Application outside Great Britain\) \(Variation\) Order 2011 \(S.I. 2011/745\)](#), arts. 1(1), **3(2)**)
- C431** Ss. 33-42 applied (with modifications) (E.W.S.) (1.9.2013) by [The Biocidal Products and Chemicals \(Appointment of Authorities and Enforcement\) Regulations 2013 \(S.I. 2013/1506\)](#), regs. 2(1), **8(1)** (with reg. 3(4), (5), 8(2)-(7), 31, 32, 33(1))
- C432** Ss. 33-42 applied (1.3.2014) by [The Biocidal Products and Chemicals \(Appointment of Authorities and Enforcement\) Regulations 2013 \(S.I. 2013/1506\)](#), regs. 2(4), **19** (with reg. 3(4)(5)313233(1))
- C433** Ss. 33-35 applied (with modifications) (E.W.S.) (1.10.2014) by [The Explosives Regulations 2014 \(S.I. 2014/1638\)](#), reg. 1(1), Sch. 12 paras. 2, **3**
- C434** Ss. 33-42 applied (1.10.2014) by [The Genetically Modified Organisms \(Contained Use\) Regulations 2014 \(S.I. 2014/1663\)](#), regs. 1, **30(2)(a)** (with reg. 3(1)(2))
- C435** Ss. 33-42 applied (with modifications) (E.W.S.) (1.6.2015) by [The Biocidal Products and Chemicals \(Appointment of Authorities and Enforcement\) Regulations 2013 \(S.I. 2013/1506\)](#), regs. 2(2), **17(1)** (with reg. 3(4)(5)313233(1))
- C436** Ss. 33-42 applied (with modifications) (E.W.S.) (1.6.2015) by [The Control of Major Accident Hazards Regulations 2015 \(S.I. 2015/483\)](#), regs. 1(1), **27(1)(d)** (with regs. 3(2), 27(3))
- C437** Ss. 33-42 applied (19.7.2015) by [The Offshore Installations \(Offshore Safety Directive\) \(Safety Case etc.\) Regulations 2015 \(S.I. 2015/398\)](#), regs. 1, **36(8)(d)** (with reg. 4(2), Sch. 14)
- C438** Ss. 33-42 applied (19.7.2015) by [The Offshore Installations \(Offshore Safety Directive\) \(Safety Case etc.\) Regulations 2015 \(S.I. 2015/398\)](#), regs. 1, **36(1)(d)** (with reg. 4(2), Sch. 14)
- C440** Ss. 33-35 applied (with modifications) by S.I. 2014/1638, Sch. 12 paras. 5-7 (as substituted (E.W.S.) (20.4.2016) by [The Explosives Regulations 2014 \(Amendment\) Regulations 2016 \(S.I. 2016/315\)](#), reg. 1, **Sch. 1** (with regs. 2(1), 15))
- C526** Ss. 34-42 applied (with modifications) (30.7.2018) by [The Cableway Installations Regulations 2018 \(S.I. 2018/816\)](#), regs. 1, **21(1)-(3)** (with reg. 4)
- C554** S. 35 applied by S.I. 1989/840, **arts. 2-10**
 S. 35 excluded (with saving) (E.W.S.) (1.12.1997) by S.I. 1997/1840, **regs. 7, 9**
 S. 35 applied (with modifications) (E.W.S.) (9.1.1995) by S.I. 1994/3260, **reg. 17(3)(5)**
 S. 35: power to apply conferred (E.W.S.) (28.8.1995) by 1995 c. 15, **ss. 2(4)(a)**, 5 (with s. 3(5))
 S. 35 applied (with modifications) (E.W.S.) (1.3.1996) by S.I. 1996/192, reg. 15, **Sch. 14 para. 1(b) S. 35** applied (with modifications) (1.7.1997) by S.I. 1997/831, reg. 19(1)-(4), **Sch. 15 para. 1(a)(b)**
 S. 35 applied (15.11.2000) by S.I. 2000/2831, **reg. 26(1)(a)**
- C555** Ss. 35 applied (with modifications) (1.1.1993) by S.I. 1992/3073, reg. 28, **Sch. 6 para. 1(b)**
- C556** Ss. 35-39 modified (6.4.1992) by S.I. 1992/711, **regs. 1(2)**, 28(3)(b)(5)(a)
- C557** Ss. 33-42 applied (with modifications) (1.4.1999) by S.I. 1999/743, **reg. 20(1)**, (2)(3)
- C558** Ss. 33-42 applied (with modifications) (19.11.1999) by S.I. 1999/2892, **reg. 16(1)**
 Ss. 33-42 applied (20.9.2001) by S.I. 2001/2975, **reg. 19(d)**

Changes to legislation: *Health and Safety at Work etc. Act 1974 is up to date with all changes known to be in force on or before 28 April 2021. There are changes that may be brought into force at a future date. Changes that have been made appear in the content and are referenced with annotations. (See end of Document for details) View outstanding changes*

- C559** Ss. 33-35 applied (with modifications) (29.11.1999) by S.I. 1999/2001, reg. 24(1), **Sch. 8 para. 1(b)**
 Ss. 33-42 applied (E.W.S.) (24.7.2002) by S.I. 2002/1689, **reg. 14(1)(b)**
 Ss. 33-42 applied (16.5.2002) by S.I. 2002/1166, **reg. 31** (with art. 37)
- C560** Ss. 1-59, 80-82 applied (E.W.S.) (11.7.2001) by S.I. 2001/2127, **arts. 4(1), 5(1)(2), 6(1), 7(1), 8(1), 10** (with art. 11) (as amended by S.I. 2009/1750, **art. 2(2)(4)**)
- C561** S. 35 applied (with modifications) (E.W.S.) (22.3.2003 for certain purposes and 22.9.2003 otherwise) by S.I. 2003/403, **regs. 1(2), 23(2)(a)(3)**
- C562** S. 35 applied (with modifications) (E.W.S.) (3.5.2004) by S.I. 2004/129, **reg. 23(3)(e)**; s. 35 applied (E.W.S.) (22.4.2005) by S.I. 2005/928 {reg. 4(2)(3)(5)(6)}; s. 35 applied (2.4.2006) by S.I. 2006/397, {reg. 34(3)(d)}
- C563** S. 35 applied (with modifications) (E.W.S.) (the amendment coming into force in accordance with art. 1(1) of the amending S.I.) by **The Channel Tunnel (Safety) Order 2007 (S.I. 2007/3531), art. 4(2)(3)(h)** (subject to (4)-(6)) (with art. 7)
- C564** Ss. 1-59, 80-82 applied (temp.) (5.8.2009) by **The Health and Safety at Work etc. Act 1974 (Application outside Great Britain) Order 2001 (S.I. 2001/2127), arts. 8A, 8B** (as inserted by S.I. 2009/1750, **art. 2(3)**)
- C565** Ss. 33-42 applied (with modifications) (E.W.) (12.8.2009 with application in accordance with reg. 3 of the amending S.I.) by **The Major Accident Off-Site Emergency Plan (Management of Waste from Extractive Industries)(England and Wales) Regulations 2009 (S.I. 2009/1927), {reg. 9(1)}**
- C566** S. 35 applied (with modifications) (E.W.S.) (6.4.2010) by **The Rail Vehicle Accessibility (Non-Interoperable Rail System) Regulations 2010 (S.I. 2010/432), reg. 6(2)(3)(g)**
- C567** Ss. 33-35 applied (with modifications) (E.W.S.) (4.7.2010 for certain purposes and otherwise 4.7.2013) by **The Pyrotechnic Articles (Safety) Regulations 2010 (S.I. 2010/1554), regs. 1, 18, 37(1), {Sch. 4 paras. 1, 2}**
- C568** S. 35 applied (with modifications) (17.8.2015) by **The Pyrotechnic Articles (Safety) Regulations 2015 (S.I. 2015/1553), reg. 1, Sch. 8 paras. 1(p), 2**
- C569** S. 35 applied (with modifications) (8.12.2016) by **The Pressure Equipment (Safety) Regulations 2016 (S.I. 2016/1105), reg. 1, Sch. 8 paras. 1(o), 2** (with reg. 88)
- C570** S. 35 applied (with modifications) (8.12.2016) by **The Lifts Regulations 2016 (S.I. 2016/1093), reg. 1, Sch. 8 paras. 1(p), 2** (with regs. 3-5)
- C571** S. 35 applied (with modifications) (8.12.2016) by **The Simple Pressure Vessels (Safety) Regulations 2016 (S.I. 2016/1092), reg. 1, Sch. 6 paras. 1(o), 2** (with reg. 3)
- C572** S. 35 applied (with modifications) (8.12.2016) by **The Electrical Equipment (Safety) Regulations 2016 (S.I. 2016/1101), reg. 1, Sch. 4 paras. 1, 2** (with reg. 3)
- C573** S. 35 applied (with modifications) (E.W.S.) (8.12.2016) by **The Equipment and Protective Systems Intended for Use in Potentially Explosive Atmospheres Regulations 2016 (S.I. 2016/1107), reg. 1(1), Sch. 4 para. 1(o)**
- C574** S. 35 applied (with modifications) (21.4.2018) by **The Gas Appliances (Enforcement) and Miscellaneous Amendments Regulations 2018 (S.I. 2018/389), reg. 1(1), Sch. 2** (with reg. 2)
- C575** S. 35 applied (with modifications) (21.4.2018) by **The Personal Protective Equipment (Enforcement) Regulations 2018 (S.I. 2018/390), reg. 1(1), Sch. 2** (with reg. 2(1)-(3))

36 Offences due to fault of other person.

- (1) Where the commission by any person of an offence under any of the relevant statutory provisions is due to the act or default of some other person, that other person shall be guilty of the offence, and a person may be charged with and convicted of the offence by virtue of this subsection whether or not proceedings are taken against the first-mentioned person.
- (2) Where there would be or have been the commission of an offence under section 33 by the Crown but for the circumstance that that section does not bind the Crown, and

Changes to legislation: Health and Safety at Work etc. Act 1974 is up to date with all changes known to be in force on or before 28 April 2021. There are changes that may be brought into force at a future date. Changes that have been made appear in the content and are referenced with annotations. (See end of Document for details) View outstanding changes

that fact is due to the act or default of a person other than the Crown, that person shall be guilty of the offence which, but for that circumstance, the Crown would be committing or would have committed, and may be charged with and convicted of that offence accordingly.

- (3) The preceding provisions of this section are subject to any provision made by virtue of section 15(6).

Modifications etc. (not altering text)

- C36** Ss. 1-59 applied by S.I. 2001/2127 art. 8A 8B (as inserted (E.W.S.) (6.4.2011) by [The Health and Safety at Work etc. Act 1974 \(Application outside Great Britain\) \(Variation\) Order 2011 \(S.I. 2011/745\)](#), arts. 1(1), **3(2)**)
- C431** Ss. 33-42 applied (with modifications) (E.W.S.) (1.9.2013) by [The Biocidal Products and Chemicals \(Appointment of Authorities and Enforcement\) Regulations 2013 \(S.I. 2013/1506\)](#), regs. 2(1), **8(1)** (with reg. 3(4), (5), 8(2)-(7), 31, 32, 33(1))
- C432** Ss. 33-42 applied (1.3.2014) by [The Biocidal Products and Chemicals \(Appointment of Authorities and Enforcement\) Regulations 2013 \(S.I. 2013/1506\)](#), regs. 2(4), **19** (with reg. 3(4)(5)313233(1))
- C434** Ss. 33-42 applied (1.10.2014) by [The Genetically Modified Organisms \(Contained Use\) Regulations 2014 \(S.I. 2014/1663\)](#), regs. 1, **30(2)(a)** (with reg. 3(1)(2))
- C435** Ss. 33-42 applied (with modifications) (E.W.S.) (1.6.2015) by [The Biocidal Products and Chemicals \(Appointment of Authorities and Enforcement\) Regulations 2013 \(S.I. 2013/1506\)](#), regs. 2(2), **17(1)** (with reg. 3(4)(5)313233(1))
- C436** Ss. 33-42 applied (with modifications) (E.W.S.) (1.6.2015) by [The Control of Major Accident Hazards Regulations 2015 \(S.I. 2015/483\)](#), regs. 1(1), **27(1)(d)** (with regs. 3(2), 27(3))
- C437** Ss. 33-42 applied (19.7.2015) by [The Offshore Installations \(Offshore Safety Directive\) \(Safety Case etc.\) Regulations 2015 \(S.I. 2015/398\)](#), regs. 1, **36(8)(d)** (with reg. 4(2), Sch. 14)
- C438** Ss. 33-42 applied (19.7.2015) by [The Offshore Installations \(Offshore Safety Directive\) \(Safety Case etc.\) Regulations 2015 \(S.I. 2015/398\)](#), regs. 1, **36(1)(d)** (with reg. 4(2), Sch. 14)
- C526** Ss. 34-42 applied (with modifications) (30.7.2018) by [The Cableway Installations Regulations 2018 \(S.I. 2018/816\)](#), regs. 1, **21(1)-(3)** (with reg. 4)
- C576** S. 36 applied by S.I. 1989/840, **arts. 2-10**
 S. 36 excluded (with saving) (E.W.S.) (1.12.1997) by S.I. 1997/1840, **regs. 7, 9**
 S. 36 extended (E.W.S.) (1.10.1996) by S.I. 1996/1513, **reg. 10 S. 36** applied (15.11.2000) by S.I. 2000/2831, **reg. 26(1)(a)**
- C577** S. 36 modified (6.4.1992) by S.I. 1992/711, **regs. 1(2), 28(3)(b)(5)(a)**
- C578** Ss. 33-42 applied (with modifications) (1.4.1999) by S.I. 1999/743, **reg. 20(1)**, (2)(3)
- C579** Ss. 33-42 applied (with modifications) (19.11.1999) by S.I. 1999/2892, **reg. 16(1)**
 Ss. 33-42 applied (20.9.2001) by S.I. 2001/2975, **reg. 19(d)**
- C580** S. 36 applied (11.7.2001) by S.I. 2001/2127, **arts. 4(1), 5(1)(2), 6(1), 7(1), 8(1), 10** (with art. 11) (as amended by S.I. 2009/1750, **art. 2(2)(4)**)
 S. 36 applied (E.W.S.) (24.7.2002) by S.I. 2002/1689, **reg. 14(1)(b)**
 S. 36 applied (16.5.2002) by S.I. 2002/1166, **reg. 31** (with art. 37)
- C581** S. 36 applied (with modifications) (E.W.S.) (22.3.2003 for certain purposes and 22.9.2003 otherwise) by S.I. 2003/403, **regs. 1(2), 23(2)(a)(3)**
- C582** S. 36 applied (with modifications) (E.W.S.) (3.5.2004) by S.I. 2004/129, **reg. 23(3)(e)**; s. 36 applied (E.W.S.) (22.4.2005) by S.I. 2005/928, **reg. 4(2)(3)(5)(6)**; s. 36 applied (2.4.2006) by S.I. 2006/397, **reg. 34**
- C583** Ss. 1-59, 80-82 applied (temp.) (5.8.2009) by [The Health and Safety at Work etc. Act 1974 \(Application outside Great Britain\) Order 2001 \(S.I. 2001/2127\)](#), arts. 8A, 8B (as inserted by S.I. 2009/1750, **art. 2(3)**)

Changes to legislation: *Health and Safety at Work etc. Act 1974 is up to date with all changes known to be in force on or before 28 April 2021. There are changes that may be brought into force at a future date. Changes that have been made appear in the content and are referenced with annotations. (See end of Document for details) View outstanding changes*

- C584** Ss. 33-42 applied (with modifications) (E.W.) (12.8.2009 with application in accordance with reg. 3 of the amending S.I.) by The Major Accident Off-Site Emergency Plan (Management of Waste from Extractive Industries)(England and Wales) Regulations 2009 (S.I. 2009/1927), {reg. 9(1)}
- C585** S. 36(1)(2) applied (with modifications) (1.1.1993) by S.I.1992/3073, reg. 28, **Sch. 6 para. 1(c)**
- C586** Ss. 18(6)(7)(b), 19-22, 23(1)(2)(5), 24-26, 33(1)(e)-(h)(o)(2)(2A)(3)(4)(e), 34(3)-(5), 35, 36(1)(2), 37-39, 42 applied (with modifications) (9.1.1995) by S.I. 1994/3260, **reg. 17(3)(5)**
- C587** S. 36(1): power to apply conferred (E.W.S.) (28.8.1995) by 1995 c. 15, **ss. 2(4)(h)**, 5 (with s. 3(5))
- C588** S. 36(1) applied (with modifications) (E.W.S.) (16.4.1996) by S.I. 1996/772, **reg. 17**
- C589** Ss. 36(1)(2), 37 applied (with modifications) (1.7.1997) by S.I. 1997/831, reg. 19(1)-(4), **Sch. 15 para. 1(a)(c)**
- C590** S. 36(1) applied (with modifications) (E.W.S.) (9.6.2004) by S.I. 2004/1309, **reg. 17**
- C591** S. 36(1) applied (with modifications) (E.W.S.) (the amendment coming into force in accordance with art. 1(1) of the amending S.I.) by The Channel Tunnel (Safety) Order 2007 (S.I. 2007/3531), **art. 4(2)(3)(h)** (subject to (4)-(6)) (with art. 7)
- C592** S. 36(1)(2) applied (with modifications) (E.W.S.) (6.4.2010) by The Rail Vehicle Accessibility (Non-Interoperable Rail System) Regulations 2010 (S.I. 2010/432), **reg. 6(2)(3)(g)**
- C593** S. 36(1)(2) applied (with modifications) (E.W.S.) (6.4.2010) by The Train Driving Licences and Certificates Regulations 2010 (S.I. 2010/724), regs. 1(2), **38(2)(3)(g)**
- C594** S. 36(1)(2) applied (with modifications) (E.W.S.) (4.7.2010 for certain purposes and otherwise 4.7.2013) by The Pyrotechnic Articles (Safety) Regulations 2010 (S.I. 2010/1554), **regs. 1, 18, 37(1)**, {Sch. 4 paras. 1, 2}
- C595** S. 36(1)(2) applied (with modifications) (16.1.2012) by The Railways (Interoperability) Regulations 2011 (S.I. 2011/3066), regs. 1(2), **39(2)(3)(g)** (with reg. 3)
- C596** S. 36(1) applied (with modifications) (E.W.S.) (1.10.2014) by The Explosives Regulations 2014 (S.I. 2014/1638), reg. 1(1), **Sch. 12 paras. 2, 3**
- C597** S. 36(1)(2) applied (with modifications) by S.I. 2014/1638, Sch. 12 paras. 5-7 (as substituted (E.W.S.) (20.4.2016) by The Explosives Regulations 2014 (Amendment) Regulations 2016 (S.I. 2016/315), reg. 1, **Sch. 1** (with regs. 2(1), 15))
- C598** S. 36 applied (with modifications) (9.1.1995) by S.I. 1994/3260, **reg. 17(3)(5)**
- C599** S. 36(2) applied (with modifications) (E.W.S.) (the amendment coming into force in accordance with art. 1(1) of the amending S.I.) by The Channel Tunnel (Safety) Order 2007 (S.I. 2007/3531), **art. 4(2)(3)(h)** (subject to (4)-(6)) (with art. 7)
- C600** S. 36(2) applied (with modifications) (E.W.S.) (1.10.2014) by The Explosives Regulations 2014 (S.I. 2014/1638), reg. 1(1), **Sch. 12 paras. 2, 3**

37 Offences by bodies corporate.

- (1) Where an offence under any of the relevant statutory provisions committed by a body corporate is proved to have been committed with the consent or connivance of, or to have been attributable to any neglect on the part of, any director, manager, secretary or other similar officer of the body corporate or a person who was purporting to act in any such capacity, he as well as the body corporate shall be guilty of that offence and shall be liable to be proceeded against and punished accordingly.
- (2) Where the affairs of a body corporate are managed by its members, the preceding subsection shall apply in relation to the acts and defaults of a member in connection with his functions of management as if he were a director of the body corporate.

Changes to legislation: *Health and Safety at Work etc. Act 1974 is up to date with all changes known to be in force on or before 28 April 2021. There are changes that may be brought into force at a future date. Changes that have been made appear in the content and are referenced with annotations. (See end of Document for details) View outstanding changes*

Modifications etc. (not altering text)

- C36** Ss. 1-59 applied by S.I. 2001/2127 art. 8A 8B (as inserted (E.W.S.) (6.4.2011) by [The Health and Safety at Work etc. Act 1974 \(Application outside Great Britain\) \(Variation\) Order 2011 \(S.I. 2011/745\)](#), arts. 1(1), **3(2)**)
- C431** Ss. 33-42 applied (with modifications) (E.W.S.) (1.9.2013) by [The Biocidal Products and Chemicals \(Appointment of Authorities and Enforcement\) Regulations 2013 \(S.I. 2013/1506\)](#), regs. 2(1), **8(1)** (with reg. 3(4), (5), 8(2)-(7), 31, 32, 33(1))
- C432** Ss. 33-42 applied (1.3.2014) by [The Biocidal Products and Chemicals \(Appointment of Authorities and Enforcement\) Regulations 2013 \(S.I. 2013/1506\)](#), regs. 2(4), **19** (with reg. 3(4)(5)313233(1))
- C434** Ss. 33-42 applied (1.10.2014) by [The Genetically Modified Organisms \(Contained Use\) Regulations 2014 \(S.I. 2014/1663\)](#), regs. 1, **30(2)(a)** (with reg. 3(1)(2))
- C435** Ss. 33-42 applied (with modifications) (E.W.S.) (1.6.2015) by [The Biocidal Products and Chemicals \(Appointment of Authorities and Enforcement\) Regulations 2013 \(S.I. 2013/1506\)](#), regs. 2(2), **17(1)** (with reg. 3(4)(5)313233(1))
- C436** Ss. 33-42 applied (with modifications) (E.W.S.) (1.6.2015) by [The Control of Major Accident Hazards Regulations 2015 \(S.I. 2015/483\)](#), regs. 1(1), **27(1)(d)** (with regs. 3(2), 27(3))
- C437** Ss. 33-42 applied (19.7.2015) by [The Offshore Installations \(Offshore Safety Directive\) \(Safety Case etc.\) Regulations 2015 \(S.I. 2015/398\)](#), regs. 1, **36(8)(d)** (with reg. 4(2), Sch. 14)
- C438** Ss. 33-42 applied (19.7.2015) by [The Offshore Installations \(Offshore Safety Directive\) \(Safety Case etc.\) Regulations 2015 \(S.I. 2015/398\)](#), regs. 1, **36(1)(d)** (with reg. 4(2), Sch. 14)
- C526** Ss. 34-42 applied (with modifications) (30.7.2018) by [The Cableway Installations Regulations 2018 \(S.I. 2018/816\)](#), regs. 1, **21(1)-(3)** (with reg. 4)
- C601** S. 37 applied by S.I. 1989/840, **arts. 2-10**
 S. 37 excluded (with saving) (E.W.S.) (1.12.1997) by S.I. 1997/1840, **regs. 7, 9**
 S. 37 extended (E.W.S.) (1.10.1996) by S.I. 1996/1513, **reg. 10**
 Ss. 18(6)(7)(b), 19-22, 23(1)(2)(5), 24-26, 33(1)(e)-(h)(o)(2)(2A)(3)(4)(e), 34(3)-(5), 35, 36(1)(2), 37-39, 42 applied (with modifications) (9.1.1995) by S.I. 1994/3260, **reg. 17(3)(5)**
 S. 37: power to apply conferred (E.W.S.) (28.8.1995) by 1995 c. 15, **ss. 2(4)(h), 5** (with s. 3(5))
 Ss. 18-27, 33(1)(e)-(i)(n)(o)(2)-(4), 34(2)-(6), 36(1), 37-42, 46 applied (with modifications) (E.W.S.) (16.4.1996) by S.I. 1996/772, **reg. 17**
 Ss. 16-26, 33-42, 47 applied (15.11.2000) by S.I. 2000/2831, **reg. 26(1)(a)**
- C602** S. 37 applied by S.I. 1990/556, **reg. 5(2)**
- C603** S. 37 applied (with modifications) (1.1.1993) by S.I. 1992/3073, **reg. 28, Sch. 6 para. 1(c)**
 Ss. 36(1)(2), 37 applied (with modifications) (1.7.1997) by S.I. 1997/831, **reg. 19(1)-(4), Sch. 15 para. 1(a)(c)**
- C604** Ss. 35-39 modified (6.4.1992) by S.I. 1992/711, **regs. 1(2), 28(3)(b)(5)(a)**
- C605** Ss. 33-42 applied (with modifications) (1.4.1999) by S.I. 1999/743, **reg. 20(1), (2)(3)**
- C606** Ss. 33-42 applied (with modifications) (19.11.1999) by S.I. 1999/2892, **reg. 16(1)**
- C607** Ss. 1-59, 80-82 applied (11.7.2001) by S.I. 2001/2127, **arts. 4(1), 5(1)(2), 6(1), 7(1), 8(1), 10** (with art. 11) (as amended by S.I. 2009/1750, **art. 2(2)(4)**)
- C608** Ss. 33-42 applied (20.9.2001) by S.I. 2001/2975, **reg. 19(d)**
 Ss. 33-42 applied (E.W.S.) (24.7.2002) by S.I. 2002/1689, **reg. 14(1)(b)**
 Ss. 33-42 applied (16.5.2002) by S.I. 2002/1166, **reg. 31** (with art. 37)
- C609** S. 37 applied (with modifications) (E.W.S.) (22.3.2003 for certain purposes and 22.9.2003 otherwise) by S.I. 2003/403, **regs. 1(2), 23(2)(a)(3)**
- C610** S. 37 applied (with modifications) (E.W.S.) (3.5.2004) by S.I. 2004/129, **reg. 23(3)(e)**; s. 37 applied (with modifications) (E.W.S.) (9.6.2004) by S.I. 2004/1309, **reg. 17**; s. 37 applied (E.W.S.) (22.4.2005) by S.I. 2005/928, **reg. 4(2)(3)(5)(6)**; ss. 37 applied (2.4.2006) by S.I. 2006/397, **reg. 34(3)(d)**
- C611** Ss. 37-41 applied (with modifications) (E.W.S.) (the amendment coming into force in accordance with art. 1(1) of the amending S.I.) by [The Channel Tunnel \(Safety\) Order 2007 \(S.I. 2007/3531\)](#), **art. 4(2)(3)(h)** (subject to (4)-(6)) (with art. 7)

Changes to legislation: Health and Safety at Work etc. Act 1974 is up to date with all changes known to be in force on or before 28 April 2021. There are changes that may be brought into force at a future date. Changes that have been made appear in the content and are referenced with annotations. (See end of Document for details) View outstanding changes

- C612** Ss. 1-59, 80-82 applied (temp.) (5.8.2009) by The Health and Safety at Work etc. Act 1974 (Application outside Great Britain) Order 2001 (S.I. 2001/2127), arts. 8A, 8B (as inserted by S.I. 2009/1750, **art. 2(3)**)
- C613** Ss. 33-42 applied (with modifications) (E.W.) (12.8.2009 with application in accordance with reg. 3 of the amending S.I.) by The Major Accident Off-Site Emergency Plan (Management of Waste from Extractive Industries)(England and Wales) Regulations 2009 (S.I. 2009/1927), {reg. 9(1)}
- C614** Ss. 37-41 applied (with modifications) (E.W.S.) (6.4.2010) by The Rail Vehicle Accessibility (Non-Interoperable Rail System) Regulations 2010 (S.I. 2010/432), **reg. 6(2)(3)(g)**
- C615** Ss. 37-41 applied (with modifications) (E.W.S.) (6.4.2010) by The Train Driving Licences and Certificates Regulations 2010 (S.I. 2010/724), regs. 1(2), **38(2)(3)(g)**
- C616** S. 37 applied (with modifications) (E.W.S.) (4.7.2010 for certain purposes and otherwise 4.7.2013) by The Pyrotechnic Articles (Safety) Regulations 2010 (S.I. 2010/1554), **regs. 1, 18, 37(1)**, {Sch. 4 paras. 1, 2}
- C617** Ss. 37-41 applied (with modifications) (16.1.2012) by The Railways (Interoperability) Regulations 2011 (S.I. 2011/3066), regs. 1(2), **39(2)(3)(g)** (with reg. 3)
- C618** S. 37 applied (with modifications) (E.W.S.) (1.10.2014) by The Explosives Regulations 2014 (S.I. 2014/1638), **reg. 1(1)**, Sch. 12 paras. 2, 3
- C619** S. 37 applied (with modifications) by S.I. 2014/1638, Sch. 12 paras. 5-7 (as substituted (E.W.S.) (20.4.2016) by The Explosives Regulations 2014 (Amendment) Regulations 2016 (S.I. 2016/315), **reg. 1, Sch. 1** (with regs. 2(1), 15))

38 Restrictions on institution of proceedings in England and Wales.

Proceedings for an offence under any of the relevant statutory provisions shall not, in England and Wales, be instituted except by an inspector [^{F162}, the Environment Agency or the Natural Resources Body for Wales] by or with the consent of the Director of Public Prosecutions.

Textual Amendments

- F162** Words in s. 38 substituted (1.4.2013) by The Natural Resources Body for Wales (Functions) Order 2013 (No. 755), art. 1(2), **Sch. 2 para. 113** (with Sch. 7)

Modifications etc. (not altering text)

- C36** Ss. 1-59 applied by S.I. 2001/2127 art. 8A 8B (as inserted (E.W.S.) (6.4.2011) by The Health and Safety at Work etc. Act 1974 (Application outside Great Britain) (Variation) Order 2011 (S.I. 2011/745), arts. 1(1), **3(2)**)
- C431** Ss. 33-42 applied (with modifications) (E.W.S.) (1.9.2013) by The Biocidal Products and Chemicals (Appointment of Authorities and Enforcement) Regulations 2013 (S.I. 2013/1506), regs. 2(1), **8(1)** (with reg. 3(4), (5), 8(2)-(7), 31, 32, 33(1))
- C432** Ss. 33-42 applied (1.3.2014) by The Biocidal Products and Chemicals (Appointment of Authorities and Enforcement) Regulations 2013 (S.I. 2013/1506), regs. 2(4), **19** (with reg. 3(4)(5)313233(1))
- C434** Ss. 33-42 applied (1.10.2014) by The Genetically Modified Organisms (Contained Use) Regulations 2014 (S.I. 2014/1663), regs. 1, **30(2)(a)** (with reg. 3(1)(2))
- C435** Ss. 33-42 applied (with modifications) (E.W.S.) (1.6.2015) by The Biocidal Products and Chemicals (Appointment of Authorities and Enforcement) Regulations 2013 (S.I. 2013/1506), regs. 2(2), **17(1)** (with reg. 3(4)(5)313233(1))
- C436** Ss. 33-42 applied (with modifications) (E.W.S.) (1.6.2015) by The Control of Major Accident Hazards Regulations 2015 (S.I. 2015/483), regs. 1(1), **27(1)(d)** (with regs. 3(2), 27(3))
- C437** Ss. 33-42 applied (19.7.2015) by The Offshore Installations (Offshore Safety Directive) (Safety Case etc.) Regulations 2015 (S.I. 2015/398), regs. 1, **36(8)(d)** (with reg. 4(2), Sch. 14)

Changes to legislation: *Health and Safety at Work etc. Act 1974 is up to date with all changes known to be in force on or before 28 April 2021. There are changes that may be brought into force at a future date. Changes that have been made appear in the content and are referenced with annotations. (See end of Document for details) View outstanding changes*

- C438** Ss. 33-42 applied (19.7.2015) by [The Offshore Installations \(Offshore Safety Directive\) \(Safety Case etc.\) Regulations 2015 \(S.I. 2015/398\)](#), regs. 1, **36(1)(d)** (with reg. 4(2), Sch. 14)
- C526** Ss. 34-42 applied (with modifications) (30.7.2018) by [The Cableway Installations Regulations 2018 \(S.I. 2018/816\)](#), regs. 1, **21(1)-(3)** (with reg. 4)
- C617** Ss. 37-41 applied (with modifications) (16.1.2012) by [The Railways \(Interoperability\) Regulations 2011 \(S.I. 2011/3066\)](#), regs. 1(2), **39(2)(3)(g)** (with reg. 3)
- C620** S. 38 applied by [S.I. 1989/840](#), **arts. 2-10**
 S. 38 excluded (with saving) (E.W.S.) (1.12.1997) by [S.I. 1997/1840](#), **regs. 7, 9**
 S. 38 extended (E.W.S.) (1.10.1996) by [S.I. 1996/1513](#), **reg. 10**
 Ss. 18(6)(7)(b), 19-22, 23(1)(2)(5), 24-26, 33(1)(e)-(h)(o)(2)(2A)(3)(4)(e), 34(3)-(5), 35, 36(1)(2), 37-39, 42 applied (with modifications) (9.1.1995) by [S.I. 1994/3260](#), **reg. 17(3)(5)**
 S. 38: power to apply conferred (E.W.S.) (28.8.1995) by [1995 c. 15](#), **ss. 2(4)(i), 5** (with s. 3(5))
 Ss. 18-27, 33(1)(e)-(i)(n)(o)(2)-(4), 34(2)-(6), 36(1), 37-42, 46 applied (with modifications) (E.W.S.) (16.4.1996) by [S.I. 1996/772](#), **reg. 17**
 Ss. 19-28, 33-35, 38, 39, 41, 42 applied (with modifications) (E.W.S.) (1.3.1996) by [S.I. 1996/192](#), **reg. 15, Sch. 14 para. 1(b)**
 Ss. 19-28, 33-35, 38, 39, 41, 42 applied (with modifications) (1.7.1997) by [S.I. 1997/831](#), **reg. 19(1)-(4), Sch. 15 para. 1(a)(b)**
 Ss. 16-26, 33-42, 47 applied (15.11.2000) by [S.I. 2000/2831](#), **reg. 26(1)(a)**
- C621** S. 38 applied (with modifications) (1.1.1993) by [S.I. 1992/3073](#), **reg. 28, Sch. 6 para. 1(b)**
 S. 38 applied (15.2.1999) by [1998 c. 17](#), **s. 20(3)**, (with s. 9(1)(2), Sch. 3 para. 5(1)); [S.I. 1999/161](#), **art. 2(1)(2)**
- C622** Ss. 35-39 modified (6.4.1992) by [S.I. 1992/711](#), **regs. 1(2), 28(3)(b)(5)(a)**
- C623** Ss. 33-42 applied (with modifications) (1.4.1999) by [S.I. 1999/743](#), **reg. 20(1)(d), (2)(3)**
- C624** Ss. 33-42 applied (with modifications) (19.11.1999) by [S.I. 1999/2892](#), **reg. 16(1)**
 Ss. 33-42 applied (20.9.2001) by [S.I. 2001/2975](#), **reg. 19(d)**
- C625** S. 38 applied (with modifications) (29.11.1999) by [S.I. 1999/2001](#), **reg. 24(1), Sch. 8 para. 1(b)**
- C626** Ss. 1-59, 80-82 applied (11.7.2001) by [S.I. 2001/2127](#), **arts. 4(1), 5(1)(2), 6(1), 7(1), 8(1), 10** (with art. 11) (as amended by [S.I. 2009/1750](#), **art. 2(2)(4)**)
 Ss. 33-42 applied (E.W.S.) (24.7.2002) by [S.I. 2002/1689](#), **reg. 14(1)(b)**
 Ss. 33-42 applied (16.5.2002) by [S.I. 2002/1166](#), **reg. 31** (with art. 37)
- C627** S. 38 applied (with modifications) (E.W.S.) (22.3.2003 for certain purposes and 22.9.2003 otherwise) by [S.I. 2003/403](#), **regs. 1(2), 23(2)(a)(3)**
- C628** S. 38 applied (with modifications) (E.W.S.) (3.5.2004) by [S.I. 2004/129](#), **reg. 23(3)(e)**; s. 38 applied (with modifications) (E.W.S.) (9.6.2004) by [S.I. 2004/1309](#), **reg. 17**; s. 38 applied (E.W.S.) (22.4.2005) by [S.I. 2005/928](#), **reg. 4(2)(3)(5)(6)**; s. 38 applied (2.4.2006) by [S.I. 2006/397](#), **reg. 34(3)(d)**
- C629** Ss. 37-41 applied (with modifications) (E.W.S.) (the amendment coming into force in accordance with art. 1(1) of the amending S.I.) by [The Channel Tunnel \(Safety\) Order 2007 \(S.I. 2007/3531\)](#), **art. 4(2)(3)(h)** (subject to (4)-(6)) (with art. 7)
- C630** Ss. 1-59, 80-82 applied (temp.) (5.8.2009) by [The Health and Safety at Work etc. Act 1974 \(Application outside Great Britain\) Order 2001 \(S.I. 2001/2127\)](#), arts. 8A, 8B (as inserted by [S.I. 2009/1750](#), **art. 2(3)**)
- C631** Ss. 33-42 applied (with modifications) (E.W.) (12.8.2009 with application in accordance with reg. 3 of the amending S.I.) by [The Major Accident Off-Site Emergency Plan \(Management of Waste from Extractive Industries\)\(England and Wales\) Regulations 2009 \(S.I. 2009/1927\)](#), {reg. 9(1)}
- C632** Ss. 37-41 applied (with modifications) (E.W.S.) (6.4.2010) by [The Rail Vehicle Accessibility \(Non-Interoperable Rail System\) Regulations 2010 \(S.I. 2010/432\)](#), **reg. 6(2)(3)(g)**
- C633** Ss. 37-41 applied (with modifications) (E.W.S.) (6.4.2010) by [The Train Driving Licences and Certificates Regulations 2010 \(S.I. 2010/724\)](#), regs. 1(2), **38(2)(3)(g)**
- C634** S. 38 applied (with modifications) (E.W.S.) (4.7.2010 for certain purposes and otherwise 4.7.2013) by [The Pyrotechnic Articles \(Safety\) Regulations 2010 \(S.I. 2010/1554\)](#), **regs. 1, 18, 37(1)**, {Sch. 4 paras. 1, 2}

Changes to legislation: *Health and Safety at Work etc. Act 1974 is up to date with all changes known to be in force on or before 28 April 2021. There are changes that may be brought into force at a future date. Changes that have been made appear in the content and are referenced with annotations. (See end of Document for details) View outstanding changes*

- C635** S. 38 applied (with modifications) (E.W.S.) (1.10.2014) by [The Explosives Regulations 2014 \(S.I. 2014/1638\)](#), [reg. 1\(1\)](#), [Sch. 12 paras. 2, 3](#)
- C636** S. 38 applied (with modifications) by S.I. 2014/1638, Sch. 12 paras. 5-7 (as substituted (E.W.S.) (20.4.2016) by [The Explosives Regulations 2014 \(Amendment\) Regulations 2016 \(S.I. 2016/315\)](#), [reg. 1](#), [Sch. 1](#) (with [regs. 2\(1\), 15](#)))

39 Prosecutions by inspectors.

- (1) An inspector, if authorised in that behalf by the enforcing authority which appointed him, may, although not of counsel or a solicitor, prosecute before a magistrates' court proceedings for an offence under any of the relevant statutory provisions.
- (2) This section shall not apply to Scotland.

Modifications etc. (not altering text)

- C36** Ss. 1-59 applied by S.I. 2001/2127 art. 8A 8B (as inserted (E.W.S.) (6.4.2011) by [The Health and Safety at Work etc. Act 1974 \(Application outside Great Britain\) \(Variation\) Order 2011 \(S.I. 2011/745\)](#), [arts. 1\(1\), 3\(2\)](#))
- C431** Ss. 33-42 applied (with modifications) (E.W.S.) (1.9.2013) by [The Biocidal Products and Chemicals \(Appointment of Authorities and Enforcement\) Regulations 2013 \(S.I. 2013/1506\)](#), [regs. 2\(1\), 8\(1\)](#) (with [reg. 3\(4\), \(5\), 8\(2\)-\(7\), 31, 32, 33\(1\)](#))
- C432** Ss. 33-42 applied (1.3.2014) by [The Biocidal Products and Chemicals \(Appointment of Authorities and Enforcement\) Regulations 2013 \(S.I. 2013/1506\)](#), [regs. 2\(4\), 19](#) (with [reg. 3\(4\)\(5\)313233\(1\)](#))
- C434** Ss. 33-42 applied (1.10.2014) by [The Genetically Modified Organisms \(Contained Use\) Regulations 2014 \(S.I. 2014/1663\)](#), [regs. 1, 30\(2\)\(a\)](#) (with [reg. 3\(1\)\(2\)](#))
- C435** Ss. 33-42 applied (with modifications) (E.W.S.) (1.6.2015) by [The Biocidal Products and Chemicals \(Appointment of Authorities and Enforcement\) Regulations 2013 \(S.I. 2013/1506\)](#), [regs. 2\(2\), 17\(1\)](#) (with [reg. 3\(4\)\(5\)313233\(1\)](#))
- C436** Ss. 33-42 applied (with modifications) (E.W.S.) (1.6.2015) by [The Control of Major Accident Hazards Regulations 2015 \(S.I. 2015/483\)](#), [regs. 1\(1\), 27\(1\)\(d\)](#) (with [regs. 3\(2\), 27\(3\)](#))
- C437** Ss. 33-42 applied (19.7.2015) by [The Offshore Installations \(Offshore Safety Directive\) \(Safety Case etc.\) Regulations 2015 \(S.I. 2015/398\)](#), [regs. 1, 36\(8\)\(d\)](#) (with [reg. 4\(2\), Sch. 14](#))
- C438** Ss. 33-42 applied (19.7.2015) by [The Offshore Installations \(Offshore Safety Directive\) \(Safety Case etc.\) Regulations 2015 \(S.I. 2015/398\)](#), [regs. 1, 36\(1\)\(d\)](#) (with [reg. 4\(2\), Sch. 14](#))
- C526** Ss. 34-42 applied (with modifications) (30.7.2018) by [The Cableway Installations Regulations 2018 \(S.I. 2018/816\)](#), [regs. 1, 21\(1\)-\(3\)](#) (with [reg. 4](#))
- C617** Ss. 37-41 applied (with modifications) (16.1.2012) by [The Railways \(Interoperability\) Regulations 2011 \(S.I. 2011/3066\)](#), [regs. 1\(2\), 39\(2\)\(3\)\(g\)](#) (with [reg. 3](#))
- C637** S. 39 applied by S.I. 1989/840, [arts. 2-10](#)
- S. 39 excluded (with saving) (E.W.S.) (1.12.1997) by S.I. 1997/1840, [regs. 7, 9](#)
- S. 39 extended (E.W.) (1.10.1996) by S.I. 1996/1513, [reg. 10](#)
- S. 39 applied (with modifications) (9.1.1995) by S.I. 1994/3260, [reg. 17\(3\)\(5\)](#)
- S. 39: power to apply conferred (E.W.S.) (28.8.1995) by 1995 c. 15, [ss. 2\(4\)\(i\), 5](#) (with s. 3(5))
- S. 39 applied (with modifications) (E.W.S.) (16.4.1996) by S.I. 1996/772, [reg. 17 S. 39](#) applied (with modifications) (E.W.S.) (1.3.1996) by S.I. 1996/192, [reg. 15, Sch. 14 para. 1\(b\)](#)
- S. 39 applied (with modifications) (1.7.1997) by S.I. 1997/831, [reg. 19\(1\)-\(4\), Sch. 15 para. 1\(a\)\(b\)](#)
- S. 39 applied (15.11.2000) by S.I. 2000/2831, [reg. 26\(1\)\(a\)](#)
- C638** S. 39 applied (with modifications) (1.1.1993) by S.I. 1992/3073, [reg. 28, Sch. 6 para. 1\(b\)](#)
- C639** Ss. 35-39 modified (6.4.1992) by S.I. 1992/711, [regs. 1\(2\), 28\(3\)\(b\)\(5\)\(a\)](#)
- C640** Ss. 33-42 applied (with modifications) (1.4.1999) by S.I. 1999/743, [reg. 20\(1\), \(2\)\(3\)](#)
- C641** Ss. 33-42 applied (with modifications) (19.11.1999) by S.I. 1999/2892, [reg. 16\(1\)](#)

Changes to legislation: *Health and Safety at Work etc. Act 1974 is up to date with all changes known to be in force on or before 28 April 2021. There are changes that may be brought into force at a future date. Changes that have been made appear in the content and are referenced with annotations. (See end of Document for details) View outstanding changes*

- Ss. 33-42 applied (20.9.2001) by S.I. 2001/2975, **reg. 19(d)**
- C642** S. 39 applied (with modifications) (29.11.1999) by S.I. 1999/2001, **reg. 24(1), Sch. 8 para. 1(b)**
- C643** S. 39 applied (11.7.2001) by S.I. 2001/2127, **arts. 4(1), 5(1)(2), 6(1), 7(1), 8(1), 10** (with art. 11) (as amended by S.I. 2009/1750, **art. 2(2)(4)**)
- S. 39 applied (E.W.) (24.7.2002) by S.I. 2002/1689, **reg. 14(1)(b)**
- S. 39 applied (16.5.2002) by S.I. 2002/1166, **reg. 31** (with art. 37)
- C644** S. 39 applied (with modifications) (E.W.) (3.5.2004) by S.I. 2004/129, **reg. 23(3)(e)**; ss. 39 applied (with modifications) (E.W.) (9.6.2004) by S.I. 2004/1309, **reg. 17**; s. 39 applied (E.W.) (22.4.2005) by S.I. 2005/928, **reg. 4(2)(3)(5)(6)**; s. 39 applied (E.W.) (2.4.2006) by S.I. 2006/397, **reg. 34(3)(d)**
- C645** Ss. 37-41 applied (with modifications) (E.W.S.) (the amendment coming into force in accordance with art. 1(1) of the amending S.I.) by **The Channel Tunnel (Safety) Order 2007 (S.I. 2007/3531), art. 4(2)(3)(h)** (subject to (4)-(6)) (with art. 7)
- C646** Ss. 1-59, 80-82 applied (temp.) (5.8.2009) by **The Health and Safety at Work etc. Act 1974 (Application outside Great Britain) Order 2001 (S.I. 2001/2127), arts. 8A, 8B** (as inserted by S.I. 2009/1750, **art. 2(3)**)
- C647** Ss. 33-42 applied (with modifications) (E.W.) (12.8.2009 with application in accordance with reg. 3 of the amending S.I.) by **The Major Accident Off-Site Emergency Plan (Management of Waste from Extractive Industries)(England and Wales) Regulations 2009 (S.I. 2009/1927), {reg. 9(1)}**
- C648** Ss. 37-41 applied (with modifications) (E.W.S.) (6.4.2010) by **The Rail Vehicle Accessibility (Non-Interoperable Rail System) Regulations 2010 (S.I. 2010/432), reg. 6(2)(3)(g)**
- C649** Ss. 37-41 applied (with modifications) (E.W.S.) (6.4.2010) by **The Train Driving Licences and Certificates Regulations 2010 (S.I. 2010/724), regs. 1(2), 38(2)(3)(g)**
- C650** S. 39 applied (with modifications) (E.W.S.) (4.7.2010 for certain purposes and otherwise 4.7.2013) by **The Pyrotechnic Articles (Safety) Regulations 2010 (S.I. 2010/1554), regs. 1, 18, 37(1), {Sch. 4 paras. 1, 2}**
- C651** S. 39 applied (with modifications) (E.W.S.) (1.10.2014) by **The Explosives Regulations 2014 (S.I. 2014/1638), reg. 1(1), Sch. 12 paras. 2, 3**
- C652** S. 39 applied (with modifications) (17.8.2015) by **The Pyrotechnic Articles (Safety) Regulations 2015 (S.I. 2015/1553), reg. 1, Sch. 8 paras. 1(q), 2**
- C653** S. 39 applied (with modifications) by S.I. 2014/1638, Sch. 12 paras. 5-7 (as substituted (E.W.S.) (20.4.2016) by **The Explosives Regulations 2014 (Amendment) Regulations 2016 (S.I. 2016/315), reg. 1, Sch. 1** (with regs. 2(1), 15))
- C654** S. 39 applied (with modifications) (E.W.S.) (8.12.2016) by **The Equipment and Protective Systems Intended for Use in Potentially Explosive Atmospheres Regulations 2016 (S.I. 2016/1107), reg. 1(1), Sch. 4 para. 1(p)**
- C655** S. 39 applied (with modifications) (8.12.2016) by **The Lifts Regulations 2016 (S.I. 2016/1093), reg. 1, Sch. 8 paras. 1(q), 2** (with regs. 3-5)
- C656** S. 39 applied (with modifications) (8.12.2016) by **The Electrical Equipment (Safety) Regulations 2016 (S.I. 2016/1101), reg. 1, Sch. 4 paras. 1, 2** (with reg. 3)
- C657** S. 39 applied (with modifications) (8.12.2016) by **The Pressure Equipment (Safety) Regulations 2016 (S.I. 2016/1105), reg. 1, Sch. 8 paras. 1(p), 2** (with reg. 88)
- C658** S. 39 applied (with modifications) (8.12.2016) by **The Simple Pressure Vessels (Safety) Regulations 2016 (S.I. 2016/1092), reg. 1, Sch. 6 paras. 1(p), 2** (with reg. 3)
- C659** S. 39 applied (with modifications) (21.4.2018) by **The Personal Protective Equipment (Enforcement) Regulations 2018 (S.I. 2018/390), reg. 1(1), Sch. 2** (with reg. 2(1)-(3))
- C660** S. 39 applied (with modifications) (21.4.2018) by **The Gas Appliances (Enforcement) and Miscellaneous Amendments Regulations 2018 (S.I. 2018/389), reg. 1(1), Sch. 2** (with reg. 2)

40 Onus of proving limits of what is practicable etc.

In any proceedings for an offence under any of the relevant statutory provisions consisting of a failure to comply with a duty or requirement to do something so far

Changes to legislation: *Health and Safety at Work etc. Act 1974 is up to date with all changes known to be in force on or before 28 April 2021. There are changes that may be brought into force at a future date. Changes that have been made appear in the content and are referenced with annotations. (See end of Document for details) View outstanding changes*

as is practicable or so far as is reasonably practicable, or to use the best practicable means to do something, it shall be for the accused to prove (as the case may be) that it was not practicable or not reasonably practicable to do more than was in fact done to satisfy the duty or requirement, or that there was no better practicable means than was in fact used to satisfy the duty or requirement.

Modifications etc. (not altering text)

- C36** Ss. 1-59 applied by S.I. 2001/2127 art. 8A 8B (as inserted (E.W.S.) (6.4.2011) by [The Health and Safety at Work etc. Act 1974 \(Application outside Great Britain\) \(Variation\) Order 2011 \(S.I. 2011/745\)](#), arts. 1(1), **3(2)**)
- C431** Ss. 33-42 applied (with modifications) (E.W.S.) (1.9.2013) by [The Biocidal Products and Chemicals \(Appointment of Authorities and Enforcement\) Regulations 2013 \(S.I. 2013/1506\)](#), regs. 2(1), **8(1)** (with reg. 3(4), (5), 8(2)-(7), 31, 32, 33(1))
- C432** Ss. 33-42 applied (1.3.2014) by [The Biocidal Products and Chemicals \(Appointment of Authorities and Enforcement\) Regulations 2013 \(S.I. 2013/1506\)](#), regs. 2(4), **19** (with reg. 3(4)(5)313233(1))
- C434** Ss. 33-42 applied (1.10.2014) by [The Genetically Modified Organisms \(Contained Use\) Regulations 2014 \(S.I. 2014/1663\)](#), regs. 1, **30(2)(a)** (with reg. 3(1)(2))
- C435** Ss. 33-42 applied (with modifications) (E.W.S.) (1.6.2015) by [The Biocidal Products and Chemicals \(Appointment of Authorities and Enforcement\) Regulations 2013 \(S.I. 2013/1506\)](#), regs. 2(2), **17(1)** (with reg. 3(4)(5)313233(1))
- C436** Ss. 33-42 applied (with modifications) (E.W.S.) (1.6.2015) by [The Control of Major Accident Hazards Regulations 2015 \(S.I. 2015/483\)](#), regs. 1(1), **27(1)(d)** (with regs. 3(2), 27(3))
- C437** Ss. 33-42 applied (19.7.2015) by [The Offshore Installations \(Offshore Safety Directive\) \(Safety Case etc.\) Regulations 2015 \(S.I. 2015/398\)](#), regs. 1, **36(8)(d)** (with reg. 4(2), Sch. 14)
- C438** Ss. 33-42 applied (19.7.2015) by [The Offshore Installations \(Offshore Safety Directive\) \(Safety Case etc.\) Regulations 2015 \(S.I. 2015/398\)](#), regs. 1, **36(1)(d)** (with reg. 4(2), Sch. 14)
- C526** Ss. 34-42 applied (with modifications) (30.7.2018) by [The Cableway Installations Regulations 2018 \(S.I. 2018/816\)](#), regs. 1, **21(1)-(3)** (with reg. 4)
- C617** Ss. 37-41 applied (with modifications) (16.1.2012) by [The Railways \(Interoperability\) Regulations 2011 \(S.I. 2011/3066\)](#), regs. 1(2), **39(2)(3)(g)** (with reg. 3)
- C661** S. 40 applied by S.I. 1989/840, **arts. 2-10**
 S. 40 excluded (with saving) (E.W.S.) (1.12.1997) by S.I. 1997/1840, **regs. 7, 9**
 S. 40: power to apply conferred (E.W.S.) (28.8.1995) by 1995 c. 15, **ss. 2(4)(j)**, 5 (with s. 3(5))
 S. 40 applied (with modifications) (E.W.S.) (16.4.1996) by S.I. 1996/772, **reg. 17**
 S. 40 applied (15.11.2000) by S.I. 2000/2831, **reg. 26(1)(a)**
- C662** Ss. 33-42 applied (with modifications) (1.4.1999) by S.I. 1999/743, **reg. 20(1)**, (2)(3)
- C663** Ss. 33-42 applied (with modifications) (19.11.1999) by S.I. 1999/2892, **reg. 16(1)**
 Ss. 33-42 applied (20.9.2001) by S.I. 2001/2975, **reg. 19(d)**
- C664** Ss. 1-59, 80-82 applied (11.7.2001) by S.I. 2001/2127, **arts. 4(1)**, 5(1)(2), 6(1), 7(1), 8(1), 10 (with art. 11) (as amended by S.I. 2009/1750, **art. 2(2)(4)**)
 Ss. 33-42 applied (E.W.S.) (24.7.2002) by S.I. 2002/1689, **reg. 14(1)(b)**
 Ss. 33-42 applied (16.5.2002) by S.I. 2002/1166, **reg. 31** (with art. 37)
- C665** S. 40 applied (with modifications) (E.W.S.) (3.5.2004) by S.I. 2004/129, **reg. 23(3)(e)**; s. 40 applied (with modifications) (E.W.S.) (9.6.2004) by S.I. 2004/1309, **reg. 17**; s. 40 applied (E.W.S.) (22.4.2005) by S.I. 2005/928, **reg. 4(2)(3)(5)(6)**; s. 40 applied (E.W.S.) (2.4.2006) by S.I. 2006/397, **reg. 34(3)(c)**
- C666** Ss. 37-41 applied (with modifications) (E.W.S.) (the amendment coming into force in accordance with art. 1(1) of the amending S.I.) by [The Channel Tunnel \(Safety\) Order 2007 \(S.I. 2007/3531\)](#), **art. 4(2)(3)(h)** (subject to (4)-(6)) (with art. 7)
- C667** Ss. 1-59, 80-82 applied (temp.) (5.8.2009) by [The Health and Safety at Work etc. Act 1974 \(Application outside Great Britain\) Order 2001 \(S.I. 2001/2127\)](#), arts. 8A, 8B (as inserted by S.I. 2009/1750, **art. 2(3)**)

Changes to legislation: *Health and Safety at Work etc. Act 1974 is up to date with all changes known to be in force on or before 28 April 2021. There are changes that may be brought into force at a future date. Changes that have been made appear in the content and are referenced with annotations. (See end of Document for details) View outstanding changes*

- C668** Ss. 33-42 applied (with modifications) (E.W.) (12.8.2009 with application in accordance with reg. 3 of the amending S.I.) by The Major Accident Off-Site Emergency Plan (Management of Waste from Extractive Industries)(England and Wales) Regulations 2009 (S.I. 2009/1927), {reg. 9(1)}
- C669** Ss. 37-41 applied (with modifications) (E.W.S.) (6.4.2010) by The Rail Vehicle Accessibility (Non-Interoperable Rail System) Regulations 2010 (S.I. 2010/432), **reg. 6(2)(3)(g)**
- C670** Ss. 37-41 applied (with modifications) (E.W.S.) (6.4.2010) by The Train Driving Licences and Certificates Regulations 2010 (S.I. 2010/724), regs. 1(2), **38(2)(3)(g)**

41 Evidence.

- (1) Where an entry is required by any of the relevant statutory provisions to be made in any register or other record, the entry, if made, shall, as against the person by or on whose behalf it was made, be admissible as evidence or in Scotland sufficient evidence of the facts stated therein.
- (2) Where an entry which is so required to be so made with respect to the observance of any of the relevant statutory provisions has not been made, that fact shall be admissible as evidence or in Scotland sufficient evidence that that provision has not been observed.

Modifications etc. (not altering text)

- C36** Ss. 1-59 applied by S.I. 2001/2127 art. 8A 8B (as inserted (E.W.S.) (6.4.2011) by The Health and Safety at Work etc. Act 1974 (Application outside Great Britain) (Variation) Order 2011 (S.I. 2011/745), arts. 1(1), **3(2)**)
- C431** Ss. 33-42 applied (with modifications) (E.W.S.) (1.9.2013) by The Biocidal Products and Chemicals (Appointment of Authorities and Enforcement) Regulations 2013 (S.I. 2013/1506), regs. 2(1), **8(1)** (with reg. 3(4), (5), 8(2)-(7), 31, 32, 33(1))
- C432** Ss. 33-42 applied (1.3.2014) by The Biocidal Products and Chemicals (Appointment of Authorities and Enforcement) Regulations 2013 (S.I. 2013/1506), regs. 2(4), **19** (with reg. 3(4)(5)313233(1))
- C434** Ss. 33-42 applied (1.10.2014) by The Genetically Modified Organisms (Contained Use) Regulations 2014 (S.I. 2014/1663), regs. 1, **30(2)(a)** (with reg. 3(1)(2))
- C435** Ss. 33-42 applied (with modifications) (E.W.S.) (1.6.2015) by The Biocidal Products and Chemicals (Appointment of Authorities and Enforcement) Regulations 2013 (S.I. 2013/1506), regs. 2(2), **17(1)** (with reg. 3(4)(5)313233(1))
- C436** Ss. 33-42 applied (with modifications) (E.W.S.) (1.6.2015) by The Control of Major Accident Hazards Regulations 2015 (S.I. 2015/483), regs. 1(1), **27(1)(d)** (with regs. 3(2), 27(3))
- C437** Ss. 33-42 applied (19.7.2015) by The Offshore Installations (Offshore Safety Directive) (Safety Case etc.) Regulations 2015 (S.I. 2015/398), regs. 1, **36(8)(d)** (with reg. 4(2), Sch. 14)
- C438** Ss. 33-42 applied (19.7.2015) by The Offshore Installations (Offshore Safety Directive) (Safety Case etc.) Regulations 2015 (S.I. 2015/398), regs. 1, **36(1)(d)** (with reg. 4(2), Sch. 14)
- C526** Ss. 34-42 applied (with modifications) (30.7.2018) by The Cableway Installations Regulations 2018 (S.I. 2018/816), regs. 1, **21(1)-(3)** (with reg. 4)
- C617** Ss. 37-41 applied (with modifications) (16.1.2012) by The Railways (Interoperability) Regulations 2011 (S.I. 2011/3066), regs. 1(2), **39(2)(3)(g)** (with reg. 3)
- C671** S. 41 applied by S.I. 1989/840, **arts. 2-10**
 S. 41: power to apply conferred (E.W.S.) (28.8.1995) by 1995 c. 15, **ss. 2(4)(j)**, 5 (with s. 3(5))
 S. 41 applied (with modifications) (E.W.S.) (16.4.1996) by S.I. 1996/772, **reg. 17**
 S. 41 applied (with modifications) (E.W.S.) (1.3.1996) by S.I. 1996/192, **reg. 15, Sch. 14 para. 1(b)**
 S. 41 applied (with modifications) (1.7.1997) by S.I. 1997/831, **reg. 19(1)-(4), Sch. 15 para. 1(a)(b)**
 S. 41 applied (15.11.2000) by S.I. 2000/2831, **reg. 26(1)(a)**
- C672** S. 41 applied (with modifications) (1.1.1993) by S.I. 1992/3073, **reg. 28, Sch. 6 para. 1(b)**

Changes to legislation: *Health and Safety at Work etc. Act 1974 is up to date with all changes known to be in force on or before 28 April 2021. There are changes that may be brought into force at a future date. Changes that have been made appear in the content and are referenced with annotations. (See end of Document for details) View outstanding changes*

- C673** S. 41 modified (6.4.1992) by S.I. 1992/711, **regs. 1(2)**, 28(3)(b)(5)(a).
- C674** Ss. 33-42 applied (with modifications) (1.4.1999) by S.I. 1999/743, **reg. 20(1)**, (2)(3)
- C675** Ss. 33-42 applied (with modifications) (19.11.1999) by S.I. 1999/2892, **reg. 16(1)**
Ss. 33-42 applied (20.9.2001) by S.I. 2001/2975, **reg. 19(d)**
- C676** S. 41 applied (with modifications) (29.11.1999) by S.I. 1999/2001, **reg. 24(1)**, **Sch. 8 para. 1(b)**
- C677** Ss. 1-59, 80-82 applied (11.7.2001) by S.I. 2001/2127, **arts. 4(1)**, 5(1)(2), 6(1), 7(1), 8(1), 10 (with art. 11) (as amended by S.I. 2009/1750, **art. 2(2)(4)**)
Ss. 33-42 applied (E.W.S.) (24.7.2002) by S.I. 2002/1689, **reg. 14(1)(b)**
Ss. 33-42 applied (16.5.2002) by S.I. 2002/1166, **reg. 31** (with art. 37)
- C678** S. 41 applied (with modifications) (E.W.S.) (3.5.2004) by S.I. 2004/129, **reg. 23(3)(e)**; s. 41 applied (with modifications) (E.W.S.) (9.6.2004) by S.I. 2004/1309, **reg. 17**; s. 41 applied (E.W.S.) (22.4.2005) by S.I. 2005/928, **reg. 4(2)(3)(5)(6)**; s. 41 applied (2.4.2006) by S.I. 2006/397, **reg. 34(3)(d)**
- C679** Ss. 37-41 applied (with modifications) (E.W.S.) (the amendment coming into force in accordance with art. 1(1) of the amending S.I.) by The Channel Tunnel (Safety) Order 2007 (S.I. 2007/3531), **art. 4(2)(3)(h)** (subject to (4)-(6)) (with art. 7)
- C680** Ss. 1-59, 80-82 applied (temp.) (5.8.2009) by The Health and Safety at Work etc. Act 1974 (Application outside Great Britain) Order 2001 (S.I. 2001/2127), **arts. 8A, 8B** (as inserted by S.I. 2009/1750, **art. 2(3)**)
- C681** Ss. 33-42 applied (with modifications) (E.W.) (12.8.2009 with application in accordance with reg. 3 of the amending S.I.) by The Major Accident Off-Site Emergency Plan (Management of Waste from Extractive Industries)(England and Wales) Regulations 2009 (S.I. 2009/1927), {reg. 9(1)}
- C682** Ss. 37-41 applied (with modifications) (E.W.S.) (6.4.2010) by The Rail Vehicle Accessibility (Non-Interoperable Rail System) Regulations 2010 (S.I. 2010/432), **reg. 6(2)(3)(g)**
- C683** Ss. 37-41 applied (with modifications) (E.W.S.) (6.4.2010) by The Train Driving Licences and Certificates Regulations 2010 (S.I. 2010/724), **regs. 1(2)**, **38(2)(3)(g)**
- C684** S. 41 applied (with modifications) (E.W.S.) (4.7.2010 for certain purposes and otherwise 4.7.2013) by The Pyrotechnic Articles (Safety) Regulations 2010 (S.I. 2010/1554), **regs. 1**, 18, 37(1), {Sch. 4 paras. 1, 2}
- C685** S. 41 applied (with modifications) (E.W.S.) (1.10.2014) by The Explosives Regulations 2014 (S.I. 2014/1638), **reg. 1(1)**, **Sch. 12 paras. 2, 3**
- C686** S. 41 applied (with modifications) (17.8.2015) by The Pyrotechnic Articles (Safety) Regulations 2015 (S.I. 2015/1553), **reg. 1**, **Sch. 8 paras. 1(r), 2**
- C687** S. 41 applied (with modifications) by S.I. 2014/1638, **Sch. 12 paras. 5-7** (as substituted (E.W.S.) (20.4.2016) by The Explosives Regulations 2014 (Amendment) Regulations 2016 (S.I. 2016/315), **reg. 1**, **Sch. 1** (with **regs. 2(1), 15**))
- C688** S. 41 applied (with modifications) (8.12.2016) by The Lifts Regulations 2016 (S.I. 2016/1093), **reg. 1**, **Sch. 8 paras. 1(r), 2** (with **regs. 3-5**)
- C689** S. 41 applied (with modifications) (E.W.S.) (8.12.2016) by The Equipment and Protective Systems Intended for Use in Potentially Explosive Atmospheres Regulations 2016 (S.I. 2016/1107), **reg. 1(1)**, **Sch. 4 para. 1(q)**
- C690** S. 41 applied (with modifications) (8.12.2016) by The Pressure Equipment (Safety) Regulations 2016 (S.I. 2016/1105), **reg. 1**, **Sch. 8 paras. 1(q), 2** (with **reg. 88**)
- C691** S. 41 applied (with modifications) (8.12.2016) by The Simple Pressure Vessels (Safety) Regulations 2016 (S.I. 2016/1092), **reg. 1**, **Sch. 6 paras. 1(q), 2** (with **reg. 3**)
- C692** S. 41 applied (with modifications) (8.12.2016) by The Electrical Equipment (Safety) Regulations 2016 (S.I. 2016/1101), **reg. 1**, **Sch. 4 paras. 1, 2** (with **reg. 3**)
- C693** S. 41 applied (with modifications) (21.4.2018) by The Personal Protective Equipment (Enforcement) Regulations 2018 (S.I. 2018/390), **reg. 1(1)**, **Sch. 2** (with **reg. 2(1)-(3)**)
- C694** S. 41 applied (with modifications) (21.4.2018) by The Gas Appliances (Enforcement) and Miscellaneous Amendments Regulations 2018 (S.I. 2018/389), **reg. 1(1)**, **Sch. 2** (with **reg. 2**)

Changes to legislation: Health and Safety at Work etc. Act 1974 is up to date with all changes known to be in force on or before 28 April 2021. There are changes that may be brought into force at a future date. Changes that have been made appear in the content and are referenced with annotations. (See end of Document for details) View outstanding changes

42 Power of court to order cause of offence to be remedied or, in certain cases, forfeiture.

- (1) Where a person is convicted of an offence under any of the relevant statutory provisions in respect of any matters which appear to the court to be matters which it is in his power to remedy, the court may, in addition to or instead of imposing any punishment, order him, within such time as may be fixed by the order, to take such steps as may be specified in the order for remedying the said matters.
- (2) The time fixed by an order under subsection (1) above may be extended or further extended by order of the court on an application made before the end of that time as originally fixed or as extended under this subsection, as the case may be.
- (3) Where a person is ordered under subsection (1) above to remedy any matters, that person shall not be liable under any of the relevant statutory provisions in respect of those matters in so far as they continue during the time fixed by the order or any further time allowed under subsection (2) above.
- [^{F163}(3A) Subsection (4) applies where a person is convicted of an offence consisting of acquiring or attempting to acquire, possessing or using an explosive article or substance (within the meaning of any of the relevant statutory provisions) in contravention of any of the relevant statutory provisions.]
- (4) Subject to the following subsection, the court by or before which [^{F164}the person is convicted of the offence] may order the article or substance in question to be forfeited and either destroyed or dealt with in such other manner as the court may order.
- (5) The court shall not order anything to be forfeited under the preceding subsection where a person claiming to be the owner of or otherwise interested in it applies to be heard by the court, unless an opportunity has been given to him to show cause why the order should not be made.

Textual Amendments

F163 S. 42(3A) inserted (16.1.2009) by [Health and Safety \(Offences\) Act 2008 \(c. 20\)](#), ss. 2, 3(2), **Sch. 3 para. 2(2)** (with s. 3(3))

F164 Words in s. 42(4) substituted (16.1.2009) by [Health and Safety \(Offences\) Act 2008 \(c. 20\)](#), ss. 2(1), 3(2), **Sch. 3 para. 2(3)** (with s. 3(3))

Modifications etc. (not altering text)

C36 Ss. 1-59 applied by S.I. 2001/2127 art. 8A 8B (as inserted (E.W.S.) (6.4.2011) by [The Health and Safety at Work etc. Act 1974 \(Application outside Great Britain\) \(Variation\) Order 2011 \(S.I. 2011/745\)](#), arts. 1(1), **3(2)**)

C431 Ss. 33-42 applied (with modifications) (E.W.S.) (1.9.2013) by [The Biocidal Products and Chemicals \(Appointment of Authorities and Enforcement\) Regulations 2013 \(S.I. 2013/1506\)](#), regs. 2(1), **8(1)** (with reg. 3(4), (5), 8(2)-(7), 31, 32, 33(1))

C432 Ss. 33-42 applied (1.3.2014) by [The Biocidal Products and Chemicals \(Appointment of Authorities and Enforcement\) Regulations 2013 \(S.I. 2013/1506\)](#), regs. 2(4), **19** (with reg. 3(4)(5)313233(1))

C434 Ss. 33-42 applied (1.10.2014) by [The Genetically Modified Organisms \(Contained Use\) Regulations 2014 \(S.I. 2014/1663\)](#), regs. 1, **30(2)(a)** (with reg. 3(1)(2))

C435 Ss. 33-42 applied (with modifications) (E.W.S.) (1.6.2015) by [The Biocidal Products and Chemicals \(Appointment of Authorities and Enforcement\) Regulations 2013 \(S.I. 2013/1506\)](#), regs. 2(2), **17(1)** (with reg. 3(4)(5)313233(1))

Changes to legislation: *Health and Safety at Work etc. Act 1974 is up to date with all changes known to be in force on or before 28 April 2021. There are changes that may be brought into force at a future date. Changes that have been made appear in the content and are referenced with annotations. (See end of Document for details) View outstanding changes*

- C436** Ss. 33-42 applied (with modifications) (E.W.S.) (1.6.2015) by The Control of Major Accident Hazards Regulations 2015 (S.I. 2015/483), regs. 1(1), **27(1)(d)** (with regs. 3(2), 27(3))
- C437** Ss. 33-42 applied (19.7.2015) by The Offshore Installations (Offshore Safety Directive) (Safety Case etc.) Regulations 2015 (S.I. 2015/398), regs. 1, **36(8)(d)** (with reg. 4(2), Sch. 14)
- C438** Ss. 33-42 applied (19.7.2015) by The Offshore Installations (Offshore Safety Directive) (Safety Case etc.) Regulations 2015 (S.I. 2015/398), regs. 1, **36(1)(d)** (with reg. 4(2), Sch. 14)
- C526** Ss. 34-42 applied (with modifications) (30.7.2018) by The Cableway Installations Regulations 2018 (S.I. 2018/816), regs. 1, **21(1)-(3)** (with reg. 4)
- C695** S. 42 applied by S.I. 1989/840, **arts. 2-10**
 S. 42 excluded (with saving) (E.W.S.) (1.12.1997) by S.I. 1997/1840, **regs. 7, 9**
 S. 42 applied (with modifications) (9.1.1995) by S.I. 1994/3260, **reg. 17(3)(5)**
 S. 42: power to apply conferred (E.W.S.) (28.8.1995) by 1995 c. 15, **ss. 2(4)(k), 5** (with s. 3(5))
 S. 42 applied (with modifications) (E.W.S.) (16.4.1996) by S.I. 1996/772, **reg. 17**
 S. 42 applied (with modifications) (E.W.S.) (1.3.1996) by S.I. 1996/192, reg. 15, **Sch. 14 para. 1(b)**
 S. 42 applied (with modifications) (1.7.1997) by S.I. 1997/831, reg. 19(1)-(4), **Sch. 15 para. 1(a)(b)**
 S. 42 applied (15.11.2000) by S.I. 2000/2831, **reg. 26(1)(a)**
- C696** S. 42 applied (with modifications) (1.1.1993) by S.I. 1992/3073, reg. 28, **Sch. 6 para. 1(b)**
- C697** S. 42 modified (6.4.1992) by S.I. 1992/711, **regs. 1(2), 28(3)(b)(5)(a)**.
- C698** Ss. 33-42 applied (with modifications) (1.4.1999) by S.I. 1999/743, **reg. 20(1), (2)(3)**
- C699** Ss. 33-42 applied (with modifications) (19.11.1999) by S.I. 1999/2892, **reg. 16(1)**
 Ss. 33-42 applied (20.9.2001) by S.I. 2001/2975, **reg. 19(d)**
- C700** S. 42 applied (with modifications) (29.11.1999) by S.I. 1999/2001, reg. 24(1), **Sch. 8 para. 1(b)**
- C701** Ss. 1-59, 80-82 applied (11.7.2001) by S.I. 2001/2127, **arts. 4(1), 5(1)(2), 6(1), 7(1), 8(1), 10** (with art. 11) (as amended by S.I. 2009/1750, **art. 2(2)(4)**)
 Ss. 33-42 applied (E.W.S.) (24.7.2002) by S.I. 2002/1689, **reg. 14(1)(b)**
 Ss. 33-42 applied (16.5.2002) by S.I. 2002/1166, **reg. 31** (with art. 37)
- C702** S. 42 applied (with modifications) (E.W.S.) (22.3.2003 for certain purposes and 22.9.2003 otherwise) by S.I. 2003/403, **regs. 1(2), 23(2)(a)(3)**; s. 42 applied (with modifications) (E.W.S.) (3.5.2004) by S.I. 2004/129, **reg. 23(3)(e)**; ss. 37-42 applied (with modifications) (E.W.S.) (9.6.2004) by S.I. 2004/1309, **reg. 17**; s. 42 applied (E.W.S.) (22.4.2005) by S.I. 2005/928, **reg. 4(2)(3)(5)(6)**; s. 42 applied (2.4.2006) by S.I. 2006/397, **reg. 34(3)(d)**
- C703** Ss. 1-59, 80-82 applied (temp.) (5.8.2009) by The Health and Safety at Work etc. Act 1974 (Application outside Great Britain) Order 2001 (S.I. 2001/2127), arts. 8A, 8B (as inserted by S.I. 2009/1750, **art. 2(3)**)
- C704** Ss. 33-42 applied (with modifications) (E.W.) (12.8.2009 with application in accordance with reg. 3 of the amending S.I.) by The Major Accident Off-Site Emergency Plan (Management of Waste from Extractive Industries)(England and Wales) Regulations 2009 (S.I. 2009/1927), {reg. 9(1)}
- C705** S. 42 applied (with modifications) (E.W.S.) (4.7.2010 for certain purposes and otherwise 4.7.2013) by The Pyrotechnic Articles (Safety) Regulations 2010 (S.I. 2010/1554), **regs. 1, 18, 37(1)**, {Sch. 4 paras. 1, 2}
- C706** S. 42 applied (with modifications) (1.10.2014) by The Explosives Regulations 2014 (S.I. 2014/1638), **reg. 1(1), Sch. 12 paras. 2, 3**
- C707** S. 42 applied (with modifications) (17.8.2015) by The Pyrotechnic Articles (Safety) Regulations 2015 (S.I. 2015/1553), **reg. 1, Sch. 8 paras. 1(s), 2**
- C708** S. 42 applied (with modifications) by S.I. 2014/1638, Sch. 12 paras. 5-7 (as substituted (E.W.S.) (20.4.2016) by The Explosives Regulations 2014 (Amendment) Regulations 2016 (S.I. 2016/315), **reg. 1, Sch. 1** (with **regs. 2(1), 15**))
- C709** S. 42 applied (with modifications) (8.12.2016) by The Electrical Equipment (Safety) Regulations 2016 (S.I. 2016/1101), **reg. 1, Sch. 4 paras. 1, 2** (with reg. 3)
- C710** S. 42 applied (with modifications) (8.12.2016) by The Simple Pressure Vessels (Safety) Regulations 2016 (S.I. 2016/1092), **reg. 1, Sch. 6 paras. 1(r), 2** (with reg. 3)
- C711** S. 42 applied (with modifications) (8.12.2016) by The Lifts Regulations 2016 (S.I. 2016/1093), **reg. 1, Sch. 8 paras. 1(s), 2** (with **regs. 3-5**)

Changes to legislation: *Health and Safety at Work etc. Act 1974 is up to date with all changes known to be in force on or before 28 April 2021. There are changes that may be brought into force at a future date. Changes that have been made appear in the content and are referenced with annotations. (See end of Document for details) View outstanding changes*

- C712** S. 42 applied (with modifications) (8.12.2016) by [The Pressure Equipment \(Safety\) Regulations 2016 \(S.I. 2016/1105\)](#), reg. 1, Sch. 8 paras. 1(r), 2 (with reg. 88)
- C713** S. 42 applied (with modifications) (E.W.S.) (8.12.2016) by [The Equipment and Protective Systems Intended for Use in Potentially Explosive Atmospheres Regulations 2016 \(S.I. 2016/1107\)](#), reg. 1(1), **Sch. 4 para. 1(r)**
- C714** S. 42 applied (with modifications) (21.4.2018) by [The Personal Protective Equipment \(Enforcement\) Regulations 2018 \(S.I. 2018/390\)](#), reg. 1(1), **Sch. 2** (with reg. 2(1)-(3))
- C715** S. 42 applied (with modifications) (21.4.2018) by [The Gas Appliances \(Enforcement\) and Miscellaneous Amendments Regulations 2018 \(S.I. 2018/389\)](#), reg. 1(1), **Sch. 2** (with reg. 2)
- C716** S. 42(1) extended (E.W.S.) (1.10.1996) by [S.I. 1996/1513](#), **reg. 10**
- C717** S. 42(1)-(3) applied (with modifications) (E.W.S.) (the amendment coming into force in accordance with art. 1(1) of the amending S.I.) by [The Channel Tunnel \(Safety\) Order 2007 \(S.I. 2007/3531\)](#), **art. 4(2)(3)(h)** (subject to (4)-(6)) (with art. 7)
- C718** S. 42(1)-(3) applied (with modifications) (E.W.S.) (6.4.2010) by [The Rail Vehicle Accessibility \(Non-Interoperable Rail System\) Regulations 2010 \(S.I. 2010/432\)](#), **reg. 6(2)(3)(g)**
- C719** S. 42(1)-(3) applied (with modifications) (E.W.S.) (6.4.2010) by [The Train Driving Licences and Certificates Regulations 2010 \(S.I. 2010/724\)](#), regs. 1(2), **38(2)(3)(g)**
- C720** S. 42(1)-(3) applied (with modifications) (16.1.2012) by [The Railways \(Interoperability\) Regulations 2011 \(S.I. 2011/3066\)](#), regs. 1(2), **39(2)(3)(g)** (with reg. 3)
- C721** S. 42(2) extended (E.W.S.) (1.10.1996) by [S.I. 1996/1513](#), **reg. 10**
- C722** S. 42(1)-(3) applied (with modifications) (E.W.S.) (the amendment coming into force in accordance with art. 1(1) of the amending S.I.) by [The Channel Tunnel \(Safety\) Order 2007 \(S.I. 2007/3531\)](#), **art. 4(2)(3)(h)** (subject to (4)-(6)) (with art. 7)
- C723** S. 42(3) extended (E.W.S.) (1.10.1996) by [S.I. 1996/1513](#), **reg. 10**
- C724** S. 42(1)-(3) applied (with modifications) (E.W.S.) (the amendment coming into force in accordance with art. 1(1) of the amending S.I.) by [The Channel Tunnel \(Safety\) Order 2007 \(S.I. 2007/3531\)](#), **art. 4(2)(3)(h)** (subject to (4)-(6)) (with art. 7)

Financial provisions

43 Financial provisions.

- (1) It shall be the duty of the Secretary of State to pay to [^{F165}the Executive] such sums as are approved by the Treasury and as he considers appropriate for the purpose of enabling [^{F165}the Executive] to perform its functions;
^{F166}
- (2) Regulations may provide for such fees as may be fixed by or determined under the regulations to be payable for or in connection with the performance by or on behalf of any authority to which this subsection applies of any function conferred on that authority by or under any of the relevant statutory provisions.
- (3) Subsection (2) above applies to the following authorities, namely ^{F167}... the Executive, the Secretary of State, . . . ^{F168}, every enforcing authority, and any other person on whom any function is conferred by or under any of the relevant statutory provisions.
- (4) Regulations under this section may specify the person by whom any fee payable under the regulations is to be paid; but no such fee shall be made payable by a person in any of the following capacities, namely an employee, a person seeking employment, a person training for employment, and a person seeking training for employment.

Changes to legislation: *Health and Safety at Work etc. Act 1974 is up to date with all changes known to be in force on or before 28 April 2021. There are changes that may be brought into force at a future date. Changes that have been made appear in the content and are referenced with annotations. (See end of Document for details) View outstanding changes*

(5) Without prejudice to section 82(3), regulations under this section may fix or provide for the determination of different fees in relation to different functions, or in relation to the same function in different circumstances.

[^{F169}(6) The power to make regulations under this section shall be exercisable by the Secretary of State ^{F170} . . .]

(8) In subsection (4) above the references to a person training for employment and a person seeking training for employment shall include respectively a person attending an industrial rehabilitation course provided by virtue of the ^{M4}Employment and Training Act 1973 and a person seeking to attend such a course.

(9) For the purposes of this section the performance by an inspector of his functions shall be treated as the performance by the enforcing authority which appointed him of functions conferred on that authority by or under any of the relevant statutory provisions.

Textual Amendments

F165 Words in s. 43(1) substituted (1.4.2008) by [The Legislative Reform \(Health and Safety Executive\) Order 2008 \(S.I. 2008/960\)](#), [art. 14\(a\)\(i\)](#) (with art. 21, Sch. 2)

F166 Words in s. 43(1) omitted (1.4.2008) by virtue of [The Legislative Reform \(Health and Safety Executive\) Order 2008 \(S.I. 2008/960\)](#), [art. 14\(a\)\(ii\)](#) (with art. 21, Sch. 2)

F167 Words in s. 43(3) omitted (1.4.2008) by virtue of [The Legislative Reform \(Health and Safety Executive\) Order 2008 \(S.I. 2008/960\)](#), [art. 14\(b\)](#) (with art. 21, Sch. 2)

F168 Words repealed by [Employment Protection Act 1975 \(c. 71\)](#), [Sch. 18](#)

F169 S. 43(6) substituted for s. 43(6)(7) by [Employment Protection Act 1975 \(c. 71\)](#), [Sch. 15 para. 12](#)

F170 Words in s. 43(6) repealed (27.3.2002) by [S.I. 2002/794](#), [art. 5\(2\)](#), [Sch.](#) (with art. 6)

Modifications etc. (not altering text)

C36 Ss. 1-59 applied by [S.I. 2001/2127 art. 8A 8B](#) (as inserted (E.W.S.) (6.4.2011) by [The Health and Safety at Work etc. Act 1974 \(Application outside Great Britain\) \(Variation\) Order 2011 \(S.I. 2011/745\)](#), [arts. 1\(1\)](#), [3\(2\)](#))

C725 Ss. 1-25, 26, 27, 28, 30, 33, 34-59, 80, 81 and 82 applied by [S.I. 1989/840](#), [arts. 2-10](#)

C726 Ss. 1-59, 80-82 applied (11.7.2001) by [S.I. 2001/2127](#), [arts. 4\(1\)](#), [5\(1\)\(2\)](#), [6\(1\)](#), [7\(1\)](#), [8\(1\)](#), [10](#) (with art. 11) (as amended by [S.I. 2009/1750](#), [art. 2\(2\)\(4\)](#))

C727 Ss. 1-59, 80-82 applied (temp.) (5.8.2009) by [The Health and Safety at Work etc. Act 1974 \(Application outside Great Britain\) Order 2001 \(S.I. 2001/2127\)](#), [arts. 8A](#), [8B](#) (as inserted by [S.I. 2009/1750](#), [art. 2\(3\)](#))

Marginal Citations

M4 1973 c. 50.

[^{F171}
43A **Railway safety levy** **E+W+S**

(1) The Secretary of State may make regulations requiring persons who provide railway services to pay railway safety levy.

(2) Railway safety levy shall be applied only for the purpose of meeting expenses incurred—

[^{F172}(a) in respect of activities undertaken by the [^{F173}Office of Rail and Road] under or by virtue of this Act or Schedule 3 to the Railways Act 2005; or

Changes to legislation: Health and Safety at Work etc. Act 1974 is up to date with all changes known to be in force on or before 28 April 2021. There are changes that may be brought into force at a future date. Changes that have been made appear in the content and are referenced with annotations. (See end of Document for details) View outstanding changes

- (b) in respect of activities in relation to a transport system falling within paragraph 1(3) of that Schedule that are undertaken by that Office under or by virtue of any other enactment.]
- (3) The railway safety levy shall not be used to meet—
 - (a) an expense in respect of which a fee is payable under regulations made under section 43, or
 - (b) an expense in respect of a matter specified by the regulations for the purpose of this paragraph.
- (4) Where an expense is incurred partly in respect of activity within subsection (2)(a) or (b) and partly in respect of other activity, the railway safety levy may be used to meet a part of that expense which is reasonably referable to activity within subsection (2) (a) or (b).
- (5) Regulations under subsection (1) may, in particular, determine or enable the [^{F173}Office of Rail and Road] to determine—
 - (a) the total amount of the railway safety levy to be imposed in respect of a specified period;
 - (b) the persons by whom the levy is to be paid;
 - (c) the criteria for assessing the proportion of the levy to be paid by a particular person (which may, in particular, refer to the size of a person's income or provide for an amount to be reduced or waived in specified circumstances);
 - (d) the periods in respect of which the levy is to be paid;
 - (e) the manner in which the levy is to be paid;
 - (f) the person to whom the levy is to be paid;
 - (g) when the levy is to be paid.
- (6) Regulations under subsection (1) may, in particular, enable the [^{F173}Office of Rail and Road]—
 - (a) to require a person who provides railway services to supply information for the purposes of the consideration of a matter specified in subsection (5);
 - (b) where information requested is not supplied, to make assumptions;
 - (c) to revise a determination of a matter specified in subsection (5)(whether before, during or after the period to which it relates);
 - (d) to make refunds.
- (7) Regulations by virtue of subsection (6)(a) may, in particular, make provision—
 - (a) about the manner and timing of the supply of information;
 - (b) about certification of the accuracy of information supplied;
 - (c) creating a criminal offence in connection with the supply of inaccurate or misleading information (but not an offence punishable with imprisonment).
- (8) Regulations under subsection (1) may enable payment to be enforced by civil proceeding.
- (9) For the purposes of this section a person provides railway services if he manages or controls, or participates in managing or controlling, a transport system [^{F174}falling within paragraph 1(3) of Schedule 3 to the Railways Act 2005] .]

Changes to legislation: Health and Safety at Work etc. Act 1974 is up to date with all changes known to be in force on or before 28 April 2021. There are changes that may be brought into force at a future date. Changes that have been made appear in the content and are referenced with annotations. (See end of Document for details) View outstanding changes

Extent Information

- E7** This version of this provision extends to England and Wales and Scotland only; a separate version has been created for Northern Ireland only

Textual Amendments

- F171** S. 43A inserted (10.9.2003) by [Railways and Transport Safety Act 2003 \(c. 20\)](#), **ss. 105(1)**, 120
- F172** S. 43A(2)(a)(b) substituted (E.W.S.) (7.2.2006) by [Railways Act 2005 \(c. 14\)](#), **ss. 2, 60**, **Sch. 3 para. 12(2)**; [S.I. 2006/266](#), **art. 2(1)(a)(b)**
- F173** Words in s. 43A substituted (E.W.S.) (16.10.2015) by [The Office of Rail Regulation \(Change of Name\) Regulations 2015 \(S.I. 2015/1682\)](#), **reg. 1(2)**, **Sch. para. 4(c)(iii)**
- F174** Words in s. 43A(9) substituted (E.W.S.) (7.2.2006) by [Railways Act 2005 \(c. 14\)](#), **ss. 2, 60**, **Sch. 3 para. 12(4)**; [S.I. 2006/266](#), **art. 2(1)(a)(b)**

Modifications etc. (not altering text)

- C36** Ss. 1-59 applied by [S.I. 2001/2127 art. 8A 8B](#) (as inserted (E.W.S.) (6.4.2011) by [The Health and Safety at Work etc. Act 1974 \(Application outside Great Britain\) \(Variation\) Order 2011 \(S.I. 2011/745\)](#), **arts. 1(1), 3(2)**)
- C728** Ss. 1-59, 80-82 applied by [S.I. 2001/2127](#), **arts. 4(1), 5(1)(2), 6(1), 7(1), 8(1), 10** (with [art. 11](#)) (as amended (5.8.2009) by [S.I. 2009/1750](#), **art. 2(2)(4)**)
- C729** Ss. 1-59, 80-82 applied (temp.) (5.8.2009) by [The Health and Safety at Work etc. Act 1974 \(Application outside Great Britain\) Order 2001 \(S.I. 2001/2127\)](#), **arts. 8A, 8B** (as inserted by [S.I. 2009/1750](#), **art. 2(3)**)

43A Railway safety levy **N.I.**

- (1) The Secretary of State may make regulations requiring persons who provide railway services to pay railway safety levy.
- (2) Railway safety levy shall be applied only for the purpose of meeting expenses incurred—
 - (a) in respect of activity undertaken by the Executive in reliance on section 117 of the Railways Act 1993 (safety of railways, &c.), or
 - (b) in respect of activity undertaken by the Executive, under or by virtue of any other enactment, in relation to a transport system to which that section applies.
- (3) The railway safety levy shall not be used to meet—
 - (a) an expense in respect of which a fee is payable under regulations made under section 43, or
 - (b) an expense in respect of a matter specified by the regulations for the purpose of this paragraph.
- (4) Where an expense is incurred partly in respect of activity within subsection (2)(a) or (b) and partly in respect of other activity, the railway safety levy may be used to meet a part of that expense which is reasonably referable to activity within subsection (2)(a) or (b).
- (5) Regulations under subsection (1) may, in particular, determine or enable the Commission or the Executive to determine—
 - (a) the total amount of the railway safety levy to be imposed in respect of a specified period;
 - (b) the persons by whom the levy is to be paid;

Changes to legislation: *Health and Safety at Work etc. Act 1974 is up to date with all changes known to be in force on or before 28 April 2021. There are changes that may be brought into force at a future date. Changes that have been made appear in the content and are referenced with annotations. (See end of Document for details) View outstanding changes*

- (c) the criteria for assessing the proportion of the levy to be paid by a particular person (which may, in particular, refer to the size of a person's income or provide for an amount to be reduced or waived in specified circumstances);
 - (d) the periods in respect of which the levy is to be paid;
 - (e) the manner in which the levy is to be paid;
 - (f) the person to whom the levy is to be paid;
 - (g) when the levy is to be paid.
- (6) Regulations under subsection (1) may, in particular, enable the Commission or the Executive—
- (a) to require a person who provides railway services to supply information for the purposes of the consideration of a matter specified in subsection (5);
 - (b) where information requested is not supplied, to make assumptions;
 - (c) to revise a determination of a matter specified in subsection (5)(whether before, during or after the period to which it relates);
 - (d) to make refunds.
- (7) Regulations by virtue of subsection (6)(a) may, in particular, make provision—
- (a) about the manner and timing of the supply of information;
 - (b) about certification of the accuracy of information supplied;
 - (c) creating a criminal offence in connection with the supply of inaccurate or misleading information (but not an offence punishable with imprisonment).
- (8) Regulations under subsection (1) may enable payment to be enforced by civil proceeding.
- (9) For the purposes of this section a person provides railway services if he manages or controls, or participates in managing or controlling, a transport system to which section 117 of the Railways Act 1993 applies.

Extent Information

E16 This version of this provision extends to Northern Ireland only; a separate version has been created for England and Wales and Scotland only

Modifications etc. (not altering text)

C729 Ss. 1-59, 80-82 applied (temp.) (5.8.2009) by The Health and Safety at [Work etc. Act 1974](#) ([Application outside Great Britain](#)) Order 2001 (S.I. 2001/2127), arts. 8A, 8B (as inserted by S.I. 2009/1750, [art. 2\(3\)](#))

C869 Ss. 1-59, 80-82 applied by S.I. 2001/2127, arts. [4\(1\)](#), [5\(1\)\(2\)](#), [6\(1\)](#), [7\(1\)](#), [8\(1\)](#), [10](#) (with [art. 11](#)) (as amended (5.8.2009) by S.I. 2009/1750, [art. 2\(2\)\(4\)](#))

Miscellaneous and supplementary

44 Appeals in connection with licensing provisions in the relevant statutory provisions.

- (1) Any person who is aggrieved by a decision of an authority having power to issue licences ^{F175}...under any of the relevant statutory provisions—

Changes to legislation: *Health and Safety at Work etc. Act 1974 is up to date with all changes known to be in force on or before 28 April 2021. There are changes that may be brought into force at a future date. Changes that have been made appear in the content and are referenced with annotations. (See end of Document for details) View outstanding changes*

- (a) refusing to issue him a licence, to renew a licence held by him, or to transfer to him a licence held by another;
 - (b) issuing him a licence on or subject to any term, condition or restriction whereby he is aggrieved;
 - (c) varying or refusing to vary any term, condition or restriction on or subject to which a licence is held by him; or
 - (d) revoking a licence held by him,
- may appeal to the Secretary of State.
- (2) The Secretary of State may, in such cases as he considers it appropriate to do so, having regard to the nature of the questions which appear to him to arise, direct that an appeal under this section shall be determined on his behalf by a person appointed by him for that purpose.
- (3) Before the determination of an appeal the Secretary of State shall ask the appellant and the authority against whose decision the appeal is brought whether they wish to appear and be heard on the appeal and—
- (a) the appeal may be determined without a hearing of the parties if both of them express a wish not to appear and be heard as aforesaid;
 - (b) the Secretary of State shall, if either of the parties expresses a wish to appear and be heard, afford to both of them an opportunity of so doing.
- (4) The Tribunals and Inquiries Act [^{F176}1992] shall apply to a hearing held by a person appointed in pursuance of subsection (2) above to determine an appeal as it applies to a statutory inquiry held by the Secretary of State, but as if in [^{F176}section 10(1)] of that Act (statement of reasons for decisions) the reference to any decision taken by the Secretary of State included a reference to a decision taken on his behalf by that person.

^{F177}(4A)

- (5) A person who determines an appeal under this section on behalf of the Secretary of State and the Secretary of State, if he determines such an appeal, may give such directions as he considers appropriate to give effect to his determination.
- (6) The Secretary of State may pay to any person appointed to hear or determine an appeal under this section on his behalf such remuneration and allowances as the Secretary of State may with the approval of the Minister for the Civil Service determine.
- (7) In this section—
 - (a) “licence” means a licence under any of the relevant statutory provisions ^{F178} ...;
 - ^{F179}(b)

^{F180}(8)

Textual Amendments

- F175** Words in s. 44(1) omitted (1.4.2014) by virtue of [Energy Act 2013 \(c. 32\), s. 156\(1\), Sch. 12 para. 10\(2\)](#); S.I. 2014/251, art. 4
- F176** Words in s. 44(4) substituted (1.10.1992) by [Tribunals and Inquiries Act 1992 \(c. 53\), ss. 18\(1\), 19\(2\), Sch. 3 para.9](#)
- F177** S. 44(4A) omitted (19.9.2013) by virtue of [The Public Bodies \(Abolition of Administrative Justice and Tribunals Council\) Order 2013 \(S.I. 2013/2042\), art. 1\(2\), Sch. para. 2](#)
- F178** Words in s. 44(7)(a) omitted (1.4.2014) by virtue of [Energy Act 2013 \(c. 32\), s. 156\(1\), Sch. 12 para. 10\(3\)\(a\)](#); S.I. 2014/251, art. 4

Changes to legislation: *Health and Safety at Work etc. Act 1974 is up to date with all changes known to be in force on or before 28 April 2021. There are changes that may be brought into force at a future date. Changes that have been made appear in the content and are referenced with annotations. (See end of Document for details) View outstanding changes*

F179 S. 44(7)(b) omitted (1.4.2014) by virtue of [Energy Act 2013 \(c. 32\)](#), s. 156(1), [Sch. 12 para. 10\(3\)\(b\)](#); [S.I. 2014/251](#), art. 4

F180 S. 44(8) omitted (1.4.2014) by virtue of [Energy Act 2013 \(c. 32\)](#), s. 156(1), [Sch. 12 para. 10\(4\)](#); [S.I. 2014/251](#), art. 4

Modifications etc. (not altering text)

C36 Ss. 1-59 applied by [S.I. 2001/2127](#) art. 8A 8B (as inserted (E.W.S.) (6.4.2011) by [The Health and Safety at Work etc. Act 1974 \(Application outside Great Britain\) \(Variation\) Order 2011 \(S.I. 2011/745\)](#), arts. 1(1), [3\(2\)](#))

C730 Ss. 1-25, 26, 27, 28, 30, 33, 34-59, 80, 81 and 82 applied by [S.I. 1989/840](#), [arts. 2-10](#)

C731 Ss. 1-59, 80-82 applied (11.7.2001) by [S.I. 2001/2127](#), [arts. 4\(1\)](#), 5(1)(2), 6(1), 7(1), 8(1), 10 (with art. 11) (as amended by [S.I. 2009/1750](#), [art. 2\(2\)\(4\)](#))

C732 Ss. 1-59, 80-82 applied (temp.) (5.8.2009) by [The Health and Safety at Work etc. Act 1974 \(Application outside Great Britain\) Order 2001 \(S.I. 2001/2127\)](#), arts. 8A, 8B (as inserted by [S.I. 2009/1750](#), [art. 2\(3\)](#))

C733 S. 44 applied (1.10.2014) by [The Petroleum \(Consolidation\) Regulations 2014 \(S.I. 2014/1637\)](#), regs. 1(2), [11\(2\)](#) (with reg. 3(1))

C734 S. 44 applied (1.10.2014) by [The Petroleum \(Consolidation\) Regulations 2014 \(S.I. 2014/1637\)](#), regs. 1(2), [15\(2\)](#) (with reg. 3(1))

C735 S. 44(2)-(6) applied (13.5.2000) by [S.I. 1999/3232](#), [reg. 5\(6\)](#)

C736 S. 44(2)-(6) applied (26.4.2005) by [S.I. 2005/1082](#), [reg. 19](#)

C737 S. 44(2)-(6) applied (1.1.2018) by [The Ionising Radiations Regulations 2017 \(S.I. 2017/1075\)](#), regs. 1(2), [6\(8\)](#), 7(7), [Sch. 3 para. 19](#) (with regs. 2(5), 3, 40, [Sch. 8](#))

45 Default powers.

- (1) Where, in the case of a local authority who are an enforcing authority, [^{F181}the Executive] is of the opinion that an investigation should be made as to whether that local authority have failed to perform any of their enforcement functions [^{F181}the Executive] may make a report to the Secretary of State.
- (2) The Secretary of State may, after considering a report submitted to him under the preceding subsection, cause a local inquiry to be held; and the provisions of subsections (2) to (5) of section 250 of the ^{M5}Local Government Act 1972 as to local inquiries shall, without prejudice to the generality of subsection (1) of that section, apply to a local inquiry so held as they apply to a local inquiry held in pursuance of that section.
- (3) If the Secretary of State is satisfied, after having caused a local inquiry to be held into the matter, that a local authority have failed to perform any of their enforcement functions, he may make an order declaring the authority to be in default.
- (4) An order made by virtue of the preceding subsection which declares an authority to be in default may, for the purpose of remedying the default, direct the authority (hereafter in this section referred to as “the defaulting authority”) to perform such of their enforcement functions as are specified in the order in such manner as may be so specified and may specify the time or times within which those functions are to be performed by the authority.
- (5) If the defaulting authority fail to comply with any direction contained in such an order the Secretary of State may, instead of enforcing the order by mandamus, make an order transferring to the Executive such of the enforcement functions of the defaulting authority as he thinks fit.

Changes to legislation: *Health and Safety at Work etc. Act 1974 is up to date with all changes known to be in force on or before 28 April 2021. There are changes that may be brought into force at a future date. Changes that have been made appear in the content and are referenced with annotations. (See end of Document for details) View outstanding changes*

- (6) Where any enforcement functions of the defaulting authority are transferred in pursuance of the preceding subsection, the amount of any expenses which the Executive certifies were incurred by it in performing those functions shall on demand be paid to it by the defaulting authority.
- (7) Any expenses which in pursuance of the preceding subsection are required to be paid by the defaulting authority in respect of any enforcement functions transferred in pursuance of this section shall be defrayed by the authority in the like manner, and shall be debited to the like account, as if the enforcement functions had not been transferred and the expenses had been incurred by the authority in performing them.
- (8) Where the defaulting authority are required to defray any such expenses the authority shall have the like powers for the purpose of raising the money for defraying those expenses as they would have had for the purpose of raising money required for defraying expenses incurred for the purpose of the enforcement functions in question.
- (9) An order transferring any enforcement functions of the defaulting authority in pursuance of subsection (5) above may provide for the transfer to the Executive of such of the rights, liabilities and obligations of the authority as the Secretary of State considers appropriate; and where such an order is revoked the Secretary of State may, by the revoking order or a subsequent order, make such provision as he considers appropriate with respect to any rights, liabilities and obligations held by the Executive for the purposes of the transferred enforcement functions.
- (10) The Secretary of State may by order vary or revoke any order previously made by him in pursuance of this section.
- (11) In this section “enforcement functions”, in relation to a local authority, means the functions of the authority as an enforcing authority.
- (12) In the application of this section to Scotland—
- (a) in subsection (2) for the words “subsections (2) to (5) of section 250 of the ^{M6}Local Government Act 1972” there shall be substituted the words “subsections (2) to (8) of section 210 of the ^{M7}Local Government (Scotland) Act 1973”, except that before 16th May 1975 for the said words there shall be substituted the words “subsections (2) to (9) of section 355 of the ^{M8}Local Government (Scotland) Act 1947”;
 - (b) in subsection (5) the words “instead of enforcing the order by mandamus” shall be omitted.

Textual Amendments

F181 Words in s. 45(1) substituted (1.4.2008) by [The Legislative Reform \(Health and Safety Executive\) Order 2008 \(S.I. 2008/960\)](#), [art. 15](#) (with [art. 21](#), [Sch. 2](#))

Modifications etc. (not altering text)

C36 Ss. 1-59 applied by S.I. 2001/2127 art. 8A 8B (as inserted (E.W.S.)) (6.4.2011) by [The Health and Safety at Work etc. Act 1974 \(Application outside Great Britain\) \(Variation\) Order 2011 \(S.I. 2011/745\)](#), [arts. 1\(1\)](#), [3\(2\)](#)

C738 Ss. 1-25, 26, 27, 28, 30, 33, 34-59, 80, 81 and 82 applied by S.I. 1989/840, [arts. 2-10](#)

C739 Ss. 1-59, 80-82 applied (11.7.2001) by S.I. 2001/2127, [arts. 4\(1\)](#), [5\(1\)\(2\)](#), [6\(1\)](#), [7\(1\)](#), [8\(1\)](#), [10](#) (with [art. 11](#)) (as amended by S.I. 2009/1750, [art. 2\(2\)\(4\)](#))

Changes to legislation: *Health and Safety at Work etc. Act 1974 is up to date with all changes known to be in force on or before 28 April 2021. There are changes that may be brought into force at a future date. Changes that have been made appear in the content and are referenced with annotations. (See end of Document for details) View outstanding changes*

C740 Ss. 1-59, 80-82 applied (temp.) (5.8.2009) by The Health and Safety at [Work etc. Act 1974](#) (Application outside Great Britain) Order 2001 (S.I. 2001/2127), arts. 8A, 8B (as inserted by S.I. 2009/1750, [art. 2\(3\)](#))

Marginal Citations

M5 1972 c. 70.
M6 1972 c. 70.
M7 1973 c. 65.
M8 1947 c. 43.

46 Service of notices.

- (1) Any notice required or authorised by any of the relevant statutory provisions to be served on or given to an inspector may be served or given by delivering it to him or by leaving it at, or sending it by post to, his office.
- (2) Any such notice required or authorised to be served on or given to a person other than an inspector may be served or given by delivering it to him, or by leaving it at his proper address, or by sending it by post to him at that address.
- (3) Any such notice may—
 - (a) in the case of a body corporate, be served on or given to the secretary or clerk of that body;
 - (b) in the case of a partnership, be served on or given to a partner or a person having the control or management of the partnership business or, in Scotland, the firm.
- (4) For the purposes of this section and of [^{F182}section 7 of the ^{M9}Interpretation Act 1978] (service of documents by post) in its application to this section, the proper address of any person on or to whom any such notice is to be served or given shall be his last known address, except that—
 - (a) in the case of a body corporate or their secretary or clerk, it shall be the address of the registered or principal office of that body;
 - (b) in the case of a partnership or a person having the control or the management of the partnership business, it shall be the principal office of the partnership;
 and for the purposes of this subsection the principal office of a company registered outside the United Kingdom or of a partnership carrying on business outside the United Kingdom shall be their principal office within the United Kingdom.
- (5) If the person to be served with or given any such notice has specified an address within the United Kingdom other than his proper address within the meaning of subsection (4) above as the one at which he or someone on his behalf will accept notices of the same description as that notice, that address shall also be treated for the purposes of this section and [^{F182}section 7 of the Interpretation Act 1978] as his proper address.
- (6) Without prejudice to any other provision of this section, any such notice required or authorised to be served on or given to the owner or occupier of any premises (whether a body corporate or not) may be served or given by sending it by post to him at those premises, or by addressing it by name to the person on or to whom it is to be served or given and delivering it to some responsible person who is or appears to be resident or employed in the premises.

Changes to legislation: *Health and Safety at Work etc. Act 1974 is up to date with all changes known to be in force on or before 28 April 2021. There are changes that may be brought into force at a future date. Changes that have been made appear in the content and are referenced with annotations. (See end of Document for details) View outstanding changes*

- (7) If the name or the address of any owner or occupier of premises on or to whom any such notice as aforesaid is to be served or given cannot after reasonable inquiry be ascertained, the notice may be served or given by addressing it to the person on or to whom it is to be served or given by the description of “owner” or “occupier” of the premises (describing them) to which the notice relates, and by delivering it to some responsible person who is or appears to be resident or employed in the premises, or, if there is no such person to whom it can be delivered, by affixing it or a copy of it to some conspicuous part of the premises.
- (8) The preceding provisions of this section shall apply to the sending or giving of a document as they apply to the giving of a notice.

Textual Amendments

F182 Words substituted by virtue of [Interpretation Act 1978 \(c. 30\), s. 25\(2\)](#)

Modifications etc. (not altering text)

- C36** Ss. 1-59 applied by S.I. 2001/2127 art. 8A 8B (as inserted (E.W.S.) (6.4.2011) by [The Health and Safety at Work etc. Act 1974 \(Application outside Great Britain\) \(Variation\) Order 2011 \(S.I. 2011/745\)](#), arts. 1(1), **3(2)**)
- C741** S. 46 applied by S.I. 1989/840, **arts. 2-10**
 S. 46 excluded (with saving) (E.W.S.) (1.12.1997) by S.I. 1997/1840, **regs. 7, 9**
 S. 46 extended (E.W.S.) (1.10.1996) by S.I. 1996/1513, **reg. 10 S. 46**: power to apply conferred (E.W.S.) (28.8.1995) by 1995 c. 15, **ss. 2(4)(l), 5** (with s. 3(5))
 S. 46 applied (with modifications) (E.W.S.) (16.4.1996) by S.I. 1996/772, **reg. 17**
- C742** Ss. 1-59, 80-82 applied (11.7.2001) by S.I. 2001/2127, **arts. 4(1), 5(1)(2), 6(1), 7(1), 8(1), 10** (with art. 11) (as amended by S.I. 2009/1750, **art. 2(2)(4)**)
- C743** S. 46 applied (with modifications) (E.W.S.) (22.3.2003 for certain purposes and 22.9.2003 otherwise) by S.I. 2003/403, **regs. 1(2), 23(2)(a)(3)**; s. 46 applied (with modifications) (E.W.S.) (9.6.2004) by S.I. 2004/1309, **reg. 17**
- C744** S. 46 applied (with modifications) (E.W.S.) (the amendment coming into force in accordance with art. 1(1) of the amending S.I.) by [The Channel Tunnel \(Safety\) Order 2007 \(S.I. 2007/3531\)](#), **art. 4(2)(3)(i)** (subject to (4)-(6)) (with art. 7)
- C745** Ss. 1-59, 80-82 applied (temp.) (5.8.2009) by [The Health and Safety at Work etc. Act 1974 \(Application outside Great Britain\) Order 2001 \(S.I. 2001/2127\)](#), arts. 8A, 8B (as inserted by S.I. 2009/1750, **art. 2(3)**)
- C746** S. 46 applied (with modifications) (E.W.S.) (6.4.2010) by [The Rail Vehicle Accessibility \(Non-Interoperable Rail System\) Regulations 2010 \(S.I. 2010/432\)](#), **reg. 6(2)(3)(h)**
- C747** S. 46 applied (with modifications) (E.W.S.) (6.4.2010) by [The Train Driving Licences and Certificates Regulations 2010 \(S.I. 2010/724\)](#), **regs. 1(2), 38(2)(3)(h)**
- C748** S. 46 applied (with modifications) (16.1.2012) by [The Railways \(Interoperability\) Regulations 2011 \(S.I. 2011/3066\)](#), **regs. 1(2), 39(2)(3)(h)** (with reg. 3)
- C749** S. 46 applied (1.3.2014) by [The Biocidal Products and Chemicals \(Appointment of Authorities and Enforcement\) Regulations 2013 \(S.I. 2013/1506\)](#), **regs. 2(4), 29(1)** (with reg. 3(4)(5)31)
- C750** S. 46 applied by SI 1975/335 reg. 11(3) (as substituted (1.4.2014) by [The Energy Act 2013 \(Office for Nuclear Regulation\) \(Consequential Amendments, Transitional Provisions and Savings\) Order 2014 \(S.I. 2014/469\)](#), art. 1(2), **Sch. 3 para. 175** (with Sch. 4))
- C751** S. 46 applied (with modifications) by S.I. 2014/1638, Sch. 12 paras. 5-7 (as substituted (E.W.S.) (20.4.2016) by [The Explosives Regulations 2014 \(Amendment\) Regulations 2016 \(S.I. 2016/315\)](#), reg. 1, **Sch. 1** (with **regs. 2(1), 15**))
- C752** S. 46 applied (with modifications) (30.7.2018) by [The Cableway Installations Regulations 2018 \(S.I. 2018/816\)](#), **regs. 1, 21(1)-(3)** (with reg. 4)

Changes to legislation: *Health and Safety at Work etc. Act 1974 is up to date with all changes known to be in force on or before 28 April 2021. There are changes that may be brought into force at a future date. Changes that have been made appear in the content and are referenced with annotations. (See end of Document for details) View outstanding changes*

Marginal Citations

M9 1978 c. 30.

47 Civil liability.

- (1) Nothing in this Part shall be construed—
- (a) as conferring a right of action in any civil proceedings in respect of any failure to comply with any duty imposed by sections 2 to 7 or any contravention of section 8; or
 - ^{F183}(b)
 - (c) as affecting the operation of section 12 of the ^{M10}Nuclear Installations Act 1965 (right to compensation by virtue of certain provisions of that Act).
- ^{F184}(2) Breach of a duty imposed by a statutory instrument containing (whether alone or with other provision) health and safety regulations shall not be actionable except to the extent that regulations under this section so provide.
- (2A) Breach of a duty imposed by an existing statutory provision shall not be actionable except to the extent that regulations under this section so provide (including by modifying any of the existing statutory provisions).
- (2B) Regulations under this section may include provision for—
- (a) a defence to be available in any action for breach of the duty mentioned in subsection (2) or (2A);
 - (b) any term of an agreement which purports to exclude or restrict any liability for such a breach to be void.]
- (3) No provision made by virtue of section 15(6)(b) shall afford a defence in any civil proceedings ^{F185}...
- (4) Subsections (1)(a) [^{F186}, (2) and (2A)] above are without prejudice to any right of action which exists apart from the provisions of this Act, and subsection [^{F187}(2B)(a)] above is without prejudice to any defence which may be available apart from the provisions of the regulations there mentioned.
- ^{F188}(5)
- ^{F188}(6)
- ^{F189}(7) The power to make regulations under this section shall be exercisable by the Secretary of State.]

Textual Amendments

- F183** S. 47(1)(b) omitted (25.4.2013 for specified purposes, 1.10.2013 for remaining purposes) by virtue of [Enterprise and Regulatory Reform Act 2013 \(c. 24\)](#), **ss. 69(2)**, 103(1)(i), (3) (with s. 69(8)-(10)); S.I. 2013/2227, art. 2(f)
- F184** S. 47(2)-(2B) substituted for s. 47(2) (25.4.2013 for specified purposes, 1.10.2013 for remaining purposes) by [Enterprise and Regulatory Reform Act 2013 \(c. 24\)](#), **ss. 69(3)**, 103(1)(i), (3), (3) (with s. 69(8)-(10)); S.I. 2013/2227, art. 2(f)
- F185** Words in s. 47(3) omitted (25.4.2013 for specified purposes, 1.10.2013 for remaining purposes) by virtue of [Enterprise and Regulatory Reform Act 2013 \(c. 24\)](#), **ss. 69(4)**, 103(1)(i), (3) (with s. 69(8)-(10)); S.I. 2013/2227, art. 2(f)

Changes to legislation: *Health and Safety at Work etc. Act 1974 is up to date with all changes known to be in force on or before 28 April 2021. There are changes that may be brought into force at a future date. Changes that have been made appear in the content and are referenced with annotations. (See end of Document for details) View outstanding changes*

- F186** Words in s. 47(4) substituted (25.4.2013 for specified purposes, 1.10.2013 for remaining purposes) by [Enterprise and Regulatory Reform Act 2013 \(c. 24\), ss. 69\(5\)\(a\), 103\(1\)\(i\), \(3\)](#) (with s. 69(8)-(10)); S.I. 2013/2227, art. 2(f)
- F187** Word in s. 47(4) substituted (25.4.2013 for specified purposes, 1.10.2013 for remaining purposes) by [Enterprise and Regulatory Reform Act 2013 \(c. 24\), ss. 69\(5\)\(b\), 103\(1\)\(i\), \(3\)](#) (with s. 69(8)-(10)); S.I. 2013/2227, art. 2(f)
- F188** S. 47(5)(6) omitted (25.4.2013 for specified purposes, 1.10.2013 for remaining purposes) by virtue of [Enterprise and Regulatory Reform Act 2013 \(c. 24\), ss. 69\(6\), 103\(1\)\(i\), \(3\)](#) (with s. 69(8)-(10)); S.I. 2013/2227, art. 2(f)
- F189** s. 47(7) inserted (25.4.2013 for specified purposes, 1.10.2013 for remaining purposes) by [Enterprise and Regulatory Reform Act 2013 \(c. 24\), ss. 69\(7\), 103\(1\)\(i\), \(3\), \(3\)](#) (with s. 69(8)-(10)); S.I. 2013/2227, art. 2(f)

Modifications etc. (not altering text)

- C36** Ss. 1-59 applied by S.I. 2001/2127 art. 8A 8B (as inserted (E.W.S.) (6.4.2011) by [The Health and Safety at Work etc. Act 1974 \(Application outside Great Britain\) \(Variation\) Order 2011 \(S.I. 2011/745\)](#), arts. 1(1), 3(2))
- C753** Ss. 1-25, 26, 27, 28, 30, 33, 34-59, 80, 81 and 82 applied by S.I. 1989/840, [arts. 2-10](#)
Ss. 16-24, 26, 28, 33-40, 42, 46, 47 excluded (with saving) (E.W.S.) (1.12.1997) by S.I. 1997/1840, [regs. 7, 9](#)
Ss. 16-26, 33-42, 47 applied (15.11.2000) by S.I. 2000/2831, [reg. 26\(1\)\(a\)](#)
- C754** Ss. 1-59, 80-82 applied (11.7.2001) by S.I. 2001/2127, [arts. 4\(1\), 5\(1\)\(2\), 6\(1\), 7\(1\), 8\(1\), 10](#) (with art. 11) (as amended by S.I. 2009/1750, [art. 2\(2\)\(4\)](#))
- C755** Ss. 1-59, 80-82 applied (temp.) (5.8.2009) by [The Health and Safety at Work etc. Act 1974 \(Application outside Great Britain\) Order 2001 \(S.I. 2001/2127\)](#), arts. 8A, 8B (as inserted by S.I. 2009/1750, [art. 2\(3\)](#))
- C756** S. 47(2) applied (E.W.S.) (24.7.2002) by S.I. 2002/1689, [reg. 14\(1\)\(c\)](#)

Marginal Citations

- M10** 1965 c. 57.

48 Application to Crown.

- (1) Subject to the provisions of this section, the provisions of this Part, except sections 21 to 25 and 33 to 42, and of regulations made under this Part shall bind the Crown.
- (2) Although they do not bind the Crown, sections 33 to 42 shall apply to persons in the public service of the Crown as they apply to other persons.
- (3) For the purposes of this Part and regulations made thereunder persons in the service of the Crown shall be treated as employees of the Crown whether or not they would be so treated apart from this subsection.
- (4) Without prejudice to section 15(5), the Secretary of State may, to the extent that it appears to him requisite or expedient to do so in the interests of the safety of the State or the safe custody of persons lawfully detained, by order exempt the Crown either generally or in particular respects from all or any of the provisions of this Part which would, by virtue of subsection (1) above, bind the Crown.
- (5) The power to make orders under this section shall be exercisable by statutory instrument, and any such order may be varied or revoked by a subsequent order.
- (6) Nothing in this section shall authorise proceedings to be brought against Her Majesty in her private capacity, and this subsection shall be construed as if section 38(3) of

Changes to legislation: Health and Safety at Work etc. Act 1974 is up to date with all changes known to be in force on or before 28 April 2021. There are changes that may be brought into force at a future date. Changes that have been made appear in the content and are referenced with annotations. (See end of Document for details) View outstanding changes

the ^{M11}Crown Proceedings Act 1947 (interpretation of references in that Act to Her Majesty in her private capacity) were contained in this Act.

Modifications etc. (not altering text)

- C36** Ss. 1–59 applied by S.I. 2001/2127 art. 8A 8B (as inserted (E.W.S.) (6.4.2011) by [The Health and Safety at Work etc. Act 1974 \(Application outside Great Britain\) \(Variation\) Order 2011 \(S.I. 2011/745\)](#), arts. 1(1), 3(2))
- C757** Ss. 1–25, 26, 27, 28, 30, 33, 34–59, 80, 81 and 82 applied by [S.I. 1989/840](#), arts. 2–10
 S. 48 extended (E.W.S.) (1.10.1996) by [S.I. 1996/1513](#), reg. 11
 S. 48 applied (with modifications) (E.W.S.) (1.10.1996) by [S.I. 1996/1513](#), reg. 11
- C758** Ss. 1–59, 80–82 applied (11.7.2001) by [S.I. 2001/2127](#), arts. 4(1), 5(1)(2), 6(1), 7(1), 8(1), 10 (with art. 11) (as amended by [S.I. 2009/1750](#), art. 2(2)(4))
- C759** Ss. 1–59, 80–82 applied (temp.) (5.8.2009) by [The Health and Safety at Work etc. Act 1974 \(Application outside Great Britain\) Order 2001 \(S.I. 2001/2127\)](#), arts. 8A, 8B (as inserted by [S.I. 2009/1750](#), art. 2(3))
- C760** S. 48(1) applied (with modifications) (E.W.S.) (3.5.2004) by [S.I. 2004/129](#), reg. 23(3)(f)
- C761** S. 48(1)–(3) applied (with modifications) (30.7.2018) by [The Cableway Installations Regulations 2018 \(S.I. 2018/816\)](#), regs. 1, 21(1)–(3) (with reg. 4)
- C762** S. 48(2) applied (with modifications) (E.W.S.) (3.5.2004) by [S.I. 2004/129](#), reg. 23(3)(f)
- C763** S. 48(3) applied (with modifications) (E.W.S.) (3.5.2004) by [S.I. 2004/129](#), reg. 23(3)(f)
- C764** S. 48(4) modified (E.W.) (25.09.1991) by [Atomic Weapons Establishment Act 1991 \(c. 46, SIF 8\)](#), ss. 3, 6, [Sch. para. 7\(1\)](#).

Marginal Citations

M11 1947 c. 44.

49 Adaptation of enactments to metric units or appropriate metric units.

- (1) [^{F190}Regulations made under this subsection may amend]—
- (a) any of the relevant statutory provisions; or
 - (b) any provision of an enactment which relates to any matter relevant to any of the general purposes of this Part but is not among the relevant statutory provisions; or
 - (c) any provision of an instrument made or having effect under any such enactment as is mentioned in the preceding paragraph,
- by substituting an amount or quantity expressed in metric units for an amount or quantity not so expressed or by substituting an amount or quantity expressed in metric units of a description specified in the regulations for an amount or quantity expressed in metric units of a different description.
- (2) The amendments shall be such as to preserve the effect of the provisions mentioned except to such extent as in the opinion of the [^{F190}authority making the regulations] is necessary to obtain amounts expressed in convenient and suitable terms.
- (3) Regulations made ^{F191}. . . under this subsection may, in the case of a provision which falls within any of paragraphs (a) to (c) of subsection (1) above and contains words which refer to units other than metric units, repeal those words [^{F190}if the authority making the regulations] is of the opinion that those words could be omitted without altering the effect of that provision.

Changes to legislation: *Health and Safety at Work etc. Act 1974 is up to date with all changes known to be in force on or before 28 April 2021. There are changes that may be brought into force at a future date. Changes that have been made appear in the content and are referenced with annotations. (See end of Document for details) View outstanding changes*

[^{F192}(4) The power to make regulations under this section shall be exercisable by the Secretary of State ^{F193} . . .].

Textual Amendments

F190 Words substituted by [Employment Protection Act 1975 \(c. 71\)](#), **Sch. 15 para. 15(1)**

F191 Words repealed by [Employment Protection Act 1975 \(c. 71\)](#), **Sch. 18**

F192 S. 49(4) substituted by [Employment Protection Act 1975 \(c. 71\)](#), **Sch. 15 para. 15(2)**

F193 Words in s. 49(4) repealed (27.3.2002) by S.I. 2002/794, art. 5(2), **Sch.** (with art. 6)

Modifications etc. (not altering text)

C36 Ss. 1-59 applied by S.I. 2001/2127 art. 8A 8B (as inserted (E.W.S.) (6.4.2011) by [The Health and Safety at Work etc. Act 1974 \(Application outside Great Britain\) \(Variation\) Order 2011 \(S.I. 2011/745\)](#), arts. 1(1), **3(2)**)

C765 Ss. 1–25, 26, 27, 28, 30, 33, 34–59, 80, 81 and 82 applied by S.I. 1989/840, **arts. 2–10**

C766 Ss. 1-59, 80-82 applied (11.7.2001) by S.I. 2001/2127, **arts. 4(1), 5(1)(2), 6(1), 7(1), 8(1), 10** (with art. 11) (as amended by S.I. 2009/1750, **art. 2(2)(4)**)

C767 Ss. 1-59, 80-82 applied (temp.) (5.8.2009) by [The Health and Safety at Work etc. Act 1974 \(Application outside Great Britain\) Order 2001 \(S.I. 2001/2127\)](#), arts. 8A, 8B (as inserted by S.I. 2009/1750, **art. 2(3)**)

50 Regulations under the relevant statutory provisions.

[^{F194}(1) Where any power to make regulations under any of the relevant statutory provisions is exercisable by the Secretary of State, that power may be exercised either—

- (a) so as to give effect (with or without modifications) to proposals submitted by the Executive under section 11(3); or
- (b) subject to subsection (1AA), independently of such proposals.

(1AA) The Secretary of State shall not exercise the power referred to in subsection (1) independently of proposals from the Executive unless [^{F195}the Secretary of State has consulted—]

- (a) the Executive,
- (b) the Office for Nuclear Regulation, and
- (c) such other bodies as appear to the Secretary of State to be appropriate.]

[^{F196}(1A) Subsection (1) does not apply to the exercise of a power to make regulations so far as it is exercised—

- (a) for giving effect (with or without modifications) to proposals submitted by the [^{F197}Office of Rail and Road] under paragraph 2(5) of Schedule 3 to the Railways Act 2005; or
- (b) otherwise for or in connection with the railway safety purposes.]

(2) Where the [^{F198}authority who is to exercise any such power as is mentioned in subsection (1) above proposes to exercise that power] so as to give effect to any such proposals as are there mentioned with modifications, he shall, before making the regulations, consult [^{F199}— .

- (a) the Executive, and
- (b) the Office for Nuclear Regulation.]

Changes to legislation: Health and Safety at Work etc. Act 1974 is up to date with all changes known to be in force on or before 28 April 2021. There are changes that may be brought into force at a future date. Changes that have been made appear in the content and are referenced with annotations. (See end of Document for details) View outstanding changes

- (3) Where [^{F200}the Executive] proposes to submit [^{F201}under section [^{F202}11(3)]] any such proposals as are mentioned in subsection (1) above except proposals for the making of regulations under section 43(2), it shall, before so submitting them, consult—
- [^{F203}(za) the Office for Nuclear Regulation;]
- (a) any government department or other body that appears to [^{F200}the Executive] to be appropriate (and, in particular, in the case of proposals for the making of regulations under section 18(2), any body representing local authorities that so appears^{F204} ...;
 - (b) such government departments and other bodies, if any, as, in relation to any matter dealt with in the proposals, [^{F200}the Executive] is required to consult under this subsection by virtue of directions given to it by the Secretary of State.
- [^{F205}(4) If the Executive has consulted the Office for Nuclear Regulation under subsection (3) in relation to a proposal under section 11(3) for regulations under any of the relevant statutory provisions, it must, when it submits the proposal (with or without modification) to the Secretary of State, also submit—
- (a) any representations made by the Office for Nuclear Regulation in response to the consultation, and
 - (b) any response to those representations given by the Executive to the Office for Nuclear Regulation.
- (5) The preceding provisions of this section do not apply to the exercise of the power in section 43 to make ONR fees regulations, but the Secretary of State must consult the Office for Nuclear Regulation before—
- (a) making ONR fees regulations independently of any proposals submitted by the Office for Nuclear Regulation under section 81(1) of the Energy Act 2013, or
 - (b) making ONR fees regulations which give effect to such proposals but with modifications.
- (6) In subsection (5) “ ONR fees regulations ” means regulations under section 43 so far as they make provision in relation to fees payable for or in connection with the performance of a function by or on behalf of—
- (a) the Office for Nuclear Regulation, or
 - (b) any inspector appointed by the Office for Nuclear Regulation.]

[^{F206}(4)

Textual Amendments

- F194** S. 50(1)(1AA) substituted (1.4.2008) for s. 50(1) by [The Legislative Reform \(Health and Safety Executive\) Order 2008 \(S.I. 2008/960\)](#), **art. 16(2)** (with art. 21, Sch. 2)
- F195** Words in s. 50(1AA) substituted (1.4.2014) by [Energy Act 2013 \(c. 32\)](#), s. 156(1), **Sch. 12 para. 11(2)**; [S.I. 2014/251](#), art. 4
- F196** S. 50(1A) inserted (E.W.S.) (1.4.2006) by [Railways Act 2005 \(c. 14\)](#), ss. 2, 60, **Sch. 3 para. 13**; [S.I. 2006/266](#), **art. 2(2)**, Sch.
- F197** Words in s. 50(1A)(a) substituted (16.10.2015) by [The Office of Rail Regulation \(Change of Name\) Regulations 2015 \(S.I. 2015/1682\)](#), reg. 1(2), **Sch. para. 4(c)(iv)**
- F198** Words substituted by [Employment Protection Act 1975 \(c. 71\)](#), **Sch. 15 para. 16(2)**
- F199** Words in s. 50(2) substituted (1.4.2014) by [Energy Act 2013 \(c. 32\)](#), s. 156(1), **Sch. 12 para. 11(3)**; [S.I. 2014/251](#), art. 4

Changes to legislation: *Health and Safety at Work etc. Act 1974 is up to date with all changes known to be in force on or before 28 April 2021. There are changes that may be brought into force at a future date. Changes that have been made appear in the content and are referenced with annotations. (See end of Document for details) View outstanding changes*

- F200** Words in s. 50(3) substituted (1.4.2008) by [The Legislative Reform \(Health and Safety Executive\) Order 2008 \(S.I. 2008/960\)](#), [art. 16\(4\)\(b\)](#) (with art. 21, Sch. 2)
- F201** Words substituted by [Employment Protection Act 1975 \(c. 71\)](#), [Sch. 15 para. 16\(3\)](#)
- F202** Words in s. 50(3) substituted (1.4.2008) by [The Legislative Reform \(Health and Safety Executive\) Order 2008 \(S.I. 2008/960\)](#), [art. 16\(4\)\(a\)](#) (with art. 21, Sch. 2)
- F203** S. 50(3)(za) inserted (1.4.2014) by [Energy Act 2013 \(c. 32\)](#), s. 156(1), [Sch. 12 para. 11\(4\)](#); S.I. 2014/251, art. 4
- F204** Words in s. 50(3)(a) omitted (1.4.2013) by virtue of [Health and Social Care Act 2012 \(c. 7\)](#), s. 306(4), [Sch. 7 para. 6](#); S.I. 2013/160, art. 2(2) (with arts. 7-9)
- F205** S. 50(4)-(6) inserted (1.4.2014) by [Energy Act 2013 \(c. 32\)](#), s. 156(1), [Sch. 12 para. 11\(5\)](#); S.I. 2014/251, art. 4
- F206** Ss. 2(5), 29, 31, 32, 50(4)(5), 53(2)–(6) repealed by [Employment Protection Act 1975 \(c. 71\)](#), [Sch. 18](#)

Modifications etc. (not altering text)

- C36** Ss. 1-59 applied by S.I. 2001/2127 art. 8A 8B (as inserted (E.W.S.) (6.4.2011) by [The Health and Safety at Work etc. Act 1974 \(Application outside Great Britain\) \(Variation\) Order 2011 \(S.I. 2011/745\)](#), arts. 1(1), [3\(2\)](#))
- C768** S. 50 applied by S.I. 1989/840, [arts. 2-10](#)
- C769** S. 50 applied (11.7.2001) by S.I. 2001/2127, [arts. 4\(1\)](#), 5(1)(2), 6(1), 7(1), 8(1), 10 (with art. 11) (as amended by S.I. 2009/1750, [art. 2\(2\)\(4\)](#))
- C770** Ss. 1-59, 80-82 applied (temp.) (5.8.2009) by [The Health and Safety at Work etc. Act 1974 \(Application outside Great Britain\) Order 2001 \(S.I. 2001/2127\)](#), arts. 8A, 8B (as inserted by S.I. 2009/1750, [art. 2\(3\)](#))

51 Exclusion of application to domestic employment.

Nothing in this Part shall apply in relation to a person by reason only that he employs another, or is himself employed, as a domestic servant in a private household.

Modifications etc. (not altering text)

- C36** Ss. 1-59 applied by S.I. 2001/2127 art. 8A 8B (as inserted (E.W.S.) (6.4.2011) by [The Health and Safety at Work etc. Act 1974 \(Application outside Great Britain\) \(Variation\) Order 2011 \(S.I. 2011/745\)](#), arts. 1(1), [3\(2\)](#))
- C771** Ss. 1–25, 26, 27, 28, 30, 33, 34–59, 80, 81 and 82 applied by S.I. 1989/840, [arts. 2–10](#)
- C772** Ss. 1-59, 80-82 applied (11.7.2001) by S.I. 2001/2127, [arts. 4\(1\)](#), 5(1)(2), 6(1), 7(1), 8(1), 10 (with art. 11) (as amended by S.I. 2009/1750, [art. 2\(2\)\(4\)](#))
- C773** Ss. 1-59, 80-82 applied (temp.) (5.8.2009) by [The Health and Safety at Work etc. Act 1974 \(Application outside Great Britain\) Order 2001 \(S.I. 2001/2127\)](#), arts. 8A, 8B (as inserted by S.I. 2009/1750, [art. 2\(3\)](#))

[^{F207}
51A

Application of Part to police. **E+W**

- (1) For the purposes of this Part, a person who, otherwise than under a contract of employment, holds the office of constable or an appointment as police cadet shall be treated as an employee of the relevant officer.
- (2) In this section “ the relevant officer ”—
- (a) in relation to a member of a police force or a special constable or police cadet appointed for a police area, [^{F208} means—
- (i) the chief officer of police of that force, or

Changes to legislation: *Health and Safety at Work etc. Act 1974 is up to date with all changes known to be in force on or before 28 April 2021. There are changes that may be brought into force at a future date. Changes that have been made appear in the content and are referenced with annotations. (See end of Document for details) View outstanding changes*

- (ii) in the case of a member of the force or a special constable who is, by virtue of a collaboration agreement under section 22A of the Police Act 1996, under the direction and control of a chief officer (within the meaning given by section 23I of that Act), that chief officer.]
- [^{F209}(b) in relation to a member of a police force seconded to the [^{F210} National Crime Agency to serve as a National Crime Agency officer], means that Agency, and]
- (c) in relation to any other person holding the office of constable or an appointment as police cadet, [^{F211} means—
- (i) the person who has the direction and control of the body of constables or cadets in question, or
- (ii) in the case of a constable who is, by virtue of a collaboration agreement under section 22A of the Police Act 1996, under the direction and control of a chief officer (within the meaning given by section 23I of that Act), that chief officer.]
- [For the purposes of this Part the relevant officer, as defined by subsection (2)(a) or (c) ^{F212}(2A) above, shall [^{F213} , if not a corporation sole,]be treated as a corporation sole.
- (2B) Where, in a case in which the relevant officer, as so defined, is guilty of an offence by virtue of this section, it is proved—
- (a) that the officer-holder personally consented to the commission of the offence,
- (b) that he personally connived in its commission, or
- (c) that the commission of the offence was attributable to personal neglect on his part,
- the office-holder (as well as the corporation sole) shall be guilty of the offence and shall be liable to be proceeded against and punished accordingly.
- (2C) In subsection (2B) above “ the office-holder ”, in relation to the relevant officer, means an individual who, at the time of the consent, connivance or neglect—
- (a) held the office or other position mentioned in subsection (2) above as the office or position of that officer; or
- (b) was for the time being responsible for exercising and performing the powers and duties of that office or position.
- (2D) The provisions mentioned in subsection (2E) below (which impose the same liability for unlawful conduct of constables on persons having their direction or control as would arise if the constables were employees of those persons) do not apply to any liability by virtue of this Part.
- (2E) Those provisions are—
- [^{F214}(a) section 24 of the Police and Fire Reform (Scotland) Act 2012 (asp 8) ;]
- (b) section 88(1) of the Police Act 1996;
- (c) ^{F215}
- (d) ^{F215}
- (e) paragraph 14(1) of Schedule 3 to the Criminal Justice and Police Act 2001;
- [^{F216}(f) paragraph 2 of Schedule 4 to the Crime and Courts Act 2013;]
- [^{F217}(g) paragraph 20 of Schedule 1 to the Police and Justice Act 2006;]

Changes to legislation: *Health and Safety at Work etc. Act 1974 is up to date with all changes known to be in force on or before 28 April 2021. There are changes that may be brought into force at a future date. Changes that have been made appear in the content and are referenced with annotations. (See end of Document for details) View outstanding changes*

- (2F) In the application of this section to Scotland—
- (a) subsection (2A) shall have effect as if for the words “corporation sole” there were substituted distinct juristic person (that is to say, as a juristic person distinct from the individual who for the time being is the office-holder);
 - (b) subsection (2B) shall have effect as if for the words “corporation sole” there were substituted juristic person; and
 - (c) subsection (2C) shall have effect as if for the words “subsection (2B)” there were substituted subsections (2A) and (2B).]
- (3) For the purposes of regulations under section 2(4) above—
- (a) the Police Federation for England and Wales shall be treated as a recognised trade union recognised by each chief officer of police in England and Wales,
 - (b) the Police Federation for Scotland shall be treated as a recognised trade union recognised by [^{F218}the chief constable of the Police Service of Scotland], and
 - (c) any body recognised by the Secretary of State for the purposes of section 64 of the Police Act 1996 shall be treated as a recognised trade union recognised by each chief officer of police in England, Wales and Scotland.
- (4) Regulations under section 2(4) above may provide, in relation to persons falling within subsection (2)(b) or (c) above, that a body specified in the regulations is to be treated as a recognised trade union recognised by such person as may be specified.]

Extent Information

- E8** This version of this provision extends to England and Wales only; a separate version has been created for Scotland only

Textual Amendments

- F207** S. 51A inserted (E.W.S.) (1.7.1998) by 1997 c. 42, s. 1; S.I. 1998/1542, art. 2
- F208** Words in s. 51A(2)(a) substituted (16.1.2012) by Police Reform and Social Responsibility Act 2011 (c. 13), s. 157(1), Sch. 16 para. 119(2)(a); S.I. 2011/3019, art. 3, Sch. 1
- F209** S. 51A(2)(b) substituted (E.W.) (1.4.2006) by Serious Organised Crime and Police Act 2005 (c.15), ss. 59, 178, Sch. 4 para. 20; S.I. 2006/378, art. 4, Sch. para. 10
- F210** Words in s. 51A(2)(b) substituted (7.10.2013) by Crime and Courts Act 2013 (c. 22), s. 61(2), Sch. 8 para. 21(2); S.I. 2013/1682, art. 3(v)
- F211** Words in s. 51A(2)(c) substituted (16.1.2012) by Police Reform and Social Responsibility Act 2011 (c. 13), s. 157(1), Sch. 16 para. 119(2)(b); S.I. 2011/3019, art. 3, Sch. 1
- F212** S. 51A(2A)-(2F) inserted (7.4.2005) by Serious Organised Crime and Police Act 2005 (c. 15), s. 158(1)(5)-(7)
- F213** Words in s. 51A(2A) inserted (16.1.2012) by Police Reform and Social Responsibility Act 2011 (c. 13), s. 157(1), Sch. 16 para. 119(3); S.I. 2011/3019, art. 3, Sch. 1
- F214** S. 51A(2E)(a) substituted (1.4.2013) by The Police and Fire Reform (Scotland) Act 2012 (Consequential Provisions and Modifications) Order 2013 (S.I. 2013/602), art. 1(2), Sch. 1 para. 2(a)
- F215** S. 51A(2E)(c)(d) repealed (1.4.2007) by Police and Justice Act 2006 (c. 48), ss. 52, 53(1), Sch. 15 Pt. 1(A); S.I. 2007/709, art. 3(o)(q) (subject to art. 6)
- F216** S. 51A(2E)(f) substituted (7.10.2013) by Crime and Courts Act 2013 (c. 22), s. 61(2), Sch. 8 para. 21(3); S.I. 2013/1682, art. 3(v)
- F217** S. 51A(2E)(g) inserted (1.4.2007.) by Police and Justice Act 2006 (c. 48), ss. 1, 53(1), Sch. 1 para. 54; S.I. 2007/709, art. 3(a) (subject to art. 6)
- F218** Words in s. 51A(3)(b) substituted (1.4.2013) by The Police and Fire Reform (Scotland) Act 2012 (Consequential Provisions and Modifications) Order 2013 (S.I. 2013/602), art. 1(2), Sch. 1 para. 2(b)

Changes to legislation: *Health and Safety at Work etc. Act 1974 is up to date with all changes known to be in force on or before 28 April 2021. There are changes that may be brought into force at a future date. Changes that have been made appear in the content and are referenced with annotations. (See end of Document for details) View outstanding changes*

Modifications etc. (not altering text)

- C36** Ss. 1-59 applied by S.I. 2001/2127 art. 8A 8B (as inserted (E.W.S.) (6.4.2011) by [The Health and Safety at Work etc. Act 1974 \(Application outside Great Britain\) \(Variation\) Order 2011 \(S.I. 2011/745\)](#), arts. 1(1), 3(2))
- C774** S. 51A applied (14.4.1999) by [S.I. 1999/860](#), [art. 2](#)
- C775** Ss. 1-59, 80-82 applied (11.7.2001) by [S.I. 2001/2127](#), [arts. 4\(1\)](#), 5(1)(2), 6(1), 7(1), 8(1), 10 (with [art. 11](#)) (as amended by [S.I. 2009/1750](#), [art. 2\(2\)\(4\)](#))
- C776** Ss. 1-59, 80-82 applied (temp.) (5.8.2009) by [The Health and Safety at Work etc. Act 1974 \(Application outside Great Britain\) Order 2001 \(S.I. 2001/2127\)](#), arts. 8A, 8B (as inserted by [S.I. 2009/1750](#), [art. 2\(3\)](#))

[^{F207}
51A

Application of Part to police. S

- (1) For the purposes of this Part, a person who, otherwise than under a contract of employment, holds the office of constable or an appointment as police cadet shall be treated as an employee of the relevant officer.
- (2) In this section “ the relevant officer ”—
- (a) in relation to a member of a police force or a special constable or police cadet appointed for a police area, means the chief officer of police,
 - (b) in relation to a person holding office under section 9(1)(b) or 55(1)(b) of the Police Act 1997 (police members of the National Criminal Intelligence Service and the National Crime Squad) means the Director General of the National Criminal Intelligence Service or, as the case may be, the Director General of the National Crime Squad, and
 - (c) in relation to any other person holding the office of constable or an appointment as police cadet, means the person who has the direction and control of the body of constables or cadets in question.

[For the purposes of this Part the relevant officer, as defined by subsection (2)(a) or (c) ^{F212}(2A) above, shall be treated as a corporation sole.

- (2B) Where, in a case in which the relevant officer, as so defined, is guilty of an offence by virtue of this section, it is proved—
- (a) that the officer-holder personally consented to the commission of the offence,
 - (b) that he personally connived in its commission, or
 - (c) that the commission of the offence was attributable to personal neglect on his part,
- the office-holder (as well as the corporation sole) shall be guilty of the offence and shall be liable to be proceeded against and punished accordingly.
- (2C) In subsection (2B) above “ the office-holder ”, in relation to the relevant officer, means an individual who, at the time of the consent, connivance or neglect—
- (a) held the office or other position mentioned in subsection (2) above as the office or position of that officer; or
 - (b) was for the time being responsible for exercising and performing the powers and duties of that office or position.

- (2D) The provisions mentioned in subsection (2E) below (which impose the same liability for unlawful conduct of constables on persons having their direction or control as would arise if the constables were employees of those persons) do not apply to any liability by virtue of this Part.

Changes to legislation: *Health and Safety at Work etc. Act 1974 is up to date with all changes known to be in force on or before 28 April 2021. There are changes that may be brought into force at a future date. Changes that have been made appear in the content and are referenced with annotations. (See end of Document for details) View outstanding changes*

(2E) Those provisions are—

- (a) section 39 of the Police (Scotland) Act 1967;
- (b) section 88(1) of the Police Act 1996;
- (c) ^{F356}
- (d) ^{F356}
- (e) paragraph 14(1) of Schedule 3 to the Criminal Justice and Police Act 2001;
- [^{F216}(f) paragraph 2 of Schedule 4 to the Crime and Courts Act 2013;]
- [^{F217}(g) paragraph 20 of Schedule 1 to the Police and Justice Act 2006;]

(2F) In the application of this section to Scotland—

- (a) subsection (2A) shall have effect as if for the words “corporation sole” there were substituted distinct juristic person (that is to say, as a juristic person distinct from the individual who for the time being is the office-holder);
- (b) subsection (2B) shall have effect as if for the words “corporation sole” there were substituted juristic person; and
- (c) subsection (2C) shall have effect as if for the words “subsection (2B)” there were substituted subsections (2A) and (2B).]

(3) For the purposes of regulations under section 2(4) above—

- (a) the Police Federation for England and Wales shall be treated as a recognised trade union recognised by each chief officer of police in England and Wales,
- (b) the Police Federation for Scotland shall be treated as a recognised trade union recognised by each chief officer of police in Scotland, and
- (c) any body recognised by the Secretary of State for the purposes of section 64 of the Police Act 1996 shall be treated as a recognised trade union recognised by each chief officer of police in England, Wales and Scotland.

(4) Regulations under section 2(4) above may provide, in relation to persons falling within subsection (2)(b) or (c) above, that a body specified in the regulations is to be treated as a recognised trade union recognised by such person as may be specified.]

Extent Information

E17 This version of this provision extends to Scotland only; a separate version has been created for England and Wales only

Textual Amendments

F207 S. 51A inserted (E.W.S.) (1.7.1998) by 1997 c. 42, s. 1; S.I. 1998/1542, art. 2

F212 S. 51A(2A)-(2F) inserted (7.4.2005) by Serious Organised Crime and Police Act 2005 (c. 15), s. 158(1)(5)-(7)

F216 S. 51A(2E)(f) substituted (7.10.2013) by Crime and Courts Act 2013 (c. 22), s. 61(2), Sch. 8 para. 21(3); S.I. 2013/1682, art. 3(v)

F217 S. 51A(2E)(g) inserted (1.4.2007.) by Police and Justice Act 2006 (c. 48), ss. 1, 53(1), Sch. 1 para. 54; S.I. 2007/709, art. 3(a) (subject to art. 6)

F356 S. 51A(2E)(c)(d) repealed (1.4.2007) by Police and Justice Act 2006 (c. 48), ss. 52, 53(1), Sch. 15 Pt. 1(A); S.I. 2007/709, art. 3(o)(q) (subject to art. 6)

Changes to legislation: *Health and Safety at Work etc. Act 1974 is up to date with all changes known to be in force on or before 28 April 2021. There are changes that may be brought into force at a future date. Changes that have been made appear in the content and are referenced with annotations. (See end of Document for details) View outstanding changes*

Modifications etc. (not altering text)

- C36** Ss. 1-59 applied by S.I. 2001/2127 art. 8A 8B (as inserted (E.W.S.) (6.4.2011) by [The Health and Safety at Work etc. Act 1974 \(Application outside Great Britain\) \(Variation\) Order 2011 \(S.I. 2011/745\)](#), arts. 1(1), **3(2)**)
- C774** S. 51A applied (14.4.1999) by [S.I. 1999/860](#), **art. 2**
- C775** Ss. 1-59, 80-82 applied (11.7.2001) by [S.I. 2001/2127](#), **arts. 4(1)**, 5(1)(2), 6(1), 7(1), 8(1), 10 (with art. 11) (as amended by [S.I. 2009/1750](#), **art. 2(2)(4)**)
- C776** Ss. 1-59, 80-82 applied (temp.) (5.8.2009) by [The Health and Safety at Work etc. Act 1974 \(Application outside Great Britain\) Order 2001 \(S.I. 2001/2127\)](#), arts. 8A, 8B (as inserted by [S.I. 2009/1750](#), **art. 2(3)**)

52 Meaning of work and at work.

(1) For the purposes of this Part—

- (a) “work” means work as an employee or as a self-employed person;
- (b) an employee is at work throughout the time when he is in the course of his employment, but not otherwise;
- ^[F219](bb) a person holding the office of constable is at work throughout the time when he is on duty, but not otherwise; and]
- (c) a self-employed person is at work throughout such time as he devotes to work as a self-employed person;

and, subject to the following subsection, the expressions “work” and “at work”, in whatever context, shall be construed accordingly.

(2) Regulations made under this subsection may—

- (a) extend the meaning of “work” and “at work” for the purposes of this Part; and
- (b) in that connection provide for any of the relevant statutory provisions to have effect subject to such adaptations as may be specified in the regulations.

^[F220](3) The power to make regulations under subsection (2) above shall be exercisable by the Secretary of State ^{F221} . . .]

Textual Amendments

- F219** S. 52(1)(bb) substituted for word in s. 52(1)(b) (E.W.S.) (1.7.1998) by [1997 c. 42, s. 2](#); [S.I. 1998/1542](#), **art. 2**
- F220** S. 52(3) substituted for s. 52(3)(4) by [Employment Protection Act 1975 \(c. 71\)](#), **Sch. 15 para. 17**
- F221** Words in s. 52(3) repealed (27.3.2002) by [S.I. 2002/794](#), **art. 5(2)**, **Sch.** (with art. 6)

Modifications etc. (not altering text)

- C36** Ss. 1-59 applied by S.I. 2001/2127 art. 8A 8B (as inserted (E.W.S.) (6.4.2011) by [The Health and Safety at Work etc. Act 1974 \(Application outside Great Britain\) \(Variation\) Order 2011 \(S.I. 2011/745\)](#), arts. 1(1), **3(2)**)
- C777** Ss. 1–25, 26, 27, 28, 30, 33, 34–59, 80, 81 and 82 applied by [S.I. 1989/840](#), **arts. 2–10**
- C778** Ss. 1-59, 80-82 applied (11.7.2001) by [S.I. 2001/2127](#), **arts. 4(1)**, 5(1)(2), 6(1), 7(1), 8(1), 10 (with art. 11) (as amended by [S.I. 2009/1750](#), **art. 2(2)(4)**)
- C779** S. 52 applied (E.W.S.) (1.4.2006) by [Railways Act 2005 \(c. 14\)](#), ss. 2, 60, {Sch. 3 para. 11(10)}; [S.I. 2006/266](#), **art. 2(2)**, **Sch.**
- C780** Ss. 1-59, 80-82 applied (temp.) (5.8.2009) by [The Health and Safety at Work etc. Act 1974 \(Application outside Great Britain\) Order 2001 \(S.I. 2001/2127\)](#), arts. 8A, 8B (as inserted by [S.I. 2009/1750](#), **art. 2(3)**)

Changes to legislation: *Health and Safety at Work etc. Act 1974 is up to date with all changes known to be in force on or before 28 April 2021. There are changes that may be brought into force at a future date. Changes that have been made appear in the content and are referenced with annotations. (See end of Document for details) View outstanding changes*

C781 S. 52(1) applied (1.4.2014) by [Energy Act 2013 \(c. 32\)](#), **ss. 112(2)(a)**, 156(1) (with [ss. 107, 111](#)); [S.I. 2014/251](#), art. 4

C782 S. 52(2)(a) applied (1.4.2014) by [Energy Act 2013 \(c. 32\)](#), **ss. 112(2)(b)**, 156(1) (with [ss. 107, 111](#)); [S.I. 2014/251](#), art. 4

53 General interpretation of Part I.

(1) In this Part, unless the context otherwise requires—

^{F222}

“article for use at work” means—

(a) any plant designed for use or operation (whether exclusively or not) by persons at work, and

(b) any article designed for use as a component in any such plant;

[^{F223} “article of fairground equipment” means any fairground equipment or any article designed for use as a component in any such equipment;]

“code of practice” (without prejudice to section 16(8)) includes a standard, a specification and any other documentary form of practical guidance;

^{F224}

“conditional sale agreement” means an agreement for the sale of goods under which the purchase price or part of it is payable by instalments, and the property in the goods is to remain in the seller (notwithstanding that the buyer is to be in possession of the goods) until such conditions as to the payment of instalments or otherwise as may be specified in the agreement are fulfilled;

“contract of employment” means a contract of employment or apprenticeship (whether express or implied and, if express, whether oral or in writing);

“credit-sale agreement” means an agreement for the sale of goods, under which the purchase price or part of it is payable by instalments, but which is not a conditional sale agreement;

[^{F225} “customs officer” means an officer within the meaning of the Customs and Excise Management Act ^{M12} 1979;]

“domestic premises” means premises occupied as a private dwelling (including any garden, yard, garage, outhouse or other appurtenance of such premises which is not used in common by the occupants of more than one such dwelling), and

“non-domestic premises” shall be construed accordingly;

“employee” means an individual who works under a contract of employment [^{F226} or is treated by section 51A as being an employee], and related expressions shall be construed accordingly;

“enforcing authority” has the meaning assigned by section 18(7);

“the Executive” has the meaning assigned by section [^{F227} 10(1)];

“the existing statutory provisions” means the following provisions while and to the extent that they remain in force, namely the provisions of the Acts mentioned in Schedule 1 which are specified in the third column of that Schedule and of the regulations, orders or other instruments of a legislative character made or having effect under any provision so specified;

^{F228}

[^{F229} “fairground equipment” means any fairground ride, any similar plant which is designed to be in motion for entertainment purposes with members of the public on or inside it or any plant which is designed to be used by members of the public for entertainment purposes either as a slide or for bouncing upon, and

Changes to legislation: *Health and Safety at Work etc. Act 1974 is up to date with all changes known to be in force on or before 28 April 2021. There are changes that may be brought into force at a future date. Changes that have been made appear in the content and are referenced with annotations. (See end of Document for details) View outstanding changes*

in this definition the reference to plant which is designed to be in motion with members of the public on or inside it includes a reference to swings, dodgems and other plant which is designed to be in motion wholly or partly under the control of, or to be put in motion by, a member of the public;]

“the general purposes of this Part” has the meaning assigned by section 1;

“health and safety regulations” has the meaning assigned by section 15(1);

“hire-purchase agreement” means an agreement other than a conditional sale agreement, under which—

- (a) goods are bailed or (in Scotland) hired in return for periodical payments by the person to whom they are bailed or hired; and
- (b) the property in the goods will pass to that person if the terms of the agreement are complied with and one or more of the following occurs:
 - (i) the exercise of an option to purchase by that person;
 - (ii) the doing of any other specified act by any party to the agreement;
 - (iii) the happening of any other event;

and “hire-purchase” shall be construed accordingly;

“improvement notice” means a notice under section 21;

“inspector” means an inspector appointed under section 19;

^{F228}

“local authority” means—

- (a) in relation to England ^{F230} . . . , a county council, ^{F231} . . . a district council, a London borough council, the Common Council of the City of London, the Sub-Treasurer of the Inner Temple or the Under-Treasurer of the Middle Temple,
- (aa) [^{F232} in relation to Wales, a county council or a county borough council,]
- (b) in relation to Scotland, a [^{F233} council constituted under section 2 of the Local Government etc. (Scotland) Act 1994];

[^{F234} “ micro-organism ” includes any microscopic biological entity which is capable of replication;]

[^{F235} “nuclear safeguards purposes” has the same meaning as in Part 3 of the Energy Act 2013 (nuclear regulation etc.) (see section 72 of that Act);

“nuclear safety purposes” has the same meaning as in that Part of that Act (see section 68 of that Act);

“nuclear security purposes” has the same meaning as in that Part of that Act (see section 70 of that Act);]

“offshore installation” means any installation which is intended for underwater exploitation of mineral resources or exploration with a view to such exploitation;

[^{F236} “the ONR's purposes” has the same meaning as in Part 3 of the Energy Act 2013 (see section 67 of that Act);]

“personal injury” includes any disease and any impairment of a person’s physical or mental condition;

“plant” includes any machinery, equipment or appliance;

“premises” includes any place and, in particular, includes—

- (a) any vehicle, vessel, aircraft or hovercraft,
- (b) any installation on land (including the foreshore and other land intermittently covered by water), any offshore installation, and any other installation (whether floating, or resting on the seabed or the subsoil

Changes to legislation: *Health and Safety at Work etc. Act 1974 is up to date with all changes known to be in force on or before 28 April 2021. There are changes that may be brought into force at a future date. Changes that have been made appear in the content and are referenced with annotations. (See end of Document for details) View outstanding changes*

thereof, or resting on other land covered with water or the subsoil thereof), and

(c) any tent or moveable structure;

“prescribed” means prescribed by regulations made by the Secretary of State;

“prohibition notice” means a notice under section 22;

[^{F237}“the radioactive material transport purposes” means the transport purposes within the meaning of Part 3 of the Energy Act 2013 (see section 73 of that Act);]

^{F228}

[^{F238} “ railway safety purposes ” has the same meaning as in Schedule 3 to the Railways Act 2005;]

“the relevant statutory provisions” means—

(a) the provisions of this Part and of any health and safety regulations ^{F239} . . . ;
and

(b) the existing statutory provisions;

“self-employed person” means an individual who works for gain or reward otherwise than under a contract of employment, whether or not he himself employs others;

“substance” means any natural or artificial substance [^{F240}(including micro-organisms)], whether in solid or liquid form or in the form of a gas or vapour;

^{F241}

“supply”, where the reference is to supplying articles or substances, means supplying them by way of sale, lease, hire or hire-purchase, whether as principal or agent for another.

^{F242}(2)

Textual Amendments

F222 Definitions repealed by [Employment Protection Act 1975 \(c. 71\)](#), **Sch. 18**

F223 Definition inserted by [Consumer Protection Act 1987 \(c. 43, SIF 109:1\)](#), s. 36, **Sch. 3 para. 7(a)**

F224 S. 53(1): definition of “the Commission” omitted (1.4.2008) by virtue of [The Legislative Reform \(Health and Safety Executive\) Order 2008 \(S.I. 2008/960\)](#), **art. 17(a)** (with art. 21, Sch. 2)

F225 Definition inserted by [Consumer Protection Act 1987 \(c. 43, SIF 109:1\)](#), s. 36, **Sch. 3 para. 7(b)**

F226 S. 53(1): words in definition of “employee” inserted (E.W.S.) (1.7.1998) by 1997 c. 42, s. 6(1); S.I. 1998/1542, **art. 2**

F227 S. 53(1): word in definition of “the Executive” substituted (1.4.2008) by [The Legislative Reform \(Health and Safety Executive\) Order 2008 \(S.I. 2008/960\)](#), **art. 17(b)** (with art. 21, Sch. 2)

F228 Definition repealed by [Employment Protection Act 1975 \(c. 71\)](#), **Sch. 18**

F229 Definition inserted by [Consumer Protection Act 1987 \(c. 43, SIF 109:1\)](#), s. 36, **Sch. 3 para. 7(c)**

F230 S. 53(1): words in definition of “local authority” repealed (1.4.1996) by 1994 c. 19, s. 22(3), **Sch. 1 para. 9, Sch. 18** (with ss. 54(5)(7), 55(5), Sch. 17 paras. 22(1), 23(2)); S.I. 1996/396, art. 3, **Sch. 1**

F231 Words repealed by [Local Government Act 1985 \(c. 51, SIF 81:1\)](#), s. 102, **Sch. 17**

F232 S. 53(1): in definition of “local authority” para. (aa) inserted (1.4.1996) by 1994 c. 19, s. 22(3), **Sch. 9 para. 9** (with ss. 54(5)(7), 55(5), Sch. 17 paras. 22(1), 23(2)); S.I. 1996/396, art. 3, **Sch. 1**

F233 S. 53(1): words in definition of “local authority” substituted (S.) (1.4.1996) by 1994 c. 39, s. 180(1), **Sch. 13 para. 93(3)**; S.I. 1996/323, **art. 4(1)(b)(c)**

F234 Definition inserted by [Consumer Protection Act 1987 \(c. 43, SIF 109:1\)](#), s. 36, **Sch. 3 para. 7(d)**

F235 Words in s. 53(1) inserted (1.4.2014) by [Energy Act 2013 \(c. 32\)](#), s. 156(1), **Sch. 12 para. 12(a)**; S.I. 2014/251, art. 4

F236 Words in s. 53(1) inserted (1.4.2014) by [Energy Act 2013 \(c. 32\)](#), s. 156(1), **Sch. 12 para. 12(b)**; S.I. 2014/251, art. 4

Changes to legislation: *Health and Safety at Work etc. Act 1974 is up to date with all changes known to be in force on or before 28 April 2021. There are changes that may be brought into force at a future date. Changes that have been made appear in the content and are referenced with annotations. (See end of Document for details) View outstanding changes*

- F237** Words in s. 53(1) inserted (1.4.2014) by [Energy Act 2013 \(c. 32\)](#), s. 156(1), **Sch. 12 para. 12(c)**; S.I. 2014/251, art. 4
- F238** S. 53(1): definition of "railway safety purposes" inserted (E.W.S) (1.4.2006) by [Railways Act 2005 \(c. 14\)](#), ss. 2, 60, **Sch. 3 para. 15(3)**; S.I. 2006/266, **art. 2(2)**, Sch.
- F239** Words repealed by [Employment Protection Act 1975 \(c. 71\)](#), **Sch. 18**
- F240** Words inserted by [Consumer Protection Act 1987 \(c. 43, SIF 109:1\)](#), s. 36, **Sch. 3 para. 7(e)**
- F241** Definition repealed by [Consumer Protection Act 1987 \(c. 43, SIF 109:1\)](#), s. 48(3), **Sch. 5**
- F242** Ss. 2(5), 29, 31, 32, 50(4)(5), 53(2)–(6) repealed by [Employment Protection Act 1975 \(c. 71\)](#), **Sch. 18**

Modifications etc. (not altering text)

- C36** Ss. 1-59 applied by S.I. 2001/2127 art. 8A 8B (as inserted (E.W.S.) (6.4.2011) by [The Health and Safety at Work etc. Act 1974 \(Application outside Great Britain\) \(Variation\) Order 2011 \(S.I. 2011/745\)](#), arts. 1(1), **3(2)**)
- C783** Ss. 1–25, 26, 27, 28, 30, 33, 34–59, 80, 81 and 82 applied by S.I. 1989/840, **arts. 2–10**
- C784** Ss. 1-59, 80-82 applied (11.7.2001) by S.I. 2001/2127, **arts. 4(1), 5(1)(2), 6(1), 7(1), 8(1), 10** (with art. 11) (as amended by S.I. 2009/1750, **art. 2(2)(4)**)
- C785** Ss. 1-59, 80-82 applied (temp.) (5.8.2009) by [The Health and Safety at Work etc. Act 1974 \(Application outside Great Britain\) Order 2001 \(S.I. 2001/2127\)](#), arts. 8A, 8B (as inserted by S.I. 2009/1750, **art. 2(3)**)
- C786** In s. 53: definition of "relevant statutory provisions" applied by [Tay Road Bridge Order Confirmation Act 1991 \(c. iv\)](#), s. 1, **Sch. Pt. VII s. 62**
 In s. 53: definition of "relevant statutory provisions" applied (25.7.1991) by [Highland Regional Council \(Harbours\) Order Confirmation Act 1991 \(c. xii\)](#), s. 1, **Sch. s. 61(1)(f)**

Marginal Citations

- M12** 1979 c.2(40:1).

54 Application of Part I to Isles of Scilly.

This Part, in its application to the Isles of Scilly, shall apply as if those Isles were a local government area and the Council of those Isles were a local authority.

Modifications etc. (not altering text)

- C36** Ss. 1-59 applied by S.I. 2001/2127 art. 8A 8B (as inserted (E.W.S.) (6.4.2011) by [The Health and Safety at Work etc. Act 1974 \(Application outside Great Britain\) \(Variation\) Order 2011 \(S.I. 2011/745\)](#), arts. 1(1), **3(2)**)
- C787** Ss. 1–25, 26, 27, 28, 30, 33, 34–59, 80, 81 and 82 applied by S.I. 1989/840, **arts. 2–10**
- C788** Ss. 1-59, 80-82 applied (11.7.2001) by S.I. 2001/2127, **arts. 4(1), 5(1)(2), 6(1), 7(1), 8(1), 10** (with art. 11) (as amended by S.I. 2009/1750, **art. 2(2)(4)**)
- C789** Ss. 1-59, 80-82 applied (temp.) (5.8.2009) by [The Health and Safety at Work etc. Act 1974 \(Application outside Great Britain\) Order 2001 \(S.I. 2001/2127\)](#), arts. 8A, 8B (as inserted by S.I. 2009/1750, **art. 2(3)**)

Changes to legislation: Health and Safety at Work etc. Act 1974 is up to date with all changes known to be in force on or before 28 April 2021. There are changes that may be brought into force at a future date. Changes that have been made appear in the content and are referenced with annotations. (See end of Document for details) View outstanding changes

PART II

THE EMPLOYMENT MEDICAL ADVISORY SERVICE

55 Functions of, and responsibility for maintaining, employment medical advisory service.

- (1) There shall continue to be an employment medical advisory service, which shall be maintained for the following purposes, that is to say—
 - (a) securing that the Secretary of State, [^{F243}the Health and Safety Executive] , ^{F244} . . . and others concerned with the health of employed persons or of persons seeking or training for employment can be kept informed of, and adequately advised on, matters of which they ought respectively to take cognisance concerning the safeguarding and improvement of the health of those persons;
 - (b) giving to employed persons and persons seeking or training for employment information and advice on health in relation to employment and training for employment;
 - (c) other purposes of the Secretary of State's functions relating to employment.
- (2) The authority responsible for maintaining the said service shall be the Secretary of State; but if arrangements are made by the Secretary of State for that responsibility to be discharged on his behalf by [^{F245}the Health and Safety Executive] or some other body, then, while those arrangements operate, the body so discharging that responsibility (and not the Secretary of State) shall be the authority responsible for maintaining that service.
- (3) The authority for the time being responsible for maintaining the said service may also for the purposes mentioned in subsection (1) above, and for the purpose of assisting employment medical advisers in the performance of their functions, investigate or assist in, arrange for or make payments in respect of the investigation of problems arising in connection with any such matters as are so mentioned or otherwise in connection with the functions of employment medical advisers, and for the purpose of investigating or assisting in the investigation of such problems may provide and maintain such laboratories and other services as appear to the authority to be requisite.
- (4) Any arrangements made by the Secretary of State in pursuance of subsection (2) above may be terminated by him at any time, but without prejudice to the making of other arrangements at any time in pursuance of that subsection (including arrangements which are to operate from the time when any previous arrangements so made cease to operate).
- ^{F246}(5) Without prejudice to section 12, it shall be the duty of the Health and Safety Executive, if so directed by the Secretary of State, to enter into arrangements with him for the Executive to be responsible for maintaining the said service.]
- (6) In subsection (1) above—
 - (a) the reference to persons training for employment shall include persons attending industrial rehabilitation courses provided by virtue of the ^{M13}Employment and Training Act 1973; and
 - (b) the reference to persons (other than the Secretary of State and the [^{F247}the Health and Safety Executive]) concerned with the health of employed persons or of persons seeking or training for employment shall be taken to include

Changes to legislation: Health and Safety at Work etc. Act 1974 is up to date with all changes known to be in force on or before 28 April 2021. There are changes that may be brought into force at a future date. Changes that have been made appear in the content and are referenced with annotations. (See end of Document for details) View outstanding changes

organisations representing employers, employees and occupational health practitioners respectively.

Textual Amendments

- F243** Words in s. 55(1) substituted (1.4.2008) by [The Legislative Reform \(Health and Safety Executive\) Order 2008 \(S.I. 2008/960\)](#), [art. 18\(2\)](#) (with art. 21, Sch. 2)
- F244** Words repealed by virtue of [Employment Act 1988 \(c. 19, SIF 43:5\)](#), s. 33(1), [Sch. 3 Pt. II para. 7\(a\)](#) and [Employment Act 1989 \(c. 38, SIF 43:1\)](#), s. 29(3)(4), Sch. 6 para. 11(2), [Sch. 7 Pt. I](#)
- F245** Words in s. 55(2) substituted (1.4.2008) by [The Legislative Reform \(Health and Safety Executive\) Order 2008 \(S.I. 2008/960\)](#), [art. 18\(2\)](#) (with art. 21, Sch. 2)
- F246** S. 55(5) substituted (1.4.2008) by [The Legislative Reform \(Health and Safety Executive\) Order 2008 \(S.I. 2008/960\)](#), [art. 18\(3\)](#) (with art. 21, Sch. 2)
- F247** Words in s. 55(6)(b) substituted (1.4.2008) by [The Legislative Reform \(Health and Safety Executive\) Order 2008 \(S.I. 2008/960\)](#), [art. 18\(3\)](#) (with art. 21, Sch. 2)

Modifications etc. (not altering text)

- C36** Ss. 1-59 applied by S.I. 2001/2127 art. 8A 8B (as inserted (E.W.S.) (6.4.2011) by [The Health and Safety at Work etc. Act 1974 \(Application outside Great Britain\) \(Variation\) Order 2011 \(S.I. 2011/745\)](#), arts. 1(1), [3\(2\)](#))
- C790** Ss. 1-25, 26, 27, 28, 30, 33, 34-59, 80, 81 and 82 applied by S.I. 1989/840, [arts. 2-10](#)
- C791** Ss. 1-59, 80-82 applied (11.7.2001) by S.I. 2001/2127, [arts. 4\(1\)](#), 5(1)(2), 6(1), 7(1), 8(1), 10 (with art. 11) (as amended by S.I. 2009/1750, [art. 2\(2\)\(4\)](#))
- C792** Ss. 1-59, 80-82 applied (temp.) (5.8.2009) by [The Health and Safety at Work etc. Act 1974 \(Application outside Great Britain\) Order 2001 \(S.I. 2001/2127\)](#), arts. 8A, 8B (as inserted by S.I. 2009/1750, [art. 2\(3\)](#))

Marginal Citations

- M13** 1973 c. 50.

56 Functions of authority responsible for maintaining the service.

- (1) The authority for the time being responsible for maintaining the employment medical advisory service shall for the purpose of discharging that responsibility appoint persons to be employment medical advisers, and may for that purpose appoint such other officers and servants as it may determine, subject however to the requisite approval as to numbers, that is to say—
 - (a) where that authority is the Secretary of State, the approval of the Minister for the Civil Service;
 - (b) otherwise, the approval of the Secretary of State given with the consent of that Minister.
- (2) A person shall not be qualified to be appointed, or to be, an employment medical adviser unless he is a fully registered medical practitioner [^{F248}who holds a licence to practise].
- (3) The authority for the time being responsible for maintaining the said service may determine the cases and circumstances in which the employment medical advisers or any of them are to perform the duties or exercise the powers conferred on employment medical advisers by or under this Act or otherwise.

Changes to legislation: *Health and Safety at Work etc. Act 1974 is up to date with all changes known to be in force on or before 28 April 2021. There are changes that may be brought into force at a future date. Changes that have been made appear in the content and are referenced with annotations. (See end of Document for details) View outstanding changes*

- (4) Where as a result of arrangements made in pursuance of section 55(2) the authority responsible for maintaining the said service changes, the change shall not invalidate any appointment previously made under subsection (1) above, and any such appointment subsisting when the change occurs shall thereafter have effect as if made by the new authority.

Textual Amendments

F248 Words in s. 56(2) inserted (coming into force in accordance with art. 1(2)(3) of the amending S.I.) by S.I. 2002/3135, art. 16(1)(3), **Sch. 1 para. 7(1)** (with transitional provisions in Sch. 2)

Modifications etc. (not altering text)

C36 Ss. 1-59 applied by S.I. 2001/2127 art. 8A 8B (as inserted (E.W.S.) (6.4.2011) by [The Health and Safety at Work etc. Act 1974 \(Application outside Great Britain\) \(Variation\) Order 2011 \(S.I. 2011/745\)](#), arts. 1(1), **3(2)**)

C793 Ss. 1-25, 26, 27, 28, 30, 33, 34-59, 80, 81 and 82 applied by S.I. 1989/840, **arts. 2-10**

C794 Ss. 1-59, 80-82 applied (11.7.2001) by S.I. 2001/2127, **arts. 4(1), 5(1)(2), 6(1), 7(1), 8(1), 10** (with art. 11) (as amended by S.I. 2009/1750, **art. 2(2)(4)**)

C795 Ss. 1-59, 80-82 applied (temp.) (5.8.2009) by [The Health and Safety at Work etc. Act 1974 \(Application outside Great Britain\) Order 2001 \(S.I. 2001/2127\)](#), arts. 8A, 8B (as inserted by S.I. 2009/1750, **art. 2(3)**)

57 Fees.

- (1) The Secretary of State may by regulations provide for such fees as may be fixed by or determined under the regulations to be payable for or in connection with the performance by the authority responsible for maintaining the employment medical advisory service of any function conferred for the purposes of that service on that authority by virtue of this Part or otherwise.
- (2) For the purposes of this section, the performance by an employment medical adviser of his functions shall be treated as the performance by the authority responsible for maintaining the said service of functions conferred on that authority as mentioned in the preceding subsection.
- (3) The provisions of subsections (4), (5) and (8) of section 43 shall apply in relation to regulations under this section with the modification that references to subsection (2) of that section shall be read as references to subsection (1) of this section.
- (4) Where an authority other than the Secretary of State is responsible for maintaining the said service, the Secretary of State shall consult that authority before making any regulations under this section.

Modifications etc. (not altering text)

C36 Ss. 1-59 applied by S.I. 2001/2127 art. 8A 8B (as inserted (E.W.S.) (6.4.2011) by [The Health and Safety at Work etc. Act 1974 \(Application outside Great Britain\) \(Variation\) Order 2011 \(S.I. 2011/745\)](#), arts. 1(1), **3(2)**)

C796 Ss. 1-25, 26, 27, 28, 30, 33, 34-59, 80, 81 and 82 applied by S.I. 1989/840, **arts. 2-10**

C797 Ss. 1-59, 80-82 applied (11.7.2001) by S.I. 2001/2127, **arts. 4(1), 5(1)(2), 6(1), 7(1), 8(1), 10** (with art. 11) (as amended by S.I. 2009/1750, **art. 2(2)(4)**)

Changes to legislation: Health and Safety at Work etc. Act 1974 is up to date with all changes known to be in force on or before 28 April 2021. There are changes that may be brought into force at a future date. Changes that have been made appear in the content and are referenced with annotations. (See end of Document for details) View outstanding changes

C798 Ss. 1-59, 80-82 applied (temp.) (5.8.2009) by The Health and Safety at [Work etc. Act 1974](#) (Application outside Great Britain) Order 2001 (S.I. 2001/2127), arts. 8A, 8B (as inserted by S.I. 2009/1750, [art. 2\(3\)](#))

58 Other financial provisions.

- (1) The authority for the time being responsible for maintaining the employment medical advisory service may pay—
- (a) to employment medical advisers such salaries or such fees and travelling or other allowances; and
 - (b) to other persons called upon to give advice in connection with the execution of the authority's functions under this Part such travelling or other allowances or compensation for loss of remunerative time; and
 - (c) to persons attending for medical examinations conducted by, or in accordance with arrangements made by, employment medical advisers (including pathological, physiological and radiological tests and similar investigations so conducted) such travelling or subsistence allowances or such compensation for loss of earnings,
- as the authority may, with the requisite approval, determine.
- (2) For the purposes of the preceding subsection the requisite approval is—
- (a) where the said authority is the Secretary of State, the approval of the Minister for the Civil Service;
 - (b) otherwise, the approval of the Secretary of State given with the consent of that Minister.
- (3) Where an authority other than the Secretary of State is responsible for maintaining the said service, it shall be the duty of the Secretary of State to pay to that authority such sums as are approved by the Treasury and as he considers appropriate for the purpose of enabling the authority to discharge that responsibility.

Modifications etc. (not altering text)

- C36** Ss. 1-59 applied by S.I. 2001/2127 art. 8A 8B (as inserted (E.W.S.) (6.4.2011) by [The Health and Safety at Work etc. Act 1974 \(Application outside Great Britain\) \(Variation\) Order 2011](#) (S.I. 2011/745), arts. 1(1), [3\(2\)](#))
- C799** Ss. 1-25, 26, 27, 28, 30, 33, 34-59, 80, 81 and 82 applied by S.I. 1989/840, [arts. 2-10](#)
- C800** Ss. 1-59, 80-82 applied (11.7.2001) by S.I. 2001/2127, [arts. 4\(1\)](#), 5(1)(2), 6(1), 7(1), 8(1), 10 (with [art. 11](#)) (as amended by S.I. 2009/1750, [art. 2\(2\)\(4\)](#))
- C801** Ss. 1-59, 80-82 applied (temp.) (5.8.2009) by The Health and Safety at [Work etc. Act 1974](#) (Application outside Great Britain) Order 2001 (S.I. 2001/2127), arts. 8A, 8B (as inserted by S.I. 2009/1750, [art. 2\(3\)](#))

59 Duty of responsible authority to keep accounts and to report.

- (1) It shall be the duty of the authority for the time being responsible for maintaining the employment medical advisory service—
- (a) to keep, in relation to the maintenance of that service, proper accounts and proper records in relation to the accounts;

Changes to legislation: *Health and Safety at Work etc. Act 1974 is up to date with all changes known to be in force on or before 28 April 2021. There are changes that may be brought into force at a future date. Changes that have been made appear in the content and are referenced with annotations. (See end of Document for details) View outstanding changes*

- (b) to prepare in respect of each accounting year a statement of accounts relating to the maintenance of that service in such form as the Secretary of State may direct with the approval of the Treasury; and
 - (c) to send copies of the statement to the Secretary of State and the Comptroller and Auditor General before the end of the month of November next following the accounting year to which the statement relates.
- (2) The Comptroller and Auditor General shall examine, certify and report on each statement received by him in pursuance of subsection (1) above and shall lay copies of each statement and of his report before each House of Parliament.
- (3) It shall also be the duty of the authority responsible for maintaining the employment medical advisory service to make to the Secretary of State, as soon as possible after the end of each accounting year, a report on the discharge of its responsibilities in relation to that service during that year; and the Secretary of State shall lay before each House of Parliament a copy of each report made to him in pursuance of this subsection.
- (4) Where as a result of arrangements made in pursuance of section 55(2) the authority responsible for maintaining the employment medical advisory service changes, the change shall not affect any duty imposed by this section on the body which was responsible for maintaining that service before the change.
- (5) No duty imposed on the authority for the time being responsible for maintaining the employment medical advisory service by subsection (1) or (3) above shall fall on [F249the Executive](which is subject to corresponding duties under Schedule 2) or on the Secretary of State.
- (6) In this section “accounting year” means, except so far as the Secretary of State otherwise directs, the period of twelve months ending with 31st March in any year.

Textual Amendments

F249 Words s. 59(5) substituted (1.4.2008) by [The Legislative Reform \(Health and Safety Executive\) Order 2008 \(S.I. 2008/960\)](#), **art. 19** (with **art. 21**, **Sch. 2**)

Modifications etc. (not altering text)

C36 Ss. 1-59 applied by S.I. 2001/2127 art. 8A 8B (as inserted (E.W.S.) (6.4.2011) by [The Health and Safety at Work etc. Act 1974 \(Application outside Great Britain\) \(Variation\) Order 2011 \(S.I. 2011/745\)](#), arts. 1(1), **3(2)**)

C802 Ss. 1-25, 26, 27, 28, 30, 33, 34-59, 80, 81 and 82 applied by S.I. 1989/840, **arts. 2-10**

C803 Ss. 1-59, 80-82 applied (11.7.2001) by S.I. 2001/2127, **arts. 4(1)**, 5(1)(2), 6(1), 7(1), 8(1), 10 (with **art. 11**) (as amended by S.I. 2009/1750, **art. 2(2)(4)**)

C804 Ss. 1-59, 80-82 applied (temp.) (5.8.2009) by [The Health and Safety at Work etc. Act 1974 \(Application outside Great Britain\) Order 2001 \(S.I. 2001/2127\)](#), arts. 8A, 8B (as inserted by S.I. 2009/1750, **art. 2(3)**)

60 Supplementary.

- (1) It shall be the duty of the Secretary of State to secure that[F250the National Health Service Commissioning Board or each clinical commissioning group (in relation to England) and each Local Health Board (in relation to Wales)][F251arranges for] a fully registered medical practitioner [F252who holds a licence to practise] to furnish, on the application of an employment medical adviser, such particulars of the school medical

Changes to legislation: Health and Safety at Work etc. Act 1974 is up to date with all changes known to be in force on or before 28 April 2021. There are changes that may be brought into force at a future date. Changes that have been made appear in the content and are referenced with annotations. (See end of Document for details) View outstanding changes

record of a person who has not attained the age of eighteen and such other information relating to his medical history as the adviser may reasonably require for the efficient performance of his functions; but no particulars or information about any person which may be furnished to an adviser in pursuance of this subsection shall (without the consent of that person) be disclosed by the adviser otherwise than for the efficient performance of his functions.

- (2) In its application to Scotland the preceding subsection shall have effect with the substitution of the words “every Health Board arrange ^{F253}...” for the words from [^{F254}“the National” to “arranges”].
- ^{F255}(3)
- (4) References to the chief employment medical adviser or a deputy chief employment medical adviser in any provision of an enactment or instrument made under an enactment shall be read as references to a person appointed for the purposes of that provision by the authority responsible for maintaining the employment medical advisory service.
- (5) The following provisions of the ^{M14}Employment Medical Advisory Service Act 1972 (which are superseded by the preceding provisions of this Part or rendered unnecessary by provisions contained in Part I), namely sections 1 and 6 and Schedule 1, shall cease to have effect; but—
- (a) in so far as anything done under or by virtue of the said section 1 or Schedule 1 could have been done under or by virtue of a corresponding provision of Part I or this Part, it shall not be invalidated by the repeal of that section and Schedule by this Act but shall have effect as if done under or by virtue of that corresponding provision; and
- (b) any order made under the said section 6 which is in force immediately before the repeal of that section by this Act shall remain in force notwithstanding that repeal, but may be revoked or varied by regulations under section 43(2) or 57, as if it were an instrument containing regulations made under section 43(2) or 57, as the case may require.
- (6) Where any Act (whether passed before, or in the same Session as, this Act) or any document refers, either expressly or by implication, to or to any enactment contained in any of the provisions of the said Act of 1972 which are mentioned in the preceding subsection, the reference shall, except where the context otherwise requires, be construed as, or as including, a reference to the corresponding provision of this Act.
- (7) Nothing in subsection (5) or (6) above shall be taken as prejudicing the operation of [^{F256}sections 16(1) and 17(2)(a) of the ^{M15}Interpretation Act 1978] (which relates to the effect of repeals).

Textual Amendments

F250 Words in s. 60(1) substituted (1.4.2013) by **Health and Social Care Act 2012 (c. 7), s. 306(4), Sch. 5 para. 19(2)**; S.I. 2013/160, art. 2(2) (with arts. 7-9)

F251 Words in s. 60(1) substituted (28.6.1995 for specified purposes and otherwise 1.4.1996) by **1995 c. 17, ss. 2(1)(3), 8(1), Sch. 1 Pt. III para. 99** (with Sch. 2 paras. 6, 16)

F252 Words in s. 60(1) inserted (coming into force in accordance with art. 1(2)(3) of the amending S.I.) by 2002/3135, art. 16(1)(3), Sch. 1 para. 7(2) (with transitional provisions in Sch. 2)

F253 Words in s. 60(2) omitted (1.4.2013) by virtue of **Health and Social Care Act 2012 (c. 7), s. 306(4), Sch. 5 para. 19(3)(a)**; S.I. 2013/160, art. 2(2) (with arts. 7-9)

Changes to legislation: *Health and Safety at Work etc. Act 1974 is up to date with all changes known to be in force on or before 28 April 2021. There are changes that may be brought into force at a future date. Changes that have been made appear in the content and are referenced with annotations. (See end of Document for details) View outstanding changes*

F254 Words in s. 60(2) substituted (1.4.2013) by Health and Social Care Act 2012 (c. 7), s. 306(4), **Sch. 5 para. 19(3)(b)**; S.I. 2013/160, art. 2(2) (with arts. 7-9)

F255 S. 60(3) repealed by Statute Law (Repeals) Act 1986 (c. 12), s. 1(1), **Sch. 1 Pt. XIII**

F256 Words substituted by virtue of Interpretation Act 1978 (c. 30), s. 25(2)

Modifications etc. (not altering text)

C805 S. 60(1): functions not to be exercised by a primary care trust (1.4.2000) by virtue of S.I. 2000/695, art. 4(1), **Sch. 4**; which amendment falls (1.4.2002) by virtue of S.I. 2002/555, **reg. 6(2)(a)**

Marginal Citations

M14 1972 c. 28.

M15 1978 c. 30.

PART III

M16 BUILDING REGULATIONS, AND AMENDMENT OF BUILDING (SCOTLAND) ACT 1959

Marginal Citations

M16 1959 c. 24.

F257 61,
62.

Textual Amendments

F257 Ss. 61, 62, 63(5)(6)(7), 64–69, 70(2)–(8), 71–74, 76, Sch. 5 and Sch. 6 repealed by Building Act 1984 (c. 55, SIF 15), s. 133(2), **Sch. 7**

63 Miscellaneous provisions as to the approval of plans.

F258 (1)

F259 (5)

Textual Amendments

F258 S. 63(1)–(4) repealed by Local Government (Miscellaneous Provisions) Act 1982 (c. 30, SIF 81:1), s. 47, **Sch. 7 Pt. XVI**

F259 Ss. 61, 62, 63(5)(6)(7), 64–69, 70(2)–(8), 71–74, 76, Sch. 5 and Sch. 6 repealed by Building Act 1984 (c. 55, SIF 15), s. 133(2), **Sch. 7**

F260 64
—69.

Changes to legislation: Health and Safety at Work etc. Act 1974 is up to date with all changes known to be in force on or before 28 April 2021. There are changes that may be brought into force at a future date. Changes that have been made appear in the content and are referenced with annotations. (See end of Document for details) View outstanding changes

Textual Amendments

F260 Ss. 61, 62, 63(5)(6)(7), 64–69, 70(2)–(8), 71–74, 76, Sch. 5 and Sch. 6 repealed by [Building Act 1984](#) (c. 55, SIF 15), s. 133(2), [Sch. 7](#)

70 Power to make building regulations for Inner London.

F261(1)

F262(2)

Textual Amendments

F261 S. 70(1) repealed by [Building Act 1984](#) (c. 55, SIF 15), ss. 132, 133(2), Sch. 5 para. 5, [Sch. 7](#)

F262 Ss. 61, 62, 63(5)(6)(7), 64–69, 70(2)–(8), 71–74, 76, Sch. 5 and Sch. 6 repealed by [Building Act 1984](#) (c. 55, SIF 15), s. 133(2), [Sch. 7](#)

F263~~71~~

~~—74.~~

Textual Amendments

F263 Ss. 61, 62, 63(5)(6)(7), 64–69, 70(2)–(8), 71–74, 76, Sch. 5 and Sch. 6 repealed by [Building Act 1984](#) (c. 55, SIF 15), s. 133(2), [Sch. 7](#)

75 Amendment of Building (Scotland) Act 1959.

F264

Textual Amendments

F264 S. 75 repealed (S.) (1.5.2005) by [Building \(Scotland\) Act 2003](#) (asp 8), s. 58, [Sch. 6 para. 9](#), S.S.I. 2004/404, [arts. 2\(1\)](#), 3, 4

F265~~76~~

Textual Amendments

F265 Ss. 61, 62, 63(5)(6)(7), 64–69, 70(2)–(8), 71–74, 76, Sch. 5 and Sch. 6 repealed by [Building Act 1984](#) (c. 55, SIF 15), s. 133(2), [Sch. 7](#)

Changes to legislation: *Health and Safety at Work etc. Act 1974 is up to date with all changes known to be in force on or before 28 April 2021. There are changes that may be brought into force at a future date. Changes that have been made appear in the content and are referenced with annotations. (See end of Document for details) View outstanding changes*

PART IV

MISCELLANEOUS AND GENERAL

Extent Information

E9 For the application of Pt. IV to Northern Ireland see s. 84(1).

^{x1}77 **Amendment of Radiological Protection Act 1970.**

[^{F266}(1) Section 1 of the Radiological Protection Act 1970 (establishment and functions of the National Radiological Protection Board) shall be amended in accordance with the following provisions of this subsection—

(a) after subsection (6) there shall be inserted as subsection (6A)—

“(6A) In carrying out such of their functions as relate to matters to which functions of the Health and Safety Commission relate, the Board shall (without prejudice to subsection (7) below) act in consultation with the Commission and have regard to the Commission’s policies with respect to such matters.”

(b) after subsection (7) there shall be inserted as subsections (7A) and (7B)—

“(7A) Without prejudice to subsection (6) or (7) above, it shall be the duty of the Board, if so directed by the Health Ministers, to enter into an agreement with the Health and Safety Commission for the Board to carry out on behalf of the Commission such of the Commission’s functions relating to ionising or other radiations (including those which are not electro-magnetic) as may be determined by or in accordance with the direction ; and the Board shall have the power to carry out any agreement entered into in pursuance of a direction under this subsection.

(7B) The requirement as to consultation in subsection (7) above shall not apply to a direction under subsection (7A).”

(c) in subsection (8), after the words “subsection (7)” there shall be inserted the words “ or (7A) ”.

(2) In section 2(6) of the Radiological Protection Act 1970 (persons by whom, as regards premises occupied by the said Board, sections 1 to 51 of the ^{M17}Offices, Shops and Railway Premises Act 1963 and regulations thereunder are enforceable) for the words from “inspectors appointed” to the end of the subsection there shall be substituted the words “ inpectors appointed by the Health and Safety Executive under section 19 of the Health and Safety at Work etc. Act 1974. ”]

Editorial Information

X1 The text of ss. 75, 77, 78(1)–(3)(5)–(9), 83, Sch. 7, Sch. 9 para. 1, and Sch. 10 is in the form in which it was originally enacted: it was not reproduced in Statutes in Force and, except as specified, does not reflect any amendments or repeals which may have been made prior to 1.2.1991

Changes to legislation: Health and Safety at Work etc. Act 1974 is up to date with all changes known to be in force on or before 28 April 2021. There are changes that may be brought into force at a future date. Changes that have been made appear in the content and are referenced with annotations. (See end of Document for details) View outstanding changes

Textual Amendments

F266 S. 77 repealed (1.4.2005) by [Health Protection Agency Act 2004 \(c. 17\)](#), ss. 11, 12, [Sch. 4](#); S.I. 2005/121, [art. 2\(2\)](#)

Marginal Citations

M17 1963 c. 41.

78 Amendment of Fire Precautions Act 1971.

^{X2}[^{F267}(1) The ^{M18}Fire Precautions Act 1971 shall be amended in accordance with the following provisions of this section.

^{X2}(2) In section 1(2) (power to designate uses of premises for which fire certificate is compulsory) at the end there shall be inserted as paragraph (f)—
“^(f) use of place of work.”

^{F268}(3)

^{F269}(4)

^{X2}(5) In section 12(1) (power to make regulations about fire precautions as regards certain premises), at the end there shall be added the words “ and nothing in this section shall confer on the Secretary of State power to make provision with respect to the taking or observance of special precautions in connection with the carrying on of any manufacturing process ”.

^{X2}(6) In section 17 (duty of fire authorities to consult other authorities before requiring alterations to buildings)—

(a) in subsection (1), the word “and” shall be omitted where last occurring in paragraph (i) and shall be added at the end of paragraph (ii), and after paragraph (ii) there shall be added as paragraph (iii)—

“⁽ⁱⁱⁱ⁾ if the premises are used as a place of work and are within the field of responsibility of one or more enforcing authorities within the meaning of Part I of the Health and Safety at Work etc. Act 1974, consult that authority or each of those authorities.”;

(b) in subsection (2) (clarification of references in section 9 to persons aggrieved), for the words “or buildings authority” there shall be substituted the words “ buildings authority or other authority ”;

(c) after subsection (2) there shall be added as subsection (3)—

“⁽³⁾ Section 18(7) of the Health and Safety at Work etc. Act 1974 (meaning in Part I of that Act of “enforcing authority” and of such an authority’s “field of responsibility”) shall apply for the purposes of this section as it applies for the purposes of that Part.”

^{X2}(7) In section 18 (enforcement of Act)—

(a) for the word “it” there shall be substituted the words “ (1) Subject to subsection (2) below, it ”;

(b) for the word “section” there shall be substituted the word “ subsection ”; and

(c) [^{F270}after the word “offence” there shall be added as subsection (2)—

Changes to legislation: *Health and Safety at Work etc. Act 1974 is up to date with all changes known to be in force on or before 28 April 2021. There are changes that may be brought into force at a future date. Changes that have been made appear in the content and are referenced with annotations. (See end of Document for details) View outstanding changes*

“(2) A fire authority shall have power to arrange with the Health and Safety Commission for such of the authority’s functions under this Act as may be specified in the arrangements to be performed on their behalf by the Health and Safety Executive (with or without payment) in relation to any particular premises so specified which are used as a place of work.”]

^{X2}(8) In section 40 (application to Crown etc.)—

- (a) in subsection (1)(a) (provisions which apply to premises owned, but not occupied by the Crown), after the word “6” there shall be inserted the words “, 9A (except subsection (4)) ”;
- (b) in subsection (1)(b) (provisions which apply to premises owned, but not occupied by the Crown), after the word “8” there shall be inserted the word “ 9A ”;
- (c) in subsection (10) (application of Act to hospital premises in Scotland), for the words from “Regional” to “hospitals” there shall be substituted the words “ Health Board ”;

^{F271}(d)

^{X2}(9) In section 43(1) (interpretation) there shall be added at the end the following definition—

““work” has the same meaning as it has for the purposes of Part I of the Health and Safety at Work etc. Act 1974”

(10) Schedule 8 (transitional provisions with respect to fire certificates under the ^{M19}Factories Act 1961 or the ^{M20}Offices, Shops and Railway Premises Act 1963) shall have effect.]

Editorial Information

X2 The text of ss. 75, 77, 78(1)–(3)(5)–(9), 83, Sch. 7, Sch. 9 para. 1, and Sch. 10 is in the form in which it was originally enacted: it was not reproduced in Statutes in Force and, except as specified, does not reflect any amendments or repeals which may have been made prior to 1.2.1991

Textual Amendments

- F267** S. 78 repealed (E.W.) (1.10.2006) by [The Regulatory Reform \(Fire Safety\) Order 2005 \(S.I. 2005/1541\)](#), art. 53(2), **Sch. 4** (with art. 49) (as amended by [The Regulatory Reform \(Fire Safety\) Subordinate Provisions Order 2006 \(S.I. 2006/484\)](#), **arts. 1(1), 2**); and s. 78 repealed (S.) (1.10.2006) by [The Fire \(Scotland\) Act 2005 \(Consequential Modifications and Savings\) Order 2006 \(S.S.I. 2006/475\)](#), art. 2(2), **Sch. 2**
- F268** S. 78(3) repealed (5.11.1993) by 1993 c. 50, s. 1(1), **Sch. 1 Pt. XVI** Group 1.
- F269** S. 78(4) repealed by [Fire Safety and Safety of Places of Sport Act 1987 \(c. 27, SIF 45A\)](#), s. 49, **Sch. 4**
- F270** S. 78(7)(c) repealed (E.W.S.) (1.4.2006) by [Railways Act 2005 \(c. 14\)](#), ss. 59, 60, **Sch. 13 Pt. 1** (with s. 14(4)(5), **Sch. 11 para. 11(2)**); S.I. 2006/266, **art. 2(2)**, Sch.
- F271** S. 78(8)(d) repealed (1.4.1996) by 1995 c. 17, s. 5(1)(2), **Sch. 3**

Marginal Citations

- M18** 1971 c. 40.
M19 1961 c. 34.
M20 1963 c. 41.

Changes to legislation: Health and Safety at Work etc. Act 1974 is up to date with all changes known to be in force on or before 28 April 2021. There are changes that may be brought into force at a future date. Changes that have been made appear in the content and are referenced with annotations. (See end of Document for details) View outstanding changes

F272 79

Textual Amendments

F272 S. 79 repealed by Companies Consolidation (Consequential Provisions) Act 1985 (c. 9, SIF 27), s. 29, Sch. 1

80 General power to repeal or modify Acts and instruments.

- (1) Regulations made under this subsection may repeal or modify any provision to which this subsection applies if it appears to the authority making the regulations that the repeal or, as the case may be, the modification of that provision is expedient in consequence of or in connection with any provision made by or under Part I.
- (2) Subsection (1) above applies to any provision, not being among the relevant statutory provisions, which—
 - (a) is contained in this Act or in any other Act passed before or in the same Session as this Act; or
 - (b) is contained in any regulations, order or other instrument of a legislative character which was made under an Act before the passing of this Act; or
 - (c) applies, excludes or for any other purpose refers to any of the relevant statutory provisions and is contained in any Act not falling within paragraph (a) above or in any regulations, order or other instrument of a legislative character which is made under an Act but does not fall within paragraph (b) above.
- [^{F273}(2A) Subsection (1) above shall apply to provisions in [^{F274}the Employment Rights Act 1996 or the Trade Union and Labour Relations (Consolidation) Act 1992 which derive from provisions of the Employment Protection (Consolidation) Act 1978 which re-enacted]provisions previously contained in the ^{M21}Redundancy Payments Act 1965, the ^{M22}Contracts of Employment Act 1972 or the ^{M23}Trade Union and Labour Relations Act 1974 as it applies to provisions contained in Acts passed before or in the same Session as this Act.]
- (3) Without prejudice to the generality of subsection (1) above, the modifications which may be made by regulations thereunder include modifications relating to the enforcement of provisions to which this section applies (including the appointment of persons for the purpose of such enforcement, and the powers of persons so appointed).
- [^{F275}(4) The power to make regulations under subsection (1) above shall be exercisable by the Secretary of State ^{F276}. . .; but the authority who is to exercise the power shall, before exercising it, consult such bodies as appear to him to be appropriate.
- (5) In this section “the relevant statutory provisions” has the same meaning as in Part I.]

Textual Amendments

F273 S. 80(2A) inserted by Employment Protection (Consolidation) Act 1978 (c. 44), Sch. 16 para. 17

F274 Words in s. 80(2A) substituted (22.8.1996) by 1996 c. 18, ss. 240, 243, Sch. 1 para. 5 (with ss. 191-195, 202)

F275 S. 80(4)(5) substituted for S. 80(4)-(6) by Employment Protection Act 1975 (c. 71), Sch. 15 para. 19

F276 Words in s. 80(4) repealed (27.3.2002) by S.I. 2002/794, art. 5(2), Sch. 2 (with art. 6)

Changes to legislation: *Health and Safety at Work etc. Act 1974 is up to date with all changes known to be in force on or before 28 April 2021. There are changes that may be brought into force at a future date. Changes that have been made appear in the content and are referenced with annotations. (See end of Document for details) View outstanding changes*

Modifications etc. (not altering text)

- C806** S. 80 extended by Local Government (Miscellaneous Provisions) Act 1976 (c. 57), s. 12(3)
- C807** Ss. 1–25, 26, 27, 28, 30, 33, 34–59, 80, 81 and 82 applied by S.I. 1989/840, arts. 2–10
- C808** S. 80 extended by Local Government (Scotland) Act 1973 (c. 65, SIF 81:2), s. 170B(5), as inserted by Electricity Act 1989 (c. 29, SIF 44:1), s. 102, Sch. 13
- C809** Ss. 1–59, 80–82 applied (11.7.2001) by S.I. 2001/2127, arts. 4(1), 5(1)(2), 6(1), 7(1), 8(1), 10 (with art. 11) (as amended by S.I. 2009/1750, art. 2(2)(4))
- C810** Ss. 1–59, 80–82 applied (temp.) (5.8.2009) by The Health and Safety at Work etc. Act 1974 (Application outside Great Britain) Order 2001 (S.I. 2001/2127), arts. 8A, 8B (as inserted by S.I. 2009/1750, art. 2(3))
- C811** Ss. 80–82 applied by S.I. 2001/2127 art. 8A 8B (as inserted (6.4.2011) by The Health and Safety at Work etc. Act 1974 (Application outside Great Britain) (Variation) Order 2011 (S.I. 2011/745), arts. 1(1), 3(2))
- C812** S. 80(1) extended (E.W.) by British Waterways Act 1983 (c. ii), s. 19(1), and (S.) by Civic Government (Scotland) Act 1982 (c. 45, SIF 81:2), s. 109
- C813** S. 80(1) extended (S.) by Roads (Scotland) Act 1984 (c. 54, SIF 108), s. 128(2)
S. 80(1) extended (E.W.S.) (27.8.1993) by 1993 c. 11, ss. 67(1), 68(2), Sch. 4 para. 1.
- C814** S. 80(1) applied (18.6.1992) by Pittenweem Harbour Order Confirmation Act 1992 (c. ix), s. 1, Sch. s. 22(2)
- C815** S. 80(1) applied (16.7.1992) by Peterhead Harbours Order Confirmation Act 1992 (c. xii), s. 1, Sch. s. 61
S. 80(1) applied (27.8.1993) by 1993 c. 12, ss. 49(2), 51(2), Sch. 5 Pt. I para. 6 (with ss. 42, 46).
S. 80(1) applied (5.9.2002) by S.S.I. 2002/410, art. 57(2) (with arts. 59, 61)
- C816** S. 80(1) applied (S.) (23.5.2008) by The Dumfries and Galloway Council (Port William) Harbour Empowerment Order 2008 (S.S.I. 2008/188), art. 53(2) (with arts. 53–56)
- C817** S. 80(1) applied (S.) (23.5.2008) by The Dumfries and Galloway Council (Isle of Whithorn) Harbour Empowerment Order 2008 (S.S.I. 2008/189), art. 53(2) (with arts. 53–56)
- C818** S. 80(1) applied (S.) (23.5.2008) by The Dumfries and Galloway Council (Garlieston) Harbour Empowerment Order 2008 (S.S.I. 2008/190), art. 53(2) (with arts. 53–56)

Marginal Citations

- M21** 1965 c. 62.
M22 1972 c. 53.
M23 1974 c. 52.

81 Expenses and receipts.

There shall be paid out of money provided by Parliament—

- (a) any expenses incurred by a Minister of the Crown or government department for the purposes of this Act; and
- (b) any increase attributable to the provisions of this Act in the sums payable under any other Act out of money so provided;

and any sums received by a Minister of the Crown or government department by virtue of this Act shall be paid into the Consolidated Fund.

Modifications etc. (not altering text)

- C811** Ss. 80–82 applied by S.I. 2001/2127 art. 8A 8B (as inserted (6.4.2011) by The Health and Safety at Work etc. Act 1974 (Application outside Great Britain) (Variation) Order 2011 (S.I. 2011/745), arts. 1(1), 3(2))
- C819** Ss. 1–25, 26, 27, 28, 30, 33, 34–59, 80, 81 and 82 applied by S.I. 1989/840, arts. 2–10

Changes to legislation: *Health and Safety at Work etc. Act 1974 is up to date with all changes known to be in force on or before 28 April 2021. There are changes that may be brought into force at a future date. Changes that have been made appear in the content and are referenced with annotations. (See end of Document for details) View outstanding changes*

Ss. 1-59, 80-82 applied (11.7.2001) by S.I. 2001/2127, **arts. 4(1), 5(1)(2), 6(1), 7(1), 8(1), 10** (with art. 11) (as amended by S.I. 2009/1750, **art. 2(2)(4)**)

C820 Ss. 1-59, 80-82 applied (temp.) (5.8.2009) by The Health and Safety at Work etc. Act 1974 (Application outside Great Britain) Order 2001 (S.I. 2001/2127), arts. 8A, 8B (as inserted by S.I. 2009/1750, **art. 2(3)**)

82 General provisions as to interpretation and regulations.

(1) In this Act—

- (a) “Act” includes a provisional order confirmed by an Act;
- (b) “contravention” includes failure to comply, and “contravene” has a corresponding meaning;
- (c) “modifications” includes additions, omissions and amendments, and related expressions shall be construed accordingly;
- (d) any reference to a Part, section or Schedule not otherwise identified is a reference to that Part or section of, or Schedule to, this Act.

(2) Except in so far as the context otherwise requires, any references in this Act to an enactment is a reference to it as amended, and includes a reference to it as applied, by or under any other enactment, including this Act.

(3) Any power conferred by Part I or II or this Part to make regulations—

- (a) includes power to make different provision by the regulations for different circumstances or cases and to include in the regulations such incidental, supplemental and transitional provisions as the authority making the regulations considers appropriate in connection with the regulations; and
- (b) shall be exercisable by statutory instrument, which [^{F277}(unless [^{F278}subsection (3A), (3B) or (4)] applies)] shall be subject to annulment in pursuance of a resolution of either House of Parliament.

[^{F279}(3A) In the case of a statutory instrument which also contains regulations under section 74 of the Energy Act 2013 (nuclear regulations), subsection (3) is subject to section 113 of that Act (subordinate legislation).]

[^{F280}(3B) Regulations under section 3(2) shall not be made unless a draft has been laid before and approved by resolution of each House of Parliament.]

[^{F281}(4) The first regulations under section 43A(1) shall not be made unless a draft has been laid before and approved by resolution of each House of Parliament.]

Textual Amendments

F277 Words in s. 82(3)(b) inserted (10.9.2003) by [Railways and Transport Safety Act 2003 \(c. 20\)](#), **s. 105(3)(a)**

F278 Words in s. 82(3)(b) substituted (26.3.2015 for specified purposes, 1.10.2015 in so far as not already in force) by [Deregulation Act 2015 \(c. 20\)](#), **ss. 1(5)(a), 115(2)(a)** (with s. 1(6)); S.I. 2015/1732, **art. 2(a)**

F279 S. 82(3A) inserted (1.4.2014) by [Energy Act 2013 \(c. 32\)](#), s. 156(1), **Sch. 12 para. 13(3)**; S.I. 2014/251, **art. 4**

F280 S. 82(3B) inserted (26.3.2015 for specified purposes, 1.10.2015 in so far as not already in force) by [Deregulation Act 2015 \(c. 20\)](#), **ss. 1(5)(b), 115(2)(a)** (with s. 1(6)); S.I. 2015/1732, **art. 2(a)**

F281 S. 82(4) inserted (10.9.2003) by [Railways and Transport Safety Act 2003 \(c. 20\)](#), **s. 105(3)(b)**

Changes to legislation: *Health and Safety at Work etc. Act 1974 is up to date with all changes known to be in force on or before 28 April 2021. There are changes that may be brought into force at a future date. Changes that have been made appear in the content and are referenced with annotations. (See end of Document for details) View outstanding changes*

Modifications etc. (not altering text)

- C811** Ss. 80-82 applied by S.I. 2001/2127 art. 8A 8B (as inserted (6.4.2011) by [The Health and Safety at Work etc. Act 1974 \(Application outside Great Britain\) \(Variation\) Order 2011 \(S.I. 2011/745\)](#), arts. 1(1), 3(2))
- C821** Ss. 1–25, 26, 27, 28, 30, 33, 34–59, 80, 81 and 82 applied by S.I. 1989/840, **arts. 2–10**
- C822** Ss. 1-59, 80-82 applied (11.7.2001) by S.I. 2001/2127, **arts. 4(1), 5(1)(2), 6(1), 7(1), 8(1), 10** (with art. 11) (as amended by S.I. 2009/1750, **art. 2(2)(4)**)
- C823** Ss. 1-59, 80-82 applied (temp.) (5.8.2009) by [The Health and Safety at Work etc. Act 1974 \(Application outside Great Britain\) Order 2001 \(S.I. 2001/2127\)](#), arts. 8A, 8B (as inserted by S.I. 2009/1750, **art. 2(3)**)

^{F282}**83**

Textual Amendments

- F282** S. 83 repealed (5.11.1993) by [1993 c. 50, s. 1\(1\), Sch. 1 Pt. XVI](#) Group1.

84 Extent, and application of Act.

- (1) This Act, except—
- (a) Part I and this Part so far as may be necessary to enable regulations under section 15 [^{F283} or 30] to be made and operate for the purpose mentioned in paragraph 2 of Schedule 3; and
 - (b) paragraphs ^{F284} . . . 3 of Schedule 9, does not extend to Northern Ireland.
- (2) Part III, except section 75 and Schedule 7, does not extend to Scotland.
- (3) Her Majesty may by Order in Council provide that the provisions of Parts I and II and this Part shall, to such extent and for such purposes as may be specified in the Order, apply (with or without modification) to or in relation to persons, premises, work, articles, substances and other matters (of whatever kind) outside Great Britain as those provisions apply within Great Britain or within a part of Great Britain so specified.

For the purposes of this subsection “premises”, “work” and “substance” have the same meanings as they have for the purposes of Part I.

- (4) An Order in Council under subsection (3) above—
- (a) may make different provision for different circumstances or cases;
 - (b) may (notwithstanding that this may affect individuals or bodies corporate outside the United Kingdom) provide for any of the provisions mentioned in that subsection, as applied by such an Order, to apply to individuals whether or not they are British subjects and to bodies corporate whether or not they are incorporated under the law of any part of the United Kingdom;
 - (c) may make provision for conferring jurisdiction on any court or class of courts specified in the Order with respect to offences under Part I committed outside Great Britain or with respect to causes of action arising by virtue of section 47(2) in respect of acts or omissions taking place outside Great Britain, and for the determination, in accordance with the law in force in such part

Changes to legislation: *Health and Safety at Work etc. Act 1974 is up to date with all changes known to be in force on or before 28 April 2021. There are changes that may be brought into force at a future date. Changes that have been made appear in the content and are referenced with annotations. (See end of Document for details) View outstanding changes*

of Great Britain as may be specified in the Order, of questions arising out of such acts or omissions;

(d) may exclude from the operation of section 3 of the ^{M24}Territorial Waters Jurisdiction Act 1878 (consents required for prosecutions) proceedings for offences under any provision of Part I committed outside Great Britain;

(e) may be varied or revoked by a subsequent Order in Council under this section; and any such Order shall be subject to annulment in pursuance of a resolution of either House of Parliament.

[^{F285}(5) In relation to proceedings for an offence under Part I committed outside Great Britain by virtue of an Order in Council under subsection (3) above, section 38 shall have effect as if the words “by an inspector, or” were omitted.]

(6) Any jurisdiction conferred on any court under this section shall be without prejudice to any jurisdiction exercisable apart from this section by that or any other court.

Textual Amendments

F283 Words repealed (E.W.)(S.) by [Employment Protection Act 1975 \(c. 71\)](#), **Sch. 18**

F284 Words repealed by [House of Commons Disqualification Act 1975 \(c. 24\)](#), **Sch. 3**

F285 [S. 84\(5\)](#) repealed (E.W.S.) (6.3.1992) by [Offshore Safety Act 1992 \(c. 15\)](#), ss. 3(1)(b), 7(2), **Sch. 2**

Marginal Citations

M24 [1878 c. 73](#).

85 Short title and commencement.

(1) This Act may be cited as the Health and Safety at Work etc. Act 1974.

(2) This Act shall come into operation on such day as the Secretary of State may by order made by statutory instrument appoint, and different days may be appointed under this subsection for different purposes.

(3) An order under this section may contain such transitional provisions and savings as appear to the Secretary of State to be necessary or expedient in connection with the provisions thereby brought into force, including such adaptations of those provisions or any provision of this Act then in force as appear to him to be necessary or expedient in consequence of the partial operation of this Act (whether before or after the day appointed by the order).

Modifications etc. (not altering text)

C824 Power of appointment conferred by s. 85(2) partly exercised: [S.I. 1974/1439](#), 1975/344, 1364, 1977/294, 1980/208, 269

Changes to legislation: *Health and Safety at Work etc. Act 1974 is up to date with all changes known to be in force on or before 28 April 2021. There are changes that may be brought into force at a future date. Changes that have been made appear in the content and are referenced with annotations. (See end of Document for details) View outstanding changes*

SCHEDULES

SCHEDULE 1

Sections 1 and 53.

EXISTING ENACTMENTS WHICH ARE RELEVANT STATUTORY PROVISIONS

Modifications etc. (not altering text)

C825 Sch. 1 amended (E.W.S) (1.3.1996) by [1995 c. 45, s. 16\(1\)](#), [Sch. 4 para. 10\(1\)\(b\)\(3\)](#); [S.I. 1996/218, art. 2](#)

Chapter	Short title	Provisions which are relevant statutory provisions
1875 c. 17.	The Explosives Act 1875.	The whole Act except sections 30 to 32, 80 and 116 to 121.
1882 c. 22.	The Boiler Explosions Act 1882.	The whole Act.
1890 c. 35.	The Boiler Explosions Act 1890.	The whole Act.
1906 c. 14.	The Alkali, &c. Works Regulation Act 1906.	The whole Act.
1909 c. 43.	The Revenue Act 1909.	Section 11.
F286	F286	F286
...
1920 c. 65.	The Employment of Women, Young Persons and Children Act 1920.	The whole Act.
[^{F287} 1922 c. 35.]	The Celluloid and Cinematograph Film Act 1922.	The whole Act.
F288	F288	F288
...
1926 c. 43.	The Public Health (Smoke Abatement) Act 1926.	The whole Act.
1928 c. 32.	The Petroleum (Consolidation) Act 1928.	The whole Act.
1936 c. 22.	The Hours of Employment (Conventions) Act 1936.	The whole Act except section 5.

Changes to legislation: *Health and Safety at Work etc. Act 1974 is up to date with all changes known to be in force on or before 28 April 2021. There are changes that may be brought into force at a future date. Changes that have been made appear in the content and are referenced with annotations. (See end of Document for details) View outstanding changes*

1936 c. 27.	The Petroleum (Transfer of Licences) Act 1936.	The whole Act.
1937 c. 45.	The Hydrogen Cyanide (Fumigation) Act 1937.	The whole Act.
1945 c. 19.	The Ministry of Fuel and Power Act 1945.	Section 1(1) so far as it relates to maintaining and improving the safety, health and welfare of persons employed in or about mines and quarries in Great Britain.
1946 c. 59.	The Coal Industry Nationalisation Act 1946.	Section 42(1) and (2).
1948 c. 37.	The Radioactive Substances Act 1948.	Section 5(1)(a).
1951 c. 21.	The Alkali, &c. Works Regulation (Scotland) Act 1951.	The whole Act.
F289	F289	F289
...
1952 c. 60.	The Agriculture (Poisonous Substances) Act 1952.	The whole Act.
F290	F290	F290
...
...
F291	F291	F291
1954 c. 70.	The Mines and Quarries Act 1954.	The whole Act except section 151.
1956 c. 49.	The Agriculture (Safety, Health and Welfare Provisions) Act 1956.	The whole Act.
1961 c. 34.	The Factories Act 1961.	The whole Act except section 135.
1961 c. 64.	The Public Health Act 1961.	Section 73.
1962 c. 58.	The Pipe-lines Act 1962.	Sections 20 to 26, 33, 34 and 42, Schedule 5.
1963 c. 41.	The Offices, Shops and Railway Premises Act 1963.	The whole Act.
F292	F292	F292
...
F293	F293	F293
...
1971 c. 20.	The Mines Management Act 1971.	The whole Act.

Changes to legislation: Health and Safety at Work etc. Act 1974 is up to date with all changes known to be in force on or before 28 April 2021. There are changes that may be brought into force at a future date. Changes that have been made appear in the content and are referenced with annotations. (See end of Document for details) View outstanding changes

1972 c. 28.	The Employment Medical Advisory Service Act 1972.	The whole Act except sections 1 and 6 and Schedule 1.
-------------	--	---

Textual Amendments

- F286** Sch. 1: "reference to the Anthrax Prevention Act 1919" repealed (6.4.2005) by [The Anthrax Prevention Order 1971 etc. \(Revocation\) Regulations 2005 \(S.I. 2005/228\)](#), [art. 2\(2\)](#)
- F287** Words in Sch. 1 repealed (6.4.2013) by [The Health and Safety \(Miscellaneous Repeals, Revocations and Amendments\) Regulations 2013 \(S.I. 2013/448\)](#), [reg. 1](#), [Sch. Table 3](#)
- F288** Sch. 1: entry repealed (26.4.2005) by [The Manufacture and Storage of Explosives Regulations 2005 \(S.I. 2005/1082\)](#), [reg. 28\(1\)\(2\)](#), [Sch. 5 para. 14](#), [Sch. 6 Pt. 1](#)
- F289** Sch. 1: entry repealed (26.4.2005) by [The Manufacture and Storage of Explosives Regulations 2005 \(S.I. 2005/1082\)](#), [reg. 28\(1\)\(2\)](#), [Sch. 5 para. 14](#), [Sch. 6 Pt. 1](#)
- F290** Sch. 1: entry repealed (26.4.2005) by [The Manufacture and Storage of Explosives Regulations 2005 \(S.I. 2005/1082\)](#), [reg. 28\(1\)\(2\)](#), [Sch. 5 para. 14](#), [Sch. 6 Pt. 1](#)
- F291** Entry inserted by [Sex Discrimination Act 1975 \(c. 65\)](#), [Sch. 5 para. 3](#) and repealed by [Sex Discrimination Act 1986 \(c. 59, SIF 106:1\)](#), [s. 9\(2\)](#), [Sch. Pt. III](#)
- F292** Words in Sch. 1 omitted (1.4.2014) by virtue of [Energy Act 2013 \(c. 32\)](#), [s. 156\(1\)](#), [Sch. 12 para. 14](#); [S.I. 2014/251](#), [art. 4](#)
- F293** Words in Sch. 1 repealed (6.4.2015) by [The Mines Regulations 2014 \(S.I. 2014/3248\)](#), [reg. 1\(2\)](#), [Sch. 3 Pt. 1](#) (with [reg. 1\(3\)](#))

[^{F294}SCHEDULE 2

ADDITIONAL PROVISIONS RELATING TO THE CONSTITUTION ETC. OF THE HEALTH AND SAFETY EXECUTIVE

Textual Amendments

- F294** Sch. 2 substituted (1.4.2008) by [The Legislative Reform \(Health and Safety Executive\) Order 2008 \(S.I. 2008/960\)](#), [art. 20](#), [Sch. 1](#) (with [art. 21](#), [Sch. 2](#))

Section 10

THE HEALTH AND SAFETY EXECUTIVE

- 1 The Executive shall consist of—
- the Chair of the Executive, and
 - at least seven and no more than [^{F295}twelve] other members (referred to in this Schedule as “members”).

Textual Amendments

- F295** Word in [Sch. 2 para. 1\(b\)](#) substituted (1.4.2014) by [Energy Act 2013 \(c. 32\)](#), [s. 156\(1\)](#), [Sch. 12 para. 15\(2\)](#); [S.I. 2014/251](#), [art. 4](#)

Changes to legislation: Health and Safety at Work etc. Act 1974 is up to date with all changes known to be in force on or before 28 April 2021. There are changes that may be brought into force at a future date. Changes that have been made appear in the content and are referenced with annotations. (See end of Document for details) View outstanding changes

- 2 (1) The Secretary of State shall appoint the Chair of the Executive.
- (2) ^{F296}Subject to sub-paragraph (3A),]The Secretary of State shall appoint the other members of the Executive according to sub-paragraph (3).
- (3) The Secretary of State—
- (a) shall appoint three members after consulting such organisations representing employers as he considers appropriate;
 - (b) shall appoint three members after consulting such organisations representing employees as he considers appropriate;
 - (c) shall appoint one member after consulting such organisations representing local authorities as he considers appropriate; and
 - (d) may appoint up to four other members after consulting, as he considers appropriate—
 - (i) the Scottish Ministers,
 - (ii) the Welsh Ministers, or
 - (iii) such organisations as he considers appropriate, including professional bodies, whose activities are concerned with matters relating to the general purposes of this Part.
- ^{F297}(3A) The Office for Nuclear Regulation may appoint a member from among the non-executive members of the Office for Nuclear Regulation (“an ONR member”).
- (3B) The Office for Nuclear Regulation must notify the Executive and the Secretary of State whenever it appoints an ONR member.]
- (4) Service as the Chair or as another member of the Executive is not service in the civil service of the State.
- (5) The Secretary of State, with the approval of the Chair, may appoint one of the other members appointed under sub-paragraph (2) to be the deputy chair of the Executive.

Textual Amendments

F296 Words in Sch. 2 para. 2(2) inserted (1.4.2014) by Energy Act 2013 (c. 32), s. 156(1), Sch. 12 para. 15(3); S.I. 2014/251, art. 4

F297 Sch. 2 para. 2(3A), (3B) inserted (1.4.2014) by Energy Act 2013 (c. 32), s. 156(1), Sch. 12 para. 15(4); S.I. 2014/251, art. 4

TERMS OF APPOINTMENT OF THE EXECUTIVE

- 3 Subject to paragraphs 4 ^{F298}, 4A]and 5, a person shall hold and vacate office as the Chair or as another member according to the terms of the instrument appointing him to that office.

Textual Amendments

F298 Word in Sch. 2 para. 3 inserted (1.4.2014) by Energy Act 2013 (c. 32), s. 156(1), Sch. 12 para. 15(5); S.I. 2014/251, art. 4

- 4 The Chair or any other member of the Executive ^{F299}, other than an ONR member,] may at any time resign his office by giving notice in writing to the Secretary of State.

Changes to legislation: *Health and Safety at Work etc. Act 1974 is up to date with all changes known to be in force on or before 28 April 2021. There are changes that may be brought into force at a future date. Changes that have been made appear in the content and are referenced with annotations. (See end of Document for details) View outstanding changes*

Textual Amendments

F299 Words in [Sch. 2 para. 4](#) inserted (1.4.2014) by [Energy Act 2013 \(c. 32\)](#), s. 156(1), [Sch. 12 para. 15\(6\)](#); [S.I. 2014/251](#), art. 4

- ^{F300}4A(1) An ONR member may at any time resign from office by giving notice in writing to the Office for Nuclear Regulation.
- (2) An ONR member ceases to be a member of the Executive upon ceasing to be a non-executive member of the Office for Nuclear Regulation.
- (3) The Office for Nuclear Regulation may remove an ONR member from office by giving notice in writing.
- (4) The Office for Nuclear Regulation must notify the Executive and the Secretary of State whenever an ONR member—
- resigns from office,
 - ceases to be a non-executive member of the Office for Nuclear Regulation, or
 - is removed from office.]

Textual Amendments

F300 [Sch. 2 para. 4A](#) inserted (1.4.2014) by [Energy Act 2013 \(c. 32\)](#), s. 156(1), [Sch. 12 para. 15\(7\)](#); [S.I. 2014/251](#), art. 4

- 5 The Secretary of State may remove a Chair or other member ^{F301}, other than an ONR member,]who—
- has been absent from meetings of the Executive for a period longer than six months without the permission of the Executive;
 - has become bankrupt or ^{F302}has had a debt relief order (under Part 7A of the Insolvency Act 1986) made in respect of him or] has made an arrangement with his creditors;
 - in Scotland, has had his estate sequestrated or has made a trust deed for creditors or a composition contract;
 - has become incapacitated by physical or mental illness; or
 - is otherwise, in the opinion of the Secretary of State, unable or unfit to carry out his functions.

Textual Amendments

F301 Words in [Sch. 2 para. 5](#) inserted (1.4.2014) by [Energy Act 2013 \(c. 32\)](#), s. 156(1), [Sch. 12 para. 15\(8\)](#); [S.I. 2014/251](#), art. 4

F302 Words in [Sch. 2 para. 5\(b\)](#) inserted (1.10.2012) by [The Tribunals, Courts and Enforcement Act 2007 \(Consequential Amendments\) Order 2012 \(S.I. 2012/2404\)](#), art. 1, [Sch. 2 para. 6](#) (with art. 5)

REMUNERATION OF MEMBERS

- 6 (1) The Executive shall pay ^{F303}—
- to each member, other than an ONR member, such remuneration, and
 - to each member such travelling and other allowances,

Changes to legislation: Health and Safety at Work etc. Act 1974 is up to date with all changes known to be in force on or before 28 April 2021. There are changes that may be brought into force at a future date. Changes that have been made appear in the content and are referenced with annotations. (See end of Document for details) View outstanding changes

as may be determined by the Secretary of State.]

- (2) The Executive shall pay to, or in respect of, any member [^{F304} other than an ONR member], such sums by way of pension, superannuation allowances and gratuities as the Secretary of State may determine.
- (3) Where a person ceases to be a member [^{F305} other than an ONR member] otherwise than on the expiry of his term of office, and the Secretary of State determines that there are special circumstances which make it right that he should receive compensation, the Executive shall pay to him such amount by way of compensation as the Secretary of State may determine.
- [^{F306}(4) Where—
- (a) a member appointed under paragraph 4(4)(a) of Schedule 7 to the Energy Act 2013 to be a member of the Office for Nuclear Regulation (the “ HSE member of the ONR”)—
- (i) ceases to be the HSE member of the ONR otherwise than on the expiry of his or her term of office as HSE member of the ONR, but
- (ii) does not cease to be a member of the Executive, and
- (b) it appears to the Executive that there are special circumstances that make it right for that person to receive compensation,
- the Executive may pay the member such amount by way of compensation as the Secretary of State may determine.]

Textual Amendments

- F303** Words in Sch. 2 para. 6(1) substituted (1.4.2014) by Energy Act 2013 (c. 32), s. 156(1), Sch. 12 para. 15(10); S.I. 2014/251, art. 4
- F304** Words in Sch. 2 para. 6(2) inserted (1.4.2014) by Energy Act 2013 (c. 32), s. 156(1), Sch. 12 para. 15(11); S.I. 2014/251, art. 4
- F305** Words in Sch. 2 para. 6(3) inserted (1.4.2014) by Energy Act 2013 (c. 32), s. 156(1), Sch. 12 para. 15(12); S.I. 2014/251, art. 4
- F306** Sch. 2 para. 6(4) inserted (10.3.2014) by Energy Act 2013 (c. 32), s. 156(1), Sch. 12 para. 15(13); S.I. 2014/251, art. 3(f)(i)

PROCEEDINGS OF THE EXECUTIVE

- 7 (1) The Executive may regulate its own procedure.
- (2) The validity of any proceedings of the Executive shall not be affected by any vacancy among the members or by any defect in the appointment of a member.
- (3) The Executive shall consult with the Secretary of State before making or revising its rules and procedures for dealing with conflicts of interest.
- (4) The Executive shall from time to time publish a summary of its rules and procedures.

STAFF

- 8 (1) The Executive shall, with the consent of the Secretary of State, appoint a person to act as Chief Executive on such terms and conditions as the Secretary of State may determine.

Changes to legislation: *Health and Safety at Work etc. Act 1974 is up to date with all changes known to be in force on or before 28 April 2021. There are changes that may be brought into force at a future date. Changes that have been made appear in the content and are referenced with annotations. (See end of Document for details) View outstanding changes*

- (2) The Executive shall appoint such other staff to the service of the Executive as it may determine, with the consent of the Secretary of State as to numbers of persons appointed and as to the terms and conditions of their service.
- (3) The Executive shall pay to the Minister for the Civil Service at such times as that Minister may direct, such sums as the Minister may determine in respect of any increase attributable to this paragraph in the sums payable out of monies provided by Parliament under the Superannuation Act 1972.
- (4) A person appointed to the staff of the Executive may not at the same time be a member of the Executive.
- (5) Service as a member of staff of the Executive is service in the civil service of the State.

PERFORMANCE OF FUNCTIONS

- 9 (1) Subject to sub-paragraphs (2) to (4), anything authorised or required to be done by the Executive (including exercising the powers under this paragraph) may be done by—
 - (a) such members of the Executive or members of staff of the Executive as the Executive considers fit to authorise for that purpose, whether generally or specifically; or
 - (b) any committee of the Executive which has been so authorised.
- (2) Sub-paragraph (1)(b) does not apply to a committee whose members include a person who is neither a member of the Executive nor a member of staff of the Executive.
- (3) The Executive—
 - (a) shall authorise such of its members of staff as it considers fit to authorise for that purpose, to perform on its behalf those of its functions which consist of the enforcement of the relevant statutory provisions in any particular case; but
 - (b) shall not authorise any member or committee of the Executive to make decisions concerning the enforcement of the relevant statutory provisions in any particular case.
- (4) The Executive shall not authorise any person to legislate by subordinate instrument.
- (5) The Executive shall publish any authorisations which it makes under this paragraph.

ACCOUNTS AND REPORTS

- 10 (1) It shall be the duty of the Chief Executive—
 - (a) to keep proper accounts and proper records in relation to the accounts;
 - (b) to prepare in respect of each accounting year a statement of accounts in such form as the Secretary of State may direct with the approval of the Treasury; and
 - (c) to send copies of the statement to the Secretary of State and the Comptroller and Auditor General before the end of November next following the accounting year to which the statement relates.
- (2) The Comptroller and the Auditor General shall examine, certify and report on each statement referred to in sub-paragraph (1)(c) and shall lay copies of each statement and his report before each House of Parliament.

Changes to legislation: Health and Safety at Work etc. Act 1974 is up to date with all changes known to be in force on or before 28 April 2021. There are changes that may be brought into force at a future date. Changes that have been made appear in the content and are referenced with annotations. (See end of Document for details) View outstanding changes

- (3) As soon as possible after the end of the accounting year, the Executive shall make to the Secretary of State a report on the performance of the Executive's functions during the year.
- (4) The Secretary of State shall lay the report referred to in sub-paragraph (3) before each House of Parliament.
- (5) In this paragraph, “accounting year” means the period of 12 months ending with 31st March in any year; but the first accounting year of the Executive shall, if the Secretary of State so directs, be of such other period not exceeding 2 years as may be specified in the direction.

SUPPLEMENTAL

- 11 The Secretary of State shall not make any determination or give his consent under paragraph 6 or 8 of this Schedule except with the approval of the Minister for the Civil Service.
- 12 (1) The fixing of the common seal of the Executive shall be authenticated by the signature of the Chair or some other person authorised by the Executive to act for that purpose.
- (2) A document purporting to be duly executed under the seal of the Executive shall be received in evidence and shall be deemed to be so executed unless the contrary is proved.
- (3) This paragraph does not apply to Scotland.]

SCHEDULE 3

Section 15.

SUBJECT-MATTER OF HEALTH AND SAFETY REGULATIONS

- 1 (1) Regulating or prohibiting—
 - (a) the manufacture, supply or use of any plant;
 - (b) the manufacture, supply, keeping or use of any substance;
 - (c) the carrying on of any process or the carrying out of any operation.
- (2) Imposing requirements with respect to the design, construction, guarding, siting, installation, commissioning, examination, repair, maintenance, alteration, adjustment, dismantling, testing or inspection of any plant.
- (3) Imposing requirements with respect to the marking of any plant or of any articles used or designed for use as components in any plant, and in that connection regulating or restricting the use of specified markings.
- (4) Imposing requirements with respect to the testing, labelling or examination of any substance.
- (5) Imposing requirements with respect to the carrying out of research in connection with any activity mentioned in subparagraphs (1) to (4) above.
- 2 (1) Prohibiting the importation into the United Kingdom or the landing or unloading there of articles or substances of any specified description, whether absolutely or unless conditions imposed by or under the regulations are complied with.

Changes to legislation: *Health and Safety at Work etc. Act 1974 is up to date with all changes known to be in force on or before 28 April 2021. There are changes that may be brought into force at a future date. Changes that have been made appear in the content and are referenced with annotations. (See end of Document for details) View outstanding changes*

- (2) Specifying, in a case where an act or omission in relation to such an importation, landing or unloading as is mentioned in the preceding sub-paragraph constitutes an offence under a provision of this Act and of [F307 the Customs and Excise Acts 1979] the Act under which the offence is to be punished.

Textual Amendments

F307 Words substituted by [Customs and Excise Management Act 1979 \(c. 2\)](#), [Sch. 4 para. 12](#) Table Pt. I

- 3 (1) Prohibiting or regulating the transport of articles or substances of any specified description.
- (2) Imposing requirements with respect to the manner and means of transporting articles or substances of any specified description, including requirements with respect to the construction, testing and marking of containers and means of transport and the packaging and labelling of articles or substances in connection with their transport.
- 4 (1) Prohibiting the carrying on of any specified activity or the doing of any specified thing except under the authority and in accordance with the terms and conditions of a licence, or except with the consent or approval of a specified authority.
- (2) Providing for the grant, renewal, variation, transfer and revocation of licences (including the variation and revocation of conditions attached to licences).
- 5 Requiring any person, premises or thing to be registered in any specified circumstances or as a condition of the carrying on of any specified activity or the doing of any specified thing.
- 6 (1) Requiring, in specified circumstances, the appointment (whether in a specified capacity or not) of persons (or persons with specified qualifications or experience, or both) to perform specified functions, and imposing duties or conferring powers on persons appointed (whether in pursuance of the regulations or not) to perform specified functions.
- (2) Restricting the performance of specified functions to persons possessing specified qualifications or experience.
- 7 Regulating or prohibiting the employment in specified circumstances of all persons or any class of persons.
- 8 (1) Requiring the making of arrangements for securing the health of persons at work or other persons, including arrangements for medical examinations and health surveys.
- (2) Requiring the making of arrangements for monitoring the atmospheric or other conditions in which persons work.
- 9 Imposing requirements with respect to any matter affecting the conditions in which persons work, including in particular such matters as the structural condition and stability of premises, the means of access to and egress from premises, cleanliness, temperature, lighting, ventilation, overcrowding, noise, vibrations, ionising and other radiations, dust and fumes.
- 10 Securing the provision of specified welfare facilities for persons at work, including in particular such things as an adequate water supply, sanitary conveniences, washing and bathing facilities, ambulance and first-aid arrangements, cloakroom accommodation, sitting facilities and refreshment facilities.

Changes to legislation: *Health and Safety at Work etc. Act 1974 is up to date with all changes known to be in force on or before 28 April 2021. There are changes that may be brought into force at a future date. Changes that have been made appear in the content and are referenced with annotations. (See end of Document for details) View outstanding changes*

- 11 Imposing requirements with respect to the provision and use in specified circumstances of protective clothing or equipment, including clothing affording protection against the weather.
- 12 Requiring in specified circumstances the taking of specified precautions in connection with the risk of fire.
- 13 (1) Prohibiting or imposing requirements in connection with the emission into the atmosphere of any specified gas, smoke or dust or any other specified substance whatsoever.
- (2) Prohibiting or imposing requirements in connection with the emission of noise, vibrations or any ionising or other radiations.
- (3) Imposing requirements with respect to the monitoring of any such emission as is mentioned in the preceding sub-paragraphs.
- 14 Imposing requirements with respect to the instruction, training and supervision of persons at work.
- 15 (1) Requiring in specified circumstances, specified matters to be notified in a specified manner to specified persons.
- (2) Empowering inspectors in specified circumstances to require persons to submit written particulars of measures proposed to be taken to achieve compliance with any of the relevant statutory provisions.
- 16 Imposing requirements with respect to the keeping and preservation of records and other documents, including plans and maps.
- 17 Imposing requirements with respect to the management of animals.
- 18 The following purposes as regards premises of any specified description where persons work, namely—
- (a) requiring precautions to be taken against dangers to which the premises or persons therein are or may be exposed by reason of conditions (including natural conditions) existing in the vicinity;
- (b) securing that persons in the premises leave them in specified circumstances.
- 19 Conferring, in specified circumstances involving a risk of fire or explosion, power to search a person or any article which a person has with him for the purpose of ascertaining whether he has in his possession any article of a specified kind likely in those circumstances to cause a fire or explosion, and power to seize and dispose of any article of that kind found on such a search.
- 20 Restricting, prohibiting or requiring the doing of any specified thing where any accident or other occurrence of a specified kind has occurred.
- 21 As regards cases of any specified class, being a class such that the variety in the circumstances of particular cases within it calls for the making of special provision for particular cases, any of the following purposes, namely—
- (a) conferring on employers or other persons power to make rules or give directions with respect to matters affecting health or safety;
- (b) requiring employers or other persons to make rules with respect to any such matters;
- (c) empowering specified persons to require employers or other persons either to make rules with respect to any such matters or to modify any such rules previously made by virtue of this paragraph; and

Changes to legislation: *Health and Safety at Work etc. Act 1974 is up to date with all changes known to be in force on or before 28 April 2021. There are changes that may be brought into force at a future date. Changes that have been made appear in the content and are referenced with annotations. (See end of Document for details) View outstanding changes*

- (d) making admissible in evidence without further proof, in such circumstances and subject to such conditions as may be specified, documents which purport to be copies of rules or rules of any specified class made under this paragraph.
- 22 Conferring on any local or public authority power to make byelaws with respect to any specified matter, specifying the authority or person by whom any byelaws made in the exercise of that power need to be confirmed, and generally providing for the procedure to be followed in connection with the making of any such byelaws.

Interpretation

- 23 (1) In this Schedule “specified” means specified in health and safety regulations.
- (2) It is hereby declared that the mention in this Schedule of a purpose that falls within any more general purpose mentioned therein is without prejudice to the generality of the more general purpose.

[^{F308}SCHEDULE 3A

OFFENCES: MODE OF TRIAL AND MAXIMUM PENALTY

Textual Amendments

F308 Sch. 3A inserted (16.1.2009) by [Health and Safety \(Offences\) Act 2008 \(c. 20\)](#), ss. 1(2), 3(2), [Sch. 1](#) (with s. 3(3))

Modifications etc. (not altering text)

C826 Sch. 3A applied (with modifications) (E.W.S.) (1.10.2014) by [The Explosives Regulations 2014 \(S.I. 2014/1638\)](#), reg. 1(1), [Sch. 12 paras. 2, 3](#)

C827 Sch. 3A applied (with modifications) by S.I. 2014/1638, Sch. 12 paras. 5-7 (as substituted (E.W.S.) (20.4.2016) by [The Explosives Regulations 2014 \(Amendment\) Regulations 2016 \(S.I. 2016/315\)](#), reg. 1, [Sch. 1](#) (with regs. 2(1), 15))

C828 Sch. 3A applied (with modifications) (30.7.2018) by [The Cableway Installations Regulations 2018 \(S.I. 2018/816\)](#), regs. 1, [21\(1\)-\(3\)](#) (with reg. 4)

- 1 The mode of trial and maximum penalty applicable to each offence listed in the first column of the following table are as set out opposite that offence in the subsequent columns of the table.

<i>Offence</i>	<i>Mode of trial</i>	<i>Penalty on summary conviction</i>	<i>Penalty on conviction on indictment</i>
An offence under section 33(1) (a) consisting of a failure to discharge a duty to which a person is	Summarily or on indictment.	Imprisonment for a term not exceeding 12 months, or a [^{F309} fine], or both.	Imprisonment for a term not exceeding two years, or a fine, or both.

Changes to legislation: *Health and Safety at Work etc. Act 1974 is up to date with all changes known to be in force on or before 28 April 2021. There are changes that may be brought into force at a future date. Changes that have been made appear in the content and are referenced with annotations. (See end of Document for details) View outstanding changes*

subject by virtue of sections 2 to 6.

An offence under section 33(1)(a) consisting of a failure to discharge a duty to which a person is subject by virtue of section 7.	Summarily or on indictment.	Imprisonment for a term not exceeding 12 months, or a [^{F310} fine], or both.	Imprisonment for a term not exceeding two years, or a fine, or both.
An offence under section 33(1)(b) consisting of a contravention of section 8.	Summarily or on indictment.	Imprisonment for a term not exceeding 12 months, or a [^{F309} fine], or both.	Imprisonment for a term not exceeding two years, or a fine, or both.
An offence under section 33(1)(b) consisting of a contravention of section 9.	Summarily or on indictment.	A [^{F309} fine].	A fine.
An offence under section 33(1)(c).	Summarily or on indictment.	Imprisonment for a term not exceeding 12 months, or a [^{F309} fine], or both.	Imprisonment for a term not exceeding two years, or a fine, or both.
An offence under section 33(1)(d).	Summarily only.	A [^{F311} fine].	
An offence under section 33(1)(e), (f) or (g).	Summarily or on indictment.	Imprisonment for a term not exceeding 12 months, or a [^{F309} fine], or both.	Imprisonment for a term not exceeding two years, or a fine, or both.
An offence under section 33(1)(h).	Summarily only.	Imprisonment for a term not exceeding 51 weeks (in England and Wales) or 12 months (in Scotland), or a [^{F311} fine], or both.	
An offence under section 33(1)(i).	Summarily or on indictment.	A [^{F310} fine].	A fine.
An offence under section 33(1)(j).	Summarily or on indictment.	Imprisonment for a term not exceeding 12 months, or a [^{F310} fine], or both.	Imprisonment for a term not exceeding two years, or a fine, or both.
An offence under section 33(1)(k), (l) or (m).	Summarily or on indictment.	Imprisonment for a term not exceeding	Imprisonment for a term not exceeding

Changes to legislation: *Health and Safety at Work etc. Act 1974 is up to date with all changes known to be in force on or before 28 April 2021. There are changes that may be brought into force at a future date. Changes that have been made appear in the content and are referenced with annotations. (See end of Document for details) View outstanding changes*

		12 months, or a [^{F309} fine], or both.	two years, or a fine, or both.
An offence under section 33(1)(n).	Summarily only.	A [^{F311} fine].	
An offence under section 33(1)(o).	Summarily or on indictment.	Imprisonment for a term not exceeding 12 months, or a [^{F309} fine], or both.	Imprisonment for a term not exceeding two years, or a fine, or both.
An offence under the existing statutory provisions for which no other penalty is specified.	Summarily or on indictment.	Imprisonment for a term not exceeding 12 months, or a [^{F309} fine], or both.	Imprisonment for a term not exceeding two years, or a fine, or both.

Textual Amendments

- F309** Words in Sch. 3A para. 1 substituted (E.W.) (12.3.2015) by [The Legal Aid, Sentencing and Punishment of Offenders Act 2012 \(Fines on Summary Conviction\) Regulations 2015 \(S.I. 2015/664\)](#), reg. 1(1), [Sch. 4 para. 7\(a\)](#) (with reg. 5(1))
- F310** Words in Sch. 3A para. 1 substituted (E.W.) (12.3.2015) by [The Legal Aid, Sentencing and Punishment of Offenders Act 2012 \(Fines on Summary Conviction\) Regulations 2015 \(S.I. 2015/664\)](#), reg. 1(1), [Sch. 4 para. 7\(b\)](#) (with reg. 5(1))
- F311** Words in Sch. 3A para. 1 substituted (E.W.) (12.3.2015) by [The Legal Aid, Sentencing and Punishment of Offenders Act 2012 \(Fines on Summary Conviction\) Regulations 2015 \(S.I. 2015/664\)](#), reg. 1(1), [Sch. 4 para. 7\(c\)](#) (with reg. 5(1))

- 2 (1) This paragraph makes transitional modifications of the table as it applies to England and Wales.
- (2) In relation to an offence committed before the commencement of [^{F312}paragraph 24(2) of Schedule 22 to the Sentencing Act 2020] (general limit on magistrates' court's powers to imprison), a reference to imprisonment for a term not exceeding 12 months is to be read as a reference to imprisonment for a term not exceeding six months.
- (3) In relation to an offence committed before the commencement of section 281(5) of that Act (alteration of penalties for summary offences), a reference to imprisonment for a term not exceeding 51 weeks is to be read as a reference to imprisonment for a term not exceeding six months.]

Textual Amendments

- F312** Words in [Sch. 3A para. 2\(2\)](#) substituted (1.12.2020) by [Sentencing Act 2020 \(c. 17\)](#), s. 416(1), [Sch. 24 para. 443\(1\)](#) (with [Sch. 24 para. 447](#), [Sch. 27](#)); S.I. 2020/1236, reg. 2

Changes to legislation: *Health and Safety at Work etc. Act 1974 is up to date with all changes known to be in force on or before 28 April 2021. There are changes that may be brought into force at a future date. Changes that have been made appear in the content and are referenced with annotations. (See end of Document for details) View outstanding changes*

F313 SCHEDULE 4

Textual Amendments

F313 Sch. 4 repealed by [Employment Protection Act 1975 \(c. 71\)](#), **Sch. 18**

F314 SCHEDULE 5

Textual Amendments

F314 Ss. 61, 62, 63(5)(6)(7), 64–69, 70(2)–(8), 71–74, 76, Sch. 5 and Sch. 6 repealed by [Building Act 1984 \(c. 55, SIF 15\)](#), s. 133(2), **Sch. 7**

F315 SCHEDULE 6

Textual Amendments

F315 Ss. 61, 62, 63(5)(6)(7), 64–69, 70(2)–(8), 71–74, 76, Sch. 5 and Sch. 6 repealed by [Building Act 1984 \(c. 55, SIF 15\)](#), s. 133(2), **Sch. 7**

F316F316X3 SCHEDULE 7

Editorial Information

X3 The text of ss. 75, 77, 78(1)–(3)(5)–(9), 83, Sch. 7, Sch. 9 para. 1, and Sch. 10 is in the form in which it was originally enacted: it was not reproduced in Statutes in Force and, except as specified, does not reflect any amendments or repeals which may have been made prior to 1.2.1991

Textual Amendments

F316 Sch. 7 repealed (S.) (1.5.2005) by [Building \(Scotland\) Act 2003 \(asp 8\)](#), s. 58, **Sch. 6 para. 9**, S.S.I. 2004/404, **arts. 2(1)**, 3, 4

Changes to legislation: *Health and Safety at Work etc. Act 1974 is up to date with all changes known to be in force on or before 28 April 2021. There are changes that may be brought into force at a future date. Changes that have been made appear in the content and are referenced with annotations. (See end of Document for details) View outstanding changes*

[^{F317}SCHEDULE 8]

Section 78.

TRANSITIONAL PROVISIONS WITH RESPECT TO FIRE CERTIFICATES UNDER
FACTORIES ACT 1961^{M25} OR OFFICES, SHOPS AND RAILWAY PREMISES ACT 1963^{M26}**Textual Amendments**

F317 Sch. 8 repealed (E.W.) (1.10.2006) by [The Regulatory Reform \(Fire Safety\) Order 2005 \(S.I. 2005/1541\)](#), art. 53(2), **Sch. 4** (with art. 49) (as amended by [The Regulatory Reform \(Fire Safety\) Subordinate Provisions Order 2006 \(S.I. 2006/484\)](#), **arts. 1(1), 2**); and Sch. 8 repealed (S.) (1.10.2006) by [The Fire \(Scotland\) Act 2005 \(Consequential Modifications and Savings\) Order 2006 \(S.S.I. 2006/475\)](#), art. 2(2), **Sch. 2**

Marginal Citations

M25 1961 c. 34.

M26 1963 c. 41.

[^{F318}1 In this Schedule—

“the 1971 Act” means the ^{M27}Fire Precautions Act 1971;

“1971 Act certificate” means a fire certificate within the meaning of the 1971 Act;

“Factories Act certificate” means a certificate under section 40 of the ^{M28}Factories Act 1961 (means of escape in case of fire-certification by fire authority);

“Offices Act certificate” means a fire certificate under section 29 of the ^{M29}Offices, Shops and Railway Premises Act 1963.]

Textual Amendments

F318 Sch. 8 repealed (E.W.) (1.10.2006) by [The Regulatory Reform \(Fire Safety\) Order 2005 \(S.I. 2005/1541\)](#), art. 53(2), **Sch. 4** (with art. 49) (as amended by [The Regulatory Reform \(Fire Safety\) Subordinate Provisions Order 2006 \(S.I. 2006/484\)](#), **arts. 1(1), 2**); and Sch. 8 repealed (S.) (1.10.2006) by [The Fire \(Scotland\) Act 2005 \(Consequential Modifications and Savings\) Order 2006 \(S.S.I. 2006/475\)](#), art. 2(2), **Sch. 2**

Marginal Citations

M27 1971 c. 40.

M28 1961 c. 34.

M29 1963 c. 41.

[^{F319}2 (1) Where by virtue of an order under section 1 of the 1971 Act a 1971 Act certificate becomes required in respect of any premises at a time when there is in force in respect of those premises a Factories Act certificate or an Offices Act certificate (“the existing certificate”), the following provisions of this paragraph shall apply.

(2) The existing certificate shall continue in force (irrespective of whether the section under which it was issued remains in force) and—

(a) shall as from the said time be deemed to be a 1971 Act certificate validly issued with respect to the premises with respect to which it was issued and to cover the use or uses to which those premises were being put at that time; and

Changes to legislation: Health and Safety at Work etc. Act 1974 is up to date with all changes known to be in force on or before 28 April 2021. There are changes that may be brought into force at a future date. Changes that have been made appear in the content and are referenced with annotations. (See end of Document for details) View outstanding changes

- (b) may (in particular) be amended, replaced or revoked in accordance with the 1971 Act accordingly.

(3) Without prejudice to sub-paragraph (2)(b) above, the existing certificate, as it has effect by virtue of sub-paragraph (2) above, shall as from the said time be treated as imposing in relation to the premises the like requirements as were previously imposed in relation thereto by the following provisions, that is to say—

- (a) if the existing certificate is a Factories Act certificate, the following provision of the Factories Act 1961, namely sections 41(1), 48 (except subsections (5), (8) and (9)), 49(1), 51(1) and 52(1) and (4) and, so far as it relates to a proposed increase in the number of persons employed in any premises, section 41(3);
- (b) if the existing certificate is an Offices Act certificate the following provisions of the Offices, Shops and Railway Premises Act 1963, namely section 30(1), 33, 34(1) and (2), 36(1) and 38(1) and, so far as it relates to a proposed increase in the number of persons employed to work in any premises at any one time, section 30(3).]

Textual Amendments

F319 Sch. 8 repealed (E.W.) (1.10.2006) by [The Regulatory Reform \(Fire Safety\) Order 2005 \(S.I. 2005/1541\)](#), art. 53(2), [Sch. 4](#) (with art. 49) (as amended by [The Regulatory Reform \(Fire Safety\) Subordinate Provisions Order 2006 \(S.I. 2006/484\)](#), [arts. 1\(1\)](#), 2); and Sch. 8 repealed (S.) (1.10.2006) by [The Fire \(Scotland\) Act 2005 \(Consequential Modifications and Savings\) Order 2006 \(S.S.I. 2006/475\)](#), art. 2(2), [Sch. 2](#)

F320

Textual Amendments

F320 Sch. 8 para. 3 repealed (5.11.1993) by [1993 c. 50, s. 1\(1\)](#), [Sch. 1 Pt. XVI](#) Group1.

F321 SCHEDULE 9

Textual Amendments

F321 [Sch. 9](#) repealed (5.11.1993) by [1993 c. 50, s. 1\(1\)](#), [Sch. 1 Pt. XVI](#) Group1.

F325 SCHEDULE 10

Textual Amendments

F325 [Sch. 10](#) repealed (5.11.1993) by [1993 c. 50, s. 1\(1\)](#), [Sch. 1 Pt. XVI](#) Group1.

SCCHEDULE 10

Document Generated: 2021-04-28

Changes to legislation: *Health and Safety at Work etc. Act 1974 is up to date with all changes known to be in force on or before 28 April 2021. There are changes that may be brought into force at a future date. Changes that have been made appear in the content and are referenced with annotations. (See end of Document for details) [View outstanding changes](#)*

.....

Changes to legislation:

Health and Safety at Work etc. Act 1974 is up to date with all changes known to be in force on or before 28 April 2021. There are changes that may be brought into force at a future date. Changes that have been made appear in the content and are referenced with annotations.

[View outstanding changes](#)

Changes and effects yet to be applied to :

- Pt. 1 modified by [2008 c. 32 s. 99\(1\)](#)
- Pt. 1 power to exclude conferred by [2014 c. 20 Sch. 1 para. 4\(1\)\(b\)\(c\)](#)
- Pt. 1 power to repeal or modify conferred by [2008 c. 32 s. 99\(2\)](#)
- s. 21-25 power to exclude conferred by [2014 c. 20 Sch. 1 para. 4\(1\)\(a\)](#)
- s. 51A(1) word substituted by [2002 c. 30 s. 95\(1\)\(a\)\(2\)](#) (This amendment not applied to legislation.gov.uk. S. 95 repealed (7.4.2005) without ever being in force by 2005 c. 15, ss. 158(4)(a), 174(2), 178(1), Sch. 17 Pt. 1)
- s. 51A(2)(2A) substituted for s. 51A(2) by [2002 c. 30 s. 95\(1\)\(a\)\(3\)](#) (This amendment not applied to legislation.gov.uk. S. 95 repealed (7.4.2005) without ever being in force by 2005 c. 15, ss. 158(4)(a), 174(2), 178(1), Sch. 17 Pt. 1)
- s. 51A(2B)-(2D) inserted by [2002 c. 30 s. 95\(4\)](#) (This amendment not applied to legislation.gov.uk. S. 95 repealed (7.4.2005) without ever being in force by 2005 c. 15, ss. 158(4)(a), 174(2), 178(1), Sch. 17 Pt. 1)
- s. 51A(3)(a) words substituted by [2002 c. 30 s. 95\(5\)](#) (This amendment not applied to legislation.gov.uk. S. 95 repealed (7.4.2005) without ever being in force by 2005 c. 15, ss. 158(4)(a), 174(2), 178(1), Sch. 17 Pt. 1)
- s. 51A(3)(b) words substituted by [2002 c. 30 s. 95\(5\)](#) (This amendment not applied to legislation.gov.uk. S. 95 repealed (7.4.2005) without ever being in force by 2005 c. 15, ss. 158(4)(a), 174(2), 178(1), Sch. 17 Pt. 1)
- s. 51A(3)(c) words substituted by [2002 c. 30 s. 95\(5\)](#) (This amendment not applied to legislation.gov.uk. S. 95 repealed (7.4.2005) without ever being in force by 2005 c. 15, ss. 158(4)(a), 174(2), 178(1), Sch. 17 Pt. 1)
- s. 51A(4) words substituted by [2002 c. 30 s. 95\(6\)](#) (This amendment not applied to legislation.gov.uk. S. 95 repealed (7.4.2005) without ever being in force by 2005 c. 15, ss. 158(4)(a), 174(2), 178(1), Sch. 17 Pt. 1)
- Sch. 1 words repealed by [2003 c. 22 Sch.](#)

APPENDIX B

The Electricity at Work Regulations 1989

The Electricity at Work Regulations 1989

Guidance on Regulations



HSR25 (Third edition)
Published 2015

This new edition of HSR25 will help dutyholders meet the requirements of the Electricity at Work Regulations 1989. It will be of interest and practical help to all dutyholders, particularly engineers (including those involved in the design, construction, operation or maintenance of electrical systems), technicians and their managers.

It sets out the Regulations and gives technical and legal guidance on them. The purpose of this guidance is to highlight the nature of the precautions in general terms to help dutyholders achieve high standards of electrical safety in compliance with the duties imposed.

This third edition removes reference to regulations 17–28 and Schedule 1, which applied only to mines and were revoked in April 2015 by the Mines Regulations 2014, and shows changes made to regulations 3 and 29. This document applies to all electrical systems and there is additional guidance for mines in *Electrical safety in mines* (HSE publication HSG278).

The publication also contains references to HSE guidance and codes of practice from other standards-making bodies and trade associations.

© *Crown copyright 2015*

First published 1989
Second edition 2007
Third edition 2015

ISBN 978 0 7176 6636 2

You may reuse this information (excluding logos) free of charge in any format or medium, under the terms of the Open Government Licence. To view the licence visit www.nationalarchives.gov.uk/doc/open-government-licence/, write to the Information Policy Team, The National Archives, Kew, London TW9 4DU, or email psi@nationalarchives.gsi.gov.uk.

Some images and illustrations may not be owned by the Crown so cannot be reproduced without permission of the copyright owner. Enquiries should be sent to copyright@hse.gsi.gov.uk.

Guidance

This guidance is issued by the Health and Safety Executive. Following the guidance is not compulsory, unless specifically stated, and you are free to take other action. But if you do follow the guidance you will normally be doing enough to comply with the law. Health and safety inspectors seek to secure compliance with the law and may refer to this guidance.

Contents

Introduction	5
The Regulations	7
Regulation 1	Citation and commencement 7
Regulation 2	Interpretation 7
Regulation 3	Persons on whom duties are imposed by these Regulations 13
Regulation 4	Systems, work activities and protective equipment 15
Regulation 5	Strength and capability of electrical equipment 18
Regulation 6	Adverse or hazardous environments 19
Regulation 7	Insulation, protection and placing of conductors 22
Regulation 8	Earthing or other suitable precautions 25
Regulation 9	Integrity of referenced conductors 29
Regulation 10	Connections 30
Regulation 11	Means for protecting from excess of current 31
Regulation 12	Means for cutting off the supply and for isolation 33
Regulation 13	Precautions for work on equipment made dead 35
Regulation 14	Work on or near live conductors 37
Regulation 15	Working space, access and lighting 41
Regulation 16	Persons to be competent to prevent danger and injury 42
Regulations 17–28	43
Regulation 29	Defence 43
Regulation 30	Exemption certificates 44
Regulation 31	Extension outside Great Britain 44
Regulation 32	Disapplication of duties 45
Regulation 33	Revocations and modifications 45
Appendix 1	46
References and further reading	48
Further information	52

Introduction

About this book

1 This book gives guidance on and sets out the Electricity at Work Regulations 1989. The guidance is relevant to all work activities and premises except certain offshore workplaces and certain ships. Additional guidance specific to mines is given in *Electrical safety in mines*.¹

2 The Electricity at Work Regulations 1989 (SI 1989/635) (as amended) (the Regulations) came into force on 1 April 1990. The purpose of the Regulations is to require precautions to be taken against the risk of death or personal injury from electricity in work activities. The text of the Regulations is available free to download from legislation.gov.uk or to purchase from The Stationery Office.

3 The Regulations are made under the Health and Safety at Work etc Act 1974 (the HSW Act).² The HSW Act applies principally to employers, the self-employed and to employees, including certain classes of trainees. Duties are imposed on people (referred to in this guidance as 'dutyholders') in respect of **systems, electrical equipment** and **conductors**, and in respect of work activities on or near electrical equipment. Words in bold (above and in extracts from the Regulations) are defined in regulation 2. The duties are in addition to those imposed by the HSW Act. The 1989 Regulations pre-date the risk assessment process brought in with the 1992 version of the Management of Health and Safety at Work Regulations. However, the risk assessment process is still required. Further information can be found in *Managing for health and safety*.³

What are the differences between this edition and the previous edition?

4 This third edition notes that regulations 17–28 and Schedule 1, which applied only to mines, were revoked in April 2015 by the Mines Regulations 2014. These Regulations also modified regulations 3 and 29.

Who should read this book?

5 The guidance is primarily for dutyholders (including those involved in the design, construction, operation or maintenance of electrical systems and equipment), engineers, technicians and their managers. It sets out the Regulations and gives technical and legal guidance on them. While it reflects the Health and Safety Executive's (HSE's) view of the meaning of terms used in the Regulations, only the Courts can provide a binding interpretation. The text of the Regulations is set out in *italics*, the accompanying guidance is in normal type. Coloured borders also indicate each section clearly.

Scope

6 This guidance applies to all operational voltages.

7 The Regulations apply to all **electrical systems and equipment** (as defined) whenever manufactured, purchased, installed or taken into use even if its manufacture or installation pre-dates the Regulations. Where electrical equipment pre-dates the Regulations this does not of itself mean that the continued use of the equipment would be in contravention of the Regulations. For example, some of the equipment to which the Regulations apply may have been made to a standard, such as a British Standard, which has since been modified or superseded. Standards such as BS 7671⁴ can provide assistance but, ultimately, compliance with the Regulations is required. It is likely to be reasonably practicable to replace it with equipment made to a more recent standard when, but only when, it becomes unsafe or falls due for replacement for other than safety reasons, whichever occurs sooner.

British Standard BS 7671 Requirements for Electrical Installations (also known as the IET Wiring Regulations)

8 *BS 7671 Requirements for electrical installations* is also known as the IET Wiring Regulations. They are non-statutory regulations which 'relate principally to the design, selection, erection, inspection and testing of electrical installations, whether permanent or temporary, in and about buildings generally and to agricultural and horticultural premises, construction sites and caravans and their sites'.

9 BS 7671 is a code of practice which is widely recognised and accepted in the UK and compliance with it is likely to achieve compliance with relevant aspects of the Electricity at Work Regulations 1989.

10 There are, however, many types of system, equipment and hazard to which BS 7671 is not applicable; for example, certain installations at mines and quarries, equipment on vehicles, systems for public electricity supply and explosion protection. Furthermore, BS 7671 applies only to installations operating at up to 1000 V ac or 1500 V dc.

11 Installations to which BS 7671 is relevant may have been installed in accordance with an earlier edition, now superseded but then current. That, in itself, would not mean that the installation would fail to comply with the Regulations.

Electricity Safety, Quality and Continuity Regulations

12 The Electricity Safety, Quality and Continuity Regulations 2002 (ESQCR)⁵ impose requirements in respect of the generation, distribution and supply of electricity, including supply networks and electrical equipment. The Department of Energy and Climate Change (DECC) leads on ESQCR matters, though HSE performs some functions on DECC's behalf, in particular with regards to public safety and incident notifications. Some ESQCR obligations – such as requirements for connection with earth – overlap with the Regulations, but others provide additional requirements.

The Regulations

Regulation 1 Citation and commencement

Regulation 1

These Regulations may be cited as the Electricity at Work Regulations 1989 and shall come into force on 1st April 1990.

Regulation 2 Interpretation

Regulation 2

(1) *In these Regulations, unless the context otherwise requires –*

*“circuit conductor” means any **conductor** in a **system** which is intended to carry electric current in normal conditions, or to be energised in normal conditions, and includes a combined neutral and earth conductor, but does not include a conductor provided solely to perform a protective function by connection to earth or other reference point;*

*“conductor” means a **conductor** of electrical energy;*

*“danger” means risk of **injury**;*

“electrical equipment” includes anything used, intended to be used or installed for use, to generate, provide, transmit, transform, rectify, convert, conduct, distribute, control, store, measure or use electrical energy;

“injury” means death or personal injury from electric shock, electric burn, electrical explosion or arcing, or from fire or explosion initiated by electrical energy, where any such death or injury is associated with the generation, provision, transmission, transformation, rectification, conversion, conduction, distribution, control, storage, measurement or use of electrical energy;

“system” means an electrical system in which all the electrical equipment is, or may be, electrically connected to a common source of electrical energy, and includes such source and such equipment.

Guidance 2

13 Words and phrases which are in **bold** type in the text of the regulation preceding the guidance are those which have been assigned a special meaning by being defined in regulation 2.

Systems

14 The term ‘system’ includes all parts of a system, eg conductors and electrical equipment in it, and is not a reference solely to the functional circuit as a whole. It follows that something required of a system is required both of the system as a whole and of the equipment and conductors in it.

Guidance

2

15 The definition refers to electrical systems. In the case of each system this will include all of the electrical equipment connected together and the various electrical energy sources in that system. In the case of transformers, even though there may be galvanic separation between the various windings of the transformers, where the energy is transmitted through these from one part of the electrical system to another, the transformer and all of its windings are part of the same system.

16 The definition of 'system' includes equipment which, although not energised, may be electrically connected to a common source of electrical energy. Equipment which is readily capable of being made live by a system is therefore considered to be part of that system. For example, a lighting circuit which has been disconnected from its source of electrical energy by means of removable links or fuses is still part of that system, as is such a circuit which has been switched off even though the switch might be a double pole switch.

17 Equipment which is in any way connected to a source of electrical energy, eg a test instrument containing a source and the equipment containing or connected to that source, becomes part of a system and the Regulations apply to that system. Electrical equipment which is not connected, and cannot be readily connected, to a source of electrical energy is not part of a system. Protective conductors, if they are connected to a source, are part of that system.

18 The reference in the definition to a common source of electrical energy does not exclude systems fed by several generators or transformers. The word 'common' is included in the definition so that completely independent electrical installations are regarded as separate systems. If, however, they are electrically connected in any way they are part of the same system for the purposes of the Regulations. This may mean that the system may be an extensive electrical network covering large geographical areas over which several or even many people have control of various parts. The Regulations place duties on these people only in respect of those provisions of the Regulations which relate to matters which are within their control (see regulation 3).

19 Self-contained portable systems, such as portable generating sets, are electrical systems for the purpose of the Regulations, as are transportable systems and systems on vehicles etc.

Electrical equipment

20 'Electrical equipment' as defined in the Regulations includes every type of electrical equipment from, for example, a high-voltage transmission overhead line to a battery-powered hand lamp. There are no voltage limits in the Regulations; the criteria are whether danger (as defined) may arise. It is appropriate for the Regulations to apply even at the very lowest end of the voltage or power spectrum because the Regulations are concerned with, for example, explosion risks, which may be caused by very low levels of energy igniting flammable gases even though there may be no risk of electric shock or burn.

21 Electrical equipment (as defined) includes conductors used to distribute electrical energy such as cables, wires and leads and those used in the transmission at high voltage of bulk electrical energy, as in the national grid.

Conductors

22 Regulation 2 defines a conductor as 'a conductor of electrical energy'. This means any material which is capable of conducting electricity (electricity is synonymous with electrical energy) and therefore includes both metals and all other

Guidance 2

conducting materials. The definition is not limited to conductors intended to carry current and so includes, for example, metal structures, salt water, ionised gases and conducting particles. The conductance of most materials varies with parameters such as temperature, eg glass is conducting when molten (and is then a conductor, as defined) whereas in its normal, solid, state it is a good insulator and finds many applications as such. For the purposes of the Regulations, while such materials conduct electricity, they are 'conductors'.

Figure 1 Types of conductor

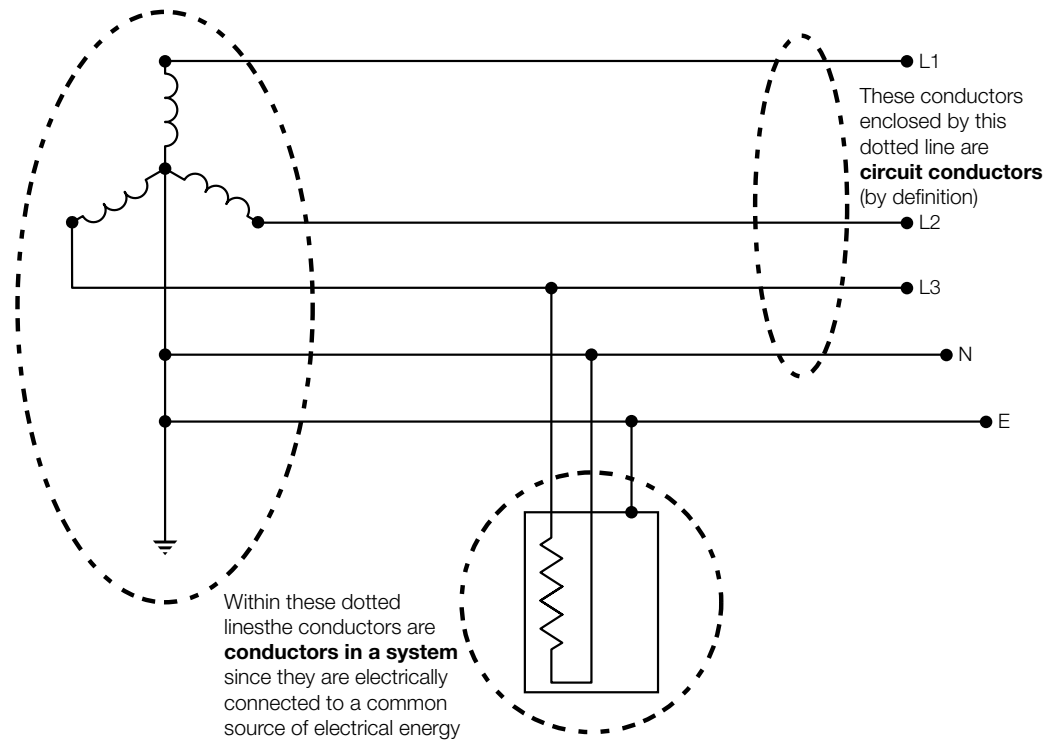

3 Phase system – separate neutral and earth

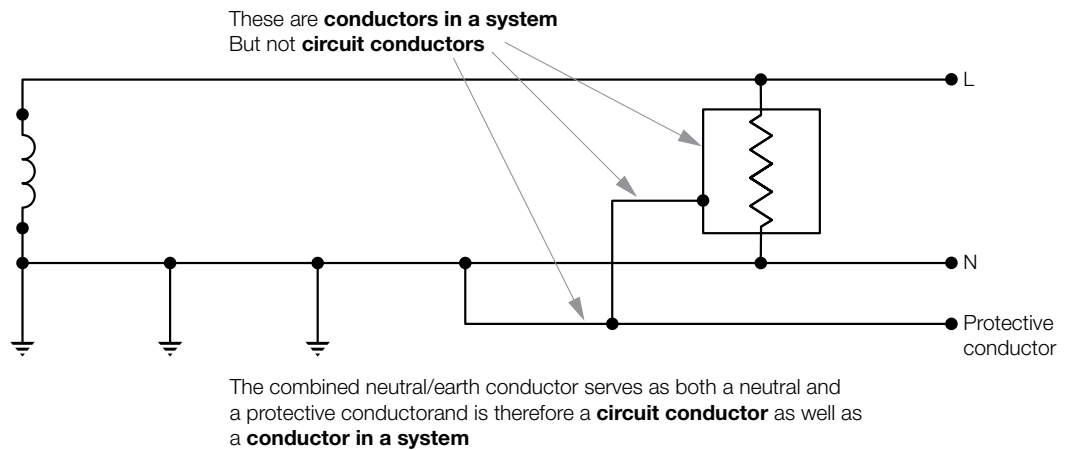

System including both combined and separate neutral and earth conductors (single phase only shown)

Guidance

2

Circuit conductor

23 This definition is used in regulations 8 and 9 only. It distinguishes from all other conductors those conductors whose normal function is to carry load current or to be energised (see Figure 1).

Danger

24 The Regulations use the two defined terms, 'danger' and 'injury'. 'Danger' is defined as 'risk of *injury*'. 'Injury' is defined in terms of certain classes of potential harm to people.

25 Where the term 'prevent danger' is used it should therefore be read as 'prevent the risk of *injury*'.

26 The Regulations make requirements to 'prevent danger' or 'prevent injury' – or in the case of regulation 16 – 'to prevent danger or, where appropriate, injury'. The purpose of the distinction between 'injury' and 'danger' is to accommodate those circumstances when people must work on or so near live equipment that there is a risk of 'injury', ie where 'danger' is present and cannot be prevented. In these circumstances, under regulation 14, danger may be present but injury must be prevented.

27 The type of injuries with which the Regulations are concerned are detailed in the definition of 'injury' in the regulation (see paragraphs 29 and 30). The scope of the Regulations does not include consequential dangers such as crushing injuries caused by a machine going out of control following an electrical malfunction. Such other dangers are subject to other legal requirements under, for example, the HSW Act, the Factories Act 1961 and the Office, Shops and Railway Premises Act 1963.

28 If no danger arises from a particular system, item of electrical equipment or conductor and will not arise, then the Regulations, although applying to it, do not require any precautions to be taken. However, in order for there to be no danger, there would have to be no risk of electric shock, electric burn, fire, arcing or explosion.

Injury

29 The purpose of the Regulations is to prevent death or personal injury to any person from electrical causes in connection with work activities.

30 'Injury' means death or injury to any person from:

- (a) electric shock;
- (b) electric burn;
- (c) fires of electrical origin;
- (d) electric arcing;
- (e) explosions initiated or caused by electricity.

Electric shock

31 The human body responds in several ways to electrical current flowing through it. The sensation of shock is only one such effect and this can be extremely painful. When a shock is received, the electric current may take multiple paths through the body and its intensity at any one point is difficult or impossible to predict. The passage of electric current may cause muscular contractions, respiratory failure, fibrillation of the heart, cardiac arrest or injury from internal burns. Any of these can be fatal.

Guidance

2

32 The nature and severity of injury depends upon the magnitude, duration and path of the current through the body and, in the case of alternating current (ac), on its frequency. It is not possible to identify precise thresholds for the existence of hazard because a judgement has to be made in each case taking all the circumstances into account, such as body weight, physical condition of the victim and so forth. Nevertheless, a guide to the sort of current magnitudes which mark the occurrence of various dangerous effects is given in the International Electrotechnical Commission's (IEC's) publication *Guide to effects of current on human beings and livestock. Special aspects relating to human beings*.⁶ Quite low currents, of the order of only a few milliamps (mA), can cause fatal electric shock.

33 The likely effects of shock current are mainly influenced by:

- (a) voltage;
- (b) frequency;
- (c) duration;
- (d) any impedance in the current path.

34 The effects of electric shock are most acute at around the public electricity supply frequency of 50 hertz. Susceptibility to electric shock is increased if a person is in:

- (a) good electrical contact with earth, such as in damp or wet conditions or in conducting locations such as inside a metal tank;
- (b) hot environments where people may become damp due to perspiration or humidity, thus reducing the insulation protection offered by clothing.

35 The variability of conditions makes it impossible to specify a voltage which is guaranteed to be safe in all situations. In any situation, you should consider the risk of injury from electric shock against published guidance as to the voltages and other factors which have been found by extensive experience to be safe. This includes national and international standards and technical publications. However, these documents should be interpreted carefully and with a view to the limitations of their various scopes and assumptions. You should always consider the conventional public electricity supply voltage of 230 V ac as potentially fatally dangerous. Many fatal electric shock accidents have occurred from contact with conductors live at this voltage and possibly the most dangerous situation is where contact is made with conductors by each hand, current then flowing 'hand to hand' across the heart region.

36 The following documents give some guidance (see References):

- (a) *Guide to effects of current on human beings and livestock* (IEC TS 60479);
- (b) *Requirements for electrical installations* (BS 7671);
- (c) *Safety of equipment electrically connected to a telecommunications network* (IEC 62151).⁷

Electric burn

37 Electric burns are different from burns due to fire (see paragraphs 39–40), arcing (see paragraphs 41–42) or explosion (see paragraphs 44–46). They are due to the heating effect caused by the passage of electric current through body tissues. They are most commonly associated with electric shock and often occur in and on the skin layers at the point of contact with the electrical conductors which gave rise to the electric shock. Electrical arcs jump across gaps and can cause burns.

Guidance 2

38 At high frequencies, eg radio frequencies (RF), which include microwaves, it may not even be necessary for contact to be made with live conductors for an electric burn to be received. In the case of RF, the heating is by absorption of the electromagnetic wave energy by a dielectric loss process in the body of the victim. RF burns can thus be extremely deep within the body. RF burning can occur without the sensation of shock, particularly if no contact is made with the RF conductors, and can therefore cause severe injury before the victim is aware of their occurrence. Electric burns are usually painful and very slow to heal. Permanent scarring is common.

Fires of an electrical origin

39 Fires may be started by electricity in a number of ways. The main causes are:

- (a) overheating of cables and electrical equipment due to overloading of conductors;
- (b) leakage currents due to poor or inadequate insulation;
- (c) overheating of flammable materials placed too close to electrical equipment which is otherwise operating normally;
- (d) the ignition of flammable materials by arcing or sparking of electrical equipment, including the scattering of hot particles from electrical equipment.

40 The injuries associated with fire are usually burns but may include other injuries such as smoke inhalation, each with the potential to kill.

Arcing

41 Arcing causes a particular type of burn injury which is distinct from other types. Arcing generates ultraviolet radiation which causes damage similar to severe sunburn. Molten metal particles from the arc itself can penetrate burn and lodge in the flesh. These effects are additional to any radiated heat damage caused by the arc.

42 On its own, ultraviolet radiation can cause damage; sensitive skin and eyes are especially vulnerable to arc flash. ('Arc eye' is commonly encountered with electric arc welding if the proper precautions are not adopted.)

43 Arcing faults can occur if the energy available at a piece of electrical equipment is sufficient to maintain a conductive path through the air or insulation between two conductors which are at different potentials. Under fault flashover conditions, currents many times the nominal rating or setting of a protective device may flow before those devices operate to clear the fault. Much energy is dissipated in the arc and, depending on the electrical protection, may continue long enough to inflict very serious arcing burns or to initiate a fire. These periods can be as short as 0.2 seconds. Arc flashovers caused during work on live circuit conductors are likely to be particularly hazardous because the worker is likely to be very near to or even enveloped by the arc. Such cases often lead to very serious, sometimes fatal, burn injuries.

Explosion

44 This category includes those injuries caused by explosions either of an electrical nature or those ignited by an electrical source.

45 Electrical explosions include the violent and catastrophic rupture of any electrical equipment. Switchgear, motors and power cables are liable to explode if they are subjected to excessive currents, which release violent electromagnetic forces and dissipate heat energy, or if they suffer prolonged internal arcing faults.

46 Explosions caused by ignition from an electrical source include ignition of flammable vapours, gases, liquids and dusts by electrostatic discharge, electric sparks, arcs or the high surface temperature of electrical equipment.

Guidance 2

Other words used in the Regulations

Charged/live (as used in regulations 8, 13 and 14)

47 The terms ‘charged’ and ‘live’ have different meanings; they are not defined in the Regulations so they take their ordinary meaning. ‘Live’ means equipment that is at a voltage by being connected to a source of electricity. ‘Charged’ means that the item has acquired a charge either because it is live or because it has become charged by other means, such as static or induction charging, or has retained or regained a charge due to capacitance effects even though it may be disconnected from the rest of the system.

Dead (as used in regulations 13 and 14)

48 The term ‘dead’ is not defined in the Regulations so it takes its ordinary meaning. Thus, in the context of the Regulations, for a conductor to be ‘dead’ means that it is neither ‘live’ nor ‘charged’.

Other words used in the guidance

High voltage, low voltage

49 High voltage is a voltage in excess of 1000 V ac or 1500 V dc (direct current). Low voltage is a voltage up to and including 1000 V ac or 1500 V dc.

Live work

50 Live work is work on or near conductors that are accessible and ‘live’ or ‘charged’. Note that testing of live exposed conductors using a test instrument is live work.

Regulation 3 Persons on whom duties are imposed by these Regulations

Regulation 3

(1) *Except where otherwise expressly provided in these Regulations, it shall be the duty of every –*

- (a) *employer and self-employed person to comply with the provisions of these Regulations in so far as they relate to matters which are within his control; and*
- (b) *[(i) mine operator, in relation to a mine within the meaning of regulation 3 of the Mines Regulations 2014, and]*
(ii) operator, in relation to a quarry within the meaning of regulation 3 of the Quarries Regulations 1999, to ensure that all requirements or prohibitions imposed by or under these Regulations are complied with in so far as they relate to the mine of which he is the [mine operator]* or quarry of which he is the operator and to matters which are within his control.*

(2) *It shall be the duty of every employee while at work –*

- (a) *to co-operate with his employer so far as is necessary to enable any duty placed on that employer by the provisions of these Regulations to be complied with; and*
- (b) *to comply with the provisions of these Regulations in so far as they relate to matters which are within his control.*

*[(3) In this regulation, “mine operator” has the meaning given by regulation 2(1) of the Mines Regulations 2014.]**

* Amended by the Mines Regulations 2014, SI 2014/3248.

Guidance

3

Employer

51 For the purposes of the Regulations, an employer is any person or body who:

- (a) employs one or more individuals under a contract of employment or apprenticeship; or
- (b) provides training under the schemes to which the HSW Act applies through the Health and Safety (Training for Employment) Regulations 1990 (SI 1990/1380).

Self-employed

52 A self-employed person is an individual who works for gain or reward other than under a contract of employment, whether or not they employ others. They encounter the same risks as employed people.

Employee

53 Regulation 3(2)(a) reiterates the duty placed on employees by section 7(b) of the HSW Act.

54 Regulation 3(2)(b) places duties on employees equivalent to those placed on employers and self-employed people where these are matters within their control. This will include those trainees who will be considered as employees under the Regulations described in paragraph 51.

55 This arrangement recognises the level of responsibility which many employees in the electrical trades and professions are expected to take on as part of their job. The 'control' which they exercise over the electrical safety in any particular circumstances will determine to what extent they hold responsibilities under the Regulations to ensure that the Regulations are complied with.

56 A person may find themselves responsible for causing danger to arise elsewhere in an electrical system, at a point beyond their own installation. This situation may arise, for example, due to unauthorised or unscheduled back feeding from their installation onto the system, or to raising the fault power level on the system above rated and agreed maximum levels due to connecting extra generation capacity etc. Because such circumstances are within their control, the effect of regulation 3 is to bring responsibilities for compliance with the rest of the Regulations to that person, thus making them a dutyholder.

Absolute/reasonably practicable

57 Duties in some of the Regulations are subject to the qualifying term 'reasonably practicable'. Where qualifying terms are absent the requirement in the regulation is said to be absolute. The meaning of reasonably practicable has been well established in law. The interpretations in paragraphs 59–60 are given only as a guide to dutyholders.

Absolute

58 If the requirement in a regulation is 'absolute', for example if the requirement is not qualified by the words 'so far as is reasonably practicable', the requirement must be met regardless of cost or any other consideration. Regulations making such absolute requirements are subject to the defence provision of regulation 29.

Guidance 3

Reasonably practicable

59 Generally, you should do everything ‘reasonably practicable’ to protect people from harm. This means balancing the level of risk against the measures needed to control the real risk in terms of money, time or trouble. However, you do not need to take action if it would be grossly disproportionate to the level of risk.

60 In the context of the Regulations, where the risk is very often that of death, eg from electrocution, and where the nature of the precautions which can be taken are so often very simple and cheap, eg insulation, the level of duty to prevent that danger approaches that of an absolute duty.

Regulation 4 Systems, work activities and protective equipment

Regulation 4

(1) All **systems** shall at all times be of such construction as to prevent, so far as is reasonably practicable, **danger**.

(2) As may be necessary to prevent **danger**, all **systems** shall be maintained so as to prevent, so far as is reasonably practicable, such **danger**.

(3) Every work activity, including operation, use and maintenance of a **system** and work near a **system**, shall be carried out in such a manner as not to give rise, so far as is reasonably practicable, to **danger**.

(4) Any equipment provided under these Regulations for the purpose of protecting persons at work on or near **electrical equipment** shall be suitable for the use for which it is provided, be maintained in a condition suitable for that use, and be properly used.

Guidance 4

61 Regulation 4 covers, in a general way, those aspects of electrical systems and equipment, and work on or near these, which are fundamental to electrical safety.

Regulation 4(1)

62 The word ‘construction’ in the regulation has a wide application. It may be considered to cover the physical condition and arrangement of the components of a system at any time during its life. It will include aspects such as the design of the system and the equipment comprising that system.

63 In assessing the suitability of the construction of electrical systems, consideration should be given to all likely or reasonably foreseeable conditions of actual application or use of the electrical equipment in the system. This will include the testing, commissioning, operation and maintenance of the equipment throughout the life of the system.

64 In particular, you should consider:

- (a) the manufacturer’s assigned or other certified rating of the equipment;
- (b) the likely load and fault conditions;
- (c) the need for suitable electrical protective devices;
- (d) the fault level at the point of supply and the ability of the equipment and the protective devices to handle likely fault conditions;
- (e) any contribution to the fault level from the connected loads such as from motors;

Guidance

4

- (f) the environmental conditions which will have a bearing on the mechanical strength and protection required of the equipment;
- (g) the user's requirements of the installation;
- (h) the risks that a system may create to adjacent work activities and the public;
- (i) the manner in which commissioning, testing and subsequent maintenance or other work may need to be carried out.

65 The safety of a system depends upon the proper selection of all the electrical equipment in the system and the proper consideration of the inter-relationship between the individual items of equipment. For example, electrical protection against overloads and earth faults etc may need to be provided in one part of a system to protect another, possibly remote, part of the system. Also, where electrical energy is transformed or converted from one voltage to another, you should take precautions to prevent danger arising from the lower-voltage conductors becoming charged above their normal voltage.

Regulation 4(2)

66 Regulation 4(2) is concerned with the need for maintenance to be done to ensure safety of the system, rather than with the activity of doing the maintenance in a safe manner (which is required by regulation 4(3)).

67 The obligation to maintain arises only if danger would otherwise result. The maintenance should be sufficient to prevent danger so far as is reasonably practicable.

68 Inspection and, where necessary, testing of equipment is an essential part of any preventive maintenance programme. Practical experience of use may indicate an adjustment to the frequency at which preventive maintenance needs to be carried out. This is a matter for the judgement of the dutyholder, who should seek all the information they need to make this judgement including reference to the equipment manufacturer's guidance.

69 Records can aid demonstration of compliance and allow useful analysis of equipment condition, although keeping records is not a legal requirement. Maintenance records (including test results), preferably kept throughout the working life of an electrical system, will allow the condition of the equipment and the effectiveness of maintenance policies to be monitored. Without effective monitoring, dutyholders cannot be certain that the requirement for maintenance has been complied with.

70 British Standard Codes of Practice offering guidance on maintenance are referred to in Further reading. Advice on inspection and testing of some fixed installations is given in BS 7671.

Regulation 4(3)

71 Regulation 4(3) requires that work activities of any sort, whether directly or indirectly associated with an electrical system, must be carried out in a way which, as far as is reasonably practicable, does not give rise to danger. Regulations 12 to 16 provide more specific requirements in connection with work of an electrical nature on or near electrical systems. See *Electricity at work: Safe working practices*⁹ for more information

Guidance

4

Work activities associated with electrical systems

72 In the case of electrical work, it is preferable that the conductors are made dead before work starts (see regulations 12, 13 and 14). In such cases, it is essential that the equipment is isolated (note that 'isolation' is defined in regulation 12(2), which will include securing by locking off etc; see also paragraph 75) and the conductors proved dead at the point of work before the work starts. Where a test instrument or voltage indicator is used for this purpose, this device should itself be proved immediately before and immediately after testing the conductors.

73 Safe systems of work incorporating safety isolation procedures are important for work on equipment which is to be made dead before work starts. Particular consideration is needed where multiple sources of supply can exist, eg connection of alternative generation. These are also discussed under regulations 12 and 13. Some work, such as fault finding and testing or live jointing by the electricity supply industry, may require electrical equipment to remain energised during the work. In these cases, regulation 14 makes particular requirements and regulation 4(4) is also likely to be relevant in terms of the protective equipment which may need to be provided. *Electricity at work: Safe working practices* gives further guidance.

74 The operation, maintenance and testing of electrical systems and equipment must only be carried out by those people who are competent for that work (see also regulation 16).

Disused electrical equipment and systems

75 Before electrical equipment or systems are decommissioned they must be disconnected from all sources of supply and isolated. Similarly, electrical equipment or systems which are disused, or no longer required or abandoned for any reason, should be disconnected from all sources of supply and isolated. Isolation (as defined in regulation 12(2)) requires taking effective steps to ensure that it is dead and cannot become inadvertently re-energised or charged by induction or capacitance effects. (Regulations 12, 13 and 14 are also likely to be relevant.) Suitable labels or notices to bring people's attention to the state of the equipment are likely to be necessary in preventing inadvertent re-energisation.

Other work near electrical systems

76 Regulation 4(3) is wide in its application and includes work of a non-electrical nature where there is a risk of electrical injury. A common example is excavation near to live electric power cables and work near live overhead power lines, where the risks can be severe. Advice on these matters is given in HSE publications listed in References and further reading. You must also consider the requirements of regulation 14.

Regulation 4(4)

77 The defence (regulation 29) is available in any proceedings for an offence under this part of regulation 4.

78 The term 'protective equipment' can be of wide application but typically includes those special tools, protective clothing and insulating screening materials etc necessary to do work safely on live electrical equipment. The requirement for

Guidance 4

suitable precautions to prevent injury may arise under regulation 14. The regulation requires the protective equipment to be:

- (a) suitable for use;
- (b) maintained in that condition;
- (c) properly used.

79 Regulation 4(4) is not qualified by 'so far as is reasonably practicable', nor does the regulation refer either to injury or the risk of injury, ie electrical danger. The impact of the regulation is that, where protective equipment is provided in order to comply with any of the other regulations, the equipment must conform to the requirements of regulation 4(4). Advice on safe working practices is given in HSE guidance. Specifications for certain types of protective equipment such as insulating gloves and floor mats are listed in relevant standards in References and further reading.

Regulation 5 Strength and capability of electrical equipment

Regulation 5

No **electrical equipment** shall be put into use where its strength and capability may be exceeded in such a way as may give rise to **danger**.

Guidance 5

80 The defence (regulation 29) is available in any proceedings for an offence under this regulation.

81 Before equipment is energised, the characteristics of the system to which the equipment is connected must be taken into account. This should include those existing under normal conditions, possible transient conditions and prospective fault conditions, so that the equipment is not subjected to stress which it is not capable of handling without giving rise to danger. The effects to be considered include voltage stress and the heating and electromagnetic effects of current.

Strength and capability

82 The term 'strength and capability' of electrical equipment refers to the ability of the equipment to withstand the thermal, electromagnetic, electrochemical or other effects of the electrical currents which might be expected to flow when the equipment is part of a system. These currents include, for example, load currents, transient overloads, fault currents, pulses of current and, for alternating current circuits, currents at various power factors and frequencies. Insulation must be effective to enable the equipment to withstand the applied voltage and any likely transient over-voltages.

83 A knowledge of the electrical specification and the tests, usually based on the requirements of national or international standards, will assist the user in identifying the withstand properties of the equipment so that it may be selected and installed to comply with this regulation. Such tests are normally carried out either by the manufacturer or by an accredited testing organisation.

Rating

84 The strength and capability of electrical equipment is not necessarily the same as its rating. Usually the rating is that which has been assigned by the manufacturer following a number of agreed tests.

Guidance 5

85 Electrical equipment should be used within the manufacturer's rating (continuous, intermittent or fault rating as appropriate) and in accordance with any instructions supplied with the equipment.

Fault conditions

86 So that equipment remains safe under prospective fault conditions, you must select equipment that takes account of the fault levels and the characteristics of the electrical protection which has been provided for the purpose of interrupting or reducing fault current (excess current protection is required by regulation 11). Most electrical equipment will be able to withstand short-circuit currents safely for limited periods only. The considerations also extend to conductors and equipment provided solely for protective purposes, eg earthing conductors must be adequately rated to survive beyond fault clearance times to ensure satisfactory protective gear operation and fault clearance.

Regulation 6 Adverse or hazardous environments

Regulation 6

Electrical equipment which may reasonably foreseeably be exposed to –

- (a) mechanical damage;
- (b) the effects of the weather, natural hazards, temperature or pressure;
- (c) the effects of wet, dirty, dusty or corrosive conditions; or
- (d) any flammable or explosive substance, including dusts, vapours or gases,

shall be of such construction or as necessary protected as to prevent, so far as is reasonably practicable, **danger** arising from such exposure.

Guidance 6

87 The regulation draws attention to the kinds of adverse conditions where danger could arise if equipment is not constructed and protected to withstand such exposure. Electrical equipment must be suitable for the environment and conditions of use to which it may reasonably foreseeably be exposed so that danger which may arise from such exposure will be prevented so far as is reasonably practicable. The following paragraphs detail some of the conditions to which electrical equipment may be subjected. Guidance is given in these paragraphs and additional guidance may be found in the documents listed in References and further reading. Particular attention should be paid to the IP rating (Index of Protection) of equipment (see paragraph 108). Guidance is also given under regulation 8 on the use of reduced voltage systems on construction sites and elsewhere where particularly arduous or conducting locations may exist (see paragraphs 142–144).

Effects

88 The conditions at which the regulation is directed are those occurring naturally as well as those resulting from human activities, including the following:

- (a) mechanical damage including impact, stress, strain, abrasion, wear, vibration and hydraulic and pneumatic pressure;
- (b) effects of the weather, which include both short-term (eg wind, ice and snow, lightning) and long-term (eg temperature cycling) effects;
- (c) natural hazards, which are those resulting from other than man's activities and include animals, trees and plants, tides and solar radiation etc;
- (d) temperature and pressure;

Guidance

6

- (e) liquids which include water and other liquids and their effects, including humidity, condensation, flooding, splashing, or immersion in these, cleaning with liquids, hosing down and solvent and solvent vapour action (electrically conducting and non-conducting liquids may present different aspects of electrical danger);
- (f) dirty conditions which include all contamination as a result of liquids or solids (electrically conducting and non-conducting dusts may present different aspects of electrical danger);
- (g) corrosive conditions which include all chemical actions and reactions and electrochemical effects;
- (h) flammable substances, including flammable dusts and flammable vapours;
- (i) explosive substances which include both any mixture of solids, liquids or gases which is capable of exploding and substances intended to be explosive (ie explosives).

89 When determining the suitability of equipment for particular environments or conditions of use, you only need to consider exposure or effects which are reasonably foreseeable.

Mechanical damage

90 The mechanical damage to which electrical equipment may be subjected varies considerably from one environment to another. For example, equipment designed for use in an office is unlikely to be suitable, without further protection or careful siting, in a workshop or farm environment.

91 The effects covered by regulation 6(b), (c) and (d) may also impose mechanical stresses on electrical equipment. For example, ice and wind loading, or loss of mechanical strength due to expansion and contraction resulting from temperature changes, can give rise to mechanical damage.

92 This regulation requires the mechanical protection, if necessary, of the insulation which is required under regulation 7(a). For example, to protect against impact damage, steel wire armouring of a cable may be necessary. Further suitable protection in addition to basic insulation may be required to form the physical protection necessary to ensure the continuing integrity of basic insulation, eg conduits or a trunking for single-insulated conductors or the armouring or tough external sheathing of composite or multi-core electric cable.

Weather, natural hazards and extreme conditions

93 Precautions taken to protect a site, structure or building from natural hazards and extreme weather conditions may give some protection to the associated electrical installation, but additional protection or precautions may also be necessary.

94 Extremes of temperature, pressure or humidity may result either from climatic conditions or from adjacent plant or from the use of the electrical equipment itself. Standards frequently quote the range of service conditions for electrical equipment, including temperature limits, and users should consider these when selecting equipment.

95 Guidance on assessing the need for lightning protection of structures and buildings etc, the design and provision of systems and their inspection, testing and maintenance is given in publications listed in References and further reading.

Guidance

6

Corrosive effects

96 If substances are present in the environment that accelerate corrosion of metallic enclosures or fittings, special materials or surface treatments may be necessary. In these cases, the electrical equipment must be protected, eg motors, and be of a type which is totally enclosed by an appropriate corrosion-resistant housing, ie not ventilated to the atmosphere.

97 Insulating materials and other materials used in electrical equipment may be affected by chemical agents or solvents. Cubicles housing electrical control equipment in hostile environments may need to be kept purged or pressurised with clean air or, in special cases, inert gas. See Further reading for details of relevant standards.

Dirt and dusts

98 Most industrial enclosures for electrical equipment do not resist the entry of fine dusts. Equipment must be constructed to resist the entry of dust and dirt where this may give rise to electrical and mechanical failures. Appropriate regular inspection and cleaning are recommended where dirt and dusts are likely to accumulate, eg portable motor-driven equipment incorporating ventilation slots which can cause the accumulation of potentially hazardous layers of dirt and dust.

Combustible dusts

99 In cloud form, some dusts create an explosion hazard, while layers of combustible dust on electrical equipment can give rise to fire hazards. The selection, construction or installation of equipment exposed to combustible dust must guard against the possibility of ignition. The maximum temperature attainable on the surface of any electrical equipment where these dusts may be deposited should always be below the temperature at which any ignition, charring or smoking of dust takes place. However, appropriate dust control measures and general cleanliness which minimise the problem at source are recommended. See References and further reading for details of relevant standards.

Potentially explosive atmospheres

100 If electrical equipment is used where a flammable or explosive atmosphere is likely to occur, the equipment must be constructed so that it is not liable to ignite that atmosphere. Further information is available in the Dangerous Substances and Explosive Atmospheres Regulations.⁹

101 The selection and installation of equipment for use in potentially explosive atmospheres should be guided by the recommendations contained in the HSE guidance and British Standards on the subject. Existing installations complying with the recommendations of earlier standards should be acceptable for continuing service, subject to proper maintenance.

102 Such electrical equipment must be chosen from that which has been certified as conforming to an appropriate standard.

103 Uncertified electrical equipment must not be used unless it will provide at least an equivalent level of safety to that provided by appropriately certified equipment.

Guidance 6

104 Some manufacturing processes, eg electrostatic paint spraying, make use of the characteristics of static electricity and the design of electrical equipment should be such that the ignition of solvents, vapours or particulate substances is prevented. See References and further reading for details of relevant standards.

105 The maintenance and repair of explosion-protected equipment is a specialised field of work and must only be carried out by those who have the necessary training and experience.

Other flammable substances

106 Electrical equipment that generates heat or produces sparks must not be placed where either the heat emitted or sparking could lead to the uncontrolled ignition of any substance.

107 The construction of the equipment should either exclude the substances from any part of the equipment which may be a source of ignition (eg by suitable enclosure) or should ensure that the equipment operates at sufficiently low temperature and energy levels as not to be a source of ignition under likely conditions of use and fault.

Classification system of ingress protection (IP rating)

108 There is an internationally recognised system of classifying the degree of protection provided by enclosures against the ingress of solid objects and moisture, and the protection afforded against contact with any live parts within the enclosure for all types of electrical equipment. The system is commonly known as the IP rating system and is detailed in a number of standards which are listed in Further reading.

Regulation 7 Insulation, protection and placing of conductors

Regulation 7

All **conductors** in a **system** which may give rise to danger shall either –

- (a) be suitably covered with insulating material and as necessary protected so as to prevent, so far as is reasonably practicable, **danger**; or
- (b) have such precautions taken in respect of them (including, where appropriate, their being suitably placed) as will prevent, so far as is reasonably practicable, **danger**.

Guidance 7

109 The danger to be protected against generally arises from differences in electrical potential (voltage) between circuit conductors or between such conductors and other conductors in a system – usually conductors at earth potential. The conventional approach is either to insulate the conductors or place them so people are unable to receive an electric shock or burn from them.

110 Some form of basic insulation, or physical separation, of conductors in a system is necessary for the system to function. That functional minimum, however, may not be sufficient to comply with the requirements of regulation 7. Factors which must be taken into account are:

Guidance

7

- (a) the nature and severity of the probable danger;
- (b) the functions to be performed by the equipment;
- (c) the location of the equipment, its environment and the conditions to which it will be subjected;
- (d) any work which is likely to be done on, with or near the equipment.

Insulation

111 Regulation 7(a) states that conductors must be insulated. Suitable insulation of the conductors in an electrical system is, in the majority of cases, the primary and necessary safeguard to prevent danger from electric shock, either between live conductors or between a live conductor and earth. It will also prevent danger from fire and explosion arising from contact of conductors either with each other or with earth. Energy from quite low levels of voltage (and levels insufficient to create a shock risk) can ignite a flammable atmosphere. The quality and effectiveness of insulation therefore needs to be commensurate with the voltages applied to the conductors and the conditions of use.

112 BS 7671 gives some advice on these matters for fixed electrical installations up to 1000 V ac or 1500 V dc.

113 The regulation requires that the insulation be protected as necessary, so that danger may be prevented so far as is reasonably practicable. Often, the protection required is to prevent mechanical damage to the insulation but may include any of the effects detailed under regulation 6. Examples of such protection would be the use of steel trunking and conduits or the use of steel armoured cables.

Other precautions including placing

114 Regulation 7(b) permits the alternative of having such precautions taken in respect of the conductors. These precautions may include the suitable placing of conductors. They may comprise strictly controlled working practices reinforced by measures such as written instructions, training and warning notices etc. The precautions must prevent danger so far as is reasonably practicable. Examples where bare conductors are used in conjunction with suitable precautions are to be found in many applications including overhead electric power lines, down-shop conductors for overhead travelling cranes in factories etc, railway electrification using either separate conductor and running rails or overhead pick-up wires, and certain large electrolytic and electrothermal plants.

115 The placing of overhead electric power lines is specified in ESQCR (see Introduction for more information).

116 Electric railway and tramway operators, in conjunction with the Office of Rail and Road, have developed standards and safety specifications for the construction of those parts of their systems which use bare conductors at overhead and at track level, together with safe systems of work.

117 Safety is ensured in electrochemical plants which use high current by such means as the separation of conductors which are at different potentials, the use of insulating working platforms and unearthed or isolated electrical supplies (see paragraphs 121–123).

118 Suitable placing of the conductors may, on its own, go a considerable way towards preventing danger, for example where the conductors are within a secure enclosure or where they are placed overhead at such a height that contact with

Guidance

7

these conductors is not reasonably foreseeable. Guidance on the security and protection of enclosures and the measure of their accessibility as determined by standard (finger) tests is given in standards listed in Further reading.

119 However, if the placing of the conductors cannot alone be relied upon to prevent danger, then additional precautions must be taken and rigorously applied. For example, in the case of live railway conductor rails the precautions may include warning notices, barriers and special training for railway staff. Electrolytic and electrothermal processes are further examples and are covered in paragraphs 121–123.

120 Dutyholders should carefully consider the inherent risks that may still exist if bare conductors are placed where they cannot normally be touched, eg maintenance activities around the conductors of an electric overhead crane system. Firstly, the protection of the equipment is required under regulation 6 for a range of reasonably foreseeable effects and, secondly, there may be occasions when people will require access to the area or enclosure where such conductors are located, eg substations and test areas. Where work is to be done with the conductors live, regulation 14 is relevant and the guidance under that regulation also applies.

Electrolytic and electrothermal processes

121 It is often necessary for industrial electrolytic and electrothermal processes, including large secondary battery installations, to adopt a range of precautions. As the work activity is likely to be near the live and uninsulated conductors, the precautions adopted will go towards satisfying both part (b) of regulation 7 and regulation 14.

122 Precautions may include:

- (a) segregating the process area and limiting access to those people who are trained and experienced in the process and to people who are supervised so that injuries are prevented;
- (b) ensuring a separation of conductors appropriate to the difference in potentials;
- (c) use of insulating work platforms;
- (d) use of electrical supplies which are isolated from earth together with protective devices to ensure this isolation;
- (e) exclusion of unnecessary conducting materials and implements from the process area;
- (f) use of protective clothing, eg in electric arc welding processes; such clothing offers protection against both the hot welding process and against the electric shock risk.

123 Details of advice on the safe use of electric induction furnaces and electric arc welding are given in Further reading.

Regulation 8 Earthing or other suitable precautions

Regulation 8

*Precautions shall be taken, either by earthing or by other suitable means, to prevent **danger** arising when any **conductor** (other than a **circuit conductor**) which may reasonably foreseeably become charged as a result of either the use of a **system**, or a fault in a **system**, becomes so charged; and, for the purposes of ensuring compliance with this regulation, a **conductor** shall be regarded as earthed when it is connected to the general mass of earth by **conductors** of sufficient strength and current-carrying capability to discharge electrical energy to earth.*

Guidance 8

124 The defence (regulation 29) is available in any proceedings for an offence under this regulation.

125 The regulation applies to any conductor (other than circuit conductors), including the conductive parts of equipment, such as outer metallic casings, which can be touched and, though not live, may become live under fault conditions.

126 Conductors which, although not part of a system, are within electrostatic or electromagnetic fields created by a system may be subject to this regulation. Appropriate precautions are necessary if the induced voltages or currents are large enough to give rise to danger.

Dangers

127 Dangers which may arise as a result of failure to take the necessary precautions include:

- (a) risk of shock from conductors which are or may be exposed so that they may be touched and which become charged at dangerous voltage relative to earth or to other exposed conductors;
- (b) risk of burns, fire, arcing or explosion due to currents of excessive magnitude and/or duration in such conductors.

128 The requirements of the regulation may be met in several different ways, depending on the circumstances, including:

- (a) ensuring that such conductors do not become charged. This has the effect of excluding the conductors from the scope of this regulation;
- (b) ensuring that if such conductors do become charged the values of voltage and current and the duration are such that danger will not arise;
- (c) ensuring that if such conductors do become charged the environment is such that danger will not arise.

129 Techniques employed for achieving the above include:

- (a) double insulation;
- (b) earthing;
- (c) connection to a common voltage reference point on the system;
- (d) equipotential bonding;
- (e) use of safe voltages;
- (f) earth-free, non-conducting environments;
- (g) current/energy limitation;
- (h) separated or isolated systems.

130 You may employ the above techniques singly or in combination.

Guidance

8

Double insulation

131 The principle of 'double insulation' is that the live conductors of the electrical equipment are covered by two discrete layers or components of insulation, each of which would adequately insulate the conductor but which together ensure an improbability of danger arising from insulation failure. This arrangement avoids the need for any external metalwork of the equipment to be connected to a protective conductor or to earth. Double insulation has been found to be particularly suitable for certain types of portable equipment, eg electric motor-driven tools etc. See Further reading for details of relevant standards. However, the integrity of this safety protection depends upon the layers of insulation remaining in sound condition and this in turn requires the equipment to be properly constructed, used and maintained.

Earthing

132 It is the practice in the UK for the public electricity supply system at the usual distribution voltages of 230 V single-phase, 400 V three-phase, to be referenced to earth by a deliberate electrical connection made at the distribution substations or power transformers. It is the existence of this system earthing which enables earth faults on electrical equipment to be detected and the electrical supply to faulty equipment to be cut off automatically.

133 Many 230/400 V power installations are designed so that the automatic interruption of the supply in the event of an earth fault is achieved by the operation of fuses or automatic circuit breakers (MCBs etc). In most cases, these devices will have been selected to provide the additional protective function of interrupting excess current required under regulation 11. In these circumstances the earth fault current must be large enough to rupture the fuse quickly. The magnitude of the fault current under full earth fault conditions is governed mainly by the combined impedance of the fault loop, which will include the impedance of the fault itself, that of the earthing or protective conductors, the circuit conductors and that of the source.

134 Tests must therefore be carried out on new installations and at appropriate intervals thereafter to ascertain that the earth fault (loop) impedances are low enough to ensure the electrical protective devices such as fuses, circuit breakers etc will operate in the event of a breakdown of insulation leading to an 'earth fault'. This includes the temporary electrical system used at a construction site in the process of carrying out construction activities.

135 Acceptable values of earth loop impedance and interruption times etc, for final installations up to 1000 V, can be found in BS 7671. It is rarely sufficient to rely on an earth rod or rods to provide sufficient conductance for return fault currents. Separate protective earth cables or conductors connected to the neutral point of the supply are usually necessary unless other measures, such as the use of sensitive residual current protection equipment, are used to detect earth fault currents.

136 For the duration of the fault, the electrical bonding of exposed conductive parts and their connection to earth serves to limit the shock risk from the transient voltages appearing between metallic enclosures of equipment in the system or between a metallic enclosure and earth. Equipment earthing therefore includes the bonding of metallic enclosures, cable armouring, conduits and trunking etc, so that these conductors are electrically continuous and securely connected to the general mass of earth at one or more points.

137 Earthing and bonding conductors must be suitable for the maximum current which they may carry under fault conditions and be capable of surviving the worst-

Guidance

8

case fault (see paragraph 82). Their construction and strength must be adequate to withstand likely wear and tear. Where it might otherwise be difficult to ensure the continued effectiveness of earthing and bonding arrangements, it may be necessary to provide supplementary protection such as protective earth conductor monitoring.

138 Accidents have been caused by the metalwork of portable or transportable equipment becoming live as a result of the combined effects of a fault and high-impedance, protective conductor connections. The danger may be reduced by the use of a residual current device (RCD) designed to operate rapidly at small leakage currents (typically not exceeding 30 mA), although these devices do not eliminate the risk of electric shock. RCDs should not be considered as the sole means of protection but as an additional protective measure. They should be operated regularly using the test trip button. This test trip procedure is important in maintaining the effectiveness of most types of RCD.

139 Electric arc welding brings special problems associated with earthing practices. Stray currents from electrical arc welding can damage the protective earthing conductors of electrical installations. Information on earthing practice is available in a number of publications, some of which are listed in References and further reading.

Connection to a common voltage reference point on the system

140 In UK public electricity supply systems where transformer neutral points are connected to earth, the voltage reference point is the general mass of earth. Other reference points, to which systems may be referenced and to which bonding conductors are connected, may be chosen to suit particular circumstances.

Equipotential bonding

141 Equipotential bonding is the electrical interconnection of all exposed and extraneous conductors, which may become electrically charged, in such a way that dangerous voltages between any of the conductors that may be simultaneously touched are limited.

Use of reduced voltages

142 Reduced voltage systems are particularly appropriate for portable and transportable equipment, and in highly conducting locations such as boilers and tunnels where the risk of mechanical damage to equipment and trailing cables is high, and/or the body may be damp and have large areas of contact with the conducting location and on construction sites.

143 One example is a building or construction site supply system operating at 55-0-55 V ac single-phase, or at 110 V three-phase with a phase-earth voltage of 64 V ac. Another example is an extra-low-voltage system operating at or below 50 V ac or 120 V dc. Supply systems like these are referenced to earth and are therefore a special case of systems operating at reduced voltage for which bonding and earthing of all metallic enclosures are still recommended.

144 Further advice on reduced voltage systems is in Further reading.

Earth-free, non-conducting environments

145 If a system is supplied from a source which is earth-referenced, the path for fault current and the existence of dangerous potentials to earth can be eliminated in a defined area by ensuring that the area is 'earth-free'. This does not necessarily mean that metallic components or fittings need to be prohibited but rather that no part of the defined area is earthed. It is easier to ensure the integrity of an 'earth-free' area by constructing it from non-metallic components, in which case it is more appropriately known as a non-conducting location or area. 'Earth-free' and 'non-

Guidance

8

conducting' areas are specialised applications and are used mainly in certain testing of electrical equipment. Advice is available in the publications on electrical testing listed in References and further reading.

Current limitation

146 If fault currents which could cause electric shock are inherently limited by appropriate passive devices, eg high-integrity resistors, then protection by earthing or other means may not be required. In a conventional, dry working environment, for example, if the current is limited preferably to 1 mA but certainly to no more than 3 mA, this will not usually present a risk of injury from electric shock to people in good health who may be subjected to it only occasionally and for a short time. However, even this low level of current may give perceptible shock which, although by itself is unlikely to be physiologically dangerous, may give rise to a consequential injury such as from a fall induced by the shock. See paragraphs 29–30 on 'injury' under regulation 2, and especially IEC publication *Guide to effects of current on human beings and livestock*.

Separated or isolated systems

147 If safety depends on the supply system not being referenced to its immediate environment, whether true earth or surrounding metalwork, no potential should normally exist between live conductors and earth or exposed metallic parts. However, all systems are to some extent referenced to their environment by capacitive or inductive coupling or by leakage. That is why you cannot necessarily rely on the circuit conductors of separated or isolated* systems being at zero potential relative to their environment. Unless the isolated system is a very small and localised one, the leakage current may be large enough to provide a path for a fatal electric shock. Any difference in potential is likely to be greatest on extensive systems but, in all cases when the voltages or currents could be dangerous, precautions are needed. Examples of isolated systems are those supplied from the secondary winding of an isolating transformer or the winding of an alternator where there is no connection between them and any other source of electrical energy.

148 The isolation of a power system from earth may reduce the risks associated with a single fault. However, if this first fault has the effect of referencing the system to earth or other exposed conductor, subsequent faults may lead to very destructive and hazardous short circuits so extra precautions will be necessary to prevent this danger. These may include the bonding of metallic enclosures, earth fault detection, insulation monitoring or the use of an earth-free non-conducting environment. Regular inspection and testing to ensure that system isolation integrity is maintained will also be necessary.

* 'Isolated' in this context means separate from all other systems and does not imply 'isolation' as defined specifically for the purpose of regulation 12.

Regulation 9 Integrity of referenced conductors

Regulation 9

*If a **circuit conductor** is connected to earth or to any other reference point, nothing which might reasonably be expected to give rise to **danger** by breaking the electrical continuity or introducing high impedance shall be placed in that conductor unless suitable precautions are taken to prevent that **danger**.*

Guidance 9

149 The defence (regulation 29) is available in any proceedings for an offence under this regulation.

150 In many circumstances the reference point is earthed because the majority of power distribution installations are so referenced by a deliberate connection to earth at the generators or distribution transformers.

151 The object of the regulation is to prevent referenced circuit conductors which should be at or about the same potential as the reference point from reaching significantly different potentials, thereby giving rise to possible danger.

152 The most common situation in which this regulation is relevant is in systems having a neutral point which is earthed. Such systems can be subdivided:

- (a) systems or parts of systems in which the neutral and protective conductor are combined (eg TN-C and the combined parts of TN-C-S systems);*
- (b) systems or parts of systems in which the neutral and protective conductors are separate (eg TN-S and the separate parts of TN-C-S systems).

Devices placed in the conductor

153 The regulation does not prohibit all electrical devices from being placed in referenced conductors. For example, a proper joint or a bolted link or a bar primary current transformer can be arranged to ensure the integrity of the conductor.

154 The regulation would also permit the inclusion of other devices such as a removable link, or even a manually-operated knife switch, provided that suitable precautions are adopted to ensure that these devices are not removed or operated in such a way as to give rise to danger. However, a number of other devices, such as fuses, thyristors, transistors etc, generally have the potential to give rise to danger by becoming open circuit or introducing high impedance into the conductor. The regulation prohibits such applications.

Combined neutral and protective conductors

155 Open circuit of, or high impedance in, combined neutral and protective conductors will almost certainly result in the exposed and extraneous conductors connected to the protective conductors, eg metal enclosures of switchgear, being at a significant potential (up to phase-neutral volts) relative to earth. This could lead to a risk of electric shock or burn, so the integrity of the combined neutral and earth conductor is very important.

156 However, where the protective conductor is combined with the neutral conductor over some part of their length, you should take precautions to prevent people coming into simultaneous contact with the protective conductors and earth (or conductors at earth potential). Equipotential bonding of all metalwork within a building and the connection of this to the protective conductor or neutral is a

* This terminology is explained in BS 7671.

Guidance 9

commonly used approach. Generally, however, combined neutral earth (CNE) systems should be confined to the public electricity supply network up to the point of supply to consumers.

Separate neutral and protective conductors

157 In deciding whether danger may result where there are separate neutral and protective conductors, consider not only the normal operation of the system but also the situations that may arise when work is being carried out on or near the system. If voltage rises on the neutral conductor could result in danger during the work then observe the above restrictions on devices in the neutral. For example, a fuse should not be placed in a neutral of a fixed power distribution installation (typically 230 V) as this places people working on the installation at risk of electric shock and burn if that fuse operates or otherwise becomes open circuit. Double pole fusing (fuses in both the phase and neutral) is acceptable, if these are fitted within self-contained electrical equipment which itself is not part of the fixed electrical installation, and is connected to the fixed installation by a plug and socket. This arrangement allows the equipment to be readily isolated from the system before work is done on that equipment.

158 In general, if a neutral conductor is to be switched, a multipole switch or circuit breaker should be used which also switches all of the related phase conductors, the neutral breaking last and making first. Such switching should not interrupt the protective conductor.

Regulation 10 Connections

Regulation 10

*Where necessary to prevent **danger**, every joint and connection in a **system** shall be mechanically and electrically suitable for use.*

Guidance 10

159 The defence (regulation 29) is available in any proceedings for an offence under this regulation.

Suitability of connections

160 The regulation requires that all connections in circuit and protective conductors, including connections to terminals, plugs and sockets, and any other means of joining or connecting conductors, should be suitable for the purposes for which they are used. This requirement applies equally to temporary and permanent connections. The insulation and conductance of the connections must be suitable, having regard to the conditions of use including likely fault conditions.

161 The mechanical protection and strength must be such as to ensure the integrity of the insulation and conductance under all conditions of use including likely fault conditions, subject to the need for any maintenance which may be required by regulation 4(2).

162 Joints and connections in protective conductors must be made at least as carefully as those in circuit conductors and they should be of sufficient strength and conductance to allow for the passage of fault currents. Such connections may need to be treated so they prevent corrosion. It is recommended that combinations of metals liable to produce damaging electrolytic action be avoided.

Guidance 10

Plugs and sockets

163 Plug and socket connections and their use must be arranged so that accidental contact with conductors live at dangerous voltages is prevented. This should be achieved by selection of appropriate equipment but may involve some degree of operator skill and/or training, depending on the circumstances.

164 In most applications, where a plug and socket type connector conveys a protective conductor as well as the circuit conductors, the protective conductor should be the first to be made and the last to be separated. The use of equipment made to appropriate standards should ensure this principle is adhered to.

165 Where plug and socket connections are not rated for making or breaking the maximum load current, effective arrangements should be made, eg by mechanical interlocking with the switch that controls the power, to ensure that the connections are made or broken only under no-load conditions.

Portable equipment

166 Special attention should be given to joints and connections in cables and equipment which will be handled, eg flexible cables for portable equipment. Plugs and sockets for portable equipment must be constructed in accordance with appropriate standards and arranged so that, where necessary, earthing of any metal casing of the equipment is automatically effected by the insertion of the plug. HSE guidance (see *Maintaining portable electric equipment in low-risk environments*¹⁰) and British Standards give further guidance on portable equipment.

Regulation 11 Means for protecting from excess of current

Regulation 11

*Efficient means, suitably located, shall be provided for protecting from excess of current every part of a **system** as may be necessary to prevent **danger**.*

Guidance 11

167 The defence (regulation 29) is available in any proceedings for an offence under this regulation (see paragraphs 177–179).

168 It is recognised that faults and overloads may occur on electrical systems. The regulation requires that systems and parts of systems be protected against the effects of short circuits and overloads if these would result in currents which would otherwise result in danger.

169 The means of protection is likely to be in the form of fuses or circuit breakers controlled by relays etc, or it may be provided by some other means capable of interrupting the current or reducing it to a safe value.

The need to anticipate abnormal conditions

170 The regulation requires the means of preventing danger to be provided in anticipation of excess current; a fault or overload need not have occurred. Fault currents arise as a result of short circuits between conductors caused either by inherent failure of the electrical equipment or some outside influence, eg mechanical damage to a cable. Overload currents can arise as a result of the inadequacy of a system to supply the load and may be caused by an increased demand created by

Guidance 11

outside influence on the electrical equipment, eg mechanical overloading of an electric motor.

The selection of excess current protection

171 In principle, every main circuit should be protected at its origin, ie at the source end of the circuit. Where the rating of the conductors forming a branch circuit is less than that of the conductors from which it is drawing power, it is conventional for protection to be placed at this point. In practice, however, there are exceptions to this principle and, depending on the nature of the system, a technical judgement must be made as to where the protection should be placed. Guidance on some aspects of this subject is given in BS 7671.

172 When selecting the means of protection, you must consider a number of factors – the more important of these include:

- (a) the nature of the circuits and type of equipment to be protected;
- (b) the short-circuit energy available in the supply (the fault level);
- (c) the nature of the environment;
- (d) whether the system is earthed or not.

The nature of the circuits and type of equipment to be protected

173 The circuits to be dealt with may vary from high-power, high-voltage circuits, eg for the inter-connection of substations or for the supply to large motors, down to the smallest final circuit supplying a few low-power lamps at, say, 6 V. Over this range lies a great diversity of equipment, each item of which will possess characteristics which must be carefully considered in the selection of appropriate devices to protect against excess current.

Fault level

174 The maximum short-circuit current in the protected circuit must be considered. (The ability of circuit breakers and fuses to operate successfully and without dangerous effects, serious arcing or, in the case of oil-filled equipment, the liberation of oil, is implicit in the requirements of regulations 4 and 5.) The design of the protective arrangement must also provide for sufficient current to be available to operate the protective devices correctly in respect of all likely faults.

The nature of the environment

175 The nature of the environment may have a bearing on the choice of protective devices and their settings, eg where the possibility of a fire being started may be considerable. However, in all cases, the protection against excess current must be effective so that short circuits and earth faults are cleared promptly to minimise destructive arcing and heating. Protective devices, whether they are circuit breakers or fuses, should therefore be set or selected for the minimum tripping currents and times consistent with ensuring the reliable operation of the device and with the need to discriminate between successive stages of protection.

Earthed system

176 Where a system is earthed, the nature and efficiency of the earthing system is important in relation to the design and reliability of the protective devices. In earthed systems, operation in the event of an earth fault of the protective device is dependent on sufficient current passing to operate the excess current or earth leakage tripping device or to blow the fuse. In many systems, the device provided to comply with the requirements of this regulation in respect of excess of current (very often a fuse) may also provide protection against earth faults – and thus be in compliance with the requirements of regulation 8.

Guidance 11

Defence in criminal proceedings

177 The defence (regulation 29) is available in any proceedings for an offence under this regulation.

178 In some circumstances it will be technically impossible to achieve total compliance with the absolute requirement to prevent danger. If an excess of current is drawn due to a fault or overload, eg due to an arcing fault, then whatever form of electrical protection is provided, there will be some danger at the point of the fault during the finite time taken for the detection and interruption of the fault current. Nevertheless, electrical protection – whether by means of a simple fuse or another method – must be properly chosen and installed in accordance with good electrical engineering practice. The protection must be efficient and effective.

179 In some circumstances it is undesirable to interrupt the current in a circuit because this may itself lead to a hazard. Examples include the excitation field current of direct current motors, trip coil circuits, lifting electromagnets and the secondary circuits of current transformers. In such cases, however, the circuit should be rated or arranged so as not to give rise to danger from excess of current.

Regulation 12 Means for cutting off the supply and for isolation

Regulation 12

(1) Subject to paragraph (3), where necessary to prevent **danger**, suitable means (including, where appropriate, methods of identifying circuits) shall be available for –

- (a) cutting off the supply of electrical energy to any **electrical equipment**; and
- (b) the isolation of any **electrical equipment**.

(2) In paragraph (1), “isolation” means the disconnection and separation of the **electrical equipment** from every source of electrical energy in such a way that this disconnection and separation is secure.

(3) Paragraph (1) shall not apply to **electrical equipment** which is itself a source of electrical energy but, in such a case as is necessary, precautions shall be taken to prevent, so far as is reasonably practicable, **danger**.

Guidance 12

180 The defence (regulation 29) is available in any proceedings for an offence under this regulation.

Regulation 12(1)(a)

181 The objective of this part of the regulation is to ensure that, where necessary to prevent danger, suitable means are available to switch off the electricity supply to any piece of equipment. Switching can be, for example, by direct manual operation or by indirect operation via ‘stop’ buttons in the control circuits of contactors or circuit breakers. There may be a need to switch off electrical equipment for reasons other than preventing electrical danger but these considerations are outside the scope of the Regulations.

Guidance 12

Regulation 12(1)(b)

182 Whereas regulation 12(1)(a) requires means to be provided whereby the supply of electrical energy can be switched off, 12(1)(b) requires that there will be available suitable means of ensuring that the supply will remain switched off and inadvertent reconnection prevented. This is isolation. This provision, in conjunction with safe working practices, will enable work to be carried out on electrical equipment without risk of it becoming live during the course of that work, eg if the work is to be done under the terms of regulation 13.

183 In some cases, the equipment used to perform the requirement under regulation 12(1)(a) may also serve to perform the requirement under 12(1)(b). The two functions of **switching off** and **isolation** are not the same, even though in some circumstances they are performed by the same action or by the same equipment.

Regulation 12(3)

184 Regulation 12(3) recognises the impracticability in some cases of switching off or isolating that equipment which is itself an integral part of a source of electrical energy, eg the terminals of batteries, battery cells, photovoltaic systems, large capacitors and the windings of generators. The regulation requires precautions to be taken in these circumstances so that danger is prevented so far as is reasonably practicable. See References and further reading for details of guidance on working practices.

‘Where necessary to prevent danger’

185 The need for means to cut off the supply and effect isolation depends on factors such as likely danger in normal and abnormal conditions. This assessment may be influenced by environmental conditions and provisions to be made in case of emergencies, such as a fire in premises. It includes consideration of which electrical equipment could be a source of danger if such means were not provided and of the installation, commissioning, operational and maintenance requirements over the life of the equipment.

Suitable means for cutting off the supply

186 The suitable means for cutting off the supply (regulation 12(1)(a)) should:

- (a) be capable of cutting off the supply under all likely conditions having regard to the equipment, its normal operation conditions, any abnormal operating or fault conditions, and the characteristics of the source(s) of electrical energy;
- (b) be in a suitable location regarding the nature of the risks, the availability of people to operate the means and the speed at which operation may be necessary. Access to switches etc should be kept clear and unobstructed, free of tripping and slipping hazards etc;
- (c) be clearly marked to show its relationship to the equipment which it controls, unless there could be no doubt that this would be obvious to any person who may need to operate it;
- (d) only be common to several items of electrical equipment where it is appropriate for these to be energised and de-energised as a group.

Guidance 12

Suitable means of isolation

187 The suitable means of isolation of equipment (regulation 12(1)(b)) should:

- (a) have the capability to positively establish an air gap or other effective dielectric which, together with adequate creepage and clearance distances, will ensure that there is no likely way in which the isolation gap can fail electrically;
- (b) include, where necessary, means directed at preventing unauthorised interference with or improper operation of the equipment, eg means of locking off;
- (c) be located so the accessibility and ease with which it may be employed is appropriate for the application. The time and effort that must be expended to effect isolation should be reasonable, depending on the nature of the equipment and the circumstances under which isolation may be required. For example, a very remote means of isolation may be acceptable if isolation is only needed infrequently and any additional time taken to effect isolation does not result in danger;
- (d) be clearly marked to show which equipment it relates to, unless there could be no doubt that this would be obvious to any person who may need to operate it;
- (e) only be common to several items of electrical equipment where it is appropriate for these to be isolated as a group.

Selection of isolator switches

188 Isolator switches (or disconnectors) will often be used as the means of disconnection and securing separation from the supply. When selecting appropriate equipment, consider:

- (a) the isolating distances between contacts or other means of isolation which should meet an appropriate standard or be otherwise equally effective;
- (b) the position of the contacts or other means of isolation, which should either be externally visible or clearly and reliably indicated. An indication of the isolated position, other than by direct observation of the isolating gap, should occur when the specified isolating distance has been achieved in each pole;
- (c) provision to enable the prevention of unauthorised, improper or unintentional energisation, eg locking-off facilities.

189 For further information on the selection of isolators/disconnectors, refer to appropriate standards (see Further reading).

Regulation 13 Precautions for work on equipment made dead

Regulation 13

*Adequate precautions shall be taken to prevent **electrical equipment**, which has been made dead in order to prevent **danger** while work is carried out on or near that equipment, from becoming electrically charged during that work if **danger** may thereby arise.*

Guidance 13

190 The defence (regulation 29) is available in any proceedings for an offence under this regulation.

191 The regulation may apply during any work, be it electrical or non-electrical. The regulation requires adequate precautions to be taken to prevent the electrical

Guidance 13

equipment that has been made dead from becoming electrically charged, from whatever source, if this charging would give rise to danger. 'Charged' is discussed under regulation 2.

192 The regulation uses the term 'electrical equipment', which is defined by regulation 2 and explained in paragraphs 20–21.

The precautions

193 The precautions must be effective in preventing the electrical equipment from becoming charged in any way which would give rise to danger.

194 In the first place, the procedures for making the equipment dead will probably involve use of the means required by regulation 12(1)(a) for cutting off the supply of electrical energy. Isolation of the electrical equipment will be necessary and the means required by regulation 12(1)(b) will facilitate this. Ideally, a means of locking off an isolator can be used. Where such facilities are not available, the removal of fuses or links and their being held in safe keeping can provide a secure arrangement if proper control procedures are used.

195 These precautions will prevent the equipment from becoming charged by connection to its own or normal sources of electrical energy but may not, alone, be sufficient to prevent charging. The presence of electrical energy as a result of electromagnetic induction, mutual capacitance or stored electrical energy may have to be guarded against, eg by applying earthing connections for the duration of the work (temporary earths). The precautions may need to include means of preventing further accumulation of electrical charge, following initial discharge, because latent energy may be stored in the system, eg in the dielectric of high-voltage cables or capacitors within equipment. For work on high-voltage power distribution circuits, isolation procedures should include the application of circuit main earths (primary earths) at points of isolation and additional earthing around the point of work.

196 Where work is to be done on or near conductors that have been isolated, the conductors must be proved dead at the point of work before the task starts. Where a test instrument or voltage indicator is used for this purpose, this should itself be proved, preferably immediately before and immediately after testing the conductor (see also regulation 4(3)).

197 The regulation does not prevent the application of a test voltage to equipment, provided that this does not give rise to danger.

Written procedures

198 The safety isolation procedures should be formalised in written instructions or house rules. Safety documentation, including 'permits-to-work', may form part of the written procedures and their use is considered essential to ensuring a safe system of work where this involves work on the conductors or equipment of high-voltage power distribution systems (typically where the working voltage exceeds 1000 V) or where the system is very complex. Properly formulated and regulated 'permit-to-work' procedures focus the minds of those issuing and of those receiving the permits, both on the manner in which the work is to be done and on how the equipment has been made safe. Further advice on these procedures and precautions is in the guidance listed in References and further reading.

Guidance 13

Decommissioned equipment

199 Before electrical equipment is decommissioned, dismantled or abandoned for any reason, it must be disconnected from all sources of supply and effective steps taken to ensure that it is dead and cannot inadvertently become re-energised or dangerously charged. It may be necessary to securely mark or otherwise suitably label equipment, circuits, switches etc to guard against inadvertent re-energisation. (See also the requirement for identifying circuits under regulation 12(1).)

Regulation 14 Work on or near live conductors

Regulation 14

*No person shall be engaged in any work activity on or so near any live **conductor** (other than one suitably covered with insulating material so as to prevent **danger**) that **danger** may arise unless –*

- (a) it is unreasonable in **all** the circumstances for it to be dead; and*
- (b) it is reasonable in all the circumstances for him to be at work on or near it while it is live; and*
- (c) suitable precautions (including where necessary the provision of suitable protective equipment) are taken to prevent **injury**.*

Guidance 14

200 The defence (regulation 29) is available in any proceedings for an offence under this regulation.

201 Regulation 14 addresses the situation where, either permanently or temporarily, danger from conductors is not prevented by the precautions specified in regulation 7(a).

202 The regulation is concerned only with those situations where people are at work on or near live electrical conductors which may foreseeably give rise to danger. Such work is permitted only if conditions (a), (b) and (c) are satisfied. 'Work' is not confined to electrical work but includes any work activity, eg electrical testing.

The need for the conductor to be live

203 If danger may otherwise arise it is always preferable that work on or near electrical equipment should be carried out when that equipment is dead (see regulation 13 and guidance). Regulation 14 recognises that there are circumstances, however, in which it is unreasonable, having regard to all relevant factors, for the equipment to be dead while work proceeds. An example of this might be undertaking maintenance, checks or repairs on a busy section of electric railway track where it would be disproportionately disruptive and costly for the live conductors to be isolated for the period of the work. Other examples are in the electrical supply industry, particularly live cable jointing, and in much of the work done on telephone network connections.

204 When ordering, purchasing and installing plant, consider the manner of operation, maintenance and repair of the electrical equipment which will be necessary during its life.

205 The design of electrical equipment and of the installation should eliminate the need for live work which puts people at risk of injury. This can often be done by careful thought at the design stage of installations, for example by the provision of alternative power infeeds; properly laid out distribution systems to allow parts to be isolated for work to proceed; and by designing equipment housings etc which

Guidance 14

result in segregation of parts to be worked on and protect people from other parts which may be live.

206 Equipment which combines power and control circuitry should be arranged so that the power circuits are physically separate and segregated from logic and control circuits, or so placed, recessed or otherwise arranged that the risk of accidental contact is eliminated. Diagnostic work on the low-power/voltage circuits may then proceed with less risk to personnel. Where regular measurements of, say, voltage, current etc are to be made, consider appropriate test and measuring equipment, eg voltmeters, ammeters etc, or test points being built into the equipment.

207 Live work includes live testing, for example the use of a potential indicator on mains power and control logic circuits (but see paragraph 218).

208 The factors which should be considered in deciding whether it was justifiable for work to proceed with the conductors live should include the following:

- (a) It is not practicable to carry out the work with the conductors dead, eg where for the purposes of testing it is necessary for the conductors to be live.
- (b) To make the conductors dead will create other hazards, such as to other users of the system, or for continuously operating process plants etc.
- (c) The need to comply with other statutory requirements.
- (d) The level of risk involved in working live and the effectiveness of the precautions available set against the economic need to perform that work.

The need to be near uninsulated live conductors

209 People at work are permitted to be near live conductors only if this is reasonable in all the circumstances. If, for example, it would be reasonable for the work to be carried out at a safe distance from the conductors then it would be prohibited for that work to be done near the conductors.

210 People whose presence near the live conductors is not necessary should not be so near the conductors that they are at risk of injury. However, there may be occasions when people who do not normally need to be in the vicinity of live conductors are required to be present, eg those assisting or recovering a casualty after an incident. Appropriate measures must be put in place to protect them.

The need to take precautions to prevent injury

211 The precautions necessary to comply with regulation 14(c) should be commensurate with the risk.

212 The system of work must:

- (a) allow only people who are competent to do so to work on or near exposed, live conductors (competence for these and other purposes is further dealt with at regulation 16); *and*
- (b) indicate within what limits the work is to be attempted; *and*
- (c) indicate what levels of competence apply to each category of such work; *and*
- (d) incorporate procedures under which the person attempting the work will report back if the limits specified in the system are likely to be exceeded.

Guidance 14

213 This usually requires detailed planning before the work is started.

214 Suitable precautions should include, as appropriate:

- (a) the use of people who are properly trained and competent to work on live equipment safely (see also regulation 16);
- (b) the provision of adequate information to the person carrying out the work about the live conductors involved, the associated electrical system and the foreseeable risks (NB: when excavation work is ongoing the insulation of a cable is not an effective measure against damage to the cable or penetration of it by a mechanical tool);
- (c) the use of suitable tools, including insulated tools, equipment and protective clothing (see also regulation 4(4));
- (d) the use of suitable insulated barriers or screens (see also regulation 4(4));
- (e) the use of suitable instruments and test probes;
- (f) accompaniment by another person or people if the presence of such person or people could contribute significantly to ensuring that injury is prevented;
- (g) the restriction of routine live test work (eg product testing) to specific areas and the use of special precautions within those areas, such as isolated power supplies, non-conducting locations etc;
- (h) effective control of any area where there is danger from live conductors.

Accompaniment

215 A dutyholder's judgement as to whether someone carrying out work subject to regulation 14 should be accompanied, should be based on considerations of how injury is to be prevented. If an accompanying person can substantially contribute towards the implementation of safe working practice, then they should be present. They should be trained to recognise danger and, if necessary, to render assistance in the event of an emergency.

216 Some examples of electrical work where it is likely that the person carrying out the work should be accompanied are:

- (a) electrical work involving manipulation of live, uninsulated power conductors at, say, 230 V using insulated tools;
- (b) other work on or near bare live conductors where someone working on their own would not be capable of undertaking the work safely without assistance in, for example, keeping other people from the work area.

Control of the area

217 Where there is danger from live conductors ensure that those who are not competent to prevent the occurrence of injury, and those whose presence is unnecessary, are not permitted into the area. If the person undertaking the work is continuously present while danger exists from the live conductors, and the area is small enough to be under their constant supervision and control, then further precautions to control access may not be necessary. If, however, the area is too large or they are not continuously present, then effective control should be secured by other means, such as the provision of lockable enclosures or barriers and warning notices indicating the presence of live conductors. (The above examples are given without prejudice to the requirements of regulation 14, the criteria of which must be followed in each case before live work is undertaken.)

Testing

218 Regulation 14 will often apply to electrical testing. Testing to establish whether electrical conductors are live or dead should always be done on the assumption that they may be live and, therefore, it should be assumed that this regulation is applicable until such time as the conductors have been proved dead.

Guidance 14

219 When testing for confirmation of a 'dead' circuit, the test instrument or voltage indicator used for this purpose must itself be proved, preferably immediately before and immediately after testing the conductors.

220 Although live testing may be justifiable it does not follow that there will necessarily be justification for subsequent repair work to be carried out live.

Suitable protective equipment

221 Protective equipment suitable for the work activity should only be used as a last resort, ie when all other ways to eliminate or reduce risks have been considered.

222 Examples of equipment that can protect someone from the effects of electricity are:

- (a) suitable clothing, including insulating helmets, goggles and gloves;
- (b) insulating materials used as fixed or temporary screening to prevent:
 - (i) electric shock;
 - (ii) short circuit between live conductors;
 - (iii) short circuit between live conductors and earth;
- (c) insulating mats and stands to prevent electric shock current via the feet;
- (d) insulated tools;
- (e) insulated test probes.

223 There must be procedures for the periodic examination and, where necessary, testing and replacement of this protective equipment. See also the requirements of regulation 4(4), and References and further reading for details of guidance on working procedures, standards etc.

Emergency resuscitation and first aid

224 You should consider placing notices or placards giving details of emergency resuscitation procedures in the event of electric shock at those locations where people may be at greater risk of electric shock. Such places might include electrical test areas, substations and laboratories but, for resuscitation techniques to be effective, those required to exercise them must receive proper training and regular practice. The Health and Safety (First-Aid) Regulations 1981¹¹ make various requirements for the provision of suitably trained first-aiders at places of work.

Work near underground cables

225 Serious injuries have occurred during excavation and other work near underground power cables. This work comes within the scope of regulation 14 if there is a risk of injury from these cables.

226 Underground power cables present a risk of serious or fatal injury during excavation or similar work, particularly to people using hand tools (eg picks, concrete breakers etc). Precautions should include:

- (a) mapping, recording and marking on site of cable runs;
- (b) use of cable-locating devices;
- (c) safe digging practices.

227 Well-established advice on working near underground cables is given in *Avoiding danger from underground services*.¹²

Work near overhead power lines

228 Every year workers are killed or injured while working near to overhead power lines. They may be readily accessible to people working on elevated platforms,

Guidance 14

scaffolding or roofs. People working with tall vehicles such as cranes, tipper lorries or farm machinery, or handling metal ladders, pipes or other long articles may also be at risk from a flashover or contact with overhead power lines.

229 Well-established advice on work near overhead power lines is given in HSE guidance notes *Avoiding danger from overhead power lines*¹³ and *Working safely near overhead electricity power lines*.¹⁴

Regulation 15 Working space, access and lighting

Regulation 15

*For the purposes of enabling **injury** to be prevented, adequate working space, adequate means of access, and adequate lighting shall be provided at all **electrical equipment** on which or near which work is being done in circumstances which may give rise to **danger**.*

Guidance 15

230 The defence (regulation 29) is available in any proceedings for an offence under this regulation.

231 The purpose of the regulation is to ensure that sufficient space, access and adequate illumination are provided while people are working on, at or near electrical equipment so that they may work safely. The requirement is not restricted to those circumstances where live conductors are exposed, but applies where any work is being done in circumstances which may give rise to danger. The regulation does not require such space, access or illumination to be provided at times other than when work is being done. (But see guidance under regulation 12(1)(a) (paragraph 186(b)) in respect of safe access to means of cutting off the supply.)

Working space

232 Where there are dangerous exposed live conductors within reach, the working space dimensions should be adequate:

- (a) to allow people to pull back away from the conductors without hazard;
- (b) to allow people to pass one another with ease and without hazard.

233 Among the legal provisions revoked when these Regulations came into force were the Electricity (Factories Act) Special Regulations 1908 and 1944. Regulation 17 of those Regulations specified minimum width and height dimensions of switchboard passageways where there were bare conductors exposed or arranged to be exposed when live so that they may be touched. That regulation and the relevant definitions used are reproduced in Appendix 1. The dimensions specified were arrived at after much consideration of the circumstances in a Public Inquiry when those Regulations were being drafted. However, those dimensions can still provide guidance for an appropriate level of safety in many circumstances and where the voltages do not significantly exceed 3000 V. This does not condone the use of equipment having normally bare and exposed conductors if a safe alternative can reasonably be adopted.

Lighting

234 Natural light is preferable to artificial light, but where artificial light is necessary it is preferable that this be from a permanent and properly designed installation – in indoor switchrooms etc. However, there will always be exceptions and special circumstances where these principles cannot be achieved, eg where handlamps or

Guidance 15

torches may be the sole or most important means of lighting. Whatever level of lighting is used, it must be adequate to enable injury to be prevented. HSE guidance *Lighting at work*¹⁵ refers.

Regulation 16 Persons to be competent to prevent danger and injury

Regulation 16

*No person shall be engaged in any work activity where technical knowledge or experience is necessary to prevent **danger** or, where appropriate, **injury**, unless he possesses such knowledge or experience, or is under such degree of supervision as may be appropriate having regard to the nature of the work.*

Guidance 16

235 The defence (regulation 29) is available in any proceedings for an offence under this regulation.

236 The object of the regulation is to ensure that people are not placed at risk due to their own lack of competence in dealing with electrical equipment, or that of others.

‘... prevent danger or, where appropriate, injury ...’

237 This regulation uses both terms: ‘injury’ and ‘danger’. The regulation therefore applies to all work associated with electrical equipment where danger may arise and whether or not danger (or the risk of injury) is actually present during the work. It will include situations where the elimination of the risk of injury, ie the prevention of danger, for the duration of the work is under the control of someone who must therefore possess sufficient technical knowledge or experience – or be so supervised etc – to be capable of ensuring that danger is prevented. For example, where a person is to isolate some electrical equipment before undertaking work on the equipment, they will require sufficient technical knowledge or experience to prevent danger during the isolation. There will be no danger from the equipment during the work, provided that the isolation has been carried out properly: danger will have been prevented. However, the person doing the work must have sufficient technical knowledge or experience so as to prevent danger during that work, eg by knowing not to work on adjacent ‘live’ circuits.

238 The regulation also covers those circumstances where danger is present, ie where there is a risk of injury, as for example where work is being done on live or charged equipment using special techniques and under the terms of regulation 14. In these circumstances, people must possess sufficient technical knowledge or experience – or be so supervised etc – to be capable of ensuring that injury is prevented.

Technical knowledge or experience

239 The scope of ‘technical knowledge or experience’ should include:

- (a) adequate knowledge of electricity;
- (b) adequate experience of the electrical work being carried out;
- (c) adequate understanding of the system to be worked on and practical experience of that class of system;
- (d) understanding of the hazards which may arise during the work and the precautions which need to be taken;
- (e) the ability to recognise at all times whether it is safe for work to continue.

Guidance 16

Allocation of responsibilities

240 Employees must be trained and instructed to ensure that they understand the safety procedures which are relevant to their work and must work in accordance with any instructions or rules laid down by their employer and directed at ensuring safety.

Supervision

241 The regulation recognises that, in many circumstances, people will require some degree of supervision where they do not have sufficient technical knowledge or experience to ensure that they can undertake the work safely. Dutyholders, when allocating to supervisors responsibilities for supervision, should clearly state to the supervisor exactly what their responsibilities are and consider stating these responsibilities in writing. Where the risks involved are low, verbal instructions are likely to be adequate but as the risk or complexity increase there comes a point where the need for written procedures becomes important if instructions are to be understood and supervised more rigorously. In this context, supervision does not necessarily require continual attendance at the work site, but the degree of supervision and the manner in which it is exercised is for the dutyholders to arrange to ensure that danger, or as the case may be, injury, is prevented.

242 You should also refer to appropriate guidance, such as that in national, international, reputable foreign and harmonised or industry standards and codes of practice, or to HSE guidance, or seek expert advice.

Regulations 17–28

243 Regulations 17 to 28 and Schedule 1 inclusive were revoked by the Mines Regulations 2014.

Regulation 29 Defence

Regulation 29

In any proceedings for an offence consisting of a contravention of [regulations 4(4), 5, 8, 9, 10, 11, 12, 13, 14, 15 or 16,] it shall be a defence for any person to prove that he took all reasonable steps and exercised all due diligence to avoid the commission of that offence.*

** Amended by the Mines Regulations 2014, SI 2014/3248.*

Guidance 29

244 Regulation 29 applies only in criminal proceedings. It provides a defence for a dutyholder who can establish that they took all reasonable steps and exercised all due diligence to avoid committing an offence under regulations 4(4), 5, 8, 9, 10, 11, 12, 13, 14, 15 or 16.

Regulation 30 Exemption certificates

Regulation 30

(1) Subject to paragraph (2), the Health and Safety Executive may, by a certificate in writing, exempt –

- (a) any person;
- (b) any premises;
- (c) any electrical equipment;
- (d) any electrical system;
- (e) any electrical process;
- (f) any activity,

or any class of the above, from any requirement or prohibition imposed by these Regulations and any such exemption may be granted subject to conditions and to a limit of time and may be revoked by a certificate in writing at any time.

(2) The Executive shall not grant any such exemption unless, having regard to the circumstances of the case, and in particular to –

- (a) the conditions, if any, which it proposes to attach to the exemption; and
- (b) any other requirements imposed by or under any enactment which apply to the case,

it is satisfied that the health and safety of persons who are likely to be affected by the exemption will not be prejudiced in consequence of it.

Guidance 30

245 HSE is given power to issue general or special exemptions and to impose conditions and time limits on them. It is a standard power given to allow the variation of legal duties where, in circumstances unforeseen by those drafting the legislation, they are in practice unnecessary or inappropriate. Exemptions would be granted only in very exceptional circumstances.

Regulation 31 Extension outside Great Britain

Regulation 31

These Regulations shall apply –

- (a) in Great Britain; and
- (b) outside Great Britain as sections 1 to 59 and 80 to 82 of the Health and Safety at Work etc Act 1974 apply by virtue of the provisions of the Health and Safety at Work etc Act 1974 (Application outside Great Britain) Order 1995.

Guidance 31

246 Regulation 31 was modified by the Offshore Electricity and Noise Regulations 1997. Although the regulation refers to the Health and Safety at Work etc Act 1974 (Application outside Great Britain) Order 1995, this order has been revoked. The regulation should be read as referring to the Health and Safety at Work etc Act 1974 (Application outside Great Britain) Order 2013 (SI 2013/240).¹⁶

247 The Electricity at Work Regulations apply to all work activities on offshore installations, wells, pipelines and pipelines works and to certain connected activities within the territorial waters of Great Britain, or in the designated areas of the UK Continental Shelf. They also apply to certain other activities within territorial waters, including the construction and operation of wind farms.

Regulation 32 Disapplication of duties

Regulation 32

The duties imposed by these Regulations shall not extend to –

- (a) *the master or crew of a sea-going ship or to the employer of such persons, in relation to the normal ship-board activities of a ship's crew under the direction of the master; or*
- (b) *any person, in relation to any aircraft or hovercraft which is moving under its own power.*

Guidance 32

Sea-going ships

248 Sea-going ships are subject to other electrical safety legislation which gives protection to people on board. Regulation 32 disapplies the Electricity at Work Regulations from these ships as far as the normal ship-board activities of a ship's crew under the direction of the master is concerned. It does not disapply them in respect of other work activities however, eg where a shore-based electrical contractor goes on board to carry out electrical work on the ship. That person's activities will be subject to the Regulations within the general applicability of the Regulations. The Regulations will apply outside Great Britain only as provided for under regulation 31.

Aircraft and hovercraft

249 The Regulations may apply only while an aircraft or hovercraft is not moving under its own power.

Vehicles

250 The Regulations may apply to electrical equipment on vehicles if this equipment may give rise to danger.

Regulation 33 Revocations and modifications

Regulation 33

(1) *The instruments specified in column 1 of Part I of Schedule 2 are revoked to the extent specified in the corresponding entry in column 3 of that Part.*

(2) *The enactments and instruments specified in Part II of Schedule 2 shall be modified to the extent specified in that Part.*

(3) *In the Mines and Quarries Act 1954, the Mines and Quarries (Tips) Act 1969 and the Mines Management Act 1971, and in regulations made under any of those Acts, or in health and safety regulations, any reference to any of those Acts shall be treated as including a reference to these Regulations.*

Guidance 33

251 The Regulations replace or modify a number of statutory provisions in accordance with the intention of the HSW Act section 1(2).

252 Systems and equipment which were subject to provisions which have been revoked are now subject to these Regulations.

Appendix 1

Working space and access: Historical comment on revoked legislation (see regulation 15)

Among the legal provisions revoked upon the coming into force of the Electricity at Work Regulations 1989 were the Electricity (Factories Act) Special Regulations 1908 and 1944. Regulation 17 of those Regulations specified minimum width and height dimensions of 'switchboard passage-ways' if there were 'bare conductors' exposed or arranged to be exposed when 'live' so that they may be touched. These related to what are commonly known as 'open type' switchboards which had much exposed copper work, knife switches etc. That regulation (and the key definitions used at that time) are reproduced below for information. The dimensions which were specified by that regulation were arrived at after much consideration of the circumstances at the time. A compromise was struck between the objective of achieving the safety of those who had to work at and operate these 'open type' switchboards and the need to recognise the constraints imposed by the installations existing and the nature of the technology in 1908. Even though the dimensions were a compromise, it was widely recognised that they were a good minimum standard which had been found necessary following a number of severe and fatal accidents in factories and power stations due to inadequate space or cluttered access in the vicinity of bare live conductors at these 'open type' switchboards. The dimensions chosen allowed workmen to operate or otherwise work upon the switchboard in reasonable safety and allowed, for example, people to pass one another in the switchboard passageway without being placed at unacceptable risk of touching live conductors.

Where the need does arise to work on or near live conductors, the principles of providing adequate working space and uncluttered access/egress, which were expressed in regulation 17 of the Electricity (Factories Act) Special Regulations 1908 and 1944, should be given proper consideration.

Regulation 17 (of 1908 Regulations)

At the working platform of every switchboard and in every *switchboard passage-way*, if there be *bare conductors* exposed or arranged to be exposed when *live* so that they may be touched, there shall be a clear and unobstructed passage of ample width and height, with a firm and even floor. Adequate means of access, free from danger, shall be provided for every *switchboard passage-way*.

The following provisions shall apply to all such *switchboard* working platforms and passage-ways constructed after January 1, 1909 unless the bare conductors, whether overhead or at the sides of the *passage-ways*, are otherwise adequately protected against *danger* by divisions or screens or other suitable means:

- (a) Those constructed for *low pressure* and *medium pressure switchboards* shall have a clear height of not less than 7 ft and a clear width measured from *bare conductor* of not less than 3 ft.
- (b) Those constructed for *high pressure* and *extra high pressure switchboards*, other than operating desks or panels working solely at *low pressure*, shall have a clear height of not less than 8 ft and a clear width measured from *bare conductor* of not less than 3 ft 6 in.
- (c) Bare conductors shall not be exposed on both sides of the *switchboard passage-way* unless either (i) the clear width of the passage is in the case of *low pressure* and *medium pressure* not less than 4 ft 6 in and in the case of *high pressure* and *extra high pressure* not less than 8 ft in each case measured between bare conductors, or (ii) the *conductors* on one side are so guarded that they cannot be accidentally touched.

Key definitions used in the 1908 Regulations

Switchboard means the collection of switches or fuses, *conductors*, and other *apparatus* in connection therewith, used for the purpose of controlling the current or pressure in any *system* or part of a *system*.

Switchboard passage-way means any passage-way or compartment large enough for a person to enter, and used in connection with a *switchboard* when *live*.

Low pressure means a *pressure* in a *system* normally not exceeding 250 volts where the electrical energy is used.

Medium pressure means a *pressure* in a *system* normally above 250 volts, but not exceeding 650 volts, where the electrical energy is used.

High pressure means a *pressure* in a *system* normally above 650 volts, but not exceeding 3000 volts, where the electrical energy is used or supplied.

Extra-high pressure means a *pressure* in a *system* normally exceeding 3000 volts where the electrical energy is used or supplied.

References and further reading

References

- 1 *Electrical safety in mines* HSG278 HSE Books 2015
www.hse.gov.uk/pubns/books/hsg278.htm
- 2 *The Health and Safety at Work etc Act 1974 (c37)* The Stationery Office 1974
ISBN 978 0 10 543774 1
- 3 *Managing for health and safety* HSG65 (Third edition) HSE Books 2013
www.hse.gov.uk/pubns/books/hsg65.htm
- 4 BS 7671 *Requirements for electrical installations. IET Wiring Regulations. Seventeenth edition* British Standards Institution
- 5 *The Electricity Safety, Quality and Continuity Regulations 2002 (ESQCR)*
SI 2002/2665 The Stationery Office www.legislation.gov.uk
- 6 *Guide to effects of current on human beings and livestock. Special aspects relating to human beings* PD 60479-2:1987 IEC www.iec.ch
- 7 *Safety of equipment electrically connected to a telecommunication network*
62151:2000 IEC www.iec.ch
- 8 *Electricity at work: Safe working practices* HSG85 (Third edition)
HSE Books 2013 www.hse.gov.uk/pubns/books/hsg85.htm
- 9 *Dangerous substances and explosive atmospheres: Dangerous Substances and Explosive Atmospheres Regulations 2002. Approved Code of Practice and guidance* L138 (Second edition) HSE Books 2013
www.hse.gov.uk/pubns/books/l138.htm
- 10 *Maintaining portable electric equipment in low-risk environments* Leaflet
INDG236(rev3) HSE Books 2013 www.hse.gov.uk/pubns/indg236.htm
- 11 *First aid at work: The Health and Safety (First-Aid) Regulations 1981. Guidance on Regulations* L74 (Third edition) HSE Books 2013
www.hse.gov.uk/pubns/books/l74.htm
- 12 *Avoiding danger from underground services* HSG47 (Third edition)
HSE Books 2013 www.hse.gov.uk/pubns/books/hsg47.htm
- 13 *Avoiding danger from overhead power lines* General Guidance Note GS6
(Fourth edition) HSE 2013 www.hse.gov.uk/pubns/gs6.htm
- 14 *Working safely near overhead electricity power lines* AIS8(rev3)
HSE Books 2012 www.hse.gov.uk/pubns/ais8.htm

15 *Lighting at work* HSG38 (Second edition) HSE Books 1998 www.hse.gov.uk/pubns/books/hsg38.htm

16 *The Health and Safety at Work etc Act 1974 (Application outside Great Britain) Order 2013* SI 2013/240 The Stationery Office

Further reading

Guidance

Electrical safety and you: A brief guide Leaflet INDG231(rev1) HSE Books 2012 www.hse.gov.uk/pubns/indg231.htm

Electrical risks from steam/water pressure cleaners Plant and Machinery Guidance Note PM29 (Second edition) HSE Books 1995 www.hse.gov.uk/pubns/pm29.htm

Selection and use of electric handlamps Plant and Machinery Guidance Note PM38 (web only) HSE Books 2007 www.hse.gov.uk/pubns/pm38.htm

Electrical test equipment for use by electricians General Guidance Note GS38 (Fourth edition) HSE Books 2015 www.hse.gov.uk/pubns/gs38.htm

Electrical safety at places of entertainment General Guidance Note GS50 (Third edition) HSE Books 2014 www.hse.gov.uk/pubns/gs50.htm

Keeping electrical switchgear safe HSG230 HSE Books 2015 www.hse.gov.uk/pubns/books/hsg230.htm

Listed below are standards, codes of practice and other publications which contain guidance relevant to these Regulations and electrical safety – published by bodies other than HSE. Most of these documents are the product of technical committees on which HSE has been represented. This does not mean, however, that the documents are concerned solely with safety and users should bear in mind the scope of the safety content of these documents and the fact that they have largely been arrived at through a process of consensus.

International Electrotechnical Commission (IEC) publications

Guide to effects of current on human beings and livestock. Part 1: General aspects TS 60479-1:2005 IEC www.iec.ch

Safety of equipment electrically connected to a telecommunication network 62151:2000 IEC www.iec.ch

Extra-low voltage (ELV) – Limit values 61201:ed 2.0 2007–08 IEC www.iec.ch

Effects of current on human beings and livestock. General aspects DD IEC/TS 60479-1 www.iec.ch

Guide to effects of current on human beings and livestock. Special aspects relating to human beings PD 6519-2:1998 IEC 60479-2 www.iec.ch

Safety of equipment electrically connected to a telecommunication network IEC 62151 www.iec.ch

Extra-low voltage (ELV) – Limit values IEC 61201 ed 2.0 www.iec.ch

British Standards

The following British Standards are relevant to different aspects of electrical safety. The up-to-date version of each standard is available from BSI on <http://shop.bsigroup.com> (see Further information).

BS 4363 *Specification for distribution assemblies for reduced low voltage electricity supplies for construction and building sites*

BS 4444 *Guide to electrical earth monitoring and protective conductor proving*

BS 6423 *Code of practice for maintenance of low-voltage electrical switchgear and controlgear*

BS 6626 *Maintenance of electrical switchgear and control gear for voltages above 1 kV and up to and including 36 kV. Code of practice*

BS 6867 *Maintenance of electrical switchgear for voltages above 36 kV. Code of practice*

BS 7375 *Distribution of electricity on construction and building sites. Code of practice*

BS 7430 *Code of practice for protective earthing of electrical installations*

BS 7671 *Requirements for Electrical Installations. IET Wiring Regulations. Seventeenth edition*

BS 7909 *Code of practice for temporary electrical systems for entertainment and related purposes*

BS EN 50050 *Electrostatic hand-held spraying equipment. Safety requirements (50050 series, see Parts 1, 2 & 3)*

BS EN 60034 *Rotating electrical machines. Degrees of protection provided by the internal design of rotating electrical machines (IP Code). Classification*

BS EN 60079 *Explosive atmospheres (60079 series, see Parts 0, 14, 17, 31)*

BS EN 60204-1 *Safety of machinery. Electrical equipment of machines. General requirements*

BS EN 60529 *Degrees of protection provided by enclosures (IP Code)*

BS EN 60903 *Live working. Gloves of insulating material*

BS EN 60947 *Low-voltage switchgear and controlgear (60947 series, see Parts 1, 2)*

BS EN 61111 *Live working. Electrical insulating matting*

BS EN 61439-1 *Low-voltage switchgear and controlgear assemblies. General rules*

BS EN 61439-2 *High-voltage switchgear and controlgear. Alternating current circuit breakers*

BS EN 62271 *High-voltage switchgear and controlgear (62271 series, see Parts 100, 102)*

BS EN 62305-1 *Protection against lightning. General principles*

BS EN 81-20 *Safety rules for the construction and installation of lifts. Lifts for the transportation of persons and goods. Passenger and goods passenger lifts*

PD CLC/TR 50404 *Electrostatics. Code of practice for the avoidance of hazards due to static electricity*

Useful web links

www.hse.gov.uk/construction/safetytopics/electricity.htm

International Electrotechnical Commission (IEC) www.iec.ch

Further information

For information about health and safety, or to report inconsistencies or inaccuracies in this guidance, visit www.hse.gov.uk/. You can view HSE guidance online and order priced publications from the website. HSE priced publications are also available from bookshops.

British Standards can be obtained in PDF or hard copy formats from BSI: <http://shop.bsigroup.com> or by contacting BSI Customer Services for hard copies only Tel: 0845 086 9001 email: cservices@bsigroup.com.

The Stationery Office publications are available from The Stationery Office, PO Box 29, Norwich NR3 1GN Tel: 0870 600 5522 Fax: 0870 600 5533 email: customer.services@tso.co.uk Website: www.tsoshop.co.uk. (They are also available from bookshops.) Statutory Instruments can be viewed free of charge at www.legislation.gov.uk where you can also search for changes to legislation.

This publication is available at www.hse.gov.uk/pubns/books/hsr25.htm.

APPENDIX C

HSE Guidance HSG230 Keeping Switchgear Safe

Keeping electrical switchgear safe



HSG230 (2nd edition)
Published 2015

Failure of electrical switchgear can cause death, serious injury and major damage. If you own or operate this type of equipment in industrial or commercial organisations, this book is mainly aimed at you. It should help you to select, use and maintain switchgear safely and reduce the risk of accidents.

© *Crown copyright 2015*

First published 2002
Second edition 2015

ISBN 978 0 7176 6557 0

You may reuse this information (excluding logos) free of charge in any format or medium, under the terms of the Open Government Licence. To view the licence visit www.nationalarchives.gov.uk/doc/open-government-licence/, write to the Information Policy Team, The National Archives, Kew, London TW9 4DU, or email psi@nationalarchives.gsi.gov.uk.

Some images and illustrations may not be owned by the Crown so cannot be reproduced without permission of the copyright owner. Enquiries should be sent to copyright@hse.gsi.gov.uk.

This guidance is issued by the Health and Safety Executive. Following the guidance is not compulsory, unless specifically stated, and you are free to take other action. But if you do follow the guidance you will normally be doing enough to comply with the law. Health and safety inspectors seek to secure compliance with the law and may refer to this guidance.

Contents

Introduction 5

- Scope 5
- Background 5
- What does the law require? 5

Switchgear safety 6

- Understand your system 6
- Maintenance 7
- Design rating and system modifications 8
- Design modifications and limitations on use 8
- Dependent manual operating mechanisms 8
- Anti-reflex handles 9

Management of switchgear 9

- Management systems 9
- Training and competence 10
- Operational safety documents 11
- Network diagram 12
- Maintenance systems and asset registers 12
- Maintenance records 13

Operation of switchgear 13

- Fault level and ratings 13
- Effect of on-site generation and other large rotating machines 14

Reducing the risk of switchgear failure 14

- Overstressed switchgear 14
- Dependent manually operated (DMO) switchgear 15
- Fault clearance 16

Care and maintenance of HV switchgear: Common requirements 16

- Time-based preventive maintenance 16
- Condition-based maintenance 17
- Reliability-centred maintenance (RCM) 18
- Switchgear availability 18
- Trip-testing 18
- Protection testing 19
- Tests to be undertaken following maintenance 19
- Routine inspection of substations and switch rooms 19
- Signs of abnormal conditions 19
- Equipment environment 20
- Visual examination of switchgear 20
- General services 20
- Circuit-breakers subject to special duty 21
- Disposal issues, post-maintenance 21

Care and maintenance of oil-filled switchgear 21

- Maintenance procedures 22
- Frequency of maintenance 23

Cleaning and inspection of oil-filled switchgear 23
Tank cleaning techniques 24
Insulating oil 24
Post-fault maintenance of oil-filled circuit-breakers 25

Care and maintenance of non-oil switchgear 25

General guidance 25
Maintenance procedures: Vacuum switchgear 26
Maintenance procedures: Air-brake switchgear 27
Maintenance procedures: SF₆ switchgear 27
SF₆ gas handling and safety precautions 28
Release of SF₆ 28
Hazards 28
Sampling 29

Care and maintenance of ancillary equipment 29

Test probes 29
Earthing equipment 30

Assessment of aged switchgear 31

Protection 34

Protection relay schemes 34
Fuse protection 35
Batteries and chargers 35

Selection of new, replacement or refurbished switchgear 36

General advice 36
Retrofit circuit-breakers for withdrawable switchgear 37
Second-hand equipment 37

Measures to limit fires 37

Compartmentation 37
Control and extinction 37
Detection 37
Safety issues 38

Appendix 1: Examples of switchgear configurations 39

References and further reading 47

Glossary 49

Further information 50

Introduction

1 This guidance is aimed at owners and operators of electrical switchgear in industrial and commercial organisations. It may also be useful to others. It will help managers, engineers and others to understand their responsibilities and duties in the selection, use, operation and maintenance of high-voltage switchgear. Some knowledge of electrical switchgear and distribution systems is necessary to gain most benefit from this document. Owners and operators of electrical switchgear with little electrical knowledge or expertise should refer to *Electrical switchgear safety: A guide for owners and users*.¹

Scope

2 Guidance is given on the selection, use, operation and maintenance of three-phase electrical switchgear with voltage ratings from 1 kV alternating current (AC) up to and including 33 kV AC. This includes circuit-breakers, switches, switch fuses, isolators and high-voltage (HV) contactors that use oil, air, sulphur hexafluoride (SF₆) or vacuum as the interrupting medium. Guidance is also provided on assessing risks associated with aged switchgear and the actions necessary when considering replacement or refurbishment of switchgear. Low-voltage (ie below 1 kV) equipment is out of the scope of this guidance, although some references are made to low-voltage (LV) equipment where it is an essential part of an HV system.

3 This guidance does not address direct current (DC) switchgear, switchgear used on single-phase AC traction systems, or power electronic switching devices used at high voltage such as inverters, cyclo-converters and rectifiers.

Background

4 Switchgear failures are rare, but when they do occur, the results can be catastrophic. In the case of oil-filled switchgear, burning oil and gas can be ejected, causing death or serious injury to people who may be nearby, and major damage to equipment and buildings. Switchgear using SF₆ gas or vacuum as the insulating medium presents other risks that need to be controlled and managed.

5 Failures are most likely to occur during, or shortly after, switchgear operation. The way switchgear is operated, its condition and the conditions in the electrical system at the time it operates will largely determine whether it will function safely.

What does the law require?

6 The Health and Safety at Work etc Act 1974 (the HSW Act),² the Management of Health and Safety at Work Regulations 1999 (the Management Regulations)³ and the Electricity at Work Regulations 1989 (EAWR)⁴ are applicable to the selection, use, operation and maintenance of high-voltage switchgear. The HSW Act also places duties on the manufacturers of switchgear.

7 Older switchgear may contain parts that were manufactured from asbestos or asbestos-containing materials (ACMs). The Control of Asbestos Regulations 2012⁵ place a duty on those who have responsibility for the maintenance and repair of equipment to manage the risks from the potential for exposure to asbestos. This includes the responsibility to determine if asbestos is present so that others can be made aware of the hazard and take appropriate action. Advice should be sought from the original equipment supplier or a specialist maintenance provider on the likelihood of asbestos or ACMs being present in switchgear.

8 The HSW Act requires employers to ensure, so far as is reasonably practicable (see paragraph 11), the safety of employees and other people who may be affected by their activities. Similarly, self-employed people while at work must ensure that they do not expose themselves to risks to their own health and safety, and that they do not affect the health and safety of others.

9 The Management Regulations require an employer or self-employed person to make an assessment of the risks to employees and others. To do this, they should consider what might cause harm to people and decide whether they are doing enough to prevent that. For more information on risk assessment, see *Risk assessment: A brief guide to controlling risks in the workplace*.⁶

10 The EAWR requires electrical equipment, which includes switchgear, for use at work to be constructed, maintained and operated in such a way as to prevent, so far as is reasonably practicable, danger. Electrical equipment, including switchgear, must not be used where its strength or capability may be exceeded, unless it is used in such a way that nobody could be exposed to danger. This includes protection against the effects of excess current and exposure to the physical environment in which the switchgear is located. People who work on or near to electrical equipment, and those responsible for managing such work activities, must be suitably competent for the activity to be undertaken (ie they must have the appropriate level of technical knowledge or experience). Alternatively, those working on switchgear must be suitably supervised.

11 'So far as is reasonably practicable' means balancing the level of risk against the measures needed to control the real risk in terms of money, time or trouble. However, you do not need to take action if it would be grossly disproportionate to the level of risk. In the context of HV switchgear, the procedures to select and maintain suitable equipment and to ensure the safety of those working on or near it are well established. These are supported by existing standards, guidance and training qualifications. Many organisations successfully apply these measures to the management of their switchgear. For certain work activities on switchgear, there can be a risk of death, and this must be taken into account when considering the measures needed to ensure safety when such tasks are completed. For more information, see *Risk assessment: A brief guide to controlling risks in the workplace*.

Switchgear safety

12 The use, maintenance and operation of high-voltage switchgear must be managed to prevent both the equipment giving rise to danger and to ensure the safety of the people who use it. Allowing equipment to become unsafe and, as a result, exposing people to danger during its use is likely to breach the law. Oil-filled switchgear presents particular issues not encountered with other types of equipment.

Understand your system

13 Switchgear varies in size, age and appearance. Examples are shown in Appendix 1. Different types of switchgear such as switches, isolators, switch fuses, contactors and circuit-breakers have different switching and fault-handling capabilities. It is important to be able to recognise the different types of switchgear and understand the differences in their capability. Failure to do so can result in switchgear being used incorrectly, which may be dangerous for the operator.

14 Some switchgear may appear to be of robust construction due to its size. Despite appearances, it may have limited operational capability and be restricted in

the way it should be used. Any limitations or restrictions must be understood by those who operate or maintain the equipment.

15 HV switchgear may be located close to machinery controlled by it. People who have access to the switchgear may not be electrically competent, but must be made aware of its presence and the potential hazards associated with it. They should know what to do if they notice anything unusual or wrong with the switchgear.

16 In certain industries, the location of switchgear in relation to the process activity is important. For example, for explosives manufacture and storage, HV equipment should be sited outdoors, see *Explosives Regulations 2014: Safety provisions. Guidance on Regulations*.⁷ It is important that the location of HV switchgear is considered if the use of a premises changes.

17 Switchgear must only be operated by people who are competent to do so. Being competent means having sufficient knowledge or experience to prevent danger or injury; or being under such degree of supervision as may be appropriate for the nature of the work. Switchgear operated incorrectly can result in danger both to those operating it and others. Experience will include an understanding of the operation of the switchgear and knowledge of the arrangement of the system in which it is installed. People who are required to operate older switchgear must be specifically trained and experienced in its use. They must be aware of its limitations. People trained only on more modern equipment may not have such knowledge.

18 People with the necessary competence to operate switchgear are often referred to as 'authorised persons'. A system should be in place to assess and appoint the people who can operate switchgear (authorised persons), record who they are, what training they have received, what experience they have, what items of switchgear they are permitted to operate, and what duties they are authorised to undertake. If no one within an organisation has the necessary competence to make the assessments to appoint people or to operate switchgear, someone should be developed to fulfil this role, or it must be given to an independent organisation with the necessary competence. It may be necessary to consider arrangements for support outside normal working hours. Even if the operation and maintenance of switchgear is contracted to an external provider, the owner of the switchgear retains a legal responsibility for its safe operation and maintenance.

19 A number of organisations (eg electricity distribution companies or specialist training organisations) can provide training. Attending a training course alone is unlikely to demonstrate that an individual has adequate technical knowledge or experience to satisfy the legal requirement for competence. Depending on the work to be undertaken, it is likely that specific experience of the switchgear to be operated and an understanding of the system in which it is installed will be necessary to prevent danger.

Maintenance

20 A system must be in place to ensure that switchgear is maintained appropriately by people competent to do so, at an appropriate frequency to provide assurance that it remains in a safe condition. Oversights, lack of knowledge, lack of the necessary skills, or concerns over the impact of a loss of power are common reasons for failing to maintain HV switchgear. Failure to carry out maintenance may result in the switchgear not operating when required to do so. This can place unnecessary stress on switchgear elsewhere within a system and result in more extensive damage if faults do occur. The switchgear may also become dangerous to operate.

Design rating and system modifications

21 Switchgear is described as being 'overstressed' when it is operated beyond its design rating. This could be due to excess load or where the fault energy (the energy that the switchgear would need to carry, make or interrupt in the event of an electrical fault) exceeds the capability of the switchgear. If required to operate under these conditions, overstressed switchgear may not cope with the electrical, magnetic and thermal stresses imposed upon it. This can result in it failing catastrophically with the potential to cause injury. Switchgear must not be used where its strength and capability may be exceeded, unless it is used in such a way that nobody could be exposed to danger.

22 When originally installed, switchgear should have been adequately rated for the duty it was intended to perform. Changes to an electrical system can result in switchgear becoming overstressed. Careful consideration must be given to system modifications to ensure that dangerous conditions are not created. Changing the configuration of a system through switching operations that put transformers into parallel operation can result in an increase in fault energy. Such arrangements may result from a response to abnormal system conditions or be necessary during planned maintenance work. Interlock systems should be used to prevent overstressing in such circumstances. Where it is not possible to use interlocks, clear operating instructions must be provided to prevent configurations that have the potential to overstress switchgear.

Design modifications and limitations on use

23 During the life of switchgear, defects with the original design or manufacturing process may become apparent. Manufacturers may recommend modifications, some of which may be required for the continued safe operation of the switchgear. While manufacturers must inform the original purchaser of modifications required to prevent danger, it is the current owner and operator of the switchgear who has the legal duty to ensure it remains safe. Audits at appropriate intervals can be helpful to identify switchgear that may require modification. These could involve either the switchgear manufacturer or specialist maintenance providers. Modifications essential for safety must be completed. If defects relating to safety are identified and result in restrictions on the use of switchgear, the people who operate or maintain the equipment must be made aware of the restrictions so that they can perform their work safely.

Dependent manual operating mechanisms

24 Dependent manual operating (DMO) mechanisms used to be fitted to both HV and LV switchgear. Although no longer made, they may still be in use on some systems. In switchgear fitted with DMO mechanisms, the operator opens and closes the contacts within the switchgear solely by manual effort. Movement of the contacts is dependent on the speed and actions of the operator. Hesitancy can lead to failure of the switchgear with potentially fatal consequences. Under some circumstances, such as operation during fault conditions, it may be physically impossible to close a DMO switch due to the electromagnetic forces involved. Attempting to operate switchgear under fault conditions can cause it to fail.

25 Where DMO switchgear is in service, it must only be used by people who have been trained specifically in its use and are aware of the potential danger associated with its operation. In general, the switchgear should only be operated after first being made dead by the operation of other switchgear which is suitably rated and does not have a DMO mechanism. Similarly, it should only be put back into service through the operation of such switchgear. See paragraphs 56–59 for further information on DMO switchgear.

26 There is a foreseeable risk associated with the use of DMO switchgear. It is foreseeable that such equipment present within an electrical system may at some time be used. It is a legal requirement that all systems shall at all times be of such construction as to prevent, so far as is reasonably practicable, danger. It is highly recommended that DMO switchgear is replaced.

Anti-reflex handles

27 Oil switches, such as those incorporated within ring main units, may be rated to close onto a fault but not to interrupt fault current (sometimes referred to as fault make, load break switches). Where switchgear using oil switches is also fitted with integral earthing, incidents have resulted when a failure to check the position of the selector mechanism has led to operators switching from OFF to EARTH instead of from OFF to ON. This action has the potential to put an earth fault onto the HV system. This is not necessarily a dangerous situation as oil switches are designed to close onto a fault, but danger arises if the operator, realising that a mistake has been made, instinctively reacts and attempts to open the switch. Oil switches are not rated to interrupt fault current, and where this has occurred, switches have failed, causing serious injury to the operator.

28 To address this problem, manufacturers supply 'anti-reflex' handles. These are handles that have to be removed and re-inserted before they can be used to reverse the operation of an oil switch. They are provided to ensure that if a mistake is made, it is not possible to immediately reverse a switching action. This may allow sufficient time for circuit protection to operate, clearing a fault by operating a circuit breaker or other device designed to break fault current, or it will provide thinking time for an operator before making the conscious decision to reverse a switching action.

29 A review of oil switches and oil switch fuses present on a system should be undertaken to determine if anti-reflex handles have been provided. If not, it is advisable to replace standard handles with anti-reflex handles.

Management of switchgear

Management systems

30 Establishing and implementing a formal system for the management and control of an electrical distribution system is an effective and practical way of demonstrating compliance with a number of legal requirements. When correctly implemented, a management system can help address the safety issues identified with the operation, use and maintenance of HV switchgear. A management system for a distribution system need not be complex; the requirements should be proportionate to the complexity of the system.

31 Record keeping is an important part of a management system, in terms of having both adequate information about the equipment on a system, and information about the competency and responsibilities of those authorised to work on it. A management system for HV switchgear may include:

- policies and procedures for the installation, commissioning, operation and maintenance of HV switchgear. These should include the arrangements for authorising people to work on the switchgear and the training, experience and development requirements to be satisfied before people are authorised to operate switchgear. Procedures should include safe systems of work which are likely to include the use of safety documents such as permit-to-work systems (see *Electricity at work: Safe working practices*);⁸

- manufacturers' operating instructions for each item of switchgear and associated ancillary equipment (such as battery chargers, protection relays and fire detection systems). This should include access to any safety bulletins issued by the equipment manufacturers;
- drawings (such as a network diagram – see paragraph 41) and technical information (such as protection type, grading and fault level studies);
- definition of responsibilities and training records for people who have been authorised to use or work on the equipment;
- maintenance and operating records; recording the results of maintenance activities, repairs, modifications and any significant faults that may have occurred for each item of equipment; and
- systems for auditing the effectiveness of the management system, records of the audits completed and the actions taken to rectify any deficiencies found.

32 Policies and procedures should be developed by people who have an understanding of the risks associated with HV switchgear and the specific system in which it is installed. Competent staff should implement the policies and procedures and review the effectiveness of the management system. If the expertise necessary to do this is not available in-house, someone should be developed to obtain this expertise, or assistance should be sought from others. Assistance may be obtained from:

- distribution network operators;
- electricity generators;
- switchgear manufacturers;
- switchgear maintenance providers;
- consulting organisations specialising in switchgear and HV training; and
- technical services companies.

33 The British Electrotechnical and Allied Manufacturers Association (BEAMA) can provide up-to-date details of manufacturers (see www.beama.org.uk).

Training and competence

34 People who are required to operate or maintain switchgear must be competent to do so. Being competent means having sufficient knowledge or experience to prevent danger or injury, or to be under such degree of supervision as may be appropriate for the nature of the work. Appropriate training must be given to enable such people to carry out their duties safely and without risk to health. It is also important that they understand the limits of what they are able to do, including tasks they must not undertake unless appropriately supervised. It is unlikely that attending a training course on its own will enable someone to demonstrate competence in all circumstances. Appropriate supervision may also be necessary. A number of organisations offer training courses, from general appreciation of site access and responsibilities through to detailed courses on operation, safety and maintenance practice etc. Training providers include:

- distribution network operators;
- switchgear manufacturers; and
- technical services companies.

35 To ensure that the different types of activity necessary when operating and maintaining switchgear are performed safely, it is useful to define levels of authorisation for people. This will enable a clear definition of the duties that are expected to be documented. It will also help the people who carry out work to understand the limitations of what they are authorised to do and what they should not do. For example, someone trained to close a circuit breaker as part of an

isolation procedure may not be authorised to close the same circuit breaker if it has operated due to the detection of a fault condition.

36 Typically, there will be a designated competent person or persons (also known in some industries as an 'authorised person' or 'senior authorised person', depending on their level of responsibility). The description 'competent person' (or 'authorised person') in the context of someone appointed to operate switchgear implies:

- a person appointed by the employer, preferably in writing, to undertake certain specific responsibilities and duties, which may include the issue and/or receipt of safety documents such as permits-to-work. The person must be competent by way of training, qualifications and/or experience and knowledge of the system to be worked on.

Operational safety documents

37 The implementation of a safety document scheme, generally referred to as a permit-to-work system, is recommended as part of a safe system of work for the use, care and maintenance of high-voltage switchgear. The naming of documents may vary between organisations, but most schemes will include three types of control document:

- limitation of access – issued to define the physical limits within which a work activity may be carried out, specifying any precautions necessary and hazards that may be present within the work area;
- permit-to-work – when issued, clearly identifies the equipment to be worked on, the work to be carried out and the actions taken to achieve the conditions which safeguard people working from the dangers which are inherent in an HV system. A permit-to-work should never be issued on equipment that is still live; it should only be issued when the measures required for safety have been completed; and
- sanction for test – issued to allow specified HV equipment to be tested, identifying the conditions under which the testing is to be carried out and the actions taken to safeguard the people performing the test, and anyone else who may have access to the area. A sanction for test may allow temporary earth connections applied as part of the protective measures specified for a work activity to be removed for the purposes of testing.

38 HV permits-to-work should not be used for general work control purposes. Further guidance on their use can be found in *Electricity at work: Safe working practices* and BS 6626.⁹

39 Everyone who is reliant on operational safety documents for their safety should be familiarised with the relevant procedures and made aware of their responsibilities. A permit-to-work should only be issued by someone who is competent and authorised to do so. Permits-to-work should only be given to people capable of understanding the precautions and limitations of the activity described on the permit. Ideally, a permit should be issued at the work location and the task clearly explained to the recipient before the permit is handed over. The recipient of a permit is responsible for ensuring that the safety precautions identified are adhered to, and that only the permitted work is completed, confined to the area defined in the permit. It is important that the recipient understands these responsibilities and is, to the best of their knowledge, satisfied that the precautions are adequate for the work they or their work group are about to complete when the permit is received. When work is to be carried out on HV switchgear or equipment, it is likely that those doing the work will need to be designated 'competent persons'.

40 Working alone should be avoided whenever possible. If the person issuing the permit will also be doing the work, it is strongly recommended that someone else makes an independent check of the control measures. It is important that the person doing the work follows the process of issuing and receiving the permit in full, even though it is their signature on both parts of the document. Following this process reinforces the requirement to consider the risks associated with the task and the identification of the safety precautions required. It also helps to confirm that the necessary precautions have been put in place before work begins. Accidents have occurred when experienced people have failed to implement the requirements of permit systems.

Network diagram

41 A network diagram (also referred to as a single line diagram) is a schematic representation of an electrical network identifying the interconnection of an electrical distribution system from the supply intake point(s) to the loads that it feeds. It provides an overview of the system and identifies all the switchgear and its location within the network. A network diagram is an important reference document for the operation and maintenance of an HV system.

42 The network diagram should include prospective fault current/energy values and information about the capability of switchgear. It is a useful way to record and communicate operational restrictions such as those created by the presence of overstressed equipment or DMO switchgear. It can also be used to identify the interaction of the LV system with the HV system, which is important if there are alternative sources of energy on the LV network.

43 A network diagram can be used to identify network configurations that may increase fault levels or other operations that need to be avoided to prevent danger. It can be used for the development of safe operating procedures. It can also help to identify the different types of equipment present on a network for which training may be required.

44 For all but the most simple distribution system, a network diagram is an important reference document for the planning, coordination and control of work activities. It should be accurate and up-to-date. Providing an up-to-date copy in each substation on a site with multiple substations can provide a useful reference, particularly during abnormal system conditions. In this situation, diagrams should be controlled through an appropriate management system to ensure they stay up-to-date.

Maintenance systems and asset registers

45 Many businesses use maintenance management systems for the scheduling and recording of maintenance work. Corporate requirements are likely to determine the choice of system used. Most maintenance systems will incorporate an asset register to identify all items of equipment that require maintenance. Asset registers can usefully be used to store and reference records relating to switchgear. A maintenance system can drive inspections and preventative maintenance processes based on the equipment identified in the asset register, ensuring that equipment is not overlooked. Some form of hierarchical structure is useful within an asset register to enable referencing on larger systems. Such structures need not be complex. There are legal requirements to maintain equipment so that it does not give rise to danger. Typical information in an asset register for an item of switchgear may include:

- physical location;
- manufacturer and type reference, including the standard to which the equipment was manufactured;

- serial number and year of manufacture;
- date of installation;
- voltage rating, current rating, fault rating;
- type of operating mechanism (dependent manual, independent manual, dependent power, independent power and stored energy);
- details of any modifications, eg fitted anti-reflex handles;
- type of electrical protection installed and details of the settings;
- references to the location of manufacturer's data sheets, drawings and operating and maintenance instructions; and
- references to the location of maintenance records and other history associated with the operation and use of the equipment.

Maintenance records

46 Records are a key part of an effective maintenance system. Keeping records provides confidence that maintenance has been completed and, when used with an asset register, can be used to verify that the maintenance of switchgear has not been missed. Measurements recorded during maintenance inspections are useful in determining switchgear performance, as trends in recorded values are often more valuable than specific, one-off measurements. Trends and historical data may be used to assess the effectiveness of a maintenance programme or justify chosen maintenance frequencies.

47 A maintenance record for an item of switchgear will typically include:

- the date on which the work was performed and confirmation of the item worked on;
- who performed the work and a schedule confirming what was done;
- any observations or comments made during the maintenance, including any recommendations for further work;
- the results of any tests or measurements taken, including a record of functional checks when completed; and
- a means of raising urgent or important findings that may mean intervention is required before the next scheduled maintenance period.

Operation of switchgear

Fault level and ratings

48 Electrical equipment must not be used where its strength and capability may be exceeded, unless it is used in such a way that nobody could be exposed to danger. Before operating any switchgear, you have to determine if the switchgear is capable of performing the duties expected of it. British Standards or other standards (see 'Further reading') relevant to the manufacture of switchgear may provide information about fault-handling capability. Details may also be found on the rating plate of the switchgear itself. System studies are likely to be required to determine the fault current/energy level at the specific point in a system where the switchgear is installed, although this may not be necessary if the rating of the equipment cannot be exceeded. Where switchgear was designed to now obsolete British Standards, reassessment of the rating by the original manufacturer or switchgear specialists may be necessary.

49 To determine the fault current/energy at each point in a network, it may be necessary to include the fault energy contribution from rotating plant such as large induction motors, synchronous motors and generators. Where practical, for more complex networks, fault current/energy calculations should be performed

for all possible configurations of the network, as fault levels are likely to vary depending on the network configuration. The distribution network operator (DNO) responsible for the supply from the public supply network has a legal obligation to provide, on request, the maximum short-circuit current at the incoming supply terminals (see the Electricity Safety, Quality and Continuity Regulations 2002, regulation 28).¹⁰

50 The calculation of fault current/energy is a specialist topic, and is likely to require support from people experienced in undertaking and interpreting such calculations. Many specialists use software modelling of electrical networks to determine fault levels.

51 The information from a fault current/energy study can be recorded on a network diagram and referenced against the known ratings of the switchgear. In this way, it is possible to identify and communicate the presence of overstressed switchgear and identify any network configurations that may lead to equipment becoming overstressed.

Effect of on-site generation and other large rotating machines

52 On-site generation and large rotating machines can have an impact on the duty required of switchgear. Both contribute to fault current/energy, and this must be taken into account when determining if switchgear is adequately rated. Where a network includes large machines, the following actions should be taken:

- check that the fault current/energy at the circuit-breaker(s) controlling generators and other large rotating machines is within the capability of the circuit-breaker(s), paying particular attention to older switchgear. If the capability of the switchgear is exceeded, then treat the circuit-breaker(s) as overstressed;
- provide equipment to ensure that generators and synchronous motors are synchronised before it is possible to close the controlling circuit-breaker(s). Attempting to close a generator or synchronous motor circuit-breaker or switch onto networks that are not synchronised can lead to overstressing and damage to the driven plant;
- estimate the effects of transient voltages that may be created in a network when clearing a fault being fed by a generator or by the inertia of large, rotating machines. If this exceeds the rating of the circuit-breaker(s), treat the circuit-breaker(s) as overstressed; and
- confirm whether the protection settings in use are appropriate for the situations when the generator is operating and when it is not operating. For guidance, refer to the Energy Network Association publication ER G59/3.¹¹

Reducing the risk of switchgear failure

Overstressed switchgear

53 Where switchgear has been identified as being overstressed, immediate precautions must be implemented for safety. These may include:

- preventing people gaining access to the area containing the switchgear while it is live (blast protection may be needed if access into the immediate area such as combined HV/LV rooms cannot be prevented);
- prohibiting operation of the switchgear unless it has been made dead;
- disabling automatic tripping of the switchgear. Protection elsewhere may need to be adjusted to ensure adequate levels of fault protection for the system; and

- reducing the fault current/energy, eg by operating transformers as single feeders rather than in parallel.

54 The immediate precautions are intended as short-term measures to be implemented for safety on determining that switchgear is overstressed. Unless the situation can be remedied, the switchgear must be replaced. Fault current/energy may be reduced by the installation of reactors or reconfiguration of the network. Where network configuration is critical to the safe operation of switchgear, interlocking should ideally be fitted to prevent overstressing. Being aware that equipment is overstressed, and failing to take action to prevent danger, is likely to be a breach of the law.

55 Where overstressed switchgear has to remain connected to a network while arrangements are made to resolve the issue, it is important to have confidence that the switchgear is in good condition. If there is doubt about its condition, it should be maintained in accordance with the manufacturer's instructions. While this action will not remedy the situation, it may lessen the risk of catastrophic failure while the switchgear is in use. In making the switchgear available for maintenance, the guidance given in paragraphs 53–54 should be followed and the switchgear must not be operated unless it has been made dead.

Dependent manually operated (DMO) switchgear

56 DMO mechanisms are generally found only on older types of oil and air circuit-breakers. The risks associated with the use of this type of switchgear have been described in paragraphs 24–26. Even in situations where the equipment is known to be in good condition and its use is restricted to appropriately trained people, its live operation creates a foreseeable risk of injury. Safety is dependent on the physical actions of the operator. Its presence on a live system makes it foreseeable that it may be operated live, despite procedures that may be in place intended to prevent its use. It is a requirement in law that all systems shall be constructed at all times so as to prevent, so far as is reasonably practicable, danger. In HSE's view, the presence of this type of equipment on a system is likely to lead to a breach of the law. DMO switchgear has not been manufactured for many years, and the dangers associated with its use have been widely publicised. It is HSE's opinion that this equipment should have been replaced with switchgear that does not have a DMO mechanism.

57 For some DMO switchgear, it may be possible to fit a power closing mechanism. Only power closing mechanisms specifically designed and approved by the original equipment manufacturer should be used. The equipment then ceases to have a DMO mechanism. Where power closing mechanisms can be or have been fitted, it is essential that the owner of the switchgear is able to determine the fault-handling capability of the modified equipment to ensure that the modified switchgear is not overstressed. The determination of the fault-handling capability of DMO switchgear manufactured before the 1960s is likely to be difficult to achieve. The fitting of power closing mechanisms to equipment of this age is unlikely to resolve all of the issues associated with its safe use, and it should be replaced.

58 If DMO switchgear is found to be present in a system, its operation and maintenance must be restricted to specifically trained people. There are few circumstances where it is acceptable to operate such equipment live. Even in such cases, it is advisable to operate the equipment only after it has been made dead. When DMO switchgear is to be closed, the recommended method of operation is:

- make the system dead upstream using a suitably rated switch or circuit-breaker;
- check, where practicable, the system beyond the DMO switchgear to ensure that it is fault-free;

- close the DMO switchgear to ON (while dead); and
- energise the system from the remote point, ensuring that no people are in the vicinity of the DMO switchgear.

59 Provided the DMO switchgear is not overstressed and the risks from its operation whilst live are reduced then, in the following circumstances only, live operation of the switchgear may take place subject to risk control measures being carried out:

- bus-section and bus-coupler circuit-breakers on a fully energised system (ie live both sides);
- circuit-breakers controlling circuits which have been tested immediately before closure; and
- where the DMO switchgear has recently been operated for the purpose of routine isolation, it may be reclosed manually, providing the electrical circuit it feeds has not been disturbed.

Fault clearance

60 Circuit-breakers should be inspected after clearing a fault before being put back into service. In some situations, such as auto-reclosing systems for overhead power line protection, a number of reclose operations may be permitted before the circuit-breaker is locked out. Following inspection, if a circuit-breaker shows any signs of distress, it must be maintained before being put back into use. Signs of distress include a smell of burning or ozone on entering the substation, the ejection of oil from the circuit-breaker if it is oil-filled, distortion of the tank or enclosure, signs of soot or sounds of electrical discharge or arcing. Where possible, the reason for the circuit-breaker tripping should be identified and dealt with before any attempt is made to reclose.

Care and maintenance of HV switchgear: Common requirements

61 HV switchgear must be maintained to prevent danger. Maintenance of high-voltage equipment is practical to achieve. Detailed guidance on the maintenance of HV electrical switchgear can be found in BS 6626.

62 The frequency and type of maintenance needed can be determined from an assessment of the risks, knowledge of the equipment, how frequently it is likely to operate, and the expectation for the reliability and availability required from the system. Typically, maintenance programmes will be time-based, condition-based, reliability-centred or use a combination of all three techniques. Whatever approach is used, it is important to investigate and learn from instances of equipment failure. An analysis of switchgear failures and the results of maintenance inspections can be used to determine if the chosen maintenance regime is delivering the required results, and can allow changes to be made based on evidence obtained.

Time-based preventive maintenance

63 The rigorous application of time-based schedules for switchgear maintenance has provided high levels of reliability, particularly with equipment used in distribution networks. Oil-filled switchgear was designed and introduced at a time when the predominant maintenance philosophy consisted of equipment overhauls at fixed time intervals. Manufacturers' recommendations typically formed the basis of a maintenance programme. This approach is suitable for all types of switchgear and not just oil-filled switchgear, but the operating requirements of the equipment

must also be considered. Where it is known that switchgear will be subjected to variable operating conditions or frequent duty, eg frequent motor starting, maintenance at fixed time intervals may not be adequate, and other techniques may be more appropriate. Evidence from the investigation of switchgear failures or the findings from equipment overhauls can be used to determine if a time-based approach is appropriate.

Condition-based maintenance

64 Condition-based monitoring using predictive maintenance methods can be used to determine when maintenance of switchgear is required. Careful assessment of the parameters to be monitored, the techniques for acquiring the condition data and, most importantly, an understanding of the degradation mechanisms affecting the switchgear are needed to justify the criteria on which the decisions to take action are based.

65 When considering moving to a condition-based maintenance approach, the options available should be carefully assessed. This should be done with the assistance of organisations with experience in this area, since the performance of switchgear is influenced by the electrical and environmental conditions under which it operates. Applying techniques and criteria from one industry sector to another, or even another area of a site, may not be appropriate as conditions may vary.

66 Diagnostic tests, both intrusive and non-intrusive, can be applied to switchgear. Tests may be undertaken during commissioning in order to establish a baseline for future comparison. Examples of diagnostic testing include partial discharge detection measurements, thermographic surveys, trip mechanism timing profiles, insulation resistance measurements, polarisation index calculations, partial discharge and loss angle/tan delta testing.

Partial discharge detection

67 Partial discharge (PD) measurements can enable an assessment of the condition of the insulation in high-voltage plant to be made. Non-intrusive techniques for performing PD measurements using portable instruments include:

- measurement of transient earth voltages (TEVs);
- ultrasonic detection; and
- radio frequency interference (RFI) detection.

68 Some surface discharges are better detected using ultrasonic detection equipment. In practice, a combination of 'TEV' and ultrasonics is generally used on indoor, metal-clad switchgear. RFI can be used to detect some advanced partial discharge activity, but the technique is limited in application. On strategically important switchboards, permanent partial discharge monitoring can be installed based on the TEV principle. It is important that, if reliance is being placed on these types of measurement, the people making the measurements understand how to correctly use the instruments and the correct interpretation is made from the measurements taken. There are a number of specialist service companies who can take PD measurements and provide interpretative guidance on the significance of the results.

Thermographic surveys

69 Thermographic surveys to identify the surface temperature of components can be undertaken using infra-red thermal imaging equipment or non-contact thermometers. One of the strengths of this technique is the ability to monitor equipment while in use. The techniques are useful for detecting overheating conductors, connections and hot fuses or circuit-breakers, but only in

circumstances where it is possible to safely gain access to make the measurements. Quartz glass viewing windows may be incorporated into equipment to allow external temperature measurement, although such modifications may affect the explosion containment capability of the enclosure in which they are installed. This technique has limitations with high-voltage, metal-clad switchboards where the risks associated with opening compartments and the potential for exposure to live parts must be carefully evaluated against the benefits and reasonableness of such actions. In most cases, if a hot component is detected, the equipment should be isolated to make a repair. Consideration must be given to undertaking inspections, with equipment isolated in the first place if risks are created by taking measurements live. Industry guidance is available on completing thermographic surveys.¹²

Mechanism timing tests

70 Many problems with circuit-breakers are attributable to damage of the mechanical parts or 'stiction' in the tripping mechanism. This results in a failure of the circuit-breaker to open or close, or be slow opening. Detection of a problem in a mechanism may not be possible through invasive maintenance, but potentially can be detected by timing tests. Trip-profile measurements provide a detailed assessment of mechanism performance and are a valuable, additional test that can be incorporated into the routine trip-testing procedure. When used immediately before intrusive maintenance, trip testing can give an indication of the adequacy of the maintenance frequency.

71 A number of instruments for performing mechanical timing tests are available on the market, and specialist switchgear maintenance providers can offer a testing and assessment service.

Reliability-centred maintenance (RCM)

72 RCM can assist in the process of determining a maintenance strategy by analysing the maintenance tasks in a structured way to determine the maintenance requirements of an item of switchgear in its operating environment. It does so by taking account of plant usage and condition, the causes and consequences of failure, and the required performance standards of the organisation.

Switchgear availability

73 It can be difficult for HV switchgear to be made available for maintenance. If there are scheduled shut-down or closure periods, maintenance may become time-based, with the interval for maintenance determined by the shut-down frequency. Provided the intervals between maintenance are no greater than the manufacturer's recommended maintenance intervals, or the interval determined through an assessment of the duty of the equipment, this situation should be acceptable. Predictive techniques may be used to determine the extent of work required and minimise outage time. For organisations where a loss of power cannot be tolerated, redundant configurations of switchgear need to be employed to enable maintenance to take place. The potential difficulty of arranging for equipment to be made available for maintenance is not a justification for a failure to complete adequate maintenance.

Trip-testing

74 Trip-testing of circuit-breakers (taking action to make a circuit-breaker trip) is a simple operational test that 'exercises' the mechanism of the breaker and gives confidence that it will operate when required to do so. Annual trip-testing is undertaken by many users and, when combined with tripping via the protection

scheme, should confirm the satisfactory (or otherwise) operation of the tripping circuit. Careful movement of the disc in mechanical relays or specific command inputs into electronic relays can be used to simulate a trip condition and make a circuit-breaker trip.

Protection testing

75 Periodic testing of the protection relay scheme is a separate requirement to the maintenance of switchgear, and is needed to ensure the integrity of a system. It is not always carried out when the switchgear is maintained and requires specialist knowledge and equipment to complete. The type of testing required and frequency with which it is completed will depend largely on the type of protection equipment installed, the purpose of the testing and the consequences of protection failure. Electronic relays often incorporate self-diagnostic features and may be configured to generate alarms if faults are detected. Further guidance is provided in paragraphs 137–142.

Tests to be undertaken following maintenance

76 Before being returned to service, switchgear should be subjected to an operational check to ensure as a minimum correct close and open operations. Reference should be made to the manufacturer's instructions. Testing should also include checking that interlocks, position indicators, indicator lamps, local (and remote, if applicable) trip indications, trip counters and other associated devices are working correctly.

77 Automatic circuit-breakers should be tripped using the protection system to test the complete tripping circuit and verify that the reclosing mechanism is functioning correctly.

Routine inspection of substations and switch rooms

78 Switchgear is generally located in substations or switch rooms that may be visited infrequently. Depending on the risk, access should be restricted to specific people such as designated competent or authorised persons. One way to achieve this is by keeping doors locked and controlling access to the keys. Routine inspection is necessary to ensure deterioration has not occurred to the switchgear, any ancillary equipment or the building fabric which may have an adverse effect on the switchgear environment. Where defects are found which have the potential to give rise to danger, they must be dealt with. Minor defects should also be rectified to prevent dangerous situations from developing. Recording visits and any actions taken is a useful way to ensure that inspections are being completed and to identify trends. When undertaking an inspection, you should be aware of any signs of abnormal conditions that may give rise to danger.

Signs of abnormal conditions

79 A check for abnormal conditions should be carried out immediately on entering a substation or switch room. Persons authorised to enter a substation or switch room must have an understanding of what to look for. If any danger is suspected, the inspection should be aborted and an investigation carried out by someone who has the necessary knowledge and experience to be able to determine what actions may be necessary. Typical warning signs are:

- high temperature in the building;
- presence of smoke;
- smell of 'hot' substances (oil, compound etc);

- audible discharges or arcing;
- smell of ozone;
- nauseous odour (potentially indicative of a release of SF₆);
- signs of leaked oil in the vicinity of oil-filled equipment;
- signs of fresh compound leaks; and
- distortion of, or evidence of soot on enclosures.

80 The use of hand-held partial discharge equipment may be considered for use as an additional safety measure during a routine inspection or when entering a substation. The detection of the early onset of potential faults through the use of such equipment can reduce the risks to people who perform inspections by providing a warning that something may be wrong.

Equipment environment

81 During a routine inspection, the fabric of the substation or switchroom building should be examined to confirm that:

- there are no signs of water ingress;
- the building is clean, tidy and not being used as storage space;
- services such as lighting and telephones are working;
- doors and windows are secure and, where required, locked;
- there are no signs of damage or unwanted interference with the equipment or building;
- the building is not overgrown with vegetation, and access is acceptable; and
- there are no signs of rodent activity.

82 Routine inspection of outdoor switchgear compounds is also necessary to identify deterioration, damage or unauthorised access.

Visual examination of switchgear

83 During routine inspections of switch rooms and substations, switchgear should be examined to check:

- for signs of corrosion, oil leaks, or leaking compound;
- for the presence of earthing connections and other copper connections that may have been removed without affecting the immediate operation of the equipment;
- for evidence of water ingress into the equipment enclosures;
- that signs that ammeters, voltmeters, operation indicators, protection equipment indicators or flags, oil level or gas pressure (where sight glasses or gauges are fitted) appear to be operating and are displaying acceptable values;
- that protection equipment indicators or flags have not dropped to indicate warnings; and
- that labelling, padlocks and key exchange interlocks are present.

General services

84 Inspections should be carried out of substation lighting, including emergency lighting, tripping batteries, heaters, battery chargers, control panels, fire detection and extinguishing systems, and the telephone line, if fitted for emergency purposes. It is also useful to check for the presence of an up-to-date network diagram, substation log book and tools such as winding handles, circuit breaker lifting trolleys, test spouts or earthing equipment. Some of these items may also require a more formalised inspection (see paragraphs 131–135).

85 Battery systems may be fitted with test facilities to indicate battery condition. Where fitted, they should be used to test battery condition. Some protection devices may provide information regarding unusual conditions which have occurred on the network but not resulted in a trip. Recording this information can be useful, particularly where condition-based maintenance is being used.

Circuit-breakers subject to special duty

86 Circuit-breakers that regularly interrupt large load currents such as those controlling arc furnaces or frequently operated motors will require more frequent maintenance than circuit-breakers on normal distribution duty. The degree of maintenance will depend on the nature of the duty being performed in relation to the rated capability (electrical and mechanical) of the circuit-breakers and the frequency with which they operate. Recording information from the operation counter can be useful in assessing this. Particular attention should be paid to monitoring the rate of contact/arc control device deterioration, oil carbonisation and, where applicable, mechanism wear.

87 Where circuit-breakers operate frequently, it is possible that the rating of the circuit-breaker may be reduced after completing a number of operations. Guidance should be sought from the manufacturer of the equipment. Where frequent switching operations are likely to be required, the use of contactors rather than circuit-breakers is likely to reduce the requirements for maintenance, although such devices may not provide a suitable means of isolation.

Disposal issues, post-maintenance

88 Anyone who produces, treats, keeps, stores, transports or disposes of waste, including insulating oil and equipment that may be contaminated with SF₆ gas, must comply with the relevant requirements for the disposal of such waste. In England this is regulated by the Environment Agency, in Scotland by the Scottish Environment Protection Agency and in Wales by Natural Resources Wales.

89 Some capacitors and transformers may contain polychlorinated biphenyls (PCBs). The disposal of this type of equipment or oil that may be contaminated must only be carried out having taken into account the harmful effects and the legal requirements for the disposal of these potentially hazardous materials or substances. Advice should be sought from companies who have the necessary experience and facilities to be able to deal with these types of materials.

Care and maintenance of oil-filled switchgear

90 Examples of the arrangements of oil-filled switchgear are shown in Appendix 1 Figures 6, 7, 9, 10 and 11. If oil-filled switchgear fails, it has the potential to cause an explosion that may cause extensive damage to the switchgear and surrounding buildings, and serious injury or death to people, if present. The main failure modes for oil switchgear are:

- faults within oil compartments;
- failure of oil circuit-breaker to trip (which may result in an extended disconnection time due to fault clearance by upstream equipment); and
- solid insulation faults (external to oil compartments).

91 Faults within the oil compartment can result from:

- contaminated insulating oil;

- poor maintenance of the arc interruption system (contacts and arc control devices);
- breakdown of solid insulation;
- making or breaking fault current above the rated capability (in the case of a circuit-breaker); or
- internal component failure.

92 Actions that should be taken to minimise the risk of catastrophic failure include:

- external inspection (non-intrusive) to identify signs of abnormal condition detectable by sight, smell and sound to a person familiar with the appearance and expected condition of an item of switchgear;
- maintenance (intrusive) – a detailed inspection and examination requiring dismantling of the equipment to identify possible mechanism defects, insulating oil contamination and deterioration, erosion of contacts and arc control devices; and
- condition monitoring and assessment by partial discharge techniques – the detection and location of deterioration of solid insulation through the use of a partial discharge measuring device. Such devices can record electrical discharge activity, which gives an indication of insulation condition from the outside of live, high voltage equipment.

Maintenance procedures

93 Maintenance of oil-filled switchgear should include a thorough internal examination of circuit-breakers and switches. Maintenance should include:

- examination and cleaning of the tank interior, internal mechanism, contacts, arc control devices, bushings, phase barriers and tank lining;
- dressing, refurbishing or replacing main/arc contacts if found to be necessary;
- assessment of contact alignment using the circuit-breaker slow-close facility;
- cleaning of arc control devices, or replacement if burnt or worn beyond acceptable tolerances (cross-jet pots, turbulators etc);
- replacement of insulating oil with new, reclaimed or reconditioned oil (it is often more efficient to plan for oil replacement during maintenance than to undertake oil analysis to confirm the suitability of the insulating oil during the inspection);
- lubrication of operating mechanism and adjustment where required;
- replacement of seals and gaskets as recommended in the manufacturer's maintenance instructions, clearing vents and checking indicator windows;
- examination of primary isolating contacts for damage, burning and corrosion – cleaning and refurbishing (as necessary);
- checking and lubrication of the oil circuit-breaker isolating mechanism;
- checking correct function of position indicators and interlocks;
- checking shutter operating mechanisms as appropriate and where safe to do so;
- examining inside of cable termination chambers and current transformer chambers, as appropriate;
- examining and checking voltage transformer (as required and where safe to withdraw);
- secondary injection testing on circuit-breaker protection system, or, if this is not scheduled, carry out manual trip-test;
- on fuse switches/switch fuses, trip-testing with an appropriate fuse trip-testing device;
- examination of secondary contacts, wiring and auxiliary switches; and
- checking the truck goes fully into position and switchgear is level as appropriate when putting back into service.

94 Only remove tank covers for the minimum time necessary when maintaining oil switches, fuse switches and ring main units, and replace immediately after the work

is completed. This will minimise the risk of contamination of the tank interior by moisture, airborne particulates, dust, insects and vegetation (if outdoors). Care should be exercised when emptying and replenishing oil to minimise the risk of contamination of the new with the old.

Frequency of maintenance

95 Carrying out intrusive maintenance on oil-filled switchgear can introduce risks. Undertaking maintenance more often than is necessary can increase exposure to those risks. The risks associated with completing maintenance must be balanced against the legal requirement to maintain equipment so that it remains safe, and the need for maintenance for operational reasons. In doing so, it must be considered that:

- errors can be made during maintenance, leaving the equipment at greater risk of failure than if the maintenance had not been carried out; and
- switching is required to release the equipment for maintenance – the risk of a failure for switchgear is greatest during a switching operation.

Cleaning and inspection of oil-filled chambers

96 Oil-filled chambers should only be cleaned using proprietary wipes or synthetic sponges. It is extremely important that wipes should not release fibres, as failures have occurred due to the contamination of oil by fibres. Suppliers of cleaning products and switchgear manufacturers can provide advice on appropriate types of wipes and their performance.

97 Care is needed to avoid tearing sponges, which can allow small fragments to be introduced into chambers. Using disposable gloves and overalls can minimise the potential for fibre contamination.

98 Trace contaminants in insulating oil, such as acids, peroxides and moisture, can cause the switchgear plating metals (eg zinc and cadmium) to form metal salts and soaps, resulting in the degradation of both the plating surfaces and the oil.

99 Zinc and tin platings can degrade and form a large number of small 'whiskers'. For switchgear with tin- and/or zinc-plated components, particular care should be taken to check components for whiskers immediately following the removal of the oil. Remove any whiskers with an oil-soaked wipe, and then dispose of the wipe.

100 The phosphated coatings of steel components in switchgear are known to degrade in service, resulting in the presence of loose, phosphorous-rich particles contaminating the oil and coming to rest on the horizontal surfaces of the tank and other components, including bushings and insulators. Switches that contain phosphated components should be rigorously cleaned to remove contamination from insulating surfaces. Coated components should also be thoroughly cleaned to reduce the rate of recontamination of the oil.

101 Cadmium from the plating of mechanism metalwork can react with oil and moisture to form a cadmium soap, leading to the degradation of the plating surfaces and the oil. Cadmium soaps on the surface of solid insulation may lead to electrical degradation of the insulation. To prevent degradation, insulator surfaces should be cleaned with an appropriate solvent. Cadmium and cadmium compounds are highly toxic substances and need to be handled safely. For more information, see *Cadmium and you: Working with cadmium. Are you at risk?*¹³

102 Where oil is particularly contaminated, all components which have been in contact with the oil should be rigorously inspected to check for signs of corrosion, tracking, delamination or other degradation. Degraded components should be replaced. Densified wood laminate and pressboard are most susceptible to degradation if water has been present in the oil. Examination of these components may not reveal if they have a high moisture content, and insulation resistance measurements are recommended to establish their fitness for continued service. Guidance from the manufacturer may need to be sought to establish a suitable test method and determine the acceptable pass levels for insulation resistance measurements.

103 Fungal growth can occur in insulating oil that contains free water. The growth occurs at the interface between water from below and the carbon compounds from above. While it is rare to find fungal growth in insulating oil, any occurrence needs to be dealt with because, as the fungus grows, the oil is degraded, producing more water, various volatiles and acidic conditions that can cause corrosion. The production of water and resultant corrosion of materials in contact with the oil will also reduce the insulating properties of the oil.

104 The most common fungal growth in insulating oil is *Cladosporium Resinae*, whose spores can be airborne. They can lay dormant for periods of time and germinate when adequate moisture becomes available. Growth of the fungus from germinated spores can occur in a temperature range of -25 °C to +40 °C. Biocides can be used to kill the spores, and it is important to eradicate them because, if they are not destroyed, the fungal growth is likely to reoccur.

Tank cleaning techniques

105 To clean inside the tanks associated with oil-filled switchgear, once the old oil is removed, all accessible parts should be sprayed with clean oil under pressure. This now dirty oil should then be removed using a liquid vacuum cleaner, and the process repeated after examining the interior of the tank to determine if all the contamination has been removed.

106 Spraying is likely to create an oil mist, so suitable personal protective equipment must be worn to prevent the inhalation of oil. It is possible that the residual oil or sludge in a tank will contain cadmium as a result of the degradation of plated components which have been immersed in the oil. This presents a particular health risk to those cleaning the tank. In addition to respiratory protection, oil-resistant, disposable overalls, gloves and fitted safety goggles should be used. Workers need to be made aware of the hazards of ingestion of cadmium, and that good personal hygiene is needed after handling dirty oil and before eating.

107 Separate pumps and hoses should be used for removing and refilling equipment with oil to avoid contamination. Pumps and hoses used for clean oil should be dedicated to this purpose.

Insulating oil

108 The reliable performance of oil-filled switchgear depends on the characteristics of mineral insulating oil. Oil must be tested before being introduced into equipment, even if new, to ensure that it meets the required level of performance.

109 Laboratory assessments of oil samples taken from switchgear can provide information on the condition of both the switchgear and the oil. The results can be used to assess the effectiveness of a maintenance programme. Guidance on the

monitoring and maintenance for mineral insulating oils in electrical equipment is provided in BS EN 60422:2013.¹⁴

110 Oil taken from HV electrical equipment can be reclaimed. Oil companies have quality assurance/quality control procedures, which are intended to maintain acceptable quality and performance of reclaimed oil when it is supplied back to users. Switchgear oil may contain polychlorinated biphenyls (PCBs), so the procedures for handling used oil must take account of the procedures for PCB-contaminated materials or substances. For more information, see:

- EU Directive 96/59/EC The Disposal of Polychlorinated Biphenyls and Polychlorinated Triphenyls;¹⁵
- Statutory Instrument SI 2000 No 1043 The Environmental Protection (Disposal of Polychlorinated Biphenyls and other Dangerous Substances) (England and Wales) Regulations 2000;¹⁶
- The Environmental Protection (Disposal of Polychlorinated Biphenyls and other Dangerous Substances) (Scotland) Regulations 2000.¹⁷

111 In the UK, there are statutory requirements for the disposal of waste products. These make the holder of the waste responsible for its fate even after it has left their premises. In cases of doubt, consult the Environment Agency in England, the Scottish Environment Protection Agency in Scotland or Natural Resources Wales in Wales. These waste products include the oil removed from the switchgear (which may contain cadmium or cadmium sludge), and any new oil or solvent used to clean the components within the tank. All wipes, gloves or clothing which have come into contact with the cadmium should be collected and sealed in suitable containers labelled as special waste.

Post-fault maintenance of oil-filled circuit-breakers

112 Oil-filled circuit-breakers should be maintained as soon as possible after they have either been closed onto a fault or have operated automatically to disconnect a fault. Some organisations will inhibit the automatic tripping of a circuit-breaker after three operations on fault until maintenance has been completed. Care should be taken to distinguish tripping due to mal-operation of protection systems or inter-tripping for safety reasons from fault clearance so as not to force unnecessary maintenance of equipment. Post-fault maintenance should consist of:

- inspection and cleaning of all insulation within the tank to eliminate carbon, metal vapour/particle contamination;
- restoration of the contacts and arc control devices to an acceptable condition (including a check on contact alignment by slow-closing the oil circuit-breaker);
- replacement of the insulating oil; and
- inspection of the tank, tank gaskets and tank internal mechanism for signs of damage or distortion.

113 Where provision is made in the design for venting, this should be checked to ensure that the vents are not obstructed and any seals are intact and functioning.

Care and maintenance of non-oil switchgear

General guidance

114 Non-oil switchgear makes use of air, sulphur hexafluoride (SF₆) or vacuum as the interrupting medium. In some designs, vacuum interrupter bottles are housed within SF₆ chambers. An example of an arrangement of a vacuum circuit-breaker is

given in Appendix 1 Figure 8, an SF₆ insulated vacuum circuit-breaker is in Appendix 1 Figure 13, and an air circuit-breaker is in Appendix 1 Figure 12.

115 The sealed envelopes of SF₆ and vacuum switchgear improve reliability by removing the potential degradation of the interrupting medium due to adverse environments such as those containing dust, moisture etc. This has led to the introduction of the terms 'low maintenance' or 'reduced maintenance' for such switchgear. This does not mean that this equipment is maintenance-free; failures do occur, and inspection and maintenance procedures are required.

Maintenance procedures: Vacuum switchgear

116 Vacuum bottles may need re-certification or replacement after a specified operating life. Typically, the design life expectancy quoted by manufacturers is 20 years, although vacuum equipment of this age and older can be found in use. Testing during maintenance may identify a failed vacuum bottle, but is unlikely to provide information about the continued fitness for purpose of a bottle that does not fail the test. It is possible for a bottle which has lost vacuum while in use to remain in service under normal load conditions with no obvious signs of defect. Failure is likely only if the device is switched or required to break a heavy load or fault current. Failure is likely to be catastrophic.

117 Owners of vacuum switchgear should be aware of the design life expectancy of their equipment. While the equipment does have a high level of reliability, it cannot be assumed that this level of performance will be maintained indefinitely, or that extension to life is justifiable solely on failure rates experienced while operating the equipment within the manufacturer's design life expectancy. There must be a strategy in place to manage the risks associated with the potential for loss of vacuum when equipment reaches the limit of its design life expectancy.

118 X-rays may be generated when the open contact gap of vacuum switchgear is stressed at high voltage. High-voltage tests can be used to verify that vacuum is present, there being no other indication of the presence of vacuum within a bottle. There are no harmful emissions at normal service voltage. If a high-voltage pressure test is carried out with the switchgear in an open position, X-rays may be generated. Guidance should be sought from the applicable standards and the manufacturer.

119 Maintenance activities for vacuum switchgear should be based on manufacturers' recommendations, but are likely to include:

- inspection of the external condition;
- verification of the design life expectancy of the vacuum bottles and a check to determine the age of the equipment being maintained (note design life expectancy);
- measurement of contact wear where a measurement method is available;
- measurement of contact resistance when closed;
- a check on the vacuum integrity, eg by a high-voltage pressure test (X-ray risk);
- inspection, adjustment and lubrication of mechanisms, including shutters, where appropriate;
- on withdrawable equipment, examination of primary isolating contacts for damage, burning or corrosion – cleaning and refurbishing (as necessary);
- on withdrawable equipment, checking and lubrication of circuit-breaker isolating mechanism;
- checking correct function of position indicators and interlocks;
- examining the inside of cable termination chambers and other chambers as appropriate – removal of surface contamination from accessible solid insulation (where applicable);

- checking the operation and integrity of any automatic earthing facility, where applicable;
- examining and checking the voltage transformer, as required;
- secondary injection testing on circuit-breaker protection systems or the use of proprietary electronic simulation devices (or, if this is not scheduled, carry out manual trip-test); and
- examination of secondary contacts, wiring and auxiliary switches.

Maintenance procedures: Air-break switchgear

120 Maintenance work should be based on manufacturers' recommendations, but is likely to include:

- inspection of the external condition;
- examination of main/arcing contacts for excessive burning/damage. Recondition or renew as required, taking account of manufacturer's requirements for different contact construction and materials;
- checking/adjusting spring contact force and contact alignment, as required;
- removal, examination and cleaning of the arc chutes – renew if damaged or eroded;
- inspection, adjustment and lubrication of mechanisms, including shutters, where appropriate;
- on withdrawable equipment, examination of primary isolating contacts for damage, burning or corrosion – cleaning and refurbishing (as required);
- on withdrawable equipment, checking and lubrication of circuit-breaker isolating mechanism;
- checking correct function of position indicators and interlocks;
- examining inside of cable termination chambers and other chambers as appropriate – removal of surface contamination from accessible solid insulation (where applicable);
- examining and checking voltage transformer (as required);
- secondary injection testing on the circuit-breaker protection system (or, if this is not scheduled, carry out manual trip-test); and
- examination of secondary contacts, wiring and auxiliary switches.

Maintenance procedures: SF₆ switchgear

121 With SF₆ switchgear, a significant proportion of known problems are associated with loss of gas through defective/worn seals. Maintenance activities should be based on manufacturers' recommendations, and are likely to include:

- inspection of the external condition;
- checking of gas pressure;
- if 'topping up' of the gas is necessary, then refer to precautions in the following section;
- inspection, adjustment and lubrication of mechanisms (including shutters, where appropriate);
- on withdrawable equipment, examination of primary isolating contacts for damage, burning or corrosion – cleaning and refurbishing (as required);
- on withdrawable equipment, checking and lubrication of circuit-breaker isolating mechanism;
- checking correct function of position indicators and interlocks;
- examining the inside of cable termination chambers and other chambers as appropriate, with removal of surface contamination from accessible solid insulation (where applicable);
- examining and checking the voltage transformer (as required);

- secondary injection testing on the circuit-breaker protection system (or, if this is not scheduled, carry out manual trip-test); and
- examination of secondary contacts, wiring and auxiliary switches.

SF₆ gas handling and safety precautions

122 Under normal conditions, SF₆ gas remains inside switchgear, and any decomposition products formed during interruptions are neutralised by molecular sieves and natural recombination processes. SF₆ can be released at all stages of the equipment life cycle, and procedures for dealing with the effects of a release are required. A warning notice must be posted inside the substation clearly stating this.

123 During maintenance, refilling, condition testing and end-of-life disposal of the gas, precautions must be taken to minimise the risk of releasing gas to the environment and prevent exposure to potentially harmful substances that may form within switchgear. Procedures for dealing with accidental release due to equipment failure must be in place. Advice, training and support can be obtained from equipment manufacturers, SF₆ gas suppliers, and other organisations with experience of operating and maintaining this type of equipment.

Release of SF₆

124 SF₆ is a greenhouse gas and control over its use is essential. It must not be deliberately released into the atmosphere:

- SF₆ should be recycled and re-used to the maximum possible extent;
- losses of SF₆ from electrical equipment must be minimised;
- all new SF₆ equipment should allow for recycling; and
- recycling procedures should be formulated.

Hazards

125 Procedures for safe handling of SF₆ are available from a number of sources, including BS EN 62271-4:2013,¹⁸ ENA Engineering Recommendation G69¹⁹ and manufacturers.

126 SF₆ in its pure state is inert, colourless, tasteless, non-flammable and non-toxic. It is heavier than air, and can accumulate in cable trenches, pits and tunnels. A volume greater than 19% in the air may cause asphyxiation. An appropriate risk assessment should be undertaken in order to determine if cable trenches/tunnels are classified as confined spaces, in which case appropriate control measures for access must be implemented.

127 By-products are generated by the decomposition of SF₆ when exposed to an electric arc. Decomposition may lead to the presence of a white powder. This powder is irritating to the skin, eyes and respiratory mucous membranes. Users of switchgear containing SF₆ must be aware of the risks and have in place procedures to cover:

- emergency situations – release of SF₆ gas;
- scheduled maintenance of contaminated SF₆ equipment involving access to the SF₆ compartment;
- testing SF₆ gas and filling procedures;
- possible contamination in areas surrounding the switchgear; and
- storage, transport and disposal of contaminated gas.

128 The presence of small quantities of decomposition products is accompanied by a pungent and unpleasant odour. Irritation occurs within seconds, well in advance of any dangers arising from poisoning.

129 Where work is necessary which involves contact with equipment contaminated through contact with SF₆ or its decomposition products, the following precautions should be taken:

- use disposable protective overalls;
- maintain a high standard of personal hygiene;
- do not eat, drink or smoke;
- avoid cleaning nose, eyes or face other than with clean paper tissues;
- clean off any decomposition products from the work area, clothing and equipment;
- dispose of protective overalls in an approved manner; and
- wash all exposed parts of the body as soon as possible after leaving the working area.

Sampling

130 The majority of switchgear up to 33 kV uses sealed containment with the SF₆ gas at a small, positive gauge pressure (typically 0-1 bar gauge). The equipment is assembled, filled with SF₆ and tested in the factory, and no further handling of the gas is expected during its operating life. There may be occasions where sampling and testing of the gas is required. Gas removed from switchgear for sampling should be treated as contaminated. Guidelines for assessing the quality of SF₆ gas are available in BS EN 60376:2005.²⁰ This also provides guidance on the quality of gas to be used for topping up switchgear.

Care and maintenance of ancillary equipment

Test probes

131 Serious incidents have occurred involving failings with portable test probes. These items must be included in an inspection and maintenance programme. Incorporating them into an asset register so that routine inspection is scheduled and recorded should ensure that they are not overlooked. Use of a safety colour-coding procedure or some other method to indicate the current period of use will ensure that probes that have not been maintained are not inadvertently used. Test probes should be stored in clean, dry containers when not in use. Checks should include:

- inspection of general condition, damage and deterioration;
- inspection for correct and legible identification;
- cleaning to remove oil films and loose dirt (using wipes that do not release fibres);
- inspection of contacts for wear, burning or other signs of abnormal condition, and to ensure they are securely attached;
- inspection of bushings for cracks, damage, burning etc;
- inspection of any guide pins, interlocking tabs and locking bolts to ensure they and any other parts are securely attached;
- measurement of the insulation resistance using an insulation tester, and comparison against an agreed pass figure;
- for those probes which are shown to be in satisfactory condition, mark with the correct code for the current period of use; and
- removal of any damaged or defective probes from use, and initiation of repair or replacement.

Earthing equipment

132 Earthing equipment for switchgear can be categorised as:

- integral – part of the permanent operating mechanism of the switchgear;
- extensible – a system of probes that can be attached to a circuit-breaker truck which is then racked into an earth position; or
- portable – a system of probes for insertion into the switchgear and leads for connection to a suitable earth point by flexible cables and clamps.

133 The following recommendations are applicable to the care and maintenance of extensible and portable earthing equipment. The maintenance of integral earthing systems should be incorporated as part of the maintenance regime of the switchgear itself.

134 Portable and extensible earthing equipment are vital pieces of safety equipment. Like test probes, they should be inspected on a regular basis and included in an asset register. The use of a safety colour-coding procedure or other system to indicate the current period for use will help ensure that equipment which is outside that period is not inadvertently used.

135 Checks should include:

- inspection of general condition, specifically to identify damage or deterioration;
- inspection for correct and legible identification;
- cleaning as required;
- inspection of contacts, connections and leads for wear, burning or other signs of abnormal condition, and to ensure they are securely attached;
- inspection of all insulation components for damage;
- inspection of any guide pins, interlocking tabs and locking bolts to ensure they are present, functional and secure;
- for earthing equipment which is shown to be in satisfactory condition, mark with the correct colour code for the current period of use; and
- removal of any damaged or defective earthing equipment from use, and initiation of repair or replacement.

Assessment of aged switchgear

136 Since the risk of catastrophic failure increases with age (especially oil switchgear), a process of assessment should be used to decide on the appropriate action for dealing with aged switchgear in service. Such an approach should incorporate condition assessment. This will enable decisions to be made on whether to retain, refurbish or replace aged switchgear and allow investment to be directed to best effect. Decisions should be made on the basis of condition and on the potential risk of leaving individual switchboards in service. The decision-making process follows the assessment actions displayed in Figures 1–5.

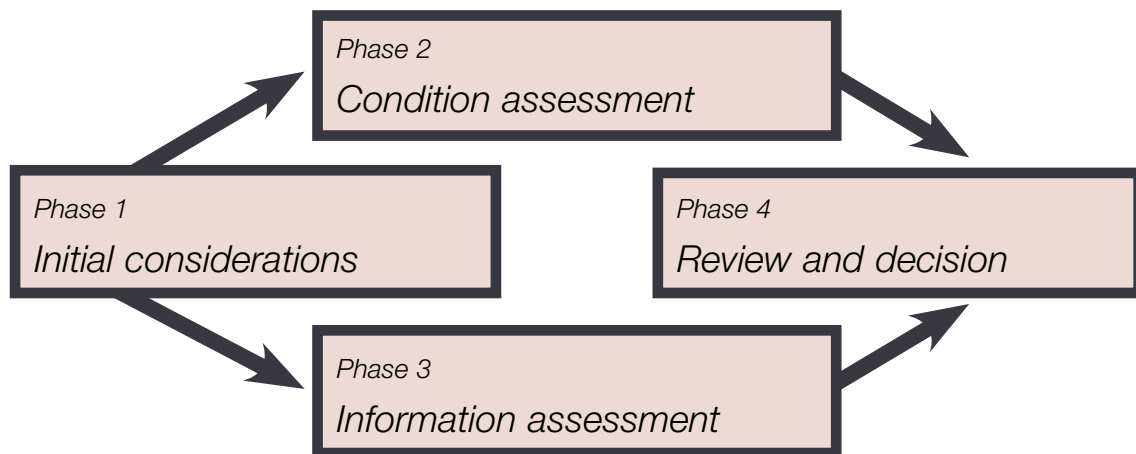

Figure 1 Assessment process overview

Notes:

- (a) If the switchgear has either a DMO mechanism or, in the case of oil circuit-breakers, plain break contacts (ie no arc control system), it should be scheduled for replacement (or upgrading, if practicable).
- (b) If the calculated fault current/energy at the switchboard exceeds the switchgear capability and there is no possibility of reconfiguring the network to reduce the fault current/energy, usually the only viable option will be to replace the switchgear.

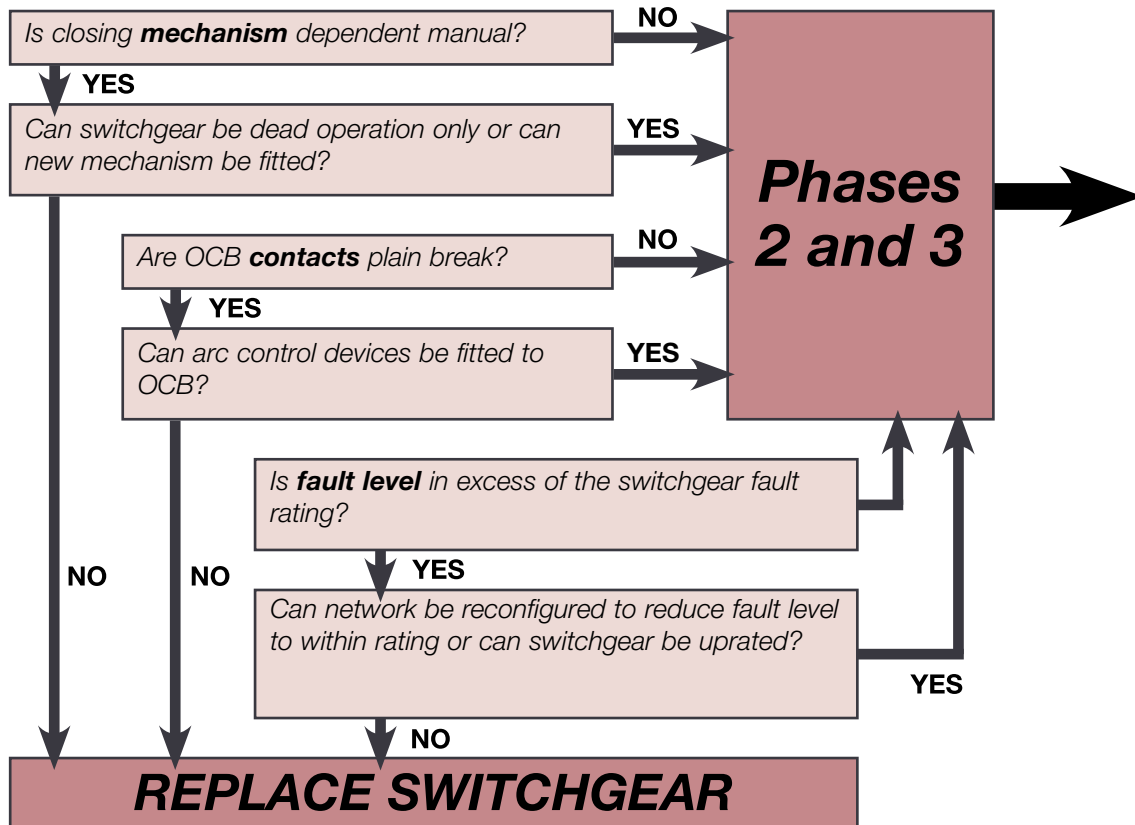

Figure 2 Phase 1: Initial considerations

Notes:

- (a) If the switchgear has either a DMO mechanism or, in the case of oil circuit-breakers, plain break contacts (ie no arc control system), it is strongly recommended that it be scheduled for early replacement (or upgrading, if practicable).
- (b) If the calculated fault current/energy at the switchboard exceeds the switchgear fault capability and there is no possibility of reconfiguring the network to reduce the fault current/energy, then usually the only viable option will be to replace the switchgear.

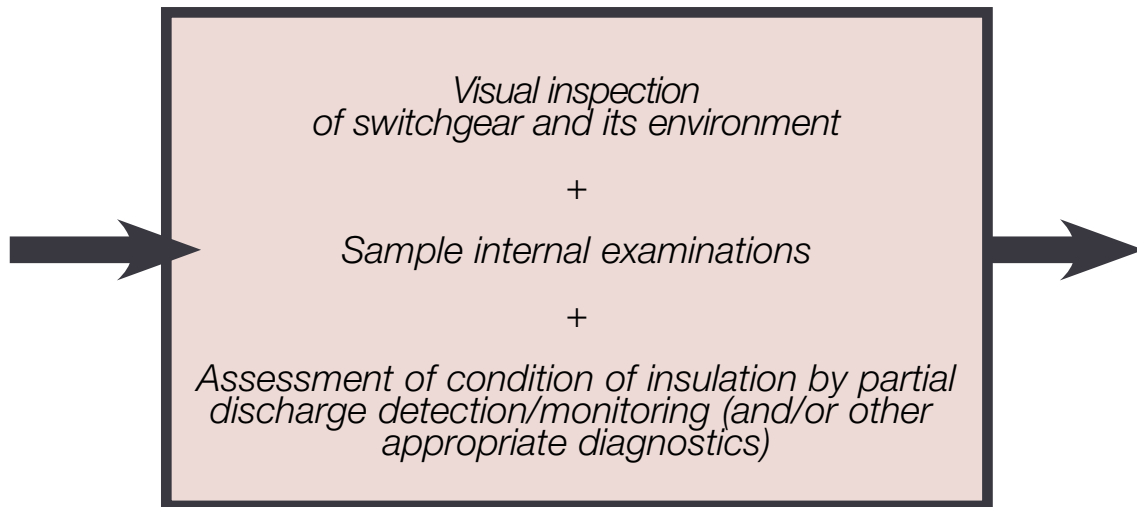

Figure 3 Phase 2: Condition assessment procedures

Notes:

(a) If the switchgear is not to be replaced as a result of the Phase 1 considerations, it will be necessary to carry out condition assessment in order to establish the suitability of the switchgear for continuing service. The condition assessment should embrace a mixture of external and internal examination, together with appropriate diagnostic tests to ascertain the condition of HV insulation.

(b) Information on diagnostics for assessing insulation condition is provided in paragraphs 67–71.

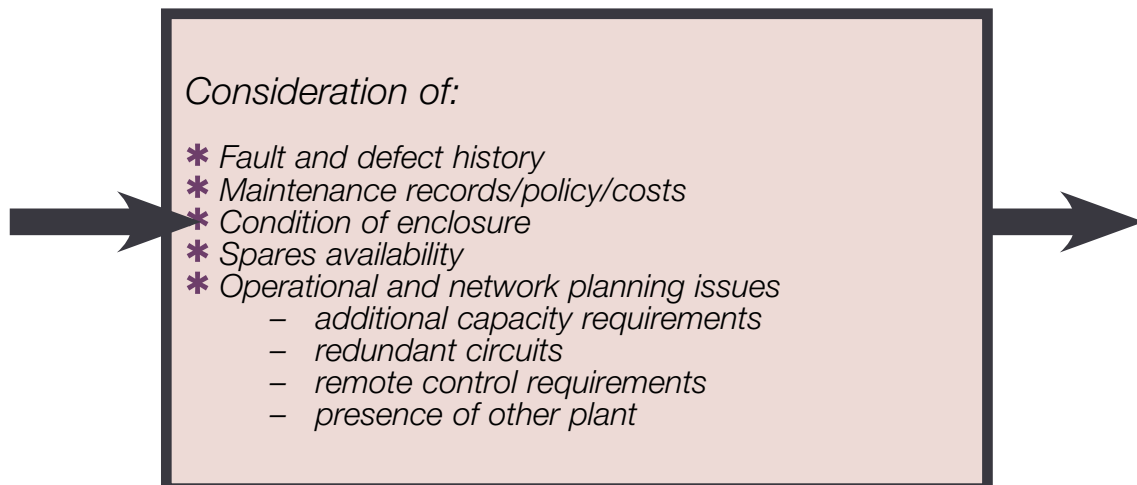

Figure 4 Phase 3: Information assessment

Note:

The above information needs to be acquired from the appropriate sources and assessed.

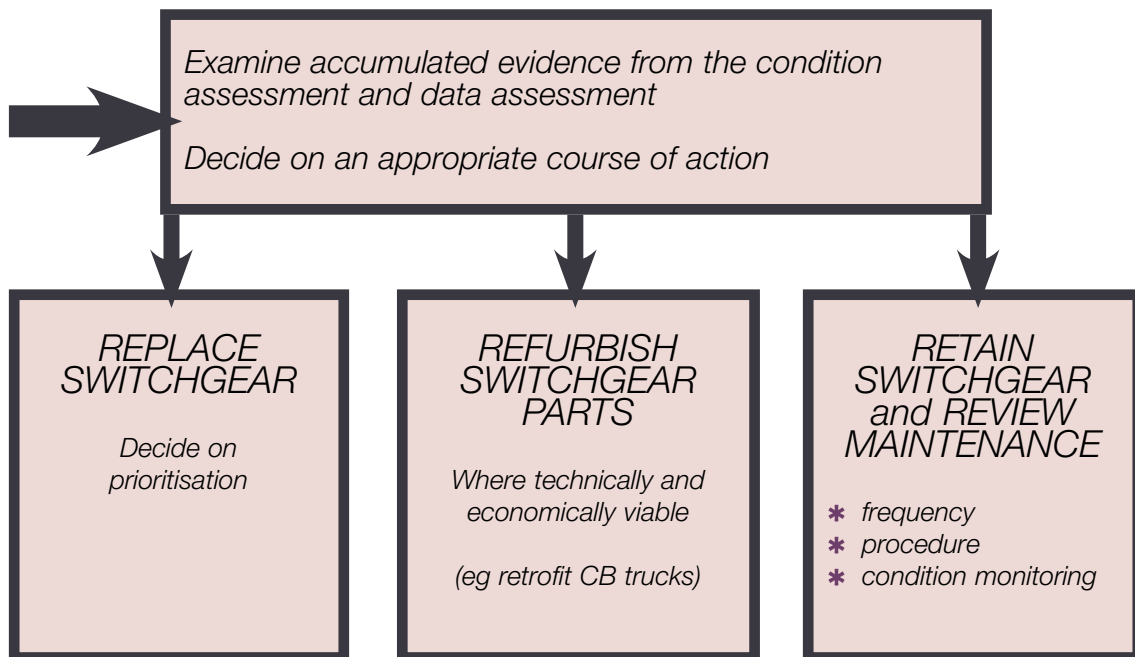

Figure 5 Phase 4: Review and decision

Note:

If it is decided to retain the switchgear in service, an estimate of remaining life should be made and the maintenance regime modified to include regular condition monitoring.

Protection

Protection relay schemes

137 Protection relays and associated systems should be inspected and tested in addition to completing routine maintenance actions. For electronic relays, there may be no specific requirements for routine maintenance other than the inspection that will take place during a routine substation or switch room check. Testing will give an indication of the condition of the equipment and provide confirmation that the relays are functioning as intended. Comparison of test results with previous results can provide a guide to possible deterioration and assist in determining the appropriate testing/maintenance interval. Testing also provides an opportunity to verify that relay settings have not been changed. For programmable relays, software tools may be required to verify the settings within a relay. Specialist equipment may also be needed if testing by current injection is not an option.

138 Insulation resistance testing should be carried out on the secondary wiring associated with protection systems, including pilot wires if they form part of the protection circuitry. This is important since current leakage across the wiring will affect the characteristics of the protection scheme and may have a detrimental effect on operation and discrimination.

139 For an electromechanical type relay, testing will include:

- verification that the relay movement runs freely;
- checking that magnet gaps and the induction disc are clean;
- inspection of the contacts for signs of burning or pitting (refurbish as necessary);

- verification by measurement that the induction disc resetting time (electromechanical IDMT relays) is not excessive;
- verification by operation that flag mechanisms and reset knobs operate correctly;
- checking that the front cover glass and seals are satisfactory;
- checking by measurement that current transformer shorting contacts operate satisfactorily; and
- performing secondary injection tests to check the operating characteristics of the relay are within the correct limits of operation dependent on the protection type. Guidance on the test procedure can be obtained from standards, manufacturer's information or specialist testing companies.

140 Harmonics can affect the operation of electromechanical (induction) type relays. Operators of switchgear may need to take account of this in the design of protection systems, and are advised to consider power quality issues when testing or fault finding on protection systems.

141 For electronic relays, the manufacturer's instructions should be referred to for guidance. Specialist equipment may be needed to interrogate the relay to determine if any internal errors have been detected. Regardless of the relay type, secondary injection testing of the relay will enable its operation to be verified. Where secondary injection is not possible, manufacturers may provide test equipment to simulate fault operation.

Fuse protection

142 For switchgear where the protection is dependent on fuse operation, the operational tests involve carrying out fuse trip-testing (a test-trip fuse can be used, if available) to ensure that:

- single fuse operation causes all other phases to operate; and
- the manual ON/OFF trip mechanism operates correctly.

Batteries and chargers

143 Batteries for circuit-breaker tripping and closing supplies play a vital role in the overall performance of switchgear. Batteries and their associated chargers require an appropriate maintenance regime to ensure reliable performance. The failure of a tripping battery set or battery charger can result in the inability of switchgear to operate. Battery condition monitoring with alarm annunciation or remote monitoring is recommended to give early warning of any problems.

144 The battery/charger installation should be inspected, tested and maintained. The level of maintenance will depend on the type of battery and charger system in use. The battery manufacturer's operation and maintenance instructions should be followed. Recommended charging rates should be adhered to and batteries should be replaced in accordance with the life expectancy declared by the manufacturer.

145 Load testing of batteries is recommended as it is not unknown for apparently healthy batteries to fail when more than a single tripping operation is demanded by the protection system.

146 When batteries or chargers are replaced, the remaining equipment must be compatible with the new. Old batteries must be disposed of observing relevant environmental legislation.

Selection of new, replacement or refurbished switchgear

General advice

147 A number of options are available when considering the replacement or refurbishment of switchgear:

- replace the switchboard in its entirety;
- replace individual switchgear units (moving and fixed pattern);
- refurbish the switchboards or individual switchgear units; and
- retrofit new circuit breakers into existing switchgear.

148 Where the decision is made to install a complete new switchboard, the opportunity exists to consider whether direct replacement is necessary or whether the switchboard arrangement can be reconfigured and simplified. It may be opportune to include provision of spare capacity, since new equipment is likely to require less space than the equipment it replaces. New equipment is likely to incorporate improved safety features such as interlocking, and may also provide the opportunity to benefit from the additional functionality available with programmable protection systems. The provision of remote operating facilities should be considered in order to minimise the risks to personnel operating the equipment. The decision to install new equipment may also lead to a reduction in maintenance requirements.

149 Where only individual switchgear panels are to be replaced, the decision is one of like-for-like replacement, if the switchgear is still available, or the selection of an equivalent from the same manufacturer. If switchgear from a different supplier is to be used, consideration must be given to the connection of the busbar systems to ensure that the rating of both the existing and new equipment is not compromised.

150 The retention or replacement of the existing cables should also be considered. Paper insulated cables can be internally damaged by significant disturbance, and appropriate measures such as through-jointing the cables should be considered if the cables are re-used.

151 A major consideration in the decision to retain existing equipment is the level of confidence that the insulation components associated with the busbar system, transformer chambers and terminations have adequate remaining life to justify anticipated expenditure saving. An overall assessment of the switchgear should be carried out before evaluating the economics of refurbishment/retrofit against replacement. This may include condition assessment of the HV insulation using partial discharge measurement techniques.

152 The load rating and the short-circuit rating of any items of original equipment which are to be retained in a retrofit or refurbishment scheme must be carefully considered. If there is a difference between the replaced/refurbished equipment and the existing equipment, the lowest load and short-circuit rating must apply. Consequently, although new switchgear may have been installed with an increased rating, it may not be possible to use the equipment to its full rating due to the limiting effects of the remaining components. Current transformer ratings for protection relays are an example where ratings must be carefully reviewed.

153 Where the replacement of circuit-breakers within existing enclosures is intended, the following should be considered:

- the condition of the secondary wiring, protection and control equipment;
- interlocking and earthing arrangements in relation to current safety standards;

- short-circuit ratings; and
- venting arrangements (where appropriate).

Retrofit circuit-breakers for withdrawable switchgear

154 Retrofitting usually involves updating the existing moving portions of switchgear generally to incorporate vacuum or SF₆ technology. Two options can be considered:

- replacing a complete circuit-breaker truck; or
- modifying an existing truck.

155 Retrofit systems can be obtained either from switchgear manufacturers or specialist suppliers. When selecting a system, particular attention should be paid to the mechanical compatibility between the fixed portion and the new moving portion. Such problems can be minimised by close liaison between the user and supplier at all stages of a retrofit operation.

Second-hand equipment

156 Second-hand switchgear may be purchased from companies specialising in its recovery and refurbishment. If second-hand switchgear is being considered, it is important to only deal with reputable and experienced organisations. Make sure the equipment is suitable for the intended use. It may be necessary to employ an independent consultant to oversee the selection, installation and commissioning of second-hand equipment if sufficient knowledge or expertise is not available in-house.

Measures to limit fires

157 Failure of switchgear can lead to fires, and with oil-filled switchgear, this can result in a major incident. This not only poses potential fire and smoke risks to people in the vicinity and to the building fabric, but may also affect other plant, thus escalating the primary event. There are a number of techniques that can be used singularly or in combination to mitigate the effects of a fire and limit smoke spread.

Compartmentation

158 Substation plant items can be separated by fire-resisting barriers to limit the extent of any fire to the item of fire origin. There may be contradictory requirements between fire safety and explosion safety. Compartmentation needs to be carefully designed so that it can contain a fire but not inhibit any venting required for explosion control.

Control and extinction

159 Fire-extinguishing systems using extinguishing mediums such as fire-suppressant gases, water or water mist and carbon dioxide (CO₂) can be installed.

160 Portable fire-extinguishers should be provided, and procedures for checking these and any permanent systems should be carried out during the routine inspection of the switchroom or substation building.

Detection

161 The use of an appropriate automatic fire detection system can provide the electrical plant room or area with early fire detection and alarm features which

could also be linked with a control/extinction system to provide fast response fire suppression or control.

Safety issues

162 Where automatic fire protection systems are installed, there may be risks to people in the protected area when the system operates. These include:

- asphyxiation by the gases or chemical extinguishants used;
- poisoning if extinguishants are toxic;
- physical injury (falling, striking objects etc) due to poor visibility after release of the gases or chemical extinguishants; and
- effect of low temperature due to release of the gases or chemical extinguishants.

163 Entry procedures must be communicated if people are to enter an area fitted with automatic fire protection equipment. These include:

- the automatic control to be rendered inoperative before entry;
- caution notices indicating that the control is on 'non-automatic' to be fitted to the automatic/non-automatic selector;
- precautions taken to render the automatic control inoperative to be noted in any safety documents issued for work in the protected area; and
- instructions issued to staff to ensure that the system is restored to automatic control as soon as all staff have withdrawn from the area.

164 Notices requiring the above actions should be prominently displayed at the point(s) of access to the area.

Appendix 1: Examples of switchgear configurations

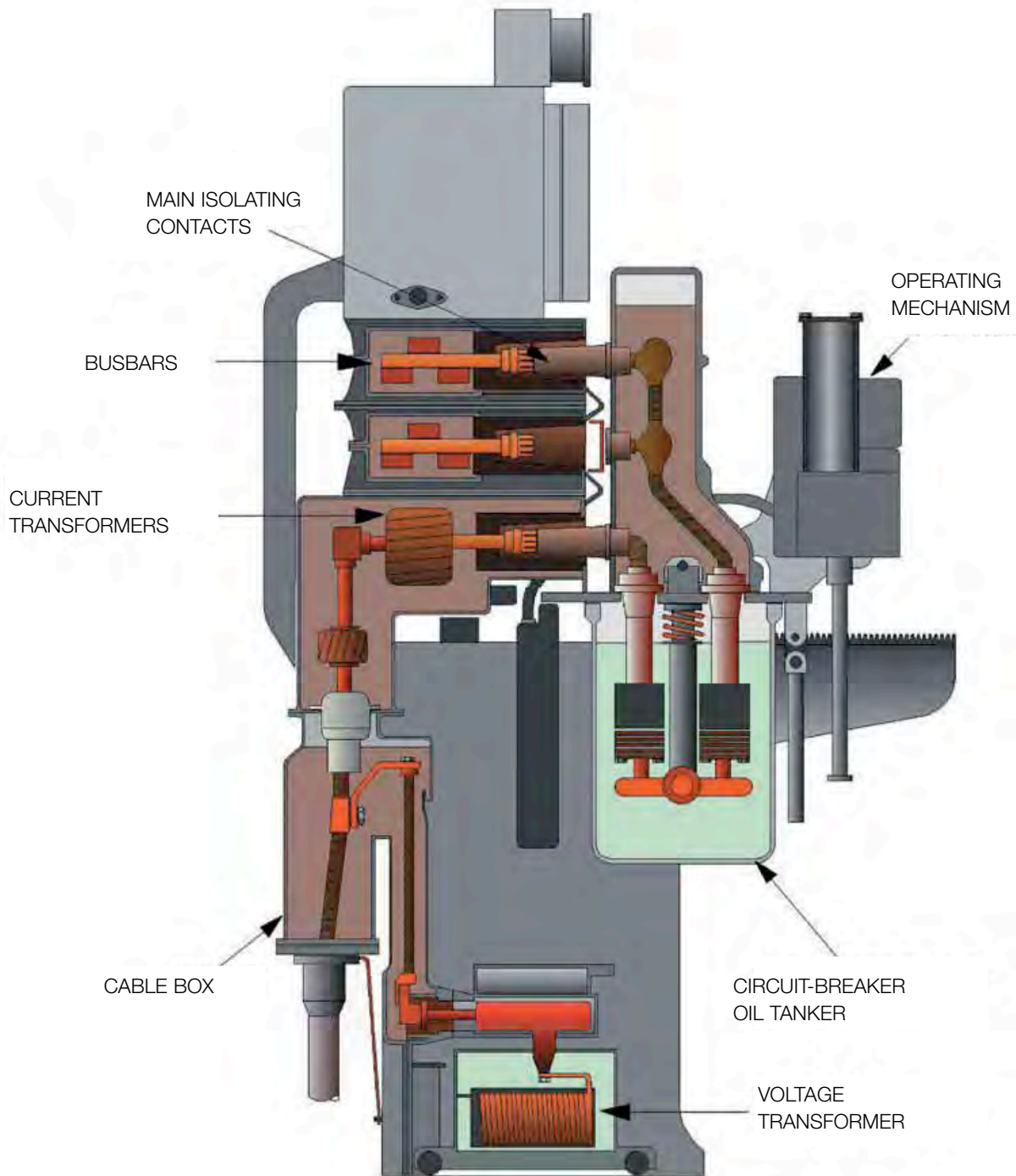

Figure 6 Typical arrangement of a horizontal isolation duplicate busbar 11 kV oil circuit-breaker

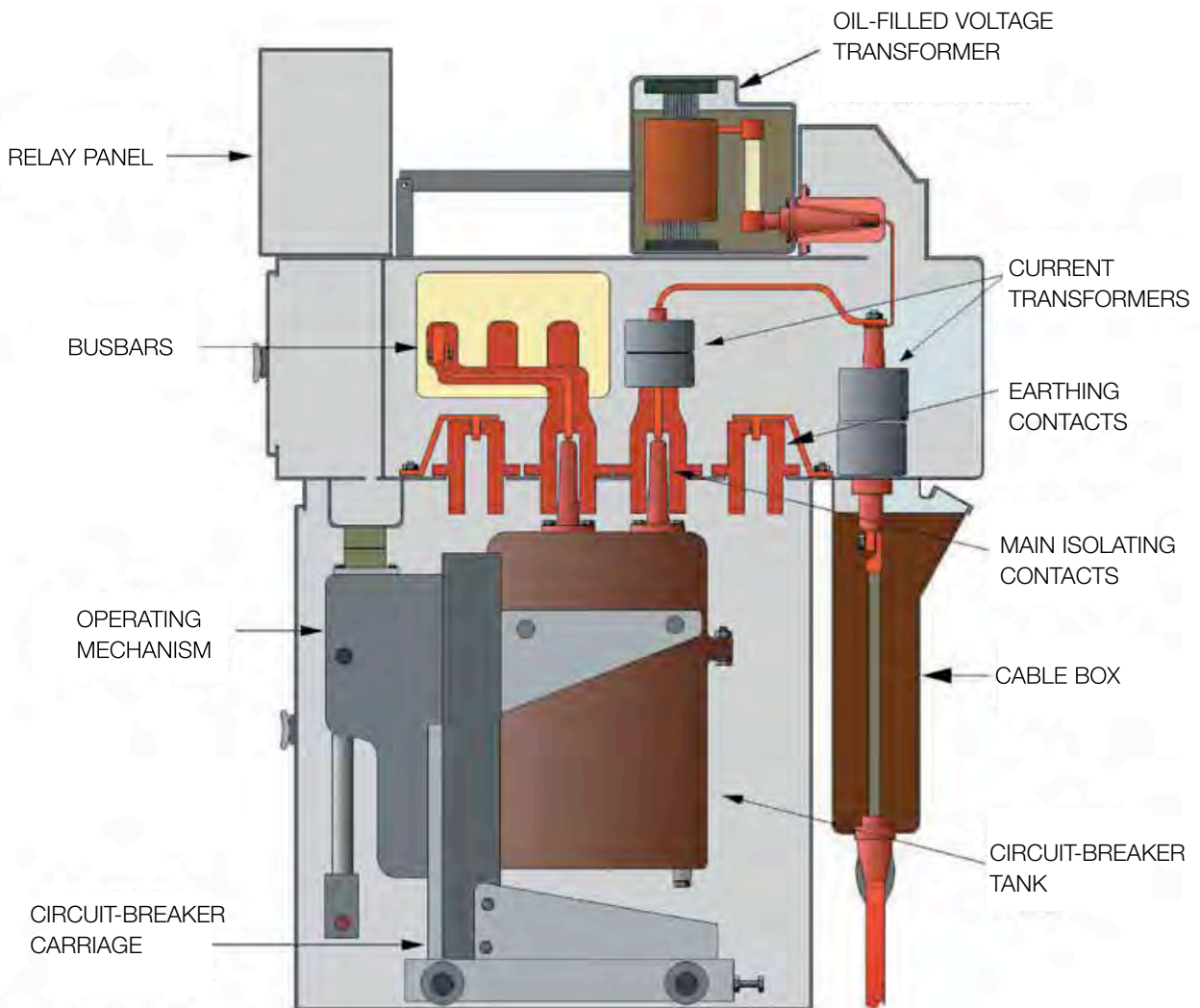

Figure 7 Typical arrangement of a vertical isolation 11 kV oil circuit-breaker panel (single busbar with feeder earthing via circuit-breaker transfer)

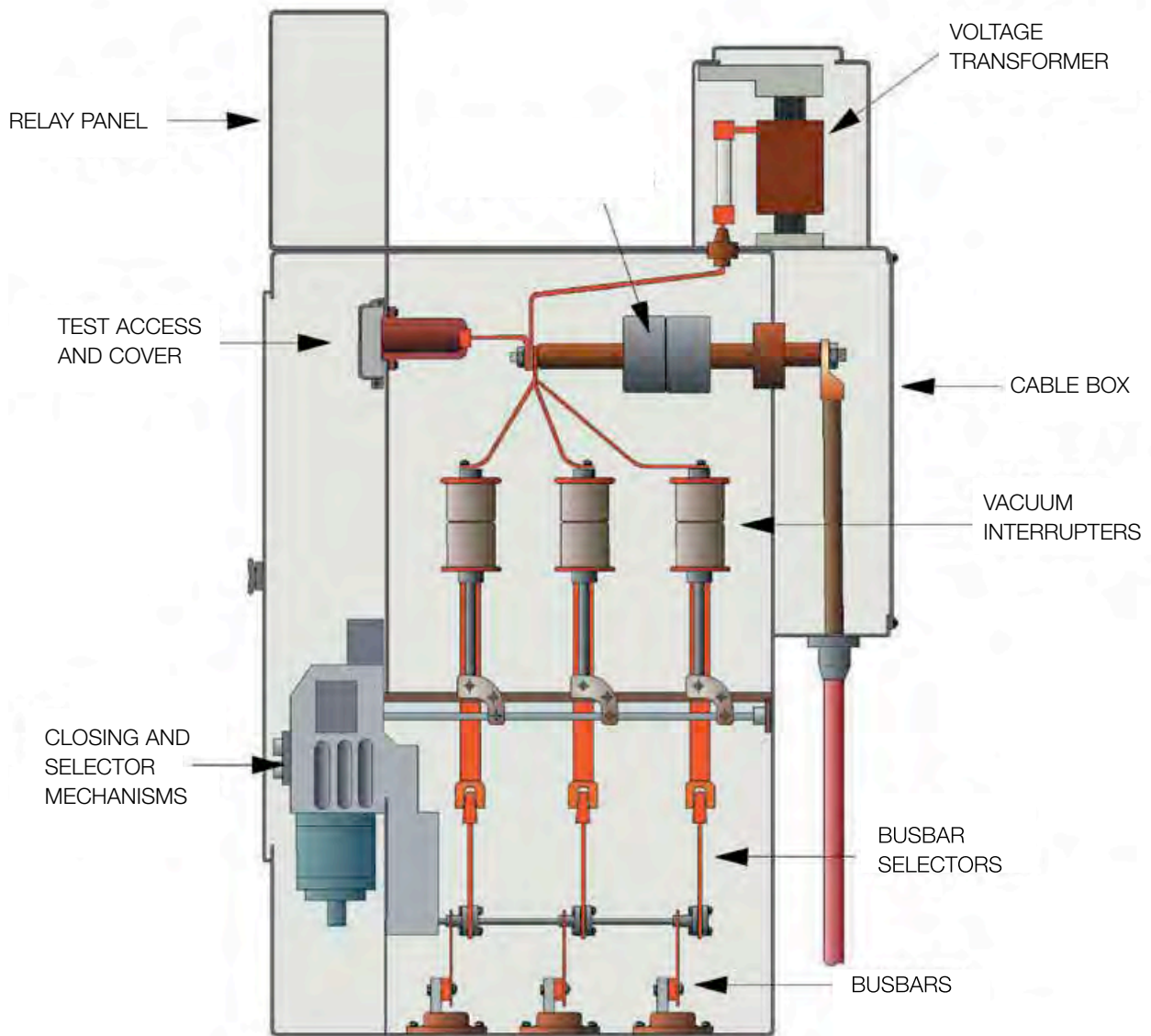

Figure 8 Typical arrangement of a single selector fixed pattern 11 kV vacuum circuit-breaker

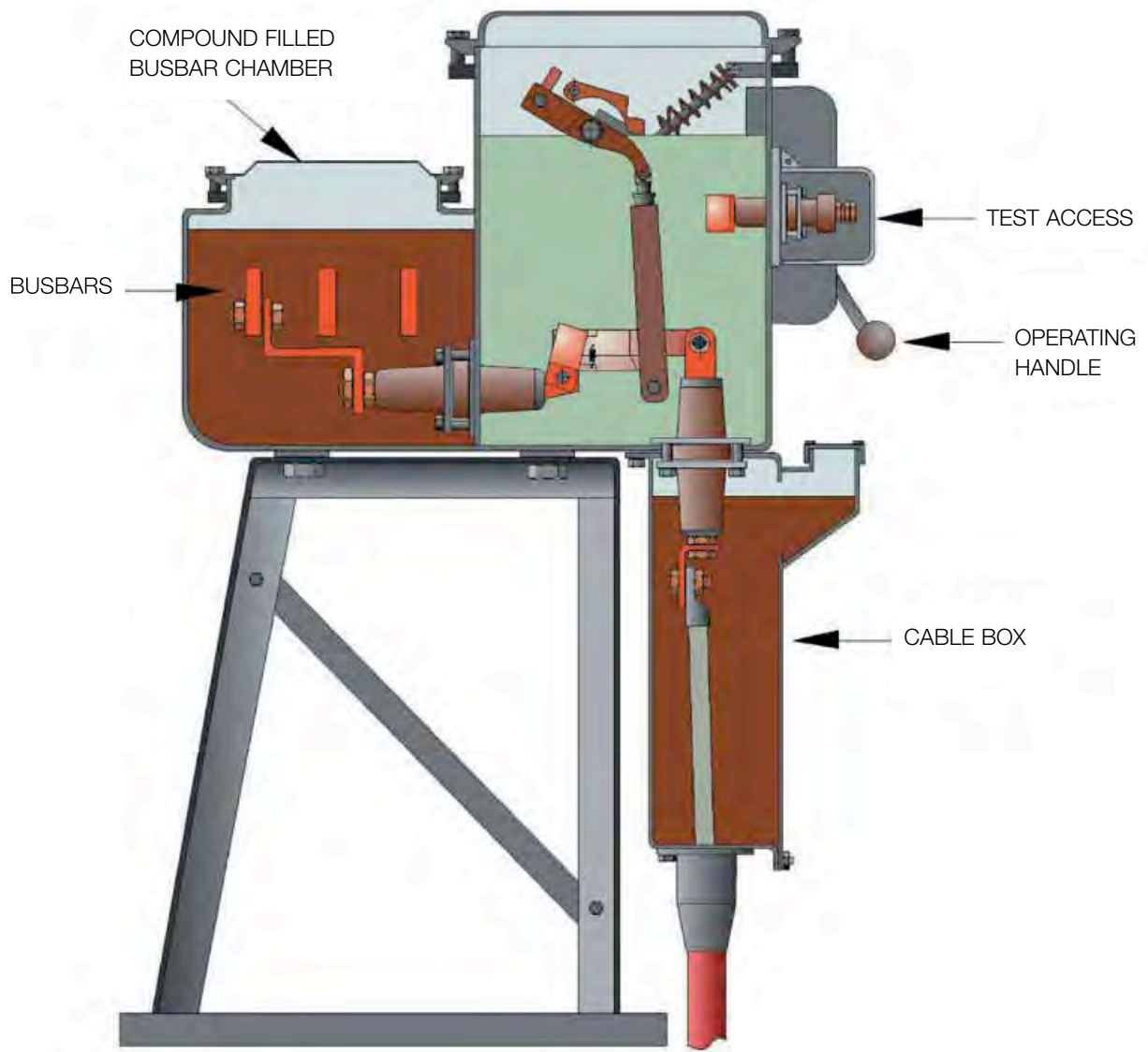

Figure 9 Typical arrangement of an 11 kV oil switch

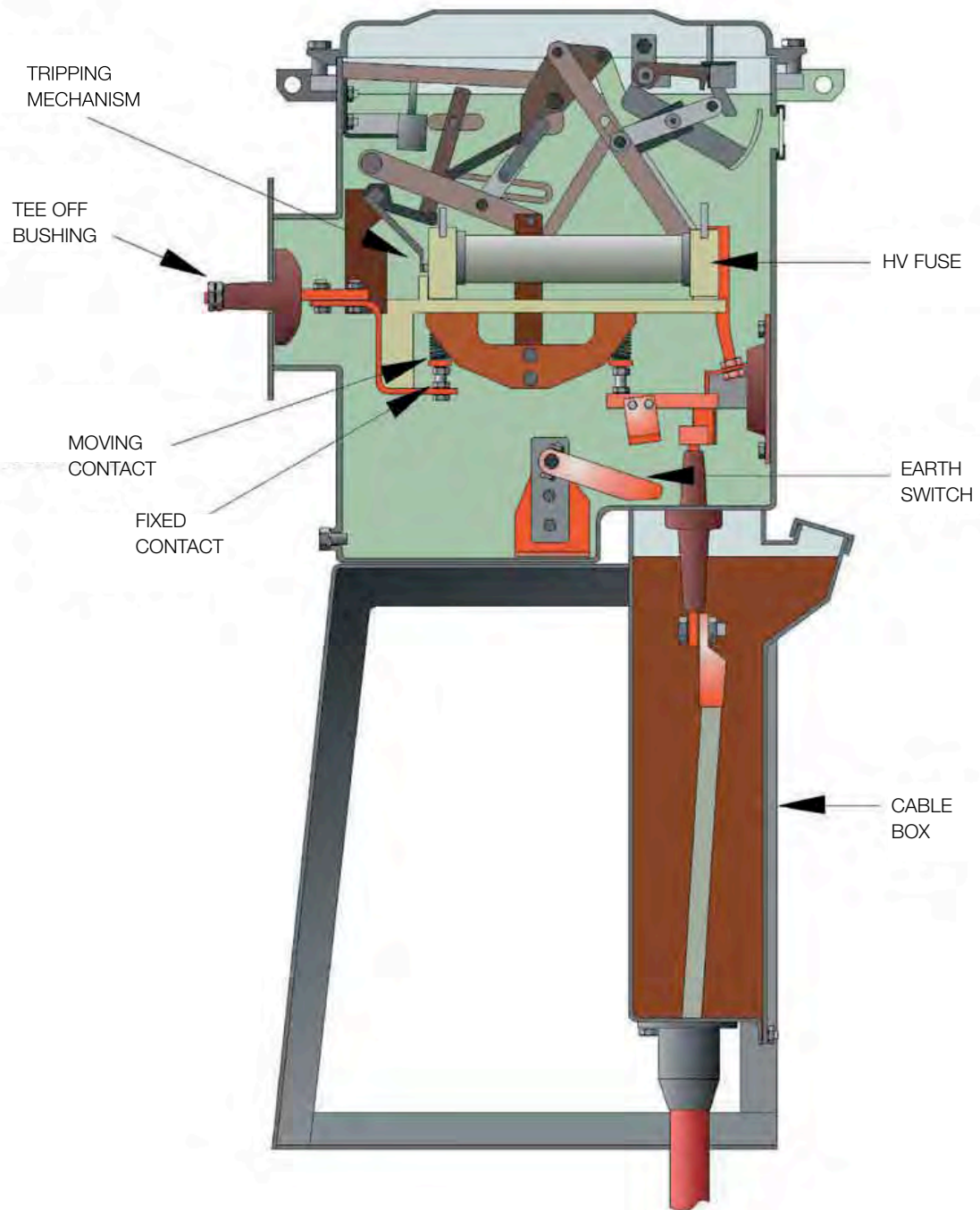

Figure 10 Typical arrangement of an 11 kV oil fuse switch

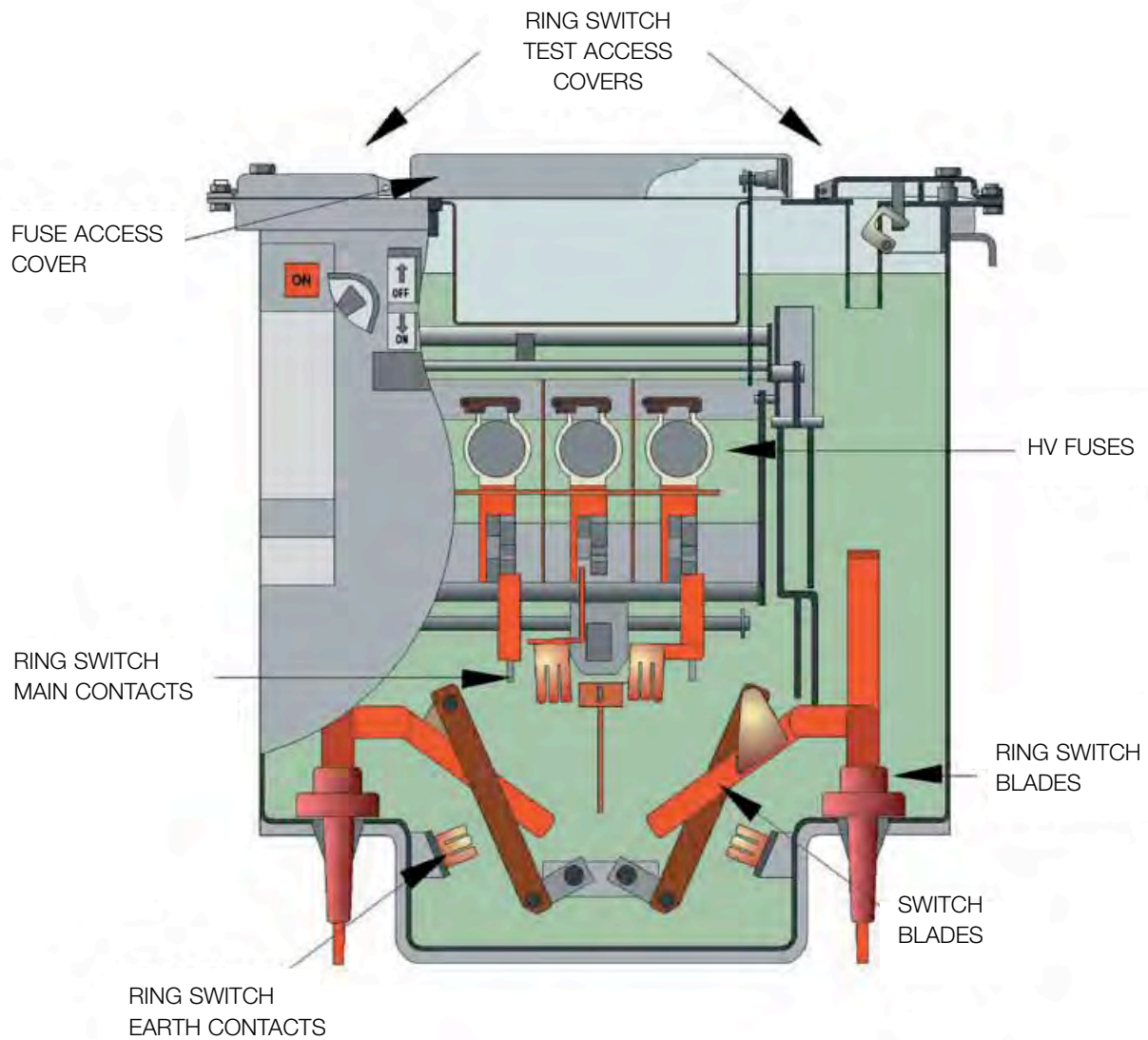

Figure 11 Typical arrangement of an 11 kV oil-filled common tank ring main unit (incorporating two ring switches and one fuse switch)

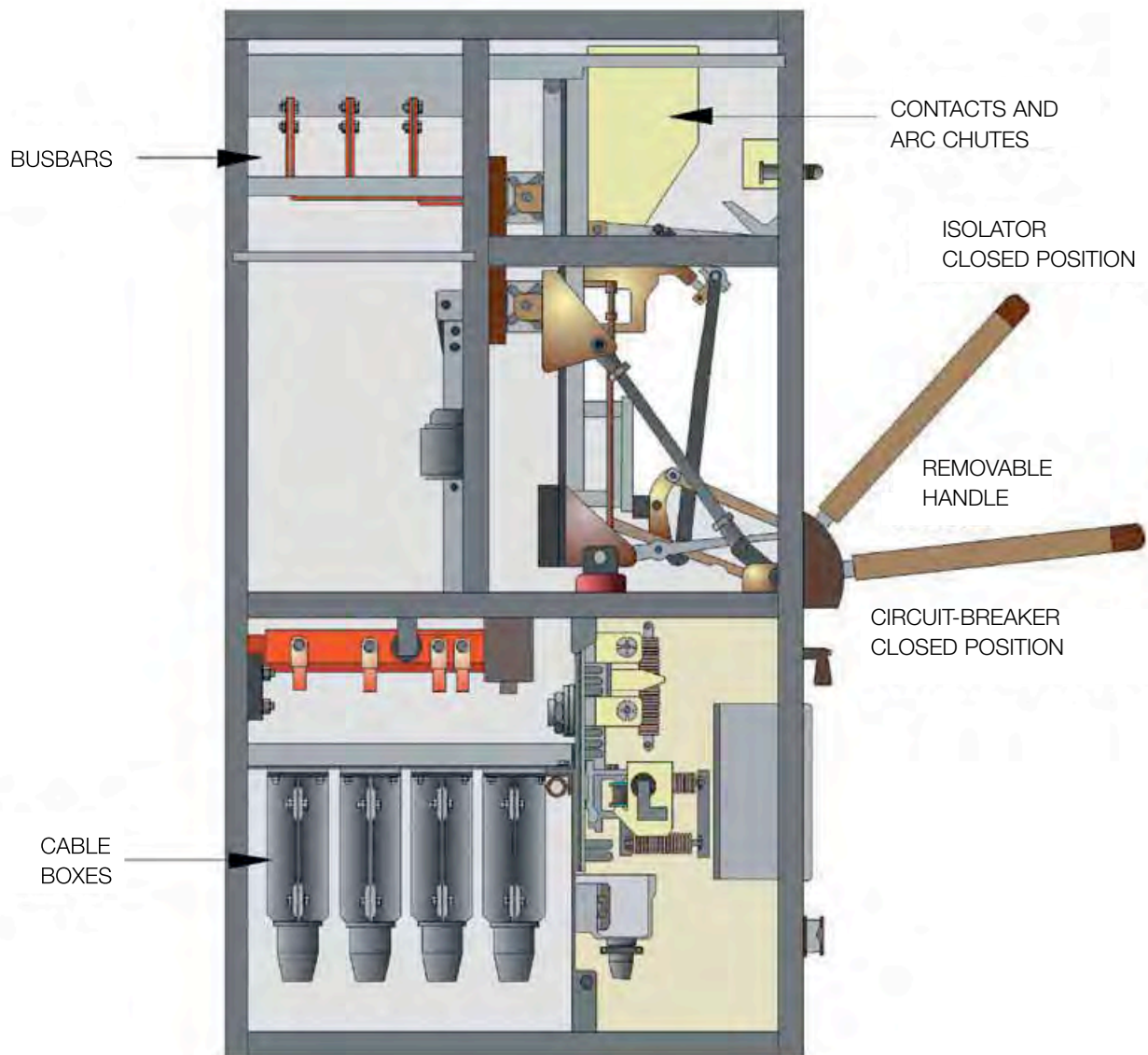

Figure 12 Typical arrangement of a 415 V air circuit-breaker

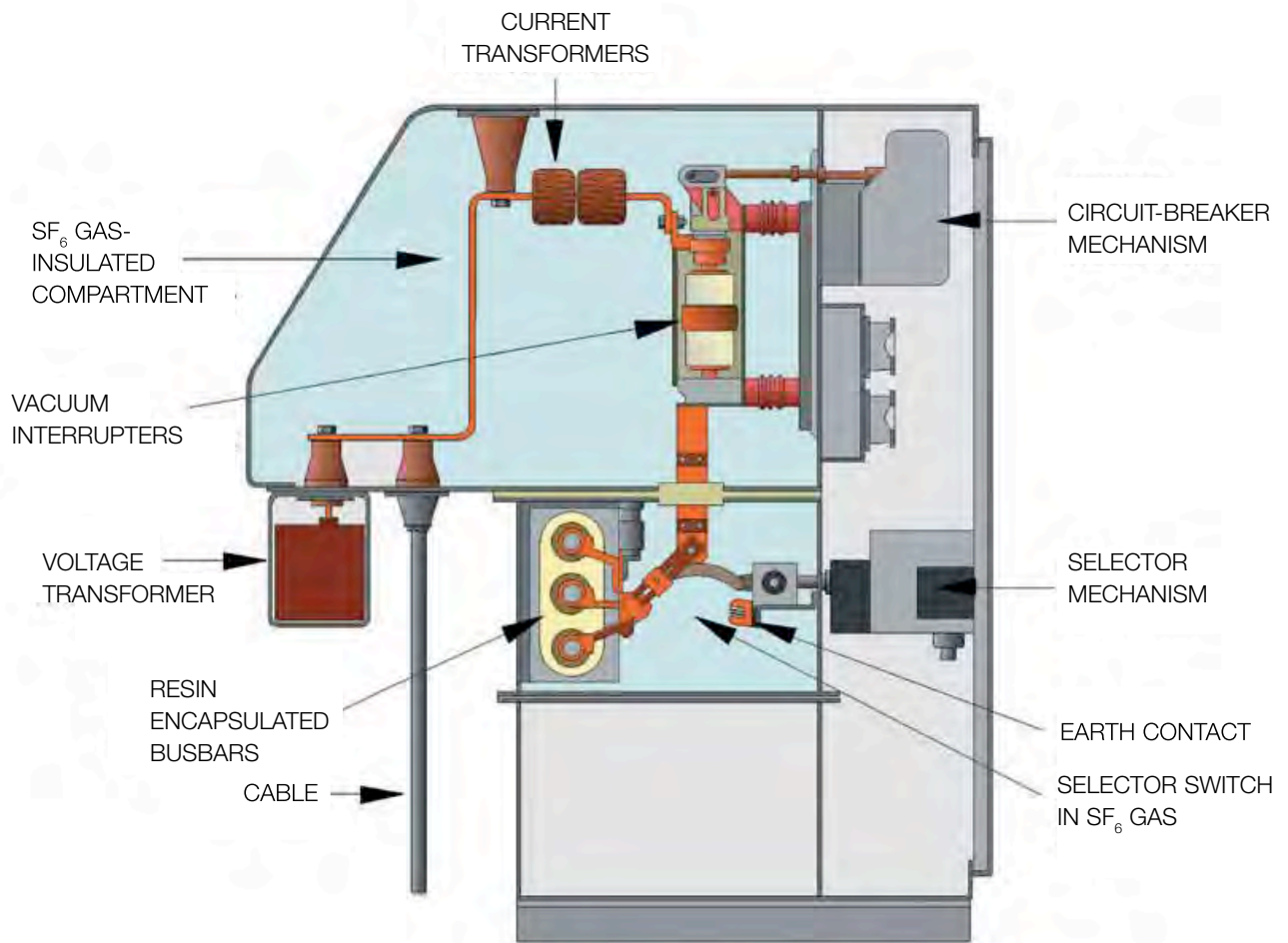

Figure 13 Typical arrangement of a 33 kV fixed-pattern vacuum circuit-breaker with sulphur hexafluoride (SF₆) gas insulation

References and further reading

References

- 1 *Electrical switchgear safety: A guide for owners and users* Leaflet INDG372(rev1) HSE Books 2013 www.hse.gov.uk/pubns/indg372.htm
- 2 *Health and Safety at Work etc Act 1974 (c37)* The Stationery Office 1974 www.legislation.gov.uk
- 3 *The Management of Health and Safety at Work Regulations 1999* SI1999/3242 The Stationery Office www.legislation.gov.uk
- 4 *The Electricity at Work Regulations 1989. Guidance on Regulations* HSR25 (Third edition) HSE Books 2015 www.hse.gov.uk/pubns/books/hsr25.htm
- 5 *Managing and working with asbestos: Control of Asbestos Regulations 2012. Approved Code of Practice and guidance* L143 (Second edition) HSE Books 2013 www.hse.gov.uk/pubns/books/l143.htm
- 6 *Risk assessment: A brief guide to controlling risks in the workplace* Leaflet INDG163(rev4) HSE Books 2014 www.hse.gov.uk/pubns/indg163.htm
- 7 *Explosives Regulations 2014: Safety provisions. Guidance on Regulations* L150 HSE Books 2014 www.hse.gov.uk/pubns/books/l150.htm
- 8 *Electricity at work: Safe working practices* HSG85 (Third edition) HSE Books 2013 www.hse.gov.uk/pubns/books/hsg85.htm
- 9 BS 6626:2010 *Maintenance of electrical switchgear and controlgear for voltages above 1 kV and up to and including 36 kV. Code of Practice* British Standards Institution
- 10 *The Electricity Safety, Quality and Continuity Regulations 2002* SI 2002/2665 The Stationery Office www.legislation.gov.uk
- 11 *Recommendations for the connection of generating plant to the distribution systems of licensed distribution network operators* G59/3 Energy Networks Association 2014 www.energynetworks.org
- 12 *Guidance and the standard specification for thermal imaging of LV electrical installations* FMS 5/99 www.bsria.co.uk
- 13 *Cadmium and you: Working with cadmium. Are you at risk?* Leaflet INDG391(rev1) HSE Books 2010 www.hse.gov.uk/pubns/indg391.htm
- 14 BS EN 60422:2013 *Mineral insulating oils in electrical equipment. Supervision and maintenance guidance* British Standards Institution
- 15 EU Directive 96/59/EC *The Disposal of Polychlorinated Biphenyls and Polychlorinated Triphenyls* <http://eur-lex.europa.eu>
- 16 *The Environmental Protection (Disposal of Polychlorinated Biphenyls and other Dangerous Substances) (England and Wales) Regulations 2000* SI 2000/1043 The Stationery Office www.legislation.gov.uk

17 *The Environmental Protection (Disposal of Polychlorinated Biphenyls and other Dangerous Substances) (Scotland) Regulations 2000* SSI 2000/95
The Stationery Office www.legislation.gov.uk

18 BS EN 62271-4:2013 *High-voltage switchgear and controlgear. Handling procedures of sulphur hexafluoride (SF₆) gas and its mixtures*
British Standards Institution

19 *Guidance on working with sulphur hexafluoride* ER G69
Energy Networks Association 2013 www.energynetworks.org

20 BS EN 60376:2005 *Specification of technical grade sulphur hexafluoride (SF₆) for use in electrical equipment* British Standards Institution

Further reading

General advice (including HSE publications)

Managing for health and safety www.hse.gov.uk/managing

Workplace exposure limits: Containing the list of workplace exposure limits for use with the Control of Substances Hazardous to Health Regulations 2002 (as amended) EH40 HSE Books www.hse.gov.uk/pubns/books/eh40.htm

British Standards relating to switchgear

BS EN 62271-103:2011 *High-voltage switchgear and controlgear. Switches for rated voltages above 1 kV up to and including 52 kV* British Standards Institution

BS EN 62271-200:2012 *High-voltage switchgear and controlgear. AC metal-enclosed switchgear and controlgear for rated voltages above 1 kV and up to and including 52 kV* British Standards Institution

BS EN 62271-106:2011 *High-voltage switchgear and controlgear. Alternating current contactors, contactor-based controllers and motor-starters*
British Standards Institution

BS EN 62271-102:2002+A2:2013 *High-voltage switchgear and controlgear. Alternating current disconnectors and earthing switches* British Standards Institution

BS EN 60947 (Series) *Low-voltage switchgear and controlgear. General requirements and circuit-breakers* British Standards Institution

British Standards relating to oil for switchgear

BS 148:2009 *Reclaimed mineral insulating oil for transformers and switchgear. Specification* British Standards Institution

Disposal of hazardous materials

Classify different types of waste

www.gov.uk/how-to-classify-different-types-of-waste

Glossary

Circuit-breaker A mechanical switching device capable of making, carrying and breaking currents under normal circuit conditions, and also making, carrying for a specified time and breaking currents under abnormal circuit conditions such as those of a short-circuit.

Contact A mechanical switching device (IEV Definition 441-14-33) having only one position of rest, operated otherwise than by hand, capable of making, carrying and breaking currents under normal circuit conditions, including operating overload conditions.

Dependent manual operation (of a mechanical switching device) (IEV Definition 441-16-13). An operation solely by means of directly applied manual energy such that the speed and force of the operation are dependent upon the action of the operator.

Dependent power operation (of a mechanical switching device) (IEV Definition 441-16-14). An operation by means of energy other than manual, where the completion of the operation is dependent upon the continuity of the power supply (to solenoids, electric or pneumatic motors etc).

Fuse switch A switch in which a fuse link or fuse carrier forms the moving contact.

High voltage Normally exceeding low voltage (see below).

Independent manual operation (of a mechanical switching device) (IEV Definition 441-16-16). A stored energy operation where the energy originates from manual power, stored and released in one continuous operation, such that the speed and force of the operation are independent of the action of the operator.

Isolator A mechanical switching device which provides in the open position an isolating distance in accordance with specified requirements. Also called a disconnect. An isolator is capable of opening and closing a circuit either when negligible current is broken or made, or when no significant change in the voltage across the terminals of each of the poles of the isolator occurs.

Low voltage Normally exceeding 50 V AC or 120 V DC, but not exceeding 1000 V AC or 1500 V DC between conductors, or 600 V AC or 900 V DC between conductors and earth.

Stored energy operation (of a mechanical switching device) (IEV Definition 441-16-15). An operation by means of energy stored in the mechanism itself prior to the completion of the operation and sufficient to complete it under predetermined conditions. This kind of operation may be subdivided according to:

- the manner of storing the energy (spring, weight etc);
- the origin of the energy (manual, electric etc); and
- the manner of releasing the energy (manual, electric etc).

Switch A mechanical switching device capable of making, carrying and breaking currents under normal circuit conditions, and also making and carrying for a specified time currents under abnormal circuit conditions such as those of a short-circuit. A switch cannot be used to break current under abnormal circuit conditions.

Switch fuse A switch in which one or more poles has a fuse connected in series in a composite unit.

Switchgear A combination of one or more switching devices together with associated control, measuring, signal, protective and regulating equipment etc completely assembled under the responsibility of the manufacturer with all the internal electrical and mechanical interconnections and structural parts.

Further information

For information about health and safety, or to report inconsistencies or inaccuracies in this guidance, visit www.hse.gov.uk/. You can view HSE guidance online and order priced publications from the website. HSE priced publications are also available from bookshops.

British Standards can be obtained in PDF or hard copy formats from BSI: <http://shop.bsigroup.com> or by contacting BSI Customer Services for hard copies only Tel: 0845 086 9001 email: cservices@bsigroup.com.

The Stationery Office publications are available from The Stationery Office, PO Box 29, Norwich NR3 1GN Tel: 0870 600 5522 Fax: 0870 600 5533 email: customer.services@tso.co.uk Website: www.tsoshop.co.uk. (They are also available from bookshops.) Statutory Instruments can be viewed free of charge at www.legislation.gov.uk where you can also search for changes to legislation.

APPENDIX D

HSE Guidance HSG85 Electricity at Work

Electricity at work

Safe working practices

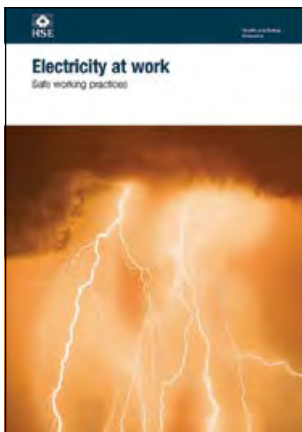

HSG85 (Third edition)
Published 2013

The guidance covers the key elements to consider when devising safe working practices and is for people who carry out work on or near electrical equipment.

It includes advice for managers and supervisors who control or influence the design, specification, selection, installation, commissioning, maintenance or operation of electrical equipment.

This third edition updates the guidance and provides sources of further information.

© *Crown copyright 2013*

First published 2013

ISBN 978 0 7176 6581 5

You may reuse this information (not including logos) free of charge in any format or medium, under the terms of the Open Government Licence. To view the licence visit www.nationalarchives.gov.uk/doc/open-government-licence/, write to the Information Policy Team, The National Archives, Kew, London TW9 4DU, or email psi@nationalarchives.gsi.gov.uk.

Some images and illustrations may not be owned by the Crown so cannot be reproduced without permission of the copyright owner. Enquiries should be sent to copyright@hse.gsi.gov.uk.

This guidance is issued by the Health and Safety Executive. Following the guidance is not compulsory, unless specifically stated, and you are free to take other action. But if you do follow the guidance you will normally be doing enough to comply with the law. Health and safety inspectors seek to secure compliance with the law and may refer to this guidance.

Contents

Introduction 4

Definitions 4

What are the hazards? 6

Correct selection and use of equipment 7

Actions for managers and supervisors 9

Assessing safe working practices 11

Deciding whether to work dead or live 12

Can the normal policy of dead working be carried out? 12

Is it unreasonable for the work to be done dead? 12

Identify, assess and evaluate the risks and methods for controlling them 12

Decide whether it is reasonable to work live 14

Decide whether suitable precautions can be taken to prevent injury 14

Actions common to both dead and live working 16

Identify the circuit or equipment to be worked on or near and the work that needs to be done 17

Plan the work 17

Specify level of supervision and whether accompaniment is necessary 17

Select and instruct competent workers 18

Ensure correct working methods 18

Provide and ensure use of appropriate protective equipment 18

Provide information, tools and instruments and ensure workers are fully instructed 18

Make arrangements for management checks and supervision of work 19

Working dead 20

Identification 21

Disconnection 21

Secure isolation 21

Post notices 21

Proving dead 22

Earthing 22

Adjacent parts 22

Additional procedures 23

Extra precautions for high-voltage work 23

Electrical permits-to-work 24

Working live 27

Appendix: Typical example of an electrical permit-to-work 28

References 30

Further reading 32

Further information 33

Introduction

1 This guidance is for people, including the self-employed, who carry out work on or near electrical equipment. It includes advice on safe working practices for managers and supervisors who control or influence the design, specification, selection, installation, commissioning, maintenance or operation of electrical equipment. Organisations that already have industry-specific rules or guidance for safe working practices should ensure that all aspects addressed in this guidance are adequately covered. Those that have no such internal rules should use this guidance to devise safe working practices relating to their own specific circumstances and activities.

2 The Electricity at Work Regulations 1989 (EAW Regulations) apply to almost all places of work. The *Memorandum of guidance on the Electricity at Work Regulations 1989*¹ (the Memorandum) is intended to help dutyholders meet the requirements of the Regulations. This guidance supplements the Memorandum with further advice on safe working practices. Where regulation numbers are given in Figures 1–5, these refer to the EAW Regulations. There is also an Approved Code of Practice covering the use of electricity at mines that provides additional guidance relevant to mining.² Other legislation can also apply to electrical work and some of this is listed in the ‘References’ or ‘Further reading’ sections, as are all other publications referred to in this guidance.

Definitions

3 Unless the context otherwise requires, in this guidance the following words and terms have meanings as given below (note: some of these terms are defined in the EAW Regulations):

- **charged:** the item has acquired a charge either because it is live or because it has become charged by other means such as by static or induction charging, or has retained or regained a charge due to capacitance effects even though it may be disconnected from the rest of the system;
- **dead:** not electrically ‘live’ or ‘charged’;
- **designated competent person (also known in some industries as ‘authorised person’ and ‘senior authorised person’):** a competent person appointed by the employer, preferably in writing, to undertake certain specific responsibilities and duties, which may include the issue and/or receipt of safety documents such as permits-to-work. The person must be competent by way of training, qualifications and/or experience and knowledge of the system to be worked on;
- **disconnected:** equipment (or a part of an electrical system) that is not connected to any source of electrical energy;
- **equipment:** electrical equipment including anything used, intended to be used or installed for use, to generate, provide, transmit, transform, rectify, convert, conduct, distribute, control, store, measure or use electrical energy (as defined in the EAW Regulations);

- **high voltage:** a voltage in excess of 1000 V ac or 1500 V dc. Voltages below these values are 'low voltage';
- **isolated:** equipment (or part of an electrical system) which is disconnected and separated by a safe distance (the isolating gap) from all sources of electrical energy in such a way that the disconnection is secure, ie it cannot be re-energised accidentally or inadvertently;
- **live:** equipment that is at a voltage by being connected to a source of electricity. Live parts that are uninsulated and exposed so that they can be touched either directly or indirectly by a conducting object are hazardous if the voltage exceeds 50 V ac or 120 V dc in dry conditions – see BSI publication PD 6519³ – and/or if the fault energy level is high;
- **live work:** work on or near conductors that are accessible and 'live' or 'charged'. Live work includes live testing, such as using a test instrument to measure voltage on a live power distribution or control system.

What are the hazards?

4 Electricity can kill or severely injure people and cause damage to property from the effects of fires and explosions. Every year accidents at work involving electric shock or burns are reported to the Health and Safety Executive (HSE). Electric shocks do not always cause lasting injury but in certain circumstances can result in death, known as electrocution. The sudden muscular contraction during the shock can result in injuries from, for example, falling. Electric current flowing through the body can cause deep burns.

5 Electrical arcing (sometimes called a 'flashover' or 'arc flash'), perhaps as a result of a short circuit caused by unsafe working practices, can generate intense heat leading to deep-seated and slow-healing burns, even if it persists for a short time. The intense ultraviolet radiation from an electric arc can also cause damage to the eyes. Often those working with or near electricity do not appreciate the risk of serious injury and consequential damage to equipment that can arise from arcing.

6 Arcing, overheating and, in some cases, electrical leakage currents can cause fire or explosion by igniting flammable materials. This can cause death, injury and considerable financial loss.

7 Most electrical accidents occur because people are working on or near equipment that is:

- thought to be dead but which is live;
- known to be live but those involved do not have adequate training or appropriate equipment to prevent injury, or they have not taken adequate precautions.

Correct selection and use of equipment

8 Equipment must be properly designed, constructed, installed and maintained so that it does not present a risk of electric shock, burns, fire or explosion when properly used. There are many equipment-specific standards that include safety-related requirements which, if followed, will ensure that the electrical risks are adequately controlled.

9 The main standard for low-voltage electrical installations is BS 7671 *Requirements for electrical installations*.⁴ It describes how systems and equipment can be designed, constructed and installed so that they can be used safely. The standard covers installations that operate at low voltage (up to 1000 V ac). Meeting the requirements of this standard is likely to achieve compliance with the relevant parts of the EAW Regulations.

10 Some old equipment that is still in use, including open-type switchboards and fuseboards used by electricity distributors and in industrial premises such as steelworks, is not designed or constructed to prevent people touching live conductors and suffering injuries from shock or burns. In these cases, the user must have sufficient knowledge and experience to recognise the danger and avoid it. This type of equipment should be located in a secure room or area, with access available only to those who have specific authority and are competent to prevent danger. Even then, you will need to further protect this type of open, uninsulated equipment to prevent accidental contact with live parts when competent persons are working near it.

11 Some equipment operates at voltages that are so low that they cannot cause a harmful electric shock but even at these extra-low voltages an arc can occur, burns can result from overheated conductors, or an explosive atmosphere can be ignited. A short-circuited car battery, for example, may cause the conductors to overheat and even cause the battery to explode. The following advice also applies to self-contained sources of electrical energy, whether the risk is from electric shock, burn, arcing, or explosion.

12 You must select equipment that is suitable for the environment in which it is used, for example cables and equipment in heavy industries such as sheet metal works need to be protected against mechanical damage. You should consider adverse environmental factors when working on equipment. For example, excessively damp or humid conditions will increase the risk of injury because of reduced effectiveness of insulation, which may undermine the effectiveness of devices used for isolation, or increase the severity should an electric shock occur. Equipment that has corroded may not function as intended.

13 Certified explosion-protected equipment must be used in places where there could be potentially explosive atmospheres, for example if there has been a leak of flammable gas or build-up of combustible dust that could be ignited by an electric spark; more information is available in the Dangerous Substances and Explosive Atmospheres Regulations 2002⁵ and, for offshore installations, the Offshore

Installations (Prevention of Fire and Explosion, and Emergency Response) Regulations 1995.⁶

14 You must assess the situation before work is carried out on or near equipment. Working on equipment may result in removal of components and parts that provide protection for people against electric shock when the equipment is in normal use.

15 You should ensure safety by the careful design and selection of electrical equipment. For example:

- switch disconnectors should have a locking-off facility or other means of securing them in the OFF position;
- circuits and equipment should be installed so that all sections of the system can be isolated as necessary;
- switch disconnectors should be suitably located and arranged so that circuits and equipment can be isolated without disconnecting other circuits that are required to continue in service;
- devices used for isolating circuits must be clearly marked to show their relationship to the equipment they control, unless there could be no doubt that this would be obvious to anyone who may need to operate them.

HSG230 *Keeping electrical switchgear safe*⁷ includes guidance on the selection, use, care and maintenance of high-voltage and low-voltage switchgear.

16 Control panels should be designed with insulated conductors and shrouded terminals so that commissioning tests, fault-finding, calibration etc can be carried out with a minimum of risk. The Engineering Equipment and Materials Users' Association (EEMUA) has produced a design guide for electrical safety.⁸ Interlocking is recommended to reduce the risk of injury from contact with live parts. Equipment with segregated power and control circuits is preferred.

17 Where possible, you must avoid live working during commissioning and fault-finding; eg by using suitably designed equipment with in-built test facilities and diagnostic aids. There must be adequate space, access and lighting to work safely. Temporary systems and equipment should be designed, constructed, installed and maintained to avoid danger.

Actions for managers and supervisors

18 Managers should establish a system of rules and procedures wherever electrical work is to be carried out, or ensure that contractors brought in to do electrical work have appropriate rules and procedures. These should be written down and everybody involved must be made aware of them as they will form the basis of task-specific risk assessments. The amount of detail depends on the circumstances; the simplest form may be a brief policy statement (perhaps reflecting a policy of always switching off, securing the isolation, working dead, and never working on live equipment) backed up by a set of simple instructions to reflect that policy. Where there are extensive or complex electrical systems, especially high-voltage systems, this will be reflected in the safety rules, which should embody a methodical approach so that the safety principles involved can be clearly understood by everyone.

19 Safety rules should set out the principles and general practices clearly and in a compact format. Those carrying out the work should be instructed to carry the safety rules with them. Workers should know the limitations of their work allowed under the safety rules. Detailed procedures for safe working on particular equipment, or under particular circumstances, should be the subject of separate documents, including task-specific risk assessments or method statements, which should be readily available when required (even in out-of-hours emergencies). These safety rules should be devised to reflect, among other things, the relevant organisation, personnel, the electrical system to be worked on, and the working environment. Further guidance can be obtained from three British Standards – BS 6423,⁹ BS 6626¹⁰ and BS 6867.¹¹

20 If something unforeseen occurs during a working procedure, there should be a review of the work. Even a properly trained, competent worker may not always be aware of what to do when things go wrong. The worker should have been trained to recognise that there may be a need to change to a new system of work. It will normally be necessary for the worker to know how to refer a changed situation to the correct people, by communicating both up and down the management structure in the organisation.

21 If you have managerial or supervisory responsibilities, it is important that you ensure that everyone knows how to work safely and without risk to their health, and that all workers follow the safety rules and control measures identified in risk assessments:

- you should be involved in planning the work and in the risk assessment process, coordinating the work where more than one group is involved, and discussing the necessary precautions and emergency procedures with the workers;
- you must clearly define the roles and responsibilities of the supervisors and workers, including those of any contractors who may be employed;
- you must ensure that supervisors are competent to supervise the work, with the level of supervision being appropriate to the danger and the competence of those carrying out the work;

- you must identify those people who are competent and have knowledge and experience of the electrical system to be worked on. Anyone who does not have this will need a greater level of supervision, or will need to be given adequate training to make sure that they have the correct skills, knowledge and risk awareness for the task. Do not let unauthorised, unqualified or untrained people work on electrical systems.

Assessing safe working practices

22 Figure 1 illustrates the sequence of the planning steps. The procedure can be divided into four stages as follows:

- deciding whether to work dead or work live (coloured orange), see Figure 2;
- planning and preparation for actions which are common to both dead and live working (coloured blue), see Figure 3;
- procedures for working dead (coloured green), see Figure 4;
- procedures for working live (coloured red), see Figure 5.

Figure 1 Basic flow chart for assessing safe working practices

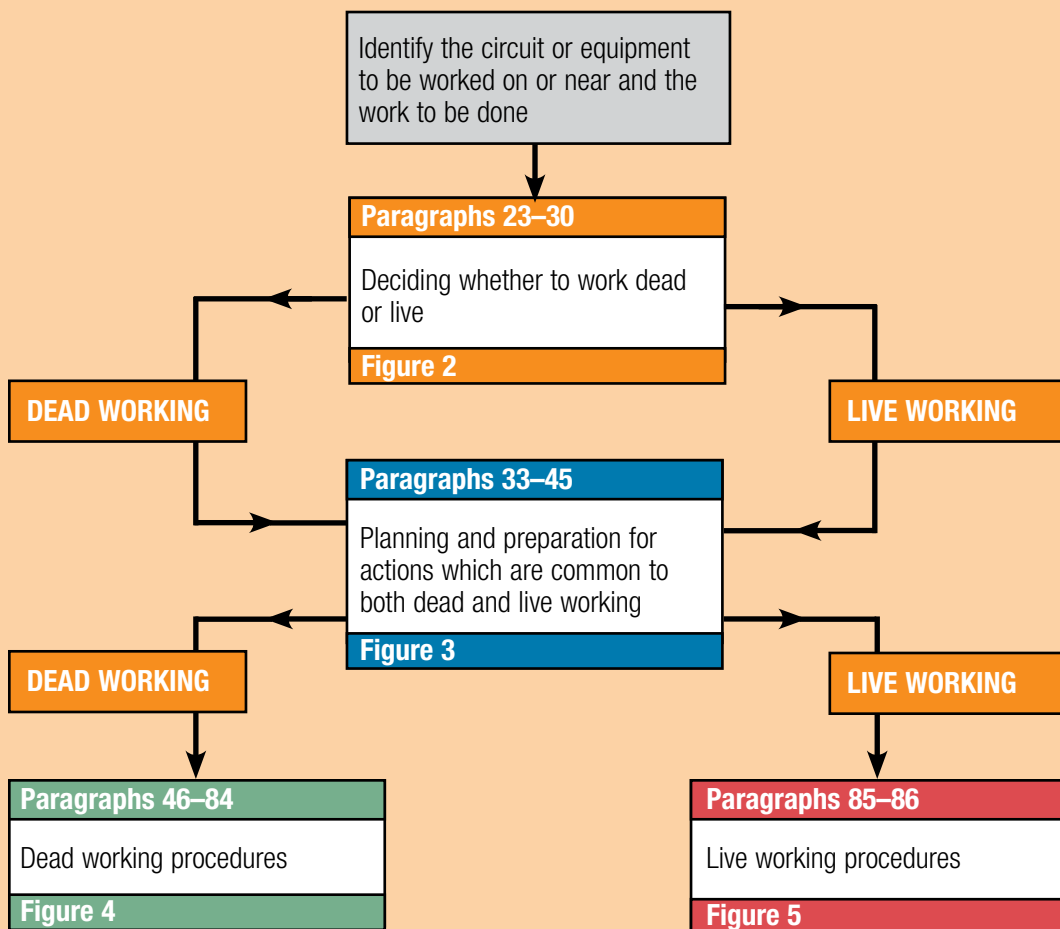

Deciding whether to work dead or live

Can the normal policy of dead working be carried out?

23 The factors to consider are illustrated in Figure 2. Work on or near live exposed conductors should rarely be permitted. Many accidents to electricians, fitters, technicians and engineers occur when they are working on equipment that could have been isolated. You should plan and programme the work to allow all jobs to be carried out where possible with the equipment dead. Three conditions must be met for live working to be permitted where danger may arise. **If just one of these conditions cannot be met, live working must not be permitted and dead working is essential.** The assessment procedure illustrates this. The conditions are:

- it is unreasonable in all the circumstances for the conductor to be dead; and
- it is reasonable in all the circumstances for the person to be at work on or near that conductor while it is live; and
- suitable precautions (including, where necessary, the provision of personal protective equipment) have been taken to prevent injury.

Is it unreasonable for the work to be done dead?

24 There are some circumstances where it is unreasonable to make equipment dead because of the difficulties it would cause. For example:

- it may be difficult, if not impossible, to commission a complex control cabinet without having it energised at some time with parts live (but not exposed so that they may be easily touched);
- it may not be technically feasible to monitor the operation and performance of a control system or to trace a malfunction of such equipment with it dead, ie fault-finding;
- a distribution network operator (DNO) needs to connect a new low-voltage service to an existing main, but it might be unreasonable to disconnect many customers. In recognition of the dangers associated with live working, the DNO must have a very strict code of safety rules and procedures to prevent injury;
- switching off a system, such as the supply to an electric railway track, to carry out maintenance or repair work may cause disproportionate disruption and cost.

Identify, assess and evaluate the risks and methods for controlling them

25 If you have decided that it is unreasonable for the work to be done dead, a risk assessment¹² is necessary. The risk assessment must cover the work on or near the specific equipment and it must be carried out by someone with comprehensive knowledge and experience of the type of work and the means of controlling the risks.

Figure 2 Deciding whether to work dead or live

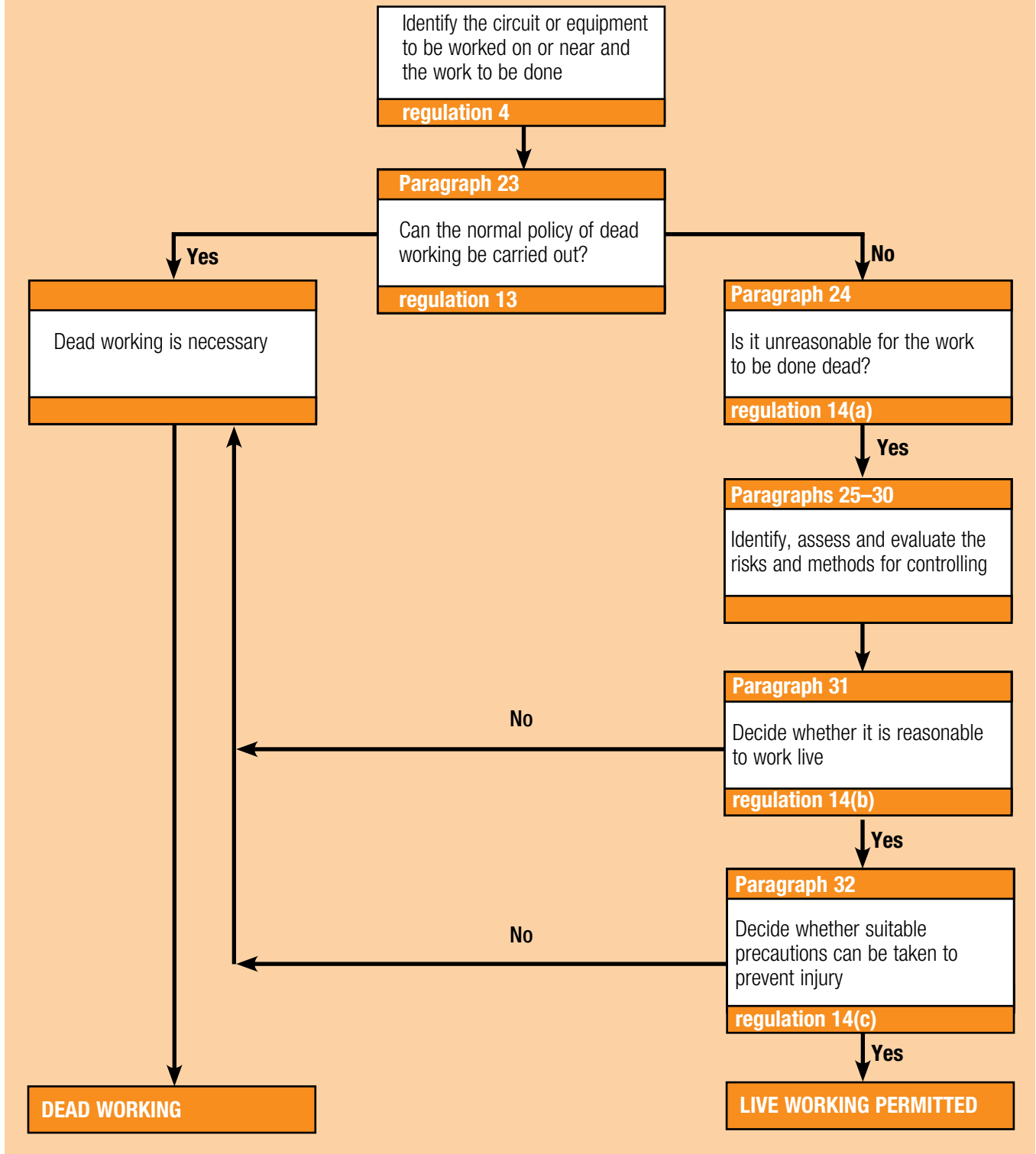

26 A risk assessment is about identifying and taking sensible and proportionate measures to control the risks in your workplace, not about creating huge amounts of paperwork. Ask your employees what they think the hazards are, as they may notice things that are not obvious to you and may have some good ideas on how to control the risks.

27 Having identified the hazards arising from the live work, you then have to decide how likely it is that harm will occur and the severity of injury that might occur. Risk is a part of everyday life and you are not expected to eliminate all risks but you need to take account of the fact that electricity can cause very serious injuries and death. What you must do is make sure you know about the main risks and the things you need to do to manage them responsibly. Generally, you need to do everything reasonably practicable to protect people from harm.

28 As part of this process, you will need to consider the competence of the people who will be carrying out the work and their ability to avoid danger, taking into account the available precautions.

29 Make a record of your significant findings – the hazards, how people might be harmed by them and what you have in place to control the risks. Any record produced should be simple and focused on controls. If you have fewer than five employees, you do not have to write anything down. But it is useful to do this so you can review it at a later date, for example if something changes. If you have five or more employees, you are required by law to write it down.

30 Few workplaces stay the same, and you should review what you are doing on an ongoing basis.

Decide whether it is reasonable to work live

31 The risk assessment should inform managers and supervisors whether it is reasonable in all the circumstances to work live. The decision should not be taken lightly. At this stage the economic and operational factors should be evaluated against the risks involved before making a decision, bearing in mind that the risks associated with working live can be very serious. Minor inconveniences arising from working with the equipment dead, sometimes arising from commercial and time pressures, will very rarely outweigh the risks associated with live work.

Decide whether suitable precautions can be taken to prevent injury

32 Providing the requirements above have been met, live working can still only be justified if suitable precautions are taken to prevent injury arising from the hazards identified in the risk assessment. The precautions should have been identified in the risk assessment and might include:

- installing temporary insulation, protective enclosures, or screens to prevent parts at different potentials being touched at the same time;
- using temporary barriers with warning notices affixed to keep unauthorised people away from the work area;
- ensuring that adequate clearances are established and maintained when working near to live equipment (see Appendix 3 of the Memorandum and Section 729 of BS 7671:2008 (+A1:2011) for information on clearances). For work near live overhead power lines, see GS6 *Avoiding danger from overhead power lines*;¹³

- making sure that workers understand the task and the system to be worked on (clarity of instructions is essential), are trained and experienced, and follow the correct procedures. They must be competent to realise their own limitations and know when to seek help;
- providing lighting and working space that is adequate and free from trip hazards. Further details on lighting at work can be found in HSG38 *Lighting at work*;¹⁴
- using robust and properly insulated tools (see BS EN 60900¹⁵);
- using test instruments with insulated probes and fused leads (see GS38 *Electrical test equipment for use by electricians*¹⁶);
- maintaining tools and test equipment in good condition and replacing them if damaged;
- storing tools correctly – horizontal surfaces and projections inside control cabinets should not be used – and ensuring that objects such as tools and bolts cannot fall onto exposed live parts;
- avoiding lone live working. Quick action is needed in the event of an electric shock to disconnect the supply and give assistance, so it will usually be necessary to be accompanied by someone who is competent to make the system safe and avoid injury;
- providing and using correct personal protective equipment (PPE) to reduce the risk of contact with live parts or earth, eg insulating gloves, insulating matting (see BS EN 61111:2009¹⁷). If there is a risk of burns from arcing or flashover that cannot be avoided, consider the use of adequately rated, thermally insulating, flame-resistant PPE (including face/eye protection). PPE should be frequently inspected and replaced if damaged. Requirements relating to PPE are covered by the Personal Protective Equipment at Work Regulations 1992.¹⁸

Actions common to both dead and live working

33 The actions common to both dead and live working are illustrated in Figure 3 and described below.

Figure 3 Planning and preparation for actions which are common to both dead and live working

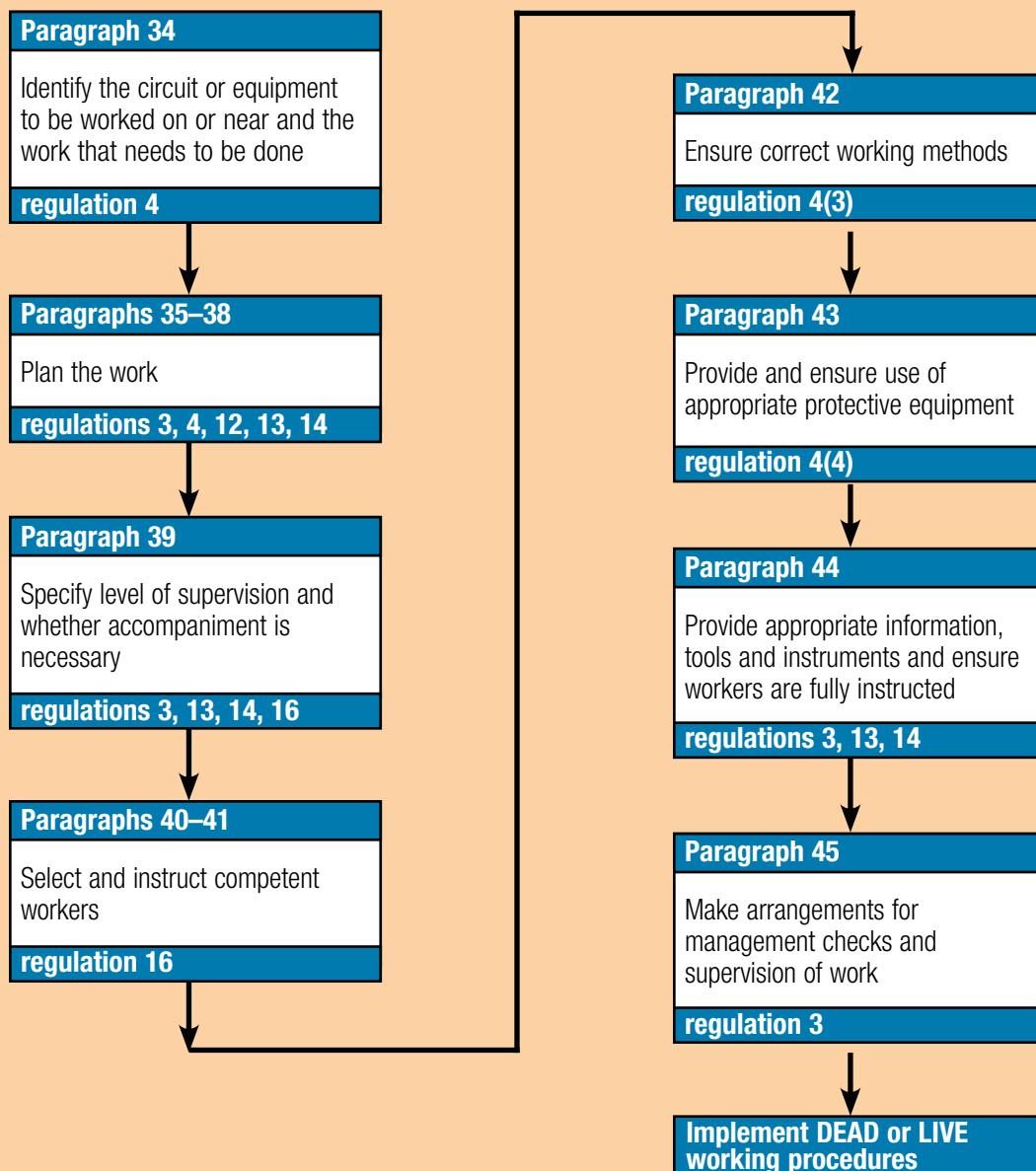

Identify the circuit or equipment to be worked on or near and the work that needs to be done

34 These tasks should be carried out before the work starts. Factors that may affect the safe system of work should also be taken into account. In many cases, actual physical identification will be necessary and this may be aided by the use of appropriate drawings, diagrams and other written information. The features of equipment mentioned in paragraphs 8–17 should be taken into account.

Plan the work

35 Many electrical accidents are due to a failure to plan ahead. Planning should consider the management, supervision, implementation and completion of the work, and should lead to a formal system of work based on information in the safety rules and a task-specific risk assessment. In some instances, the planning requirements of the Construction (Design and Management) Regulations¹⁹ will apply. You should consider the following:

- the work to be done;
- the hazards of the system or equipment to be worked on and the risks associated with the work;
- the people doing the work, their competence and the level of supervision necessary;
- the precautions to be taken and the system of work to be employed;
- the possibility that the nature of the work may change, eg a testing job may turn into fault finding.

36 There must be adequate information available about the electrical system and the work to be done. In the case of a newly constructed electrical system (or newly installed equipment), there should be drawings and schedules relating to the design and these should have been updated, if necessary, by the people carrying out the installation.

37 Records in the form of drawings and/or schedules should be kept for all but the most basic of installations. In the case of old installations where records may be poor, you should attempt to improve the records, eg by a combination of surveying, testing and labelling. However, when checking records before working on an installation it is unwise to rely solely on one source of information, eg a label. Labels should be securely fixed to equipment to clearly identify their function.

38 Electrical accidents often occur during fault-finding after a plant breakdown when pressure to repair the equipment results in risks being taken. To anticipate this, you should plan and establish safe fault-finding procedures to be implemented during breakdown maintenance.

Specify level of supervision and whether accompaniment is necessary

39 The planning process will have indicated the level of supervision required. An important factor to consider is the amount of training and experience workers have had to do the specific jobs – the less experienced or knowledgeable the worker is, including the level of familiarity with the system to be worked on, the greater will be the need for supervision. There will also be a greater need for supervision when working live. The need for accompaniment is also greater for live work, although it may still be necessary for some cases of working dead, especially if there are

adjacent live parts. The accompanying person should be trained to recognise danger, to switch off and, if necessary, to give assistance in the event of an emergency.

Select and instruct competent workers

40 Training as part of making a person competent is very important. Even the most highly qualified and capable people may not be competent to carry out specific types of work without suitable training. Competent workers will be self-disciplined and aware that reckless behaviour with electricity can lead to injury and death.

41 Those in control of the work should:

- assess the degree of competence of individual workers against the **specific** type of work to be done;
- provide clear instructions, information and adequate training for employees on:
 - the risks they may face;
 - the measures in place to control the risks, emphasising the safe system of work to be used;
 - how to follow emergency procedures;
- arrange for those being trained or those newly trained to be accompanied and supervised.

Ensure correct working methods

42 Managers and supervisors should ensure that workers understand the correct working methods, related to the specific work in hand. People doing the work should be aware of the limitations of that work and the constraints as to how they carry out the work. This includes recognising when it is unsafe to continue with the work and knowing how to deal with any contingencies that may arise.

Provide and ensure use of appropriate protective equipment

43 Managers, supervisors and workers have a responsibility to provide the protective equipment identified in the task-specific risk assessment and make sure that it is:

- suitable for the use for which it is provided;
- maintained in a condition suitable for that use; and
- used properly.

Provide information, tools and instruments and ensure workers are fully instructed

44 The workers must be supplied with and use correct and appropriate information, such as electrical drawings, tools, instruments.

Make arrangements for management checks and supervision of work

45 Employers and workers must comply with the EAW Regulations in so far as they relate to matters within their control. You should check that workers are following the rules and correct procedures. Sometimes, some or all of these checks may be delegated to the supervisor of the work. Even in organisations with effective written safety rules and safe systems of work, regular and systematic management checks of the work are necessary. This is particularly important if the work is being done in the field, on another occupier's premises, or by peripatetic workers.

Working dead

46 While it is not always possible to follow a set procedure rigidly in every situation, the sequence illustrated in Figure 4 is recommended as a guide.

Figure 4 Dead working procedures

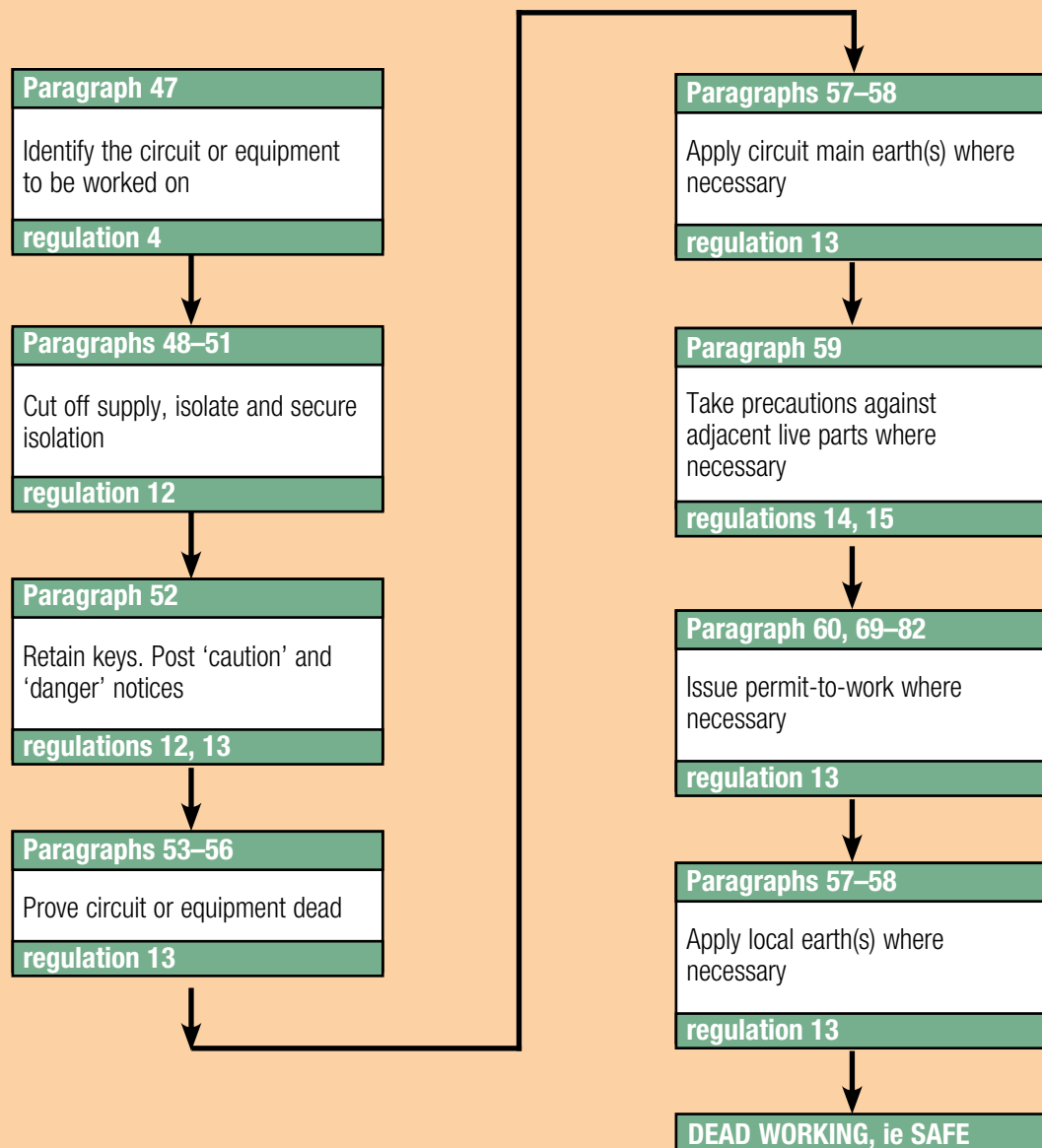

Identification

47 Adequate information should be supplied to identify equipment correctly (see paragraph 36). For most circuits and equipment correct labelling is important, but it should never be assumed that labelling is correct and that work can be started without having first proved that the equipment or circuit is dead. In some special cases, eg underground cables, cable-locating techniques using specialised instruments may be necessary and it may also be necessary to identify the cable both before and after switching operations and cable spiking.

Disconnection

48 Disconnect the equipment from every source of electrical energy before working on, or near, any part which has been live or is likely to be live. On equipment that is capable of storing charge, such as capacitors and high-voltage cables, ensure that any stored charge has been safely discharged.

Secure isolation

49 For adequate isolation, the disconnecting device should have an isolating gap sufficient for the voltage levels present or likely to occur. Make sure that any switch disconnecter or other means of disconnection is secure. Switches, including circuit breakers, should be locked in the OFF position preferably using a 'safety' lock, ie a lock or padlock having a unique key or combination. Lockout devices that can be attached to the actuators of circuit breakers are available and should be used where appropriate. All keys should be retained in a secure place. If a plug has been withdrawn, make sure that it cannot be reconnected to the electrical supply while work is taking place on the circuits or apparatus – the use of proprietary lock-out devices for this purpose is encouraged.

50 If a fuse is removed, make sure that it or a similar one cannot be reinserted by taking it away or by locking the box or enclosure until work is completed. Some manufacturers produce lockable insulating blanks that you can insert in an empty fuseway. These prevent inadvertent fitting of a fuse while the associated circuit is being worked on.

51 If you rely on locking off where a number of people are working, the use of a multiple locking hasp attachment, lock-out box or key-safe may be appropriate to ensure that all the locks have to be removed before the equipment can be re-energised. Everyone involved in the work should apply a lock to the multiple locking hasp and keep personal possession of the key.

Post notices

52 You should put a notice or label at the place of disconnection so everyone else knows that work is being done. For example, a 'caution' notice can be used to indicate that someone is working on the apparatus and may be injured if it is re-energised, and 'danger' notices attached to live equipment adjacent to the place of work will indicate that the apparatus is still energised. Notices or labels should be easily understood by anyone in the area. You should remove labels or notices when they no longer apply so that the system does not fall into disrepute. It is often useful for the 'caution' and 'danger' notices to have a space for the name of the person responsible for the work and for the date.

Proving dead

53 Having isolated the circuit or equipment, and before working on it, check that the parts to be worked on or near really are dead, even if the isolation has been achieved automatically through an interlocking system. If it is a three-phase system or equipment with more than one supply, prove that all supply conductors are dead.

54 The instrument to do this should be properly constructed to protect against electric shock and designed to prevent short circuits occurring during use. For low voltages, proprietary voltage detectors such as two-pole voltage detectors, test lamps, or voltmeters with insulated probes and fused leads can be used (see HSE Guidance Note GS38). The use of multimeters, which can be set to the wrong function, is not recommended for proving dead on low-voltage systems, neither is the use of non-contact devices such as 'volt sticks' (note: in coal mines the use of appropriately certified non-contact devices is permitted).

55 It will be necessary to test the instrument before and after use. This may be done by means of a proving unit with a low power output. If live circuits are used to prove instruments, adequate precautions against electric shock and short circuits should be taken (see paragraphs 25–32). Training in the correct use of voltage detectors is essential to avoid risk in the event of unexpected use on a live conductor. All instruments used for checking circuits should be maintained and inspected frequently (note: in coal mines appropriately certified non-contact devices must be tested daily before they are taken underground).

56 Where underground cables cannot be positively identified and proved dead at the point of work, it may be necessary to spike the cable using a properly designed, cartridge-operated spiking gun.

Earthing

57 The risk to people if the above precautions fail can be minimised by securely earthing all the conductors using properly designed earthing devices or earthing leads, usually applied to all points where the circuit or equipment is isolated from the supply. Additional local earths at the point of work may also be necessary if this is remote from the point of isolation, but these should be applied only after proving dead at the point of work. This procedure is essential for high-voltage apparatus and stored energy equipment (eg capacitors). The earthing conductors and their connections should be suitable for the energy that may flow in the event of a failure of the above precautions.

58 Earthing low-voltage equipment is desirable if there is a risk of re-energisation, eg from a generator under someone else's control. In other low-voltage equipment, however, it may be physically impractical to apply earths, or the risk of short circuit from introducing an earth near adjacent live parts may outweigh the benefit of earthing the apparatus being worked on.

Adjacent parts

59 When the circuit or equipment to be worked on has been made dead or where the work is non-electrical, you must still protect against danger from inadvertent contact with other live parts nearby. This should preferably be done by erecting physical barriers and/or the use of temporary insulation and posting 'danger' notices. The requirements regarding adequate working space, access and lighting must also be met.

Additional procedures

60 On high-voltage systems (and often on high-energy systems) a permit-to-work should be issued but only after all the actions described in paragraphs 47–59 have been carried out. It is not common practice to issue permits-to-work for work on low-voltage systems but they should be considered if their use would contribute to safety in specific circumstances. (See paragraphs 69–84 for more information on permit-to-work systems.)

Extra precautions for high-voltage work

61 The following paragraphs apply to equipment and circuits operating at high voltage. They should also be applied to low-voltage installations where high fault power gives rise to a risk of serious burns. There are a few exceptional circumstances where high voltages will not give rise to danger, for example if the maximum possible current is reliably limited to a safe level (see PD 6519 Parts 1 and 2).

62 High-voltage equipment should be designed and installed so that it is not necessary to work on exposed live parts. However, it is commonly necessary for voltage checks or tests to be carried out, and for observations to be made from safe distances such as when carrying out phase rotation tests.

63 Because high voltages can arc across an air gap, you can suffer a shock or burn without touching live voltage parts. The dead working procedure in paragraphs 46–59 must therefore be followed. Isolation should be by means of a device that has a safe isolating gap between live parts and those that have been made dead for work to be carried out (see relevant British Standards). Earthing conductors at the point where the supply is disconnected are essential and additional earths may be necessary at the place of work.

64 The system of locking OFF while work is in progress should use safety locks which have unique keys so that the apparatus cannot be inadvertently re-energised. The keys should be retained in a key safe or other suitable place available only to the person in charge of the activity; see paragraphs 49–51. The precautions should be backed up with a disciplined documentation system; the electrical permit-to-work is an established system that has proved to work well in practice and is described in paragraphs 69–84.

65 Additional procedures will be necessary to adequately cover shift changes or work extending over long periods. It may also be necessary to have special rules or procedures for particular items of equipment and for particular working practices such as testing (eg it may be necessary to remove earths to facilitate testing under a clearly defined sanction-to-test procedure).

66 Precautions must be taken to prevent people approaching dangerously close to uninsulated high-voltage conductors. This will normally mean that any work on high-voltage equipment is undertaken only after all the precautions set out in paragraphs 47–54 have been taken. There are, however, some special situations where, by the use of appropriate tools, apparatus, and precautions, work on live high-voltage conductors may be permissible while the people involved are at a safe distance. Two examples are work on overhead conductors by DNOs or work on railways using long, specially designed, insulated tools.

67 Some transmission and distribution network operators carry out live, hands-on working on overhead conductors. For this type of work special vehicles, work

equipment, tools, clothing etc, together with exacting working methods, are necessary to ensure safe working. For all the special situations referred to, specific work procedures need to be devised and a very high degree of competence and discipline are essential for everyone involved. These special situations are not within the scope of this document.

68 Similar procedures may also be necessary if high-voltage apparatus is to be tested. In every case, the objective is to prevent anyone coming near to live, high-voltage conductors and the procedure should reflect this.

Electrical permits-to-work

69 A typical example of an electrical permit-to-work form is given in the Appendix. Further information is available in BS 6626 and BS 6867. An electrical permit-to-work is primarily a statement that a circuit or item of equipment is safe to work on – it has been isolated and, where appropriate, earthed. You must never issue an electrical permit-to-work for work on equipment that is still live or to authorise live work. The information it contains should be precise, detailed and accurate. It should state which equipment etc has been made safe, the steps by which this safety has been achieved, and exactly what work is to be done.

70 An electrical permit-to-work differs to the more general permit-to-work systems used in, for example, the petroleum and chemical industries (see HSG250 *Guidance on permit-to-work systems: A guide for the petroleum, chemical and allied industries*²⁰). These more general permit-to-work systems are an integral part of safety management arrangements covering a wide range of activities and hazards. It is common for the requirement for an electrical permit-to-work to be identified through the application of a general permit-to-work system.

71 You should not allow anyone to work on equipment that is not specified in the electrical permit-to-work as having been made safe. This restriction should be understood and complied with by everyone in the premises, including directors and senior staff.

72 If a programme of work must be changed, the existing electrical permit-to-work should be cancelled and a new one issued before any variation is made to the work. The only person who has the authority to agree the change in programme and issue the new electrical permit-to-work is either the person who issued the original permit or the person nominated by management to take over the responsibility, eg at the end of a shift or during absence on leave.

73 An electrical permit-to-work should be issued by only a designated competent person (see paragraph 3) who has been assessed to be so by means of technical knowledge and/or experience and who is familiar with the system and equipment. The person should be authorised, in writing, by the employer to issue safety documents such as electrical permits-to-work relating to specified equipment or systems. Before issuing the permit, they should work out, in detail and in writing, what the various steps are to disconnect, isolate, prove dead, lock OFF, earth the equipment, post warning notices, and identify the equipment to be worked on and adjacent equipment which will still be live.

74 The electrical permit-to-work should state clearly:

- the person the permit is addressed to, ie the leader of the group or working party, who will be present throughout the work;
- the exact equipment which has been made dead and its precise location;

- the points of isolation;
- where the conductors are earthed;
- where warning notices are posted and special safety locks fitted;
- the nature of the work to be carried out;
- the presence of any other source of hazard, with cross-reference to other relevant permits;
- further precautions to be taken during the course of the work.

75 In most cases it is preferable to include a diagram on, or attached to, the permit confirming the above information and showing the zone for work.

76 It is strongly recommended that the electrical permit-to-work is issued at the place where the work is being done. The designated competent person issuing the permit should explain the work and agree the accuracy and completeness of the details with the person doing the work before they both sign the permit. The person issuing the permit must be sure that all necessary action has been taken to make the equipment safe. As a general rule, a personal inspection should be made but in geographically very large undertakings, such as the electricity supply industry, it may occasionally be necessary to make an exception to this.

77 In cases where there may be divided responsibility, roles must be defined to ensure there is no confusion over respective responsibilities, for instance:

- between a DNO and a dutyholder at the customer's premises, the electrical permit-to-work form should be countersigned by a person nominated in the joint ownership schedule or interface agreement and by the dutyholder for the premises; or
- where contractors may need to work on an occupier's system or equipment.

78 At the time the person in immediate charge of the operation accepts the permit they become responsible for ensuring that all the specified safety precautions are followed that:

- only permitted work is done; and
- the work is confined to the area defined in the permit.

79 If the permit is issued to the leader of a group, the leader accepts responsibility for the people in the group and should explain to them – before the work begins – the scope of work and the means by which safety has been achieved.

80 If the person issuing the electrical permit-to-work will also be doing the work, it is strongly recommended that someone else makes an independent check of the precautions taken. The person doing the work should then issue a permit to themselves. This routine helps to ensure that the full safety procedure is applied.

81 The recipient of an electrical permit-to-work should keep it for reference while the work is in progress and to prevent inadvertent cancellation and re-energisation of the equipment.

82 When the work is complete, whoever the permit was issued to should sign it to declare that any additional earths and tools have been removed and people in the group have been withdrawn and instructed not to approach the equipment again. The person clearing the permit should also indicate whether or not the equipment is fit for service. The permit is then returned, preferably to the designated competent person who originally issued it, for cancellation before the equipment is re-energised.

83 To reduce misunderstandings during suspension of work, it is better to cancel the original permit and issue a new one when required. The suspension of electrical permits-to-work is not generally recommended. Where this is necessary, it is essential to have a written procedure to ensure that tools and additional local earths are withdrawn and everyone is aware that the permit has been suspended.

84 Any electrical permit-to-work system should have a procedure for monitoring (audit) to ensure that the safety rules are followed and the documents are completed accurately. The monitoring should preferably be carried out by someone with managerial responsibilities, who is not involved in the day-to-day issuing of permits, and should be random and ongoing so that bad habits and inaccuracies can be identified and eliminated quickly.

Working live

Figure 5 Live working procedures

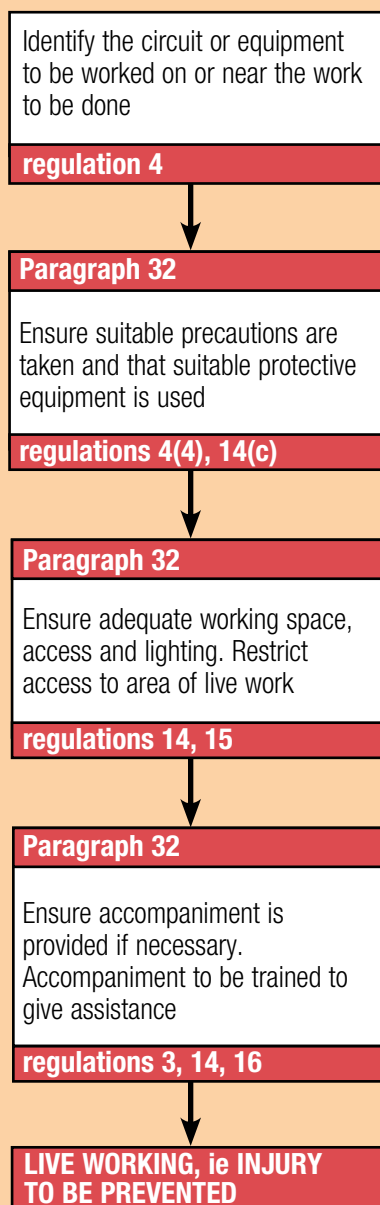

85 The procedures associated with live working are illustrated in Figure 5. While it is not always possible to follow rigidly a set procedure to cover all situations, you should follow the management principles described in this guidance and the safe system of work criteria set out in paragraphs 25–32.

86 The most common live working activity is testing, typically carried out as part of routine preventative maintenance, diagnostic testing, product testing, commissioning, or fault finding. Guidance on safety during electrical testing is available in INDG354 *Safety in electrical testing at work*.²¹

Appendix: Typical example of an electrical permit-to-work

1 Issue

To _____ in charge of this work.

I hereby declare that the following high-voltage apparatus in the area specified is dead, isolated from all live conductors and is connected to earth:

Treat all other apparatus and areas as dangerous

The apparatus is efficiently connected to EARTH at the following points:

The points of isolation are:

CAUTION NOTICES have been posted at the following points:

SAFETY LOCKS have been fitted at the following points:

The following work is to be carried out:

Diagram

Signed _____ Time _____ Date _____

Permit-to-work (front)

2 Receipt

I accept responsibility for carrying out the work on the apparatus detailed on this permit-to-work and no attempt will be made by me or by people under my charge to work on any other apparatus or in any other area.

Signed _____ Time _____ Date _____

Note: After signing the receipt, this permit-to-work should be retained by the person in charge at the place where the work is being carried out until work is complete and the clearance section is signed.

3 Clearance

The work for which this permit-to-work was issued is now suspended*/completed* and all people under my charge have been withdrawn and warned that it is no longer safe to work on the apparatus detailed on this permit-to-work.

All work equipment, tools, test instruments etc have been removed.

Additional earths have been removed.

*Delete words not applicable and where appropriate state:

The work is complete*/incomplete* as follows:

Signed _____ Time _____ Date _____

4 Cancellation

This permit-to-work is cancelled.

Signed _____ Time _____ Date _____

Permit-to-work (back)

References

- 1 *Memorandum of guidance on the Electricity at Work Regulations 1989. Guidance on Regulations* HSR25 HSE Books www.hse.gov.uk/pubns/books/hsr25.htm
- 2 *The use of electricity in mines. Electricity at Work Regulations 1989. Approved Code of Practice* L128 HSE Books www.hse.gov.uk/pubns/books/l128.htm
- 3 PD 6519-2:1988 *Guide to effects of current on human beings and livestock. Special aspects relating to human beings* British Standards Institution (IEC 60479 Part 2), DD IEC/TS 60479-1:2005 *Effects of current on human beings and livestock. General aspects* British Standards Institution
- 4 BS 7671:2008 (+A1:2011) *Requirements for electrical installations. IET Wiring Regulations. Seventeenth edition* British Standards Institution (available from the Institution of Engineering and Technology (IET))
- 5 *Dangerous Substances and Explosive Atmospheres. Dangerous Substances and Explosive Atmospheres Regulations 2002. Approved Code of Practice and guidance* L138 HSE Books www.hse.gov.uk/pubns/books/l138.htm
- 6 *Prevention of fire and explosion and emergency response on offshore installations. Offshore Installations (Prevention of Fire and Explosion, and Emergency Response) Regulations 1995. Approved Code of Practice and guidance* L65 HSE Books www.hse.gov.uk/pubns/books/l65.htm
- 7 *Keeping electrical switchgear safe* HSG230 HSE Books www.hse.gov.uk/pubns/books/hsg230.htm
- 8 *A design guide for the electrical safety of instruments, instrument/control panels and control systems* EEMUA PUB No 178 (Second edition) Engineering Equipment and Materials Users Association 2009
- 9 BS 6423 *Code of practice for maintenance of electrical switchgear and controlgear for voltages up to and including 1 kV* British Standards Institution
- 10 BS 6626:2010 *Maintenance of electrical switchgear and controlgear for voltages above 1 kV and up to and including 36 kV. Code of practice* British Standards Institution
- 11 BS 6867:1987 *Code of practice for maintenance of electrical switchgear for voltages above 36 kV* British Standards Institution (New edition due for publication in 2013)
- 12 *Controlling the risks* www.hse.gov.uk/toolbox/managing/managingtherisks.htm
- 13 *Avoiding danger from overhead power lines* General Guidance Note GS6 (Fourth edition) HSE 2013 www.hse.gov.uk/pubns/gs6.htm

14 *Lighting at work* HSG38 HSE Books 1998
www.hse.gov.uk/pubns/books/hsg38.htm

15 BS EN 60900:2012 *Live working. Hand tools for use up to 1000 V ac and 1500 V dc* British Standards Institution

16 *Electrical test equipment for use by electricians* General Guidance Note GS38
www.hse.gov.uk/pubns/gs38.htm

17 BS EN 61111:2009 *Live working. Electrical insulating matting* British Standards Institution

18 *Personal protective equipment at work (Second edition). Personal Protective Equipment at Work Regulations 1992 (as amended). Guidance on Regulations* L25 HSE Books www.hse.gov.uk/pubns/books/l25.htm

19 *Managing health and safety in construction. Construction (Design and Management) Regulations 2007. Approved Code of Practice* L144 HSE Books www.hse.gov.uk/pubns/books/l144.htm

20 *Guidance on permit-to-work systems: A guide for the petroleum, chemical and allied industries* HSG250 HSE Books www.hse.gov.uk/pubns/books/hsg250.htm

21 *Safety in electrical testing at work* Leaflet INDG354
HSE www.hse.gov.uk/pubns/indg354.htm

Further reading

HSE publications

Safe use of work equipment. Provision and Use of Work Equipment Regulations 1998. Approved Code of Practice and guidance L22 HSE Books
www.hse.gov.uk/pubns/books/l22.htm

Avoiding danger from underground services HSG47 HSE Books www.hse.gov.uk/pubns/books/hsg47.htm

Electrical safety at places of entertainment General Guidance Note GS50 HSE
www.hse.gov.uk/pubns/g50.htm

Maintaining portable and transportable electrical equipment HSG107 HSE Books
www.hse.gov.uk/pubns/books/hsg107.htm

Managing for health and safety
www.hse.gov.uk/managing

Further information

For information about health and safety, or to report inconsistencies or inaccuracies in this guidance, visit www.hse.gov.uk/. You can view HSE guidance online and order priced publications from the website. HSE priced publications are also available from bookshops.

British Standards can be obtained in PDF or hard copy formats from BSI:
<http://shop.bsigroup.com> or by contacting BSI Customer Services for hard copies only
Tel: 020 8996 9001 email: cservices@bsigroup.com.

Engineering Equipment and Materials Users' Association (EEMUA)
63 Mark Lane, London EC3R 7NQ
Tel: 020 7488 0801 Fax: 020 7488 3499

The Institution of Engineering and Technology
Michael Faraday House, Stevenage, Herts SG1 2AY
Tel: 01438 313 311 Fax: 01438 765 526

This guidance is available at: www.hse.gov.uk/pubns/books/hsg85.htm.

© *Crown copyright* If you wish to reuse this information
visit www.hse.gov.uk/copyright.htm for details. First published 08/13.

APPENDIX E

HSE Publication Do you know how to Work Safely with PCBs?

Do you know how to work safely with PCBs?

PCBs and YOU

Contents

- [What are PCBs?](#)
- [Where will I find PCBs?](#)
- [How can they enter my body?](#)
- [How can they affect my health?](#)
- [What precautions should I take?](#)
- [How do I dispose of PCBs?](#)
- [Are there any relevant laws?](#)
- [Where can I get more information?](#)
- [PCB trade names](#)

Department of the Environment

Do you dismantle or replace old electrical equipment, including switchgear, transformers and capacitors?

This equipment may contain chemicals called PCBs which can harm your health.

Do you know how to work safely with PCBs?

Is your health at risk?

Make sure you know what to do before you start work.

This leaflet provides an introduction to these questions. Further, more detailed information is contained in the booklet How to handle PCBs without harming yourself or the environment. You should consult this before carrying out regular or substantial work. Alternatively, specialist contractors can carry out the work.

Polychlorinated biphenyls (PCBs) can harm the environment and could damage your health. Because of environmental concerns, an international agreement in 1986 banned most uses. Agreement has been reached to phase out remaining uses by 2000.

What are PCBs?

PCBs are a family of substances which are good electrical insulators. They are chemically stable, fire resistant and don't easily generate a vapour. You may find them in mixtures referred to as askarels

or under a trade name. Examples of trade names of products which have contained PCBs are at the end of this leaflet.

Where will I find PCBs?

PCBs were used as dielectric filler liquids in some types of electrical equipment such as transformers, switchgear, capacitors and in the starter units of fluorescent lights and fractional horsepower motors. Some equipment is labelled as containing PCBs but if you come across old equipment with no identifying label you should check with:

- your employer; or
- the manufacturer or owner of the equipment.

You should assume that any capacitor or transformer manufactured before 1976 may contain PCBs unless you have information to the contrary. It is also possible that there may be PCBs present in capacitors and transformers manufactured between 1976-1986. Even if the PCBs have been replaced by another liquid, significant amounts of PCBs may still be present. PCBs may occur as contaminants in the oil used in oil-filled electrical equipment. Always check with your employer if you are in any doubt.

How can they enter my body?

PCBs can enter your body in three ways:

- by direct contact with the skin. PCBs pass easily through intact skin, so this is likely to be the main way they get into your body;
- by breathing in fumes, spray or droplets if PCB-containing equipment is being cut or heated;
- by swallowing PCBs if you eat, drink or smoke in the workplace.

How can they affect my health?

If you are repeatedly exposed to PCBs they can gradually build up in your body. PCBs can cause a skin condition called chloracne, which produces pustules, blackheads and cysts. In animals PCBs can cause damage to the liver, reduce the ability to fight infection, as well as other effects. Apart from chloracne, none of the range of effects seen in animals has been seen in people working with PCBs, although it is possible that they could occur if high exposures were to occur.

What precautions should I take?

All PCB-containing equipment needs to be checked regularly for signs of PCB leakage. If substantial leakage occurs you should obtain the assistance of a specialist contractor immediately.

You should not do any work where there is a possibility that you may come into contact with PCBs, including dealing with spilt PCBs, unless your employer has trained you and given you a method to follow.

Because PCBs can pass easily through your skin, you should wear personal protective equipment if there is any possibility of contact with PCBs. All cuts and abrasions need to be covered with dressings before you put on your protective clothing. Your employer will tell you the right type of protective clothing for your job, which may include:

- an impervious boilersuit or overalls;
- suitable gloves;
- overshoes or wellingtons;
- chemical resistant goggles or visor;
- respirator.

However, no material is completely impervious to PCBs. The booklet *How to handle PCBs without harming yourself or the environment* gives details of those materials which give the best protection.

In some instances capacitors in fluorescent light fittings may leak and need replacing. Here only very small quantities of fluid are involved and it may not be necessary to obtain the assistance of a specialist contractor. To do this you need to wear disposable gloves, wipe down any spillage with paper or cloth wipes, and wash your hands when you have finished the job.

If your protective clothing becomes contaminated with PCBs, do not take it home to wash it, or send it to a laundry. See 'How do I dispose of PCBs?' below.

Where PCBs may be present, do not eat, drink or smoke and wash thoroughly before eating, drinking, smoking or using toilet facilities. These measures are important to ensure that you do not come into contact with PCBs.

How do I dispose of PCBs?

PCBs, PCB waste (including protective clothing that has been contaminated with PCBs) and equipment containing PCBs must only be disposed of by specialist waste contracting firms which are licensed by the Waste Regulation Authority. You must not dispose of PCBs or PCB waste by pouring it into drains, onto land or by burning. PCBs are normally destroyed in an incinerator authorised to burn PCBs, although there are other ways of destroying PCBs. You can get advice on how to dispose of very small amounts of PCBs (such as a few capacitors from fluorescent lights) from your Waste Regulation Authority. The National Association of Waste Disposal Contractors (NAWDC) can provide a list of their members licensed to dispose of PCBs.

Are there any relevant laws?

Yes, there are several laws which apply to PCBs:

The Health and Safety at Work etc Act 1974 requires employers to ensure so far as is reasonably practicable the health, safety and welfare of all their employees at work. You are required to co-operate with your employer, for example by using safety equipment and working methods as instructed.

The Control of Substances Hazardous to Health Regulations 1994 (COSHH) place duties on your employer to:

- ensure that your exposure to PCBs is either prevented, or if this is not reasonably practicable, adequately controlled;
- assess the risks to your health from PCBs and identify the measures which are needed to protect your health;
- ensure that control measures are adequate and that you use them;
- monitor your exposure;
- provide you with information on the risks of PCBs and the steps which are necessary to protect your health.

You also have duties under COSHH to:

- co-operate with your employer;
- use protective measures and to report any defects.

The Environmental Protection Act 1990 requires, amongst other things, waste holders to exercise a duty of care when disposing of certain materials. For further details see 'Where can I get more information?'

Where can I get more information?

Your local HSE office will provide more advice and information on work involving PCBs. It is listed under Health and Safety Executive in the local telephone directory. If you are worried that you may have absorbed PCBs through working with them, you can obtain confidential advice from the Employment Medical Advisory Service, who can be contacted through your local HSE office. The booklet *How to handle PCBs without harming yourself or the environment* (ISBN 0 7176 0789 5) can be obtained from HSE Books.

For information on the handling and disposal of PCBs see Waste Management Paper No 6 - Polychlorinated biphenyls (DoE 1994, available from HMSO) or contact your local Waste Regulation Authority (listed in your local telephone directory) or the Department of the Environment Enquiry Unit, 2 Marsham Street, London SW1P 3EB (Tel 0171 276 3000).

The National Association of Waste Disposal Contractors (NAWDC) will be able to give you a list of contractors who can handle PCBs and PCB waste. Their address is Mountbarrow House, 6-20 Elizabeth Street, London, SW1W 9RB.

HSE priced and free publications are available by mail order from: HSE Books, TSO Customer Services, PO Box 29, Norwich, NR3 1GN, Tel: +44 (0)333 202 5070

PCB trade names

Mixtures of substances containing PCBs are often referred to by trade names. The following have been reported as containing PCBs at some time (but should no longer contain PCBs in current products):

- ACECLOR
- INERTEEN
- APIROLIO
- KANECHLOR
- AROCLOR
- KENNECHLOR
- ASBESTOL
- LEROMOLL
- ASKAREL
- NO-FLAMOL
- AUXOL
- OLEX-SF-D
- CHLOREXTOL
- OROPHENE
- CLOPHEN
- CLOPHENHARZ
- PRODELEC 3010
- CLORESIL
- PYDRAUL
- DIACLOR
- PYRALENE
- DELOR
- PYRANOL
- DELORENE
- PYROCLOR
- DK
- SAF-T-KUHL
- DYKANOL
- SANTOSOL
- ELAOL
- SANTOTHERM

- ELECTROPHENYL
- SOVOL
- ELEMEX
- SOVTOL
- FENCLOR
- TERPHENYCHLORE
- FENOCLORO
- THERMINOL
- GILOTHERM
- TURBINOL
- HYVOL

This list does not contain the names of all PCB mixtures.

HSE priced and free publications are available by mail order from HSE Books, TSO Customer Services, PO Box 29, Norwich, NR3 1GN, Tel: +44 (0)333 202 5070 Website: <https://books.hse.gov.uk/> (HSE priced publications are also available from bookshops and free leaflets can be downloaded from HSE's website: www.hse.gov.uk.)

Further advice can be obtained from HSE offices (see under Health and Safety Executive in the telephone directory). For other enquiries write to HSE's Information Centre, Broad Lane, Sheffield S3 7HQ.

This document contains notes on good practice which are not compulsory but which you may find helpful in considering what you need to do.

This document is available at www.hse.gov.uk/pubns/msa19.htm.

© Crown copyright This publication may be freely reproduced, except for advertising, endorsement or commercial purposes. First published 03/95. Please acknowledge the source as HSE.

Published by the Health and Safety Executive

MS(A)19 3/95 C50

Added to the web Site 8/7/98

APPENDIX F

ENA NEDeRS Ref. SOP 2013/0383/06



ENGINEERING DIRECTORATE
NEDeRS® MEMBER COMPANIES CONFIDENTIAL

URGENT

From: Bernard Pentecost **ENA Ref:** SOP 2013/0383/06 (Update)
Tel: 020 7706 5100 (Please inform switchboard that your enquiry relates to NEDeRS)
Email: bernard.pentecost@energynetworks.org **Date Issued:** 05 Feb 2016

SUSPENSION OF OPERATIONAL PRACTICE (SOP)

(See Engineering Recommendation G28/4 for notes of guidance on use)

1. REASON FOR DECIDING TO CHANGE OPERATIONAL PRACTICE

Following a disruptive failure of a Long & Crawford GF3T Fuse Switch an Restriction of Operation Practice has been implemented.

2. DESCRIPTION OF EQUIPMENT INVOLVED

Manufacturer:	Long & Crawford		
Equipment:	Switch - GF3 - Long & Crawford		
Serial Number:	9706787		
System Voltage:	11 kV	Year Manufactured:	1997
Rating:	200A	Date Commissioned:	01/06/1998
No. of Units Affected:	11899	Date Last Maintained:	04/01/2013
Total No. of Units:	11899		
Sp. Category Affected:			

3. RELATED INCIDENT DETAILS

Date:	04/01/2013 11:49
Indoor/Outdoor:	Indoor
Op. Environment:	No exceptional environmental factors
Area of Failure:	Main Tank/Chamber
Cause(s):	Maintenance or Operator Induced
Other Plant Affected:	Local Transformer, J4 Oil Switch and another GF3.
Hyperlinks: ¹	DIN 2013/0003/06

SOP 2013/0383/06

4. DETAILS OF SUSPENDED OPERATIONAL PRACTICES

This restriction affects all LONG AND CRAWFORD/GEC/ALSTOM 11/6.6kV OIL INSULATED FUSE SWITCH UNITS (GF3; GF3B; GF3D; GF3F; GF3M; GF3T; T4GF3; T3GF3 etc.)

All live operation (including fuse inspection) of the fuse switch with any part of the unit live is banned. The switchgear shall be re-energised remotely and no persons shall be present in the substation when it is being re-energised.

Precautions shall be taken to prohibit access to the substation for a period of 30 minutes following re-energisation.

This restriction does not apply to the operation of oil switches (including those on a ring main unit). This restriction shall be reviewed following the conclusion of the investigation.

*** Update 15/04/13 - Following the failure investigation the SOP has been revised as per below. An update shall be completed following the further investigations***

Any operation of the fuse switch is banned when any part of the unit or switchboard is live. Where there has been operation of the fuse switch due to a fault or 3rd party operation then the switchgear shall be made dead from remote substations.

Immediately prior to energisation of the switchgear, all automatic means of re-energisation (such as Auto Reclose) of the restricted equipment shall be inhibited on the 11/6.6kV feeder involved, and only restored 30 minutes after the re-energisation.

The switchgear shall be re-energised from a remote substation and no persons shall be present in the substation during re-energisation. A 7m exclusion zone shall be maintained around the switchgear, by a competent person, during re-energisation unless there is a physical barrier such as a GRP enclosure or brick building.

Precautions shall be taken to prohibit access to the exclusion zone for a period of 30 minutes following re-energisation.

This restriction does not apply to the operation of oil switches and earth switches (including those on a ring main unit) where operation of a fuse switch is not involved.

This restriction shall be reviewed following further investigations.

Update 26/07/13

Investigations internally and with the manufacturer and third parties are ongoing. A full update will be issued by the end of August 2013.

Update 05/09/13.

Investigations internally and with the manufacturer and third parties are still ongoing, and a local remote operation method is being tested for live operation. A full update will be issued when available.

Update 15/01/14.

Investigations internally and by third parties are ongoing, and a remote operation method which places the operator at a distance greater than 7 metres from the unit (Exclusion zone modified to be 7m), has been introduced for situations where live operation is essential, whilst the investigations continue. A full update will be issued when available.

Update 17/04/14.

Investigations internally and with third parties are still ongoing. The remote operation method and restriction is still in force. A full update will be issued when available.

Update 05/02/16.

Investigations have been completed. This SOP will remain in place on all affected units until the new full invasive maintenance is completed and the SOP removed on each unit in turn.

Proposed Review Date:

Supersedes (previous SOP):

Dated:

5. ADDITIONAL COMMENTS

1. Previously known as 'Associated Reports'. On the NEDeRS web site (<http://www.ena-eng.org/neders>), the user can browse associated incidents by linking directly between them.

*The information contained in this Report has been prepared by one or more members of the Energy Networks Association National Equipment Defect Reporting Scheme (“**Scheme Members**”) and distributed by the Energy Networks Association (“**ENA**”) solely for the benefit of Scheme Members. No warranties, guarantees or assurances are given by the ENA in respect of any information in this Report. The information in this Report does not have regard for the particular circumstances of any party that may obtain a copy of it. Accordingly, the ENA, its Scheme Members, its partners, employees and agents accept no responsibility or liability to any third party which acts or fails to act in reliance on this Report and/or any of its contents and any such acts or failures to act are entirely at that party’s own risk.*

APPENDIX G

Electricity Northwest Operational Instruction 206 Issue 6

OPERATIONAL INSTRUCTION 206

ISSUE 6

LONG AND CRAWFORD/GEC/ALSTOM 11/6.6kV OIL INSULATED FUSE SWITCH UNITS

(GF3; GF3B; GF3D; GF3F; GF3M; GF3T; T4GF3; T3GF3 etc.)

A disruptive failure of a GF3 Fuse Switch unit has occurred shortly after re-energisation following maintenance. The cause of this incident has now been investigated by EA Technology and the failure has been identified to be on one of the moving contacts on the fuse carrier assembly.

RESTRICTION OF OPERATIONS

Any manual operation of the Fuse Switch is banned when any part of the unit is Live.

It is permitted to operate the Earth Switch with the Ring Switches, cable boxes or incoming busbars within the unit Live.

Prior to opening the Fuse Switch the unit **Shall** be made dead from separate local switches e.g. extensible switchgear or remote substations.

Where there has been operation of the Fuse Switch due to a fault or 3rd party operation then the unit **Shall** be made dead from separate local switches e.g. extensible switchgear or remote substations.

Fuse replacement or access to the fuse carriage for any reason **Shall** be done with the unit made dead from separate local switches e.g. extensible switchgear or remote substations.

This restriction does not apply to the operation of Oil Switches (including those on a Ring Main Unit).

*Prior to closing and following energisation the following **Shall** be observed:-*

- All automatic means of re-energisation of the restricted equipment (ARS, TDAR, DAR and AR where practicable) **Shall** be inhibited on the 11/6.6kV feeder involved, and not restored within 30 minutes of the re-energisation.
- No persons **Shall** be present in the substation during re-energisation.
- A 7m exclusion zone **Shall** be maintained around the switchgear, by a Competent Person, during re-energisation unless there is a physical barrier such as a GRP enclosure or brick building.

- Precautions **Shall** be taken to prohibit access to the exclusion zone for a period of 30 minutes following re-energisation.

On-site operations of the Fuse Switch may be completed by using the approved lanyard remote operating system, providing all of the above observations are complied with and subject to the following:-

- There has been no fault operation of the Fuse Switch
- The fuse carrier has not been raised prior to re-energisation

Note: It is necessary to remain on-site outside the 7m exclusion zone for a minimum of 30 minutes prior to removal of the lanyard equipment.

This restriction **Shall** be removed following completion of Plant Modification 709 or complete refurbishment by Long Controls which will incorporate the requirements of Plant Modification 709. If the unit has been refurbished a new Switchgear Makers Plate will be affixed stating the Refurbished on Site Date and Long Control Logo.

References:-

Long and Crawford T3GF3 and T4GF3 Open and Close Version 1 - Lanyard Remote Operating Instructions dated 25/10/13.

Long and Crawford GF3 and GF3D Open and Close Version 1 - Lanyard Remote Operating Instructions dated 25/10/13.

Date of Issue 1	4 th January 2013
Date of Issue 2	11 th April 2013
Date of Issue 3	12 th November 2013
Date of Issue 4	12 th January 2015
Date of Issue 5	12 th March 2015
Date of Issue 6	19 th September 2016