

DONE
design and print

THE DISPLAY FOLIO[®]
Exhibit & Display Catalog

Visual Merchandising
Visual Communication
Visual Presentation

THE DISPLAY FOLIO[®]

Exhibit & Display Catalog

In the demanding environments where display products are relied on day after day, customers increasingly recognize the importance of quality and of having a partner who can support their evolving needs.

Whether you need one stock item or five thousand custom frames, we are committed to being your source for quality and value in visual merchandising.

We continue to invest to improve the quality of the products and services we deliver to you, our customers. It takes a team effort from our employees, whose priority is ensuring that your projects are successful. Our approach has always been to listen carefully to our customers, and to deliver products that meet your evolving display needs. We service a wide range of industries.

We are proud of our extraordinary reputation for quality, value and reliability. We source the finest quality components, and because we manufacture in the U.S., our supply chain is shorter, "greener", and we can offer customizable solutions tailored to your needs. We are excited about our future and look forward to continuing our pursuit of opportunities together!

VISUAL

Communication Merchandising Presentation Displays



Visual Opportunities Everywhere

Customer Base

Retailers and Brands, their Visual Merchandise and Store Planning departments, associated Digital Printers, Marketing, Logistics and Installation companies.

Large format Digital Printers who realize that the more competitive display options they can offer to their client base, especially customizable ones, the more printing they will sell.

The Trade show Exposition Industry, the Event Industry, Promotional companies, Ad Specialty companies, Sign Distributors and Retailers, P.O.P. companies, the Store Fixture Industry.

eCommerce and other resellers across many industries and businesses that are able to resell our products and earn good margins doing so.

O.E.M. companies that buy assemblies and complete products. They rely on our fabrication, quality, and reliability. Our ability to customize and quickly get it to market cost effectively is key.

Value Driven

Functionality, durability and clean design are guiding principles, yet no criteria is more important than providing value. Value is engineered into every product.

Value is achieved because we have over a hundred years of experience, a large inventory of existing tooling, and are extremely vertically integrated. Virtually all our products are made in house.

We are especially proud of our American workforce and feel we can out work, out design and out produce our foreign competitors to deliver value across all our lines.

Catalog = Idea Book

Because the products in this catalog are almost all manufactured in house, we gladly customize designs to meet your unique needs (quantity required).

Whether a custom color, a custom size, or a totally new product that uses similar materials as an existing product, we are ready to offer options for quantity opportunities.

Product innovation is customer driven by experienced design, project manager, and art teams that work closely with you, the best customers in the world.

WE WANT TO HEAR FROM YOU!

Please explore this catalog to see how innovative visual merchandising, communication and presentation displays can be used in your environment successfully.

Imagine the possibilities...

Customer Driven Product Innovation

Tradition of Service & Reliability

A tradition spanning over 100 years and four generations, family owned and operated.

End to end service including quick quotations, speedy prototyping, quick roll outs, drop shipping, kitting, labeling, tracking spreadsheets, and more.

Innovative, solutions driven, a sense of urgency, decades of existing tooling and know how, a superior quality level, with value across the board.



Fully Integrated

Great design, engineering, art and customer service teams with a can do attitude yielding the very best creative and effective solutions.

Products are made with tools and dies to ensure conformity and quality. Limited Lifetime Warranty except light boxes which is one year.

Dye Sublimated printing. Lots of fabric choices and mounting methods with an in house graphics department to support and guide.

As an American manufacturer you can count on excellent service, spare parts availability and support when needed.

CUSTOM IS OUR SPECIALTY

From Customer Pencil Sketch To Successful Roll-out

your concept.

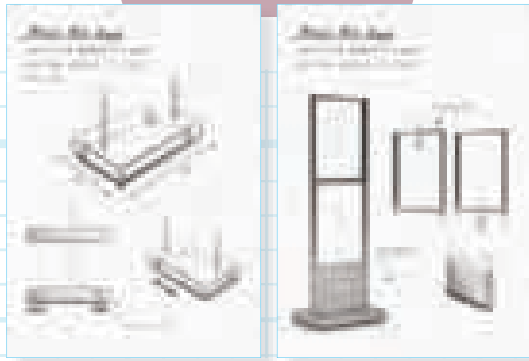

our engineering & execution.



Quick Quoting

Metals

- **Aluminum** – A lightweight metal, non-magnetic. Anodizes and powder coats well.
- **Steel** – Three times the weight and strength of aluminum but a third the cost making their relative utility a “push” value wise. Powder coats very well.

Finishing

- **Powder coating** – An electrostatic process whereby plastic polymers get fused to the metal with excellent coverage and adhesion. Any color is available including textures & glimmers. Good on aluminum and steel.
- **Anodizing** – Appropriate for aluminum, not steel. Virtually all our aluminum tubing is stocked in house in an etched and clear satin anodized finish.



Packing

- **Boxes** and inserts are manufactured in-house because of the importance of getting the product to market intact.



Packaging design and box making done in-house!!

SEG/LED Light Boxes

Charisma SEG™



Charisma Single Sided Light Boxes (4- 3/4" DEEP)

Model	Graphic Size
XBX34	36" x 48"
XBX46	48" x 72"
XBX48	48" x 96"
XBX58	60" x 96"
XBX69	72" x 108"
XBX810	96" x 120"

* Specify: Model – Location

Charisma Slim Single Sided Light Boxes (3-1/8" DEEP)

Model	Graphic Size
XSL34	36" x 48"
XSL46	48" x 72"
XSL48	48" x 96"
XSL58	60" x 96"
XSL69	72" x 108"
XSL810	96" x 120"

* Specify: Model – Location

* Must Use To Order:

- WM Wall Mount | -CP Ceiling, Vertical | -CL Ceiling, Horizontal
- FP Floor, Vertical | -FL Floor, Horizontal

Charisma Single Sided SEG/LED Light Boxes™

- Mounting - Wall & Ceiling Options
- Finish - Satin silver aluminum
- Lights - Each light strip has LEDs with wide beam angles, for light efficiency and low heat. By default, lights are on both largest sides (4 sides lit is available upon request)
- Lights are 6500°K color temperature
- Power cord - Single power cord directly from the lightbox ~90°
- All frame over 93" are in multiple sections, unless otherwise specified.

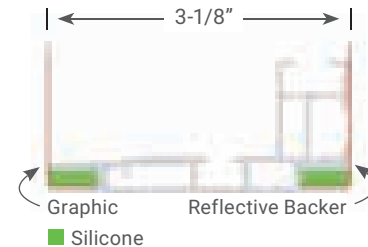
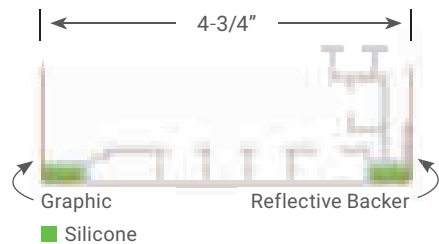

Mounting Options

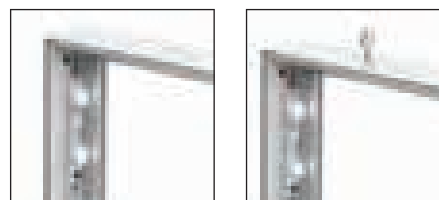

Wall Mount

Ceiling Mount

Floor Mount

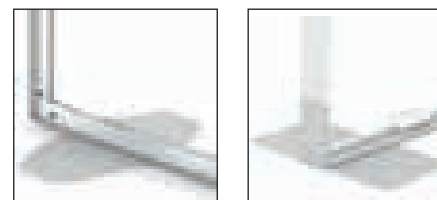

Marquise Base

Optional Megabase

Custom Colors

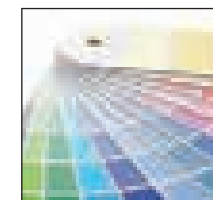

RAL Colors Available

Finish



-S Satin Silver

Custom Sizes and Finishes Available

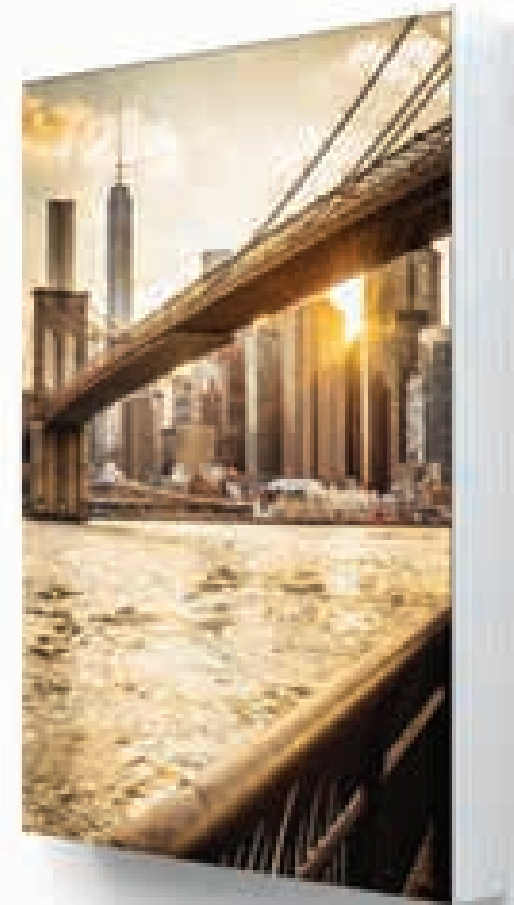

CERTIFIED the standard in safety

Double Sided Light Box

Charisma SEG™

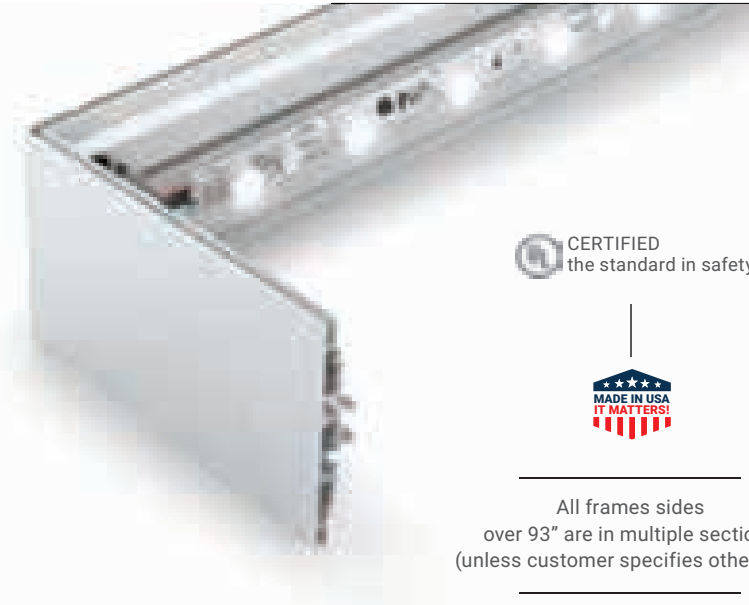

 **CERTIFIED**
the standard in safety



All frames sides
over 93" are in multiple sections
(unless customer specifies otherwise)

Charisma Double Sided Light Boxes™

Model	Graphic Size
XSD34	36" x 48"
XSD46	48" x 72"
XSD48	48" x 96"
XSD58	60" x 96"
XSD69	72" x 108"
XSD810	96" x 120"

* Specify: Model – Location

* Must Use To Order

- CP Ceiling, Vertical
- CL Ceiling, Horizontal

Floor Mount with Marquise Bases

- FP Floor, Vertical
- FL Floor, Horizontal

Floor Mount

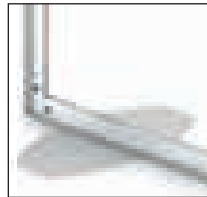

Marquise Base

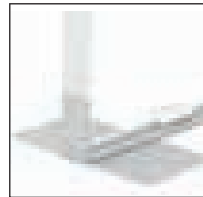

Optional Megabase

Hanging Mount

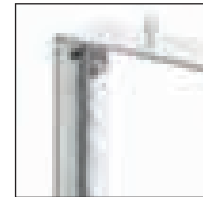

Ceiling Mount

Charisma Double Sided Light Boxes™

Free-Standing or Hanging

- 4-3/4" deep, SEG channel on front and back for graphics
- Finish - Satin silver aluminum
- Lights - Each light strip has LEDs with wide beam angles, for light efficiency and low heat. By default, lights are on both largest sides

- Lights are 6500°K color temperature
- Power cord - Single power cord directly from the lightbox ~90"
- Unit is UL Certified with individually numbered stickers on each segment
- Ships unassembled in corrugated box with custom end caps

Silicone Roll



XSSL330 327' SEG Roll

Finish



-S Satin Silver

Custom Sizes and
Finishes Available

Profile Cross Section

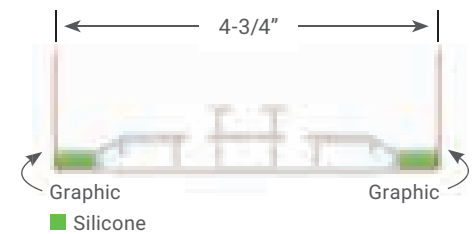

Single Sided Frame

Charisma SEG™



← 1-1/4" →

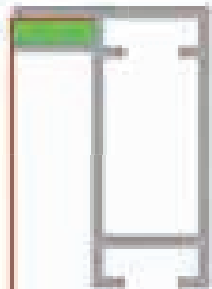

■ Silicone
■ Graphic

Charisma Single Sided SEG™

- Graphic changes are fast and easy
- Frameless, no visible seam lines
- Wall hangers provided
- Sturdy aluminum construction
- Handsome satin silver finish
- Frames over 93" are in multiple sections, unless specified otherwise

Mounting Options

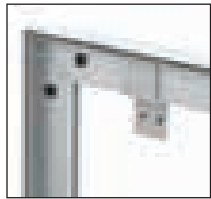

Standard Wall Mount brackets provided

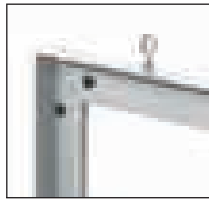

Eye-hooks used on Ceiling Mount models



Flat steel bases in attractive shape

Model	Graphic Size
XSM23A	24" x 36"
XSM34A	36" x 48"
XSM45A	48" x 60"
XSM46A	48" x 72"
XSM48A	48" x 96"
XSM56A	60" x 72"
XSM68A	72" x 96"
XSM610A	72" x 120"
XSM88A	96" x 96"
XSM810A	96" x 120"

* Specify: Model – Location

* Must Use To Order

- WM Wall Mount
- CP Ceiling, Vertical
- CL Ceiling, Horizontal

Floor Mount with Marquise Bases

- FP Floor, Vertical
- FL Floor, Horizontal

Accessories

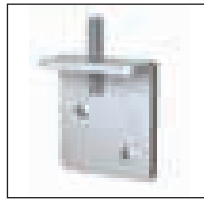

XSDCB reduces frame distortion due to tight graphics



XSSL330 327' Roll Silicone Roll

Custom Colors



Any RAL Available

Finish



-S Satin Silver

Custom Sizes and Finishes Available





Mattress headboards are a perfect use, so we offer standard headboard sizes. **XAIR6060-F-S**

Cost Effective - Lightweight - Strong

Floor - Rectangular steel bases **Ceiling** - Steel eye bolts **Wall** - Mounting Brackets

Specify: XAIR Width – Height – Mounting – Orientation (ceiling only)

Width	Height	Mounting	Eyebolt Location (ceiling only)	Finish
39"	48"	-F Floor	-C Canopy Hanging (back)	-S Silver
54"	60"	-C Ceiling Hung	-T Top	Custom requests encouraged including colors
60"	72"	-W Wall Mount		
72"				
76"				

Results in a frameless graphic with no visible sew lines.
Graphic changes are fast and easy.

Charisma Air™

Charisma SEG™

Charisma Air™

- Lightweight aluminum, sharp price point
- Double sided SEG 2" deep
- Satin Silver finish
- Excellent stability & strength
- Tool-free assembly
- Ideal for retail rollouts

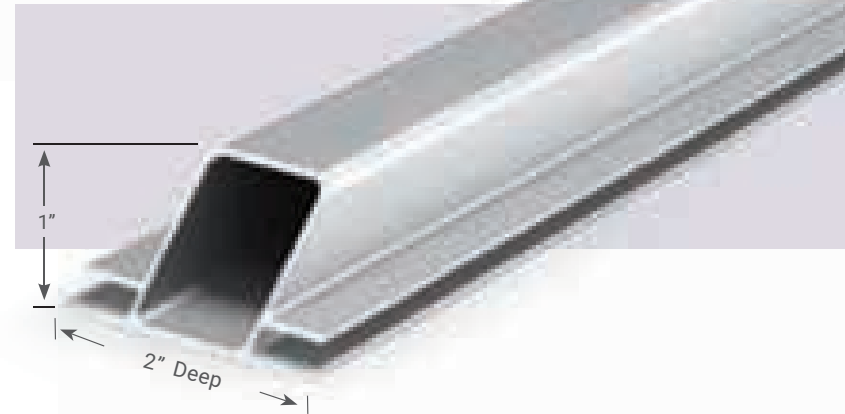

Graphic changes are fast and easy



Great for:
Furniture
Retail
Hospitality

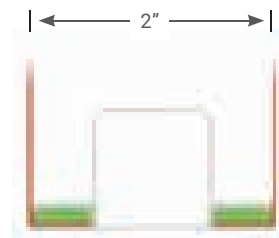

■ Silicone ■ Graphic
Use single or double sided.

Double Sided Frame

Charisma SEG™

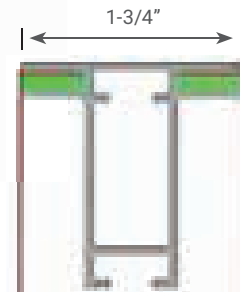

■ Silicone
■ Graphic

All frames sides over 93" are in multiple sections (unless customer specifies otherwise)

Charisma Double Sided SEG™ Hanging or Free-Standing

- Graphic changes are fast and easy
- Frameless graphics with no visible sew lines
- Fabric graphics provide luxurious look and feel
- Provides not just graphics, but great ambiance
- Handsome Satin Silver finish
- Double sided, graphic front and back

Model	Graphic Size
XSM35B	36" x 60"
XSM36B	36" x 72"
XSM45B	48" x 60"
XSM46B	48" x 72"
XSM48B	48" x 96"
XSM68B	72" x 96"
XSM610B	72" x 120"
XSM88B	96" x 96"
XSM810B	96" x 120"
XSM1010B	120" x 120"

* Specify: Model – Location

- * Must Use To Order
- CP Ceiling, Vertical
- CL Ceiling, Horizontal

Floor Mount with Marquise Bases

- FP Floor, Vertical
- FL Floor, Horizontal



Floor Mount

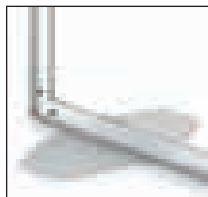

Marquise Base

Hanging Mount and Connectors

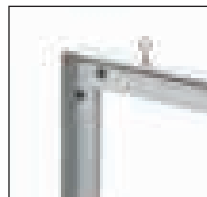

Ceiling Mount



Linking Connectors

Silicone Roll



XSSL330 327' SEG Roll

Custom Colors

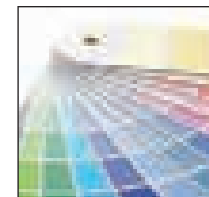

RAL Colors Available

Finish



-S Satin Silver

Custom Sizes and Finishes Available

Charisma SEG™

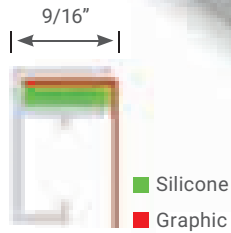

Charisma Mini SEG™ - Almost Invisible

- Ultra slim profile for wall mounting
- Smaller frame size, very effective
- Graphic changes are fast and easy
- Frameless graphics with no visible sew lines
- Wall hangers provided
- Fabric graphics provide luxurious look and feel

Charisma Mini frames come disassembled, packed in a corrugated tube to minimize shipping costs. Assembly on site is fast and easy.

Finish 
-S Satin Silver
 Custom Sizes and Finishes Available

Model	Graphic Size
XMIN4	14" x 22"
XMIN5	18" x 24"
XMIN6	22" x 28"
XMIN7	24" x 36"
XMIN8	30" x 40"
XMIN9	36" x 48"

Wall Mount



Easy Assembly

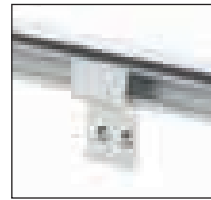

Wall Mounts Included

Charisma SEG™



Charisma SEG Picture Frame™

- Traditional style frames available in satin silver, matte black or custom colors
- Graphic changes are fast and easy
- Frameless graphics with no visible sew lines
- Wall mounts vertically or horizontally, hangers provided
- Beautiful mitered corners
- Fabric graphics provide luxurious look and feel
- Great for retail, hotel or restaurant use

Specify: Model – Location – Finish **-S** Satin Silver or **-B** Matte Black  

Model	Graphic Size
XSP4	14" x 22"
XSP5	18" x 24"
XSP6	22" x 28"
XSP7	24" x 36"
XSP8	30" x 40"
XSP9	36" x 48"

Wall Mount



Wall Mounts Included

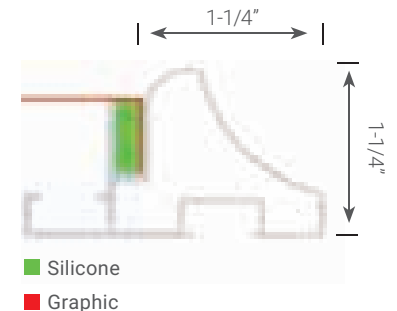

Charisma SEG™



Channels accept SEG graphics
Precision miters
Beautiful oval uprights

Handsome satin silver pucks

Charisma Double Sided SEG Frames

- All aluminum alloy construction
- 1-3/4" Double sided SEG frame
- Precision miters with support plates
- 6' uprights provide stability
- Attractive oval uprights and bases

Change height without removing graphics!



Frames can be set near, 12" or 24" from floor



XSS56-H-S

Great for:
Using as Space Dividers

Charisma SEG Elevated Stands™ Non-Lit

- Graphic changes are fast and easy
- Frameless graphics with no visible sew lines
- Racetrack oval uprights & marquise shaped bases
- Fabric graphics provide luxurious look and feel
- Frames can be set near, 12" or 24" from floor
- Units ship KD for significant freight savings
- Super sharp price points

Model	Graphic Size
XSS56	60" x 72"
XSS57	60" x 84"
XSS66	72" x 72"

* Specify: Model – Orientation
-H Horizontal -V Vertical

Finish
-S Satin Silver
Custom Sizes and Finishes Available



Light Box Elevated Stands™

Charisma SEG™



XLD56-H-S

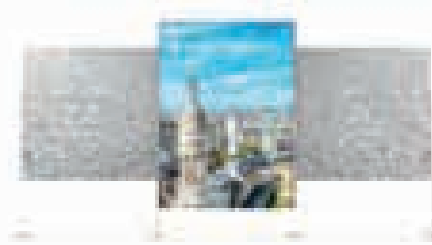

Frames can be set near, 12" or 24" from floor

LED Light Strips
UL Certified



 CERTIFIED
the standard in safety

Charisma Double Sided SEG Light Box

- 4-3/4" deep Charisma SEG/LED Light Box
- LEDs feature long life and wide beam angles
- 6500°K color temperature, UL Certified
- Units ship KD for significant freight savings
- Graphic changes are fast and easy
- Frameless graphics with no visible sew lines
- Racetrack oval uprights & marquee shaped bases

Model	Graphic Size
XLD56	60" x 72"
XLD57	60" x 84"
XLD66	72" x 72"

* Specify: Model – Orientation
-H Horizontal -V Vertical

Finish



-S Satin Silver

Custom Sizes and
Finishes Available



Units ship knocked down,
easy assembly, freight savings.

Incline Stands™

Charisma SEG™



INCSEG1-2260-S
One-sided SEG Frame

Charisma SEG Incline Stands™

- Aluminum built to exacting standards
- Ships flat, 60 second set up, portable
- Available, single and double sided
- Lightweight and strong, but very effective
- Standard graphic size is 22" x 60"



Pivot to fold flat.



Drop-In and Snap Frame Models also available pages 50-51.

Specify: Single or Double Sided — Color

Model	Frame Size W" x H"	Frame Style
INCSEG1-2260	(1) 22" x 60"	One-sided SEG Stand
INCSEG2-2260	(2) 22" x 60"	Two-sided SEG Stand

-S Satin Silver or -B Matte Black 

Relaxed, laid back, designed to put the customer at ease.



INCSEG2-2260-B
Two-sided SEG Frame

Great for malls



XSR48-S
Roll-Around Base

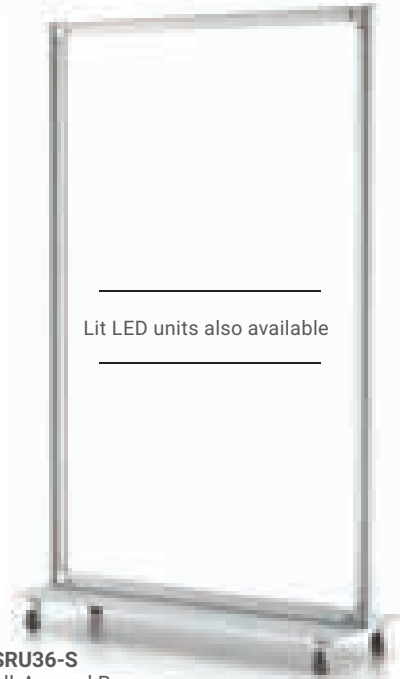

XSRU36-S
Roll-Around Base

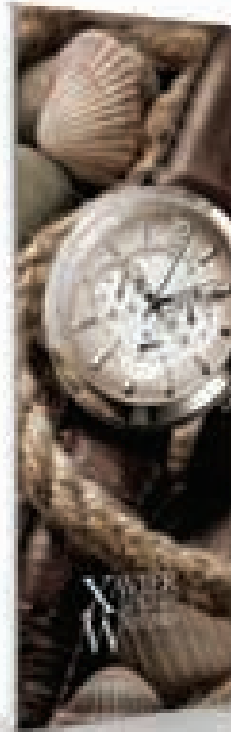

XSQU36-S
Mini Marquee Bases

Epic Stands

- Frameless – no visible sew lines
- Good for high traffic areas
- Lit LED models also available
- Sides over 93" ship in two sections
- Fabric graphics provide luxurious look
- Three standard steel base choices
- Graphic changes are fast and easy
- Handsome satin and matte finishes

Epic Stands™ Charisma SEG™



XSEU48-S Elliptical Base

A nice way to provide ambiance
and information in retail settings.

Color **-S** Satin Silver or **-B** Matte Black



Mini Marquee W/O Uprights With Uprights	Elliptical W/O Uprights With Uprights	Roll-Around W/O Uprights With Uprights	Graphic Size
XSQ36 XSQU36	XSE36 XSEU36	XSR36 XSRU36	36" x 72"
XSQ38 XSQU38	XSE38 XSEU38	XSR38 XSRU38	36" x 96"
XSQ46 XSQU46	XSE46 XSEU46	XSR46 XSRU46	48" x 72"
XSQ48 XSQU48	XSE48 XSEU48	XSR48 XSRU48	48" x 96"

Trifecta Stand™

Charisma SEG™



XP3N1
with (1)
graphic

Show One, Two or Three Graphics Per Side

- Double sided Charisma SEG
- Aluminum alloy frame
- Weighted 22" x 18" steel base

Silicone Edge Graphics

... tremendous display versatility!

Show one, two or three graphics per side

Replace one message,
leave the rest!

XP3N1
with (2)
graphics

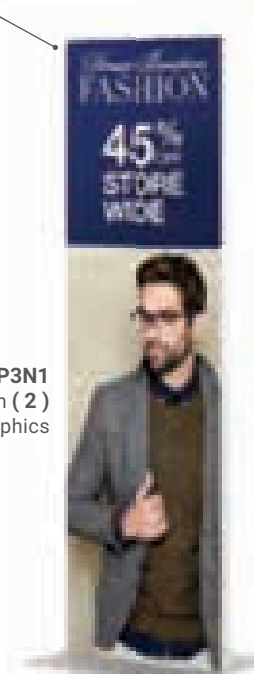

XP3N1
with (2)
graphics

XP3N1
with (3)
graphics



Model	Height	Weight
XP3N1	72"	30 lbs

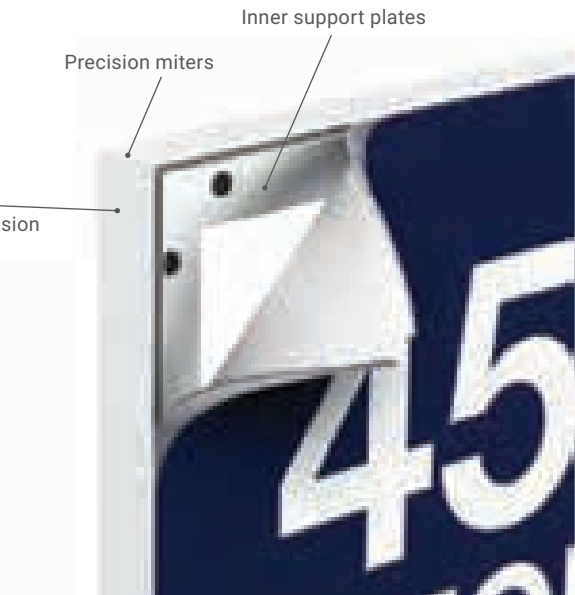

All Metal Construction Built to Last!

← 1-3/4" →

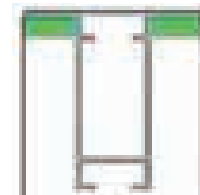

- Silicone
- Graphic

Finish 

-S Satin Silver

Custom Sizes
Available in Quantity

Silicone Edge Graphics Stands

Lit LED units also available



XPS72

Charisma SEG Double Sided Expo Stands

- Easy SEG Insertion
- Aluminum construction
- Double sided viewing
- Ultra easy assembly
- Bases: Full width (XPS) / Round base (XPLF)



XPS28



XPS36

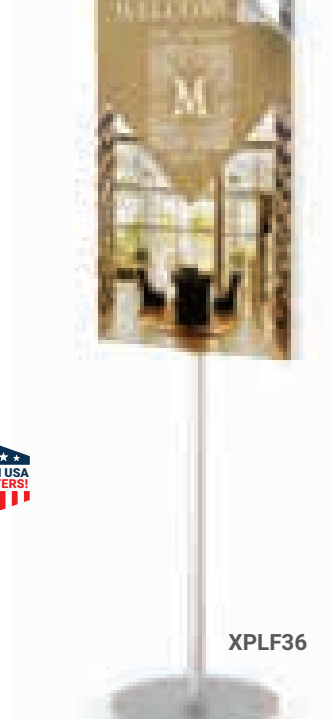

XPLF36



XPLF28

Model	Graphics	Graphics Size	Base	Uprights	Ht.	Wt. lbs
XPS28	2	22" x 28"	24" x 12"	2	64"	21
XPS36	2	24" x 36"	24" x 12"	2	72"	22
XPS72	2	24" x 72"	24" x 12"	N/A	72"	22
XPLF28	2	22" x 28"	17" Round	1	64"	19
XPLF36	2	24" x 36"	17" Round"	1	72"	20

Finish 

-S Satin Silver

Custom Colors
are Available



← 2" →

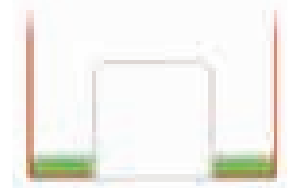

■ Silicone ■ Graphic

Use single or double sided.

SEG/LED Inside Out Light Boxes™

Charisma SEG™



Graphics Light Up, Inside and Out!

Silicone Edge Graphics
Usable in different configurations
L's, U's and Straight Walls

 CERTIFIED
the standard in safety

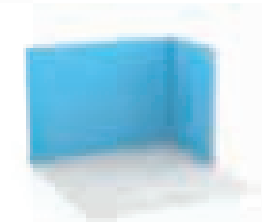

Wall Corners



As an Overhead

Experiential Retail Surround

Illuminated Inside and Out!

- LED light strips along top and bottom rails
- LEDs feature wide beam angles, and long life
- Lights are 6500°K color temp, low heat
- Aluminum trim is satin silver
- Easy SEG graphics installation and change out
- Power supply cords exit the top of the lightbox

Charisma SEG/LED Inside Out Light Boxes™

- Dramatic effects
- Lighting – both inside and out
- Heavy construction with forged bolts
- Easy SEG installation
- Custom sizes available
- Satin silver finish

Model	W x D x H
XSI084	8' x 4' x 2-1/2'
XSI0812	8' x 12' x 2-1/2'
XSI01010	10' x 10' x 2-1/2'

Allow additional lead time
for these units



Great for:
Retail Stores
Showrooms
Lobbies
Exhibitors

Suggested Use:

- Hanging
- Corners
- Freestanding
- Partitions



Charisma SEG™



Silicone Edge Graphics
Are Today's Best Choice



Easy to attach
and change out graphics

Charisma Hexahedron (Six Sided) or Triangular Towers – Non Lit

- Floor or Hanging (Special Order)
- Unique profile and corner
- Easy SEG graphic change outs
- Satin Silver Finish
- Custom sizes available
- Ships flat for cost effective shipping

Torpedo LED Exhibit Light

- Plug and play
- ETL Listed
- Customizable
- 6500K color temp.
- 6' high units have two lights
- Lights can daisy-chain

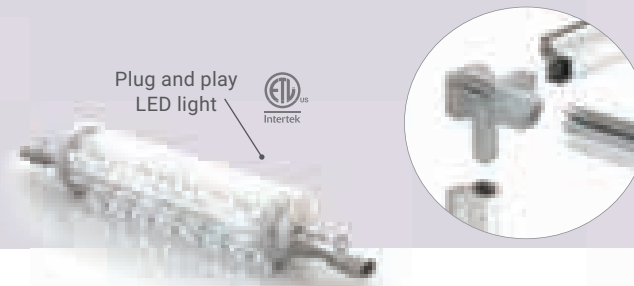

Charisma Square Cubes		
Non-Lit	Lit	W x D x H
XS2C	XS2CLEd	2' x 2' x 2'
XS3C	XS3CLEd	3' x 3' x 3'
XS4C	XS4CLEd	4' x 4' x 4'

Charisma Rectangular Towers		
Non-Lit	Lit	W x D x H
XS2T	XS2TLEd	2' x 2' x 6'
XS3T	XS3TLEd	3' x 3' x 6'
XS4T	XS4TLEd	4' x 4' x 6'

Charisma Triangular Towers		
Non-Lit	Lit	W x D x H
XS2G	XS2GLEd	2' x 2' x 6'
XS3G	XS3GLEd	3' x 3' x 6'
XS4G	XS4GLEd	4' x 4' x 6'

Custom Sizes
Available



XS3G

Charisma SEG™

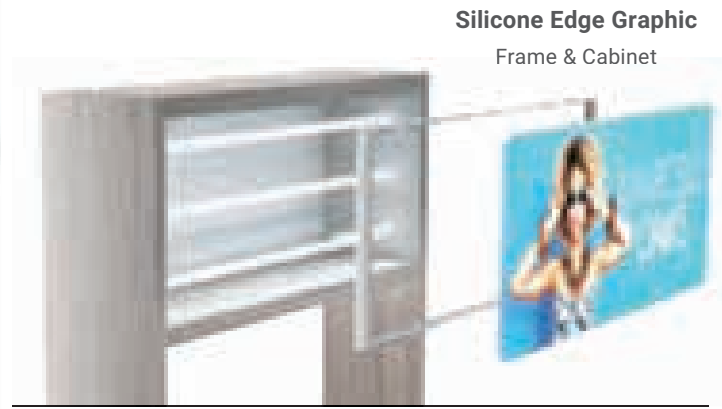
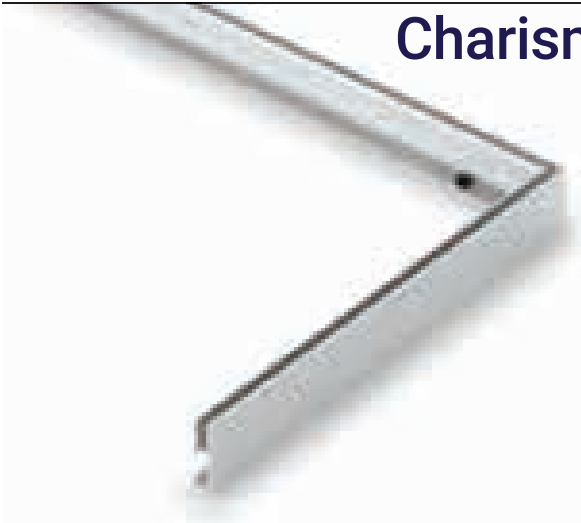

Silicone Edge Graphic
Frame & Cabinet

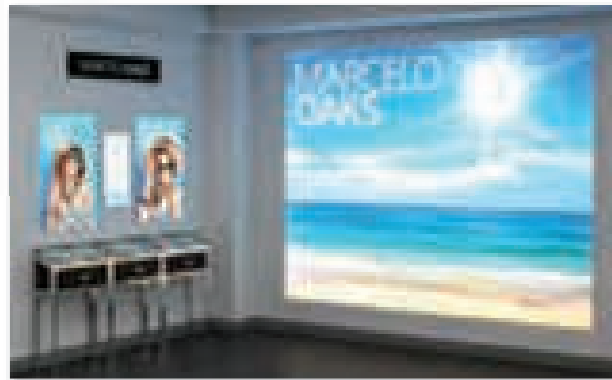

Can work in unlit & lit recesses

Retrofit recessed spaces and light boxes
with SEG Cabinet fabric frames

■ Silicone
■ Graphic

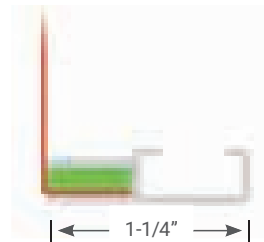

Charisma SEG Cabinet Frames™

- Convert cabinets and recessed wall areas into SEG signage
- Convert Duratrans light boxes into SEG fabric frames
- Compact SEG extrusion 1-1/4" x 3/8", extremely economical

Model	Graphic Size	Finish
XCAB1824	18" x 24"	-S Satin Silver
XCAB2228	22" x 28"	
XCAB2436	24" x 36"	
XCAB3648	36" x 48"	

LightWire SEG

Electrified Hanging Cables™

- No Visible Power Cord
- Super "Clean" secure suspension
- UL Certified Low Voltage System
- Transformer is Mounted in the Ceiling
- Available on a project basis



Electrified Hanging Cable



SEG Circles

SEG tension fabrics for textured upscale look

- Aluminum profile formed in house
- Extremely fast and easy assembly
- Made on a custom basis to specs
- Hang from wall, suspend from ceiling or hang flat in Canopy orientation
- Adds texture and ambiance to any setting
- Minimum 40" diameter



Hang on a wall or suspend from a ceiling vertically or use in a canopy orientation facing down



SEG Sell & Tell Stands

- Charisma and Build-a-Stand Podiums available. On a custom basis qty 25+, graphic available.
- Tool free construction available



Charisma SEG Podium



Build-a-Stand Podium

EasyOpen™ SnapFrames



ME7-S-RE-C

Aluminum EasyOpen SnapFrames™

- Simply pull up each leaf to snap open, place graphic under the lens, and snap close.
- Front load convenience without any hassle.
- Handsome finishes complement most any décor.
- All aluminum construction, built to last.
- Wall hanging hardware is included.

Divider bar option

Aluminum Bar attaches with pressure sensitive adhesive. **Specify Side**



EasyOpen SnapFrames™

- Aluminum frames, 1-1/4" wide, 9/16" deep
- Accepts posters and paper signs to 1/32" thick
- Vertical & horizontal mounting holes
- Styrene backing
- Clear or matte overlay lens
- Wall screws and anchors

↓
For Media
up to 1/32"
↑



3/8" margin covered by frame.



Change Graphics Effortlessly!

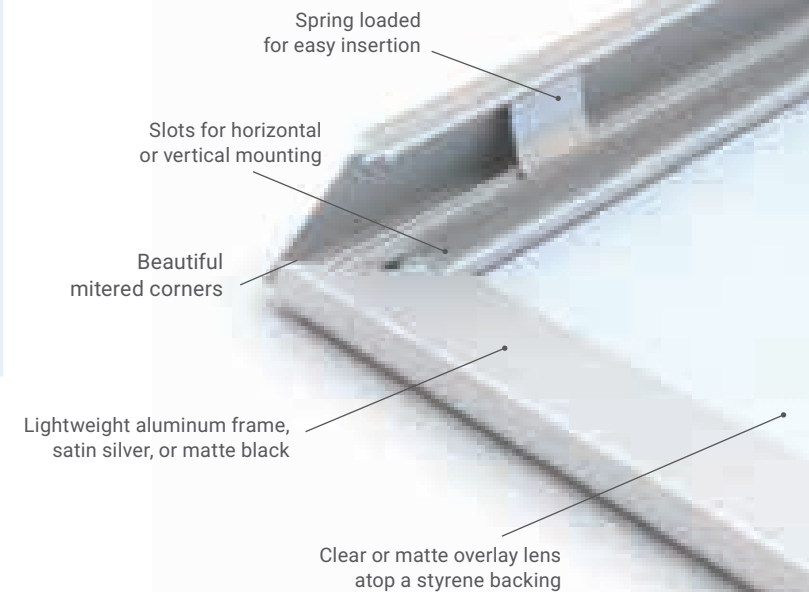

EasyOpen™ SnapFrames

Aluminum Standard Options

Rectilinear - a modern aesthetic



Both are
1-1/4" wide x 9/16" high

Curvilinear - classic original shape



Custom Options

Custom requests are encouraged.
Our customer service and
inside sales teams are ready to help.

- Any Size or Custom Color
- Wood Grain Vinyl Wrap
- Slatwall Brackets
- Brackets to mount to Madix or Lozier Standards
- Ceiling Mounts
- Countertop and Floor Stands
- Stand Offs
- Dividers for the live area
- Special Packouts



ME7-S-CV-C

Specify: Model – Color – Profile* – Lens* *Does not affect price

Model	Graphic Size	Model	Graphic Size	Color	Profile*
ME1	8" x 10"	ME6	20" x 24"	-S Satin Silver	-CV Curvilinear
ME2	8-1/2" x 11"	ME7	22" x 28"	-B Matte Black	-RE Rectilinear
ME3	11" x 14"	ME8	24" x 30"	Silver costs less than black	
ME3.5	11" x 17"	ME9	24" x 36"		
ME4	14" x 22"	ME10	30" x 40"		Lens*
ME5	16" x 20"	ME11	36" x 48"		-C Clear
					-M Matte



↓
For Media
up to 1/32"
↑

SupraSlim™ SnapFrames

Front Loading Convenience



Change Graphics Effortlessly

↓
For Media
up to 1/32"
↑

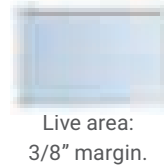

Choice of matte or clear lens included

Strong spring loaded

Styrene backing

**Ships Fully
Assembled**

SupraSlim SnapFrames™

- Aluminum rails, 3/4" wide, 1/2" deep
- Accepts substrates up to 1/32" thick
- Matte or clear lens included
- Styrene backing included
- Mounts vertically or horizontally
- Wall mount hardware provided

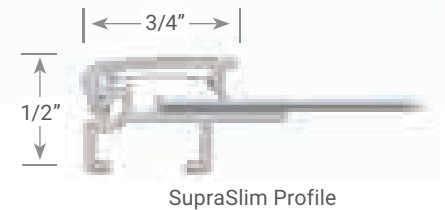
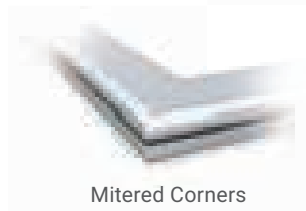

SupraSlim™ SnapFrames



Super slim profile focuses attention on the message.



Only
3/4" wide
1/2" deep

Great for Architectural Applications



Mount vertically or horizontally,
wall mount hardware included.



Matte Finishes

Specify: Model – Color – Lens*

Model	Size	Model	Size	Color	Lens*
SUP01	8" x 10"	SUP05	16" x 20"	-S Satin Silver	-C Clear
SUP02	8-1/2" x 11"	SUP06	20" x 24"	-B Matte Black	-M Matte
SUP03	11" x 14"	SUP07	22" x 28"		
SUP3.5	11" x 17"	SUP08	24" x 30"		
SUP04	14" x 22"	SUP09	24" x 36"		

Silver costs less than black

*Does not affect price

SupraSlim LED Light Boxes™

SnapFrames



Great for:
Retail stores
Showrooms
Lobbies
Exhibitors

Use for:



Backlit films
up to 1/32" thick



Attention Grabbers!



Front loading convenience

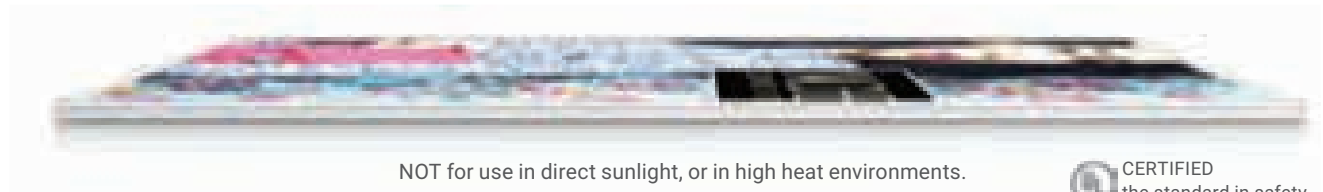

NOT for use in direct sunlight, or in high heat environments.

 CERTIFIED
the standard in safety

SupraSlim LED SnapFrame Light Boxes™

- Modern, clean design
- Front loading snap frame
- Accepts Duratrans graphics
- Aluminum alloy construction
- Precision miters
- Only 3/4" wide and deep
- Satin, matte finishes
- Clear lens included
- Mount vertically or horizontally
- Wall mount hardware included



SupraSlim Profile



Mitered Corners

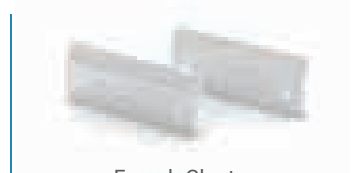

French Cleats
for hanging included

SupraSlim LED Light Boxes™

SnapFrames

Perfect for Retail Environments!

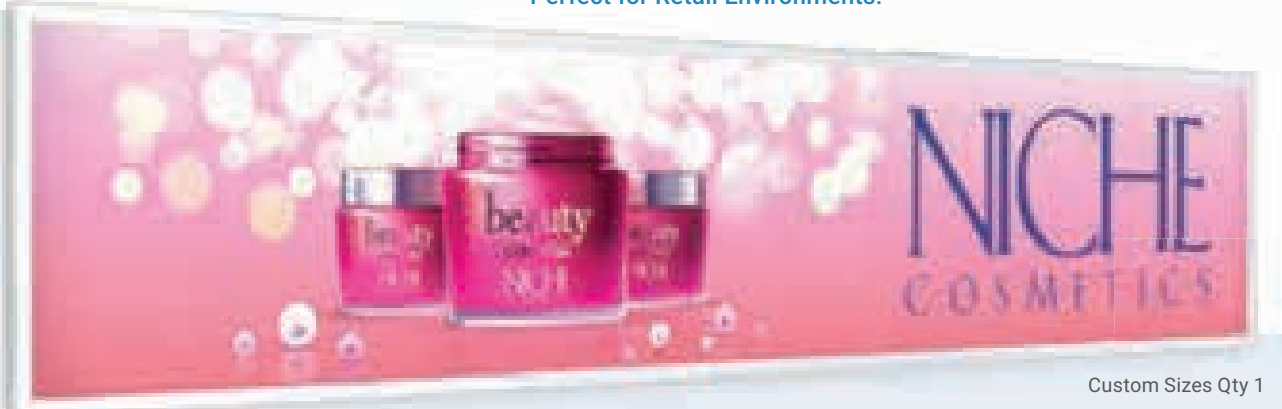

Custom Sizes Qty 1

Amazing Brightness!

About the Technology

- Perimeter lit LED acrylic panel
- Reflective back panel
- Fantastic light dispersion
- Low voltage, energy efficient
- 6500° K color temperature
- Long LED life
- 24V external power source
- UL safety certification

Use for:
 ↓
 Backlit films
 up to 1/32" thick
 ↑

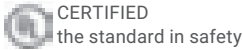

NOT for use in direct sunlight, or in high heat environments.

Specify: Model – Orientation* – Color*

Model	Size	Orientation*	Color*
SUL1824	18" x 24"	-H Horizontal	-S Satin Silver
SUL2228	22" x 28"	-V Vertical	-B Matte Black
SUL2436	24" x 36"		

*Does not affect price



Image area:
3/8" Frame Margin

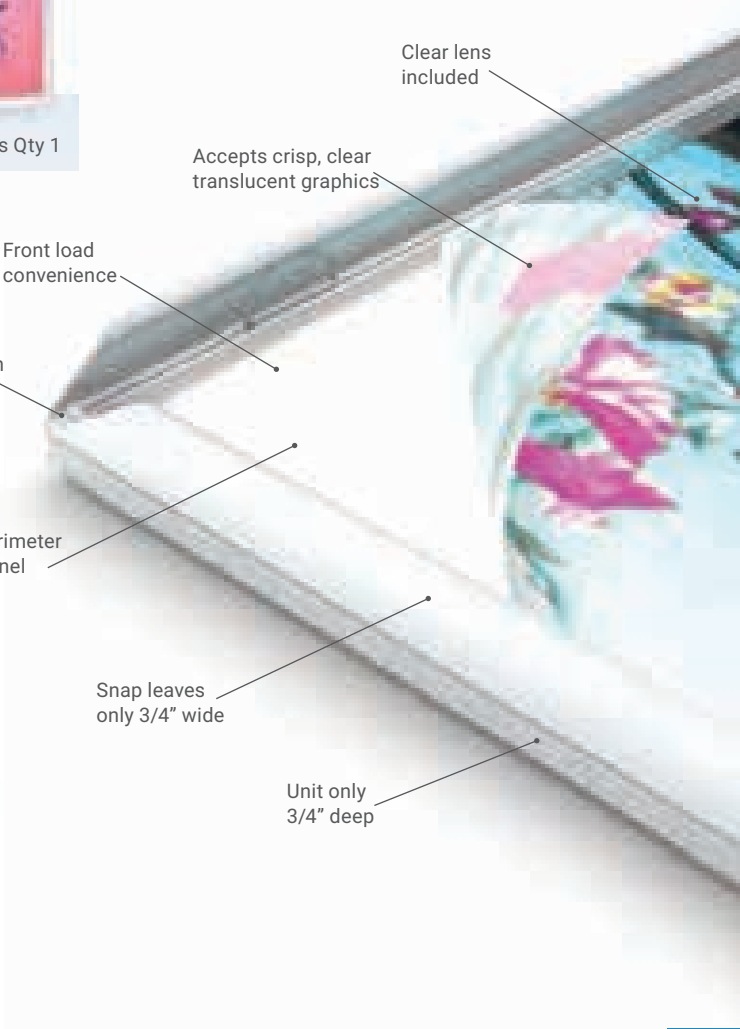

Clear lens included

Accepts crisp, clear translucent graphics

Front load convenience

Precision miters

LED lit perimeter acrylic panel

Snap leaves only 3/4" wide

Unit only 3/4" deep

EasyOpen™ SnapFrames



ETD2-B

Featuring heavy 14" x 12" steel bases, racetrack oval 37" aluminum uprights, horizontal orientation.



ETD1-S

↓
For Media
up to 1/32"
↑

EasyOpen Pedestal SnapFrame Stands™

- Easy-Open™ SnapFrames
- **All metal construction**
- Styrene backs
- Matte lens included. Special order clear lens
- Accepts graphics up to 1/32" thick
- Sturdy, quick graphic/signage change-outs



ET2H-S



Image area:
3/8" Frame Margin

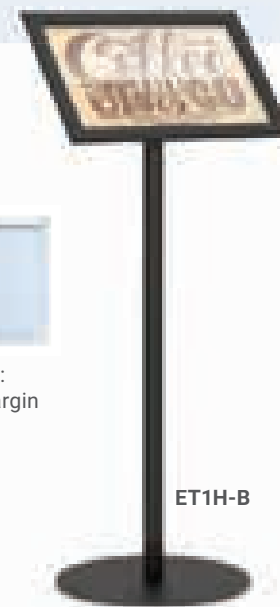

ET1H-B

Featuring Aluminum front open SnapFrames, laser cut round 3/16" steel bases and 36" high upright aluminum poles.



ET3V-S



Specify: Model – Color* -S Satin Silver or -B Matte Black



Model	Graphic Size
ETD1	17" x 11"
ETD2	22" x 14"

Special order clear lens.



SPECIFY: Model – Orientation* – Color* -S Satin Silver or -B Matte Black



Model	Graphic Size	Pole	Base	Orientation*
ET0	8.5" x 11"	36" Straight	11" Round	-H Horizontal
ET3	11" x 14"	36" Straight	11" Round	-V Vertical
ET1	11" x 17"	36" Straight	15" Round	
ET2	14" x 22"	36" Straight	15" Round	

*Does not affect price

EasyOpen SnapFrame Stands™

- Aluminum 1-1/4" wide SnapFrames
- Accepts graphics up to 1/32" thick
- EasyOpen convenience. 66" total height
- Matte overlay lens, floor levelers

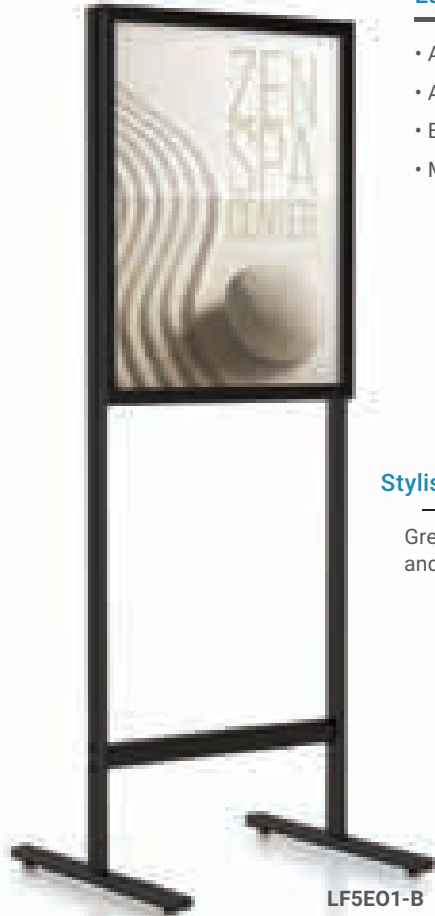

LF5E01-B

Stylish & Elegant!

Great for Retail
and Hospitality
Settings

Specify: Model – Color*

Model	Graphic Size	Style
LF5E01	22" x 28"	One-Sided
LF6E01	24" x 36"	One-Sided
LF5E02	22" x 28"	Two-Sided
LF6E02	24" x 36"	Two-Sided

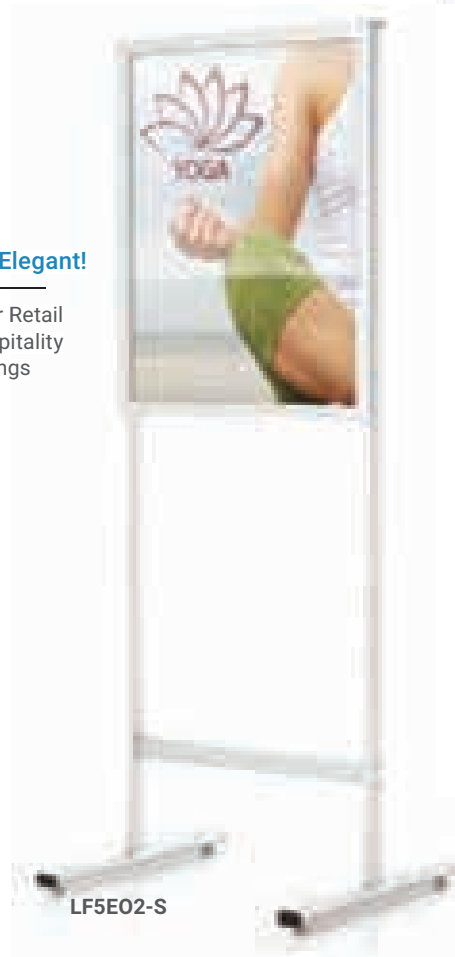

LF5E02-S

↓
For Media
up to 1/32"
↑



EF4E0H-B
with Literature Basket

EF1E0H-S

Angled EasyOpen SnapFrame Pedestal Stands™

- Easy-Open™ SnapFrames
- All metal construction
- Styrene backs
- Matte lens included

Specify: Model – Orientation* – Color*

Model	Graphic Size	Orientation*
EF1E0	8.5" x 11"	-H Horizontal
EF3E0	11" x 14"	-V Vertical
EF4E0	11" x 17"	Special order clear lens.

*Color: -S Satin Silver or -B Matte Black

*Does not affect price

Plasti™ SnapFrames



PE9-S

Extremely Cost Effective!

Plasti Front Loading SnapFrames™

- PVC frame, 1-1/8" wide, 5/8" deep
- Accepts posters to 1/32" thick
- Vertical & horizontal mounting holes
- Expanded PVC backer
- One piece "living hinge" construction
- Wall screws and anchors included

Specify: Model - Color* - Lens type if applicable*

No Lens	With Lens	Graphic Size
PE1	PE1L	8" x 10"
PE2	PE2L	8-1/2" x 11"
PE3	PE3L	11" x 14"
PE3.5	PE3.5L	11" x 17"
PE4	PE4L	14" x 22"
PE5	PE5L	16" x 20"
PE6	PE6L	20" x 24"
PE7	PE7L	22" x 28"
PE8	PE8L	24" x 30"
PE9	PE9L	24" x 36"
PE10	PE10L	30" x 40"
PE11	PE11L	36" x 48"

Color*	
-S	Satin Silver
-B	Matte Black

Lens*	
-C	Clear
-M	Matte

*Does not affect price



3/8" margin is covered by frame.

Change Graphics Effortlessly!

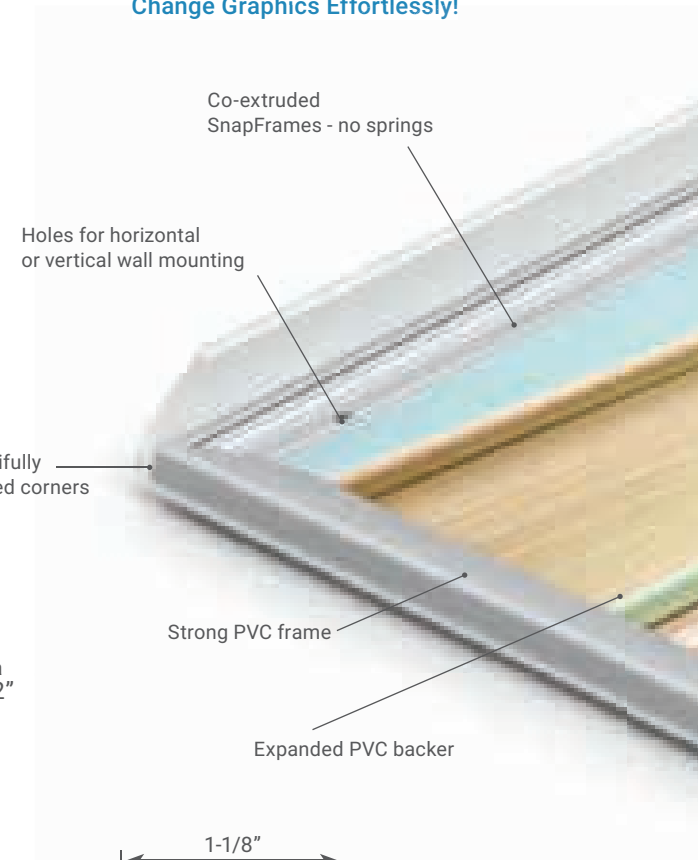

↓
For Media
up to 1/32"
↑

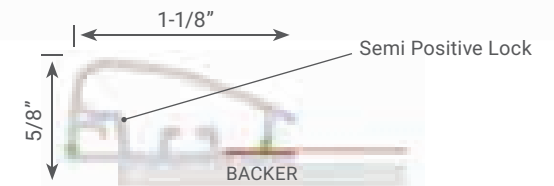

NOT recommended for use in direct sunlight.

SnapFrames



Double Sided

- Features fast easy graphic Change outs, 3/8" margins
- Frames ship completely assembled back to back

Color

- Satin Silver and Matte Black are the standard stock finishes
- Any RAL color can be matched economically in quantity

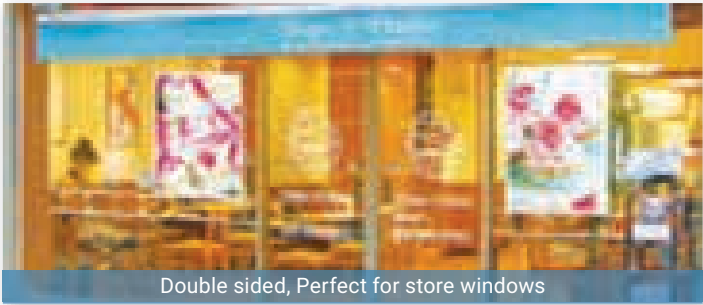

Double sided, Perfect for store windows

Custom Options

Custom requests are encouraged. Our customer service and inside sales teams are ready to take your order.

- Any size or color
- Custom Wood Grain Vinyl Wrap
- Slatwall Brackets mount to Madix or Lozier Standards
- Ceiling Mounts
- Countertop & Floor Stands
- Stand Offs
- Dividers for the live area
- Special Packouts



SupraSlim LED Light Boxes

- Accepts backlit films
- Reflective back panel
- Low voltage, energy efficient
- UL safety certification

EasyOpen Curvilinear SnapFrame™

- Frame: Snap, 1-1/4" W x 9/16" D
- Material: Aluminum Satin Finished
- Features: Curvilinear, lens
- Media: Accepts up to 1/32" thick

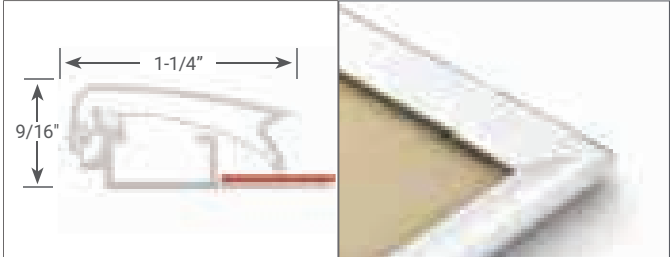

EasyOpen Rectilinear SnapFrame™

- Frame: Snap, 1-1/4" W x 9/16" D
- Material: Aluminum satin finished
- Features: Modern shape, lens
- Media: Accepts up to 1/32" thick

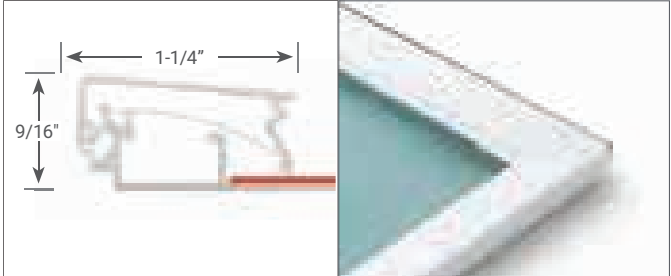

SupraSlim SnapFrame™

- Frame: Snap, 3/4" W x 1/2" D
- Material: Aluminum
- Features: Minimal aesthetic, lens
- Media: Accepts up to 1/32" thick

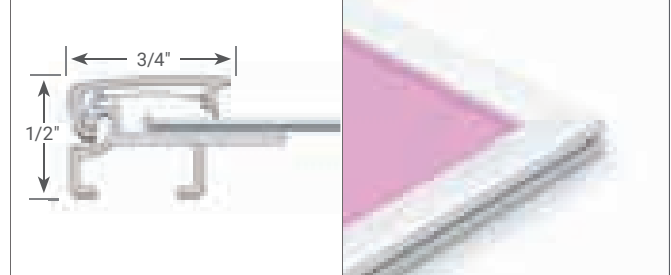

Plasti SnapFrame™

- Frame: Snap, 1-1/4" W x 11/16" D
- Material: PVC, economical
- Features: 3MM PVC backer, lens
- Media: Accepts up to 1/32" thick



Perfex Drop-In SignFrames™

Hanging Frames



↓
For Media
up to 3/16"
↑



Side loading.
Accepts 3/16" graphic and
(2) CPL 1/32" lenses (see next pg.)

Perfex SignFrame Variations

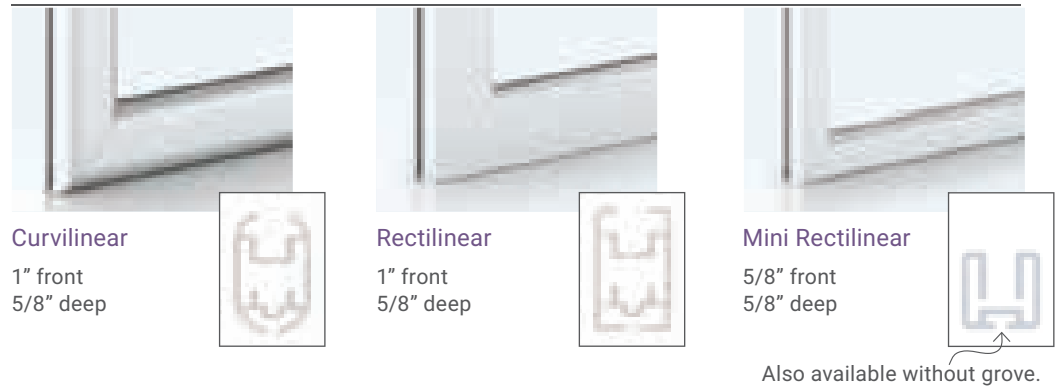

Frames include:

- 2 universal hanging clips
- 2 top and bottom wall hangers
- Additional hanging options available

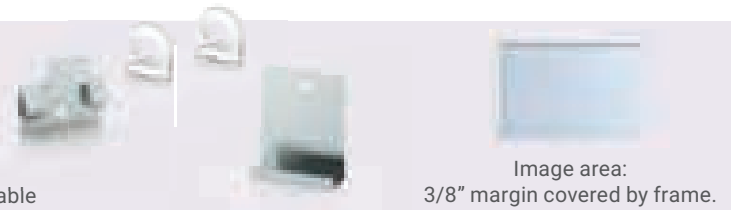

Units ship fully assembled and individually packed.

Specify: Model – Style – Orientation* – Color* -**S** Satin Silver or -**B** Matte Black



Model	Graphic Size	Style	Orientation*
PX1	8-1/2" x 11"	- CV Curvilinear	- H Horizontal
PX2	11" x 14"	- RE Rectilinear	- V Vertical
PX3	11" x 17"	- MI Mini Rectilinear	
PX4	14" x 22"		
PX5	22" x 28"		
PX6	24" x 36"		

*Doesn't affect price,
but must use to order.

On large roll-outs, bulk packing
can save significantly. Price on request.

Perfex Mini SignFrames™ Hanging Frames



Two Custom **PX-MI-V-S** Side by Side

Perfex Mini SignFrames™

- Functional, clean design
- Only 5/8" wide, and 5/8" deep
- Aluminum alloy, satin matte finishes
- Extremely strong and rigid, built to last!
- Drop in side loading, standard
- Universal hanging clips and wall brackets included

Units ship fully assembled
and individually packed.

↓
For Media
up to 3/16"
↑



PX5-MI-V-S

Accessories:

Lots of Ceiling Anchors, Links, Cables, Hooks, Ceiling Tracks and Dividers pgs. 112-113

Coroplast® Backs

White, 4 mm corrugated plastic boards make excellent frame backs. Sold individually.

Model	Size	Model	Size
COR3	8-1/2" x 11"	COR6	14" x 22"
COR4	11" x 14"	COR7	22" x 28"
COR5	11" x 17"	COR8	24" x 36"

Plastic Lenses

Sold in pairs. Available in matte or clear.

Clear	Size	Matte
CPL3	8-1/2" x 11"	CPM3
CPL4	11" x 14"	CPM4
CPL5	11" x 17"	CPM5
CPL6	14" x 22"	CPM6
CPL7	22" x 28"	CPM7
CPL8	24" x 36"	CPM8

Dividers

Available for CV and RE, not Mini.

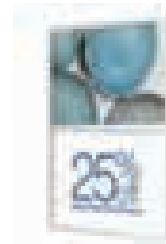

UCSW Slatwall Kit



UCWM Extra Wall Kit



Perfex Swivel SignFrames™

Drop-In Frames



↓
For Media
up to 3/16"
↑

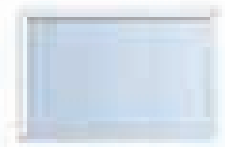

3/8" margin is covered by the frame.

Perfex Swivel SignFrames™

- All frames are vertically oriented
- Holds graphics up to 3/16" thick
- Handsome satin finishes
- Aluminum alloy frames
- Adds impact to your message

Ceiling Swivels

Includes a 9" standoff and a grid ceiling anchor.

PXCSV1	22" x 28"
--------	-----------

PXCSV2	24" x 36"
--------	-----------

Desk Swivels

Includes a 4" standoff and a 6-3/4" round base.

PXDSV1	8-1/2" x 11"
--------	--------------

PXDSV2	11" x 14"
--------	-----------

PXDSV3	11" x 17"
--------	-----------



Wall Swivels

Includes (2) 3" Standoffs and (2) 3-1/4" wall mounts.

PXWSV1	22" x 28"
--------	-----------

PXWSV2	24" x 36"
--------	-----------

* Specify: Model – Color: All models this page -S Satin Silver or -B Matte Black

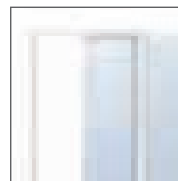

3/16" full open slots



Precision miters



Fully adjustable



Strong construction

Perfex SkyFrames™ Drop-In Frames



↓
For Media
up to 3/16"
↑

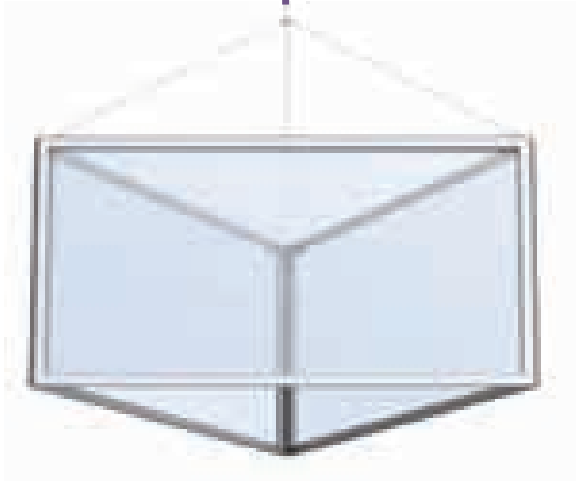

Triangular Structures

Specify: Model – Color

Model	Size: W x H x D	Color
STRPX1	36" x 18" x 36"	-S Satin Silver
STRPX2	42" x 24" x 42"	-B Matte Black
STRPX3	48" x 30" x 48"	



Live area: 3/8" margin is covered by the frame.

Strong, Lightweight - Cost Effective

- Aluminum alloy
- Cool curvilinear shape
- Contemporary design
- Precision miters
- Accepts 3/16" full graphics
- Easy side loading
- 5 minute assembly
- Handsome satin finishes

Four Sided Structures

Specify: Model – Color

Model	Size: W x H x D	Color
SRCPX1	42" x 12" x 42"	-S Satin Silver
SRCPX2	48" x 18" x 42"	-B Matte Black
SRCPX3	48" x 24" x 36"	

Steel Hanging Brackets

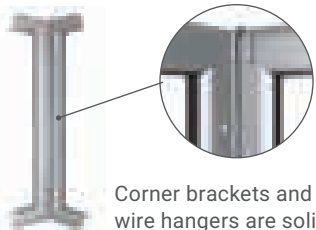

Corner brackets and welded wire hangers are solid steel.

Harness sets & other Hanging Hardware available pgs. 112 - 113

Units are also available without the hanging hooks to stack on the floor.



Silhouette Drop-In Trim Frames™

Hanging Frames

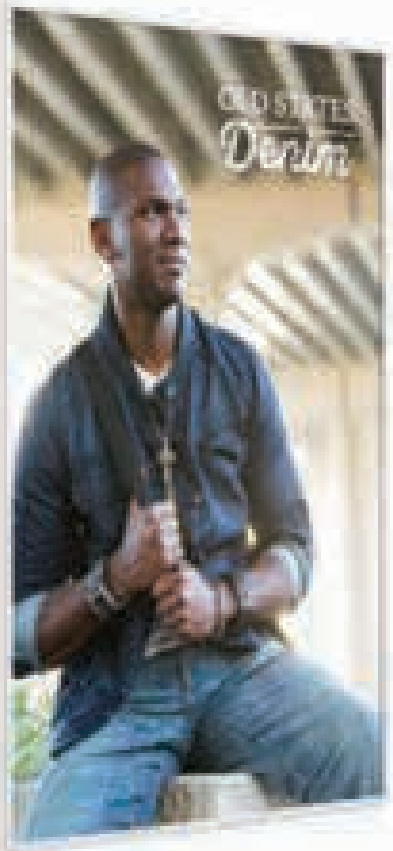

Silhouette Trim Frames™

- Super lightweight
- Extremely economical
- Real aluminum alloy
- Satin silver or matte black
- Adhesive backed
- Mitered corners
- Can be cut to any size
- Great as frame trim

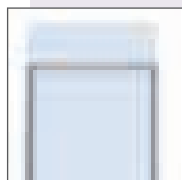

Graphic entry on short side.



Live area: 1/8" margin covered by the frame.



Removable adhesive backing.



Ultra Low Price Points!



Units ship completely assembled, bulk packed is standard.

Specify: Model – Color* *Doesn't affect price

Model	Graphic Size	Color*
OU1	8-1/2" x 11"	-S Satin Silver
OU2	11" x 14"	-B Matte Black
OU3	11" x 17"	
OU4	14" x 22"	
OU5	22" x 28"	
OU6	24" x 36"	

↓
For Media up to 3/32"
↑

Designed for Wall Mount applications.

Retail Counters



Hospitality

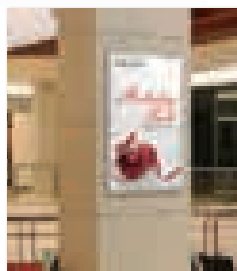

Elevators



Dressing Rooms

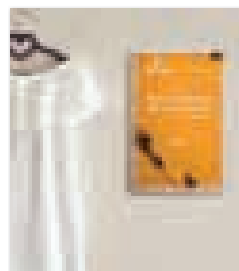

Doors

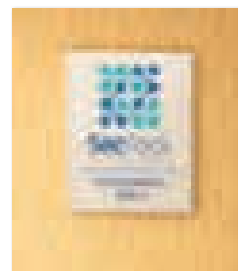

Restrooms

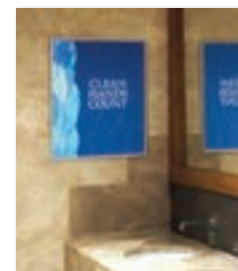

Corporate Walls

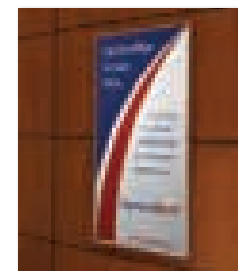

Perfex Signs Anywhere™

Drop-In Frames

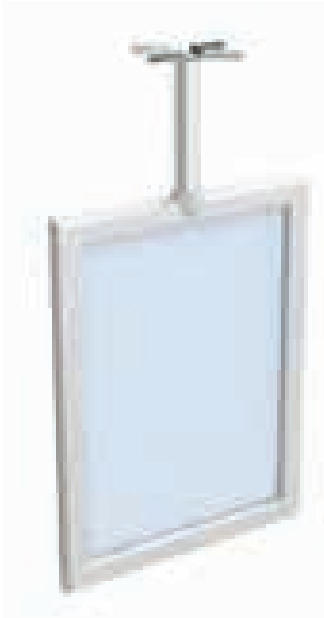

Ceiling Anchor

Strong steel clip attaches easily to grid ceilings, 6" riser, side entry.

PX1A	8-1/2" x 11"
PX2A	11" x 14"
PX3A	11" x 17"



Magnetic Mount

3-1/4" Round magnetic base for gondola tops, 6" riser, side entry.

PX1M	8-1/2" x 11"
PX2M	11" x 14"
PX3M	11" x 17"



Flange

3-1/4" round steel flange screws to wall or ceiling, 6" riser, side entry.

PX1F	8-1/2" x 11"
PX2F	11" x 14"
PX3F	11" x 17"

↓
For Media
up to 3/16"
↑



Clamp-On

VEE Clamp for round tubes 7/8" to 1-3/4" diameter and flats 5/8" to 2-1/2". 4" riser, top entry.

PX1G	8-1/2" x 11"
PX2G	11" x 14"
PX3G	11" x 17"

Custom clamps available.

Table Top

Weighted 6-3/4" round base, felt feet, 4" riser, top entry.

PX1T	8-1/2" x 11"
PX2T	11" x 14"
PX3T	11" x 17"

* Specify: Model – Color: All models this page -S Satin Silver or -B Matte Black



Magnetic Mount

Double magnetic base perfect for gondola tops.

PX1D	8-1/2" x 11"
PX2D	11" x 14"
PX3D	11" x 17"



Monster Drop-In Frames™

Hanging Frames



IMPRINTABLE

↓
For Media
up to 1/4"
↑

Monster Hanging Frames™

- Jumbo aluminum profile
- Handsome matte finishes
- Top 1/4" full entry slots
- 1-1/4" w x 1" d
- Ships fully assembled
- Individually boxed

Change Graphics Effortlessly!

Hanging Options

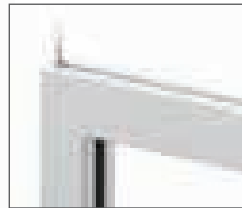

Metal eyes (ceiling)

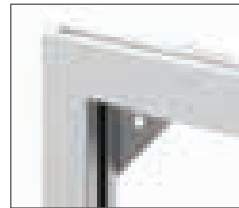

Corner brackets (wall)



3/8" margin hidden,
1-1/4" wide frame.



Full 1/4" top entry slot.



Monster Frame
Aisle Marker
Dividers sold separately

Specify: Model – Hanging* – Color*

Model	Graphic Size
NSH1	14" x 22"
NSH2	22" x 28"
NSH3	24" x 36"
NSH4	30" x 40"
NSH5	36" x 48"

Hanging*	
-WM	Wall Mount
-CP	Ceiling Vertical
-CL	Ceiling Horizontal

Color*	
-S	Satin Silver
-B	Matte Black

Clear Lenses Sold in pairs.

Model	Lens Size
CPL6	14" x 22"
CPL6.5	18" x 24"
CPL7	22" x 28"
CPL8	24" x 36"

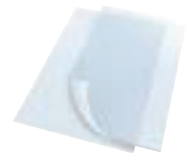

*Doesn't affect price, but must use to order.

Impressively Built - Use in high traffic areas for years to come.

Monster Pedestal SignFrames™

- Wide format alloy frame
- Racetrack oval upright
- 1/4" full top entry slot
- Ultra easy assembly
- 19" round, 15 lb. base
- Handsome matte finishes



NST1422-S



Built to Last!



Image area:
3/8" frame margin

Specify: Model - Color -S Satin Silver or -B Matte Black



Model	Graphic Size	Height	Weight
NST1422	14" x 22"	59" h	19 lbs.
NST1824	18" x 24"	61" h	20 lbs.
NST2228	22" x 28"	65" h	20 lbs.
NST2436	24" x 36"	73" h	21 lbs.

↓
For Media
up to 1/4"
↑

IMPRINTABLE

Monster Frame Divider™



NST2436-S with
Divider (sold separately)



- Terrific for:
- Wayfinders
- Retail Environments
- Restaurants
- Banks

Monster Frame
with Divider

Increased flexibility, subdivide the frame into different graphic spaces. **Customized to fit your needs. Use the same frame many different ways.**

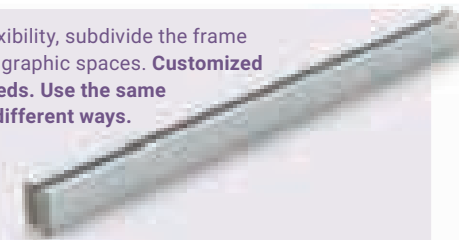

HD1
Clip Set (pg. 62)



Yoke support
adds stability

Extremely
attractive
racetrack
oval upright

NST2436-B
Shown with
HD1 clip set

19" round laser cut 15 lb. steel bases,
solid double bolt connection.

Perfex Pedestal Stands

Round Aluminum Uprights



SF5SRDTPV-B



SF5S-SQ-X-H-B with
LHP-C-1 Pamphlet Holder

↓
For Media
up to 3/16"
↑

Curvilinear, All Metal - Contemporary Design

- Heavy duty extruded alloy
- Accepts graphics to 3/16" thick
- Curvilinear frames, top slot
- All frames are open 2 sides

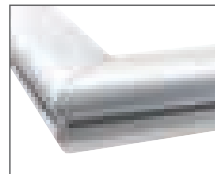

Sleek, functional, curvilinear design,
available in Satin Silver or Matte Black



Round aluminum
tubing with clutch lock



Top loading



SF3S-RD-TP-H-S Shown with
WES8511 wet erase insert
(printing not included).

Specify: Model — Base — Upright — Orientation* — Color* -S Satin Silver or -B Matte Black

Model	Graphic Size	Base	Size/Shape	Weight	Upright	Orientation*
SF3S	8-1/2" x 11"	-SQ	12" Square	5 lb. SF3, 4, 5	-TP Telescopic 28-1/2" - 51"	-H Horizontal
SF4S	11" x 14"	-SQ	16" Square	9 lb. SF6	-X Fixed 36"	-V Vertical
SF5S	11" x 17"	-RD	11" Round	5 lb. SF3, 4, 5		
SF6S	14" x 22"	-RD	13" Round	7 lb. SF6		

*Does not affect price, but must use to order.



Image area:
3/8" margin covered by frame.
Frame is 1" wide x 5/8" deep.

Perfex Pedestal Stands

Square Steel Uprights



PA4S-SQ-X-V-B

↓
For Media
up to 3/16"
↑



Image area:
3/8" frame margin



PA3S-RD-TP-H-W

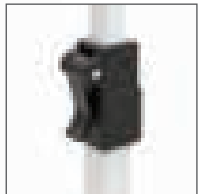

Square steel tubing
with innovative lock

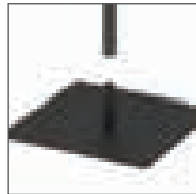

Steel
support bushing

Pedestal SignStands™

- Outstanding strength
- Square steel tubing in a sleek format
- Innovative lock for telescopic models
- Double sided Perfex Mini
- Minimalist, super strong aluminum frame
- Steel center support bushing

Top loading



Simple & Elegant!

Great for Retail
and Hospitality
Settings

Specify: Model — Base — Upright — Orientation* — Color* -W White or -B Matte Black



Model	Graphic Size	Base	Size/Shape	Weight	Upright	Orientation*
PA3S	8-1/2" x 11"	-SQ	12" Square	5 lb.	-TP Telescopic 28-1/2" - 51"	-H Horizontal
PA4S	11" x 14"	-RD	11" Round	5 lb.	-X Fixed 36"	-V Vertical
PA5S	11" x 17"	-RD	13" Round	7 lb.		

*Does not affect price, but must use to order.

Monster Drop-In SignFrames™

Floor Stand Frames

Large Format Monster Frames™

- Aluminum alloy racetrack oval uprights
- Specially designed heavy-duty alloy frame
- Rock solid double bolt upright to base connection
- Two marquise shaped steel bases
- 1/4" full top loading for graphic insertion

↓
For Media
up to 1/4"
↑

Large format aluminum frames

Frames ship ready to assemble, saving significantly on freight costs

Textured endcaps

Beautiful aluminum racetrack oval uprights



NSTR6-V-S

Units ship ready to assemble.
Estimated assembly time - 8 minutes.
NOTE: Once assembled, units cannot be disassembled.

Rubber mallet recommended for assembly.



Frames are 1/4" full top load and 3/8" margin is covered by the frame.



HD1 Set of 3 clips. Grips onto frame and holds placards up to 1/8" thick.

Racetrack oval uprights

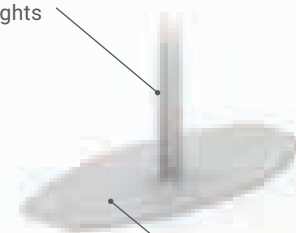

Marquise Base
18" long, 8-3/4" in the center
laser cut steel bases, solid
double bolt connection

Monster Drop-In SignFrames™ Floor Stand Frames

Large Format Monster SignFrames™

- Units ship K.D. ready to assemble for significant freight savings
- Marquise shaped steel bases
- Specially designed heavy duty frame

Specify: Model – Orientation* – Color*

Model	Graphic Size	Orientation*
NSTR1	36" x 48"	-H Horizontal
NSTR2	36" x 60"	-V Vertical
NSTR3	36" x 72"	
NSTR4	48" x 48"	Color* 
NSTR5	48" x 60"	-S Satin Silver
NSTR6	48" x 72"	-B Matte Black
NSTR7	60" x 60"	
NSTR8	60" x 72"	*Not on price sheet must use to order.

Custom sizes available

Frames are 1/4" full top load and 3/8" margin is covered by the frame.



Heights

- 36" h Frames start 36" off floor
- 48" h Frames start 24" off floor
- 60" / 72" h Frames start 12" off floor



Monster Frame Divider™

Increased flexibility, subdivide the frame into different graphic spaces. **Customized to fit your needs.**
Use the same frame many different ways.

Frame adapts as your needs change

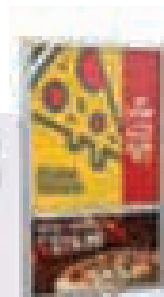
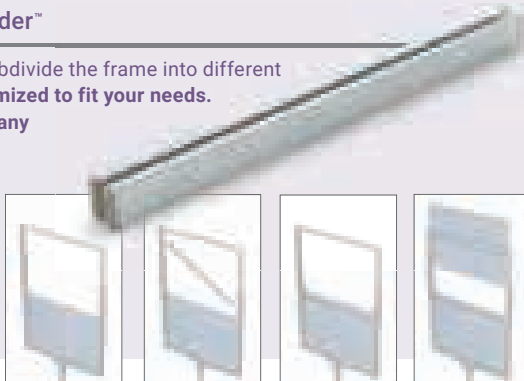

NST2436-S
with Monster
Frame Divider
(sold separately)

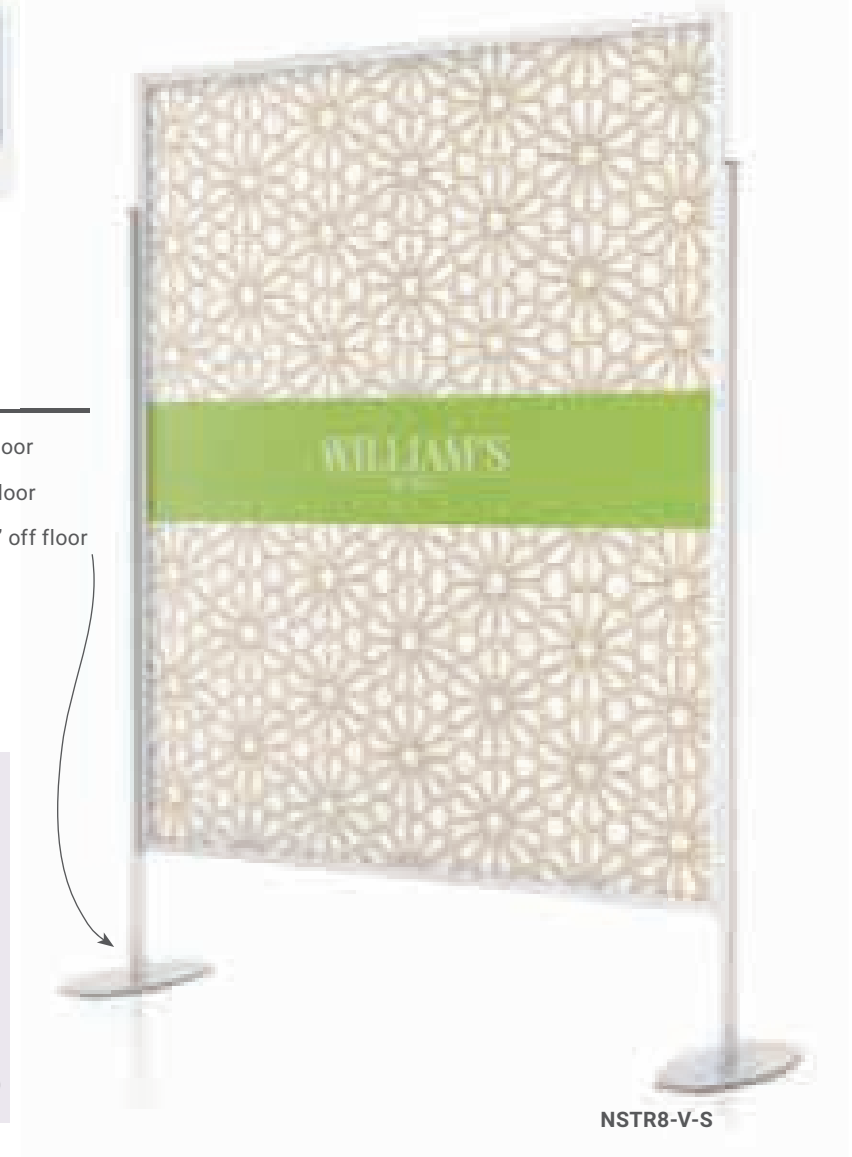

NSTR8-V-S

SignPost Kits™

SignFrame Stands



Perfex Drop-In
Y1PD9CH-S
SnapFrame
Y1SN9CH-S



SignPost™ SignFrame Kits

- Perfex Drop-In or Easy-Open SnapFrame
- Frame height can be easily adjusted
- Weighted square steel bases
- 72" high aluminum alloy upright
- Center or offset hanging
- Satin silver or matte black finish



Perfex Drop-In
Y1PD4CH-S
SnapFrame
Y1SN4CH-S



Perfex Drop-In
Y2PD2CH-S
w (2) **YLTC1**
Lit. Holders
SnapFrame
Y2SN2CH-S
w (2) **YLTC1**
Lit. Holders

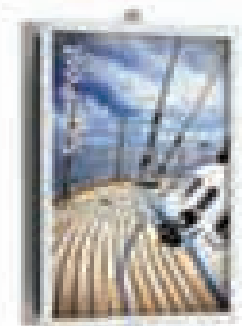

Perfex Drop-In
Y2PD2CH-S
SnapFrame
Y2SN2CH-S

Complete Kit includes Frame, Upright and Base

***Specify:** # of Frames – Frame Type – Graphic Size – Frame Position* – Color*

# of Frames		Frame Type		Graphic Size		Frame Position**		Color*	
Y1	One Frame	PD	Perfex Drop In	2	22" x 28"	CH	Center Hung	-S	Satin Silver
Y2	Two Frames	SN	SnapFrames	4	24" x 36"	OF	Offset to one side**	-B	Matte Black
				9	22" x 56"				

**Perfex only

*Does not affect price

SignPost Kits™

SignFrame Stands

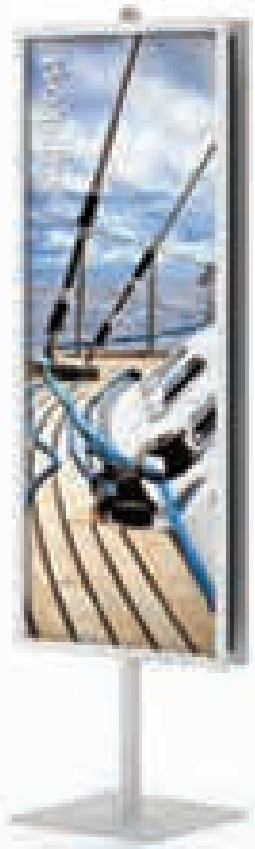

Perfex Drop-In
Y2PD9CH-S
SnapFrame
Y2SN9CH-S



Perfex Drop-In
Y2PD2CH-S w (2) YPX5C
SnapFrame
Y2SN2CH-S w (2) YE07

SignPost > the ultimate combination of stability and European styling.



Custom unit, **SignPost™ Banner Stands**, Pages 144-145

Perfex
Drop-In Frame

↓
For Media
up to 3/16"
↑

EasyOpen
SnapFrame

↓
For Media
up to 1/32"
↑

Spring loaded
sides for easy insertion

Matte overlay
lens included with
SnapFrames

SignPost™ SignFrame Kits

- Sold as complete sets
- Aluminum alloy construction
- Handsome matte finishes
- Many accessories available
- Customization requests encouraged
- Proudly made in the U.S.A.

Blade Poster SignHolders™

Drop-In Frames

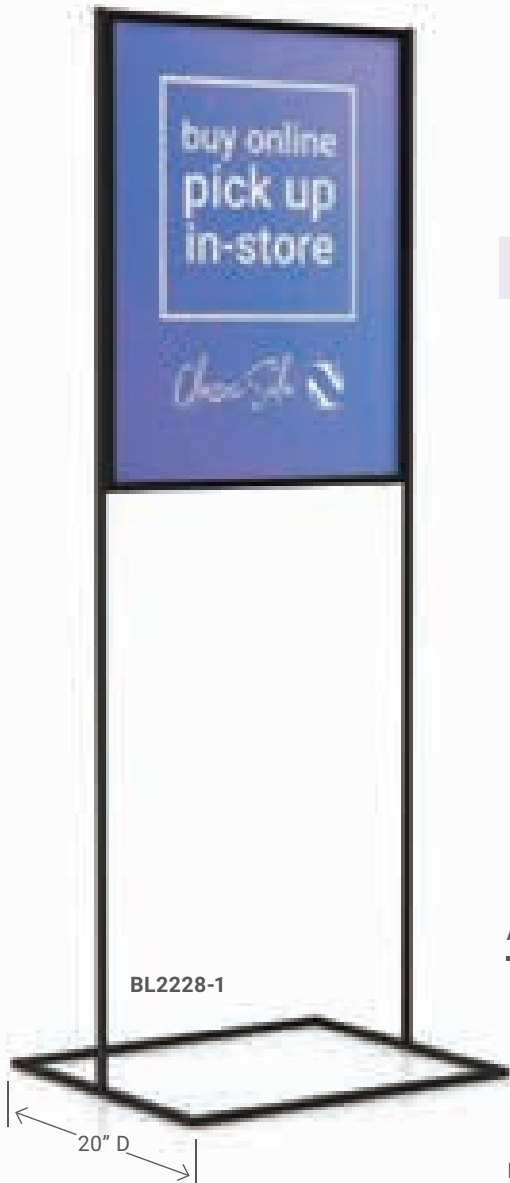

Amazingly thin!



Blade Poster Signholders™

- All metal, slender 5/8" thick profile
- Steel base & uprights, black matte finish
- Suitable for high traffic areas
- Custom sizes and colors available



Specify: Model – Color

Model	Tiers	Graphic w" x h"	Ht.	Wt.
BL1422-1	1	14" x 22"	65"	7 Lbs.
BL1422-2	2	14" x 22"	73"	9 Lbs.
BL1422-3	3	14" x 22"	88"	11 Lbs.
BL2228-1	1	22" x 28"	65"	8 Lbs.
BL2228-2	2	22" x 28"	73"	11 Lbs.

Matte Black 

Customization

Sizes, colors, different bases.
Quantity minimums apply.

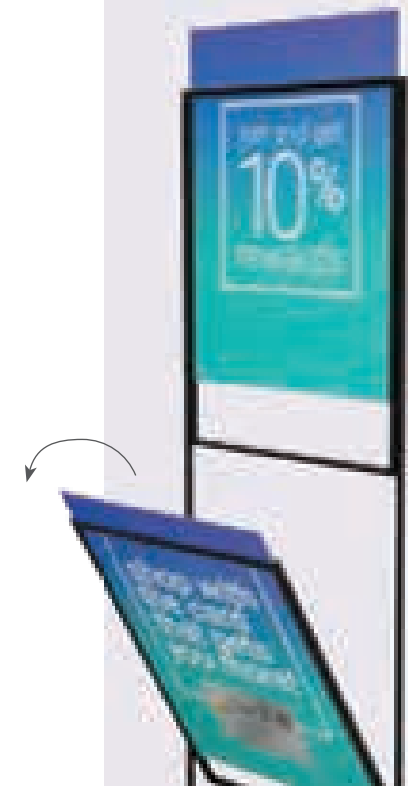

Release snap button and bottom frame pivots for graphic insertion

Accessories



Weighted Cover
BLWC14 For **BL1422** 14" x 22" (~15 lbs.)
BLWC22 For **BL2228** 22" x 28" (~25 lbs.)



SLB3 Lit. Baskets (for 22" w units only)
 (1) 11" x 17" tabloids or
 (2) 8-1/2" x 11" stacks



Coroplast® White, 4 mm
COR6 14" x 22"
COR7 22" x 28"



Clear lenses, sold in pairs.
CPL6 14" x 22"
CPL7 22" x 28"

Blade Poster SignHolders™

Drop-In Frames



BL2228-2

↓
For Media
up to 3/16"
↑



BL1422-3



Blade Poster Signholders™

- Outstanding strength
- Durable, extremely lightweight
- Great for quick, easy graphic change-outs
- Top load graphics facing out - double sided
- Snap button pivots lower frames for graphic insertion
- Strong 5/8" thick profile

Built to last in high traffic areas

A Combination of Power and Aesthetics

Extremely durable construction

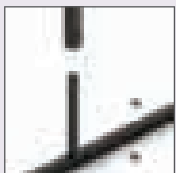

Steel tubing electrically welded.

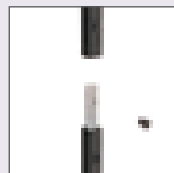

Solid support bushings.

Poster SignHolders

Drop-In Frames



LF228-B

IMPRINTABLE

Aluminum Poster SignHolders

- Aluminum construction
- Top slot for easy insertion
- Fits two 22" x 28" graphics
- Sleek frame design
- Ultra easy assembly
- Handsome satin finishes
- Double pole uprights
- Rectangular base



Top loading graphics



Bases have metal support bushings

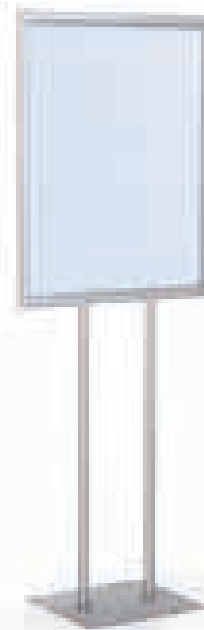

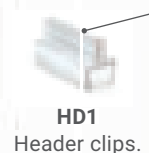

LF228-S



HD1 Header clips.



Specify: Model – Color

Model	Graphic Size	Height	Weight	Color
LF228	22" x 28"	60" h	13 lbs.	 
				-S Satin Silver
				-B Matte Black

↓
For Media
up to 3/16"
↑

Accessories



Clear lenses sold in pairs.
CPL7 22" x 28"



HD1 Clip Set of 3 pcs, 3" long. Grips signage up to 1/8" thick. Attaches to frame. Clear PVC.



SLB Lit. Baskets
(1) 11" x 17" tabloids or
(2) 8-1/2" x 11" stacks.



LF228-S with SLB Lit. basket & HD1 header clips.

Information Centers

Drop-In Frames

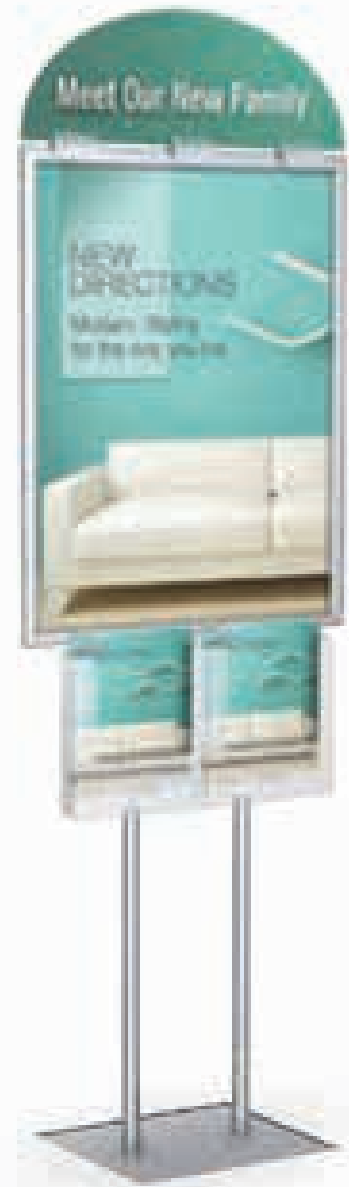



LF2LT3-S
with HD1 header clips.

One or Two Sided Information Centers

- Aluminum construction
- Sleek frame design
- Top slot for easy insertion
- Ultra easy assembly
- Fits two 22" x 28" graphics
- Handsome satin finishes

↓
For Media
up to 3/16"
↑

Specify: Model – Color

Model	Specifications	Color
LF2LT1	Signholder with 5 Pamphlet Holders on 1 side	  -S Satin Silver
LF2LT2	Signholder with 10 Pamphlet Holders, 5 each side	-B Matte Black
LF2LT3	Signholder with 2 Catalog Holders on 1 side	
LF2LT4	Signholder with 4 Catalog Holders, 2 each side	

Clip on Collateral Holders

- Crystal Clear Plastic
- Pamphlet or Catalog Sizes

Pamphlet Holders are 4" wide x 1-1/2" deep
Catalog Holders are 9" wide x 1-1/2" deep

For details see pg. 172

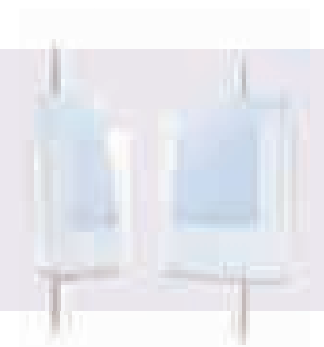

LF2LT1-B

Poster SignHolders

Drop-In Frames



LF328-B

LF3 Series Poster SignHolders

- All Aluminum construction
- Top slot (1/4") for easy insertion
- Room for two 1/8" graphics
- Electrically-welded construction
- Ultra easy assembly in minutes
- Handsome satin finishes



Top load.

Specify: Model – Color *Require rigid media, 1/4" max.

Model	Double-sided Tiers	Frame Size	Ht.	Wt.	Color
LF328	1	22" x 28"	63"	11 lbs.	-S Satin Silver
L2256*	1	22" x 56"	62"	12 lbs.	-B Matte Black
L2284*	1	22" x 84"	88"	13 lbs.	
L2328	2	22" x 28"	63"	12 lbs.	
L3328	3	22" x 28"	89"	14 lbs.	

↓
For Rigid Media
up to 1/4"
↑

Custom Examples

- Custom colors, bases, name plates, imprinting
- Minimum quantities apply



L3328-S

Poster SignHolders

Drop-In Frames



L2328-S





L2256-S

Tilter Models

- Frames pivot adding impact
- Lightweight aluminum, easily portable
- Two sided communication, assembly is fast & easy
- Quick, easy graphic changeouts
- Top 1/4" slot - room for two 1/8" graphics
- Great for Retail, Lobby and Office settings

Specify: Model – Color

Model	Tiers	Frame Size	Ht.	Wt.
TLT31	1 Tilter	22" x 28"	67"	11 lbs.
TLT32	2 Tilters	22" x 28"	67"	13 lbs.
TLT33	3 Tilters	22" x 28"	89"	14 lbs.

-S Satin Silver or -B Matte Black  



TLT33-S

Accessories



Clear lenses, sold in pairs.
CPL7 22" x 28"
 other sizes available.



HD1 Set of 3 pcs, 3" long.
 Grips signage up to 1/8" thick.
 Attaches to frame. Clear PVC.



Weighted Covers
LFWC1 21 lbs. - **LF328, LFPB, L2256, L2328-S**
LFWC2 28 lbs. - **L2284, L3328**



Tilt Wheel Base Option
 Add -WHL

Titan Poster SignHolders™

Drop-In Frames



Titan Poster SignHolders™

- All Aluminum construction
- Ultra easy assembly in minutes
- Top slot (1/4") for easy insertion
- Handsome satin finishes
- Room for two 1/8" x 22" x 28" or 24" x 36" graphics

↓
For Media
up to 1/4"
↑

Extraordinarily strong and stable.



Radius corners,
Metal Yoke.



Round base, double
bolt connection.



Beautiful
oval upright.



Graphics
top load.



Specify: Model – Color

Model	Style	Base	Graphics	Ht.	Wt.
LF128	Single Pole	17" Round	22" x 28"	65"	22 lbs.
LF136	Single Pole	17" Round	24" x 36"	65"	23 lbs.

-S Satin Silver or -B Matte Black



Eclipse Drop-In SignFrames™ Pedestal Frames

Eclipse Pedestal SignFrames™

- Metal construction
- Non-glare overlay
- 9" x 14" oval bases
- Satin finishes
- Handsome support rails
- Pole length - 43"



Choose curved or
straight graphic back

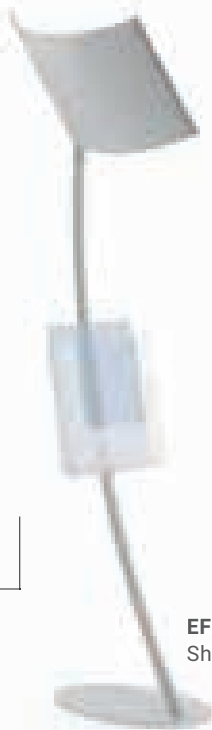

EF3CVH-S
Shown with LHC-C-1



EF4FH-B

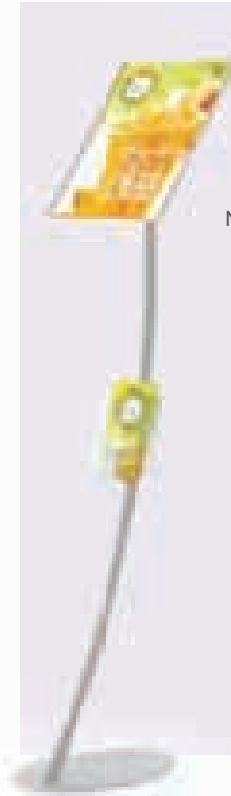

EF3FV-S
Shown with LHP-C-1

Non - glare overlay.



Specify: Model – Graphic Back* – Orientation* – Color*

Model	Graphic Size	Graphic Back	Orientation*	Color*
EF1	8-1/2" x 11"	-CV Curved	-H Horizontal	-S Satin Silver
EF3	11" x 14"	-F Flat	-V Vertical	-B Matte Black
EF4	11" x 17"			

*Not on price sheet, but must use to order.

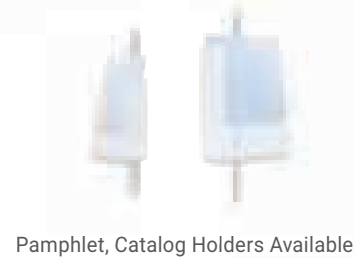

Pamphlet, Catalog Holders Available

↓
Accepts Paper
Media
↑

Incline Frame Stands™

Drop-In Frames



INCSEG1-2260-S

Lightweight and strong, portable and effective

- All metal construction, built to exacting standards
- Ships flat, ten second set up, portable
- Many different frame options, single or double sided

A nice way to provide ambience and information in retail settings.

Our most popular Frame Options:

EasyOpen SnapFrame™
Poster & paper signs up to 1/32"



Monster Drop-In Frames™
Thin graphics up to 1/4" board



Charisma SEG Frame™
Silicone edge fabric graphics

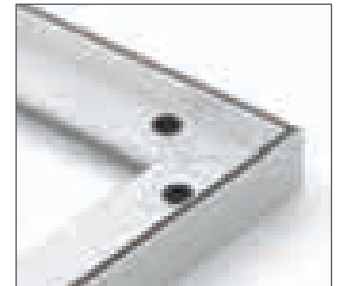

Standard and custom models available



INCSE01-2260-S
One-sided
SnapFrame



INCSE02-2260-B
Two-sided
SnapFrame



INCNST1-2260-B
One-sided
Monster Frame



INCNST2-2260-S
Two-sided
Monster Frame



INCSEG1-2260-S
One-sided
SEG Frame



INCSEG2-2260-B
Two-sided
SEG Frame

Incline Frame Stands™

Drop-In Frames

Relaxed, laid back, designed to put the customer at ease.

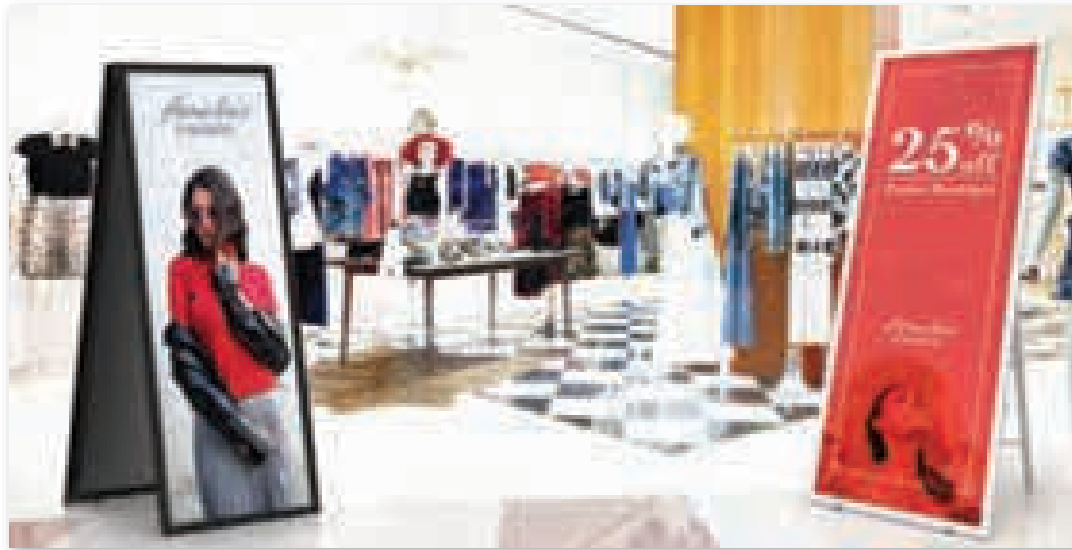

Portability:

Incline Frame Stands are easily moved from one department to another.

Choices:

Color - Size - Front Frame Style
Single or Double Sided

Specify: Model – Color

Model	Graphic Size W" x H"	Frame Style
INCE01-2260	(1) 22" x 60"	One-sided SnapFrame
INCE02-2260	(2) 22" x 60"	Two-sided SnapFrame
INCNST1-2260	(1) 22" x 60"	One-sided Monster Frame
INCNST2-2260	(2) 22" x 60"	Two-sided Monster Frame
INCSEG1-2260	(1) 22" x 60"	One-sided SEG Frame
INCSEG2-2260	(2) 22" x 60"	Two-sided SEG Frame

-S Satin Silver or -B Matte Black  



Pivot to fold flat.



INCE02-B

Monster Frames include ~1/8" thick rigid white insert, removable when using thicker graphics.

Perfex A Frames™

Drop-In Frames





Great for Malls!

Economy Folding A Frames

- Aluminum frames, legs and stays
- Units collapse & fold compactly
- 2-1/2" x 2-1/2" x 44-1/2" closed
- Accepts graphics up to 1/4" thick
- Top entry slot, non-slip tips
- Weighs only 5-1/2 lbs

Specify: Model

Model	Size	Color*
AF22-S	22" x 28"	Silver
AF22-B	22" x 28"	Black
AF24-S	24" x 36"	Silver
AF24-B	24" x 36"	Black

-S Satin Silver or -B Matte Black  
 *Black units are more costly than the silver

↓
 For Media
 up to 1/4"
 ↑



Food service, promotional messages, retail signage and more.



Top load slots
 Double sided

Collapsible side, front
 and back crossbars

Aluminum legs with
 intrinsic frame rails

Non-slip tips

AF22 - Half open and Close

NEW

Great for Outdoor Use!

Outdoor Folding A Frames

- Aluminum frames, legs and stays
- Accepts graphics from 5/32" up to 1/4" thick
- Units collapse & fold compactly
- Top entry slot, non-slip tips, 39" legs
- Steel weight for added stability

Specify: Model

Model	Size	Color
AF22-OUTDOOR-S	22" w x 28" h	Silver
AF22-OUTDOOR-B	22" w x 28" h	Black
AF24-OUTDOOR-S	24" w x 36" h	Silver
AF24-OUTDOOR-B	24" w x 36" h	Black

↓
For Media
5/32"
to 1/4" thick
↑

- Color* 
- S Satin Silver
 - B Matte Black

* Black units are more costly than the silver

AF24-OUTDOOR - S



A Frame Sign Holders Drop-In Frames

Perfex A Frames™

- Perfex aluminum curvilinear frames
- Aluminum extruded legs
- Ruggedly built - designed to last
- Heavy duty support stays
- Non-skid rubber bumpers
- 44-1/2" Closed, 43" Open



AFP22-S
Standard models top load

Header graphic size:
22" x 8" or 24" x 8"

Live area: 3/8"
margin covered
by the frame

AFPH22-S



Mount and Change Graphics Effortlessly!



Cool Curvilinear Shape.
Accepts 3/16" substrates

Clear or Matte Lens

- Sold in pairs
- Adds protection for your signage
- For indoor use only

Model	Lens	Lens Size
CPL7	Clear	22" x 28"
CPM7	Matte	22" x 28"
CPL8	Clear	24" x 36"
CPM8	Matte	24" x 36"

Specify: Model

Model	Size	Color*	with Headers
AFP22-S	22" x 28"	Silver	AFPH22-S
AFP22-B	22" x 28"	Black	AFPH22-B
AFP24-S	24" x 36"	Silver	AFPH24-S
AFP24-B	24" x 36"	Black	AFPH24-B

-S Satin Silver or -B Matte Black 
* Black units are more costly than the silver

Convex Poster SignHolders™

Drop-In Frames



Easy graphic installation

Convex Poster SignHolders™

- Graphic changes are effortless and assembly is ultra simple
- Suitable for high traffic areas
- Strong visual impact
- Double sided viewing
- Graphic can be die-cut and extend past the top of display: (Models **VX2256**, **VX2284**, **VX1292**)



↓
.060" Styrene Suggested
↑

Attractive curved units demand attention!



Specify: Model — Color

Model	Double-sided Tiers	Base	Graphics	Ht.	Wt.	Color
VX2228-1	1	17" Round	22"w x 28"h	63"	19 lbs.	-S Satin Silver
VX2228-2	2	Elipitical	22"w x 28"h	58"	18 lbs.	-B Matte Black
VX2228-3	3	Elipitical	22"w x 28"h	86"	23 lbs.	
VX2256*	1	Elipitical	22"w x 56"h	57"	16 lbs.	
VX2284*	1	Elipitical	22"w x 84"h	85"	21 lbs.	
VX1292	1	Elipitical	12"w x 92"h	92"	20 lbs.	

***VX2256** & **VX2284** require .060" (1/16") semi rigid media minimum , thinner will collapse. HIPS Styrene ideal. Maximum .090" (3/32").

Convex Poster SignHolders™

Drop-In Frames

Slim Convex Poster SignHolder

- Rise above customers with key messages
- Perfect for airports, exhibits, retail, restaurants, malls and tradeshows
- Avoid ladders while elevating message
- Change out graphics fast
- Built strong, all metal construction
- Holds 12" w x 92" h graphics



VX1292-S

↓
.040" to .060" thick
Styrene Suggested
↑



Table top available Qty 25+
Ideal for food service



VX2228-3-S

Contemporary Look with Strong Visual Impact

- Perfect for airports, exhibits, retail, restaurants, malls and tradeshows
- Double & triple units have elliptical bases
- Change out graphics instantly without disassembling unit!
- Built strong to last

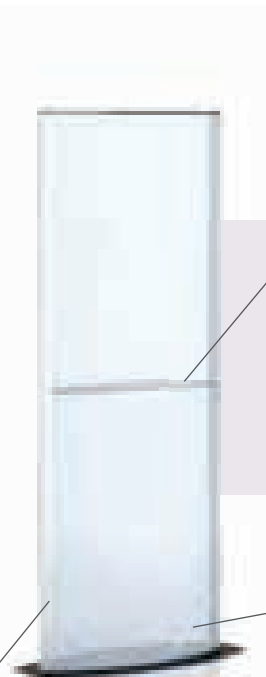

VX2228-2-S

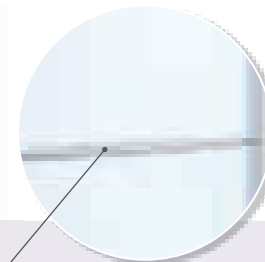

Tiered Units have dividers to hold graphics in place. One piece uprights for stability.

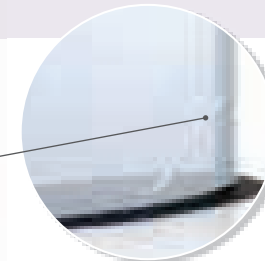

Support brackets for added stability

1/2" margin hidden on each side, viewable live area 21" wide



VX2284-S

Hercules Roll Around™ Drop-In Frames



R4328-S



R2328-S



RL328-S

Super Strong, Very Heavy Base

Model	Double-sided Tiers	Graphic Size	Ht.	Wt.
RL328	1	22" x 28"	65"	39 lbs.
R2328	2	22" x 28"	65"	44 lbs.
R3328	3	22" x 28"	94"	47 lbs.
R4328	1	22" x 84"	94"	42 lbs.

Hercules Roll Around SignHolders™

- Heavy 22" x 28" Portable SignHolders
- 30 pound steel powder coated base
- 2-1/2" ball bearing casters with brakes
- Double sided viewing
- Satin Silver finish

Top Loading
for media up to 3/16"



3/8" margin
covered by frame.

2-1/2" Ball bearing
casters with brakes.



R3328-S

Color 
-S Satin Silver

Mosaic Side Load Drop-In Stands

Mosaic Stands

- 22" x 28" Aluminum alloy frames
- Easy side load up to 1/4"
- Double sided viewing
- Beautiful satin silver finish
- Three steel base choices
- Made in USA, built to last

2 Tier units include
(2) 1/8" x 22" x 28" white
inserts with floating crossbar.

Customization Options

- Size
- Color
- Base
- Slatwall panels
- Hanging
- Countertop

Custom examples available
in quantities of 25+



MOS-2228-1-FL-S



MOS-2228-1-TW-S



MOS-2228-2-HC-S



Model	Graphic Size	Tier	Base
MOS-2228	22" w x 28" h	1 1 Tier	FL Flat
		2 2 Tier	TW Tilt to wheel
			HC Hercules

↓
For Media
up to 1/4" thick
↑

SignHolder Grippers

Drop-In Frames

HD1 Gripper

- 3" long, top grips signage up to 1/8" thick,
- Bottom grips 5/8" to 3/4" frames.
- Great for Perflex Frame tops and sides.
- Clear PVC plastic. **HD1** (Set of 3)

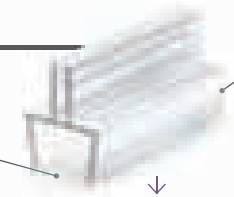

↓
For Media
up to 1/8"
↑

Adhesive Grippers

- Signholder Gripper adheres to any surface with included adhesive tape. Set of 3



Model	Length	Media
GPP1	1/2" w x 3" long	holds up to .080" media
GPP2	1/2" w x 3" long	holds 1/8" to 3/16" media
GPP3	1" w x 3" long	holds 1/8" to 1/4" media

↓
For Media
up to 1/4"
↑

Snap-on Graphic Clips

- Holds rigid media up to 3/32" thick, Clear PVC plastic. Set of 2

Model	Tubes
HT1	Fits 1" diameter tubes
HT2	Fits 3/4" diameter tubes
HT3	Fits 1-1/2" diameter tubes

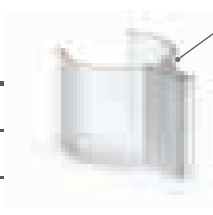

LF228-S shown with SignHolder Gripper examples.

Snap-on Flats

- Snaps onto round tubes.
- Provided on a project basis. Clear plastic.
- We can punch holes, attach foam adhesive tape, or Velcro®
- Can cut to any length. Available in 3/4", 1", 1-1/4", 1-1/2" diameters.



GPP9 Gripper

- Securely snaps onto 1" diameter tubes. Provides gripping of sign media up to 3/16" thick. Clear plastic. 3" long. Set of 2.



Frame Accessories

Drop-In Frames

Scroll Brackets

- Steel construction, powder coated finish. Each bracket comes with 2 S-Hooks.

Model	Length	Center
OLL18	18" long	6" center to center between eyehooks
OLL24	24" long	10-1/2" center to center between eyehooks

Specify: Color* **-S** Satin Silver or **-B** Matte Black

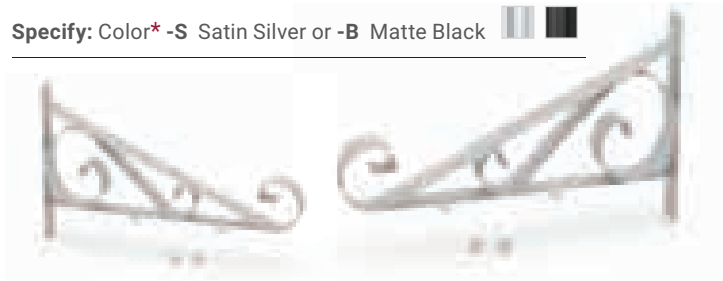

French Cleats

- Aluminum construction. Set of 2 interlocking cleats.
- Screws and wall anchors included. Anchor one piece to wall, other to hanging sign

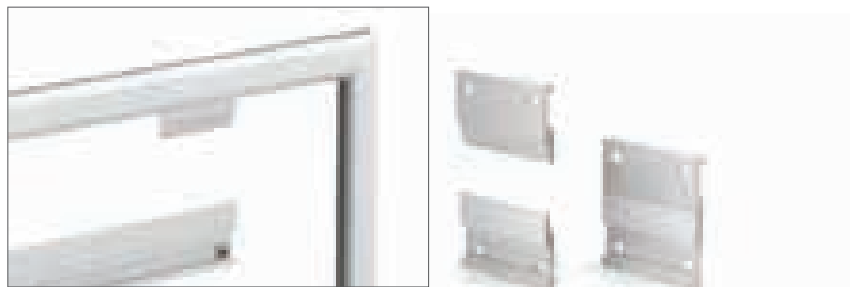

Model	Length	Model	Length	Model	Length
FNCH1	2" long	FNCH3	12" long	FNCH5	36" long
FNCH2	4" long	FNCH4	22" long	FNCH6	48" long

Coroplast® Backs

- White, 4 mm corrugated plastic boards make excellent frame backs. Sold individually



Model	Size
COR3	8-1/2" x 11"
COR4	11" x 14"
COR5	11" x 17"
COR6	14" x 22"
COR6.5	18" x 24"
COR7	22" x 28"
COR8	24" x 36"

Plastic lenses

- Sold in pairs.

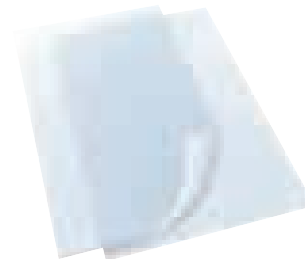

Model (Clear)	Model (Matte)	Size
CPL3	CPM3	8-1/2" x 11"
CPL4	CPM4	11" x 14"
CPL5	CPM5	11" x 17"
CPL6	CPM6	14" x 22"
CPL6.5	CPM6.5	18" x 24"
CPL7	CPM7	22" x 28"
CPL8	CPM8	24" x 36"

Coroplast® - Lens Combo Packs

- Includes one 4 mm corrugated plastic board and two clear lenses



Model (Clear)	Model (Matte)	Size
COPL3	COPM3	8-1/2" x 11"
COPL4	COPM4	11" x 14"
COPL5	COPM5	11" x 17"
COPL6	COPM6	14" x 22"
COPL6.5	COPM6.5	18" x 24"
COPL7	COPM7	22" x 28"
COPL8	COPM8	24" x 36"

Flair Perimeter Frames™

Drop-In Frames

Cut Size is the Visible "Live Area"

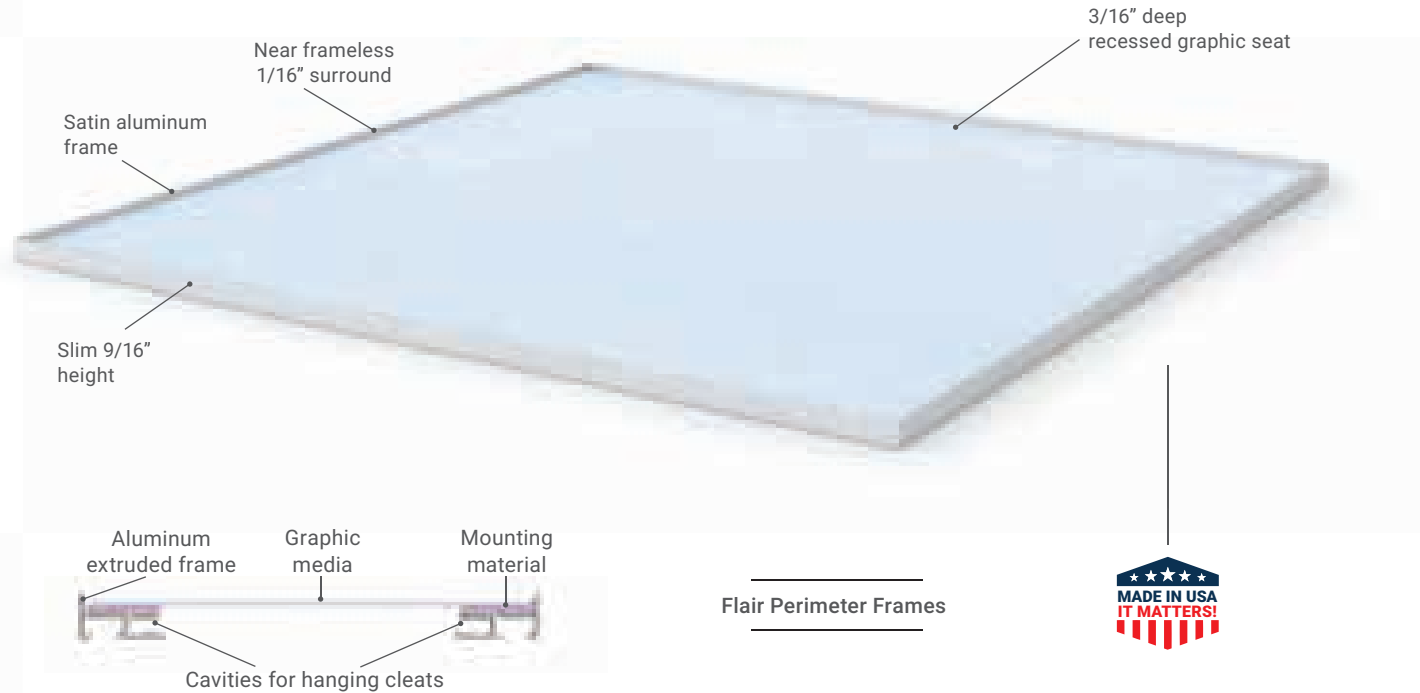
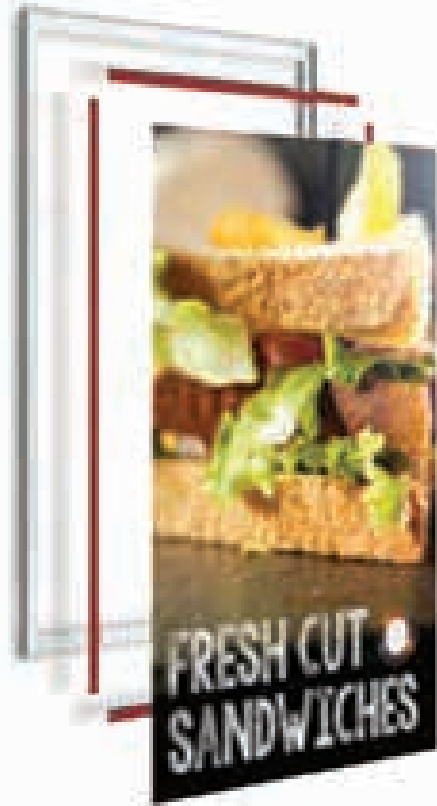

Flair Perimeter Frames

Flair Perimeter Frames™

- Graphic seat is recessed 3/16"
- Frameless look, 1/16" surround "lip"
- Accepts semi-rigid or rigid media
- Ships ready for quick assembly!
- Aluminum hanging cleats included
- Ultra clean, modern, minimalist look
- Custom sizes and colors available

Graphic Media Choices

- Styrene
- Metal plates
- Art prints
- Coroplast

Suggested Mounting Materials

- Foam tapes
- Hook/loop
- Flexible magnets

French Cleats
for hanging included.

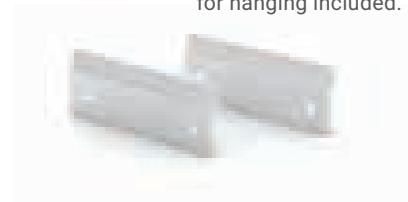

Specify: Model* – Color* -S Satin Silver or -B Matte Black   *Does not affect price

Model	Graphic Size
FLR8511	8.5" x 11"
FLR1114	11" x 14"
FLR1117	11" x 17"
FLR1422	14" x 22"
FLR2228	22" x 28"
FLR2436	24" x 36"
FLR2448	24" x 48"



Magnetic Signware Frames™

- Low profile frameless look
- Featuring recessed graphics
- Magnetic receptive steel plates
- Units ship assembled and boxed

Create 3-D effects
by layering graphics.



For Magnetic Media™

- Near frameless aluminum alloy frame
- Recessed graphic seat with a steel back plate
- For graphics, print on magnetic media (not included)

For Magnetic Receptive Media™

- Same as above but includes a high energy magnetic sheet
- Print on low cost magnetic receptive media (not included)

Magnetic Media	Graphic Size	Magnetic Receptive
TLC8511-MM	8.5" x 11"	TLC8511-MR
TLC1114-MM	11" x 14"	TLC1114-MR
TLC1117-MM	11" x 17"	TLC1117-MR
TLC1422-MM	14" x 22"	TLC1422-MR
TLC2228-MM	22" x 28"	TLC2228-MR
TLC2436-MM	24" x 36"	TLC2436-MR

French Cleats
for hanging included.



Specify: Model* – Color* -S Satin Silver or -B Matte Black   *Does not affect price

Signware Frames™ Magnetic

For Magnetic Media
Print on magnetic media
(not included)

Steel backer
included

Near frameless, 9/16"
high, satin finish frame

For Magnetic Receptive Media
Print on magnetic receptive media
(not included)

Double sided
magnet included

Steel backer
included

Near frameless, 9/16"
high, satin finish frame

FrameGraphix Signware Stands™

Magnetic



TLS2472-MR-S

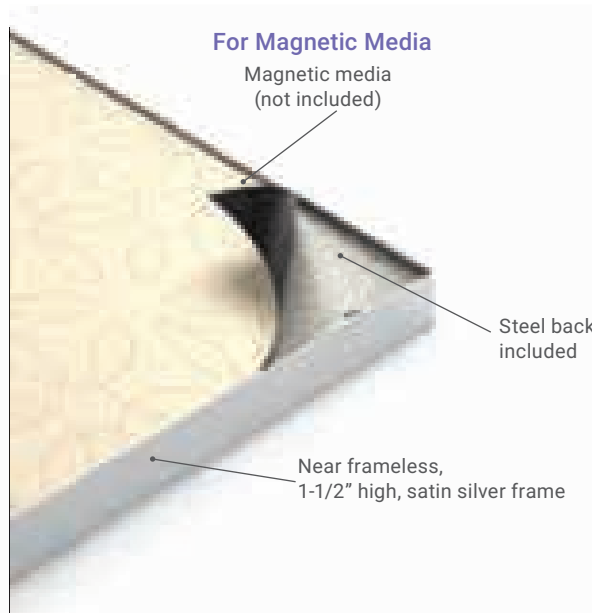

High Quality
Cost Effective



Durable
Built to last

Double sided satin silver
aluminum frame

Frame ships in 2 sections

FrameGraphix Magnetic Signware Stands™

- Ships efficiently to save on freight costs
- Recessed graphic seats with near frameless look
- Double sided satin silver aluminum frame
- Incredibly easy graphic change-outs
- Full width weighted steel base



Magnetic Media	Graphic Size	Magnetic Receptive
TLS1472-MM	14" x 72"	TLS1472-MR
TLS2472-MM	24" x 72"	TLS2472-MR

Custom size requests encouraged.

TLS1472-MM-S

Specify: Color* -S Satin Silver or -B Matte Black



FrameGraphix Wall & Pedestal Frames™

Magnetic



Mounting bracket included.

TLW4824-MM-H-S

1-1/2" Deep Frame

FrameGraphix Magnetic Wall Frames™

- 1-1/2" deep extruded profile frame
- Incredibly easy graphic change-outs
- Recessed graphic seats, frameless look
- Hang horizontally or vertically
- Wall mount hardware included

Print on Magnetic Media or Magnetic Receptive Media

Magnetic Media	Graphic Size	Magnetic Receptive	Orientation*
TLW3020-MM	30" x 20"	TLW3020-MR	-H Horizontal
TLW3624-MM	36" x 24"	TLW3624-MR	-V Vertical
TLW4824-MM	48" x 24"	TLW4824-MR	*Doesn't affect price, but must use to order.

Custom size requests encouraged.

Specify: Size – Color* -S Satin Silver or -B Matte Black



TLS5-MM-X-SQ-V-S

TLS3-MR-TP-RD-V-B

FrameGraphix Magnetic Pedestal Frames™

Magnetic Media	Graphic Size	Magnetic Receptive
TLW3-MM	8-1/2" x 11"	TLW3-MR
TLW4-MM	11" x 14"	TLW4-MR
TLW5-MM	11" x 17"	TLW5-MR

Upright	Base	Orientation*
-TP Telescopic 26"- 50"	-SQ 12" Square - 5 lb.	-H Horizontal
-X Fixed 36"	-RD 11" Round - 11 lb.	-V Vertical

*Doesn't affect price, but must use to order.

Specify: Model – Upright – Base – Orientation* – Color* -S Satin Silver or -B Matte Black

SeeWell Info Frames™

Magnetic

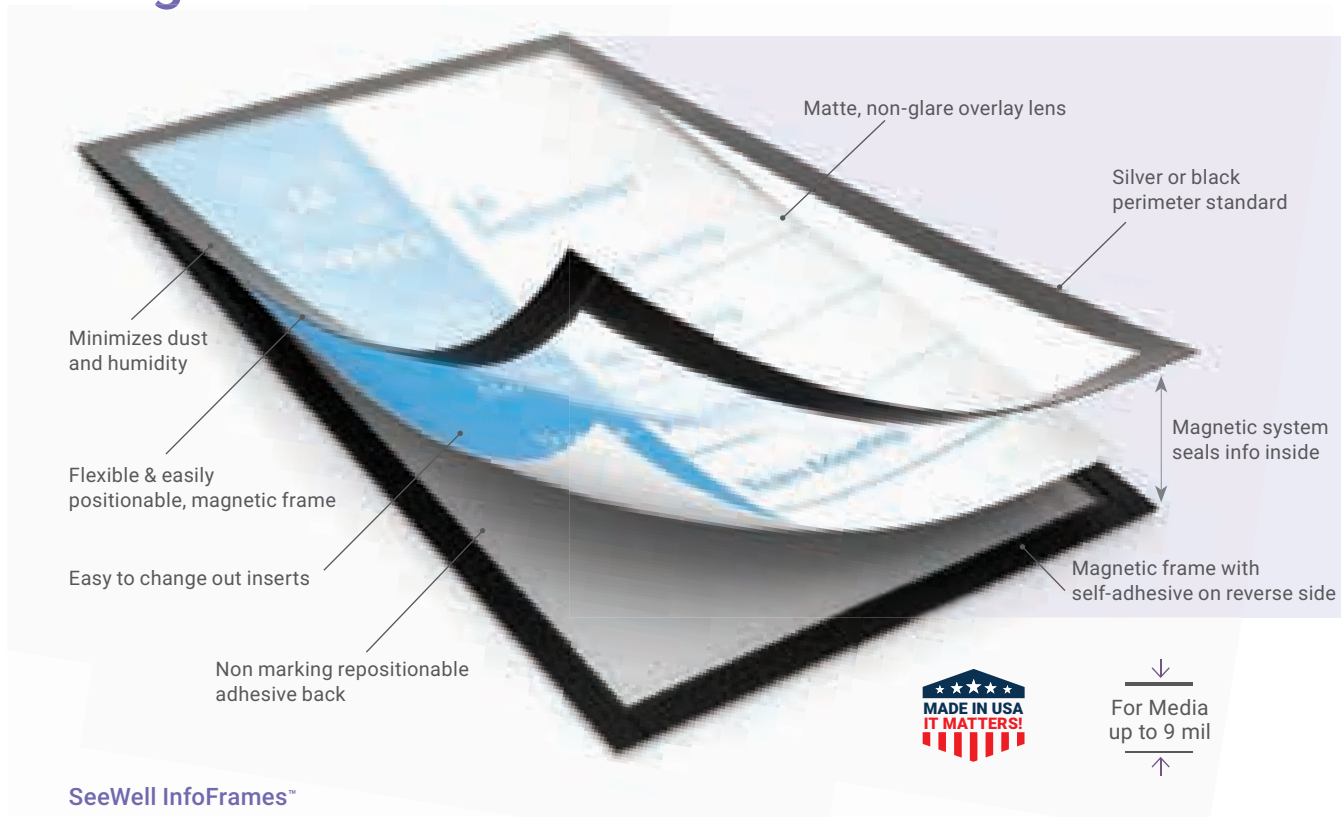

Specify: Model – Color* *Doesn't affect price

Model	Graphic Size	Color*
IFO1	8-1/2" x 11"	-S Satin Silver
IFO3	11" x 17"	-B Matte Black
IFO4	14" x 22"	
IFO7	22 x 28"	
With Magnetic Backs		
IFO1MB	8-1/2" x 11"	Magnetic Strips attach to steel surfaces
IFO3MB	11" x 17"	
With Fabric Tape		
IFO1FT	8-1/2" x 11"	Special tape attaches to fabric surfaces
IFO3FT	11" x 17"	



↓
For Media
up to 9 mil
↑

Notices • Information • Wayfinding

SeeWell InfoFrames™

- Fast instant information sheet change-outs
- Pressure sensitive non-marking and repositionable adhesive back
- Non glare overlay top lens is hinged, simply lift to open
- Use vertically or horizontally
- Clear lens with a handsome silver or black border
- Clever magnetic perimeter holds notices and allows for storage of others underneath
- The hermetically magnetic closure insures the signage stays clean away from dirt and germs
- SeeWell InfoFrames empower branding and communication

Customize to your needs!

Custom colors and design requests encouraged, as availability is fast, process easy, and the pricing is sharp.

Branded Custom Borders Available

Please Note: If insert arrives rolled in a tube, reverse roll to flatten prior to inserting into the Frames. Max thickness, 80 lb. text stock (9mil.)

SeeWell InfoFrames™

Magnetic

SeeWell InfoFrames™: signing opportunities are everywhere.



Easily display your current programs, promotions or updates. Great for office environments.



Great for:

Retail	Schools	Doors, Windows, Walls
Offices	Hotels	Egress Routing
Manufacturing	Hallways	Notices & Warnings
Distribution Centers	Directories	Specials of the Day
Car Dealerships	Banks	Urgent Care Centers
Supermarkets	Reception Areas	Dispensaries
Deli Counters	Exhibit Cases	Cabinet Sides

Double sided viewing on glass doors and windows

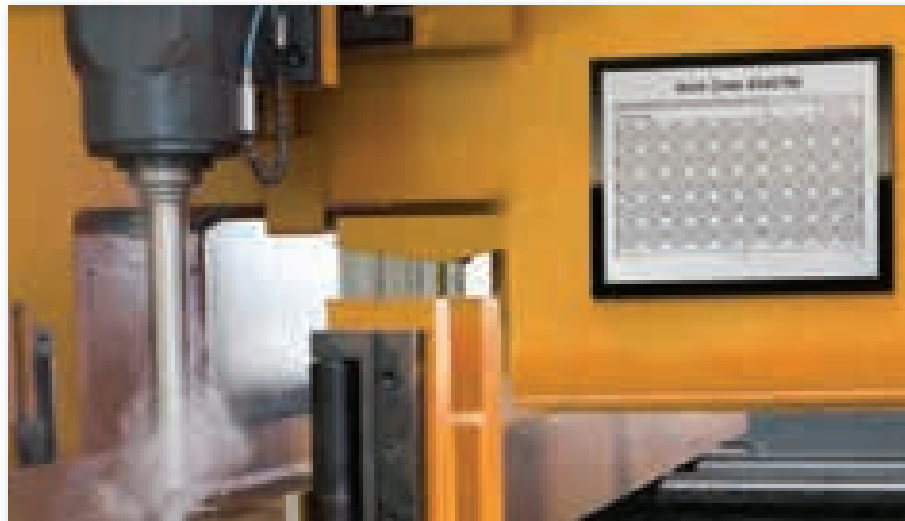

Use for Wayfinding, Events, Information, Security, Product Identification, Food Service, Supermarkets, Hospitality, Large Venues and Facilities.

SeeWell InfoFrames™

Magnetic

Ultra Low Price Points!



Units ship completely assembled, individually bagged, bulk packed.

Standard Mount

Self Adhesive back, repositionable without messy residue

Magnetic Mount

Mount InfoFrames on any steel surface

Fabric Mount

Mount InfoFrames to fabric walls

- Uses standard paper sizes
- Outrageously efficient communicators
- Fast sheet change-outs!



Customize borders, imprint your Logo, color or design. (minimum quantities apply)

Easy to change out inserts

Magnetic frame with self-adhesive on reverse side

Simply lift and insert your message

Use to Display, Present - Inform - Protect

Double-sided viewing, repositionable, reusable non-marking adhesive.

Standard Sizes

US Letter	8.5" x 11"
Tabloid	11" x 17"
Small Poster	14" x 22"
Standard Poster	22" x 28"



IMPRINTABLE

SeeWell InfoFrames™ are crafted in the USA and therefore custom designs, logos, sizes and other customizations are possible in quantity. Please inquire.



Custom Signage Board
Minimum volume applies.

SeeWell InfoFrames™
Magnetic

“The ability to put the signing where we need it can be crucial”

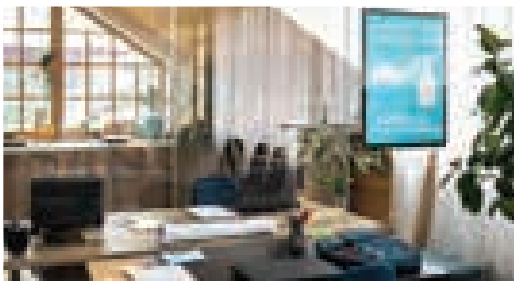

Double LL Mounts™ CounterTop

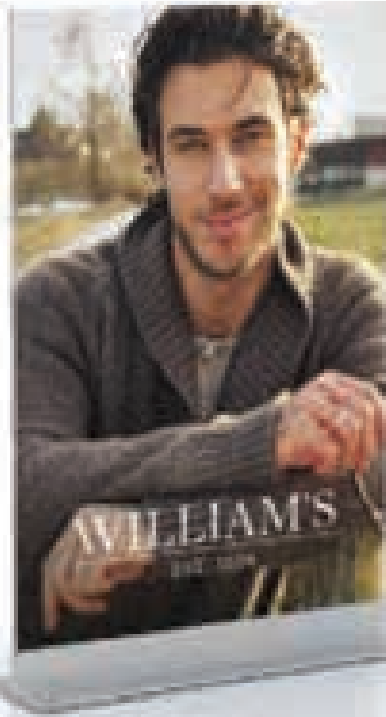

Effective Signing Mounts

- Heavy gauge solid steel
- Welded construction
- Texture powder coated finish
- 2-1/2" Wide x 1" High
- Non skid, non marking pads
- Rounded corners
- Polybagged, bulk packed

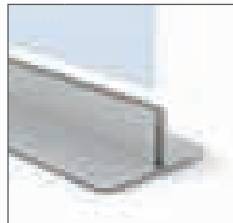

Graphic simply drops into receiving track

3/16" Graphic Track

Model	Track Length
LLT85-316	8-1/2"
LLT11-316	11"
LLT14-316	14"
LLT17-316	17"
LLT24-316	24"
LLT30-316	30"

Comes fully assembled,
no tools required



1/4" Graphic Track

Model	Track Length
LLT85-14	8-1/2"
LLT11-14	11"
LLT14-14	14"
LLT17-14	17"
LLT24-14	24"
LLT30-14	30"

Specify: Size — Color -S Satin Silver or -B Matte Black

Redesigned!



Sleek modern design



Matte black and satin silver are our standard color choices, but we can match most PMS specified colors

Customization ideas

Choices include custom

- Lengths
- Color matches
- Multiple track units for layering effects



Adjustable CounterTop Double LL Mounts

- Accepts all self standing media up to 1/2" thick
- Steel construction
- 2.5" Deep x 1" High
- Powder coated finishes
- Tremendous flexibility

Adjustable screws accommodate up to half inch thick media

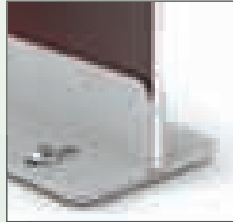

Model	Length
ALLT85	8-1/2"
ALLT11	11"
ALLT14	14"
ALLT17	17"
ALLT24	24"
ALLT30	30"

ALLT85-S

ALLT17-S

Color* -S Satin Silver or -B Matte Black 

SUPER CLICK Mounts™

- Aluminum extruded shapes
- Snap open to hold graphics
- Accepts 1/32" to 3/16" thick
- Smart satin finishes
- 3-1/4" Wide x 1" High
- Polybagged, Bulk packed



IMPRINTABLE

Model	Length
SCM35	3-1/2"
SCM55	5-1/2"
SCM7	7"



Spring loaded Simple open & close design 3-1/4" deep, 1" high.

Model	Length	Color*
SCM85	8-1/2"	-S Satin Silver
SCM11	11"	-B Matte Black
SCM14	14"	

Mini Mightee Mounts

- Steel base holds rigid graphics up to 3/16" thick. 12" long
- Polybagged, Bulk packed
- Floor Mightee Mounts available in the [Rigid Graphic Stand](#) section

Model	Length	Wt.
MM12	12"	1.5 lbs.

Color*
-S Satin Silver
-B Matte Black



Simple two screw connection. 3-3/4" deep, 1-5/8" high.

Small displays can deliver **BIG** results!

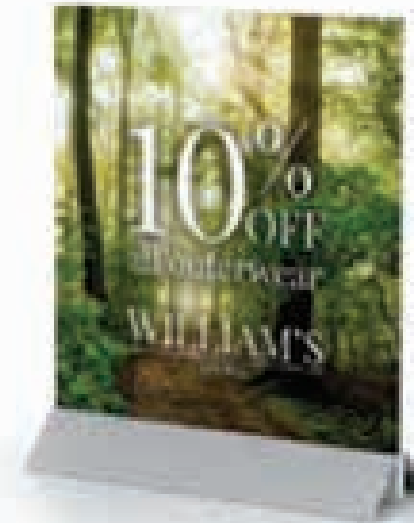

TableTop Tension Fabric Display

CounterTop



Curved Models

- Sturdy center support pole
- Gently radiused corners
- Aluminum construction
- Affordable, portable
- Effective merchandising

Model	Height
TBC693	36" high
TBC694	48" high
EBGH	Accessory Bag
Curved Models: 68" wide, 19" deep, 80-5/8" Lineal Length.	

Quick tool - free assembly
Designed for Pillowcase Graphics

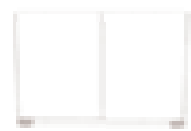

Straight Models

- Designed for pillowcase graphics
- Lightweight, strong aluminum frames
- 69" w, two 6-3/4" round bases

Model	Height	Graphic Ht.
TBS3	36" high	35"
TBS4	48" high	47"
EBGH	Accessory Bag	

Swage & spring button, tool-free coded assembly.

Sturdy Metal Construction

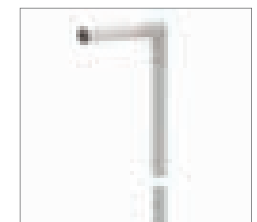
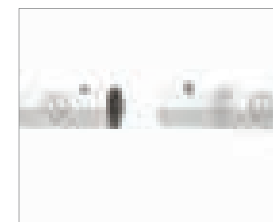

TableTop Exhibit CounterTop

PVT - Show & Tell

Tri and quad panel tabletop displays



Clamp-On SignHolders

- Clamps to tables up to 2-1/2" thick
- Adjustable heights 24" to 42" high

Model

VCCT Aluminum Clamp.

Grips up to 1/2" graphics



Model

CTMD Plastic Sign Clip.

Grips up to 1/2" graphics

CTMD

Ask about our
Custom Printed Table Covers.

COH1 Telescopic Clamp-On Header Kit

Fits 6' or 8' wide Tables

- 2 Table clamps open to 2-1/2"
- 2 Telescopic clear anodized uprights
- Ideal for hemmed banners
- 2 Crossbars telescope from 70" to 96" good for 6' or 8' wide tables. Bottom crossbar snaps on anywhere along upright



PVT TableTop Displays

- Holding rigid & semi rigid media
- .040" styrene is perfect - and it rolls
- Unit includes uprights, bases and clips
- Graphics determine panel widths
- Matte silver finish for .020" to .187" media

Model	Upright	Clips	Holds
PVT1	4 - 24" High	12	3 panels
PVT2	5 - 24" High	16	4 panels
PVT3	4 - 36" High	12	3 panels
PVT4	5 - 36" High	16	4 panels

CounterTop Wire SignHolders™

CounterTop



All CounterTop Stands are bulk packed.

All metal units Bases have felt bottoms

Specify: Pole* – Base* – Neck* – Color*

Pole*	Base*
SC1 8" height	-RD 3-1/4" round
SC2 18" height	-SQ 4" square
SC5 14" - 24" telescopic	

Neck*	Specify Finish*
-A Angle	-S Satin Silver
-G Gooseneck	-B Matte Black
-ST Straight	*Doesn't affect price.

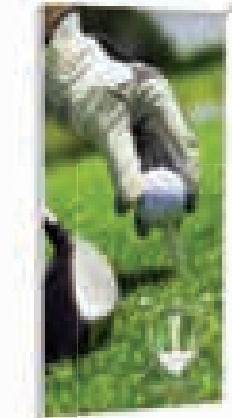

MS919-S

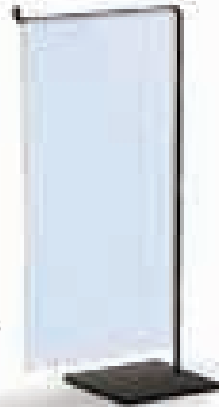

MS613-B

Mini Wire Banner Stands

Color*

- Weighted steel bases with felt bottoms
- Welded all metal construction.
- 1/4" wires with turned up ends

-S Satin Silver

-B Matte Black

*Doesn't affect price.

Model	Banner Width	Wire Height	Steel Base
MS613	6"	13"	4" x 4"
MS619	6"	19"	4" x 4"
MS919	9"	19"	6" x 4"
MS925	9"	25"	6" x 4"
MS1225	12"	25"	6" x 4"

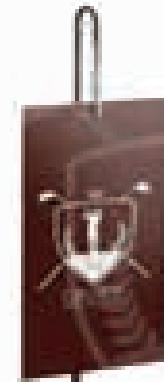

SC5-G-RD-B



SC1-ST-SQ-S

Mini Clip SignHolders

- All metal units
- Bases have felt bottoms
- 1/4" wires with turned up ends

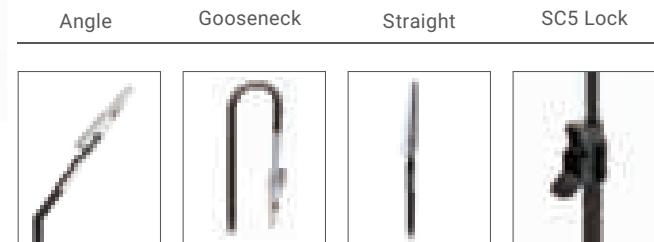

WL2

WL3



Model*

WL2 6" high

WL3 12" high

Color

-S Satin Silver

Wire Loop Holders

- Metal loops
- 3-1/4" round metal bases

Custom (minimum quantities)



WireForm CounterTop Stands™

CounterTop

Wireform Fabric Pillowcase Stands

- Use dye sublimated fabric graphics on these economical stands.
- Simple slip over and on, Double sided impact.
- All metal, welded, matte black, fully assembled.

Model	Graphic Size
WFPC1117	11" W x 17" h
WFPC1422	14" W x 22" h

All CounterTop Stands are bulk packed.



Customize for your needs!

Custom requests whether for size, color or other aspect are encouraged.



Wireform Flip Ring Stands

- Use semi-rigid graphics with holes on these economical stands.
- Use a single graphic or multiple ones and "flip" from one hanging graphic to another.
- All metal, welded, matte black, 1" silver rings, fully assembled.

Model	Graphic Size	Rings
WFFR57	5" w x 7" h	2
WFFR8511	8-1/2" w x 11" h	2
WFFR1185	11" w x 8-1/2" h	3
WFFR114	11" w x 4" h	3

Wireform J Hook Stands

- Use semi-rigid graphics with holes on these economical stands
- Simply hang punched graphics from hooks
Double sided impact
- All metal, welded, matte black, fully assembled

Model	Graphic Size	J hook centers
WFJH1117	11" w x 17" h	5-1/2"
WFJH2217	22" w x 17" h	11"
WFJH3614	36" w x 14" h	18"



Metal Shelf Talkers™

CounterTop

Metal Shelf Talkers

Communicate your message where it is most effective
> near the product being offered.

Side Load

- Slim 3/16" border top and bottom
- Individually poly bagged, bulk packed
- Economically priced
- Matte black powder coated
- Accommodates 1/16" graphics

Model	Graphic Size
KRE1	7" w x 2" h
KRE2	8-1/2" w x 2" h
KRE3	11" w x 2" h



Good design combined with the strength and sturdiness of real metal.



KRE3



KRE series features:
Extraordinary Strength.
Open sides.



KRS1

Top Load

- Accommodates 5/16" graphics
- Full metal frame on four sides
- Matte black powder coated
- Electrically welded
- Individually poly bagged, bulk packed

KRS series features:
Extraordinary Strength.
Room for seasonal signs.

Model	Graphic Size
KRS1	7" w x 2" h
KRS2	8-1/2" w x 2" h
KRS3	11" w x 2" h
Color 	
-B	Matte Black



Round Base PERFEX™ Frames

- 6-3/4" round base with felt bottoms
- 4" riser, 3/16" top loading
- Aluminum frame, satin finishes

Custom sizes available

Orientation*

-H Horizontal

-V Vertical

*Doesn't affect price



PX1T-V-S

Rectangular Base PERFEX™ Frames

- 3/16" top loading aluminum frame
- Steel base, felt feet
- Satin finishes

Orientation*

-H Horizontal

-V Vertical

*Doesn't affect price

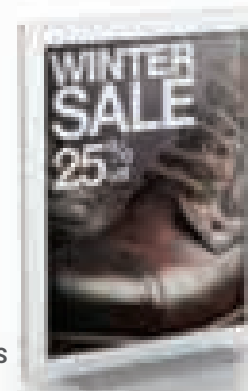

PX2R-V-S

Landscape PERFEX™ Frames



- Full width Steel base, felt feet
- 4" riser, 3/16" side loading
- Aluminum frame, matte satin finishes



PX1L-H-S



Panda

- All Aluminum
- Top load 3/16" slot
- Beautiful satin finishes



PXH8511-S



PXH117-WHL-S

Specify: Size* — Color* -S Satin Silver or -B Matte Black

Round Base PERFEX™ Frames

Model	Size
PX1T	8-1/2" x 11"
PX2T	11" x 14"
PX3T	11" x 17"

Rectangular Base PERFEX™ Frames

Model	Size	Base
PX1R	8-1/2" x 11"	4" x 6"
PX2R	11" x 14"	4" x 8"
PX3R	11" x 17"	4" x 8"
PX4R	14" x 22"	4" x 12"

Landscape PERFEX™ Frames

Model	Size	Base
PX1L	24" x 8"	4" x 24"
PX2L	36" x 8"	4" x 36"
PX3L	48" x 8"	4" x 48"

Panda

Model	Size	Base
PXH8511	8-1/2" x 11"	Non-rollable
PXH1114	11" x 17"	Non-rollable
PXH8511-WHL	8-1/2" x 11"	Rollable
PXH1117-WHL	11" x 17"	Rollable

Banner Stands

CounterTop



Side by Side
CT26-S



Cantilevered
CTV6-S

CT Banner Stands

- Classic styling
- Telescopic uprights 24" - 42"
- Satin matte finishes
- Faceout ends hold banners
- 3/8" diameter dowels
- 8" square, felt bottom bases

Side by Side

Model	Dowels
CT26	6" Dowels
CT29	9" Dowels
CT212	12" Dowels
CT218	18" Dowels

Cantilevered

Model	Dowels
CTV6	6" Dowels
CTV9	9" Dowels
CTV12	12" Dowels
CTV15	15" Dowels

Color*



-S Satin Silver

-B Matte Black

*Doesn't affect price

Telescopic CounterTop Banner Stands

- Adjustable to 42" high.
- Individually boxed.

IMPRINTABLE



All three stands on this page
feature Trouble-free lock

Trouble-free lock allows
quick height adjustments.

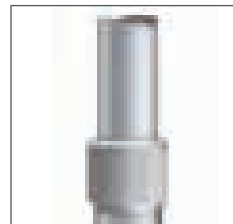

BN1-B

Classic Banner Stands

- 8" square base
- 1/2" diameter dowels
- Holds 1 or 2 banners
- 12" dowels back to back
- 12" wide banners
- 24" - 42" telescopic height

Model Telescopic Height

BN1 24" - 42"

Color*



-S Satin Silver

-B Matte Black

*Doesn't affect price

SignHolders

CounterTop

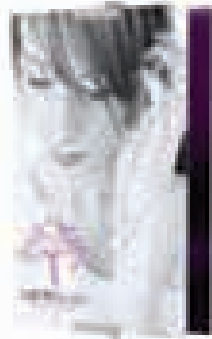

CTSE2-SQ-S

Sign Easels

- Holds placards and signs up to 1/4" thick
- Single or double sided display
- 3/4" x 28" fixed height upright
- Sliding holders carry different height signs

Model

CTSE1	One sided sign easel
CTSE2	Two sided sign easel

Specify Base*

-RD 6-3/4" Round

-SQ 8" Square

*Doesn't affect price

Specify Color*

-S Satin Silver

-B Matte Black

*Doesn't affect price

Fast, easy assembly.
All metal. Units are polybagged and bulk packed.

TableTop Easels

- Aluminum construction.
- Fits compactly into art boxes.
- 145S has a 1/2" X 9" shelf.
- Ht. 13", Wt. 6 ozs.

Model

145

145S



Model

151 School & Sign

Model

152 School & Sign

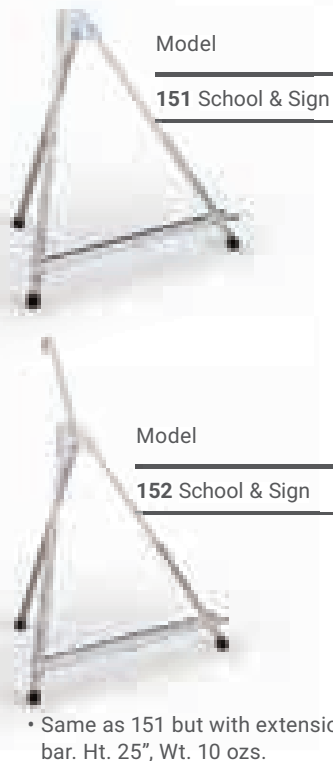

Model

180 Classic Ideal
for Art Classes

- Sturdy and rigid.
- For canvases and signs up to 26" high. 12" wide shelf.
- Handle for carrying.
- Assemble in minutes. Ht. 31", Wt. 1 lb.

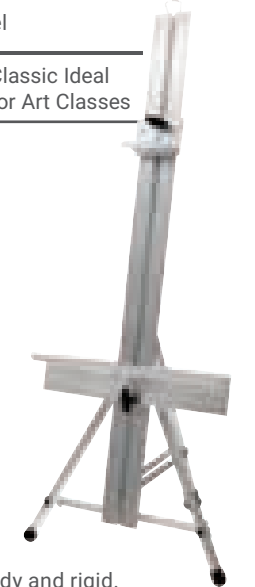

CounterTop Standee

- Use single or double sided
- Hook/loop holds graphic
- Great for Styrene graphics
- Steel base, aluminum uprights

Model

VEEM812	8"w x 12"h
VEEM818	8"w x 18"h
VEEM1218	12"w x 18"h
VEEM1224	12"w x 24"h

Specify Color*

-S Satin Silver

-B Matte Black

*Doesn't affect price



VEEM812-S



VEEM1224-S

Visual Signing Clamps™

CounterTop

Solid Aluminum Signing Clamps

- Solid aluminum alloy
- 1-1/4" w x 2" h
- Anodized satin finishes
- Clever binder spring

↓
Grip range up to
1/2" thick
↑

Single Clamp Stands

- Telescopic or fixed height
- 4" Square Base

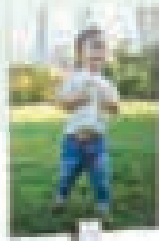

VCMT-E-S
15" - 24" Telescopic clamp stand

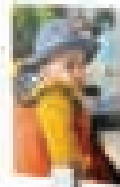

VCMST-S
12" Fixed height clamp stand

Double Clamp Stands

- 28" tall upright
- Adjustable up & down
- **VCMCT2** Two sided clamp stand



VCMCT1-S
One sided clamp stand

Specify: Color* **-S** Satin Silver or **-B** Matte Black

Solid Aluminum Signing Magnetic and Mini Clamps

- 1-1/4" w x 2" h
- 1-1/2" O.D. magnet with 15 pound rated pull strength
- 4" long stem
- Clever binder spring
- Sits on table top, or display
- Use anywhere

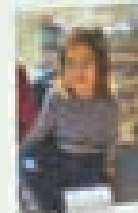

VCMMG-S

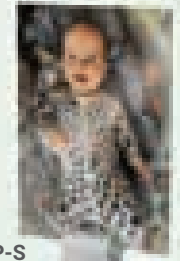

VCMT-P-S

Model

VCMMG Magnetic Clamp SignHolder

VCMT-P Mini Clamp SignHolder

Double Clamp-On SignHolder



VCMDB-S

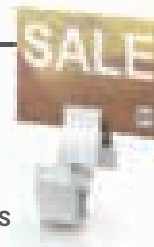

Model

VCMDB Clamps are riveted together and pivot

VCM6D 6" Rod Separator

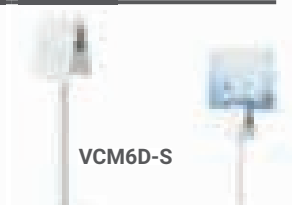

VCM6D-S

Specify: Color* **-S** Satin Silver or **-B** Matte Black

MINI Visual Signing Clamps™

2" height



VCMT-P
Mini Clamp use for small signs.



VCMCD
Mini Clamp with eye hook for drops.



VCMMT
Mini Clamp with 1/4-20 thread.



VCMWM
Mini Clamp with hole for mounting.



VCMSW
Mini Clamp with slot wall bracket.

Visual Signing Clamps™

CounterTop

Solid Aluminum Signing Clamps

- Solid aluminum alloy
 - 2" w x 3" h, rubber grips
 - Anodized satin finishes
 - Clever binder spring
- Grip range up to 1/2" thick

Model **Table Top**

VCCT Clamps onto tables up to 2-1/2" thick.

VCTP (2) Table Top Clamps

Specify Color* 

-S Satin Silver

-B Matte Black

*Doesn't affect price

IMPRINTABLE



(2) **VCTP**
Table Top

VCCT
Adjustable
24"- 42" h.



VCDP

- Steel grid clip, telescopic tube 20"- 36". Aluminum clamp included



Model **Hanging**

VCDP Steel grid clip

VCWM Wall Mount

VCCD Ceiling Hung

VCWM



VCCD

FULL SIZE Visual Signing Clamps™

3" height



VCTP
Clamp only,
use on table top,
or for small signs.



VCMT
Clamp with male
1/4-20 thread,
multifunctional.



VCWS
Clamp with
integral slot wall
bracket included.



VCWM
Features hole
for mounting
parallel on a wall.



VCCD
Clamp has
integral eye hook
for ceiling drops.

Eclipse SignHolder™

CounterTop

Great for retail signage, food service, hospitality, product identification, prices, instructions, promotional messages, and more.



Accepts standard paper thicknesses.



Eclipse Tabletop SignHolders™

- All metal modern construction
- Custom sizes available
- Includes a non reflective lens

Simply place your printed graphics behind the supplied lens.

Specify: Color* -S Satin Silver or -B Matte Black



Models TC1 thru TC3 made from a solid aluminum extrusion.

Model	Pcs. Per	W" x H" (Insert Size)
TC1	12	1" x 3/4"
TC2	5	3-1/2" x 2"
TC3	5	8" x 2"



Larger Models TC8 thru TC11, welded construction

Model	Apiece	W" x H" (Insert Size)
TC8	Each	11" x 8-1/2"
TC9	Each	8-1/2" x 11"
TC10	Each	14" x 11"
TC11	Each	11" x 14"

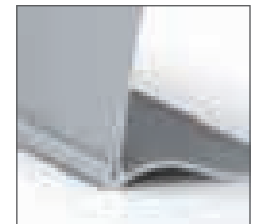

ArcTop SignHolders™ CounterTop

Custom sizes and
colors available



ArcTop SignHolders™

- Aluminum alloy bases
- Handsome satin finishes
- Elegant, contemporary design
- Individually polybagged / bulk packed

Model*	Graphic W" x H"
AT01	7" x 5-1/2"
AT02	5-1/2" x 7"
AT03	11" x 7"
AT04	7" x 11"
AT05	11" x 8-1/2"
AT06	8-1/2" x 11"
AT07	14" x 11"
AT08	11" x 14"
AT09	17" x 11"

With acrylic fold over

For regular paper stock.
Use printers and copiers.



Specify Style*

- U Upright
- A Angled

Specify Finish*

- S Satin Silver
- B Matte Black

*Doesn't affect price, but must use to order.



IMPRINTABLE

Logo Imprinting onto our Hardware

Advanced UV Inkjet Technology / Print Directly
onto Frames and Bases



Base Only

Gripper included, use rigid & semi-rigid graphics up to 1/8" thick.

Specify: Size — Style* — Color* -S Satin Silver or -B Matte Black

Model	Width	Model	Width	Specify Style*
AT11	5-1/2"	AT14	11"	-U Upright
AT12	7"	AT15	14"	-A Angled
AT13	8-1/2"	AT16	17"	

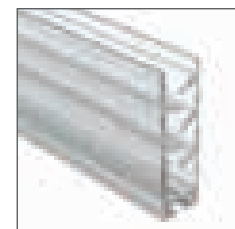

EasyGraphic Gripper accepts
rigid media up to 1/8" thick.

← Upright 4" Deep →



← Angled 4" Deep →



Wet Erase SignBacks

CounterTop

IMPRINTABLE

Logo Imprinting onto our Hardware
 Reinforce Your Branding / Advanced UV Ink jet
 Technology / Print Directly on to wet erase surface



L Backs

Model	Size (w x h)	Style	Border	Writing Surface
KSL1	5" x 5"	L Back	1/2"	4" x 4"
KSL2	8" x 10"	L Back	1/2"	7" x 9"
KSL3	11" x 14"	L Back	1/2"	10" x 13"
KSL4	11" x 17"	L Back	1/2"	10" x 16"
KSL5	18" x 12"	L Back	1"	16" x 10"
KSL6	24" x 18"	L Back	1"	22" x 16"

Chalk Wet Erase Menu Boards

- Matte black acrylic writing surface
- Satin anodized aluminum alloy back
- Use chalk markers
- Modern & contemporary
- Individually polybagged, bulk packed



Black acrylic writing surface contrasts beautifully in the satin anodized aluminum.

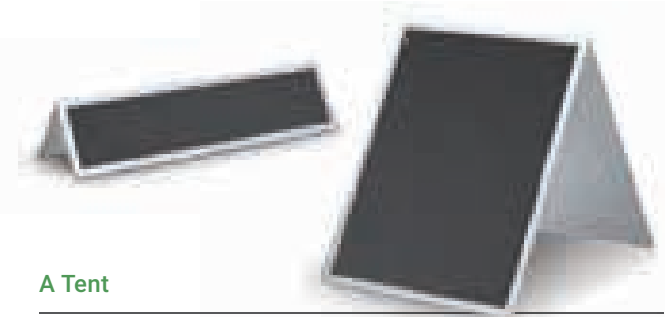

A Tent

Model	Size (w x h)	Style	Border	Writing Surface
KSA1	8" x 10"	A Tent	1/2"	7" x 9"
KSA2	11" x 14"	A Tent	1/2"	10" x 13"
KSA3	16" x 4"	A Tent	1/2"	15" x 3"

Magnetic Signbacks

CounterTop

Print on flexible media, an effective, economical countertop display option.



Magnetic CounterTop SignBacks

- Magnetic receptive surface
- Individually polybagged
- Steel backs with rounded corners
- Felt bottoms will not scratch furniture
- Custom sizes and models available in quantity

Two Great Finishes

- White Erasable with Wet or Dry Erase Markers*
- Full color digital printing on fascia available
- Matte Black Erasable with Wet Erase Markers*
- Specify quantity for quotation

Write on with Wet or Dry Erase Markers*



Write on with Wet or Dry Erase Markers*

Write on with Wet Erase Markers*

Slant Backs

White Erasable	Size (w x h)	Black Erasable	White Erasable	Size (w x h)	Black Erasable
KW1	8-1/2" x 11"	KB1	KW6	17" x 11"	KB6
KW2	11" x 8-1/2"	KB2	KW7	3-1/2" x 5-1/2"	KB7
KW3	11" x 14"	KB3	KW8	5-1/2" x 3-1/2"	KB8
KW4	14" x 11"	KB4	KW9	5-1/2" x 7"	KB9
KW5	11" x 17"	KB5	KW0	7" x 5-1/2"	KB0

*Erasability varies with the chemical composition of the markers.

IMPRINTABLE

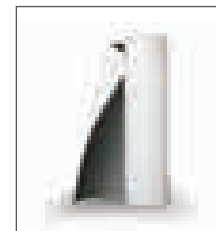

Print directly on flexible magnetic sheets

Tent Backs

White Erasable	Size (w x h)	Black Erasable
KTW1	3" x 2"	KTB1
KTW2	5-1/2" x 3-1/2"	KTB2
KTW3	7" x 5-1/2"	KTB3
KTW4	5-1/2" x 7"	KTB4
KTW5	11" x 8-1/2"	KTB5
KTW6	8-1/2" x 11"	KTB6

Paper/Card Stock SignBacks

CounterTop



↓
For Media
up to 1/16"
↑

Welded steel frames offer strength and durability at value price points.



Telescopic
Option



Telescopic
Option

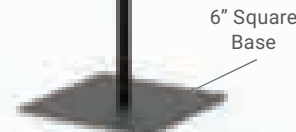

SB31-X-H-Q



SB41-T-V-W



SB41-T-H-L

All Metal SignBacks

- Accepts card stock up to 1/16" thick
- Size, orientation & upright choices
- Individually polybagged
- Heavy Steel Backs
- Matte black finish

Specify: Graphic Size – Single or double sided – Stem – Orientation* – Base* – *Does not affect price | Color -B Matte Black

Model	Size (w x h)	Single or Double Sided	Stem	Orientation*	Base*
SB3	8-1/2" x 11"	1 Single Sided	-X Fixed 18"	-H Horizontal	-Q 6" Square
SB4	11" x 14"	2 Double Sided	-T Telescopic 11" to 18"	-V Vertical	-L 4" x 7" Shovel
SB5	11" x 17"				-W 4" Square screw down

Paper/Card Stock SignBacks

CounterTop

Countertop SignBacks

- Full width bases
- Thin side rails
- Vertically oriented
- Top loading
- Steel constructed
- Polybagged, bulk packed

Steel constructed



Model	Graphic Size
SBC1	3"w x 7"h
SBC3	8-1/2"w x 11"h
SBC4	11"w x 14"h
SBC5	11"w x 17"h

Single or Double Sided	
1	Single Sided
2	Double Sided



Specify: Graphic Size — Single or double sided | Color -B Matte Black

All Metal SignBacks

- Four display styles
- Thin side rails
- Matte black powder coated
- Individually polybagged, bulk packed

Aluminum constructed



Four Common Options

Magnetic mount riveted on:

SBM1	11"w x 3-1/2"h
SBM2	11"w x 7"h



Hang over bins: (1-1/4" I.D.):

SBH1	11"w x 3-1/2"h
SBH2	11"w x 7"h

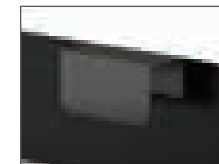

Affix to price channel (Madix):

SBP1	11"w x 3-1/2"h
SBP2	11"w x 7"h



Stack out shovel bases:

SB01	11"w x 3-1/2"h
SB02	11"w x 7"h



Perfect for the supermarket industry



Very small, 3/16" margin

Pedestal Framettes™

CounterTop

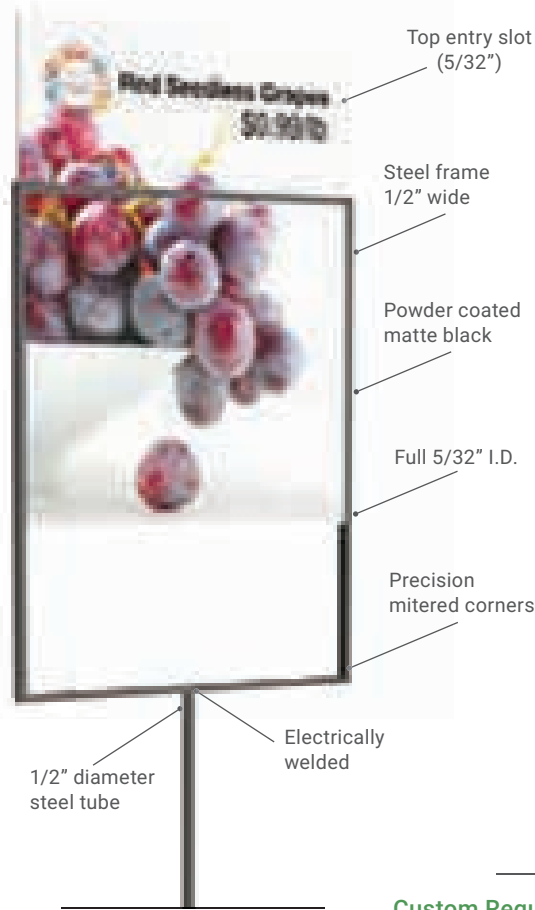

Custom Requests Encouraged.



6" Square Base

FT5-X-H-Q

↓
For Media
up to 5/32"
↑



Welded **steel** frames offer strength and durability at value price points.

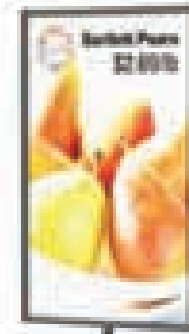

4" Square Screw down Base

FT3-X-V-W



Telescopic Option

Shovel Base

FT4-T-H-L

Pedestal Framettes™

- 5/32" inside dimensional frames, top entry slots
- All metal, satin matte black powder coated finish
- Choices include size, orientation, fixed or telescopic uprights
- All Framettes are individually poly-bagged, then bulk packed

Specify: Graphic Size – Stem – Orientation* – Base* – *Does not affect price | Color -B Matte Black

Model	Frame Size	Stem	Orientation*	Base*
FT3	7" x 11"	-X Fixed 12"	-H Horizontal	-Q 6" Square
FT4	8-1/2" x 11"	-T Telescopic 11" to 18"	-V Vertical	-L 4" x 7" Shovel
FT5	11" x 14"			-W 4" Square screw down

CounterTop Framettes options



CounterTop Framettes™

• Great for general countertop use.

Model	Frame Size
FTTP1	7" x 11"
FTTP2	8-1/2" x 11"
FTTP3	11" x 14"

Specify Orientation*

- H Horizontal
- V Vertical

All Metal!



CounterTop Framettes™ with Standoffs

• Full width bases with felt bottoms, 4" high stand-offs.

Model	Frame Size
FTVM1	7" x 11"
FTVM2	8-1/2" x 11"
FTVM3	11" x 14"

Specify Orientation*

- H Horizontal
- V Vertical

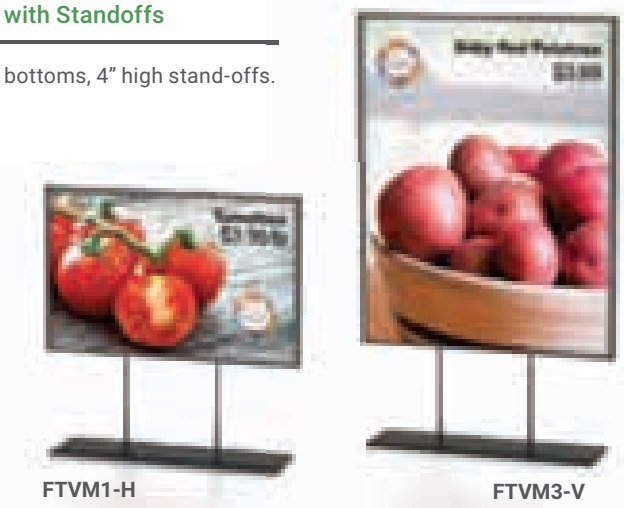

Mounting Framettes™

CounterTop

Magnetic Framettes™

- Strong channel magnet, 2-3/4" wide, 25 lb. rated pull strength
- Matte black finish

FTMB3-V

Model	Frame Size	Specify Orientation*
FTMB1	7" x 11"	-H Horizontal
FTMB2	8-1/2" x 11"	-V Vertical
FTMB3	11" x 14"	

Wall Mount Framettes™

- Welded tabs, top loading
- Wall hardware included
- Wall mount units
- Removable foam tape

FTWM2-V **FTWF1-H**

Model	Frame Size	Model	Frame Size
FTWM1	7" x 11"	FTWF1	7" x 11"
FTWM2	8-1/2" x 11"	FTWF2	8-1/2" x 11"
FTWM3	11" x 14"	FTWF3	11" x 14"

Slatwall Framettes™

- Metal "Z" brackets electrically welded. Fits standard slatwall.

FTSW3-H

Model	Frame Size
FTSW1	7" x 11"
FTSW2	8-1/2" x 11"
FTSW3	11" x 14"

Specify: Orientation*-H –Horizontal, -V –Vertical

Clamp Base Framettes™

- Clamps to flat or round surfaces
- Has a grip range of 2-1/4" open

Non Telescopic Models

• 12" high pole

Model	Frame Size
FTCX1	7" x 11"
FTCX2	8-1/2" x 11"
FTCX3	11" x 14"

Telescopic Pole Models

• 11" closed, 18" open

Model	Frame Size
FTCT1	7" x 11"
FTCT2	8-1/2" x 11"
FTCT3	11" x 14"



Specify: Orientation*-H –Horizontal, -V –Vertical



Custom Framettes™ CounterTop

Custom Framette Options

- Frame sizes
- Bases
- Swivels
- Stand-offs
- Clamps
- Mounts
- Brackets
- Colors

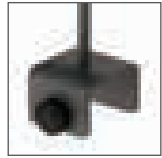

Clamp-on Mount



Flange Mount

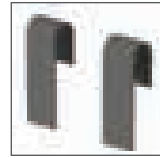

Hanging Brackets

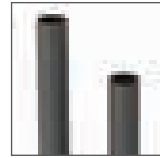

Stand-Offs

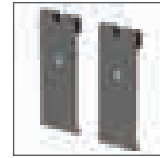

Wire Grid Mount

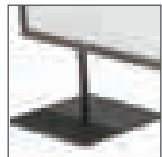

Square Base

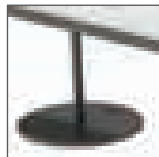

Round Base



Magnetic Mounts



Telescopic Stand-Off



Slatwall Mounts

Custom Brackets

- Contact our friendly sales staff to discuss your custom project

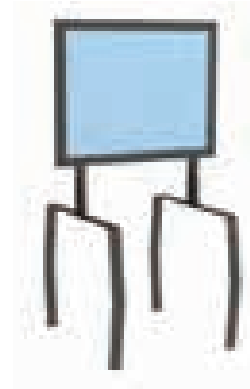

Custom Colors

- Powder coating from Speckles to designer shades to close RAL & Pantone matches available

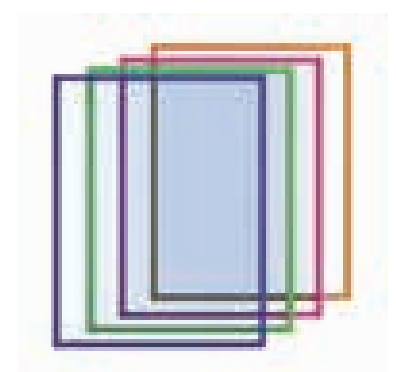

The strength and durability of
powder coated welded steel



Stellar Aisle Markers™

CounterTop



Perfect for:
Supermarkets
Big Box Stores
Pharmacies
Retail Environments



Stellar Aisle Markers™

- Stellar Aisle Markers made to order
- Material in stock, manufacturing is fast
- Custom requests encouraged!



AM101-B

Featuring:

- Strong 1/2" square steel tubing
- Handsome matte black finish
- 14" center to center J Hooks
- Variable arm & upright lengths
- Different upright & base choices
- Electrically welded construction
- J hooks for easy graphic mounting
- Single or double wing arms
- Straight or curved style arms
- Bulk Packed

Model Arm and Base Styles

AM101-B	Curved 24" arm, 9" upright, 4" square base, with mounting holes
AM102-B	Straight 24" arm, 3" upright, 4" "U" base, 2-1/2" I.D., 4 side mounting holes
AM103-B	Double 24" arms, 9" upright, 4" high "U" base, 2-1/2" I.D., 8 mounting holes
AM104-B	Straight 24" arm, 9" upright, 4" square base
AM105-B	Curved 24" arm, 5-1/2" high step upright. 6" square mount

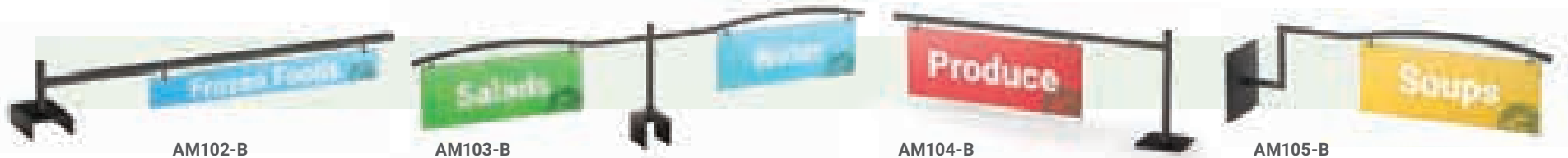

AM102-B

AM103-B

AM104-B

AM105-B

Stellar Case Markers™ CounterTop

All these options provide
two sided viewing



Attach rigid graphic with rings. Round base.



Graphic sits in channel of upright. Rectangular base.



Rigid graphic hangs from steel J hooks. Square base.



Custom Double Post Stellar Signage Stands™

Working collaboratively with our customers. We can design and produce in house what best suits your opportunity.

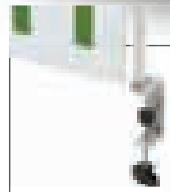

Options

- Clamp Base
- Magnetic Base
- Custom Bases

Full - Rapid Development of Custom Rollouts with Full Logistical Support. Custom Starting at Qty 25+

Hanging Graphics Hardware



Modular system.
Customize To Your Needs!



Rail Options

- Rails can be Extruded Profiles, Round or Square Shapes, cut to size and finished in virtually any color.

Rail Connections

- Hang-On Perimeter Rails can be connected in series.

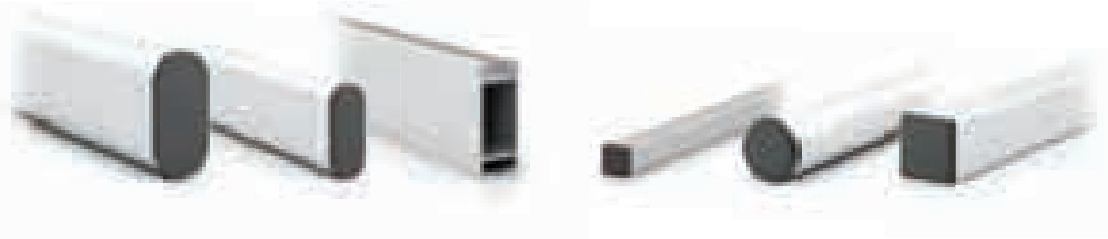

Design a Perimeter Rail
to match your visual merchandising vision

Hang-On Perimeter Rails™

Hanging Graphics Hardware

Upper and Lower Tier Perimeter Rail Systems



Double Rail System

- Allows staggering or layer effects for signage
- Rails can be Extruded Profiles, Round or Square Shapes, cut to size and finished in virtually any color.

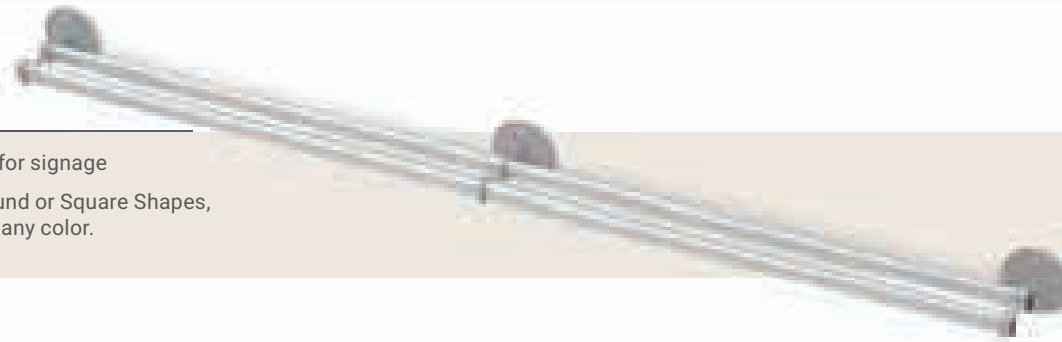

**Modular system.
Customize To Your Needs!**

Mounting Plates

- Laser cut steel electrically welded, powder coated finish.



Hangers

- Formed to hang from rail, all metal, powder coated finish.

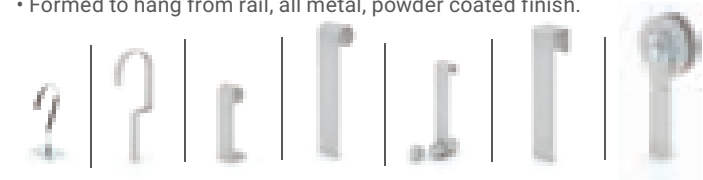

Hanging Graphics Hardware



Hanging Graphics

• Place hanging graphics anywhere along bar. Offers the versatility merchants want to be able to reposition their products.



**Modular system.
Customize To Your Needs!**

Great use for

- Sign
- Placard
- Panels
- Graphics
- Light Boxes
- Frames
- Structures
- Boards
- Mirrors
- Cubby Covers



Inexpensive Barn Door hardware available.

Valance Perimeter Rail System™

Hanging Graphics Hardware

Steel Strip

- Great for category level signing also known as lower tier rails. Using on valances is common.

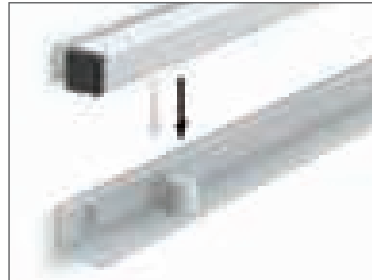

Great in store marketing signing can help to promote a cohesive store design

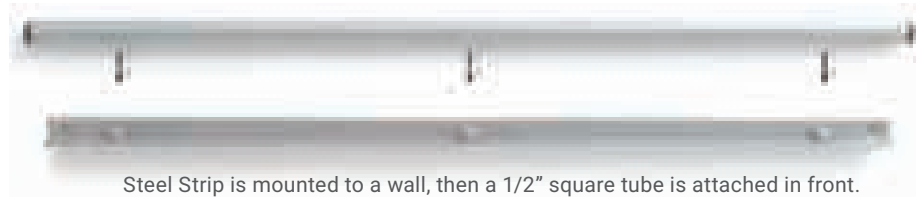

Steel Strip is mounted to a wall, then a 1/2" square tube is attached in front.



Fitting and Puck

- Attach fitting and puck to the sign and hang on rail. Sign simply sits atop rail and is movable along rail.

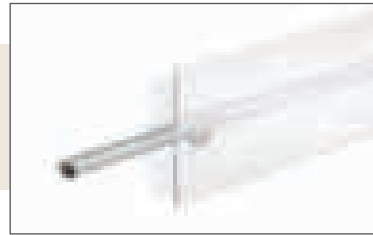
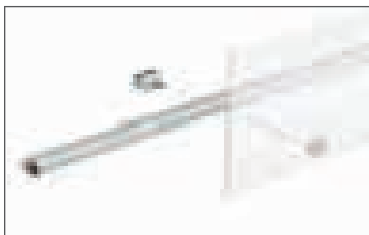

Strap, Fitting and Puck

- Attach strap, fitting and puck to the sign, then hang from rail. Hang anywhere along rail.



Hanging Graphics Hardware

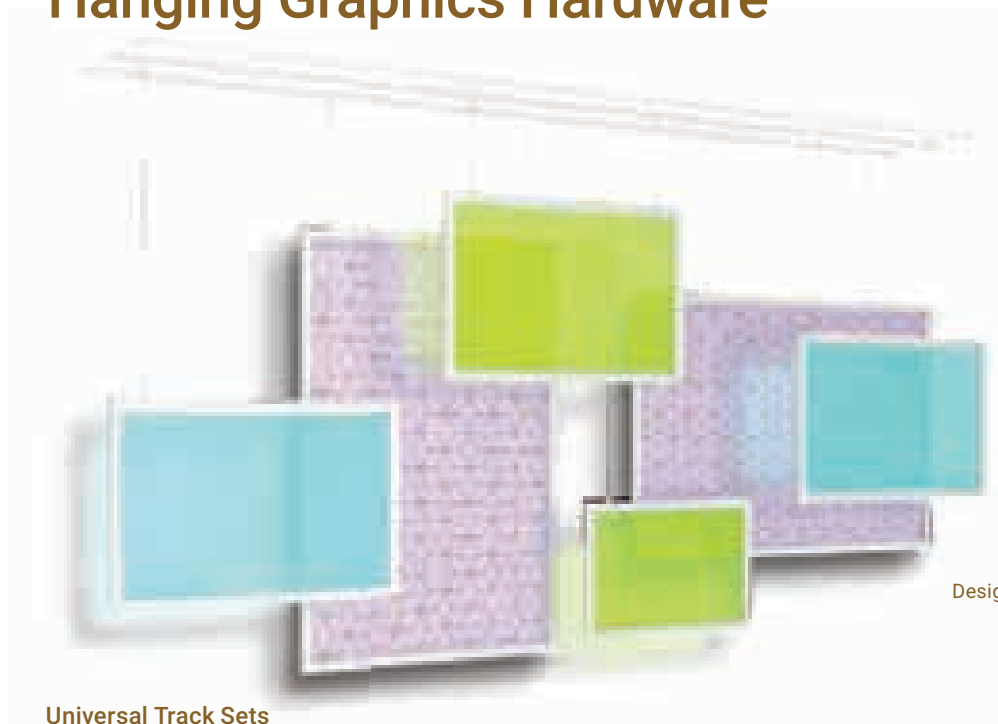

Universal Track Sets

For plaster or wood ceilings, white finish

- Aluminum alloy tracks
- Includes glide hooks.
- Hooks snap in track anywhere
- **UTS8** comes in 2 sections with joiner inside and threaded holes in top of extrusion

Model	Length	# Hangers
UTS2	24"	2
UTS4	48"	4
UTS6	72"	6
UTS8	96"	8



Glide Hook



Plaster & wood ceiling hardware

Designed to be used with plaster, wood or suspended grid ceilings



Grid Divider Universal Track Sets

For suspended drop ceilings, white finish

- Locate signage where you want
- Includes glide hooks.
- Hooks snap in track anywhere
- For 24" square tiles or 24" x 48" tiles (across the short side)

Model	Length	# Hangers
UTD	24"	2

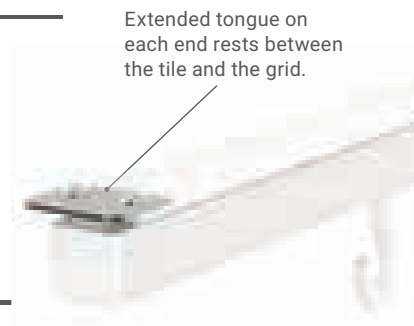

Extended tongue on each end rests between the tile and the grid.

Universal Ceiling Tracks™ Hanging Graphics Hardware

Amazing versatility of design. Change signage placements easily and often for refreshing new looks.

All rails over 93" are in 2 sections (unless customer specifies otherwise)



Suspended Rod Kits
For big box stores and others with high ceilings.

Cut rod and sheath to length, clean threaded ends with a file, mate with couplings.

Suspended Rod Kits

- 3-1/4" diameter ceiling plate
- Threaded rod with white sheath
- Two 1/4-20 steel couplings
- Steel spring clip to attach to top of Universal Ceiling Track
- White finish

Model Length *96" rod is in 2 sections with joiner

UTR48 48" Suspended Rod Kit (set of 2)

UTR96* 96" Suspended Rod Kit (set of 2)

Sliding Cross Tracks

- Aluminum 3/4" x 1" alloy track
- Clip-on intersection plates (2)
- Includes glide hooks
- Hooks snap in track anywhere
- **UTC8** in 2 sections

Model	Length	# Hangers
UTC2	24"	2
UTC4	48"	4
UTC8	96"	8

Cross Track with Connector Glide

Position perpendicular to two parallel Universal Tracks via connecting glide.

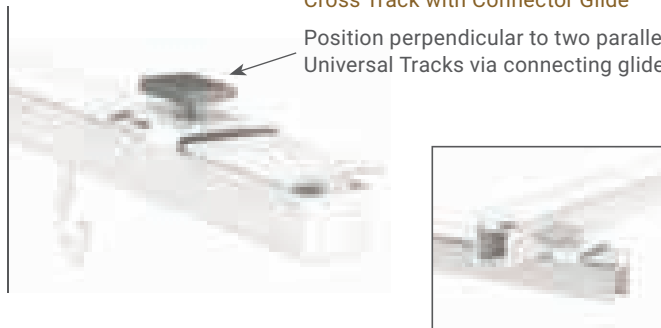

Aluminum Case Grippers

Hanging Graphics Hardware



Ingenious gripper snaps closed after graphic insertion with incredible strength, torque and care.

SnapGraphics™

- Beautifully finished aluminum case
- No end treatment required
- Designed to close easily once graphic is inserted
- Ideal for large signage, reusable
- Plastic gripper included

Sold As A Set

- Top & bottom crossbar with plastic gripper
- 2 universal hanging clips
- 4 end caps

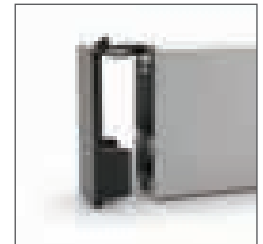
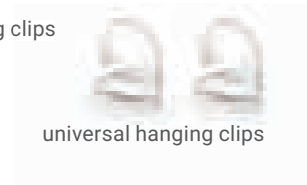

SN1, SN5
end caps have spring retention feature.



SN1 SnapGraphics
.070" capacity.

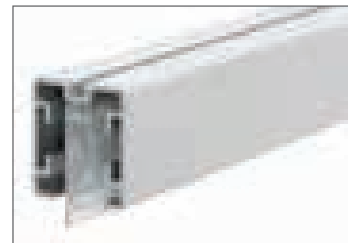

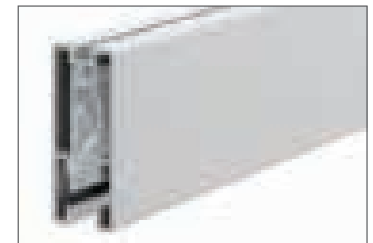

SN2 SnapGraphics
.070" capacity.



SN5 SnapGraphics
.050" capacity.

Specify: Style* – Length* – Color*

Model	Case Style	Length			Specify Finish	
		-1 - 18"	-4 - 28"	-7 - 60"		
SN1	Oval	-1 - 18"	-4 - 28"	-7 - 60"	-S	Satin Silver
SN2	Rectangular	-2 - 22"	-5 - 36"	-8 - 72"	-B	Matte Black
SN5	Slim, long rectangular	-3 - 24"	-6 - 48"	-9 - 96"		









Custom lengths available

Patented!
U.S. Utility Patent # 6,637,716
U.S. Design Patent # D-424,120

*96" long in 2 sections with joiner hardware included

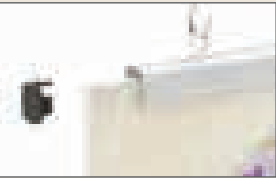
Hanging Graphics Hardware

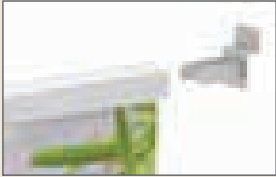
Accessories

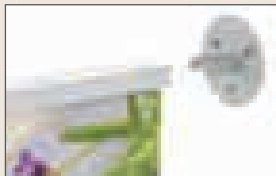
Model	Brackets		
UC180	Steel Brackets Set of 4. Allows casings to be joined in series.		
Model	Wall Mount		
UC44	Wall Mount Kit for SN1 & SN2 Set of 4.		
Model	Screw Posts		
UCSP	Aluminum Screw Posts, set of 2. Slide graphic 3/8" max. thick into casing.		
Model	Slatwall Brackets		
UCSWB	Slatwall bracket - set of 2 for 36" max. Perpendicular to wall.		
Model	Wall Mount Brackets		
UCWB	Wall Mount Bracket - set of 2, 3-1/4" diameter. For 36" maximum. Indicate -B Black or -S Silver		



Sold As A Set

- Top & bottom crossbar with plastic gripper
- 2 universal hanging clips
- 4 end caps

Patented!
 U.S. Utility Patent # 6,637,716
 U.S. Design Patent # D-424,120

HDC6

Wide variety of hanging holders available.



Stands featuring these bars are available in the **Grip Graphic Banner Stands** section pgs.151-153.

Plastic Grippers

Hanging Graphics Hardware



↓
For Media
up to .070"
↑

SnapGraphics™

- No pockets or graphic end treatment required
- Ideal for large signage. Units are reusable
- Closes easily once graphic is inserted
- Grip graphics to .70 mil (.070") thick
- Silver simulates aluminum casing

Snapgraphics™	Snapgraphics Oval™	Length
GC18	GC018	18"
GC22	GC022	22"
GC24	GC024	24"
GC28	GC028	28"
GC36	GC036	36"
GC48	GC048	48"
GC60	GC060	60"
GC72	GC072	72"
GC96	GC096	96"

Custom lengths available.

Patented!
U.S. Utility Patent # 6,637,716
U.S. Design Patent # D-424,120

GC - Snapgraphics™ Color

- C Clear blends beautifully
- B Black not for direct sunlight
- S Silver simulates aluminum

GCO - Snapgraphics Oval™ Color

- C Clear – See the full graphic
 - S Silver – Simulates aluminum
- Includes black end caps.

Sold As A Set

- Top & bottom crossbar with plastic gripper
- 2 universal hanging clips
- 4 end caps

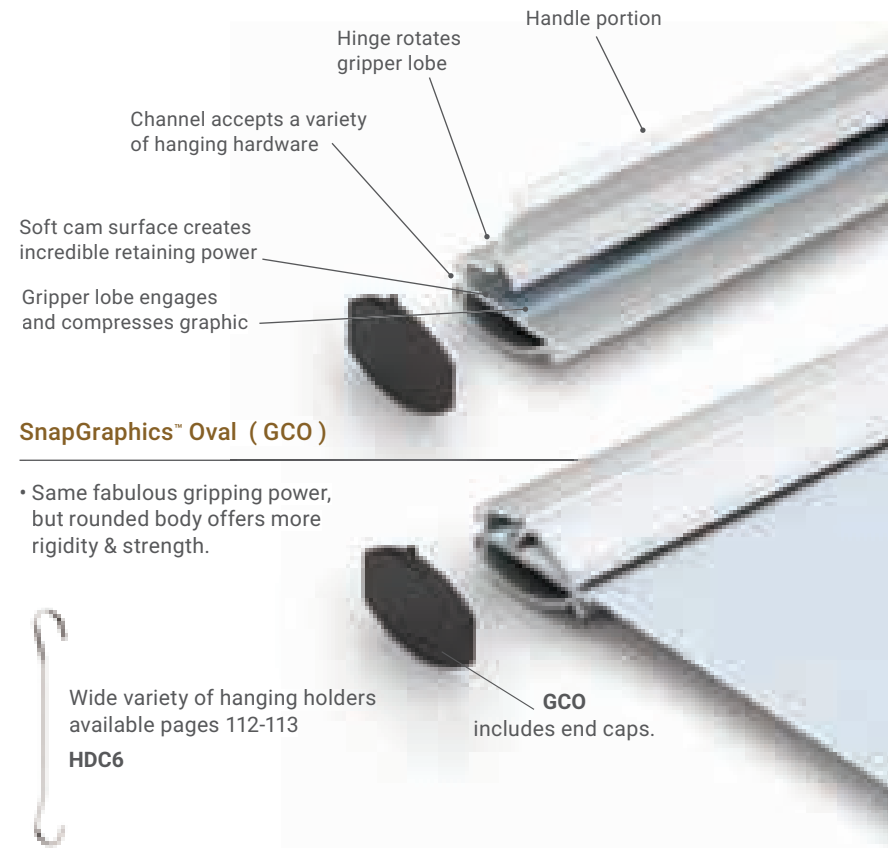
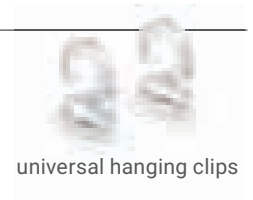

Ingenious gripper snaps closed after graphic insertion with incredible strength, torque and care.

Hanging Banner Kits

Hanging Graphics Hardware

Hanging Dowel Kits



Includes the following:

- (2) aluminum 1/2" diameter dowels, end caps
- (1) diamond braided cord
- Use a hem top & bottom to mount on wall
- Dowels are hidden inside banner hems

Specify Model

PP24	24" wide dowels
PP36	36" wide dowels
PP48	48" wide dowels

Wall Mount Snap Bar Kits



Includes the following:

- Strong springs hold graphics to 1/16" thick
- (2) Aluminum Snap Bars, matte finish
- (4) wall screws & anchors
- Black endcaps

*Specify Model

MEB1	18"
MEB2	22"
MEB3	24"
MEB4	28"

*Specify Model

MEB5	36"
MEB6	48"
MEB7	60"
MEB8	72"

Specify Finish*

- S Satin Silver
- B Matte Black

*Doesn't affect price.

Wall Mount Banner Kits

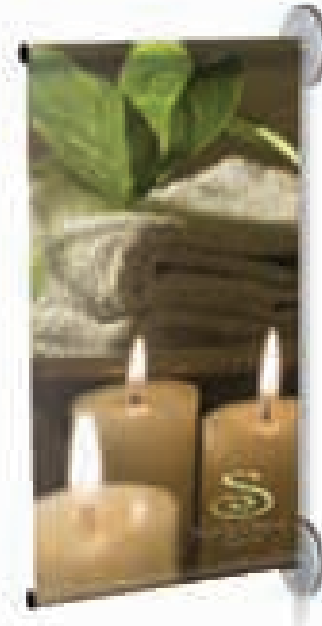

Includes the following:

- (2) 3/4" diameter matte finish poles
- (2) 3-1/4" round plates with mounting holes
- Wall hardware not included

*Specify Model

WB1	12" Banner Width
WB2	18" Banner Width
WB3	22" Banner Width
WB4	24" Banner Width
WB5	30" Banner Width

Trapeze Bars™

Hanging Graphics Hardware

Simply Hem Graphics
top and bottom for aluminum tubes.



Single Section Trapeze Bars™

- Sold as a top crossbar and bottom crossbar set
- Steel eyebolts are included for top crossbars.
- Strong and lightweight
- Very easy to use
- Extremely economical
- Shipped one set per polybag
- **BP13** comes in 2 sections with solid bushings connecting

Aluminum alloy tubes,
etched and clear anodized finish.

Model	Banner Width	Diameter	Color
BP01	18"	7/8"	-S Satin Silver
BP02	22"	7/8"	
BP03	24"	7/8"	
BP04	28"	7/8"	
BP05	36"	7/8"	
BP06	48"	7/8"	
BP07	60"	7/8"	
BP08	72"	7/8"	
BP11	84"	7/8"*	
BP13	96"	7/8"*	

* Has 3rd Eyebolt in center,
banner notch required.
Not SD compatible.

Standard Configuration

- Eyebolt is removable. Top bar is 2" longer than the bottom which sits flush in hem.

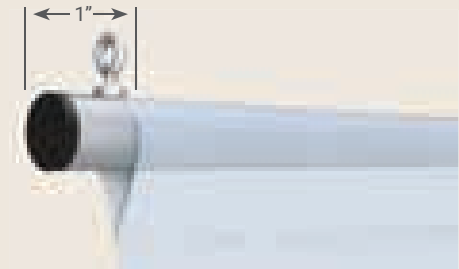

Optional Configuration

- **Specify: Side Eyebolts (SD).** Same cost as standard configuration. Example: **BP06-SD**

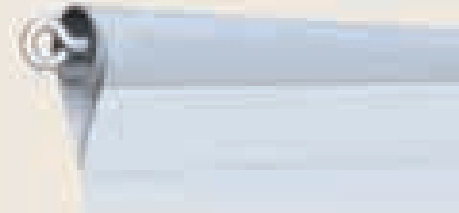

Baby Trapeze Bar Wire Sets

- 3/16" diameter steel wire. Tops have loops at each end. Bottoms are straight cut.

Model	Width	Model	Width
BPW09	9"	BPW18	18"
BPW12	12"	BPW24	24"

Hanging Graphics Hardware

Multiple Section Trapeze Bars

- Sold as a top crossbar and bottom crossbar set
- Steel eyebolts are included for top crossbars.
- Strong and lightweight
- Very easy to use
- Extremely economical



Custom Sizes Available.



Multiple section units connect with solid aluminum turned bushings.

Model	Banner Width	Sections	Diameter	# Eyebolts
BP09	96"	2	1-1/4"	3
BP10	120"	2	1-1/4"	3
BP12	144"	2	1-1/4"	3
BP15	180"	3	1-1/4"	4
BP20	240"	4	1-1/4"	5

Color 
 -S Satin Silver

All eyebolts except those at each end require a banner notch.

Disclaimer: We recommend getting samples and fully testing these products for your application. Purchaser determines suitability of all product usage and assumes all risk & liability. Neither the seller nor the manufacturer shall be held liable for any injury, loss or damage from use of such product.



Simply Hem Graphics top and bottom for aluminum tubes.

Standard Configuration

- Top Bar is 2" longer than bottom bar, which sits flush inside bottom hem.

Wall Mount Bracket Sets

Hanging Graphics Hardware



Wall Mount Bracket Sets

- Wall mount bracket sets work in conjunction with our optional configuration **SD** Trapeze Bars, pg. 106, ie. those with top bars having side threads

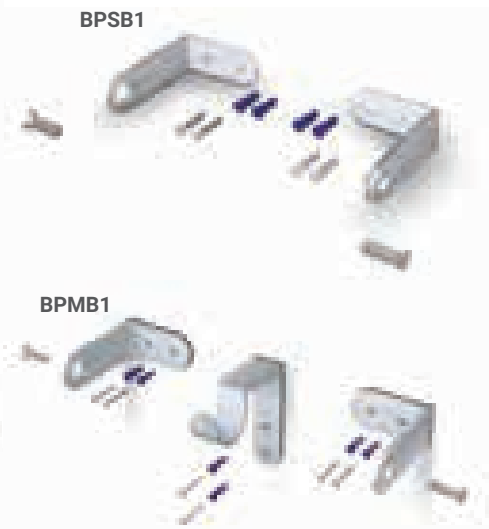

- Remove eyebolts from Trapeze Bars and discard (or order without). Attach to top bar, bottom bar drops freely.

Model Sections

BPSB1 **1 section** Trapeze Bars (7/8" diameter).

BPMB1 **2 section** Trapeze Bars **BP09-SD, BP10-SD & BP12-SD**

Simply Hem Graphics top & bottom for aluminum tubes



Ladderless Hanging
Custom Requests Encouraged

Graphic Changeouts Without a Ladder

Telescopic Changeout Pole

Model Sections

JBT1 **2 sections** - opens - 10' Extension / 15' Ceiling.

JBT2 **3 sections** - opens - 15' Extension / 20' Ceiling.

JBT1

Hanging Graphics Hardware

Straight Halo Rail Kits

- Two Systems – for fabric or styrene
- Movable eye mount assemblies
- Four plastic end cap closures



Textile - Hem Graphics



Styrene Graphics

Custom lengths available

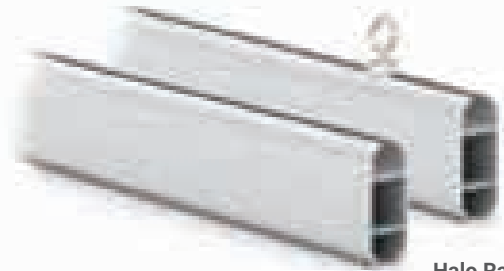

Halo Rail
1 5/8" Tall

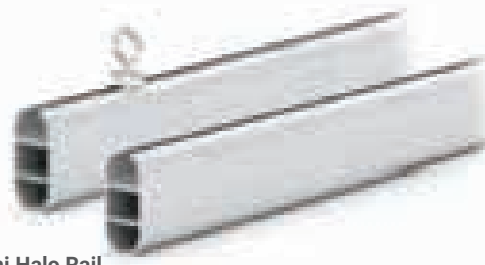

Mini Halo Rail
1 5/16" Tall

Daisy Chain
Multiples Together



Straight Halo Rail Kits (sets)

- Versatile shape in a handsome aluminum profile
- Able to hang in series by daisy chaining
- For fabric or styrene graphics
- Movable eye mount assemblies
- Four plastic end cap closures
- Custom long lengths available in single or multiple sections

Fabric Hemmed Graphics Model

Cut Length	Halo Rail	Mini Halo Rail
24"	HRGF24	HRMF24
36"	HRGF36	HRMF36
48"	HRGF48	HRMF48
72"	HRGF72	HRMF72

Styrene Graphics Model

Cut Length	Halo Rail	Mini Halo Rail
24"	HRGY24	HRMY24
36"	HRGY36	HRMY36
48"	HRGY48	HRMY48
72"	HRGY72	HRMY72

Color



Satin Silver

Custom colors
quoted on request

Hanging Graphics Hardware

Supports for the Digital Image Revolution

- Artists everywhere are printing on metal panels, and the images are often eye popping
- Increase impact by using our new Floating Stand Off Mounts – today's new modern way to display digital prints
- Prints are set off the wall an inch creating a floating frameless effect, with no visible hardware

Color



-S Satin Silver



High Bond Tape is supplied to hold graphics to StandOff Mounts.



Graphic attaches to StandOff Mount with High Bond Tape.



Floating StandOff Mount hangs from wall cleat.

Components - Available in kits or a la carte



Right angle push in corners.



1" square aluminum, quick, tool-free assembly.



Top section hangs from wall cleat.



Wall mount cleat includes mounting holes.

Security options available to "lock" frame to wall.

Floating StandOff Mounts™ Hanging Graphics Hardware

Float your Digital Print Off the Wall

- Our new Floating StandOff Mounts – a dramatic approach to display your digital prints
- Prints are set off the wall creating a shadow effect to add depth, framelessly, with no visible hardware
- Our system hangs on the wall with an intrinsic “French Cleat” design

Bulk Components

Model	Components
OATCL4	1" Square "L" Corners (Bag of 4)
OATCL100	1" Square "L" Corners (Bag of 100)
OATCSQ72	1" Square Aluminum 72" long
OATCCR72	1" Square Aluminum Cleat Receptive 72" long
OATFC72	French Cleat 72" Long
OATCHB100	High Bond Tape, Pack of 100 pcs., 3" long

Complete Kits

Includes StandOff Mount and aluminum mounting cleat, & high bond mounting tape.

Model	StandOff Mount	Suggested Graphic Size
OAT1818	18" x 18"	24"x 24" Graphic recessed 3"
OAT1830	18" x 30"	24"x 36" Graphic recessed 3"
OAT2434	24" x 34"	30"x 40" Graphic recessed 3"
OAT3042	30" x 42"	36"x 48" Graphic recessed 3"
OAT4266	42" x 66"	48"x 72" Graphic recessed 3"

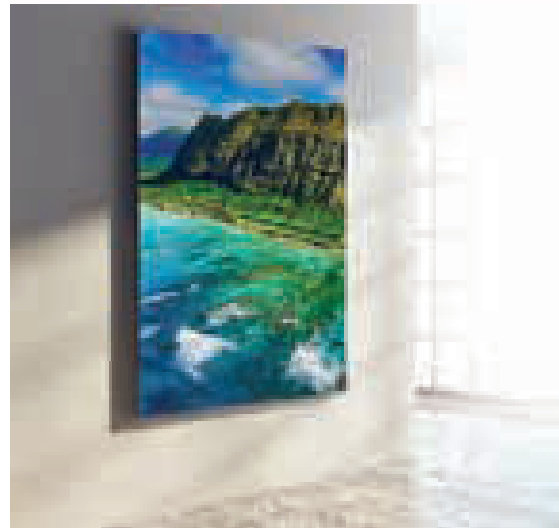

Assembled StandOff Mounts staged ready to bond to graphics. Designed for production runs.

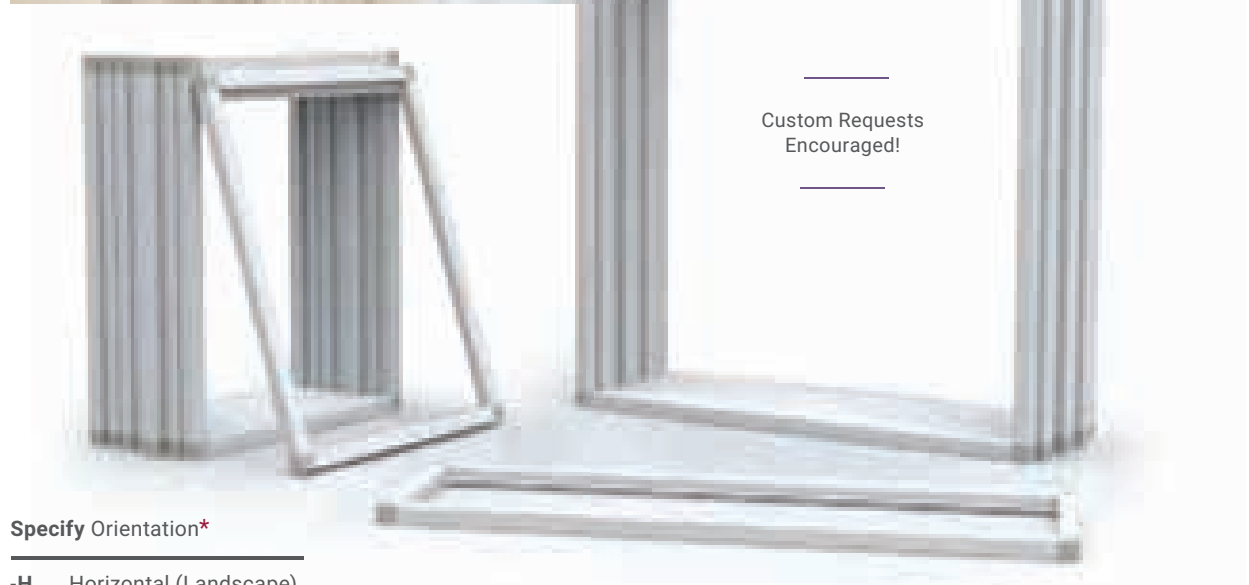

Custom Requests Encouraged!

Specify Orientation*

- H Horizontal (Landscape)
- V Vertical (Portrait)

Hanging Components

Hanging Graphics Hardware

Ceiling Anchors

Metal Loop

- Strong steel spring. Provides 15/64" loop. Sold 10/per. **ANC04**



Metal Threaded Studs

- Strong heavy duty scissors clip. Use to mount threaded accessories. Sold 10/per. **ANC14**



Butterfly Clip with Hole

- Simply squeeze together. Hole accepts hooks. Sold 10/per. **ANC16**



Grid Snap On Swivel Hook

- 1/4" hook slot rotates 360°. Sides simply snap on. White. Sold 10/per. **ANC02**



Clear Hinged Hook

- One piece hook hinges open & closes around ceiling grid. Sold 10/per. **ANC05**



Magnets



Round Magnetic Bases

- Plated steel case with hook. Houses or contains powerful magnets.

Model	O.D.	Rating
RMB1	1-1/2"	18 lbs.
RMB2	2"	20lbs.
RMB3	2-1/2"	38lbs.

Steel Spring Stud

- Clips onto grid, thread for accessories. Sold 10/per. **ANC13**



Swivel Clip

- Clear plastic clip for ceiling grids, swivels 360°. Sold 10/per. **ANC01**



Grid Snap On Eye

- 3/8" diameter eye. Great looking. Simple & strong. Sold 10/per. **ANC03**



Butterfly Clip Swivel

- Simply squeeze together to attach to grid ceiling. 1/2" opening. Sold 10/per. **ANC15**



Ceiling Twist Loop

- 7/8" loop, 2" base. Quick connect, just twist. White. Sold 10/per. **ANC06**



Grid Ceiling Divider

Grid Ceiling Divider

- **GRCD1** for positioning anchors & signage in the best possible location. 24" long, white, compatible for most grid ceilings

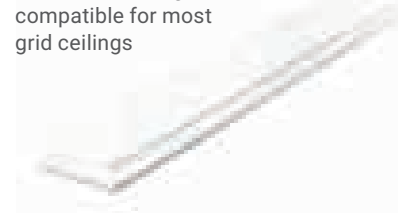

Ceiling Tracks

Ceiling Tracks

- White aluminum bars with mounting holes. Mounting hardware not included. **CTK48** 48", 3 holes, **CTK96** 96", 5 holes. **Universal Track** on pages 100 - 101

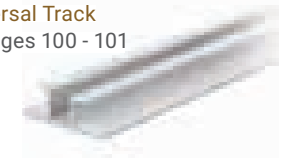

Links

C Links Sold 100/per.

CLK1 C Link 1-1/2" long

CLK2 C Link 3" long

SHK1 S Link 1" long

SHK2 S Link 1-5/8" long



Rings

- Set of 4, hold graphics with holes or grommets.

RG3 2" Diameter

RG5 3" Diameter

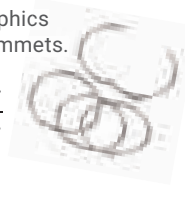

Suction Cups

Suction Cups

- Clear 2-1/4" diameter with hanging hook. Sold 100/per. **ANC18**



Suction Cups with push tack

- Clear 2-1/4" diameter Sold 100/per. **ANC19**



Round Magnetic Bases

- Plated steel case with 1/4-20 male thread.

Model O.D. Pull Force Rating

RMB75 1-1/4" 75 lbs.



Rectangular Channel Magnet

- Plated steel case holds magnetic base.
- Terrific for all around use.

Model Length Pull Force Rating

RCM-1 2 3/4" Long 25 lbs.



Hanging Graphics Hardware

Cables, Hooks and Harnesses

Double Loop Cable

- 1/16" uncoated stainless steel with 1/2" long loops. Hold up to 50 lbs. Sold 2/per.

Model	Length	Model	Length
HDL6	6"	HDL18	18"
HDL12	12"	HDL24	24"



Double C Hooks

- Plated steel hang-wires. Economical. Holds up to 10 lbs. Sold 50/per.

Order: **HDC4** (4"),
HDC6 (6"),
HDC12 (12"),
HDC18 (18"),
HDC24 (24"),
HDC36 (36")



Plastic Double "C" Hooks

- 5/32" diameter clear plastic with 3/8" open hook each end. Sold 50/per.

Model	Length	Model	Length
PDL6	6"	PDL12	12"
PDL8	8"	PDL16	16"



Locking Plastic Double "C" Hooks

- 5/32" diameter clear plastic able to lock together. Safe alternative. Sold 50/per.

Model	Length	Model	Length
PLDL6	6"	PLDL18	18"
PLDL12	12"		



Adjustable Cable Assemblies

Wire Rope Loop

- Wire rope loop one side, straight wire other, plus an adjustable spring loaded cable lock. Choice of locks - Diecast zinc and double barrel steel. Simply feed cable through the lock and adjust to required length. Sold 2/per.

Model	Lock	Gauge	Length	Rating
ADC136	Diecast	3/64"	6'	14 lbs.
ADC1312	Diecast	3/64"	12'	14 lbs.
ADC1318	Diecast	3/64"	18'	14 lbs.
ADC166	Diecast	1/16"	6'	50 lbs.
ADC1612	Diecast	1/16"	12'	50 lbs.
ADC1618	Diecast	1/16"	18'	50 lbs.
ABS166	Steel	1/16"	6'	50 lbs.
ABS1612	Steel	1/16"	12'	50 lbs.
ABS1618	Steel	1/16"	18'	50 lbs.



Adjustable Cable Locks

Adjustable Cable Lock

- Adjustable Cable Locks (without cable) Use with bare uncoated wire rope only

Model	Lock	Gauge	Rating
ADC13	Diecast	3/64"	14
ADC16	Diecast	1/16"	50
ABS16	Barrel	1/16"	50
ABSSE	Steel	3/64" 1/16"	28 50



ABSSE
• Steel, Side exit, 10/32" Female threaded base

Oval Crimp Sleeves

DWSC364 Oval crimp sleeves. For 3/64" 50/per.
DWSC116 Oval crimp sleeves. For 1/16" 50/per.



Crimping Tool

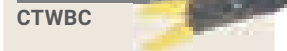

Harness Sets

Harness Sets should be professionally installed.

- HRNS3** 3 small shackles, 3 double loop lead wires (specify length), collection shackle, 20' pendant wire, 2 wire rope clips
- HRNS4** 4 small shackles, 4 double loop lead wires (specify length), collection shackle, 20' pendant wire, 2 wire rope clips
- HRNS5** 5 small shackles, 5 double loop lead wires (specify length), collection shackle, 20' pendant wire, 2 wire rope clips



Shackles | quick links | aircraft cable.

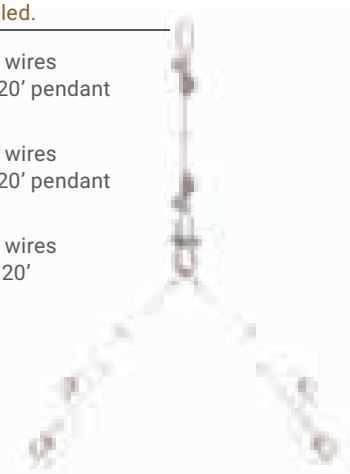

Fully test every installation as conditions vary, and neither the manufacturer nor the sales representative may be held liable for injury or loss or damage resulting from the use of these products.

Wire Ropes | 100' rolls, uncoated

Model	Gauge	Style	Rated
HWB364100	3/64"	Bare Uncoated	14 lbs.
HWB16100	1/16"	Bare Uncoated	50 lbs



HWB364100

Straight FlatWalls™

Tension Fabric



Pillowcase Mounted Graphics

- Lightweight, strong and portable
- Aluminum satin silver finish
- Tool-Free, quick easy assembly
- Sectional crossbars - uprights
- Heavy steel bases
- 1 1/4" diameter tubing



Rounded or square corner tops



Adjustable Droop preventor included on **FW108** & **FW208** for leveling crossbars.



FW088 has 2 bases and 2 uprights & crossbars.

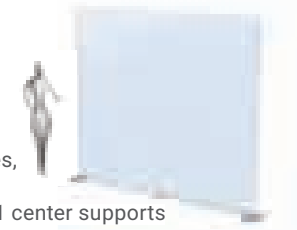

FW108 has 2 bases, 1 droop preventor, 2 - full uprights & 1 center supports 2 - crossbars.

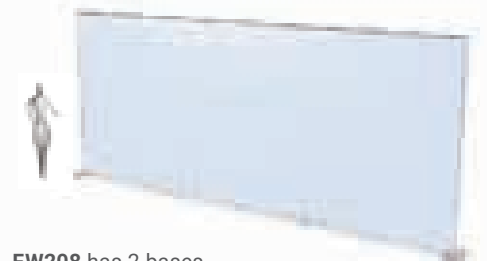

FW208 has 2 bases, 2 droop preventors, 2 - full uprights & 2 center supports, 2 - crossbars.

Choose either Square or Rounded Top Corners

Square Top	Rounded Top	Overall Size	Graphic Size
FW088	FW088R	8' wide x 8' high	96" w x 95" h
FW108	FW108R	10' wide x 8' high	111" w x 95" h
FW208	FW208R	20' wide x 8' high	230" w x 95" h



Tool - Free coded assembly



LNB1 Optional bag 33" x 18" x 13". Perfect for carrying and keeping components together.

Tension Fabric

Tool-Free Assembly Pillowcase Mounted Graphics

Dye Sub Fabric Graphics

- Endless possibilities, custom printed from your artwork, fabulous for visual marketing.
- These pillowcase mount graphics feature an industrial bottom zippered closure for easy assembly.
- Graphics are available 1 sided & 2 sided. Graphic specs on website. Light blockers are also available.
- High Impact dye sub printing on a virtually "Wrinkle Free" stretch fabric, One-sided graphics have an opaque backing.

Visual Graphic Stands™ – Lightweight and Portable

- 1" constant diameter satin silver finish uprights. Sleek design, tubes feature swaged and button construction for quick assembly & portability.
- Marquise shaped laser cut steel bases lend stability. 18" long. 8-3/4" wide in the center.
- Hanging units without bases, with eyebolts are available - **Tension Fabric Flat Fabric Pillowcase Panels** page 128

Great for:
Retail
Hospitals
Tradeshows
Hospitality

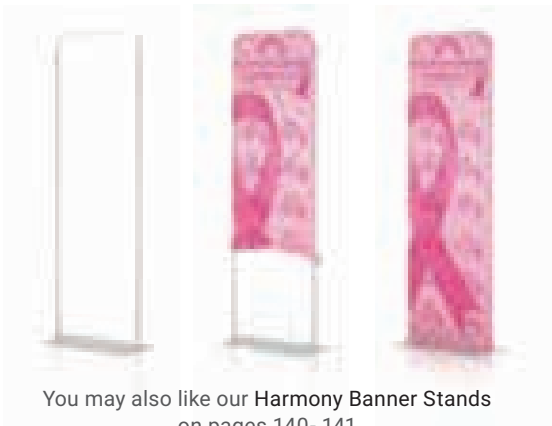
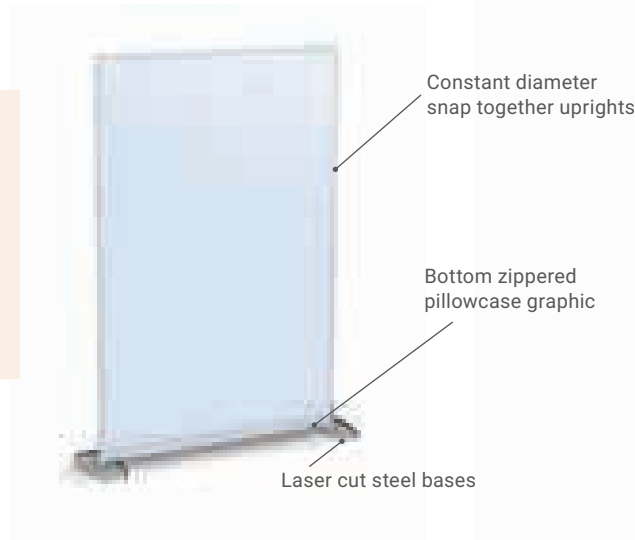

You may also like our Harmony Banner Stands on pages 140- 141

Specify: Model

Model	Overall Size	Graphic Size
VG62	2' wide x 6' high	24" w x 71" h
VG63	3' wide x 6' high	36" w x 71" h
VG64	4' wide x 6' high	48" w x 71" h.
VG82	2' wide x 8' high	24" w x 95" h
VG83	3' wide x 8' high	36" w x 95" h
VG84	4' wide x 8' high	48" w x 95" h

Swage & spring button, tool-free coded assembly.



Scenic Fabric Walls™

Tension Fabric



Pillowcase Mounted Graphics

- Adjustable angle presentations
- Sturdy 1-1/4" diameter aluminum tubing
- Soft curved top corners
- Tool-Free assembly
- Impressive 8' height
- Weighted steel bases

All connection points are coded for super easy assembly

Inner support bushing ensures structural integrity

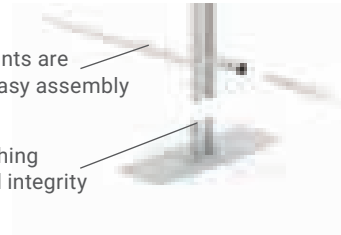

Two accessory **EBP4** bags can together transport one **PW252** or **PW3103** stand with graphics.

For 10' Tradeshow Booths

PW252

3 separate but joined together Pillowcase Stands.

- (2) 2' w x 8' high wing panels.
- (1) 5' w x 8' high center panel.

Please note: Graphic is 92" high

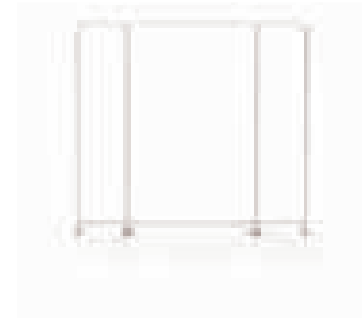

For 20' Tradeshow Booths

PW3103

3 separate but joined together Pillowcase Stands.

- (2) 3' w x 8' high wing panels.
- (1) 10' w x 8' high center panel.

Please note: Graphic is 92" high

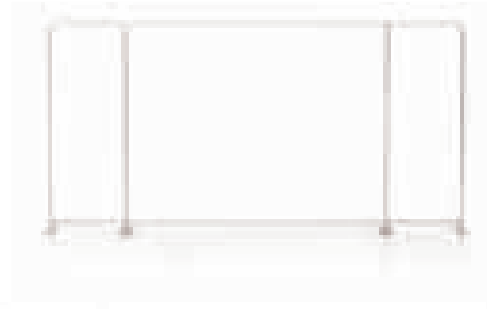

The swivel uprights and common bases allow for the same stand to be configured in many different ways.

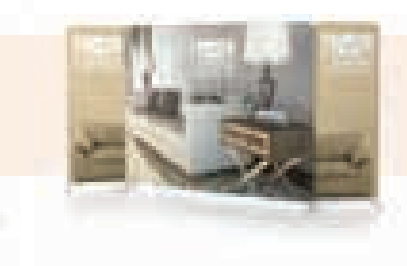

Privacy Booth Tension Fabric

Custom Examples of Scenic Fabric Walls
Being used as Vaccine Booths



Privacy Booth

- Brandable
- Portable
- Optional Fabric Graphics



PW353 w/GFX-PW353-D | Stand with double sided pillowcase graphic



Rigid Panel Privacy Booth

- Rigid Panels and Skyscraper Mounts



(1) SKMM6-S | (2) SKRA6-S | (1) SKCU6-S
and Rigid Graphics (not included) seen in
[Rigid Graphic Stands](#) Skyscraper Mounts Section

Cool C Walls™

Tension Fabric



Center pole offers support.



Enhance Brand Awareness! — Tool-Free Assembly

- Lightweight portable and sturdy
- Quick assembly
- 1-1/4" diameter anodized aluminum
- Soft travel bag included

Specify: Model Note: Graphic templates available online.

Frames	Width	Graphic Lineal Width	Height	Depth
CC86	96"	120" Approximate Linear Length	72"	30"
CC88	96"		96"	30"
CC810	96"		120"	30"
CC106	117"	140" Approximate Linear Length	72"	33"
CC108	117"		96"	33"
CC1010	117"		120"	33"
CC126	144"	176" Approximate Linear Length	72"	42"
CC128	144"		96"	42"
CC1210	144"		120"	42"

As sewing techniques differ,
please order the frame before graphic preparation.

Pillowcase Graphics available - call for pricing.

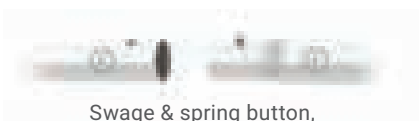

Swage & spring button,
tool-free coded assembly.



LNB1 (imported): Soft nylon bag
keeps elements together, FREE
with every Cool C Wall.
33" x 18" x 13".



Front view

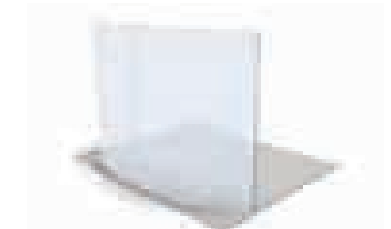

Back view -
Graphics can be 2 sided

Mega Wave Walls™

Tension Fabric

SPECIFY: Model Note: Graphic templates available online.

Frames	Width	Graphic Lineal Width	Height	Depth
MG84	96"	117" Approximate Linear Length	48"	17"
MG86	96"		72"	17"
MG88	96"		96"	17"
MG810	96"		120"	17"
MG104	120"	140" Approximate Linear Length	48"	18"
MG106	120"		72"	18"
MG108	120"		96"	18"
MG1010	120"		120"	18"
MG124	144"	155" Approximate Linear Length	48"	20"
MG126	144"		72"	20"
MG128	144"		96"	20"
MG1210	144"		120"	20"

Note: Fabrics differ as do sewing techniques, please order the frame before graphic preparation.

Mega Wave™ Tension Graphics

- Endless possibilities, custom printed from your artwork produce fabulous visual marketing effects.
- Top quality high dpi dye sub printing on a virtually "Wrinkle Free" stretch fabric, designed for this application.
- Pillow case mounting with an industrial zipper closure offers amazing ease of assembly.
- Graphics are available 1 or 2 sided. Light blockers are also available.

Mega Wave Walls™ — Tool-Free Assembly

- Lightweight portable and sturdy
- 1-1/4" diameter tubing, satin silver finish
- A soft travel bag is included with every frame
- Extremely easy to set-up and use.
- Assemble in minutes with coded indicators
- Hanging units are available with eyebolts.



Great for:

Retail
Tradeshows



LNB1 (imported): Soft nylon bag keeps elements together, FREE with every Mega Wave Wall. 33" x 18" x 13".

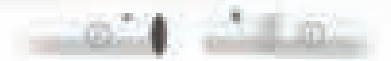

Swage & spring button, tool-free coded assembly.

Horizon Pillowcase Hanging Structures™

Tension Fabric

Classic Graphic Headboards™

- Designed for pillowcase graphics
- 1" diameter aluminum alloy
- Satin silver finish
- Ships cost efficiently-small carton
- Assembles easily in 5 minutes
- Height of all units 60"



Perfect for:
Brands
Retail
Tradeshows

Custom Sizes & Models Available.



Graphic maximum height is 57".
Visible area depends on mattress & box spring height.



Inner support bushing ensures the structural integrity. Bottom crossbar about 3" off floor.

Specify: Model Note: Graphic Ht. is 57"

Model	Width
HB39LS	39" Twin
HB54LS	54" Full
HB60LS	60" Queen
HB72LS	72" California King
HB76LS	76" King

Crest Graphic Headboards™

- Use pillowcase graphics
- 1-1/4" diameter alloy aluminum
- Satin silver finish
- Height of all units 72"
- Ships KD in a small carton
- Amazingly easy to assemble

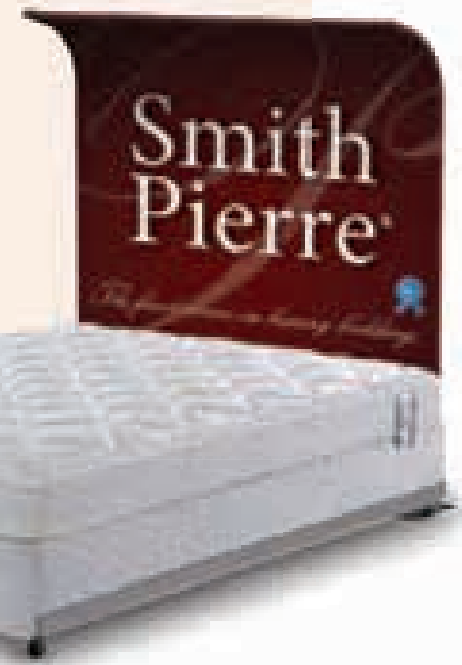

Curved Top adds Focus



Specify: Model Note: Graphic Lineal length is 75.5" h

Model	Width	Graphic Size
HB39CR	39" Twin	39" w x 75.5" h
HB54CR	54" Full	54" w x 75.5" h
HB60CR	60" Queen	60" w x 75.5" h
HB72CR	72" California King	72" w x 75.5" h
HB76CR	76" King	76" w x 75.5" h

Tension Fabric

Custom Size
Requests Encouraged



Perfect for:
Retail
Tradeshows
Exhibits

Large Format –Hanging Structures

- 1-1/4" Round tubing
- Designed for pillowcase graphics
- Tool-Free coded assembly
- Forged eyebolts included
- Aluminum tubing, satin silver finish



Swage & spring button, tool-free coded assembly.



Forged metal eyebolts are included. Removable for floor use.



All components are coded for extremely easy associate assembly!



Rectangular Structures

Model	Size: H x W x D (O.D.)
HPR3105	3' x 10' x 5'
HPR4126	4' x 12' x 6'
HPR4168	4' x 16' x 8'



Square Structures

Model	Size: H x W x D (O.D.)
HPS38	3' x 8' x 8'
HPS310	3' x 10' x 10'
HPS412	4' x 12' x 12'



Triangular Structures

Model	Size: H x W x D (O.D.)
HPT38	3' x 8' x 8' x 8'
HPT310	3' x 10' x 10' x 10'
HPT412	4' x 12' x 12' x 12'

Graphics and harness sets - sold separately - Maximum length of any one section - 93"

Disclaimer: Purchaser determines suitability of all product usage and assumes all risk & liability. Neither seller nor manufacturer shall be held liable for any injury, loss or damage from use of product.

Floor models available in Banner Stand section.



MAKE CUBES, RECTANGLES & TRIANGLES.

Halos and Tapered Halos

Tension Fabric



Accepts Dye Sub Fabric Pillowcase Graphics

- High impact Dye Sub Fabric Printing
- Virtually “wrinkle free” stretch fabric
- Single or double sided printing
- Custom printed from your art work

Pillowcase Mounted Graphics and hanging hardware sold separately.

Specify: **HALO** Model Note: Graphic templates available online.

Model	Size	Height	Sections	Struts/Eyebolts	Harness Set
HALO6	6' Diameter	2-1/2'	4	3	HRNS3
HALO8	8' Diameter	3-1/2'	5	4	HRNS4
HALO10	10' Diameter	3-1/2'	6	4	HRNS4
HALO12	12' Diameter	3-1/2'	7	5	HRNS5



Perfect for:
Tradeshows
Exhibits
Retail Environments



HATP108 Tapered Halo with **HRNS4** Harness Set.

Specify: **TAPERED HALO** Model Note: Graphic templates available online.

Model	Size	Height	Sections	Struts/Eyebolts	Harness Set
HATP64	6' Top, 4' Bottom	2-1/2'	4	3	HRNS3
HATP86	8' Top, 6' Bottom	3-1/2'	5	4	HRNS4
HATP108	10' Top, 8' Bottom	3-1/2'	6	4	HRNS4
HATP1210	12' Top, 10' Bottom	3-1/2'	7	5	HRNS5

Disclaimer: Purchaser determines suitability of all product usage and assumes all risk & liability. Neither seller nor manufacturer shall be held liable for any injury, loss or damage from use of product.

Halos and Tapered Halos Structures

- 1-1/4" diameter aluminum tubing
- Satin silver finish
- Easy swage & spring button assembly
- Forged eyebolts for hanging
- Accepts Pillowcase Graphics



Accessory Harness Sets

HRNS3 3 small shackles, 3 double loop lead wires (specify length), collection shackle, 20' pendant wire, 2 wire rope clips.

HRNS4 4 small shackles, 4 double loop lead wires (specify length), collection shackle, 20' pendant wire, 2 wire rope clips.

HRNS5 5 small shackles, 5 double loop lead wires (specify length), collection shackle, 20' pendant wire, 2 wire rope clips.

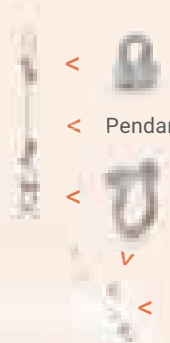

Forged wire rope clips for creating desired size top loops. Use 2 to insure safety.

< Pendant Wire

Large forged collection shackle and smaller forged shackles that attach to eyebolts.

< Lead Wires



Pillowcase Mounted Graphics and hanging hardware sold separately.



Forged metal eyebolts are included for harness sets.

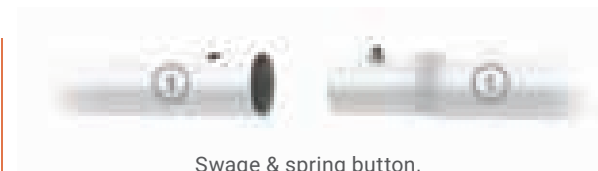

Swage & spring button, tool-free coded assembly.

Fully test every installation as conditions vary, and neither the manufacturer nor the sales representative may be held liable for injury or loss or damage resulting from the use of these products.

Tension Fabric

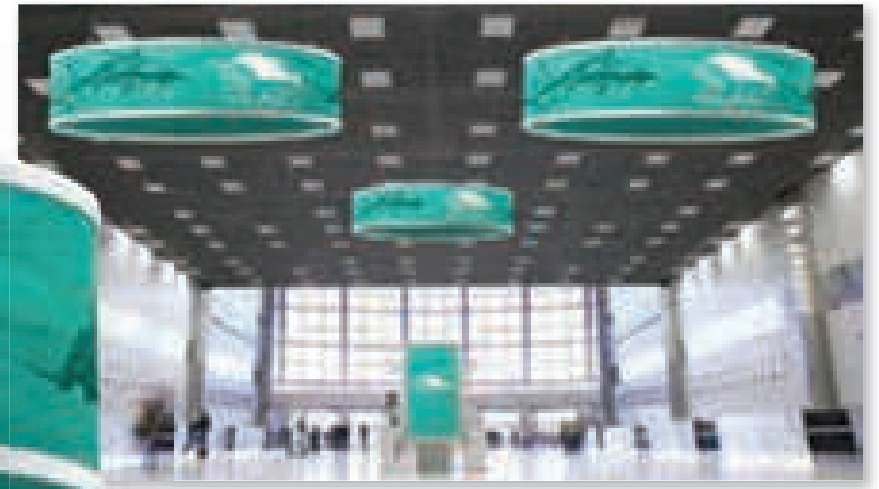

- Top and bottom profiles
- Graphic holders
- Steel eyebolts

Choose type of media being displayed:

- Fabric Hemmed Graphic **OR** • Styrene Graphics

Halo Rail® Kits Feature:

- Curved satin aluminum profiles handsomely house pole pocket graphics
- Strong, yet lightweight
- Height is 2-1/2" higher than graphic
- Ships ready for very easy assembly. Eyebolts come already attached
- Quick graphic change-outs
- No costly vertical struts needed

Harness sets sold separately, page 113

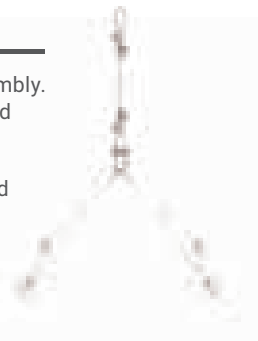

Specify: **HALO Rail** Model

Note: Graphic Specs available online.

For Fabric Graphics	For Styrene Graphics	Diameter	# Sections	Eyebolts
HRFK6	HRSK6	6'	4	3
HRFK8	HRSK8	8'	5	4
HRFK10	HRSK10	10'	6	4
HRFK12	HRSK12	12'	7	5

Custom Colors Available

Fabric Hemmed Graphics

Plastic dowels (included) insert into hemmed pole pockets top and bottom.

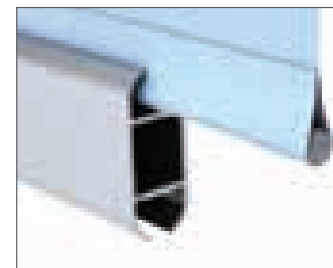

Styrene Graphics

Hang from stapled soft plastic extrusions top and bottom



Extra Graphic Holders HRPD - 50' Roll of extra fabric dowell
HRSX - Extra plastic extrusions 50' (for styrene graphics)



Styrene graphics are stapled to plastic extrusions top & bottom. Swingline® Optima® 70 Desk Stapler recommended.

Halo Rail Free Forms™

Tension Fabric

Halo Rail Free Forms™

- Top and bottom profiles
- Graphic holders
- Steel eyebolts

Simple Curves or elaborate Free Forms are all possible. Price is a function of quantity. Our engineering and sales team can work with your designers and price accordingly. Minimum quantities and radius restrictions apply.

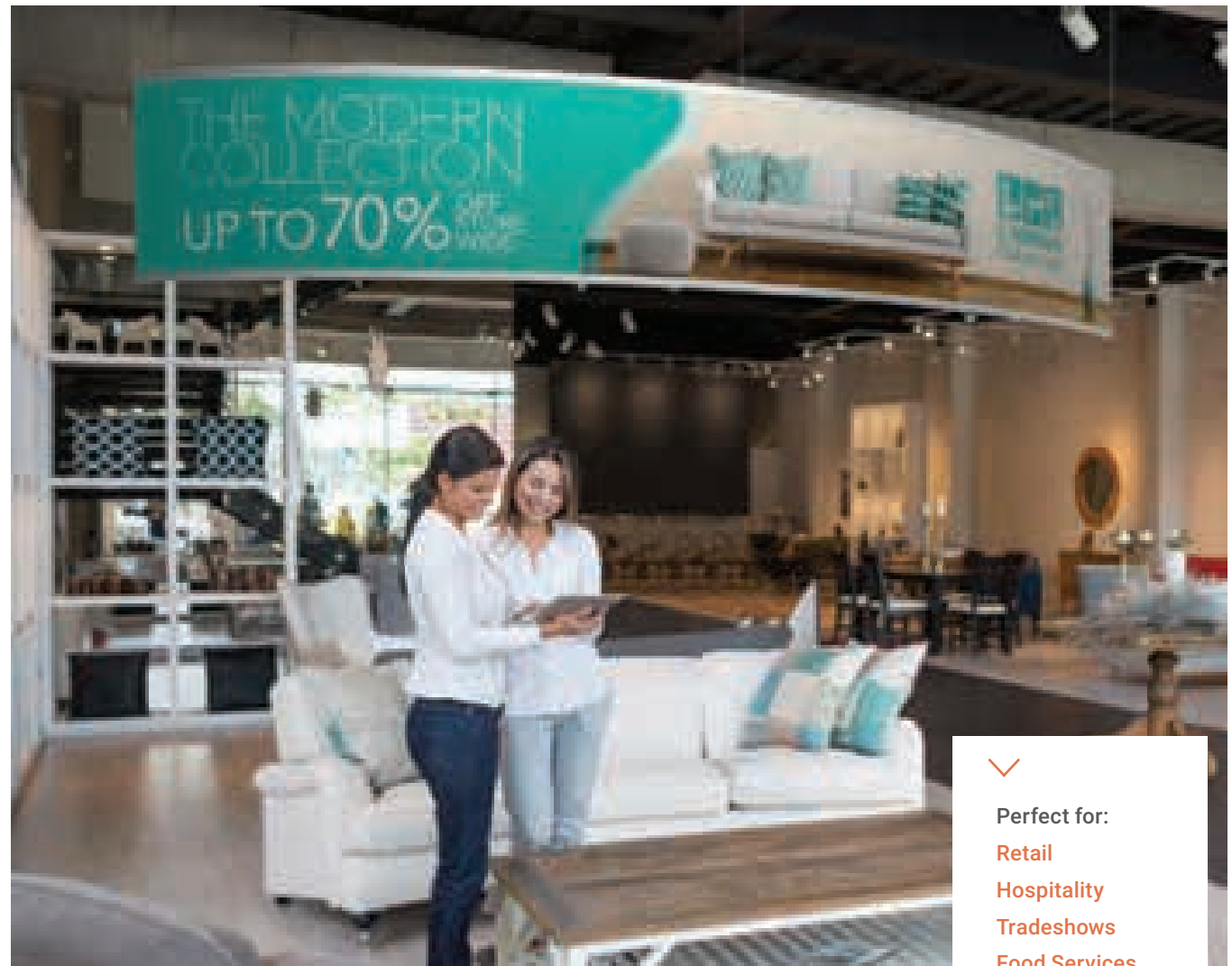
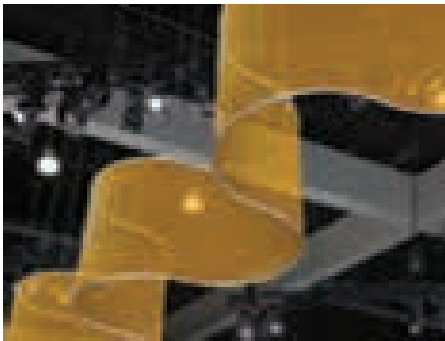
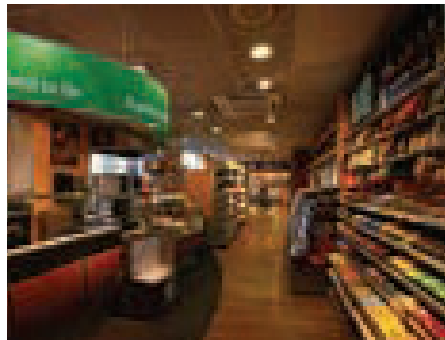

Perfect for:

Retail

Hospitality

Tradeshows

Food Services

Halo Rails™ Design Ideas

Tension Fabric

Amazingly versatile shape

- Display textile or styrene displays within a handsome functional oval shape.
- Two systems – One for hemmed fabric graphics – other for styrene signage



Fabric Hemmed Graphics
Included Inner Rods



Styrene Graphics
Staples to supplied channel
Used for round or long graphics



Styrene Graphics
Plastic snaps every ~12"
Used for straight & short graphics



Halo Rail 1 5/8" Tall



Mini Halo Rail 1 5/16" Tall

So Many
Possibilities!!

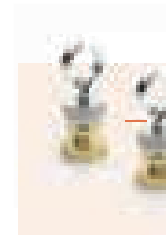

Hanging Hooks
sliding solid steel



Daisy Chain
Multiples Together
Can hang in series.

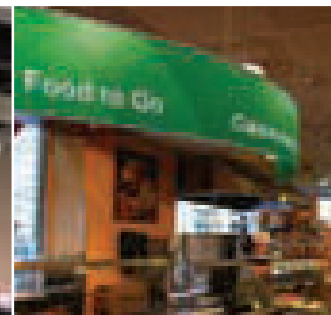
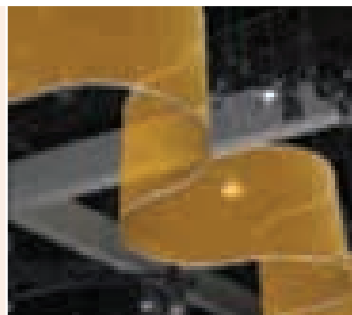

Halo Rails™ Design Ideas

Tension Fabric Structures



Huge graphics look great encapsulated within the profile



This graphic is hung horizontally as a canopy from above

Custom Requests Encouraged

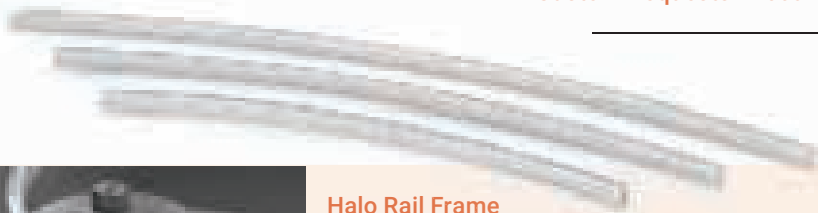

Halo Rail Frame

- Simple curves or elaborate free forms are all possible
- Great visual effects

We roll bend the profiles to your specifications

End Caps

solid steel corner brackets

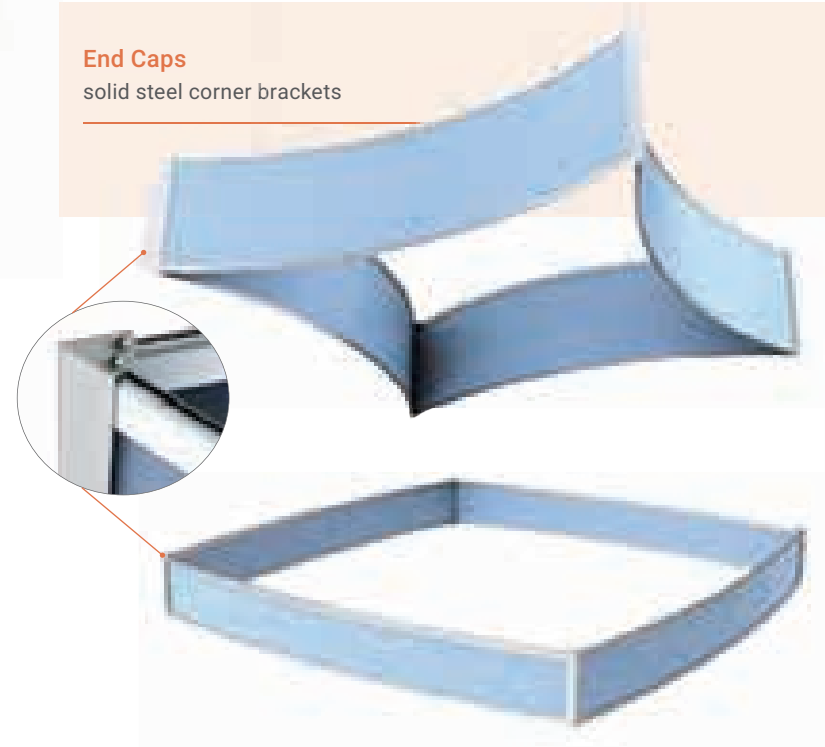

Tension Fabric

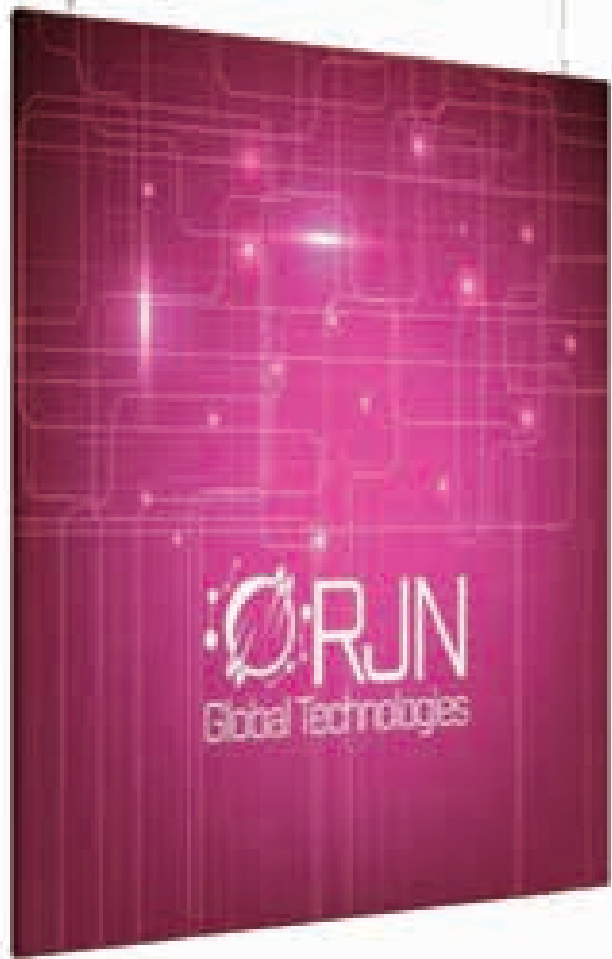

Flat Panels

- Aluminum alloy construction
- Swage & spring button construction
- Designed for pillowcase graphics
- Extremely fast & easy assembly
- Portable modular design
- Forged eyebolts for hanging



Perfect for:

Tradeshows

Showbiz

Retail Environments



Hanging Mount Choices:



Horizontal



Vertical



Canopy

Canopy SEG light box available custom.

Specify: Model – Hanging Orientation* *Not on price sheet, but must use to order.

Rectangles	W x H	Squares	W x H	Hanging Orientation*
FPL63	6' x 3'	FPL6S	6' x 6'	-H Horizontal
FPL83	8' x 3'	FPL8S	8' x 8'	-V Vertical
FPL104	10' x 4'	FPL10S	10' x 10'	-C Canopy
FPL126	12' x 6'	FPL12S	12' x 12'	



Swage & spring button, tool-free coded assembly.
Maximum length of any one section – 93”.



Forged metal eyebolts are included for easy hanging.

Circle Moons™

Tension Fabric

Hanging Hardware for Circle Moons™

- Circle Moons are lightweight, Use Double C Hooks and anchors to attach to ceiling. Found in Hooks & Cables **Hanging Hardware section** pages 112-113
- Use harness sets for additional safety.

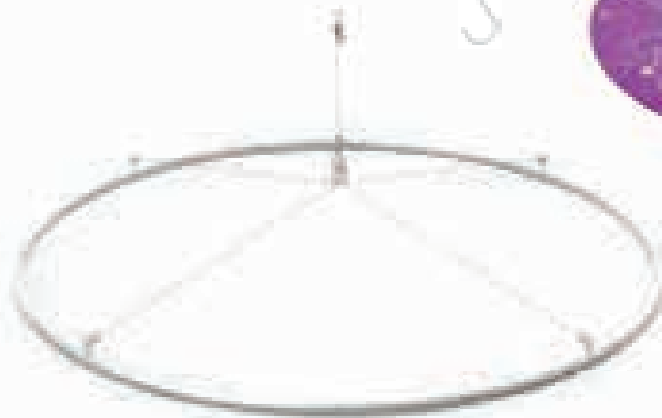

Accessory Harness Sets

HRNS3 3 small shackles, 3 double loop lead wires (specify length), collection shackle, 20' pendant wire, 2 wire rope clips.

HRNS4 4 small shackles, 4 double loop lead wires (specify length), collection shackle, 20' pendant wire, 2 wire rope clips.

HRNS5 5 small shackles, 5 double loop lead wires (specify length), collection shackle, 20' pendant wire, 2 wire rope clips.

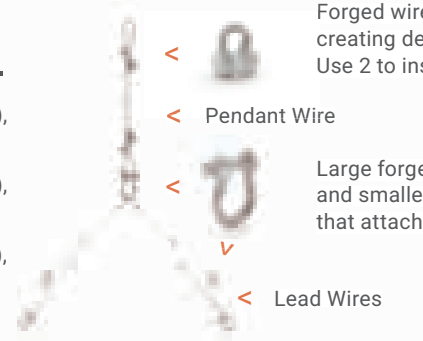

Forged wire rope clips for creating desired size top loops. Use 2 to insure safety.

Pendant Wire

Large forged collection shackle and smaller forged shackles that attach to eyebolts.

Lead Wires

Circle Moons™

- Swage & spring button assembly
- Metal eyebolts for hanging
- Strong aluminum alloy tubing
- Satin silver finish

Specify: Model

Model	Diameter	Gauge	# of Eyebolts
MOON4	4'	1"	3
MOON5	5'	1"	3
MOON6	6'	1-1/4"	4
MOON8	8'	1-1/4"	5
MOON10	10'	1-1/4"	6
MOON12	12'	1-1/4"	7

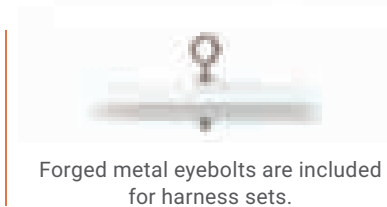
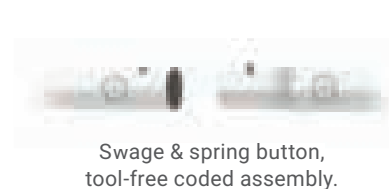

Pillowcase Mounted Graphics and hanging hardware sold separately.

Fully test every installation as conditions vary, and neither the manufacturer nor the sales representative may be held liable for injury or loss or damage resulting from the use of these products.

Collage Pop-Ups™

Tension Fabric



Complete Collage Kit 43K1

Clever Non Traditional Pop-Up*

- Create 3D effects
- Lightweight aluminum
- Instant set-up - take down
- Incredibly eye-catching
- Infinite configurations
- Padded Roller Bag included

Pick - a - Kit Catalog

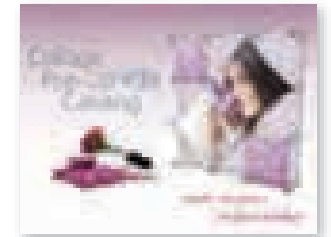

Complete Kits include:
Custom printed graphics, frame & padded roller bag.



Bolt based system
allows easy changes

Extraordinary 3D Graphic Effects

Eight Standard Frame Structures



LGP3



LGP6



LGX



LG13



LG22



LG23

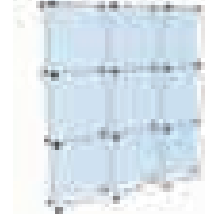

LG33



LG43

Collage Pop-Up® Graphics

- High impact 720 dpi Dye Sub Printing
- Virtually “wrinkle free” stretch fabric
- Complete catalog with 90 designs at:
<http://www.displayfolio.com/pdf-viewer/pdf/collage-pick-a-kit-2018.pdf>



Extraordinary 3D Graphic Effects



P3K1 Kit



P6K10 Kit



XK1 Kit



Note: Flags are stretched to the four points of contact with frame, please keep essential design elements (logos, text) at least 3"-5" from edges to have less distortion. When designing keep in mind focus point is 3"-5" from outer edges. Fabric is **not** transparent.

Presto Pop-Ups™

Tension Fabric

A Virtual Portable Billboard

- Graphic stays attached to frame in bag
- Hook perimeters included
- Incredibly easy, two minute set-up without tools
- Free oversized nylon carry bag with every frame
- Upgraded Portable Exhibit Cases available
- Ultra lightweight alloy tubes
- Matte silver finish
- Adjustable leveling feet
- Bolt based system, add or subtract components



Perfect for:
Tradeshows
Exhibits
Step & Repeat Backdrops
Retail Environments

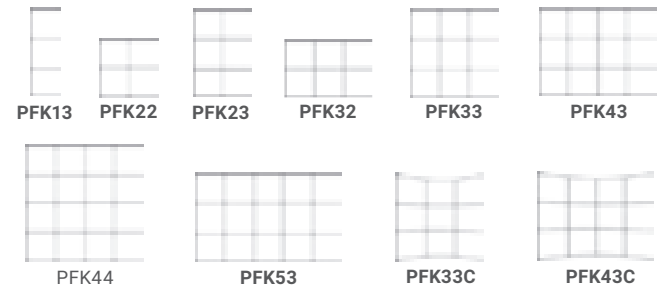

Specify: **FRAME** Model Note: **EPB1** Brackets sold separately.

Model	W x H	Weight	# EPB1 Brackets needed for use with end panels
PFK13	1 x 3 Quads	16 lbs.	8
PFK22	2 x 2 Quads	17 lbs.	6
PFK23	2 x 3 Quads	20 lbs.	8
PFK32	3 x 2 Quads	20 lbs.	6
PFK33	3 x 3 Quads	23 lbs.	8
PFK43	4 x 3 Quads	31 lbs.	8
PFK44	4 x 4 Quads	36 lbs.	10
PFK53	5 x 3 Quads	36 lbs.	8
Curved			
PFK33C	3 x 3 Quads	25 lbs.	8
PFK43C	4 x 3 Quads	31 lbs.	8

Note: Each quad is approximately 30" x 30".



PFK33 with **GF33A** graphic and (2) **LEDPU** accessory lights.

EPB1
 End Panel Bracket
 for end panel wraps



Travel Bag included with every unit.

Superwide sizes available see page 135

Presto Pop-Ups™

Tension Fabric

Presto Pop-Ups™ - Dye Sub Fabric Graphics

- High impact Dye Sub Printing on fabric
- Virtually “wrinkle free” stretch fabric
- Designed and engineered for this application
- Custom printed from your art work

Specify: **Dye Sub GRAPHIC** Model

Without End Panels W x H		with End Panels W x H	
GF13A	31" x 88.25"	GF13B	56" x 88.25"
GF22A	59.5" x 59.5"	GF22B	84.5" x 59.5"
GF23A	59.5" x 88.25"	GF23B	84.5" x 88.25"
GF32A	88.25" x 59.5"	GF32B	113.25" x 59.5"
GF33A	88.25" x 88.25"	GF33B	113.25" x 88.25"
GF43A	117.375" x 88.25"	GF43B	142.375" x 88.25"
GF44A	117" x 117"	GF44B	142" x 117"
GF53A	145.75" x 88.25"	GF53B	170.75" x 88.25"
Curved			
GF33AC	80" x 88.25"	GF33BC	105" x 88.25"
GF43AC	106" x 88.25"	GF43BC	131" x 88.25"

Note: Most Templates available online, Must add bleeds, etc.

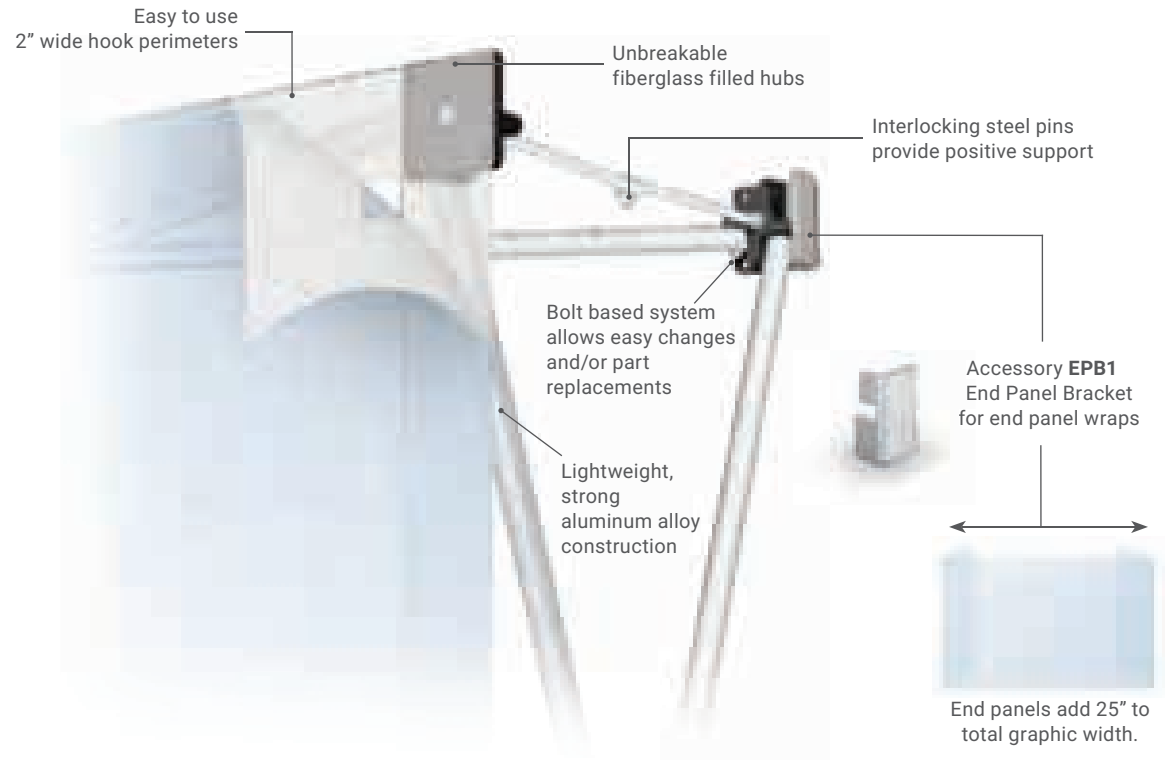

The Ultimate in Presentation Convenience!

Our American made frame is the unsurpassed standard in Quality and Value.

These units “Pop-UP” and assemble in minutes. Graphics can stay attached to frame when closed.

Presto Pop-Up displays are ultra easy to set-up and the amazing quality dye sub graphic ensures maximum impact.



Curved Presto Frame **PFK43C**, **GF43BC** graphic with end panels.

Tension Fabric Structures



EPB1 End Panel Brackets

Facilitate the wrapping of the sides, adding 25" to total graphic width. A bracket is needed for each outer hub and assembly is easy. Both straight and curved units can have their sides wrapped.



EPB1 Brackets easily attach to frame with screws.



Completely enclosed on 4 sides

Front, back and sides, End Panel Brackets are required, plus an extra Velcro® brand hook perimeter.

PFK32 straight frame, EPB1 end panel brackets, 32VB extra hook perimeter, GF32A and a GF32B graphic.

Curved unit with end panels:

PFK43C curved frame, EPB1 end panel brackets (8), GF43BC graphic face.



Marquise Shaped Steel Weighted Base

PFKWB Laser cut. Must be ordered with frames, as we pre-punch matching holes. Weight 8 lbs.

JB1 Joining Brackets

Join frames together, call to determine quantity.



Tension Fabric

SuperWide Presto Pop-Ups - A Virtual Portable Billboard

- Incredibly easy, two minute set-up without tools
- Graphic stays attached to frame in bag
- Hook perimeters included
- Ultra lightweight alloy tubes
- Matte silver finish
- Adjustable leveling feet

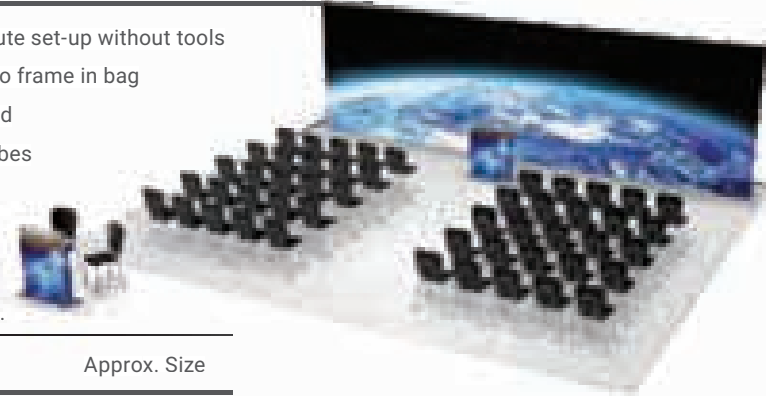

Specify: **FRAME** Model

Model	W x H	Approx. Size
PFK83	8 x 3 Quads	20' x 7-1/2'
PFK84	8 x 4 Quads	20' x 10'
PFK93	9 x 3 Quads	22-1/2' x 7-1/2'
PFK94	9 x 4 Quads	22-1/2' x 10'
PFK103	10 x 3 Quads	25' x 7-1/2'
PFK104	10 x 4 Quads	25' x 10'

Perfect for:
Tradeshows
Presentations
Symposiums

Pop-Up Lights (imported):

- Use for: Presto Pop-Ups, Collage Pop-Ups, & most other manufacturers pop-ups.



PULD1 Very bright LED trade show light for Pop-Ups, 18w.



LEDPU Cascade LED Light Extremely bright 450 Lumens, with bracket for Pop-Ups.

Podium Cases (imported):

- Hard Plastic designed for Pop-Ups
- Doubles as a Podium
- Add a Graphic Wrap to deliver your message



OPC1



OPC1 & GFW1
Graphic Wrap



OPC1 easily transportable!

Extra Bags (imported):



LNB1

Specify: Model

OPC1	24"w x 15-1/2"d x 38"h (O.D.) Podium Case. Simulated wood top
GFW1	Graphic for OPC1. Size: 70-1/2"w (includes 2" overlap) x 31"h
GFW1-PC	Pillowcase Graphic for OPC1. Template Available online
LNB1	Extra Carry Bag, 33" x 18" x 13" up to 5 x 3 frame

Allé Pillowcase™ Banner Stands

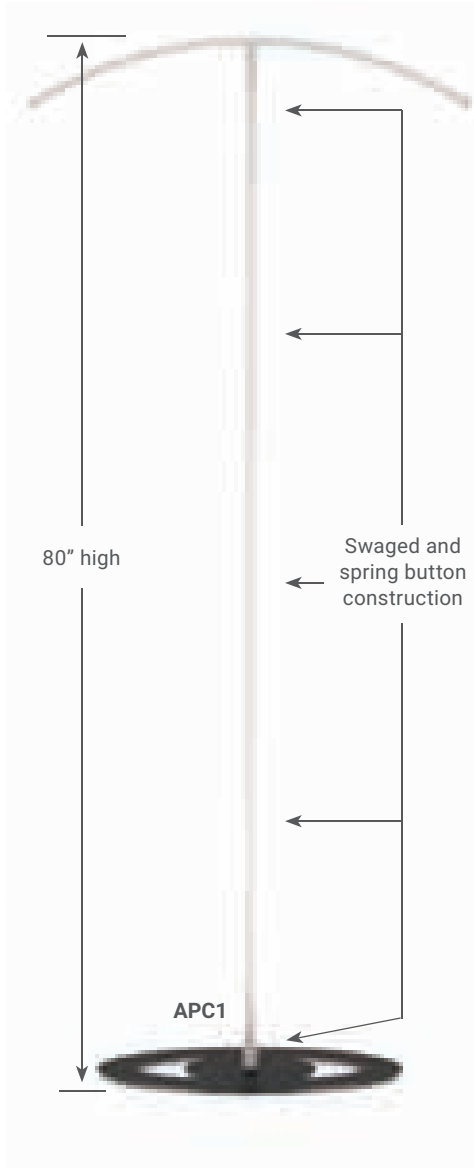

Allé Pillowcase Banner Stands™

- Constructed of aluminum alloy tubing steel weighted bases with support bushing
- 80" High and approximately 33" Wide at the top.
- Available with or without the travel bag (EBG-A)
- Available with or without stretch graphics.

Choose from three Styles

- Graphics are dye sublimated wrinkle free, stretch fabric.
- Simply pull graphics over stand like you would a pillowcase and encircle the steel base with the graphic bottom.

Pillowcase Mounting Very Fast Assembly

Curved Top



Model	Curved Top Description
APC1	Curved Top Stand only
GFX-APC	Graphic for Curved Top stand

Flat Top



Model	Flat Top Description
APF1	Flat Top Stand only
GFX-APF	Graphic for Flat Top stand

Angled Top



Model	Angled Top Description
APA1	Angled Top Stand only
GFX-APA	Graphic for Angled Top stand



Allé Pillowcase™ Banner Stands

Unique Eye Catching Shapes



APC1 with
GFX-APC



APA1 with
GFX-APA



APF1 with
GFX-APF

Model	Graphic Description
GFX-APC	Graphic for Curved Allé Stand
GFX-APA	Graphic for Angled Allé Stand
GFX-APF	Graphic for Flat Allé Stand

Simply pull graphics over stand like you would a pillowcase and encircle the steel base with the graphic bottom.



Model	Travel Bag Description
EBG-A	Travel Bag to hold the stand and graphic.

**Units ship economically and
are easy to assemble without tools.**



Graphics are dye sublimated printed on wrinkle free, stretch fabric.

Allé Pillowcase Banner Stands™

- Customized versions available and quoted on request.
- Close tolerance aluminum alloy tubing.
- Swaged and spring button construction.
- Weighted steel base with reliable support bushing.
- Units ship economically and are easy to assemble without tools.

Tornado Towers™ Banner Stands



COL24GF



Great for:
Retail
Airports
Museums
Trade Shows



Tornado Towers™

- Lightweight, 1-1/4" aluminum alloy tubing
- 84" High, either 28" or 36" top and bottom diameters
- Simple, coded swage & spring button assembly
- Custom printed Tension Fabric graphics available
- 5 lbs ballast plate included, easily add weight

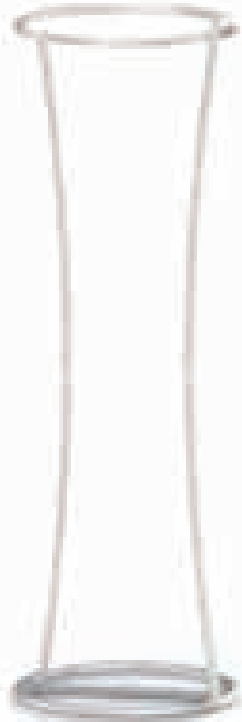

COL28



COL36

Screwdriver included for assembly,
Clips in for storage



TOR4848GF

Model	Diameter	Height	Graphic
COL28	28"	84"	COL28GF
COL36	36"	84"	COL36GF
Tornado Tapered Towers			
TOR48	48"/28"	84"	TOR48GF

Pillowcase Mounting
Stretch Fabric Graphics



Swage, spring button, construction.

Horizon Pillowcase Graphic™ Banner Stands

Portable Floor Models

- Designed for pillowcase graphics
- Swage and spring button construction
- Tool-Free coded assembly
- 1-1/4" Round tubing
- Aluminum tubing, satin silver finish



Amazingly Simple
Tool-Free Assembly!



HPF53

Triangular Structures

Model	Long Sides	Short Sides
HPF32	36"	24"
HPF42	48"	24"
HPF53	60"	36"



Rectangular Structures

Model	Size: W x H x D (O.D.)
HPF424	48" x 24" x 48"
HPF535	60" x 36" x 60"
HPF545	60" x 48" x 60"

Add Torpedo® lights for bigger Impact

- Plug and play
- ETL Listed
- Imported
- 6500K color temp.
- Must hang vertically

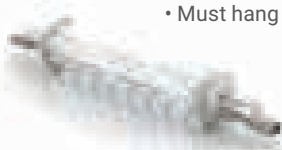

TORLED1	Torpedo LED Exhibit Light
TORLEDJC	Joiner cable to daisy chain

Ask us to quote lit before ordering
and we will pre wire for the lights



Cube Structures

Model	Size: W x H x D (O.D.)
HPF222	24" x 24" x 24"
HPF333	36" x 36" x 36"
HPF444	48" x 48" x 48"

Harmony™ Banner Stands



Harmony Banner Stands™ & HarmonyAir Banner Stands™

- 1" constant diameter aluminum uprights. Sleek design.
- Swaged, spring button, and shock cord construction.
- Curved or square tops
- Full width steel bases 12" deep offer substantial support- (Not on the HarmonyAir)
- Tubing is satin silver finish
Base color: Satin silver or matte black.
- Lightweight and portable.



HMQ4

HMQ5

HMQ6

Packaging is efficient making shipping affordable.



IMPRINTABLE

Imprint base with your logo for added impact. Additional charge applies.

Standard Models

Curved Top	Square Top	Base Width	Graphic Width	Ht.	Wt. (lbs.)	Accessory Bag
HMN1	HMQ1	24"	23-1/2"	72"	15	EBP-2
HMN2	HMQ2	30"	29-1/2"	72"	17	EBP-3
HMN3	HMQ3	36"	35-1/2"	72"	19	EBP-3
HMN4	HMQ4	24"	23-1/2"	84"	16	EBP-2
HMN5	HMQ5	30"	29-1/2"	84"	18	EBP-3
HMN6	HMQ6	36"	35-1/2"	84"	20	EBP-3

Specify: Color* -S Satin Silver or -B Matte Black



Specify: -A for Tubular Base

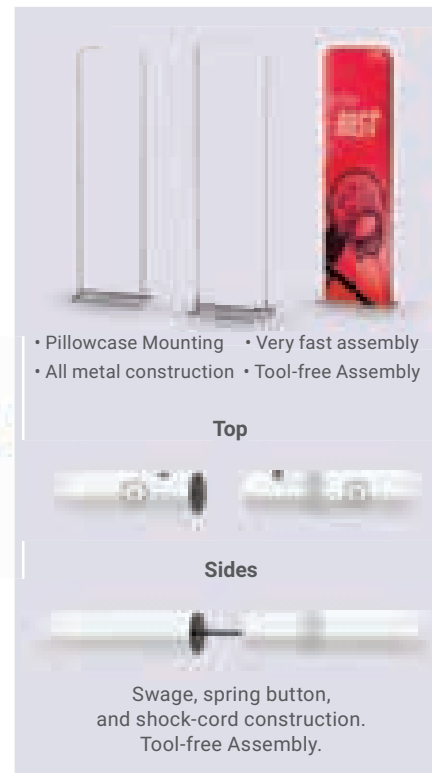

- Pillowcase Mounting
- Very fast assembly
- All metal construction
- Tool-free Assembly

Top



Sides



Swage, spring button, and shock-cord construction. Tool-free Assembly.



Accessory Bag EBP-2
inside dimensions 3" x 12" x 24"

HMN4

Harmony™ Banner Stands

LED Light Source

- LEDLF Cascade LED Light Source with clamp for banner stand attachment. (imported)

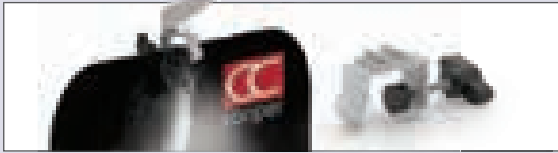

HarmonyAir Base Option

- Optional "Air" aluminum tubular bases.
- To order just add "-A" to the part number. The cost is the same.
- EBG-S - bag for all Harmony Airs

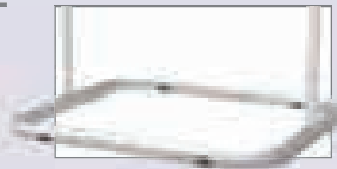

Super lightweight for Traveling

Available Bags (imported)

- EBG-A - Lightweight bag holds Harmony Air and graphics
- EBP-2 - 3" x 12" x 24" inside dimensions
- EBP-3 - 3" x 12" x 36" inside dimensions
- EBG-S - Rolling duffel carry on bag.



EBG-A



EBG-S

Choose Square Top or Round

Top and bottom, Swage & spring button construction

All metal construction

Middle sections, Swage with shock cord

Middle sections, Swage with shock cord

Top and bottom, Swage & spring button construction

12"

20"

20"

20"

HMQ1-S

HMN1-S-A with Harmony Air tubular base (only 3 lbs.)

Mercury Retractable™ Banner Stands



RY1-S with LEDBR1 light.

Most Reliable, Best Value Retractable Anywhere!

- Infinite height adjustments 36" to 96"
- Available single and double sided
- Instant set-up and take-down
- Handsome satin finishes
- Models up to 60" wide
- Aluminum construction
- **Free** soft travel bag with every unit!

Good for many types of media substrates- vinyl, fabric, laminated film and more.*

* 15 mil max. Laminate one side only.
Must be pliable to roll up tightly.

Model	Description	Graphics Width	Weight. lbs
RY1	1-Sided	36"	12
RY2	2-Sided	36"	18
RY3	1-Sided	24"	11
RY4	2-Sided	24"	14
RY5	1-Sided	48"	14
RY6	2-Sided	48"	23
RY7	1-Sided	60"	18
RY8	2-Sided	60"	29
RY9	1-Sided	33"	12
RY10	2-Sided	33"	18

Specify: Color* -S Satin Silver or -B Matte Black  

RY1-S-HC
Banner Stand
w/ Hardcase Kit.



Hard Case Option

- Units 36" wide and less can be ordered with Hard Cases, simply add -HC after part #.

For example: **RY1-S-HC**

Case Model	Description	Model
HC4213-RY24	Hard case with inserts for	RY3 or RY4
HC4213-RY36	Hard case with inserts for	RY1 or RY2

Case Dimensions: 43"w x 14.5"d x 5" h, adds 13 pounds.

The above are cases & inserts only - No Banner Stands.



Satin Silver

- Sleek new styling
- Assemble without tools



Matte Black

- Lightweight, portable
- No loose parts to lose



Tool Free Assembly!

Mercury Retractable™ Banner Stands

Velcro® Brand Hook/Loop Mount Top & Bottom Compare ours versus the competition

- Tool-free assembly
- Infinitely adjustable up to 8 feet high
- Easy to use Velcro® brand hook & loop
- Free soft travel bag with every unit
- An incredible quality & value proposition
- No cartridges to buy
- Built to last
- Still made in the USA with pride!

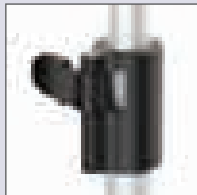

"G" Lock allows quick height adjustments.

Tremendous value & still made in the USA!



2-sided case

Our Mercury Retractable Banner Stands™ are work horses!



Adjustable to 96" high



Note: We use only Velcro® brand hook & loop with a pressure sensitive adhesive specially formulated not to damage graphics. Hook comes attached to bar & leader. The loop attaches to the graphic top & bottom.

SignPost™ Pole Pocket Banner Stands

SignPost™ > the ultimate combination of stability and European styling.



YB2818-S with
(2) **CRLSRM** Literature Holders



YB1618-S
with (2) **CRJH** J Hooks optional.



YB1618-S



YB2824-S with (1) **CRLSRM-S**
Literature Holder optional

SignPost™ Pole Pocket Banner Stands (Note: 96" Uprights are in 2 sections)

- 72" or 96" aluminum alloy upright
- Weighted, 16" square steel bases
- Satin silver or matte black finish
- Welded steel graphic rods 18" or 24" long
- Other accessories available
- Proudly made in the U.S.A.

Available as complete displays
as shown, or create your
own custom SignPost™

SignPost™ Pole Pocket Banner Stands



YB2824-S



YB2618-S

Sleek, 5/8" diameter tubes
tighten anywhere along track

Aluminum
face-out puck

Pole Pocket Banners

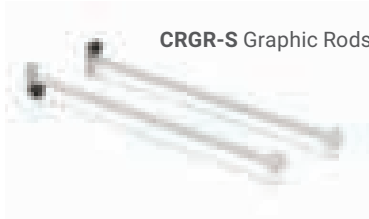

CRGR-S Graphic Rods

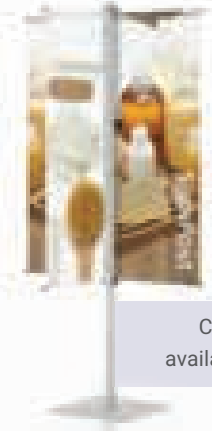

Custom units
available in quantity.

* Specify: Model (Note: 96" Uprights are in 2 sections) — Color*

Model	Height	Banners	Max. Banner Ht.	Width
YB1618	72"	1	63"	18"
YB1624	72"	1	63"	24"
YB1818	96"	1	87"	18"
YB1824	96"	1	87"	24"

Model	Height	Banners	Max. Banner Ht.	Width
YB2618	72"	2	63"	18"
YB2624	72"	2	63"	24"
YB2818	96"	2	87"	18"
YB2824	96"	2	87"	24"

Color*  

-S Satin Silver

-B Matte Black

*Does not affect price

Banner Stands

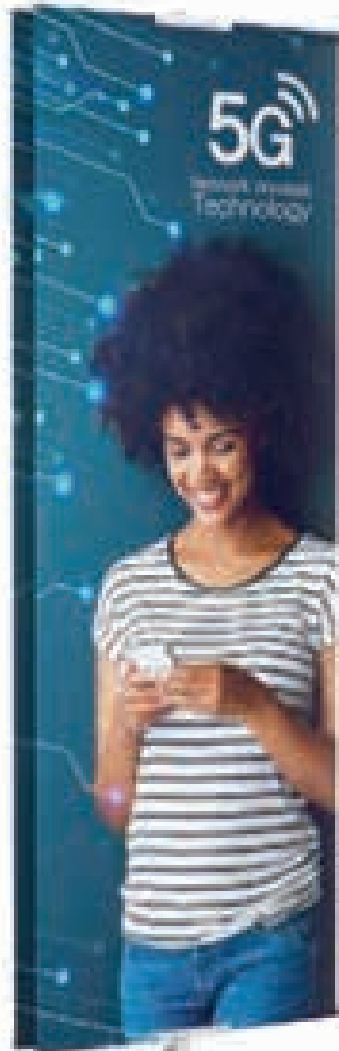

BN2-SQ-S

Classic Banner Stands™ Pole Pocket Mounting

- Adjustable height center poles and lightweight metal construction
- Top dowel holder attaches to pole top, bottom dowel holder can travel up & down
- User friendly and built to last!

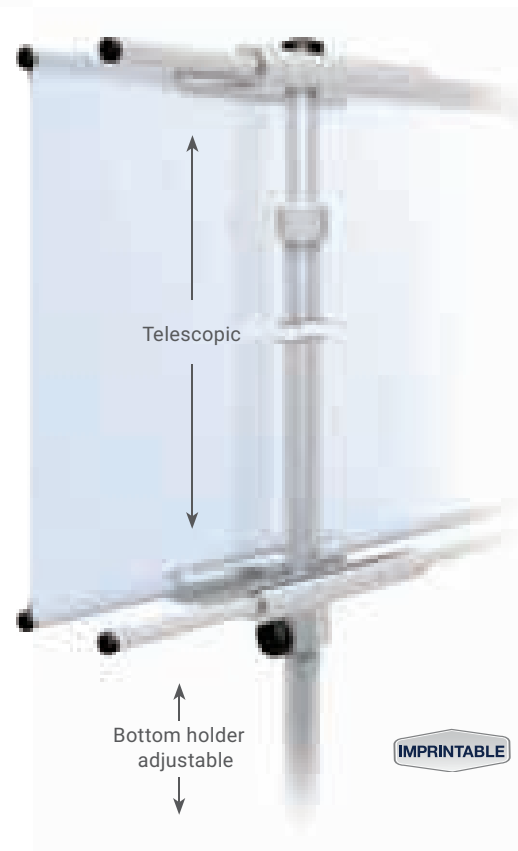

Simply hem banners top & bottom, put dowels in and slide into holders.

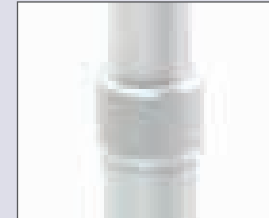

Solid aluminum adjustable clutch lock.

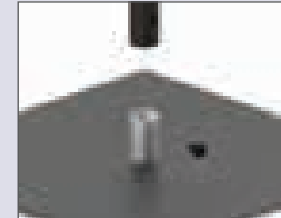

Bases feature solid support bushing.

Base Options

- **SQ** Square steel with inner support bushing, in a handsome satin silver or matte black finish.
- **RD** Round base with inner support bushing, satin powder coated finish.
- **TB** Travel Base: Modern design. Fits in travel bag. Textured powder coated finish.
- **PB** Presto Base: Internal shock cord mechanism, assembles instantly. Use with travel bags.



Specify: Color* -S Satin Silver or -B Matte Black

Model	Banners	Width	Sq Base	Telescopic Height	Wt. (lbs.)
BN1-SQ	1 or 2	12"	8	24" - 42"	5
BN2-SQ	1 or 2	24"	12	36" - 96"	8
BN3-SQ	1 or 2	36"	16	42" - 114"	15

Banner Stands

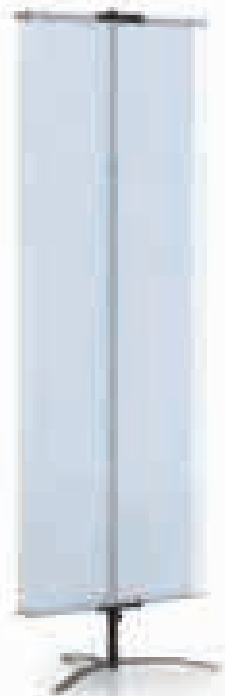

BN2-TB-B
Travel Base.
Use with travel bags.

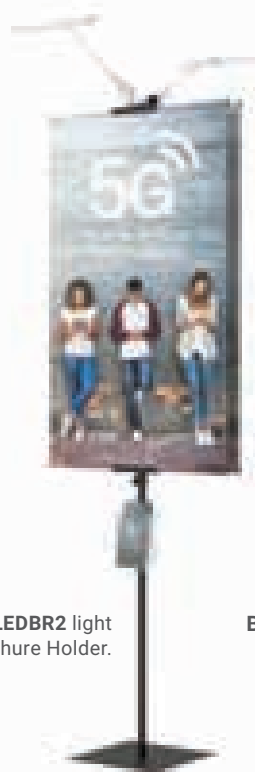

BN2-SQ-B with LEDBR2 light
and LHP-C-1 Brochure Holder.

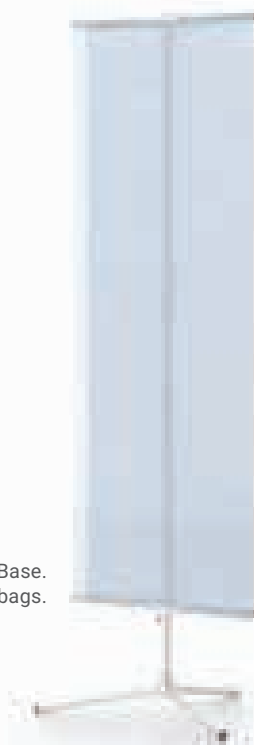

BN2-PB-S Presto Base.
Use with travel bags.

Adjustable
to 96" high



BN2-RD-S Round Base.
The most elegant style.

Accessories

• Lights, Bags & Literature Baskets available.



LEDBR2 light



LHP-C-1

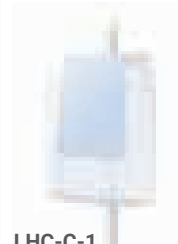

LHC-C-1

Extra Cost Bases

– **RD** Round Base: Heavy duty steel bases, beautiful baked on powder coated finish.

BN1: 1/8" x 6-3/4" (1-1/2 lbs.)

BN2: 3/16" x 11" (5 lbs.)

BN3: 3/16" x 15" (9 lbs.)



– **PB** Presto Base: Internal shock cord mechanism, assembles instantly. Use with travel bags.



Banner Stands



Velcro® Brand Hook/Loop Mount

- Trouble free clutch for secure locking
- Bottom crossbar can travel up & down
- Adjustable height 36"-96" center poles
- Hook/Loop Mount top crossbar attaches to pole top
- Custom variations available
- User friendly and built to last!

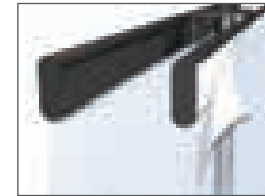
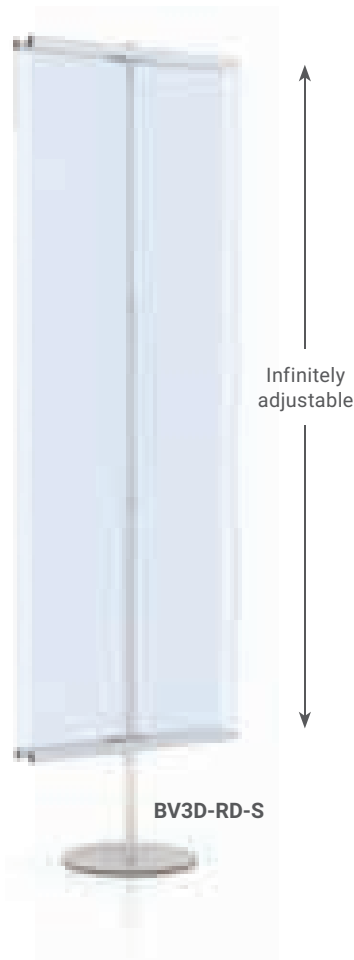

Oval crossbars with Velcro® brand Hook/Loop included.

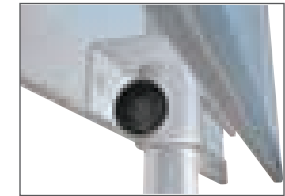

Bottom crossbars can be raised and lowered.

Base Options

- **SQ** Square steel with inner support bushing, in a handsome satin silver or matte black finish.
- **RD** Round base with inner support bushing, satin powder coated finish.
- **TB** Travel Base: Modern design. Fits in travel bag. Textured powder coated finish.
- **PB** Presto Base: Internal shock cord mechanism, assembles instantly. Use with travel bags.

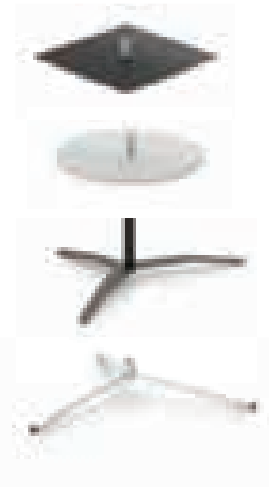

Specify: Color* -**S** Satin Silver or -**B** Matte Black



Square Base	Travel Base	Presto Base	Round Base	Graphic Width
BV2-SQ	BV2-TB	BV2-PB	BV2-RD	24" Single
BV2D-SQ	BV2D-TB	BV2D-PB	BV2D-RD	24" Double
BV3-SQ	BV3-TB	BV3-PB	BV3-RD	36" Single
BV3D-SQ	BV3D-TB	BV3D-PB	BV3D-RD	36" Double

Banner Stands



Velcro® Brand Hook/Loop Mount



Center poles accept graphics 36" to 96" tall.

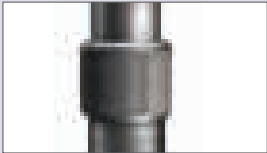

Solid aluminum adjustable clutch lock.



Solid inner bushing ensures stability.



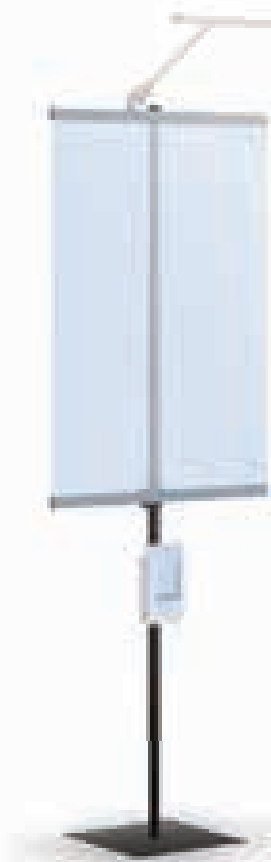

Crossbars feature aluminum brackets and Velcro® Brand Hook/Loop.

Custom variations available!

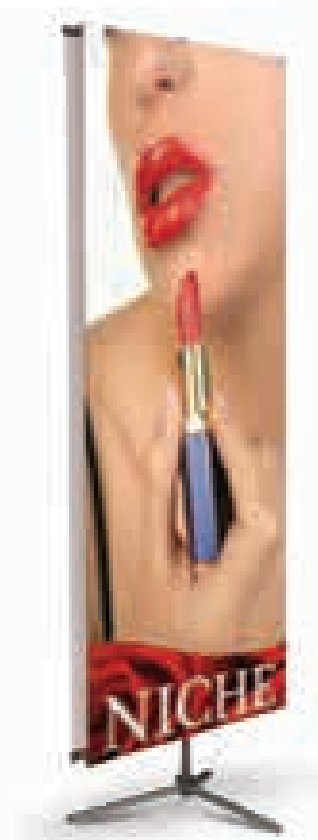

BV2-SQ-B with LEDBR1 light and LHP-C-1 Brochure Holder.



-PB Presto Base



-TB Travel Base

Accessories

- Lights, Bags & Literature Baskets available.

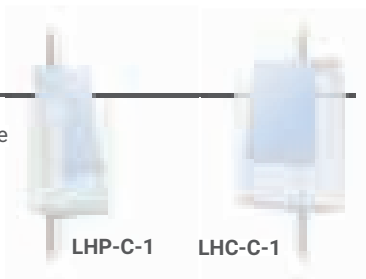

LHP-C-1

LHC-C-1

Nexus SnapBar™

Banner Stands

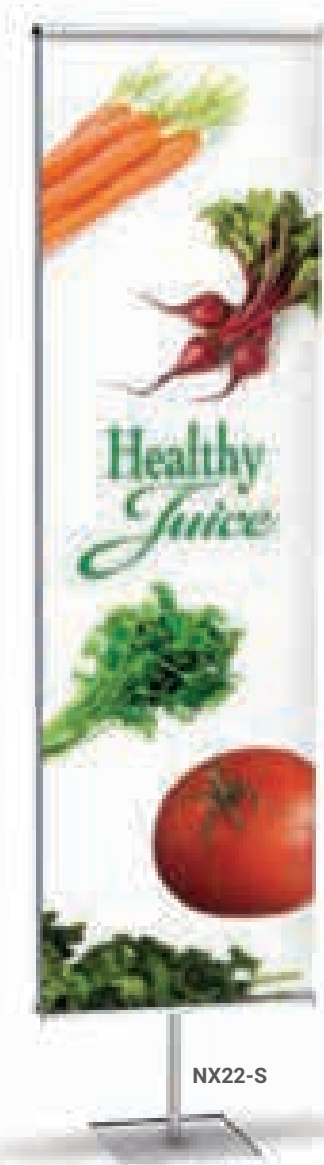

SnapBar Graphic Mounting

- Trouble free clutch for secure locking
- Bottom crossbar can travel up & down
- Adjustable height 36"-96" center poles
- User friendly and built to last!
- No graphic end finishing required

Easy Open SnapBars
hold graphics firmly

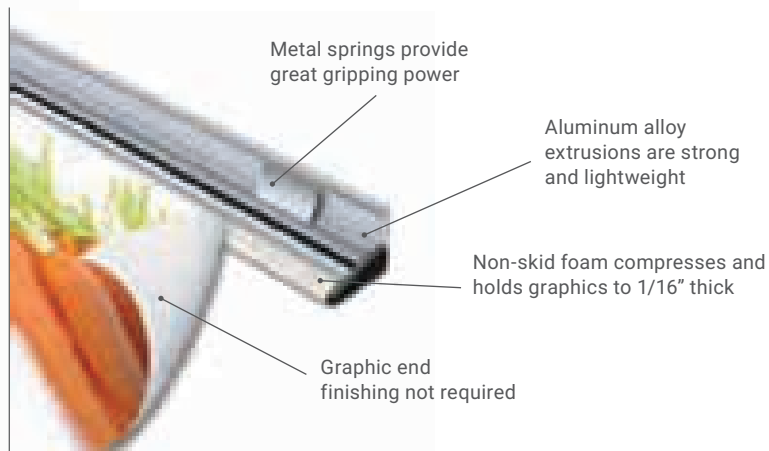

Choice: 1 sided or 2 sided, 24", 30" or 36" width

Model	Description	Width
NX21	1-sided	24"
NX22	2-sided	24"
NX251	1-sided	30"
NX252	2-sided	30"
NX31	1-sided	36"
NX32	2-sided	36"

Specify Color*	Color
-S	Satin Silver
-B	Matte Black

*Doesn't affect price.



Single Sided



Single Sided

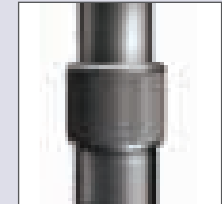

Solid aluminum adjustable clutch lock.

Double Sided

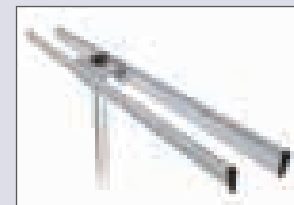

Double Sided

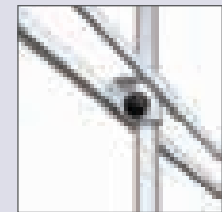

Adjustable

Standard Base

- Square bases with support bushing, satin silver or matte black finish.

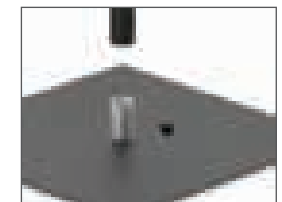

Base Option

- **TB** Travel Base: Steel, modern design. Textured powder coated finish. Folds up. Same cost - **specify -TB.**



GripGraphic™ Banner Stands

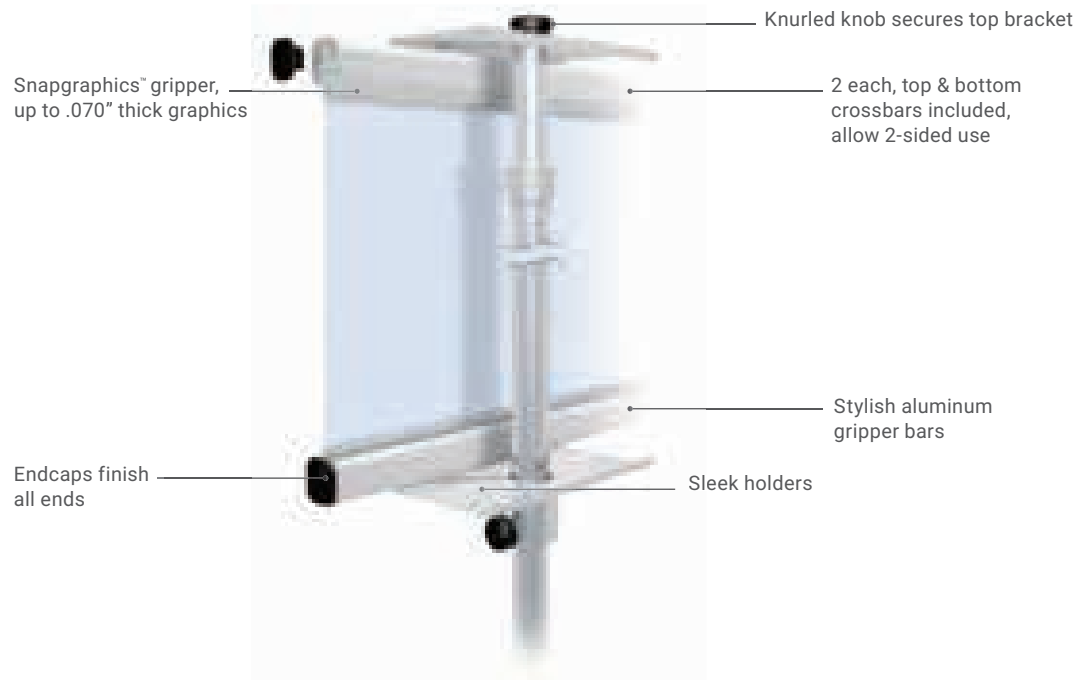

SnapGraphics Gripper Bars™
Ingenious bar snaps closed after graphic insertion with incredible strength, torque and care

- 4 bars included with every stand
- Telescopic uprights with knurled locks
- Display 1 or 2 graphics, back to back

Specify: Color* **-S** Satin Silver or **-B** Matte Black

Model	Height	Width	Standard Base*	Presto Base PB	Round Base RD
GS2	36" - 96"	24"	12" square	Shock Chord	11"
GS3	42" - 114"	36"	16" square	NA	15"

Specify: * **TB** Travel Base also available

IMPRINTABLE

Standard Bases

- Standard bases are square with inner support bushing, in a handsome satin silver or matte black finish.



- **TB** Travel Base: Modern design. Fits in travel bag. Textured powder coated finish. **-TB**.

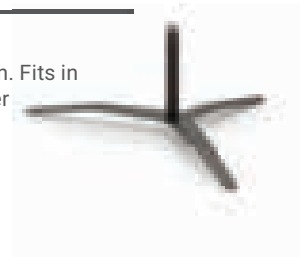

Banner Stands

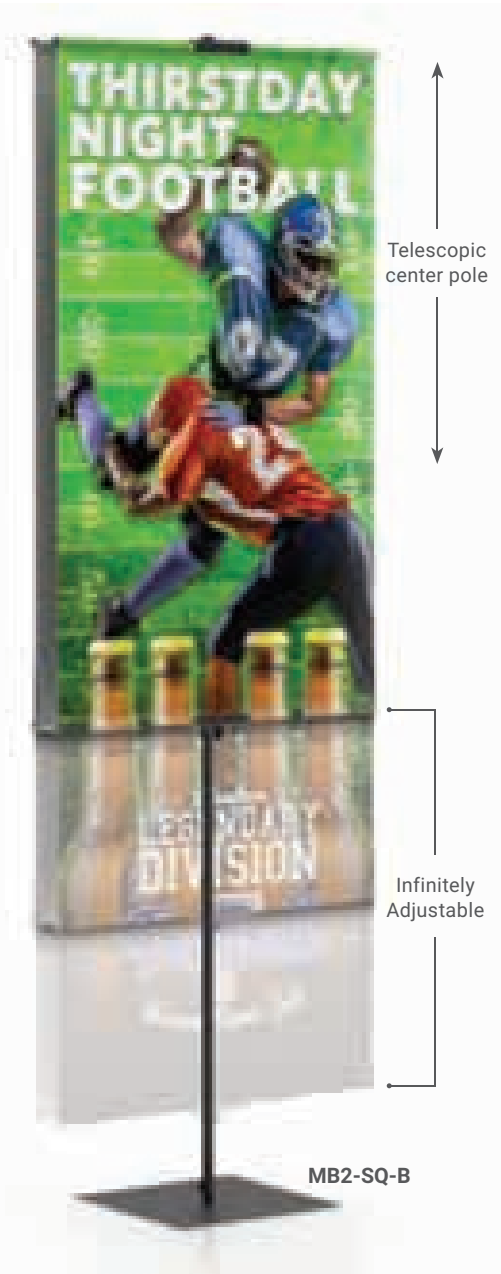

Telescopic center pole

Infinitely Adjustable

Promo Banner Stands™

- Adjustable height, all stands accept graphics up to 72" high
- 3 Mounting Choices: Pole Pocket, SnapGraphic™, Hook/Loop
- Great price points!

Model	Mounting	Width
MB1	Pole Pocket	Single 24"
MB2	Pole Pocket	Double 24"
MB3	Hook/Loop	Single 24"
MB4	Hook/Loop	Double 24"
MB5	SnapGraphic	Single 24"
MB6	SnapGraphic	Double 24"

Other widths available special order. Stands close to 38-3/8"

Color	
-S	Satin Silver
-B	Matte Black

"G" Lock

- "G" Lock allows quick height adjustments to 72"
- 5/8" & 3/4" aluminum tube diameters



MB3-SQ-B,
Shown with bottom holder 30" off floor, **LEDBR1** Light, and **LHP-C-1** Brochure Holder

Standard Bases

- **SQ** Standard Square Base: 12" steel base, 3-3/4 lbs. Solid inner bushing ensures stability. Powder coated finishes.



- **TB** Travel Base: Modern design. Fits in **EBGX** travel bag.. Textured powder coated finish.

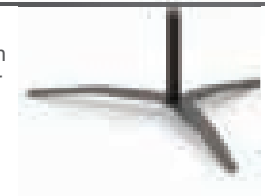

Budget™

Banner Stands



Budget Banner Stands™

Economical, Portable!

- 70" Height, single sided
- 12" square, 3-3/4 lb. base
- 1/2" Aluminum dowels
- 2 section 1" tube assembly
- Braided rope

Model	Width
BDG1	24"
BDG2	30"

Specify Finish	
-S	Satin Silver
-B	Matte Black

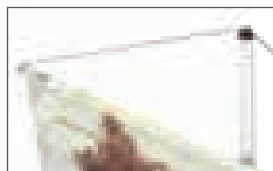

Diamond braided rope fits slot in dome shaped cap.



Inner bushing ensures stability of 12" square base.

BDG2-S

GCO GripGraphic™ Banner Stands

GripGraphic Oval Banner Stands™

Oval co-extruded bars deliver exceptional gripping power at an economical price point.

- No pockets or graphic end treatment required
- Closes easily once graphic is inserted
- Telescopic upright holds graphics up to 96" high
- Bars hold 24" wide graphic media to 3/32" thick
- No pockets or graphic end treatment required!

Model	Description
GCOBS1	Holds one 24" Banner
GCOBS2	Holds two 24" Banners

Finish:	
-S	Satin Silver

Patented Technology!

U.S. Utility Patent # 6,637,716
U.S. Design Patent # D-424,120

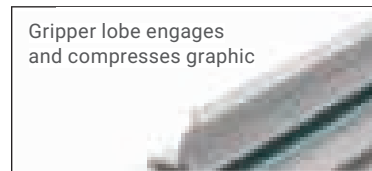

Gripper lobe engages and compresses graphic



GCOBS2-S

Bases feature an inner support bushing.

Adjustable Large/Grand Format™ Banner Stands

Sturdy Construction – Feel the Quality



Features

- Telescopic height 37"-96" • Two 3" x 17" formed steel bases
- Pole pocket mounting • Great portability. 5 minute assembly

Standard Tubing

Model	Width	Upright Diameters	Crossbar	Hem
BN4	30"-48"	3/4"-7/8"-1"	1-1/8" Diameter	2"
BN5	52"-96"	3/4"-7/8"-1"	1-1/8" Diameter	2"
BN6	24"-42"	3/4"-7/8"-1"	1-1/8" Diameter	2"
EBGH	Travel bag holds 1 Banner Stand and 1 Conversion Kit			

Jumbo Diameter Tubing

Model	Width	Upright Diameters	Crossbar	Hem
JN4	30"-48"	1-1/4"-1-3/8"-1-1/2"	1-5/8" Diameter	3"
JN5	52"-96"	1-1/4"-1-3/8"-1-1/2"	1-5/8" Diameter	3"
JN6	24"-42"	1-1/4"-1-3/8"-1-1/2"	1-5/8" Diameter	3"
EBGH	Travel bag holds 1 Banner Stand and 1 Conversion Kit			

Specify: Color -**S** Satin Silver or -**B** Matte Black



Note: For heavy weight vinyls & graphics, special order uprights with B locks. Extra cost applies.



Sturdy Steel
"Bridge" Support Base.



Twist lock offers infinite
horizontal and vertical adjustments.

Adjustable Large/Grand Format™ Banner Stands

Conversion Kits for Grand Format!

- Convert BN5 & JN5 up to 10' & 12' high & wide.

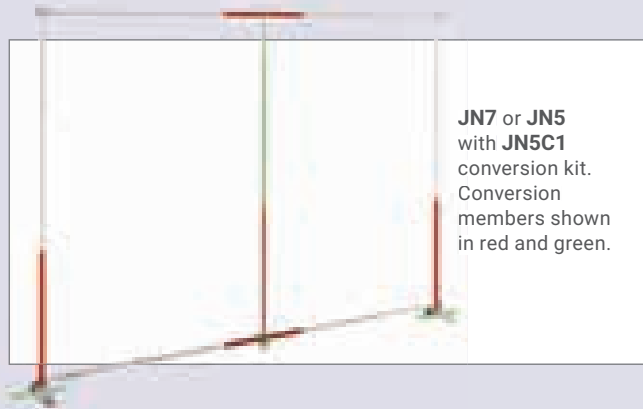

JN7 or JN5
with **JN5C1**
conversion kit.
Conversion
members shown
in red and green.

Conversion Kits

Model	Kits	Inserts and Center Support
BN5C1	10' Kit for BN-5	5 inserts & 1 center support
BN5C2	12' Kit for BN-5	10 inserts & 1 center support
JN5C1	10' Kit for JN-5	5 inserts & 1 center support
JN5C2	12' Kit for JN-5	10 inserts & 1 center support
EBGH	Travel bag holds 1 conversion kit & 1 banner stand	

Note: Center support requires a notch in the banner back.

Specify: Color* **-S** Satin Silver or **-B** Matte Black

Complete Kits - Large/Grand Format

- Include banner stand and conversion kit. • Custom Kits also available in significant quantities.

Standard Tubing

Model	High & Width	Upright Diameters	Crossbar	Graphic Hem	Specify Color*
BN7	Up to 10'	3/4"-7/8"-1"	1-1/8" Diameter	2"	-S Satin Silver
BN8	Up to 12'	3/4"-7/8"-1"	1-1/8" Diameter	2"	-B Matte Black

Jumbo Tubing

Model	High & Width	Upright Diameters	Crossbar	Graphic Hem	Specify Color*
JN7	Up to 10'	1-1/4", 1-3/8"	1-5/8" Diameter	3"	-S Satin Silver
JN8	Up to 12'	1-1/4", 1-3/8"	1-5/8" Diameter	3"	-B Matte Black

Snap-On Crossbar Kits

- Accessory telescopic crossbar attaches anywhere along the uprights. Includes 2 snap-on glide sizes.



Model	Lg/Grand Format
BN4SOC	for BN4
BN5SOC	for BN5
BN6SOC	for BN6
JN4SOC	for JN4
JN5SOC	for JN5
JN6SOC	for JN6

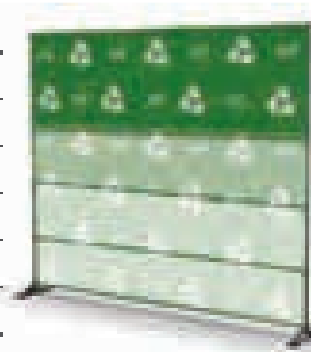

Travel Bag

- **EBGH** Travel Bag (imported): will hold a banner stand and a conversion kit.



Rings

- **RG5** Set of 4 rings holds foam core or plastic graphics with grommets

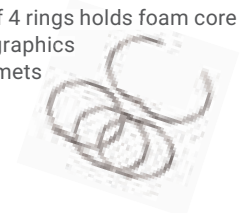

Crowd Q Stand™

Banner Stands



Stands can be used individually, or use multiple to create continuous walls

Help direct customers exactly where you need with Crowd Q Stands! Ideal for indoor environments, fast deployment, and are extremely flexible.

Stands can be used individually, or use multiple to create continuous walls or complete enclosures. Each base has 2 stems, with connection points to continue straight in either parallel direction, or perpendicular to form a 90 degree angle.



Swage, spring button, construction.



Fabric Cover Options

- **GFX-CROWD-P** - Double sided printed fabric from your art work
- **GFX-CROWD-B** - Black fabric cover (no custom printing)
- **GFX-CROWD-W** - White fabric cover (no custom printing)
- Unit fits into **EBP-3** Bag (sold separately)

Crowd Q Stand™

- 1-1/4" Aluminum tubing construction
- 81" W x 36" H Graphic size - Total stand height 39-1/4"
- Each stand includes qty (2) 3" W x ~17" Long steel bases
- Each base has 2 stems to allow building continuous walls or 90 degree angles
- Fabric cover sold separately, available as an add on

Model	Width	Height	Color
CROWD-8136-D-S	81"	36"	-S Satin Silver



EBP-3 Bag (sold separately)
Premium Padded Bag, 3" X 12" X 36"



American Eagle Banner Stands



Satin finished aluminum tightening pucks



8' & 10' wide units have droop preventor

Quality constructed, built to last

FBS86-S



Elegant - Fixed Width Banner Stands

- Lightweight & strong
- Pole pocket mounting
- Satin finishes
- Portable, built to last
- Steel weighted bases
- 8' & 10' sides come in 2 screw together sections
- Aluminum alloy

Model	Graphic w x h	Model	Graphic w x h
FBS56	60" x 72"	FBS58	60" x 96"
FBS66	72" x 72"	FBS68	72" x 96"
FBS86	96" x 72"	FBS88	96" x 96"
FBS108	120" x 96"	FBS1010	120" x 120"

Color 
-S Satin Silver

Unit ships knocked down for cost efficient transit.

Banner Stands

Lightweight, Strong - Pole Pocket Mounting

- Aluminum alloy
- Telescopic height 37"-96"
- Tube diameters 3/4"-7/8"-1"
- Hem for 3/4" diameter crossbars



Banner Stands

Model	Crossbar Width
B2X	24"
B25	30"
B3X	36"
B4X	48"

Specify Finish*  

-S Satin Silver

-B Matte Black

*Doesn't affect price.

Step Crossbar Accessory

- Allows bottom of banner to be mounted at any height.



Crossbar Section	Width
SCK1	24"
SCK2	30"

Crossbar Section	Width
SCK3	36"
SCK4	48"

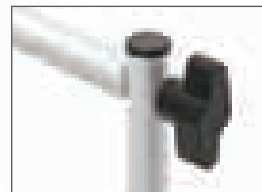



Standard ergonomic knob.



PK aluminum pucks an extra cost option.

Towers

Triangle Tower	Square Tower	Crossbar Width
TR1	SQ1	24"
TR2	SQ2	30"
TR3	SQ3	36"
TR4	SQ4	48"

Specify: Color* **-S** Satin Silver or **-B** Matte Black  

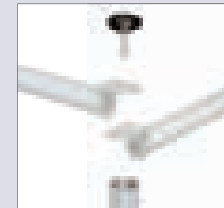

Tool-Free Assembly

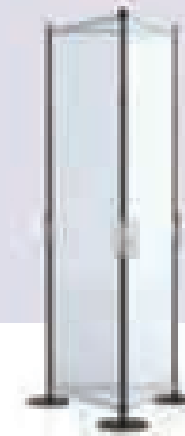

TR1-B with LHP-C-1 pamphlet holders.



SQ2-S

Banner Stands

Torpedo LED Lights Uses:



Charisma 3D



Hanging Halos



Horizon Pillowcase

Model	Description
TORLED1	Torpedo LED Exhibit Light
TORLEDJC	Daisy Chain Joiner Cable



TORLEDJC

Torpedo LED Exhibit Lights (imported)

- Plug in and light; no separate ballast
- An amazing amount of light
- Super bright 5000 Lumens, 41 Watt
- Includes hanging point on each end
- 6500K color temp, 360° full circle beam
- Daisy chain up to 6 with joiner cables **TORLEDJC**
- ETL Listed, includes 8' Power cord

Must use vertically

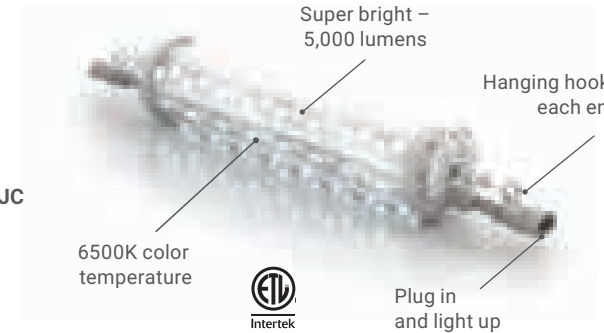

LED Light Source (imported)

- Extremely bright 450 Lumens
- Cool white color temperature
- 50,000 working hour lifetime
- 6 watt, 12 volts, 10-1/2" wide
- Wide movable swivel head



Accessory Bag (imported)

- Accessory Bag fits all Cascade Lights

Model	Description
EBGC	22" x 4" x 3"



Portable Utility Light Outfit

- Light source includes 10" diameter reflector
- Use with 75 watts or less
- Great for general lighting use
- 3-section stand extends to 7'
- Weight: 4 lbs
- Bulb not included

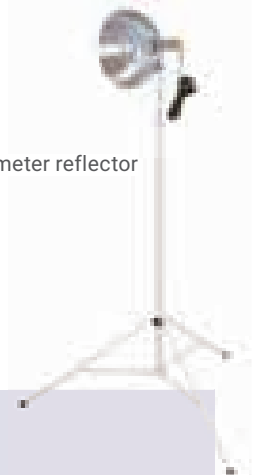

LEDBR1

Cascade LED Light Source with bracket for one-sided banner.

- Use for Banner Stands: **BN2, BN3, BV2, BV3, RY1, RY3, RY5, RY7 (2), NX21, NX251, NX31, GCOBS1, UB3, UB5, GS2, GS3, MB1, MB3, MB5.**



LEDBR2

2 Cascade LED lights with bracket for two-sided use.

- Use for Banner Stands: **BN2, BN3, BV2, BV3, RY2, RY4, RY6, RY8, NX22, NX52, NX32, GCOBS2, GS2, GS3, MB2, MB4, MB6.**



LEDLF

Cascade LED Light Source with clamp for banner stand attachment

- **BN4, BN5 (2), BN6, JN4, JN5 (2), JN6, B2X, B25, B3X, B4X,** Apollo Stands, Straight Flat Walls (2), Harmony & Visual Graphic Stands, Mega Wave Walls, Cool C Walls.

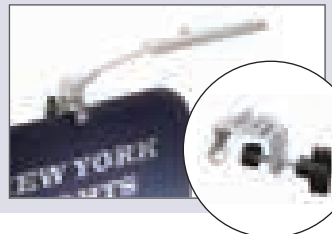

LEDCC

Cascade LED Light Source with C Clamp for multipurpose use.

- Great for: Table tops, and flat divider walls. Clamps to horizontal and vertical surfaces. Grip range open to 2-1/2".



LEDPU

Cascade LED Light Source with bracket for Pop-Ups

- Use for: Presto Pop-Ups, Collage Pop-Ups, & most other manufacturers pop-ups.

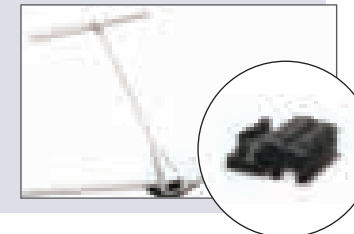

Travel Bags

Banner Stands

All bags on this page are imported.



EBGX Bag with BN-2STB inside

Model	Description
EBGX	For Models BN , BV , MB , and GS stands that have TB Travel Bases or PB Presto Bases. Also good for UB stands (except 48" models). Bag is 44" long & has top zippered compartment



EBGH

Model	Description
EBGH	Padded carry case, 39" long, features 4" round protected graphic holder and a compartment to hold lights and extensions. Good for all Model BN2 , BV2 , & GS2 Banner Stands with TB Travel or PB Presto Bases; also good for UB , JN4 , 5, & 6, BN4 , 5, & 6 Banner Stands.



EBG8

Model	Description
EBG8	54" long single compartment bag
EBG9	63" long single compartment bag, (not shown)



Model	Description
EBGM	Huge, monster sized soft nylon bag, for multipurpose use. 79" w x 22"h x 2" d



LNB1

Model	Description
LNB1	33" x 18" x 13" Duffle type carry bag



EBGLR

Model	Description
EBGLR	Well designed nylon carry bag for portable use. Features a special compartment with straps to hold 12" square base securely. 24" x 9-1/2" x 12"



EBG-A

Model	Description
EBG-A	Travel Bag to hold the Allé Stand and graphic.



EBGC

Model	Description
EBGC	22" x 4" x 3" bag for Cascade Lights only.



EBG6 Bag with BN4S

Model	Description
EBG6	For all two-sided support models BN4 , BN5 , BN6 , JN4 , JN5 , JN6 , B2x8 , B258 , B3x8 . Multi-pocketed bag has full length center zipper. Length 40"

Premium Padded Bags

Banner Stands

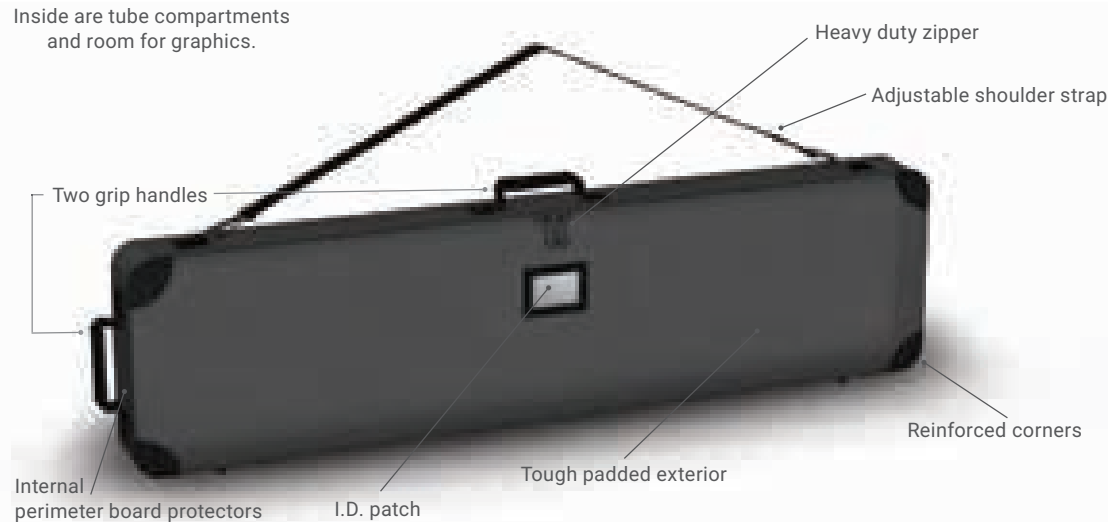

All bags on this page are imported



Model	Description
EBP2	Inside dimensions 3" x 12" x 24"



Model	Description
EBP3	Inside dimensions 3" x 12" x 36"



IMPRINTABLE

A Terrific New Padded Bag Series

- With lots of great features sized for excellent utility.
- Imprint available in quantity, additional charge applies.

Model	Product Description
EBP2	HMN1, HMN4, VG62, PVT1, PVT2, SBR1TP, SBR2TP, SBR3TP, SBR7TP, SBR8TP, SBR9TP, 1PDTR, 1PPDTF, BN1
EBP3	HMN2, HMN3, HMN5, HMN6, RY1, RY2, RY3, RY4, BN2, BV2SQ, BV2DSQ, NX21, NX22, NX251, NX252, NX31, NX32, GS2, BN4, BN5, BN6, JN4, JN5, JN6, B2X, B25, B3X, TR1, TR2, TR3, VCST1, VCST2, FW088, VG63, VG64, VG82, VG83, VG84, C3, GCOB51, GCOB52, PVC3, PVC3C, PVC4, PVC4C, PVC5, PVC5C, PVC6, PVC6C, PVT3, PVT4
EBP4	RY5, RY6, CBR2, CBR3, CBR4, CENT2, CENT3, CENT4, UB324, UB336, UB424, UB436, UB524, UB536, UB548, UB624, UB636, UB648, MB1, MB2, MB3, MB4, MB5, MB6, B4X, SBR1, SBR2, SBR3, SBR7, SBR8, SBR9, C2, COH1, IPDSRD, IPDSSQ, IPHB2, IPHC1, IPHC2.

Model	Description
EBP4	Inside dimensions 3" x 12" x 48"

Hard Shipping Cases

Banner Stands



Thermoformed Shipping Cases

- Models: **HC3919, HC4526, HC5315, HC5325, HC6522:**
Rugged thermoformed polyethylene construction.

Common Features:

- Strong steel rubber grip carrying handles
- Sturdy 1-1/2" straps with buckles
- Large 8" x 12" label area
- Heavy duty built-in durable wheels



HC3919



HC4526

Model	Description	Weight	Style
HC3919	39" x 19" x 5-1/2"	20 lbs.	Thermoformed
HC4526	45" x 26" x 9-1/2"	28 lbs.	Thermoformed
HC5315	53" x 15" x 12"	25 lbs.	Thermoformed
HC5325	53" x 25" x 10"	34 lbs.	Thermoformed
HC6522	65" x 22" x 9"	33 lbs.	Thermoformed

Note: Some of these cases ship dimensional weight, not actual weight via UPS or FedEx.



HC5325

Fabricated Board Shipping Cases

- Models: **HC4213, HC6317:**
Fabricated board, steel reinforced corners, riveted construction.

Cases on this page are made in the U.S.A.



HC4213



HC6317

Model	Description	Weight	Style
HC4213	42" x 13" x 5"	11 lbs.	Fabricated Board
HC6317	63" x 17-3/8" x 12"	24 lbs.	Fabricated Board

Note: Some of these cases ship dimensional weight, not actual weight via UPS or FedEx.

Podium and Exhibit Cases

Banner Stands

Cases on this page are imported.

Portable Exhibit Cases

Stylish design and versatile portability at a reasonable cost. Great for transporting Presto Pop-Ups™ and Collage Pop-Up™ units.

- Padded soft outer shell
- Airline checkable
- Rigid protective plastic liner
- Tough, yet lightweight

Model	Description
EGC-2	16" x 16" x 35"
EGC-3	9-1/2" x 9-1/2" x 40"

All bags on this page are imported

Light weight soft padded bag with protection rigid liner



Pull handle and side strap.



Wheels have protective outer enclosures.



EGC-2



EGC-3

Podium Cases

- Hard plastic designed for Pop-Ups
- Add a graphic wrap to deliver your message
- Doubles as a Podium
- Simulated wood top insert

Model	Podium Case (O.D.)	Weight
OPC1	24"w x 15-1/2"d x 38"h	40lbs.



OPC1



OPC1 & GFW1

Model	Description	Size
GFW1	Graphic for OPC1	70-1/2"w (includes 2" overlap) x 31"h
GFW1-PC	Pillowcase Graphic for OPC1. Template available online	

Cashier Shields

Retail Displays



Cashier Shields - Flexile System

- Use one or multiple sections, to your desired width
- 36" High Aluminum uprights with steel bases
- Non-marring base options or permanently affix to counter
- Enhance customer and employee safety
- Use any clear acrylic - 0.060" to 3/16" thick
- Full height or partial barrier (12" H stop for pass through standard)
- Clear panels can be positioned with space at the bottom or run continuous from top to bottom



No drilling of Acrylic required. Panels are held in place with set screws. Use any clear Acrylic -0.060" to 3/16" thick

Color

-S Satin Silver

Create Single or multiple sections

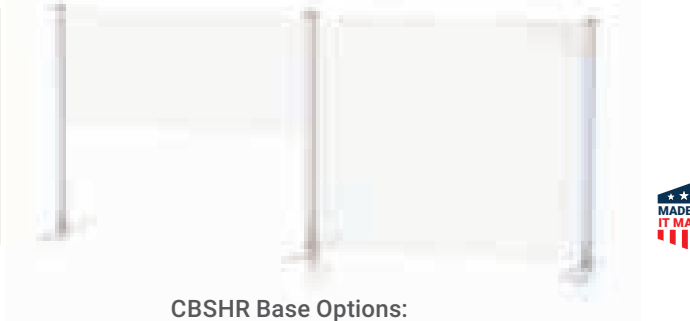

CBSHR Base Options:



Racetrack Base, with non-skid -RT



Round Base with VHB tape -RD



Square Drill Down Base -DD

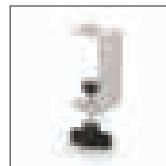

"C" Clamp-On Base -CL

End Uprights sold in pairs. For wider spans, add Center uprights, **CBSHR-SS** Series include 2 side uprights with headless set screws and laser cut steel bases. Note: Does **NOT** include the Acrylic shield.

Standard and custom models available

End Uprights w/Bases sold as a pair	Description	Center Upright w/Base sold individually
CBSHR-SS-RT	36" h Uprights w/Racetrack Oval Bases	CBSHR-DS-RT
CBSHR-SS-RD	36" h Uprights w/Round Bases	CBSHR-DS-RD
CBSHR-SS-DD	36" h Uprights w/Square Drill Down Bases	CBSHR-DS-DD
CBSHR-SS-CL	36" h Uprights w/Clamp on Bases	CBSHR-DS-CL

Clear Room Partitions™

Retail Displays

Clear Room Partitions™

- Offered in 2 style bases - Heavy Steel bases & Wheeled bases
- Fire retardant clear plastic lens (NFPA701)
- Portable, strong & lightweight
- Quick and easy setup
- Knocked down for shipping savings
- Offered in 2 sizes, custom sizes available



The Clear Room Safety Partition is ideal for the office, restaurant, salon, hotel lobby and any other environments that require social gathering. The movable safety partition allows you to setup spaces on demand.



Model	Size	Description
CLRPART-3672	36" w x 72" h	Floor Partition Stand with clear vinyl
CLRPART-7272	72" w x 72" h	Floor Partition Stand with clear Vinyl
CLRPART-3672-WHL	36" w x 72" h	Floor Partition Stand with wheel base and clear vinyl
CLRPART-7272-WHL	72" w x 72" h	Floor Partition Stand with wheel base and clear vinyl

Sign and Catalog Stands

Retail Displays

U Channel Stands

- Quick graphic change-outs
- 0.240" I.D. "U" Channel 8" long
- Choice of shovel or 12" square base
- 2 set screws firmly hold rigid graphic
- Telescopic pole 26" - 50"
- Beautiful black matte finish

IMPRINTABLE



↓
For Media
up to 1/4" or 6 mm
↑

Model	Base	Upright
PLTCH	Shovel base	Telescopic, 1" diameter
PXCH	12" square base	Telescopic, 1" diameter



Incline Slide-In Stands

- Acrylic or Steel Holders
- Telescopic poles 26"-50"
- 8.5" x 11" vertical backs
- Weighted steel bases

Specify: Model – Color* *Doesn't affect price

Model	Features
S4SQ	Acrylic holder, square base
S4RD	Acrylic holder, round base
S8SQ	Steel holder, square base
S8RD	Steel holder, round base

-S Satin Silver or -B Matte Black

Catalog Stands

- Great for retail showrooms & lobbies
- Angled 3-ring binder with pencil edge
- All metal construction
- PCS1 ~54" height base to top
- PCS2 ~50" height base to top
- 11-1/2" high by 20" wide tray



Specify: Model – Color

Model	Base	Upright
PCS1	13" Round base	1" diameter, straight
PCS2	Oval base	1" diameter, curved

-S Satin Silver or -B Matte Black

Bag Racks & SignHolders™

Retail Displays

Bag Racks

- Telescopic models available
- 40" high, 24" long arms, finial top.
- 3 base styles and 2 finishes available
- Provide attractive advertising
- Weight: 6 lbs.



Specify: Model

Model	Color	Description
SBR1	Silver	12" Square base
SBR2	Silver	Travel base*
SBR3	Silver	11" Round base
SBR7	Black	12" Square base
SBR8	Black	Travel base*
SBR9	Black	11" Round base
SWBWL	-B or -S	Wire signholder accessory
EBGX	*Bag available for travel models	

Telescopic uprights add a -TP example: **SBR1-TP**
SWBWL Specify: -B Matte Black -S Satin Silver



Simple Clamp Stands™

- Single sided
- Telescopic pole
- Several base choices

Specify: Pole – Base – Clamp* – Color*

Pole			Clamps*	
C2	2 section	38" - 72"	-1	Black plastic, opens 1-1/4"
C3	3 section	36" - 96"	-2	Plated steel opens 2"
Weighted steel bases			Color*	
-SQ	12" square (1/8")	- 5 lbs.	-S	Satin Silver
-SQ2	16" square (1/8")	- 9 lbs.	-B	Matte Black
-RD	11" round (3/16")	- 5 lbs.	*Doesn't affect price	
-RD2	13" round (3/16")	- 8 lbs.		

PLT-PX1 Pallet SignHolder

- 8-1/2" x 11" aluminum frame
- Pole telescopes 26" to 50" high
- 3/16" x 4" x 14" shovel base
- Satin silver finish



Stellar Pallet Stands™

Retail Displays



Square telescopic lock.
For infinite adjustment.

Pallet Stand

- All metal – built to last
- Matte black powder coated
- Telescopic to 78" high
- Reinforced steel base

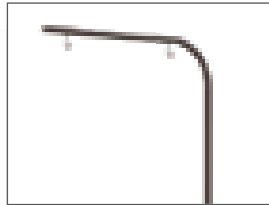

SINGLE 18" arm with
8" on center J hooks.

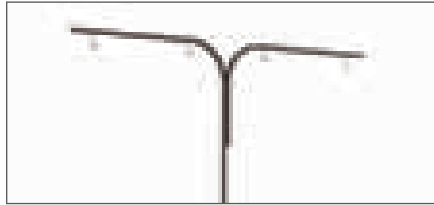

DOUBLE 18" arms with
8" on center J hooks.

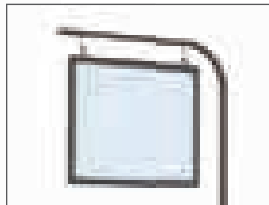

Optional Framettes™ 14" w x 11" h



Square Base

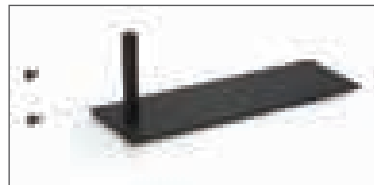

Shovel Base



PLTV-1



PLTQ1F
with PBH

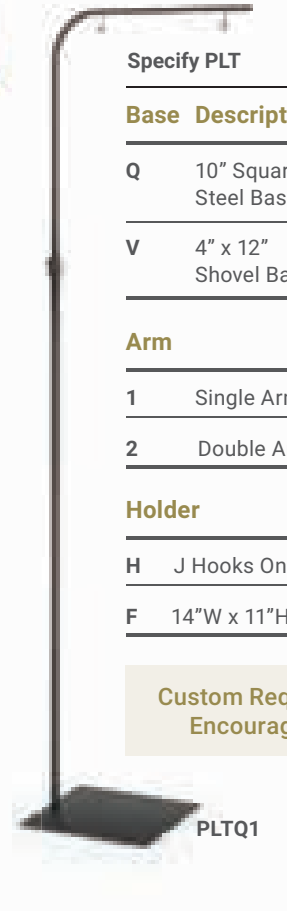

PLTQ1

Specify PLT

Base Description

Q	10" Square Steel Base 3/16"
V	4" x 12" Shovel Base 3/16"

Arm

1	Single Arm
2	Double Arm

Holder

H	J Hooks Only
F	14"W x 11"H Framette

Custom Requests
Encouraged

PBH Bag holder accessory.
Adjustable up and down

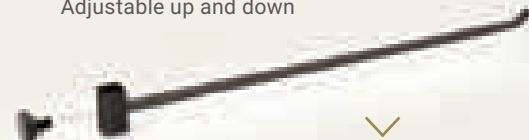

✓
Economical
and Built to last



Stellar Pallet Stands™ Retail Displays

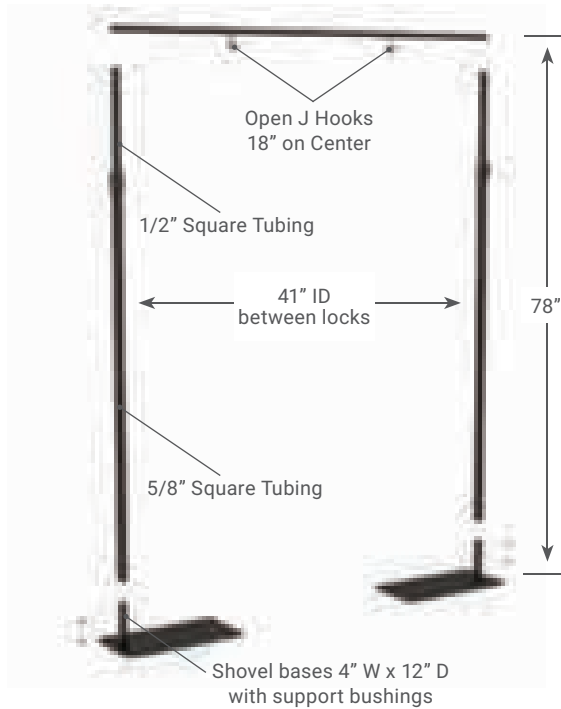

Two Sided Pallet Stand- Model PLT2U1

- Square steel, telescopic 78" high
- Innovative locking mechanism
- Two open J hooks on 18" centers
- Inside dimension 41" wide
- Heavy 4" W x 12" D shovel bases
- Internal base support bushings



Offers:

Terrific for Big Box Stores
Designed for High Traffic Areas



Full Logistic and Rollout Support Services

Customize to your opportunity

Many different variations are possible.
For example see below:

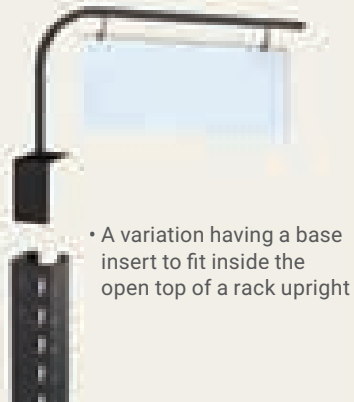
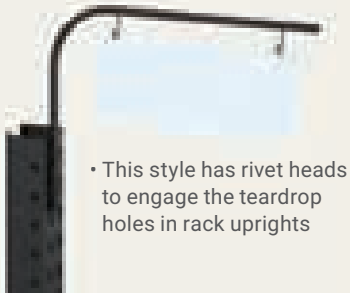

Literature Holders

Retail Displays

Collateral SignHolders

- Terrific quality, all metal **LF3** 22" x 28" SignHolder
- Crystal clear plastic compartments



HD1 Accessory
Clip Set (3) holds
headers to 1/8" thick.

↓
For Media
up to 1/4"
↑

Units are 63" high

One sided units are 13 lbs.
Two sided units are 15 lbs.

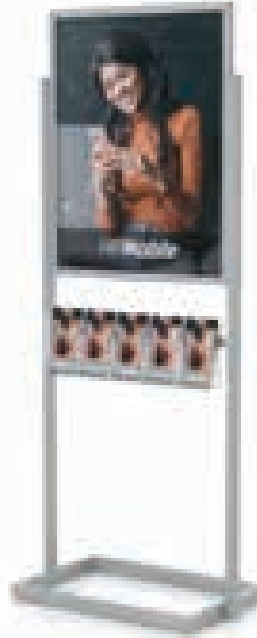

LF3LT1-S

Specify: Model – Color

Model	Specifications
LF3LT1	5 Pamphlet Holders on 1 side.
LF3LT2	10 Pamphlet Holders, 5 each side.
LF3LT3	2 Catalog Holders on 1 side.
LF3LT4	4 Catalog Holders, 2 each side.

-S Satin Silver or -B Matte Black

LF3LT3-B with **HD1** Clip Set (3)
grips up to 1/8". Header not included.

Info Centers

- Great quality, economical price point
- Aluminum construction
- Electrically welded bases
- Back to back displays

Specify: Model – Color

Model	Specifications
LFPB140	Room for 40 Pamphlets
LFPB216	Room for 16 catalogs

-S Satin Silver or -B Matte Black



LFPB216-B

- Pamphlet Holders are 4" wide x 1-1/2" deep.
- Catalog Holders are 9" wide x 1-1/2" deep.



LFPB140-S

Evo Literature Stands™ Retail Displays

Custom Examples of Literature Holders

- Add print collateral to many of our existing products
- Fully customizable options in quantity



Wheeled, Free-Standing
or Wall Mounted Options



Evo Literature Holders

- Fast setup, Lightweight
- Aluminum construction
- Floor Stand and Wall Mounted versions
- Display 2 letter size catalogs or brochure's (side by side)
- Holder Dimensions: 19" w x 11-3/8" h, 2" d
- Evo Floor Stand Dimensions: 23" w x 70" h
- Evo Wall Mount Dimensions: 23" w x 48" h



ELH-WM-S



Perfect for:
Retail
Banks
Tradeshows

Specify: Model	-S Satin Silver
Model	Specifications
ELH-FL-1-S	Floor Stand, 1 Sided
ELH-WM-S	Wall Mount



Ships unassembled
for low cost shipping



ELH-FL-1-S

Literature Holders

Retail Displays



Banner Stand with custom Aluminum Holder

Snap-On Literature Brochure Holders (to round uprights)

- Acrylic
- Wire
- Aluminum

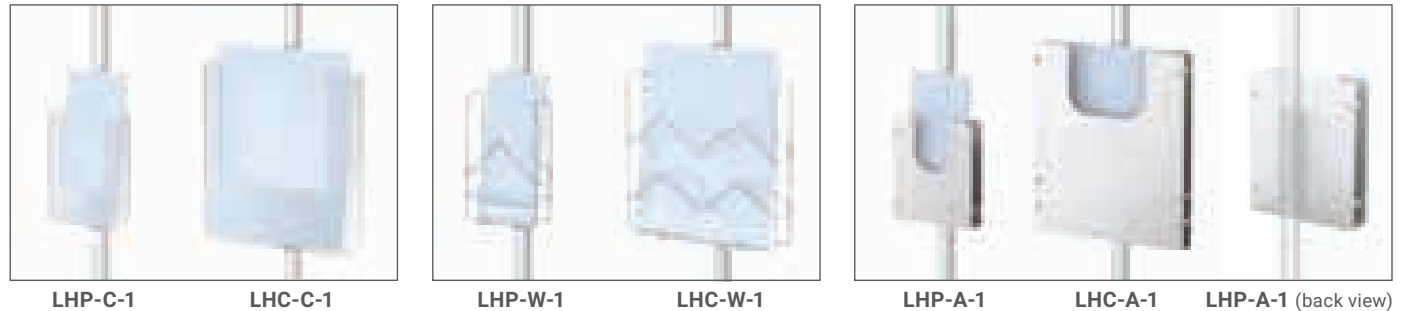

Specify: Size - Material - Mounting

Note: Acrylic and Wire Holders Imported. Aluminum - Made in USA

Size	Material	Mounting
LHP - Pamphlet	- C Clear Plastic	- 3/4 3/4" Diameter tube clip
LHC - Catalog	- W Wire	- 7/8 7/8" Diameter tube clip
	- A Aluminum	- 1 1" Diameter tube clip

LHP - Pamphlet: 4" w x 1-1/2" **LHC** - Catalog: 9" w x 1-1/2" D. Designed for 11"H literature.

Beautiful Brushed Satin Anodized Aluminum Literature Holders - Countertop and Wall Mount

- All metal
- Riveted construction
- Brushed satin anodized finish
- Custom requests encouraged

CounterTop with Flat Bases -TT

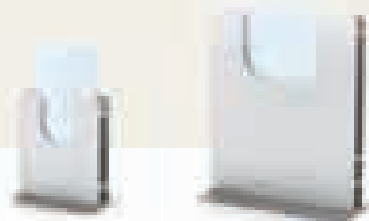

LHP-A-TT

LHC-A-TT

Wall Mount with Velcro Brand Hook/Loop® -WM

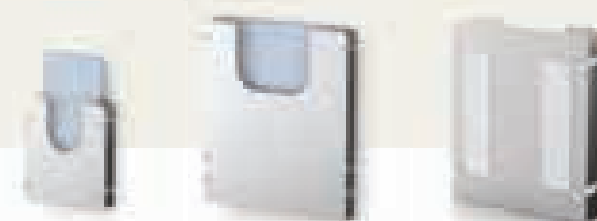

LHP-A-WM

LHC-A-WM

LHC-A-WM (back view)



SignPost Literature Stands™

Retail Displays

SignPost Literature Holder Stands

• Units can be positioned anywhere along upright



YLS8-C-S
Double Facing
Catalog Stand (8)



YLS4-C-S
Single Sided
Catalog Stand (4)



YLS6-PH-S
Double Facing
Pamphlet Stand (6)

Specify: Model – Pamphlet or Catalog – Color

Model	Height	Lit. Holders	Pamphlet or catalog
YLS3	72"	3 Holders (Single Sided)	-PH Pamphlet
YLS4	72"	4 Holders (Single Sided)	-C Catalog
YLS6	72"	6 Holders (Double Sided)	
YLS8	72"	8 Holders (Double Sided)	

Color: **-S** Satin Silver or **-B** Matte Black

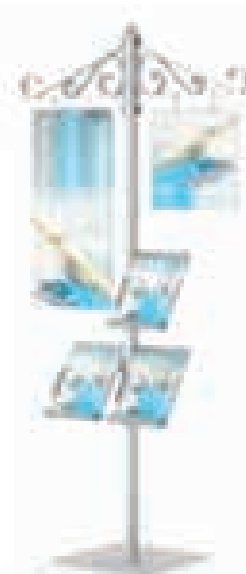

Lit. Holders &
Scroll Brackets



YB1618-S
with (3) CRLSLM-S



With Banner Stand



CRLS-S
Literature Holders

Fully Customizable



With Aluminum
Drop-In Frame

Y1PD90F-S
with (3) CRLSLM



Pro iPad Stands™ Retail Displays



Pro iPad Stand™ Common Features

- Rotates from portrait to landscape
- Anti-theft hardware
- Metal back, uprights & bases
- Satin silver or matte black finish
- High impact acrylic cover
- Included USB cable runs from the top, through the upright, down to the base



Tamper proof screws ensure secured enclosure.

Integral USB cable set. ➤ Indicate model.



360° Swivel
Rotates from
portrait to
landscape.

IPDS-SQ-B

IPDS-RD-S

Classic Pro iPad Stand™

- Oval 37" high aluminum upright
- 13" round or 14" square steel base
- Weight: 11 lbs.

Specify: Model – Color*

Model	Description
IPDS-SQ	Floor Stand, 14" Square Base
IPDS-RD	Floor Stand, 13" Round Base

-S Satin Silver or -B Matte Black

*Doesn't affect price.

Indicate tablet model - see website for tablet models accommodated.

IPDSHC - Complete Kit

Stand with Hard Case & custom designed polyethylene inserts for portability & storage.

Specify: **IPDSHC** - Base* - Color*



Classic Countertop / Wall iPad Stands™

• 8" long post, 11" round or double flange base. Indicate tablet model – see website.

CounterTop



IPDTR-S

Double Flange Base



IPDTF-S

Wall Mount



IPDTW-S

Specify: Model – Color* *Doesn't affect price.

Model	Description
IPDTR	Counter Top, 11" Round Base
IPDTF	Double Flange Base
IPDTW	Wall Mount

-S Satin Silver or -B Matte Black

Hybrid Pro iPad Stands™ Retail Displays



Drop-In Perfex Frames



SnapFrames

Front load, includes matte lens & styrene back.



Laser Cut Bases

10" x 14" oval. 7 lbs. Double bolt rock solid connections.

IPF2-E07-S



IPF2-PX9-S



IPHC2-S



IPHB2-S

The iPad Stand with iPad in vertical position is approx. 44.5" h

Hybrid Pro iPad/SignFrame Stands

IPF Aluminum Frames are movable along the 72" high upright. Choose either top load drop in frames or easy open front load SnapFrames.

Specify: Model – Frame Style

Model	Drop-In Frame	SnapFrame
IPF1 1 Frame	PX5 22" x 28"	E07 22" x 28"
IPF2 2 Frames	PX6 24" x 36"	E09 24" x 36"
	PX9 22" x 56"	E012 22" x 56"

Note: See website for tablet models accommodated. Stands this page Beautiful Satin Silver Finish.

Hybrid Pro iPad/Clamp Stands

Movable aluminum clamps along 72" high aluminum pole. Holds rigid & semi-rigid graphics up to 1/2" thick. Weight: 15 lbs.

IPHC1 Single sided (2 clamps).

IPHC2 Double sided (4 clamps)

Hybrid Pro iPad/Banner Stands

IPHB2 Holds 24" wide hemmed banner/s. Use 1 or 2 sided. Telescopic pole accommodates banners up to 96" high. Weight: 14 lbs.

Custom models available in quantity.



Convention & Hotel Easels

Retail Displays

Steel Easels

- Superior strength **Steel** construction
- Beautiful finishes
- Height: 6' • Weight: 8 lbs.
- Folds for storage 1" x 4" x 72"
- Fully-riveted, no parts to lose
- Rubber tips prevent slipping



925

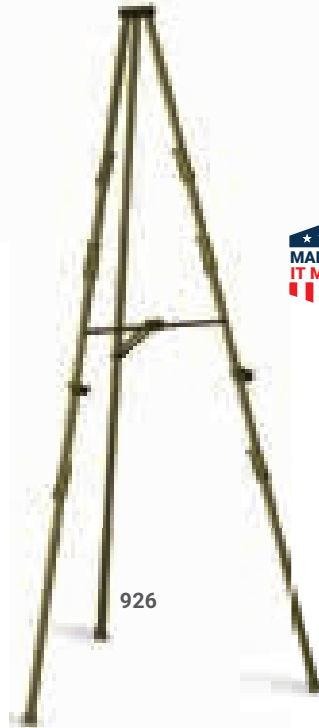

926

Space-saving design—store many easels in a small area.



Model	Description
925	Black texture
926	Brass-plated
927	Bright plated steel



Aluminum Easels - 900 Series

- Lightweight alloy construction
- Available in 5' or 6' models
- Aluminum, gold or black finishes
- Sign and chart holders fold flat
- Fully riveted, no parts to lose
- Outstanding choice for institutional use. Holds 50 lbs!



900/5A



900/5G



900/6B

5' model has 3 sets of chart holders, 6' model has 4

Model	Description	Weight
900/5A	5' aluminum finish	4.5 lbs.
900/5G	5' gold anodized	4.5 lbs.
900/5B	5' black anodized	4.5 lbs.
900/6A	6' aluminum finish	5 lbs.
900/6G	6' gold anodized	5 lbs.
900/6B	6' black anodized	5 lbs.

Elegant Easels

Retail Displays

Baroque Easels

- Attractively plated finial ends
- Hold graphics to 2-1/2" thick & 30 lbs.
- Beautifully finished 1" diameter steel legs,
- Easy assembly – durable
- Board holders 25-1/2" off floor
- Height: 5' • Weight: 7 lbs.



Perfect for:
Hotel Lobby
Theatre
High End Displays



650B



650

Model	Description
650B	Black
650	Brass-plated (Classic)



415

Lobby Easels

- Clean modern design
- Sliding adjustable signholders
- 1" diameter steel legs
- Beautiful finishes
- Built strong for rigorous use
- Height: 55" • Weight: 8 lbs.

Model	Description
415	Black textured

Flip Chart & Display Easels

Retail Displays



350, 350TZ & 555

EBG-X Easel bag for any easel on this page.



The Most Popular Display Easel Series in America

- Hold signs, posters, boards or flipcharts (with bar)
- Metal heads, support locking braces
- 2-way adjustable board holders
- Lightweight aluminum alloy construction
- Trouble-free telescoping legs
- Reliable aluminum clutch locks
- Non-mar, non-skid rubber leg tips
- Strong riveted construction • Height fully adjustable

350 Series Industry standard, utilitarian chart or display easel. Holds 30 lbs.

555 Series Jumbo version of the 350 Series. Heavy duty, large diameter legs. Holds 50 lbs.

Economy Display Easels

- Aluminum alloy construction
- Strong, lightweight & portable
- Center support, 24" shelf
- Shipped in a poly bag
- Height: 5' • Wt: 2 lbs.

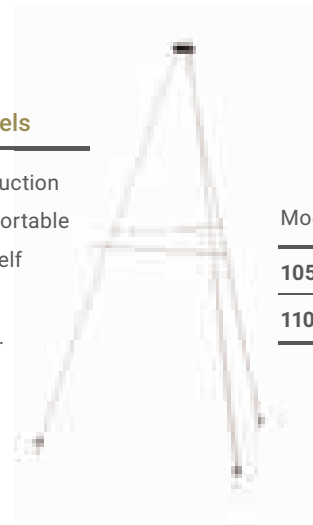

Model	Description
105	Aluminum
110	Black

Our Quality Makes the Difference!



Trouble-free clutch lock mechanism.

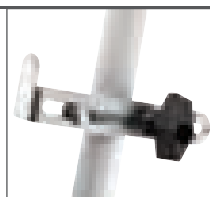

Patented metal chart holders.



Legs telescope, and easel folds together.

...A great alternative to more costly aids and techniques.

Model	Description	Color	Weight
350	Display easel	Aluminum	2.3 lbs.
350TZ	Flipchart easel	Aluminum	2.8 lbs.
555	Jumbo easel	Aluminum	3.0 lbs.
555TZ	Flipchart easel	Aluminum	3.5 lbs.



350TZ (Pad not included)

Presentation Easels

Retail Displays



425 & 425MG
Intermediate position

425 and 425MG Easels

- Unique, 4-leg design
- Three height positions
- Full length marker/chalk tray
- Spring-loaded flipchart bar for pad
- Aluminum frame.



Perfect for:
Presentations
Meetings
Classrooms



Trouble-free clutch mechanism for secure locking.



425 & 425MG
(Pad not included)

Model	Description	Weight
425	White Markerboard	11 lbs.
425MG	White Markerboard, magnetic version	17 lbs.

Classic A-Frame Easels™

Retail Displays

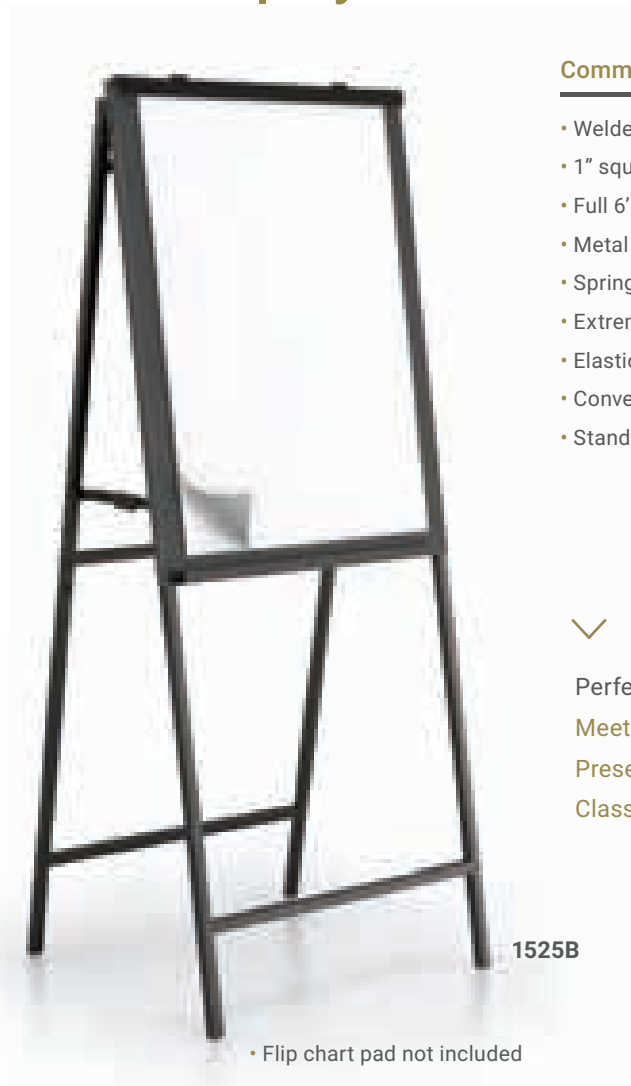

1525B

• Flip chart pad not included

Common Features- The Best Made Easel Series in the World!

- Welded aluminum construction
- 1" square heavy duty legs
- Full 6' height
- Metal panels
- Spring-loaded pad holder
- Extremely sturdy and rigid
- Elastic strap
- Convenient tray
- Stand 72"h x 28"w

Front Panel Choices:

- Steel:** strong, magnetic.
- Aluminum:** strong, lightweight.



Perfect for:
Meetings
Presentations
Classrooms

Unit breaks down for
cost efficient shipping



1520B



Optional **EBG-2** Bag for folding models only.

Model	Legs	Aluminum Surface	Weight
1525B	Black	Black aluminum	27 lbs.

Model	Legs	Steel Surface	Weight
1520B	Black	Black steel magnetic	34 lbs.

Studio Artist Easels

Retail Displays

700 Professional Studio Artist Easel

- Extra sturdy and rigid
- Folds flat for space-saving storage

Model	Description
700	Professional Studio Easel



500



600

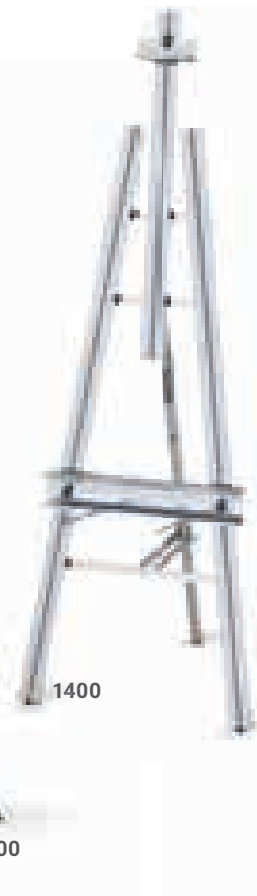

1400

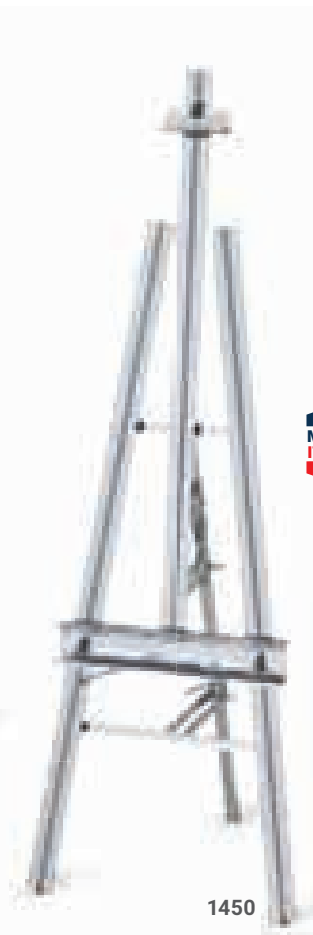

1450



700

Studio Artist Easels

- Superior strength and rigidity
- Sets up in minutes without tools
- Folds flat for transport and storage

Model	Description
500	Classic Studio Easel
600	The Studio Easel
1400	Traditional Studio Easel
1450	Superior Studio Easel

Aluminum – Lightweight yet Sturdy!

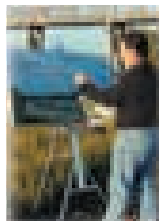

Easel Extensions

- To accommodate larger canvases

Model	Description
ST12	12" extension to center upright
ST26	26" extension to center upright



Aluminum Slatwall Displays

Merchandising Displays

Revolver Slatwall Stands™

- 1" on center slatwall
- Satin anodized finish
- Lazy susan Swivel Base
- Saves on Floor space
- Double Sided



Model	Dimensions
LUR54-S	16" Diameter Base x 54" high
LUR72-S	16" Diameter Base x 72" high



Ideal for:

- Big Box Stores
- Retail Environments

Custom Stands and Panels

Our inside sales staff is ready to assist you in designing and pricing custom stands and panels



Bulk Slatwall – 1" on Center, Satin Anodized

Aluminum etched and satin anodized complements all environments.

- 1" on center aluminum alloy
- Etched & clear satin anodized
- Lightweight & strong
- Beautiful, modern design



6" high profiles nest together.
Height is a multiple of 6" plus 1/4".

Single Sided	Double Sided	Dimensions
LUMA48	LUMD48	6" high x 48" long
LUMA72	LUMD72	6" high x 72" long
LUMA96	LUMD96	6" high x 96" long
LUMA144	LUMD144	6" high x 144" long

Other lengths available.

Tons of standard accessories fit our slatwall:

- Lit. Holders
- Jewelry Displays
- Shelf Brackets
- Face Outs
- Baskets
- Signage
- Shelves
- Hangers
- Hooks
- Hat Racks
- Cap Displays
- Waterfalls



Portable Slatwall Stands

Merchandising Displays



Contemporary Modern Look,
Beautiful Satin Finish

Portable Slatwall Stands

- Lightweight & strong
- Etched & clear satin anodized
- Welded steel bases
- Racetrack oval upright
- Ultra easy assembly
- Headers accept 22" w x 8" h graphics

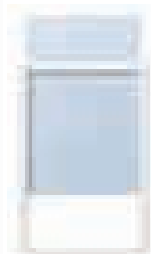

Units top load



LUP11



LUP22



LUP22H

Custom Requests Welcomed

Model	Description	Height
LUP11	One-sided Slatwall	70"
LUP11H	One-sided with header	79"
LUP12	Two-sided Slatwall	70"
LUP12H	Two-sided with header	79"
LUP22	Two-sided, 22"x 28" frame	70"
LUP22H	Same with header	79"

Lockable
casters are included.



Slatwall starts about 16" up from the floor. Rolling Base Assemblies are: 25" w x 18" d x 4" h

Merchandising Displays

Customize to your Specifications

With three simple connectors and in stock 1" square aluminum tubing, build stands to your custom specifications.

- Available in Satin Silver or Matte Black

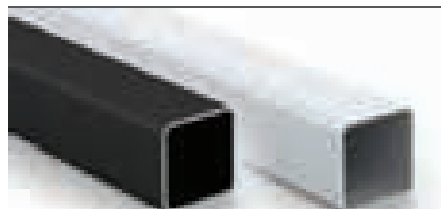

1" Square Aluminum and Steel Tubing



2-Way Right Angle



3-Way Tee



3-Way Corner

System is designed to allow DIY low quantity projects.

Complete kits are available, but only in quantity, typically 25+ depending on project.



Meal Pick Up Displays

Custom Design Examples:



POP/Literature Display



Display Cases



Carts & Counters



Shelf Units



Merchandising Displays

Make your Visual Merchandising/Communication opportunity a reality.

Design, engineering, fabrication and finishing services available, for larger projects.
Aluminum structures are strong, lightweight, portable and modular

Use to construct visual merchandising and communications stands

Integrate graphics, signing, and other collateral features



Tire Displays



The Best Aluminum Slatwall in the Business



Portable Privacy Booths

Brackets

- S Satin Silver
- B Matte Black



2 - Way Inline
1INSQ-ST-STRT



2- Way Brackets
1INSQ-ST-L

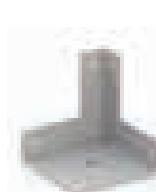

Corner
1INSQ-ST-CRNR



Corner Caster
1INSQ-ST-CRCS

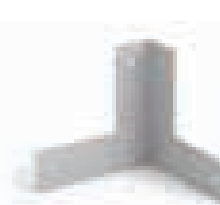

2 - Way Corner
1INSQ-ST-DBLL



2- Way Support
1INSQ-ST-BNTL



3-Way Brackets
1INSQ-ST-T



4-Way Brackets
1INSQ-ST-4WAY

SignPost Double Upright Stands™

Merchandising Displays

Available as complete displays as shown, or create your own custom SignPost™



YDU636-V-S Double Upright Video Stand with (3) **YST36** Shelves.

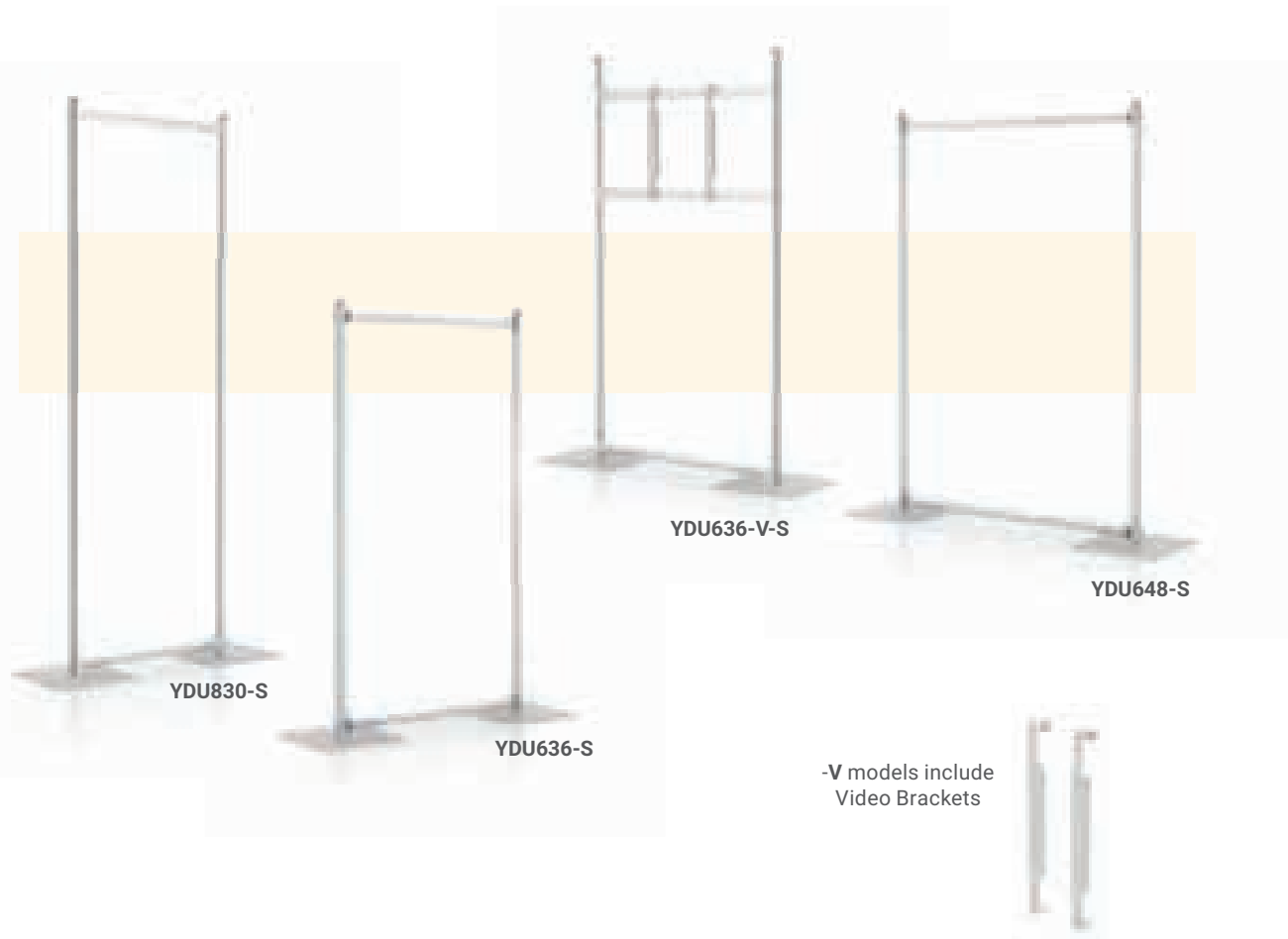

YDU830-S

YDU636-S

YDU636-V-S

YDU648-S

-V models include Video Brackets

* Specify: Model (Note: 96" Uprights are in 2 sections) – Color*

Model	Height	Width	Model	Height	Width	Model	Height	Width	Color*
YDU630	72"	30"	YDU830	96"	30"	YDU630-V	72"	30"	-S Satin Silver
YDU636	72"	36"	YDU836	96"	36"	YDU636-V	72"	36"	-B Matte Black
YDU648	72"	48"	YDU848	96"	48"	YDU648-V	72"	48"	

*Does not affect price

SignPost Double Upright Stands™

Merchandising Displays

Perfect for Point-of-Sale Roll-Outs



YDU636-S Double Upright Stand with
(3) **CRLSRM-S** Literature Holders.



YDU636-S Double Upright Stand with
CRPA25 Pocket Arms and (1) **YST-36-S** Shelf.



Anodized Pucks

Beautiful, Aluminum Alloy Uprights

Pole Pocket Graphics

SignPost™ Double Upright Stands (Note: 96" Uprights are in 2 sections)

- Two aluminum alloy uprights
- Two 16" square bases
- Two set height crossbars
- Four aluminum pucks
- Satin silver or matte black finish
- All metal, super sturdy

SignPost Walls Available
Call Our Friendly Sales Staff.



Mightee Mounts™

Rigid Graphic Stands



IMPRINTABLE

Modern Frameless Design - Adjustable Depth

- Attract buyers with single or double sided graphics
- Our unique M shaped Steel Base assemblies accommodate up to 1" thick substrates
- Extremely cost effective; graphics are displayed in a modern frameless fashion. Extremely sturdy as all the weight is centered on the floor
- 3-1/2" Height off floor, 9" front to back
- Interior holes with carriage bolts and wing nuts support any rigid graphics. Make matching holes in graphics or use without holes by sandwiching graphic above the carriage bolts

Specify: Model – Color

Model	Width	Weight
MM14	14"	6 lbs.
MM24	24"	10.5 lbs.
MM36	36"	15.75 lbs.
MM48	48"	21 lbs.
MM60	60"	26 lbs.

-S Satin Silver or -B Matte Black

Holds any Rigid Substrate up to 1" thick
(as long as it holds its own weight)

HT5 Rigid Graphic Clip hold graphics together up to 1/2" total thickness (sold 2 per)



Perfect for:
Malls
Tradeshows
Exhibits
Retail Environments



For Rigid Media
up to 1" thick



CounterTop Models

- Mini Mightee Mounts see page 73

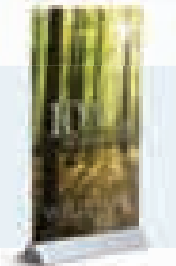

Sign Board (any, as long as it supports its own weight)

Bolt/wing nut

Sleek steel stampings

Curvette Mounts™ Rigid Graphic Stands



Perfect for:

Tradeshows

Malls

Showrooms

Retail Environments



Curvette Mounts™ - Stylish Board Supports

- Sleek design supports rigid graphic up to 1-1/4" thick
- Lightweight aluminum base, quick graphic changes
- Ergonomic bottom knob tightens rubber lined halves together firmly
- 14-1/2" front to back, 5-1/2" high

Specify: Model – Color

Model	Width	Weight
CM7	7"	3.5 lbs.
CM14	14"	6 lbs.
CM24	24"	10 lbs.
CM36	36"	15 lbs.
CM48	48"	20 lbs.

-S Satin Silver or -B Matte Black

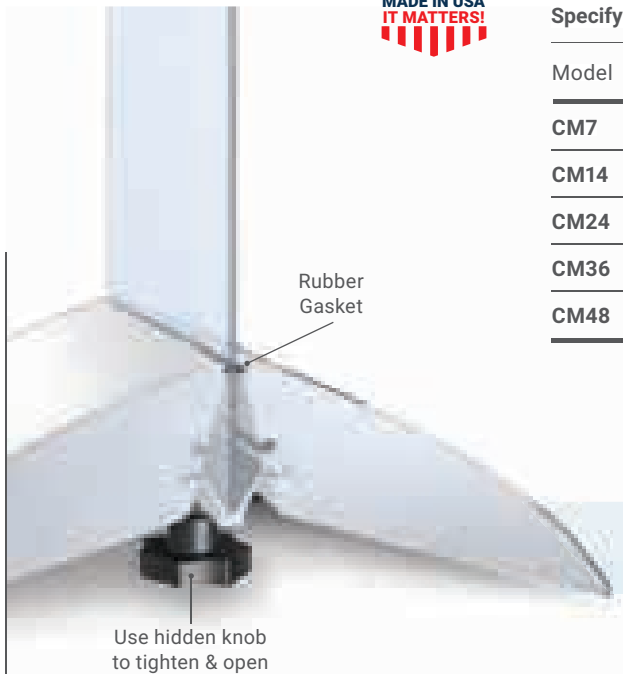

Grips rigid substrates from 3/8" to 1-1/4" thick.

HT5 Rigid Graphic Clip hold graphics together up to 1/2" total thickness (sold 2 per)

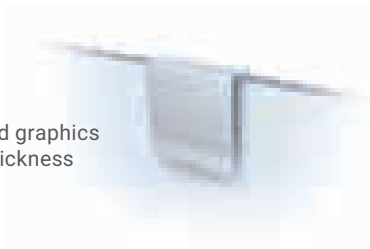

Use 2 units in series for larger graphics

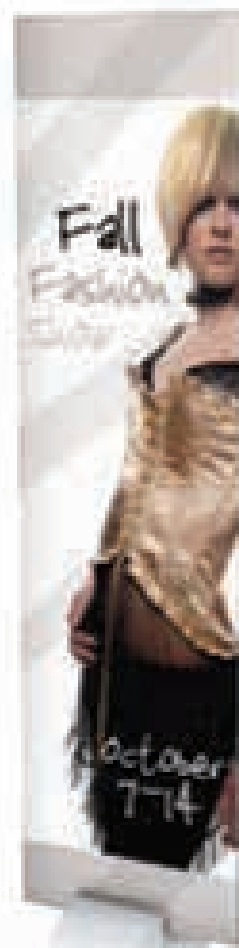

CM7-S

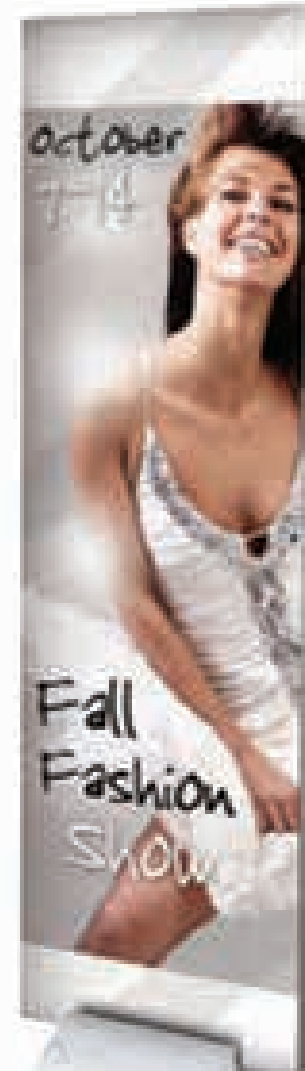

CM14-S

Double L Mounts™

Rigid Graphic Stands



Double L Mounts™ - Ships fully assembled

- 4" High, 7-3/4" front to back
- Sits flat on any surface
- Features welded construction
- All metal, extremely solid
- Great for lobbies, malls, etc.

↓
For Rigid Media
1/2" thick.
↑

Specify: Model – Color

Model	Width	Weight
LL14	14"	12.75 lbs.
LL24	24"	21.75 lbs.
LL36	36"	32.5 lbs.
LL48	48"	43.75 lbs.
LL60	60"	54 lbs.

-S Satin Silver or -B Matte Black 

Heavy and Stable Suitable for high traffic areas

CounterTop Models

- Double L Mounts see page 72

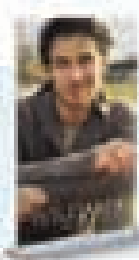

LLT385

Custom models available

- Colors
- Sizes
- Media Thickness
- Layering effects (multiple channels) two, even three tracks possible
- Mitered on one end to create corner effect. or partions



Powder coat finishes feature fine textures, designed for high traffic areas.

Adjustable Double L Mounts™ Rigid Graphic Stands



Grips 3/8" to 1" Graphics

- 4" High, 15" front to back
- Sits flat on any surface
- All metal, extremely solid construction
- 2 piece construction ships and stores efficiently

Great for:
 Lobbies
 Malls
 Showrooms
 Tradeshow Floors
 Retail Environments

For Rigid Media
 3/8" - 1" thick

Simple Two - Piece Construction

Specify: Model – Color

Model	Width	Weight
ALL14	14"	13 lbs.
ALL24	24"	21 lbs.
ALL36	36"	32 lbs.
ALL48	48"	41 lbs.
ALL60	60"	51 lbs.

-S Satin Silver or -B Matte Black



Both the satin silver and matte black powder coat finishes feature fine textures.



Rigid Graphic Stands

Sturdy Support for 1/2" Rigid Graphics

- Beautiful satin finishes
- Simple 5 minute assembly
- View graphics front & back
- 1" x 2" racetrack oval aluminum uprights
- Weighted steel bases: 3/16" x 8" x 17"
- Portable, strong, lightweight

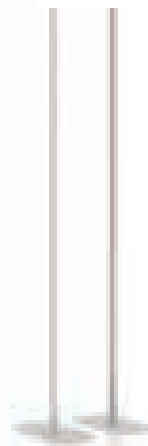

SKMM-S Skyscraper Mounts sold in pairs.

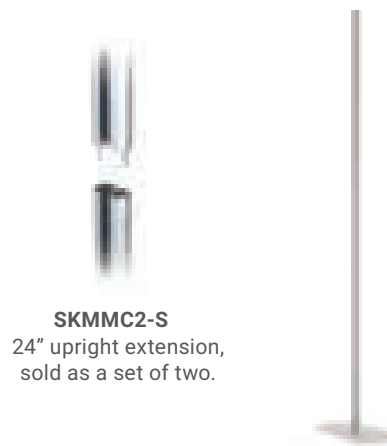

SKMMS-S 24" upright extension, sold as a set of two.



SKMM7-S Skyscraper Mount (side uprights) with a **SKCU7-S** center upright.

SKMM Sold in pairs at specific heights, they support widths up to 60" wide. For wider spans, add Center uprights, Right Angle, 60°, "T" and Quad Assemblies. **SKMM** Series include 2 side uprights with headless set screws and laser cut steel oval bases.

Specify: Model — Color*

-S Satin Silver or -B Matte Black



Skyscraper Mounts sold as a pair	Weight	Single Sided Upright w/Base sold individually	Weight	Height
SKMM6	20 lbs.	SKMS6	14 lbs.	72"
SKMM7	21 lbs.	SKMS7	15 lbs.	84"
SKMM8	22 lbs.	SKMS8	16 lbs.	96"

SKMM7 & SKMM8 uprights ship in 2 sections *Black units are more costly than the silver



Graphics can be set anywhere along or above upright.



7/8" margin each side. Headless set screws hold graphics.

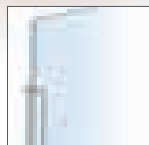

Skyscraper Mounts™

Rigid Graphic Stands

Center Upright

Two way upright with oval base.

90° & 60° Angle Assemblies

Two way upright with round base.

"T" Assembly

"T" upright with round base.

Quad Assembly

Four way upright with round base.



SKCU7-S Center Upright with oval base. Shown with **SKMM7-S** Skyscraper.

SKRA7-S Right Angle Assembly with round base. Shown with **SKMM7-S** Skyscraper.

SKTU7-S "T" Assembly with round base. Shown with **SKMM7-S** and **SKMS7-S**.

"Quad" Assembly with round base. Shown with (2) **SKMM7-S** Skyscrapers.

Center Upright sold individually	Weight	Height	Right Angle sold individually	Triangular 60°	Weight	Height	"T" Assembly sold individually	Weight	Height	"Quad" Assembly sold individually	Weight	Height
SKCU6	14 lbs.	72"	SKRA6	SKTR6	14 lbs.	72"	SKTU6	14 lbs.	72"	SKX6	22 lbs.	72"
SKCU7	15 lbs.	84"	SKRA7	SKTR7	15 lbs.	84"	SKTU7	15 lbs.	84"	SKX7	23 lbs.	84"
SKCU8	16 lbs.	96"	SKRA8	SKTR8	16 lbs.	96"	SKTU8	16 lbs.	96"	SKX8	24 lbs.	96"

SPECIFY: Model – Color* -S Satin Silver or -B Matte Black  *Black units are more costly than the silver

84" & 96" H uprights ship in 2 sections

Fixed Width Skyscraper Mounts™

Rigid Graphic Stands

Frameless - Minimalistic Design

- Attractive oval aluminum uprights
- Weighted, precision steel bases
- Portable, strong, lightweight
- Beautiful satin finishes
- Simple 5 minute assembly
- View graphics front & back

↓
For Rigid Graphics
1/2" thick
↑

Frameless Design

Place graphic any height
with set screws

Satin silver finish

1" w x 2" d
Racetrack Oval

Headless set screws
hold graphic in place

Heavy steel base

Ships KD for Fast Assembly

Graphics can be placed and set anywhere
along the uprights using headless set screws.



SKMM367-S

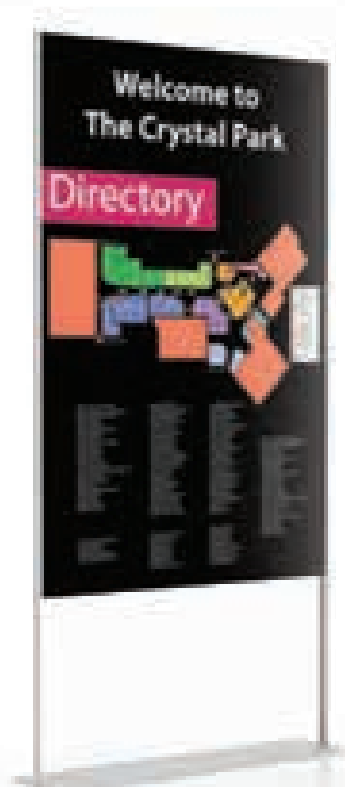

SKMM488-S

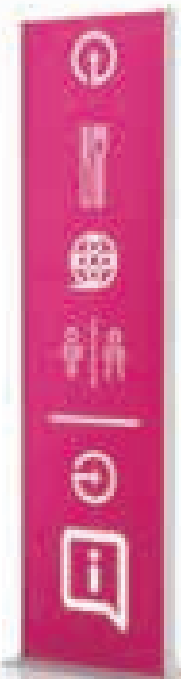

SKMM247-S

IMPRINTABLE

Fixed Width Skyscraper Mounts™

Rigid Graphic Stands

Simple - Attractive - Portable Frameless Display

- All metal, extremely solid
- Matte black or satin silver finishes
- Sits flat on any surface
- Ships KD for fast easy assembly



Specify: Model — Color* -S Satin Silver or -B Matte Black



Model	Graphic Width	Upright Height	Weight
SKMM146	14"	72"	16 lbs.
SKMM147	14"	84"	17 lbs.
SKMM148	14"	96"	18 lbs.
SKMM246	24"	72"	20 lbs.
SKMM247	24"	84"	21 lbs.
SKMM248	24"	96"	22 lbs.
SKMM366	36"	72"	25 lbs.
SKMM367	36"	84"	26 lbs.
SKMM368	36"	96"	27 lbs.
SKMM486	48"	72"	30 lbs.
SKMM487	48"	84"	31 lbs.
SKMM488	48"	96"	32 lbs.
SKMM606	60"	72"	35 lbs.
SKMM607	60"	84"	36 lbs.
SKMM608	60"	96"	37 lbs.

*Black units are more costly than the silver
84" & 96" H uprights ship in 2 sections



Place rigid 1/2" thick graphic any height with set screws



Great for:
Lobbies
Malls
Showrooms
Tradeshow Floors
Retail Environments



Graphics can be set to bottom.



set anywhere along uprights.



extend above upright sides.

Semi-Rigid Graphic Stands



All Metal, accepts Styrene Graphics with Hook/Loop

- Two heights: 72" and 84"
- Four widths: 18", 24", 30", 36"
- 2" Hook/Loop pcs. included
- 1" Square aluminum uprights
- Use single or double sided
- Fast 5 minute assembly



Specify: Model – Color*

Model	Width	Height	Weight
VEE618	18"	72"	12 lbs.
VEE624	24"	72"	15 lbs.
VEE630	30"	72"	17 lbs.
VEE636	36"	72"	24 lbs.
VEE718	18"	84"	13 lbs.
VEE724	24"	84"	16 lbs.
VEE730	30"	84"	18 lbs.
VEE736	36"	84"	25 lbs.

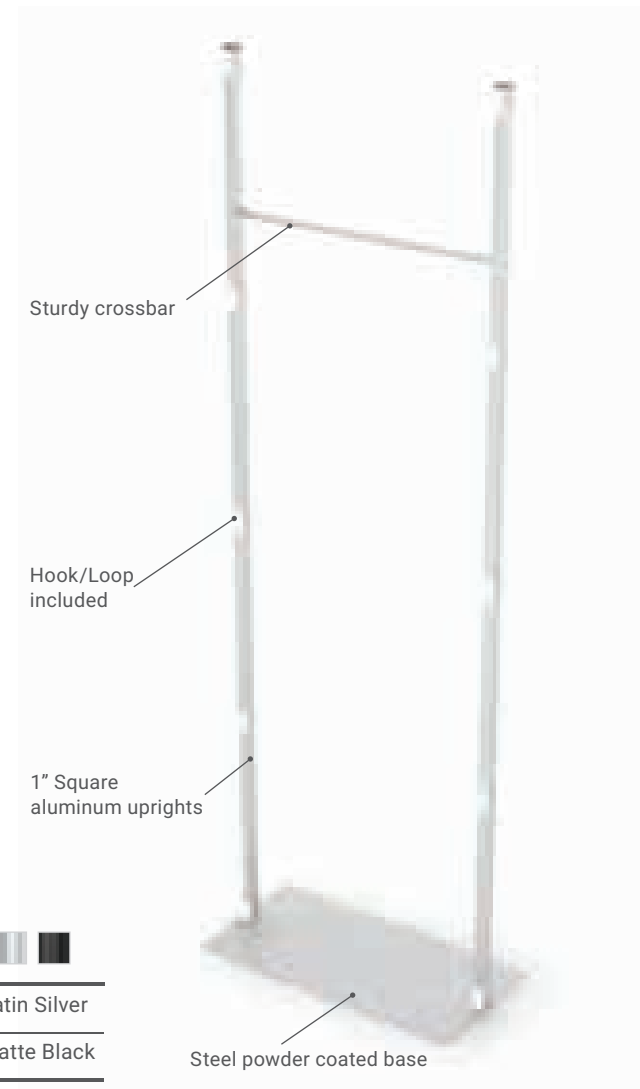

- Color*  
- S Satin Silver
 - B Matte Black

CounterTop Models

- CounterTop Standees see page 81.

VEEM1224-S

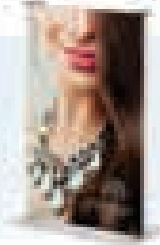

Simple SignHolders™ Rigid Graphic Stands



Simple SignHolders™

- Portable SignHolders
- 11" Diameter base with 1" upright
- Holds rigid substrates up to 1/4" thick
- Double sided - a lot of display
- Optional extra ES2 sign holder set for 2nd graphic set



Ideal for:
Art Shows
Presentations
Trade Shows

**3 Base Options:
Square, Round or Travel**

Specify: Model — Base — Color* *Doesn't affect price

Model	Height	Sections	Diameter	Base	Color*
SS2	72"	2	1"	-SQ 12" Square	-S Satin Silver
SS2	96"	3	1"	-RD 11" Round	-B Matte Black
ES2	Extra Holders for SS2, SS3			-TB Travel Base	

Adjustable top and bottom holders

Poles screw together for a seamless look

Aluminum alloy

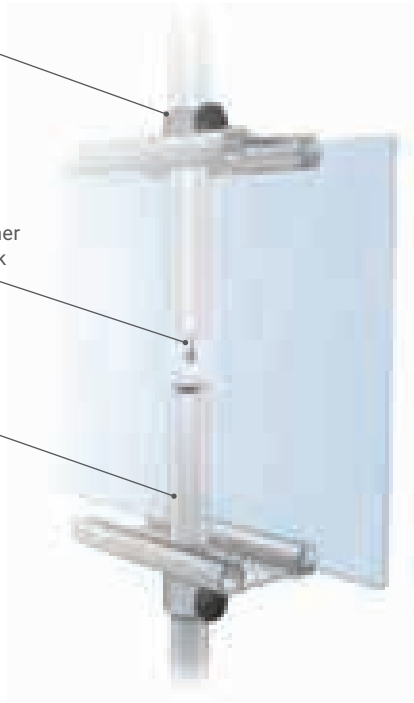

↓
For Rigid Substrates
up to 1/4"
↑

Extra Holder Sets

- Sold in sets of 2

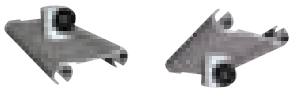

TB travel base

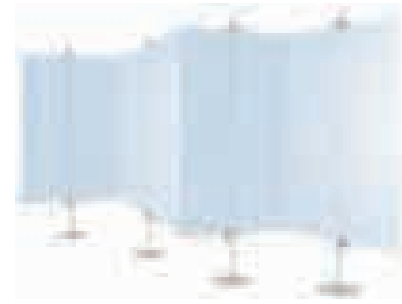

Great as Trade Show Corners.

Contemporary Clamp Stands™

Rigid Graphic Stands

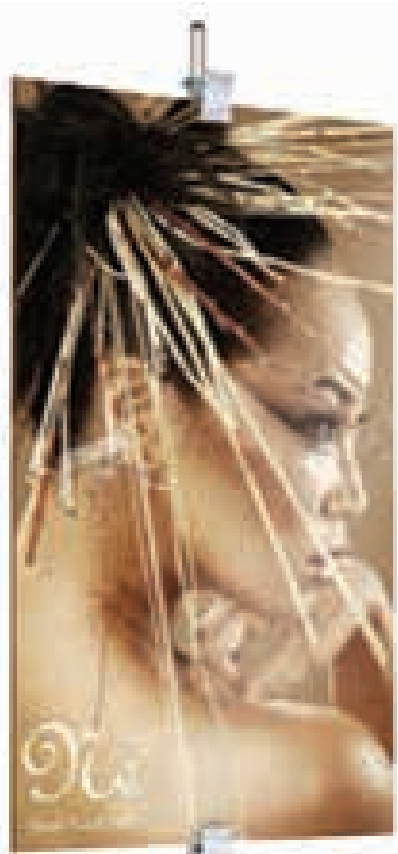

VCST1-S

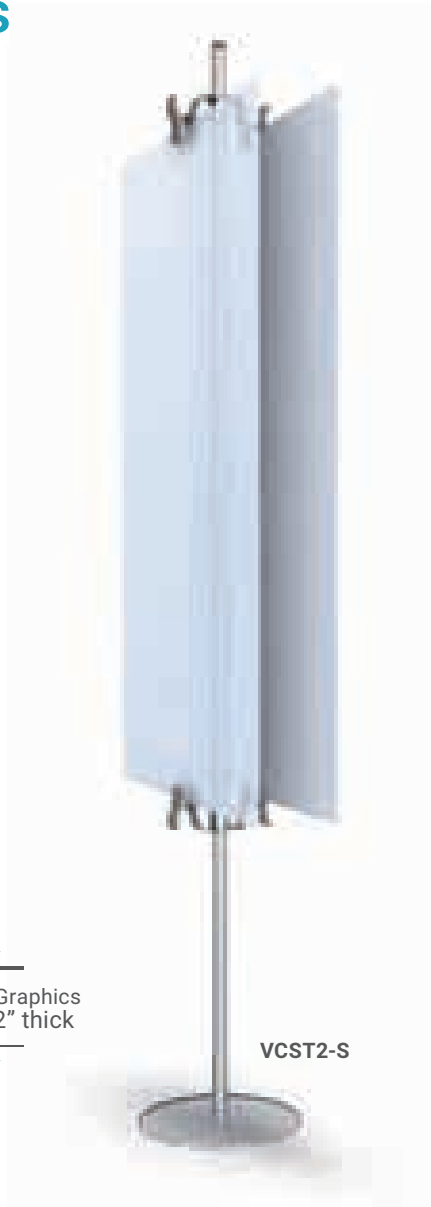

VCST2-S

↓
For Rigid Graphics
up to 1/2" thick
↑

Single and Double Sided Clamp Stands

- Laser cut 5 pound round steel base
- Choose single or double sided
- Two section aluminum 1" diameter 72" pole assembly
- Choose satin silver or matte black finish
- Stands include upper and lower clamps



Featuring: Solid Aluminum Alloy Signing Clamps

- Matte finishes
- 2" w x 3" h, rubber grips
- Grip range up to 1/2" thick
- Clever binder spring

Specify: Model – Color

Model	Description
VCST1	Single sided stand (2 clamps)
VCST2	Double sided stand (4 clamps)
Extra Clamp Sets	
VCEC1	Extra Single sided clamp set (2)
VCEC2	Extra Double sided clamp set (2)

-S Satin Silver or -B Matte Black



Extra Clamp Sets

- Sold in sets of 2



VCEC1-S
Single Sided Clamp Set



VCEC2-S
Double Sided Clamp Set

PortaPole Clamps™

Rigid Graphic Stands



VPP2-SC-S

VPP1-CG-S with
VCE3-S clamp set.

PortaPole™ – Common Features

- Extends 7' to 12'
- Beautiful satin finishes
- Movable clamp assemblies
- Clamp range to 1/2" thick
- One Clamp for 1-3/8" & one for 1-1/2" diameter poles

PortaPole™ with Suction Cup Base

Specify: Model – Top* – Color* *Doesn't affect price.

Model	Description	Top*
VPP1	Single sided PortaPole	-SC Suction Cup
VPP2	Double sided PortaPole	-CG Ceiling Grip Clip

-S Satin Silver or -B Matte Black  

Extensions attaches to pole top

VPP4 48" extension pole

VPP8 96" extension pole

Extra Clamp Sets One for 1-3/8" & one for 1-1/2" diameter.

VCE3 Extra single sided clamp. Set (2)*

VCE4 Extra double sided clamp. Set (2)*

-S Satin Silver or -B Matte Black  



VCE3-S
Single Sided Clamp Set



VCE4-S
Double Sided Clamp Set



PortaPole™

- 17" Round, 12 lb. Base

Specify: Model – Color

Model	Description
-------	-------------

VCST31 Single sided (2 clamps)

VCST32 Double sided (4 clamps)

VCST31-S

-S Satin Silver or -B Matte Black  

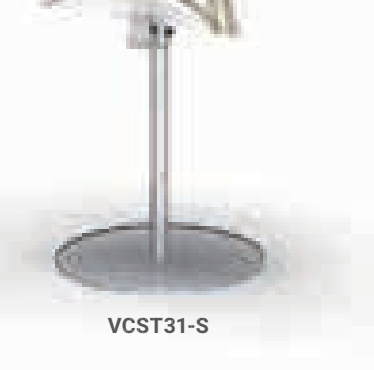

Rigid Graphic Stands

SignPost > the ultimate combination of stability and European styling.



YCL28-S



SignPost Clamp Stands

Beautiful satin silver, rubber lined jaws, strong binder spring, connector included.

YCL26-S

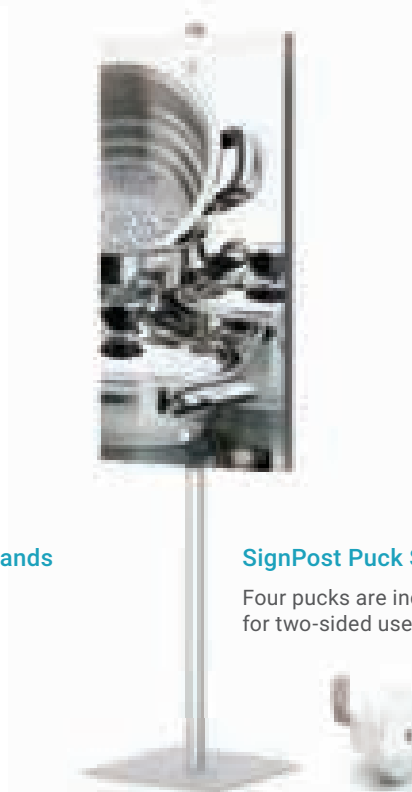

SignPost Puck Stands

Four pucks are included for two-sided use.

YPK6-S

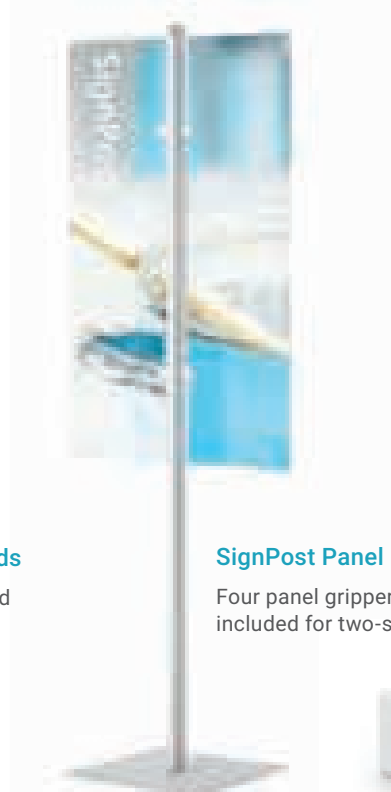

SignPost Panel Gripper Stands

Four panel grippers are included for two-sided use.

YPG6-S

* **Specify:** Model (**Note:** 96" Uprights are in 2 sections) – Color: All models this page -**S** Satin Silver or -**B** Matte Black



Model	Height	Orientation
YCL16	72"	Clamps one side
YCL26	72"	Clamps two sides
YCL18	96"	Clamps one side
YCL28	96"	Clamps two sides

Model	Height
YPK6	72"
YPK8	96"

Model	Height	Specify Gripper Thickness
YPG6-1	72"	.020" – .125"
YPG6-2	72"	.125" – .250"
YPG8-1	96"	.020" – .125"
YPG8-2	96"	.125" – .250"

Clamp, Puck, and Panel Gripper Rigid Graphic Stands

Gallery & Exhibit Wall Stands™

Rigid Graphic Stands



GE1 Aluminum shelves have upper and lower levels.



Carrying Bag with **GE1**

Portable Gallery Displays

- Ideal unit to display artwork and goods at fairs and exhibits
- Supports and accommodates frames up to 1-1/2" deep
- Sturdy Black travel bag included
- Aluminum shelves have upper and lower levels
- Additional supports and a 12" extension are available

Gallery & Exhibit Wall Stands™

GE1: 68" stand, (1) 36" and (2) 52" shelves, (1) 6" top shelf, (1) carry bag.

Accessories

GE2 (2) - 36" Aluminum shelves

GE3 (2) - 52" Aluminum shelves

ST12 12" center extension

EBG8 Extra carrying bag



GE1

Rigid Graphic Displays

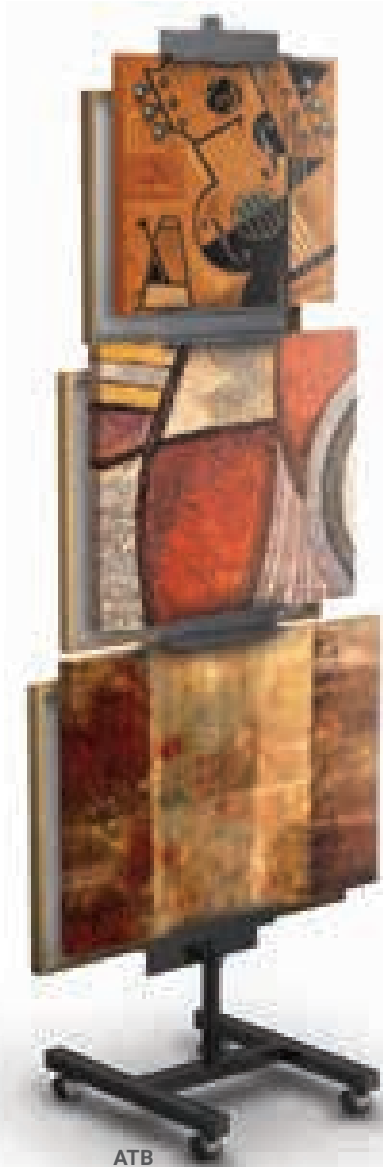

Art Trees - Height Adjustable Supports

- Designed to be portable, allowing easy adjustment
- Great for any rigid substrate
- 4 locking casters



Ideal for:

- Shows
- Presentations
- Showrooms
- Retail Environments
- Samples - Flooring, etc.

Deluxe Art Tree ATD

- Accommodates up to 32 pieces of art
- Includes an 11" x 17" vertical frame header
- Supports are adjustable up & down the four 80" vertical uprights.
- 25-1/2" square welded steel base has 4 locking casters.
- Two-tone matte silver and black finish.

Standard Art Tree ATB

- Displays up to 6 pieces of art, 3 on each side.
- Supports are adjustable up and down the 80" vertical pole.
- 17-1/2" x 21-1/2" steel base, 4 locking casters
- Handsome matte black finish

Model	Description	Weight
ATD	Art Tree Deluxe	44 lbs.
ATB	Standard Art Tree	20 lbs.

↓
for Rigid
Substrates
↑

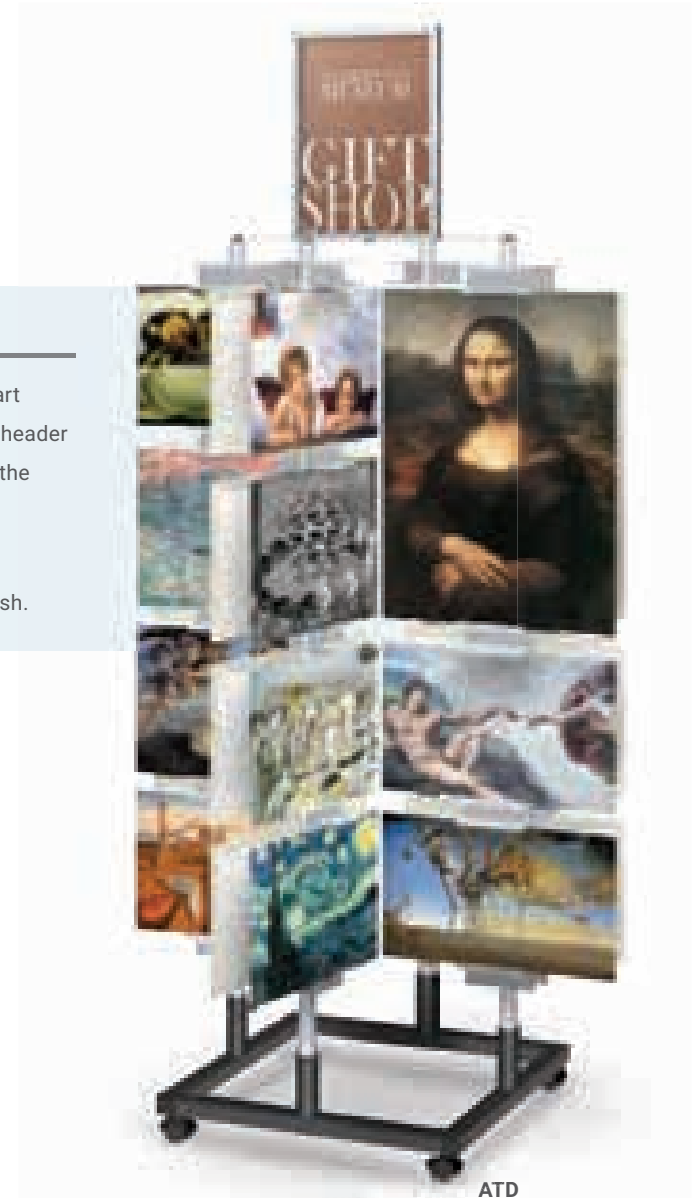

Rigid Graphic Displays

Perfect for Restaurants, Retail, Hotels, and more!



Lollipop Stands™

- Unique drop-in design
- Diameters 13" and 15" standard
- Use circular or shape cut rigid graphics
- Lightweight & portable
- Built to last all metal construction
- Ideal for double sided graphics
- Unassembled for cost efficient shipping

Custom is our specialty

* **Specify:** size, shape, color, and more! Min. qty 25+



Model	Minimum Graphic Size	Weight	Color
LOLPOP13-H-B	13" Diameter half circle	9 lbs.	-B Matte Black
LOLPOP15-H-B	15" Diameter half circle	10 lbs.	

Dye Sublimated Printing



Lots of Fabric Choices

- Canvas
- Satins
- Stretch
- Sheers
- Knits
- Back Lits

Available:

Single or Double Sided
with or without light blockers.

Mounting Methods

- Pillowcase
- Hook/Loop
- Pole Pockets
- Silicone Edge (SEG)

Benefits:

- Bright Vibrant Colors
- Soft Feel and Richness
- Wrinkle Resistant
- Flame Retardant
- Low Shipping Cost



A fabric media Swatch Book is available with all the samples.

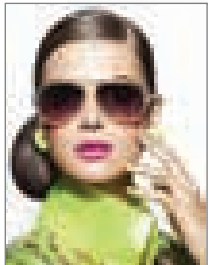

Pop-Up Fabric
Maximum Width:
96 Inches



Coated Canvas
Maximum Width:
48 Inches

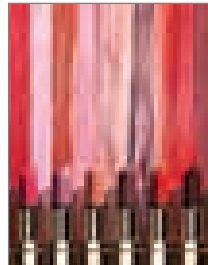

Poly Lycra
Maximum Width:
96 Inches

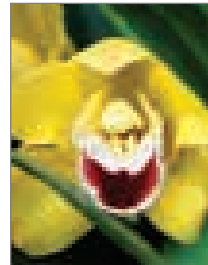

Poly Sheer
Maximum Width:
96 Inches



Poly Pro
Maximum Width:
96 Inches



Stretch
Maximum Width:
60 Inches

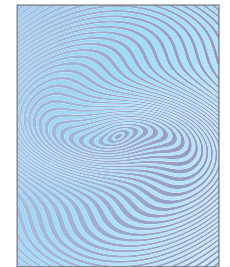

Sound
Maximum Width:
120 Inches

Dye Sublimated Printing

Retail - Hospitality - Tradeshows

Our Quality Makes the Difference ...

Aesthetically eye catching and stunning HD quality.



Our in-house Art Department can offer help and guidance.

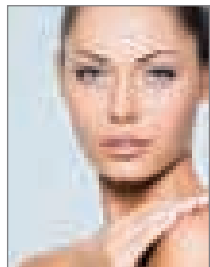

Pyro Back Lit
Maximum Width:
120 Inches



Triple White
Maximum Width:
96 Inches



Polyflex
Maximum Width:
96 Inches



Soft Knit
Maximum Width:
96 Inches



Heavy Knit
Maximum Width:
96 Inches



Satin Matte
Maximum Width:
96 Inches



Duplex Double Sided
Maximum Width:
59 Inches

Charisma - SEG

(Silicone Edge Graphic)

Light Boxes	6-8, 13 & 18
Single Sided Frames	8
Charisma Air™	9
Double Sided Frames	10
Mini SEG / SEG Picture Frames	11
Elevated Stands™	12
Incline Stands™	14
Epic Stands™	15
Trifecta Stands™	16
Expo Stands™	17
SEG 3D™	19
Cabinet Frames™	20
Lightwire™, SEG Circles™ and Sell & Tell Stands™	21

SnapFrames

EasyOpen SnapFrames™	22, 23
SupraSlim SnapFrames™	24, 25
SupraSlim LED SnapFrame Light Boxes™	26, 27
EasyOpen SnapFrames Stands™	28, 29
Plasti SnapFrames™	30
Frame Menu	31

Drop-In Frames

Perflex Drop-In Hanging SignFrames™	32
Perflex Hanging Mini SignFrames™	33
Perflex Swivel SignFrames™	34
Perflex SkyFrames™	35
Silhouette Aluminum Trim Frames™	36
Perflex Signs Anywhere™	37
Monster Drop-In Hanging Frames™	38
Monster Pedestal SignFrames	39
Perflex Drop-In Pedestal SignFrames™	40, 41
Monster Floor Stand SignFrames™	42, 43
SignPost Kits™ Stands SignFrames™	44, 45
Blade Poster SignHolders™	46, 47
Poster SignHolders™	48
Information Centers™	49
Poster SignHolders LF3 Series™	50
Poster SignHolders Tilter Models	51
Titan Poster SignHolders™	52
Eclipse Pedestal SignFrames™	53
Incline Frame Stands™	54, 55
Perflex A Frame™ & A Frame SignHolders	56, 57
Convex Poster SignHolders™	58, 59
Hercules Roll Around™	60

Mosaic	61
SignHolder Grippers	62
Frame Accessories	63

Magnetic

Flair Perimeter Frames™	64
Magnetic Signware Frames™	65
FrameGraphix™ Magnetic Signware Stands	66
FrameGraphix Wall & Pedestal Frames™	67
SeeWell Info Frames™	68-71

CounterTop Displays

Double LL Mounts™	72
Adjustable Countertop Double LL Mounts,	73
Super Click Mounts, Mini Mightee Mounts	
TableTop Tension Fabric Display	74
TableTop Exhibit	75
CounterTop Wire SignHolders™	76
WireForm CounterTop Stands™	77
Metal Shelf Talkers™	78
Perflex Round Base, Rectangular Base,	
Landscape Frames and Panda Frames	79
CT and Classic Banner Stands	80
Sign Easels, Standee and TableTop Easels	81
Mini Visual Signing Clamps™	82
Full Size Visual Signing Clamps™	83
Eclipse SignHolders™	84
ArcTop SignHolders™	85
Wet Erase SignBacks	86
Magnetic SignBacks	87
Paper/Cardstock SignBacks	88, 89
Pedestal Framettes™	90
CounterTop Framettes™	91
Mounting Framettes™	92
Custom Framettes™	93
Stellar Aisle Markers™	94, 95

Hanging Graphics Hardware

Hang-On Perimeter™	96 - 98
Valance Rail Systems™	99
Universal Ceiling Tracks™	100, 101
Aluminum Case Grippers	102, 103
Plastic Grippers	104
Hanging Banner Kits	105
Trapeze Bars™	106, 107
Wall Mount Bracker Sets	108
Halo Rail™	109

Floating StandOff Mounts™	110, 111
Hanging Components	112
Hooks & Cables	113

Tension Fabric Structures

Straight Flat Walls	114
Visual Graphic Stands™	115
Scenic Fabric Walls™	116
Privacy Booth	117
Cool C Walls™	118
Mega Wave Walls™	119
Horizon Pillowcase Hanging Structures™	120, 121
Halos and Tapered Halos	122
Halo Hardware	123
Halo Rails™ & Halo Rail Free Forms™	124, 125
Halo Rails™ Design Ideas	126, 127
Flat Fabric Pillowcase Panels™	128
Circle Moons™	129
Collage Pop-Ups™	130, 131
Presto Pop-Ups™ and Pop-Ups	132, 133
Accessories™	134, 135

Banner Stands

Allé Pillowcase™	136, 137
Tornado Towers™	138
Horizon Pillowcase Graphics™	139
Harmony™	140, 141
Mercury Retractable™	142, 143
SignPost™ Pole Pockets	144, 145
Classic™	146 - 149
Nexus SnapBar™	150
GripGraphic™	151
Promo™, Budget & GCO GripGraphic™	152, 153
Adjustable Large/Grand Format™	154, 155
Crowd Q Stand™	156
American Eagle Banner Stands™	157
Fabric Banner Stands & Towers™	158
Exhibit Lighting & Cascade LED Lights™	159
Travel Bags & Premium Padded Bags	160, 161
Hard Shipping Cases	162
Podium and Exhibit Cases	163

Retail Displays

Hand Sanitizer Dispenser Stands™	164
Clear Room Partitions™	165
Sign and Catalog Stands	166
Bag Racks & SignHolders™	167

Stellar Pallet Stands™	168, 169
Literature Holders, Literature Stands	170-173
Pro iPad Stands™ & Hybrid Pro	
iPad Stands™	174, 175
Convention & Hotel Easels, Elegant Easels	176, 177
Flip Chart Display & Presentation Easels	178, 179
Classic A-Frame Easels™	180
Studio Artist Easels	181

Merchandising Displays

Aluminum Slatwall Displays	182
Portable Slatwall Stands	183
Build-a-Stand	184, 185
SignPost Double Upright Stands™	186, 187

Rigid Graphic Stands

Mightee Mounts™	188
Curvette Mounts™	191
Double L Mounts™ & Adjustable Double	
L Mounts™	190, 191
Skyscraper Mightee Mounts™	192, 193
Fixed Width Skyscraper Mounts™	194, 195
Simple Standees™	196
Simple SignHolders™	197
Contemporary Clamp Stands™	198
PortaPole Clamps™	199
SignPost Rigid Graphic Stands™	200
Gallery & Exhibit Wall Stands™	201
Presentation Trees™	202
Lollipop Stands™	203

Dye Sublimated Printing/Fabrics

Fabric Chart & Dye Sub Printing	204, 205
Index	206
Info & Policy	207



Visit www.displayfolio.com to view or download a digital copy of this catalog

