

Studio50 Screens



Specifications	248
Desk Mounted	249
Transom Guide	250
Select by Component	252



Studio50
Screens are
Australian
Made.

Studio50

Product Specifications

Studio50 Screens

50 mm thickness

Desktop Mounted

500 mm above worktop (approx 1220 mm AFL) (can be modified)

Full Height

1200/1500/1800 mm standard height options

Breathe or Splice fabric all over

Pinnable core

Screen to desktop brackets included

Powdercoat frame finished in white or black

Option for ducting with power data punch-outs to suit Elsafe/CMS cables/Sockets/GPO's/Data bezels

Option for glazing upgrade

Made to order

Breathe

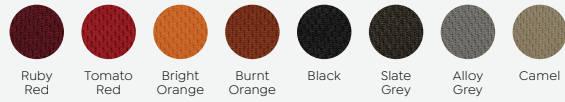

Splice

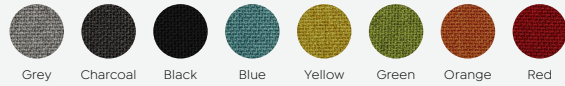

Motion Felt

(Price on application)



C.O.M

Price on Application

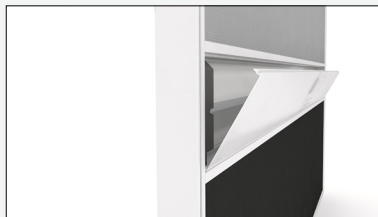

Studio50 Cable Management Panel

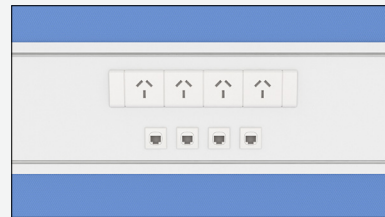

Studio50 data punch-out locations

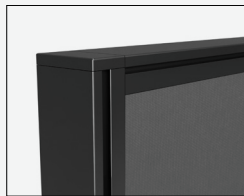

Studio50 Black Frame



Studio50 White Frame



Pinnable Core



Shown: 900 mm high Studio Screen Deskmounted









Studio50 Screens are Australian Made.



Studio50
Screens are
Australian
Made.

Studio50 Deskmount Screens

Product	Description	Screen (H)	Code	AUD\$
	Studio Screen Return Panel 600-900 mm Wide <i>with end seals, pinnable core and standard mounting brackets (fixes to spine screen). Upholstered in Breathe or Splice Fabric</i>	495 mm	OG_STU50DM605_#_##	235
			OG_STU50DM7505_#_##	250
			OG_STU50DM805_#_##	255
	Studio Screen Deskmounted Panel 900 mm Wide <i>with end seals, pinnable core and standard deskmount brackets. Upholstered in Breathe or Splice Fabric</i>	600 mm	OG_STU50DM906_#_##	280
		900 mm	OG_STU50DM909_#_##	320
		1200 mm	OG_STU50DM912_#_##	370
	Studio Screen Deskmounted Panel 1200 mm Wide <i>with end seals, pinnable core and standard deskmount brackets. Upholstered in Breathe or Splice Fabric</i>	600 mm	OG_STU50DM1206_#_##	320
		900 mm	OG_STU50DM1209_#_##	370
		1200 mm	OG_STU50DM1212_#_##	420
	Studio Screen Deskmounted Panel 1500 mm Wide <i>with end seals, pinnable core and standard deskmount brackets. Upholstered in Breathe or Splice Fabric</i>	600 mm	OG_STU50DM1506_#_##	350
		900 mm	OG_STU50DM1509_#_##	410
		1200 mm	OG_STU50DM1512_#_##	470
	Studio Screen Deskmounted Panel 1600 mm Wide <i>with end seals, pinnable core and standard deskmount brackets. Upholstered in Breathe or Splice Fabric</i>	600 mm	OG_STU50DM1606_#_##	370
		900 mm	OG_STU50DM1609_#_##	430
		1200 mm	OG_STU50DM1612_#_##	490
	Studio Screen Deskmounted Panel 1800 mm Wide <i>with end seals, pinnable core and standard deskmount brackets. Upholstered in Breathe or Splice Fabric</i>	600 mm	OG_STU50DM1806_#_##	400
		900 mm	OG_STU50DM1809_#_##	460
		1200 mm	OG_STU50DM1812_#_##	520

Studio50 Frames - Powdercoat



= **W (White)** - Select frame colour when ordering.



= **B (Black)** - Select frame colour when ordering.

Studio50 Screens

Please specify your chosen fabric colour when ordering.

= *Breathe*



= *Splice*



Size

The requirement of a transom is dictated by the maximum width of screen core.

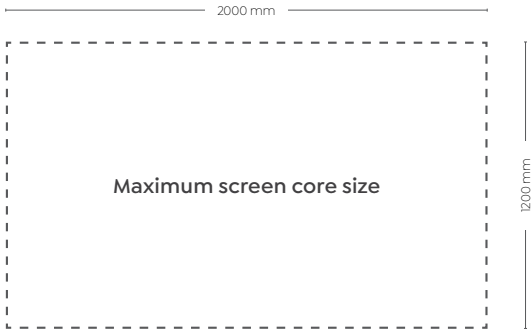

General Rules

Transom required

If both screen dimensions are larger than 1200 mm (eg 1800h x 1500w)

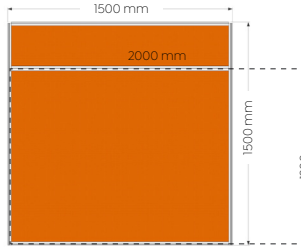

Transom not required

If screen height is 1200 mm or less (eg 1200h x 1800w)

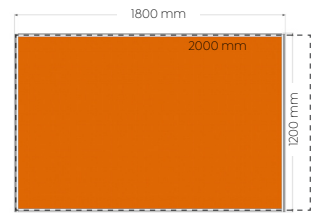

Notes

The maximum width of a single screen is 2000 mm, any screen larger than 2000 mm width will need to be split into 2 screens.

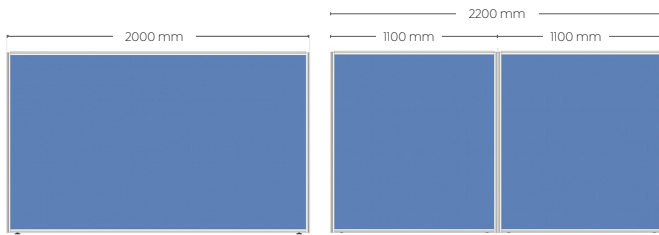

Cable Management has the same effect as a transom.

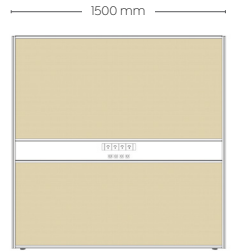

By adding transoms, you are able to have multiple colour options on your screen.

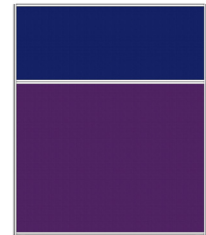

We recommend running a transom on all adjoining screens at the same height to achieve a uniform aesthetic.

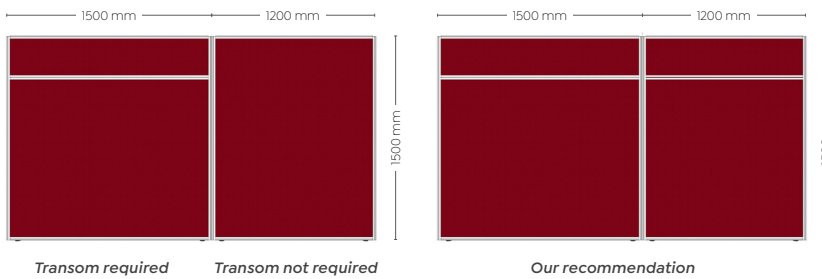

Our standard recommended transom heights:

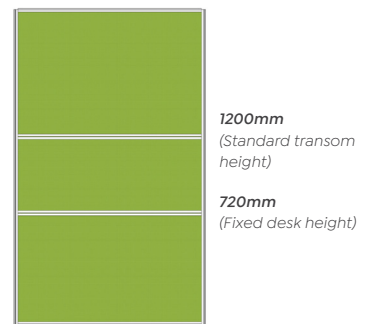

Fabric

Breathe

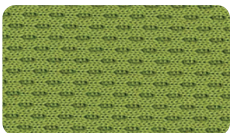

Horizontal
(Max screen height 1500mm without transom)

Splice



Directionless

Motion Felt



Directionless



Studio50
Screens are
Australian
Made.



Simply the best office partition system in the world.

Studio50

Select by Component

Select by Component

Select your product by components from the following pages using the key below for colours and finishes.

1. Select your panels and posts

2. Select your upgrades and finishes

3. Select your worktop size, legs and hardware

4. Select your cable management

5. Select your screen accessories

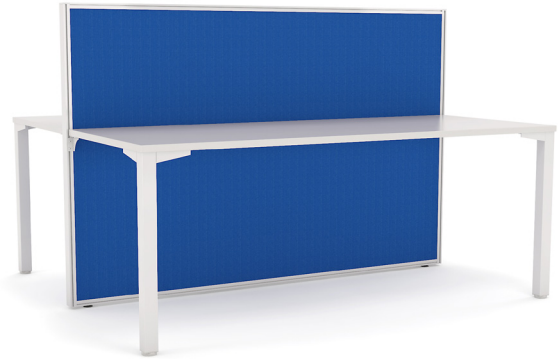

= In-stock



= Made to Order

Workspaces

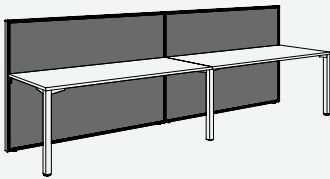

Single Sided

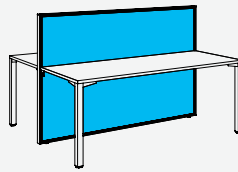

Double Sided

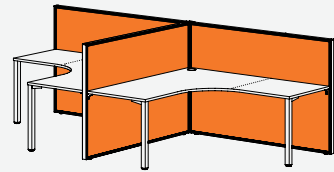

Corners

Worktops - Melamine



= **W (White)** - Select top colour when ordering.



= **NO (New Oak)** - Select top colour when ordering.

Desk/Studio50 Frames - Powdercoat



= **W (White)** - Select frame colour when ordering.



= **B (Black)** - Select frame colour when ordering.

50 mm Studio Screens (White or Black Edge)

= *Breathe*



= *Splice*



Slide-on Return Screens

= *AcoustiQ Panel*

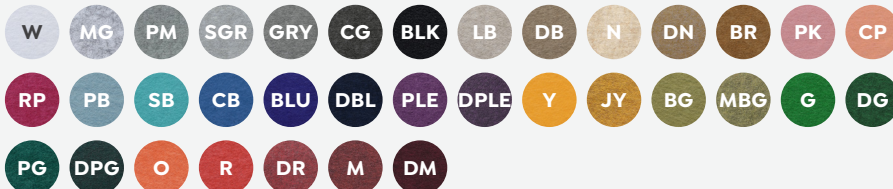

Studio50

Select by Component

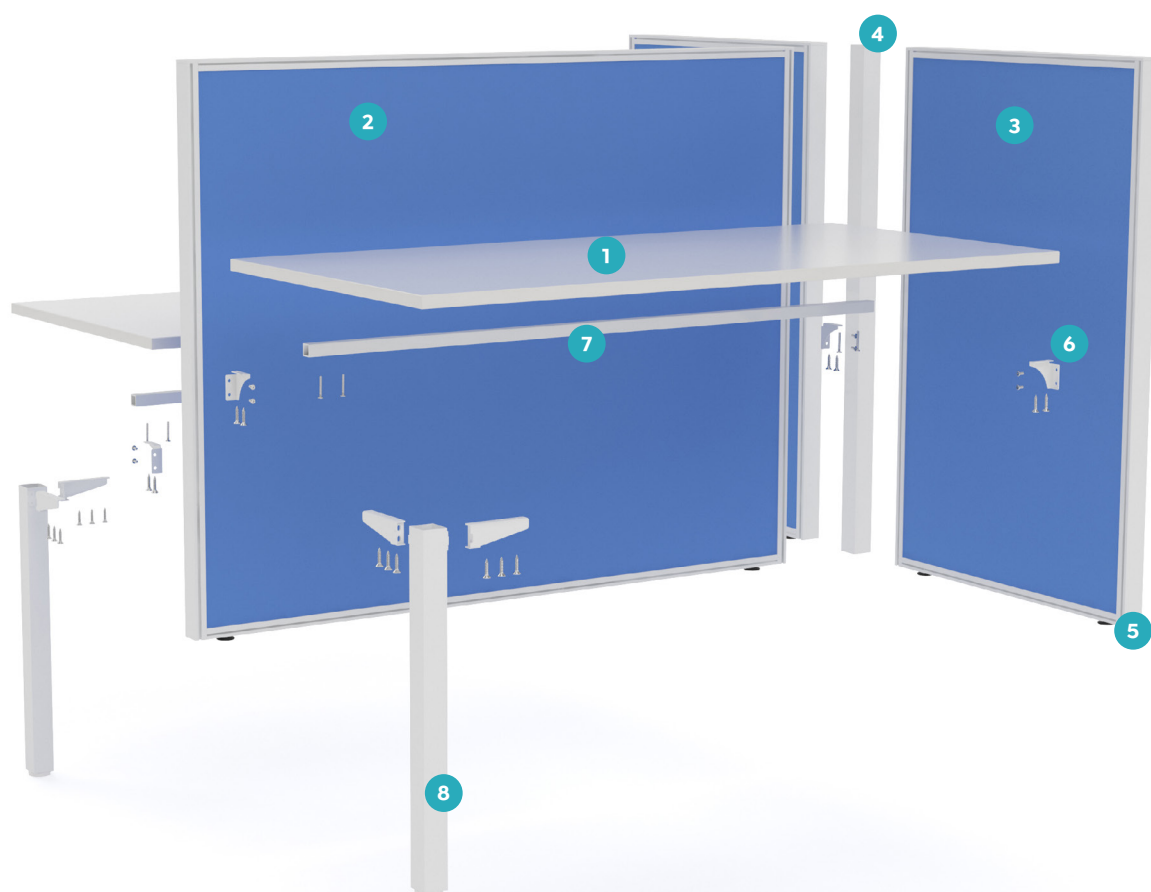

Studio50
Screens are
Australian
Made.

Components List

1. **2 x AXD1575_W** Axis Straight Desk Top W1800 x D750 x H25 - White
2. **1 x STU501215_W_BB** Studio Screen 1500w - Breathe Baby Blue
3. **2 x STU5012075_W_BB** Studio Screen 750w - Breathe Baby Blue
4. **1 x STU509P3P1200_W** Studio Post - White
5. **3 x STU5PFIN12_W** Studio Panel Finish - White
6. **3 x STUSWB60_W** 60mm Small Worktop Bracket - White
7. **2 x AXSTFRAIL128_W** Axis Stiffener Rail 1280mm - White
8. **2 x AXLEGMT1KD_W** Axis Meeting Table Leg Set 1 - White

Studio50

Select by Component



Studio50
Screens are
Australian
Made.



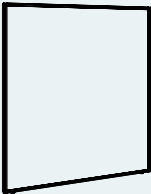
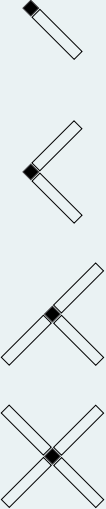









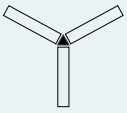

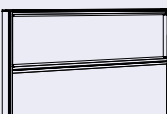
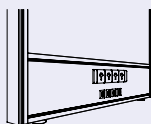
Product	Description	Code	Lead Time
	600 mm wide	600 mm high	OG_STU50606_#_##
		900 mm high	OG_STU50906_#_##
		1200 mm high	OG_STU501206_#_##
		1500 mm high	OG_STU501506_#_##
		1600 mm high	OG_STU501606_#_##
		1800 mm high	OG_STU501806_#_##
	750 mm wide	600 mm high	OG_STU50675_#_##
		900 mm high	OG_STU50975_#_##
		1200 mm high	OG_STU501275_#_##
		1500 mm high	OG_STU501575_#_##
	900 mm wide	1800 mm high	OG_STU501875_#_##
		600 mm high	OG_STU50609_#_##
		900 mm high	OG_STU50909_#_##
		1200 mm high	OG_STU501209_#_##
	1200 mm wide	1500 mm high	OG_STU501509_#_##
		1800 mm high	OG_STU501809_#_##
		600 mm high	OG_STU50612_#_##
		900 mm high	OG_STU50912_#_##
	1500 mm wide	1200 mm high	OG_STU501212_#_##
		1500 mm high	OG_STU501512_#_##
		1800 mm high	OG_STU501812_#_##
		600 mm high	OG_STU50615_#_##
	1800 mm wide	900 mm high	OG_STU50915_#_##
		1200 mm high	OG_STU501215_#_##
1500 mm high		OG_STU501515_#_##	
1800 mm high		OG_STU501815_#_##	
	1 Way Post	600 mm high	OG_STU50618_#_##
		900 mm high	OG_STU50918_#_##
		1200 mm high	OG_STU501218_#_##
		1500 mm high	OG_STU501518_#_##
	2 Way Post	1800 mm high	OG_STU501818_#_##
		900 mm high	OG_STU5091P900_#
		1200 mm high	OG_STU5091P1200_#
	3 Way Post	1500 mm high	OG_STU5091P1500_#
		1800 mm high	OG_STU5091P1800_#
		900 mm high	OG_STU5092P900_#
	4 Way Post	1200 mm high	OG_STU5092P1200_#
		1500 mm high	OG_STU5092P1500_#
1800 mm high		OG_STU5092P1800_#	
Black/White	900 mm high	OG_STU5093P900_#	
	1200 mm high	OG_STU5093P1200_#	
	1500 mm high	OG_STU5093P1500_#	
Packed per job	1800 mm high	OG_STU5093P1800_#	
	900 mm high	OG_STU5094P900_#	
	1200 mm high	OG_STU5094P1200_#	
Packed per job	1500 mm high	OG_STU5094P1500_#	
	1800 mm high	OG_STU5094P1800_#	

*Total panels on project is more than 50. Variations in panel size accepted.

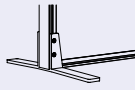

Studio50
Screens are
Australian
Made.

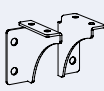
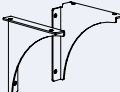
Studio50
Select by Component

Product	Description	Code	Lead Time	
	120 Degree Post 3 Way Post	900 mm high OG_STU50I23P900_#	Packed per job 	
		1200 mm high OG_STU50I23P1200_#		
		1500 mm high OG_STU50I23P1500_#		
		1800 mm high OG_STU50I23P1800_#		
 	Upgrade Glazing (300 mm High)	900 mm wide OG_STU50GLZ90W_UP	Packed per job 	
		1200 mm wide OG_STU50GLZ12#_UP		
		1500 mm wide OG_STU50GLZ15#_UP		
	Upgrade CM	1800 mm wide OG_STU50GLZ18#_UP	Packed per job 	
		1200 mm wide OG_STU50CM12#_UP		
		1500 mm wide OG_STU50CM15#_UP		
		1600 mm wide OG_STU50CM16#_UP		
		1800 mm wide OG_STU50CM18#_UP		
	 	Finishing Panel Link	OG_STU50RCP_#	Packed per job 
			Finishing Wall Start	
900 mm high OG_STU50WS900_#				
1200 mm high OG_STU50WS1200_#				
1500 mm high OG_STU50WS1500_#				
1800 mm high OG_STU50WS1800_#				
Finishing Panel Finish		600mm high OG_STU50PFIN6_#		
		900mm high OG_STU50PFIN9_#		
		1200mm high OG_STU50PFIN12_#		
		1500mm high OG_STU50PFIN15_#		
Finishing Power Pole	1800mm high OG_STU50PFIN18_#	Packed per job 		
	OG_STU50PP2700			
 	Feet Flat Fixed 400 x 40	OG_STU50FSF40_#	Pairs 	
		OG_STU50FSF60C_#		
   	Stiffening Rails	1280 mm OG_AXSTFRAIL128_#	Singles 	
		1580 mm OG_AXSTFRAIL158_#		
	Worktop Mounting Hardware Brackets	OG_STU50DFC_W	Pairs 	
		OG_STU50DFC_B		
	Worktop Mounting Hardware Brackets	60 mm OG_STUSWB60_#	Packed in pairs 	
		150 mm OG_STUSWB150_#		



*Complement any office with
seamless integration.*

Agile Screens



Studio50	259
Radius8	260



*Inspire a more collaborative
working office environment.*



Agile
Screens | Studio50

Product	Description	Screen Width	Code
	Studio Screen for Single Sided Desk <i>Includes desk hung screen brackets, see select by components for cable trays</i>	1200 wide (1250 mm AFL)	AGHS12STU_#_##
		1500 wide (1250 mm AFL)	AGHS15STU_#_##
		1600 wide (1250 mm AFL)	AGHS16STU_#_##
		1800 wide (1250 mm AFL)	AGHS18STU_#_##
	Studio Screen Including Ducting for Single Sided Desk <i>Includes desk hung screen brackets, see select by components for cable trays</i>	1200 wide (1250 mm AFL)	AGHS12STUCD_#_##
		1500 wide (1250 mm AFL)	AGHS15STUCD_#_##
		1600 wide (1250 mm AFL)	AGHS16STUCD_#_##
		1800 wide (1250 mm AFL)	AGHS18STUCD_#_##
	Studio Return Screen Single Sided Desk	750-800 w x 1250 h	See Studio Select by Components
	Studio Screen for Double Sided Desks	1200 wide (1250 mm AFL)	AGCS12STU_#_##
		1500 wide (1250 mm AFL)	AGCS15STU_#_##
		1600 wide (1250 mm AFL)	AGCS16STU_#_##
		1800 wide (1250 mm AFL)	AGCS18STU_#_##
	Studio Screen Including Ducting Double Sided Desks	1200 wide (1250 mm AFL)	AGCS12STUCD_#_##
		1500 wide (1250 mm AFL)	AGCS15STUCD_#_##
		1600 wide (1250 mm AFL)	AGCS16STUCD_#_##
		1800 wide (1250 mm AFL)	AGCS18STUCD_#_##
	Studio Return Screen Double Sided Desks	750-800 w x 1250 h	See Studio Select by Components

Studio50 Frames - Powdercoat



= **W (White)** - Select frame colour when ordering.



= **B (Black)** - Select frame colour when ordering.

Studio50 Screens

= *Breathe*



= *Splice*



Agile
Radius18



Radius18 Screen

40mm radius on all corners

Available in Splice/ Motion Felt/
Breathe Fabrics

Radius18 Screen Desk Capabilities

Agile DSD - mount of crossrail

Agile+ DSD - mount of crossrail

Agile+ Shared Workstation - mount of crossrail

Plantation Desking - clamp off worktop

Trestle DSD - clamp off worktop

Modulus Desking - clamp off worktop

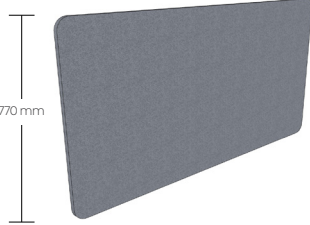
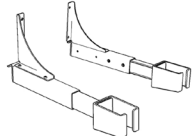
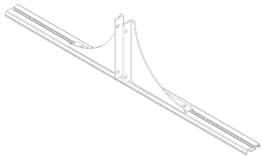
Product	Description	Screen Width	Code
	<p>Radius18 Screen for Agile Desks</p> <p>1200 mm AFL</p>	1190 wide	AGR181277_##
		1490 wide	AGR181577_##
		1590 wide	AGR181677_##
		1790 wide	AGR181877_##
	<p>Brackets to suit R18 Single Sided Agile Desk</p>	SSD Brackets	OG_AGSSDBRAC_#
	<p>Brackets to suit R18 Double Sided Agile Desk</p>	150 mm 2 pairs required Priced as 2x pairs for DSD	OG_STUSWB150_#
		Agile dropper rail 2 rails required Priced as 2x pcs for DSD	OG_AGDROPPERRAIL_#

Radius18 Screens

= Breathe



= Splice





*The power to adjust the limits
of your imagination.*



*Personal space combined with
functionality and safety.*



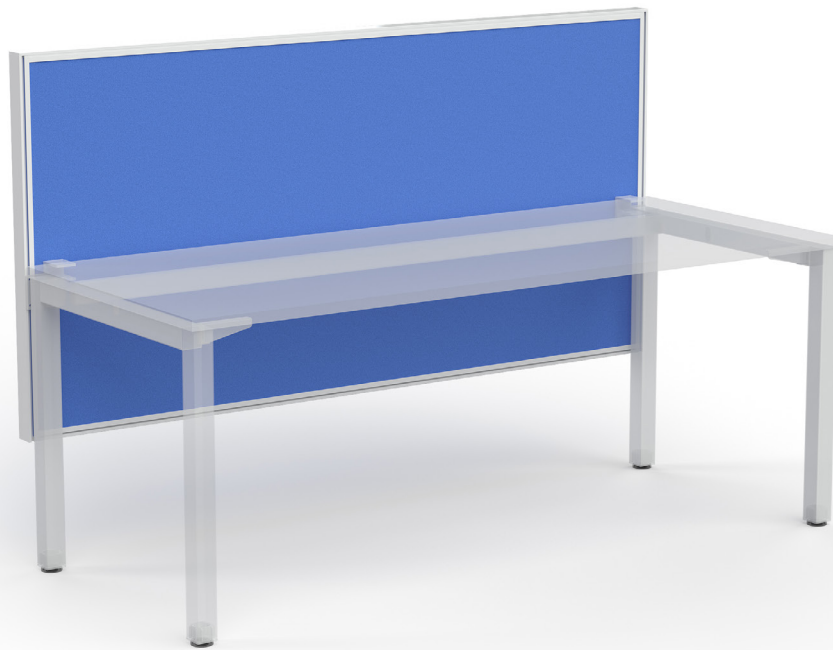

Hung Screens



SSD - Studio50	264
SSD - Radius8	265
SSD - Axis 22mm White Frame	266
AcustiQ 20mm	267
AcustiQ 10mm	268

Hung Screens
SSD - Studio50

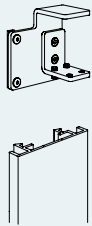

Product	Description	Screen (W)	Code
	Hung Screens SSD - Studio50 400mm high (300mm above worktop) with end seals, pinnable core and standard mounting brackets (fixes to spine screen). Upholstered in Breathe or Splice Fabric	1190 mm	OG_STU50412_#_##
		1490 mm	OG_STU50415_#_##
		1590 mm	OG_STU50416_#_##
		1790 mm	OG_STU50418_#_##
	Hung Screens SSD - Studio50 500mm high (400mm above worktop) with end seals, pinnable core and standard mounting brackets (fixes to spine screen). Upholstered in Breathe or Splice Fabric	1190 mm	OG_STU50512_#_##
		1490 mm	OG_STU50515_#_##
		1590 mm	OG_STU50516_#_##
	Hung Screens SSD - Studio50 600mm high (500mm above worktop) with end seals, pinnable core and standard mounting brackets (fixes to spine screen). Upholstered in Breathe or Splice Fabric	1190 mm	OG_STU50612_#_##
		1490 mm	OG_STU50615_#_##
		1590 mm	OG_STU50616_#_##
	Hung Screens SSD - Studio50 700mm high (500mm above worktop) with end seals, pinnable core and standard mounting brackets (fixes to spine screen). Upholstered in Breathe or Splice Fabric	1790 mm	OG_STU50618_#_##
		1190 mm	OG_STU50712_#_##
		1490 mm	OG_STU50715_#_##
	Hung Screens SSD - Studio50 800mm high (500mm above worktop) with end seals, pinnable core and standard mounting brackets (fixes to spine screen). Upholstered in Breathe or Splice Fabric	1590 mm	OG_STU50716_#_##
		1790 mm	OG_STU50718_#_##
		1190 mm	OG_STU50812_#_##
		1490 mm	OG_STU50815_#_##
		1590 mm	OG_STU50816_#_##
		1790 mm	OG_STU50818_#_##

Product	Description	Code
	Brackets 2 required per screen Packed in pairs	Multi bracket for (25mm, 75mm, 10mm offset) OG_STU50DFC_#
	Panel Finishes 2 per screen	OG_STU50PFIN6_#
		OG_STU50PFIN9_#
Link Parts 1 per join	OG_STU50PLINK_#	



Hung Screens

SSD - Radius18

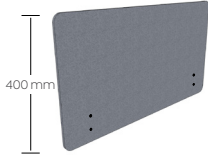
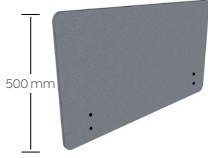
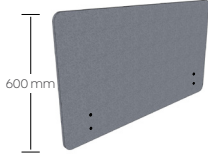
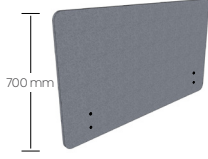
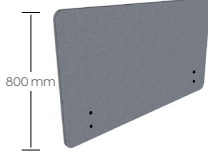
Product	Description	Screen (W)	Code
 <p>400mm</p>	Hung Screens SSD - Radius18 400mm high (300mm above worktop)	1190 mm	OG_R18124_##
		1490 mm	OG_R18154_##
		1590 mm	OG_R18164_##
		1790 mm	OG_R18184_##
 <p>500mm</p>	Hung Screens SSD - Radius18 500mm high (400mm above worktop)	1190 mm	OG_R18125_##
		1490 mm	OG_R18155_##
		1590 mm	OG_R18165_##
		1790 mm	OG_R18185_##
 <p>600mm</p>	Hung Screens SSD - Radius18 600mm high (500mm above worktop)	1190 mm	OG_R18126_##
		1490 mm	OG_R18156_##
		1590 mm	OG_R18166_##
		1790 mm	OG_R18186_##
 <p>700mm</p>	Hung Screens SSD - Radius18 700mm high (500mm above worktop)	1190 mm	OG_R18127_##
		1490 mm	OG_R18157_##
		1590 mm	OG_R18167_##
		1790 mm	OG_R18187_##
 <p>800mm</p>	Hung Screens SSD - Radius18 800mm high (500mm above worktop)	1190 mm	OG_R18128_##
		1490 mm	OG_R18158_##
		1590 mm	OG_R18168_##
		1790 mm	OG_R18188_##

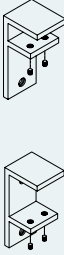
Product	Description	Code
	Brackets 2 required per screen Packed in pairs	27mm (10mm offset - for 25mm worktops)
		77mm (10mm offset - for 25mm worktops + rail)
		OG_AX27SCR900_W
		OG_AX77SCR900B_W



Hung Screens

SSD - Axis 22mm White Frame

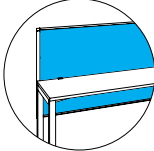
Product	Description	Screen (W)	Code
	Hung SSD Axis 22mm white frame <i>900mm high (500mm above worktop)</i>	1190 mm	OG_AXI2090_#
		1490 mm	OG_AXI5090_#
		1790 mm	OG_AXI8090_#

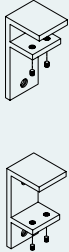
Product	Description	Code
	27mm (10mm offset - for 25mm worktops)	OG_OPCBSCBR_M_W
	Brackets <i>2 required per screen</i> <i>Packed in pairs</i>	77mm (10mm offset - for 25mm worktops + rail)



Hung Screens

AcoustiQ 20mm

Product	Description	Screen (W)	Code
 <p>400mm</p>	Hung Screens - AcoustiQ 20mm (fits to underside of worktop - needs 20mm clear under worktop) 400mm high (100 - 300mm above worktop)	1190	OG_AQ_DHS_21204_#
		1490	OG_AQ_DHS_21504_#
		1590	OG_AQ_DHS_21604_#
		1790	OG_AQ_DHS_21804_#
 <p>500mm</p>	Hung Screens - AcoustiQ 20mm (fits to underside of worktop - needs 20mm clear under worktop) 500mm high (200 - 300mm above worktop)	1190	OG_AQ_DHS_21205_#
		1490	OG_AQ_DHS_21505_#
		1590	OG_AQ_DHS_21605_#
		1790	OG_AQ_DHS_21805_#
 <p>600mm</p>	Hung Screens - AcoustiQ 20mm (fits to underside of worktop - needs 20mm clear under worktop) 600mm high (300mm above worktop)	1190	OG_AQ_DHS_21206_#
		1490	OG_AQ_DHS_21506_#
		1590	OG_AQ_DHS_21606_#
		1790	OG_AQ_DHS_21806_#

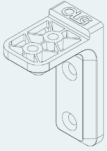
Product	Description	Code
	Brackets Allow 4 per screen Packet of 4 brackets Screws to underside of worktop	OG_EPDBRACK4_B



Hung Screens

AcoustiQ 10mm

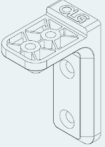

Product	Description	Screen (W)	Code
	Hung Screens - AcoustiQ 10mm (fits to underside of worktop - needs 20mm clear under worktop) 400mm high (100 - 300mm above worktop)	1190 mm	OG_AQ_DHS_11204_#
		1490 mm	OG_AQ_DHS_11504_#
		1590 mm	OG_AQ_DHS_11604_#
		1790 mm	OG_AQ_DHS_11804_#
	Hung Screens - AcoustiQ 10mm (fits to underside of worktop - needs 20mm clear under worktop) 500mm high (200 - 300mm above worktop)	1190 mm	OG_AQ_DHS_11205_#
		1490 mm	OG_AQ_DHS_11505_#
		1590 mm	OG_AQ_DHS_11605_#
	Hung Screens - AcoustiQ 10mm (fits to underside of worktop - needs 20mm clear under worktop) 600mm high (300mm above worktop)	1190 mm	OG_AQ_DHS_11206_#
		1490 mm	OG_AQ_DHS_11506_#
		1590 mm	OG_AQ_DHS_11606_#
		1790 mm	OG_AQ_DHS_11806_#

Product	Description	Code
	Brackets Allow 4 per screen Packet of 4 brackets Screws to underside of worktop	OG_EPDBRACK4_B



Wrap Screens

AcoustiQ 10mm

Product	Description	Screen (W)	Code
	Wrap Screens - AcoustiQ 10mm (fits to underside of worktop - needs 20mm clear under worktop) <i>400mm high (100 - 300mm above worktop)</i>	1190 x 600mm	OG_AQW_112604_#
		1490 x 600mm	OG_AQW_115604_#
		1590 x 600mm	OG_AQW_116604_#
		1790 x 600mm	OG_AQW_118604_#
	Wrap Screens - AcoustiQ 10mm (fits to underside of worktop - needs 20mm clear under worktop) <i>500mm high (200 - 300mm above worktop)</i>	1190 x 600mm	OG_AQW_112605_#
		1490 x 600mm	OG_AQW_115605_#
		1590 x 600mm	OG_AQW_116605_#
		1790 x 600mm	OG_AQW_118605_#
	Wrap Screens - AcoustiQ 10mm (fits to underside of worktop - needs 20mm clear under worktop) <i>600mm high (300 - 400mm above worktop)</i>	1190 x 600mm	OG_AQW_112606_#
		1490 x 600mm	OG_AQW_115606_#
		1590 x 600mm	OG_AQW_116606_#
		1790 x 600mm	OG_AQW_118606_#

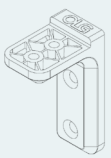
Product	Description	Code
	Brackets <i>Allow 4 per screen</i> <i>Packet of 4 brackets</i>	Screws to underside of worktop OG_EPDBRACK4_B



*A well designed product will always
make life easier.*

Spine Screens







Axis/Anvil/Trestle/Cosmic/Plantation DSD - Studio50	272
Axis/Anvil/Trestle/Cosmic/Plantation DSD - Radius18	273
Axis/Anvil - Axis 22mm	274
AcoustiQ 20mm	275

Spine Screens

Axis/Anvil/Trestle/Cosmic/Plantation - DSD - Studio50

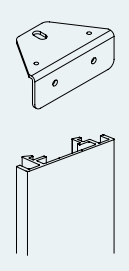

Product	Description	Screen (W)	Code
	Spine Screens - Axis/Anvil DSD - Studio50 300mm high	1200 mm	OG_STU501203_#_##
		1500 mm	OG_STU501503_#_##
		1600 mm	OG_STU501603_#_##
		1800 mm	OG_STU501803_#_##
	Spine Screens - Axis/Anvil DSD - Studio50 400mm high	1200 mm	OG_STU501204_#_##
		1500 mm	OG_STU501504_#_##
		1600 mm	OG_STU501604_#_##
	Spine Screens - Axis/Anvil DSD - Studio50 500mm high	1200 mm	OG_STU501205_#_##
		1500 mm	OG_STU501505_#_##
		1600 mm	OG_STU501605_#_##
	Cable Management Duct	1800 mm	OG_STU501805_#_##
		1200 mm	OG_STU50CM12#_UP
		1500 mm	OG_STU50CM15#_UP
		1600 mm	OG_STU50CM16#_UP
		1800 mm	OG_STU50CM18#_UP

Product	Description	Code
	Brackets 2 required per screen Packed in pairs Multi bracket (axis/anvil/trestle/plantation)	OG_AXS50BKT_#
	Panel Finishes 2 per screen	OG_STU50PFIN6_#
	Link Parts 1 per join	OG_STU50RCP_#



Spine Screens

Trestle/Cosmic/Plantation - DSD - Radius18

Product	Description	Screen (W)	Code
	Spine Screens - Trestle/Cosmic/Plantation - DSD - Radius 18 300mm high	1190 mm	OG_R18123_##
		1490 mm	OG_R18153_##
		1590 mm	OG_R18163_##
		1790 mm	OG_R18183_##
	Spine Screens - Trestle/Cosmic/Plantation - DSD - Radius 18 400mm high	1190 mm	OG_R18124_##
		1490 mm	OG_R18154_##
		1590 mm	OG_R18164_##
		1790 mm	OG_R18184_##
	Spine Screens - Trestle/Cosmic/Plantation - DSD - Radius 18 500mm high (500mm above worktop)	1190 mm	OG_R18125_##
		1490 mm	OG_R18155_##
		1590 mm	OG_R18165_##
		1790 mm	OG_R18185_##

Product	Description	Code
	Brackets 2 required per screen Packed in pairs	OG_OPCBSCBR_M_W

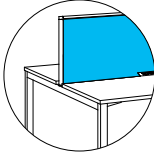

Spine Screens
Axis/Anvil - Axis 22mm

Product	Description	Screen (W)	Code
	Spine Screens Axis/Anvil - Axis 22mm 525mm high (500mm above worktop)	1190 mm	OG_AXI2053_#
		1490 mm	OG_AXI5053_#
		1790 mm	OG_AXI8053_#

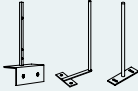
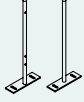
Product	Description	Code	
 	For Anvil End frames	OG_ANVBRACKEND_#	
	End Brackets 2 required per screen Packed in pairs	For Anvil End frames with full depth (800mm) tops	OG_OPBRENDI_W
	For Axis End frames	OG_OPCBSCBR_E_W	
	Middle Brackets 1 required per join in screens	Bracket for all DSD frame types	OG_OPCBSCBR_M_W
	Screen join for all DSD frame types	OG_AXKP510_W	



Spine Screens

AcoustiQ 20mm

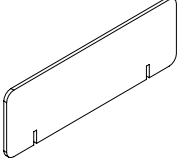
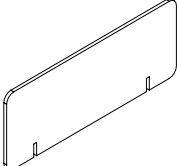
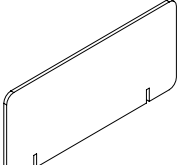
Product	Description	Screen (W)	Code
	Spine Screens - AcoustiQ 20mm (fits to all fixed height DSD ranges) <i>400mm high</i>	1190 mm	OG_AQ_COS_21204_#
		1490 mm	OG_AQ_COS_21504_#
		1590 mm	OG_AQ_COS_21604_#
		1790 mm	OG_AQ_COS_21804_#
	Spine Screens - AcoustiQ 20mm (fits to all fixed height DSD ranges) <i>500mm high</i>	1190 mm	OG_AQ_COS_21205_#
		1490 mm	OG_AQ_COS_21505_#
		1590 mm	OG_AQ_COS_21605_#
		1790 mm	OG_AQ_COS_21805_#
	Spine Screens - AcoustiQ 20mm (fits to all fixed height DSD ranges) <i>600mm high</i>	1190 mm	OG_AQ_COS_21206_#
		1490 mm	OG_AQ_COS_21506_#
		1590 mm	OG_AQ_COS_21606_#
		1790 mm	OG_AQ_COS_21806_#

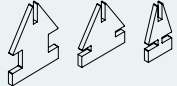
Product	Description	Code	
	Hand Fit - fits Axis with rails in normal location	OG_AQSSBRAC_AX77_#	
	Brackets <i>allow 2 per screen</i>	Hand Fit - fits Axis with rails in inset location	OG_AQSSBRAC_AX27_#
	Hand Fit -fits with 25mm tops set 20mm apart	OG_AQSSBRAC_PL27_#	



Quick Clamp Screens



AcustiQ 10mm	278
AcustiQ 20mm	279



Quick Clamp Screens
AcoustiQ 10mm

Product	Description	Screen (W)	Code
	Quick Clamp Screens - AcoustiQ 10mm (clamps to worktop - SSD/DSD/ Top Mount) <i>300mm high (2 brackets per screen)</i>	1190 mm	OG_AQ_COS_11203_#
		1490 mm	OG_AQ_COS_11503_#
		1590 mm	OG_AQ_COS_11603_#
		1790 mm	OG_AQ_COS_11803_#
	Quick Clamp Screens - AcoustiQ 10mm (clamps to worktop - SSD/DSD/ Top Mount) <i>400mm high (3 brackets per screen)</i>	1190 mm	OG_AQ_COS_11204_#
		1490 mm	OG_AQ_COS_11504_#
		1590 mm	OG_AQ_COS_11604_#
	Quick Clamp Screens - AcoustiQ 10mm (clamps to worktop - SSD/DSD/ Top Mount) <i>Cityscapes (3 brackets per screen)</i>	1190 mm	OG_AQ_COS_112_###_#
		1490 mm	OG_AQ_COS_115###_#
		1590 mm	OG_AQ_COS_116_###_#
		1790 mm	OG_AQ_COS_118_###_#

	Sydney	Manhattan	Brisbane	Meadow
Cityscapes Codes:	## = SYD	## = MAN	## = BRI	###=MEA



Product	Description	Code
	Single sided	OG_ESCRCLAMPISS_#
	Double sided	OG_ESCRCLAMPIDS_#
	Top Mount	OG_ESCRCLAMPIT_#

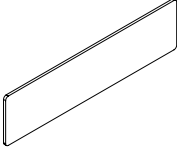
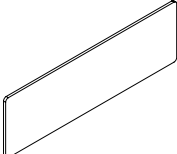
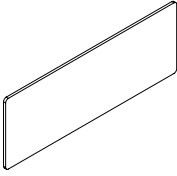

Quick Clamp Screens

AcoustiQ 20mm

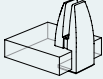
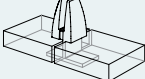
Product	Description	Screen (W)	Code
	Quick Clamp Screens – AcoustiQ 20mm (clamps to worktop – SSD/DSD/ Top Mount) 300mm high (2 brackets per screen)	1190 mm	OG_AQ_COS_21204_#
		1490 mm	OG_AQ_COS_21504_#
		1590 mm	OG_AQ_COS_21604_#
		1790 mm	OG_AQ_COS_21804_#
	Quick Clamp Screens – AcoustiQ 20mm (clamps to worktop – SSD/DSD/ Top Mount) 400mm high (3 brackets per screen)	1190 mm	OG_AQ_COS_21205_#
		1490 mm	OG_AQ_COS_21505_#
		1590 mm	OG_AQ_COS_21605_#
		1790 mm	OG_AQ_COS_21805_#
	Quick Clamp Screens – AcoustiQ 20mm (clamps to worktop – SSD/DSD/ Top Mount) 500mm high (3 brackets per screen)	1190 mm	OG_AQ_COS_21206_#
		1490 mm	OG_AQ_COS_21506_#
		1590 mm	OG_AQ_COS_21606_#
		1790 mm	OG_AQ_COS_21806_#

Product	Description	Code
  	Single sided	OG_ESCRCLAMP1SS_#
	Brackets Double sided	OG_ESCRCLAMPIDS_#
	Top Mount	OG_ESCRCLAMPIT_#



Slide-on Screens



AcoustiQ 20mm

282

Slide-on Screens

AcoustiQ 20mm

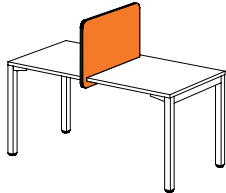
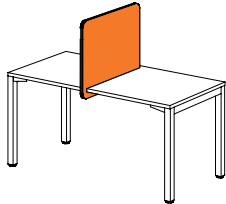
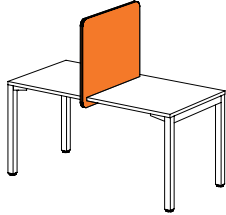

Product	Description	Screen (W)	Code
	Slide-on Screens - AcoustiQ 20mm 300mm high	600mm	OG_AQ2SLS0603_#
		800mm	OG_AQ2SLS0803_#
	Slide-on Screens - AcoustiQ 20mm 400mm high	600mm	OG_AQ2SLS0604_#
		800mm	OG_AQ2SLS0804_#
	Slide-on Screens - AcoustiQ 20mm 500mm high	600mm	OG_AQ2SLS0605_#
		800mm	OG_AQ2SLS0805_#



*A faster way to a
better workspace.*